

# AUDIO ENGINEERING

OCTOBER  
1948

THE JOURNAL FOR SOUND ENGINEERS

# PRICES AND AUDIODISCS

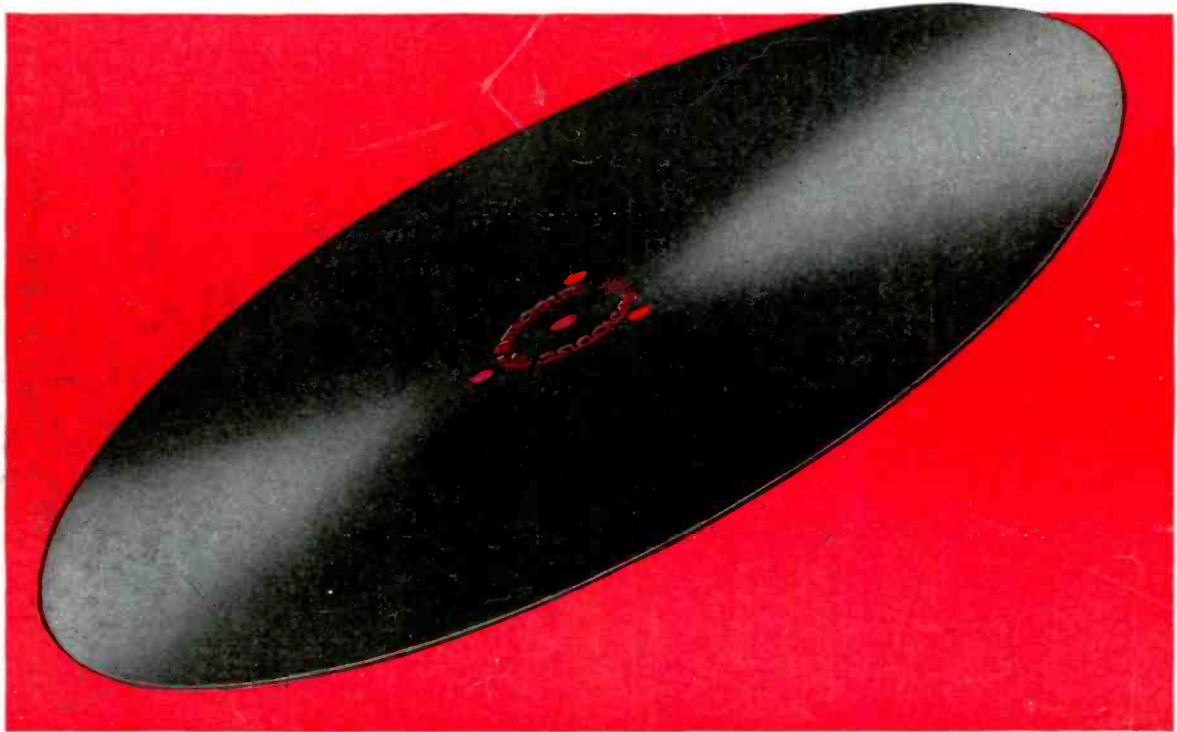

## *A Statement On Our Price Policy*

As of September 1st, aluminum prices were again increased. This means higher cost for the principal raw material used in the manufacture of AUDIODISCS. In fact, the cost of the aluminum base has always been the main item in the cost of production. Thus, any increase in aluminum prices is of major importance.

But beyond the cost of raw materials and labor there is a basic factor which determines the cost of manufacturing professional recording discs. This factor is the extent to which the particular process of manufacture enables the producer to turn out a large proportion of first quality discs. There are several methods of production used. None of these will give anything like a 100% yield. It is, however, obvious that as the percentage of yield increases there is a resulting drop in the average cost of aluminum, lacquer and labor.

Fortunately, our patented, precision-machine process—now used for over a decade and continuously improved—gives a more consistent yield of high quality discs than any method of production now used. And we have tested every other process in use.

So our position with respect to the present increase in aluminum prices is this:

1. We are **not** increasing prices of AUDIODISCS.
- 2: We shall make every effort to absorb this new aluminum price raise and thus continue our prices at the present level. Our calculations indicate that with some improved efficiency, now under way, and continued large volume production, we shall be successful in this hold-the-price effort.

*Audioidiscs are manufactured in the U.S.A. under exclusive license from PYRAL, S.A.R.L., Paris.*

**Audio Devices, Inc., 444 Madison Ave., N.Y. C.**

EXPORT DEPT: ROCKE INTERNATIONAL, 13 EAST 40TH STREET, NEW YORK 16, N. Y.



*they speak for themselves* **audioidiscs**





## ***Link* FM—With Sylvania Lock-Ins— Covers New Jersey For Its State Police Radio System**

Automotive equipment of the New Jersey State Police includes vehicles always on the alert to deal with every emergency. Fleet is spearheaded by 180 patrol cars of the department in addition to 42 patrol cars of the State Motor Vehicle Department which is served by the State Police. These vehicles are constantly in touch with fixed FM stations located at 26 strategic points throughout the state. In addition, emergency trucks carry complete radio equipment equivalent to that of a fixed station!

Link Radio Corporation, manufacturer of the communications equipment, makes extensive use of Sylvania Lock-In tubes to assure unflinching efficiency of this statewide network. Lock-In tubes stay put through vibration and jarring. They have few welded joints... no soldered ones. Elements cannot warp or weave... connections are short and direct. Top location of getter reduces losses... separation of getter material from leads cuts down leakage.

See Sylvania Distributors—or write Radio Tube Division, Emporium, Pa.

# SYLVANIA ELECTRIC

MAKERS OF RADIO TUBES; CATHODE RAY TUBES; ELECTRONIC DEVICES; FLUORESCENT LAMPS, FIXTURES, WIRING DEVICES; ELECTRIC LIGHT BULBS

AUDIO ENGINEERING OCTOBER, 1948



Drivers of both emergency trucks and patrol cars can maintain two-way communication with fixed stations.



Radio equipment in emergency trucks duplicates the set-up used in fixed transmitting stations.



The superior mechanical and electrical features of Sylvania Electric's famous Lock-In tube make it the ideal choice for equipment on the road, in the air, on the rails, marine radar, FM and television.



# Linear Standard Units...

## THE ULTIMATE IN QUALITY...

UTC Linear Standard Audio Transformers represent the closest approach to the ideal component from the standpoint of uniform frequency response, low wave form distortion, high efficiency, thorough shielding and utmost dependability.

### UTC Linear Standard Transformers feature...

- True Hum Balancing Coil Structure... maximum neutralization of stray fields.
- Balanced Variable Impedance Line... permits highest fidelity on every tap of a universal unit... no line reflections or transverse coupling.
- Reversible Mounting... permits above chassis or sub-chassis wiring.
- Alloy Shields... maximum shielding from inductive pickup.
- Hiperam-Alloy... a stable, high permeability nickel-iron core material.
- Semi-Toroidal Multiple Coil Structure... minimum distributed capacity and leakage reactance.
- Precision Winding... accuracy of winding 1%, perfect balance of inductance and capacity; exact impedance reflection.
- High Fidelity... UTC Linear Standard Transformers are the only audio units with a guaranteed uniform response of  $\pm 1$  DB from 20-20,000 cycles.



## TYPICAL LS LOW LEVEL TRANSFORMERS

Type No.	Application	Primary Impedance	Secondary Impedance	$\pm 1$ db from	Max. Level	Relative hum-pickup reduction	Max. Unbalanced DC in prim'y	List Price
LS-10	Low impedance mike, pickup, or multiple line to grid	50, 125, 200, 250, 333, 500/600 ohms	60,000 ohms in two sections	20-20,000	+15 DB	-74 DB	5 MA	\$25.00
LS-10X	As Above	As above	50,000 ohms	20-20,000	+14 DB	-92 DB	5 MA	32.00
LS-12	Low impedance mike, pickup, or multiple line to push pull grids	50, 125, 200, 250, 333, 500/600 ohms	120,000 ohms overall, in two sections	20-20,000	+15 DB	-74 DB	5 MA	28.00
LS-12X	As above	As above	80,000 ohms overall, in two sections	20-20,000	+14 DB	-92 DB	5 MA	35.00
LS-26	Bridging line to single or push pull grids	5,000 ohms	60,000 ohms in two sections	15-20,000	+20 DB	-74 DB	0 MA	25.00
LS-19	Single plate to push pull grids like 2A3, 6L6, 300A, split secondary	15,000 ohms	95,000 ohms; 1.25:1 each side	20-20,000	+17 DB	-50 DB	0 MA	24.00
LS-21	Single plate to push pull grids, split primary and secondary	15,000 ohms	135,000 ohms; turn ratio 3:1 overall	20-20,000	+14 DB	-74 DB	0 MA	24.00
LS-22	Push pull plates to push pull grids, split primary and secondary	30,000 ohms plate to plate	80,000 ohms; turn ratio 1.6:1 overall	20-20,000	+26 DB	-50 DB	.25 MA	31.00
LS-30	Mixing, low impedance mike, pickup, or multiple line to multiple line	50, 125, 200, 250, 333, 500/600 ohms	50, 125, 200, 250, 333, 500/600 ohms	20-20,000	+17 DB	-74 DB	5 MA	25.00
LS-30X	As above	As above	As above	20-20,000	+15 DB	-92 DB	3 MA	32.00
LS-27	Single plate to multiple line	50, 125, 200, 250, 333, 500/600 ohms	30-12,000 cycles	+20 DB	-74 DB	8 MA	24.00	24.00
LS-50	Single plate to multiple line	15,000 ohms	50, 125, 200, 250, 333, 500/600 ohms	20-20,000	+17 DB	-74 DB	0 MA	24.00
LS-51	Push pull low level plates to multiple line	30,000 ohms plate to plate	50, 125, 200, 250, 333, 500/600 ohms	20-20,000	+20 DB	-74 DB	1 MA	24.00
LS-141	Three sets of balanced windings for hybrid service, centertapped	500/600 ohms	500/600 ohms	30-12,000	+10 DB	-74 DB	0 MA	28.00

## TYPICAL LS OUTPUT TRANSFORMERS

Type No.	Primary will match following typical tubes	Primary Impedance	Secondary Impedance	$\pm 1$ db from	Max. Level	List Price
LS-52	Push pull 2A5, 250, 6V6, 49 or 2A5 A Prime	8,000 ohms	500, 333, 250, 200, 125, 50, 30, 20, 15, 10, 7.5, 5, 2.5, 1.2	25-20,000	15 watts	\$28.00
LS-55	Push pull 2A3's, 6A5G's, 300A's, 273A's, 6A3's, 6L6's	5,000 ohms plate to plate and 3,000 ohms plate to plate	500, 333, 250, 200, 125, 50, 30, 20, 15, 10, 7.5, 5, 2.5, 1.2	25-20,000	20 watts	28.00
LS-57	Same as above	5,000 ohms plate to plate and 3,000 ohms plate to plate	30, 20, 15, 10, 7.5, 5, 2.5, 1.2	25-20,000	20 watts	20.00
LS-58	Push pull parallel 2A3's, 6A5G's, 300A's, 6A3's	2,500 ohms plate to plate and 1,500 ohms plate to plate	500, 333, 250, 200, 125, 50, 30, 20, 15, 10, 7.5, 5, 2.5, 1.2	25-20,000	40 watts	50.00
LS-6L1	Push pull 6L6's self bias	9,000 ohms plate to plate	500, 333, 250, 200, 125, 50, 30, 20, 15, 10, 7.5, 5, 2.5, 1.2	25-20,000	30 watts	42.00

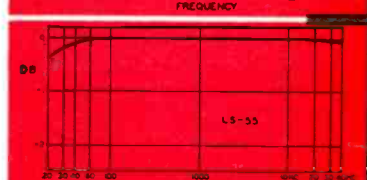
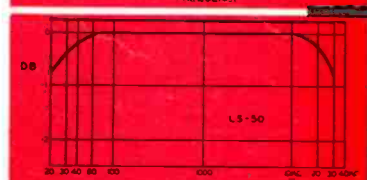
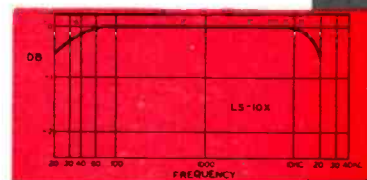

Write for our Catalog PS-408

*United Transformer Co.*

150 VARICK STREET NEW YORK 13, N. Y.  
EXPORT DIVISION: 13 EAST 40th STREET, NEW YORK 16, N. Y. CABLES: "ARLAB"



# AUDIO ENGINEERING

Successor to **RADIO**

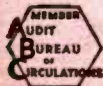

John H. Potts, Editor  
 C. G. McProud, Managing Editor  
 Lawrence LeKashman, Asst. Editor  
 Louisa B. Dresser, Edit. Prod. Mgr.

Sanford R. Cowan, Publisher  
 S. L. Cahn, Adv. Director  
 H. N. Reizes, Adv. Mgr.  
 D. Reissman, Circ. Mgr.

### Editorial Advisory Board

Howard A. Chinn  
 John D. Colvin  
 C. J. LeBel  
 J. P. Maxfield  
 George M. Nixon  
 Winston Wells  
 S. Young White

### Representatives

James C. Galloway  
 816 W. 5th St., Los Angeles 13, Calif.  
 Dale International Publications, Ltd.  
 105 Bolsover St.  
 London W. 1, England  
 Harris & Floyd  
 297 Swanston St., Melbourne  
 C. I, Victoria, Australia

Established 1917

CONTENTS

OCTOBER, 1948

Vol. 32, No. 10

Editor's Report .....	4
Letters.....	8
Magnetic Tape Recorder of Broadcast Quality— <i>Harold Lindsay and Myron Stolaroff</i> .....	13
Intermodulation and Harmonic Distortion Measurements— <i>J. Avins</i> .....	17
Measuring Amplifier Internal Resistance— <i>Walter Richter</i> .....	19
Audio Engineering Society, San Francisco Section.....	20
Elements of Residence Radio Systems, Part II— <i>C. G. McProud</i> .....	21
High Quality Speaker Enclosure— <i>Herbert G. Eidson, Jr.</i> .....	24
The Problem of Sound Distribution, Part III— <i>O. L. Angevine and R. S. Anderson</i> .....	28
Experimental Data on Germanium Crystal Amplifiers— <i>S. Young White</i> .....	32
Resistor Error in Attenuators— <i>Herbert I. Keroes</i> .....	34
DBM—Impedance Chart— <i>Clarkstan Corp.</i> .....	36
New Products .....	38
Professional Directory .....	38
Record Revue— <i>Edward Tatnall Canby</i> .....	45
TECHNICANA: Notes on a 6AS7G Amplifier.....	50
Advertising Index .....	56

### COVER

Sound wave emitted by loudspeaker. Photographed by Winston Wells especially  
 for AUDIO ENGINEERING.

AUDIO ENGINEERING (title registered U. S. Pat. Off.) is published monthly at New York, N. Y., by Radio Magazines, Inc., J. H. Potts, President; S. R. Cowan, Sec'y-Treas. Executive and Editorial Offices at 342 Madison Avenue, New York 17, N. Y. Subscription rates—United States, U. S. Possessions and Canada, \$3.00 for 1 year, \$5.00 for 2 years; elsewhere \$4.00 per year. Single copies 35c. Printed in U. S. A. All rights reserved. Entire contents copyright 1948 by Radio Magazines, Inc. Entered as Second Class Matter July 29, 1948 at the Post Office, New York, N. Y., under the Act of March 3, 1879.

# EDITOR'S REPORT

---

## MESSAGE FROM AUSTRALIA

- The charming and gracious letter which we are happy to publish below was just received from Australia.

Sir:

I have just returned from a world tour studying radio from the Broadcast Engineer's point of view. My trip included the United States.

I hope you can find space to publish this letter as an appreciation of the ready assistance and advice that was given to me at all times by engineers in your country. So many of us from Australia and other countries visit the U.S. and I am sure at times, we must occupy quite a lot of their valuable time.

I cannot of course, write personally to every engineer who entertained me, but as I know *AUDIO ENGINEERING* circulates amongst practically all those who have the same interests as I, this letter is almost sure to reach them. I would like to say how much I admire the ready inter-change of information and ideas amongst American Engineers and from them to visitors overseas.

*AUDIO ENGINEERING* is filling a need in the broadcast field and it is just what was wanted. It avoids unnecessarily wading through many articles in other magazines which are not of particular interest in the broadcast field. Keep on with the good work.

Yours sincerely,

L. N. Schultz.

Chief Engineer — 2GB, Sydney,  
Australia.

We are proud that our readers have been so courteous and helpful to this visitor from abroad, and we feel that Mr. Schultz's idea of writing a "thank you" note for

publication in a magazine which he knows<sup>o</sup> will reach practically all whom he has seen is one which we Americans in similar circumstances could well follow.

## TRANSISTORS

- From Geoffrey Parr, editor of our well-known English contemporary, *Electronic Engineering*, comes a cable congratulating us on the series of articles on germanium crystal amplifiers now running in this magazine. S. Young White is learning a great deal about the idiosyncrasies of these devices through his experimental work and feels that he will soon have his development work up to a point where these crystals can be put into production.

## AUDIO ENGINEERING SOCIETY NEWS

- On September 14th the Audio Engineering Society held a special session on disc recording at the Western Union Auditorium in New York City. Despite the heat, approximately 300 audio engineers attended and heard a talk by R. A. Lynn of NBC on the relative merits of vertical and lateral recording, and a lecture and demonstration by V. J. Liebler of Columbia Records, Inc., on the development of the new Microgroove records. Both were very well received. Before introducing the speakers for the evening, C. J. LeBel reported on the remarkable progress of the AES and pointed out that already employers are advertising for audio engineers rather than, as heretofore, electronic engineers with audio experience.



**CAST ALNICO V and VI THIN WALL RINGS  
FOR MAGNETIC FOCUSING ASSEMBLIES**

*Quality and Quantity - NO PROBLEM!*

In TELEVISION SETS, magnetic focusing eliminates blur; gives clear, sharp reception even during warm-up, or line voltage fluctuations; and the *first* focusing adjustment is the *last*. The thin ring-type permanent magnets of Alnico V and VI produced by Arnold for this use (several sizes are pictured here) are *cast*, not sintered, in order to save on first cost. It's a difficult job, but Arnold's advanced methods produce these rings in the desired quality and any quantity, *without trouble*. —No matter what the application, in any grade of Alnico or other materials, you can depend on Arnold Permanent Magnets. We'll welcome your inquiries.

**THE ARNOLD ENGINEERING COMPANY**



Subsidiary of

**ALLEGHENY LUDLUM STEEL CORPORATION**

147 East Ontario Street, Chicago 11, Illinois

*Specialists and Leaders in the Design, Engineering and Manufacture of PERMANENT MAGNETS*



# NEW!...the Roto Ranger

—automatically rotates one of 18 separate scales into position as you select the range.

SIMPSON MODEL 221 ROTO-RANGER  
HIGH-SENSITIVITY A.C./D.C. VOLT-OHM-MILLIAMMETER

Here is the only multiple-scale test instrument of its kind in the world. It definitely reduces the possibility of errors by providing a single scale for each range of this finest vol-ohm-milliammeters. As the selector switch is moved to the range desired, an ingenious gearing mechanism rotates a drum, bringing into place behind the meter window the proper scale for that range. Here is the equivalent of 25 separate instruments combined in one sturdy and compact unit. (18 scales; 7 additional direct reading ranges through use of high voltage and output jacks.) The patented Roto-Ranger principle eliminates the confusion of numerous readings off one scale, and the multiplying factors common to ordinary multi-range testers, by providing a separate scale for each range. There are no cramped calibrations in these full sized Roto-Ranger scales. Each is designed as it would be for a separate instrument.

**Simpson**  
INSTRUMENTS THAT STAY ACCURATE

SIMPSON ELECTRIC COMPANY  
5200-5218 W. Kinzie St., Chicago 44, Ill.  
In Canada: Baco-Simpson, Ltd.,  
London, Ontario

## Ranges

20,000 Ohms per Volt D.C., 1,000 Ohms per Volt A.C.  
Volts, A.C.: 2.5, 10, 50, 250, 1000, 5000  
Volts, D.C.: 2.5, 10, 50, 300, 1000, 5000  
Milliamperes, D.C.: 10, 100, 500  
Microamperes, D.C.: 100  
Amperes, D.C.: 10  
Output: 2.5, 10, 50, 250, 1000  
Ohms: 0-2000 (12 ohms center), 0-200,000 (1200 ohms center), 0-20 megohms (120,000 ohms center).  
Size: 12<sup>3</sup>/<sub>4</sub>" x 10<sup>1</sup>/<sub>8</sub>" x 5<sup>7</sup>/<sub>8</sub>"  
Weight: 8 lbs. 9 oz.  
Price, complete with test leads and 28-Page Operator's Manual..... \$69.85

High voltage probe (25,000 volts) for TV, radar, x-ray and other high voltage tests, also available.

Ask your Jobber, or write for complete descriptive literature





# AUDIO TRANSFORMERS for [ UNIFORM RESPONSE LOW DISTORTION IN 3 FREQUENCY RANGES

*Write for Catalog  
showing complete  
new stock line*

## Full Frequency Range

30 to 15,000 Cycles, provides uniform response over this entire band with  $\pm 1/2$  db up to 10 watts of audio power, within  $\pm 1$  db over 10 watts. Standard RMA impedances. Hum balancing coil structures and nickel alloy shielding. Included are Input, Output, Driver, and Modulation Transformers; Modulation Reactors. Sealed in Steel construction, stud mounting, with pin-type terminals.

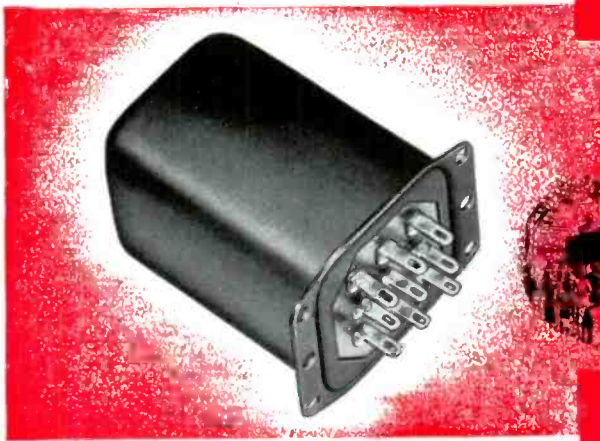

## Public Address Range

50 to 10,000 Cycles, frequency response within  $\pm 1/2$  db up to 10 watts of power, within  $\pm 1$  db over 10 watts, throughout this range. Secondary impedances match 600 and 150-ohm lines, 16, 8 and 4-ohm reproducing systems. Listed are Driver and Output Transformers. Sealed in Steel construction, flange mounting, with solder lugs or wire leads.



## Communications Range

200 to 3,500 Cycles, affords response with variations not exceeding  $\pm 1$  db over the range of voice frequencies. For use with 600 or 150-ohm lines. Input, Output, Driver and Modulation Transformers offered. Sealed in Steel construction, flange mounting, with wire leads or solder lugs.



# CHICAGO TRANSFORMER

DIVISION OF ESSEX WIRE CORPORATION

3501 ADDISON STREET • CHICAGO 18, ILLINOIS

✓ Check  
these outstanding  
IMPROVEMENTS

**ADC**  
**JACKS**

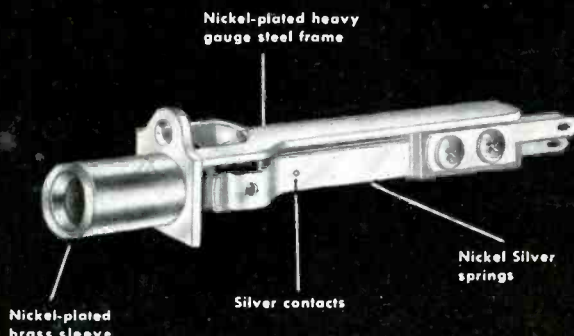

*Now You Get*  
**ALL THESE BENEFITS**

ALL ADC JACK  
PANELS NOW CONTAIN  
THESE NEW ADC JACKS

- Greater Strength & Rigidity!
- Less Corrosion!
- Better Contacts!
- Longer Life!

See your jobber  
or write today  
for ADC Catalog

The new streamlined design of ADC Jacks uses heavier gauge metal for *greater strength*. The frame is die-formed and press-welded for utmost rigidity and dimensional accuracy.

Silver-alloy contacts and genuine Nickel Silver springs guarantee corrosion resistance, even under the most humid conditions.

All the way through, the new ADC is a better jack! If you require top quality and precision-made components, ADC Jacks merit your *first* consideration.

**ADC**

**Audio DEVELOPMENT CO**

*Audio Develops the Finest*

2851 13th AVE. SOUTH · MINNEAPOLIS 7, MINN.

— Letters —

**About Our June Cover**

Sir:

I could probably win a bet that you have already been written to, or perhaps wired by, KOMO or the Austin Company about the cover on your June issue. (*You lose.*—Ed.) Apparently the table pictured in KOMO's control room is quite unusual, and they dial counter-clockwise instead of clockwise, like the rest of us. Also, the "ON AIR" sign is reversed.

What happened?

David L. Farrell,  
Control Room, WCSS  
Amsterdam, N.Y.

Sir:

What a place KOMO must be with turntables which revolve counter-clockwise (note the left-handed pickup), telephone dials that turn from right to left, and an "ON AIR" sign which reads backwards . . . .

E. F. Phillips

. . . Apparently we can't get away with anything insofar as control room pictures are concerned. We reversed this purposely; otherwise our "AUDIO ENGINEERING" slug would have covered interesting portions of the picture. But we didn't realize that our eagle-eyed readers would pick up quite so many tell-tale points.—Ed.

**High Fidelity**

Sir:

I have followed with a great deal of interest the many articles on high fidelity. Like the rest I have my own views on the subject. Perhaps they may be of interest to your other readers.

I specialize in audio experimenting together with its associated fields. As far as I'm concerned, high fidelity means this to me — a highly flexible audio amplifier and the best reproducing system possible.

To clarify that statement, here is my own personal set-up. G. E. pickup through my own preamplifier employing 300-500-800 cycle crossovers, bass boost and gain control to feed Meissner Tuner. This enables me to match radio side of tuner to phono to main audio amplifier. Main amplifier uses 6B4's (I agree with the triode hounds!), variable feedback from voice coil covering three stages, treble boost or droop and of course, main gain.

All this, of course, doesn't take into consideration the bass and treble boost or droop of the tuner which is used for the general balancing of phono or radio. My own ear dictates an approximate ortho curve, so preamp and main amplifier are set for the average best listening. The tuner controls take care of the varying individual characteristics of the program material.

From this I hope you can begin to perceive my point of view. The amplifiers should indeed be high fidelity to cleanly reproduce any frequency throughout the audio spectrum and it should be wide range with flexibility. My own runs 35 to better than 20,000 cycles and I can make it flat or build as I desire. Above all, it's cleaner than most in its reproduction throughout. I use a Lansing 12" floating on felt and rubber.

[Continued on page 11]



# for A-M BROADCAST MEASUREMENTS



**TYPE  
1931-A  
MODULATION  
MONITOR**

**TYPE  
1932-A  
DISTORTION &  
NOISE METER**



General Radio Company has supplied precise measuring equipment for broadcast stations for over twenty years. G-R instruments are designed for accuracy, ease of operation and long, trouble-free life. G-R broadcast instruments are quality instruments designed specifically for broadcast station use.

These two meters are standard equipment in most a-m broadcast stations; they are essential "musts" where transmitters and associated station equipments are to be operated continuously at peak efficiency.

The Modulation Monitor indicates continuously the percentage amplitude modulation of broadcast and other radiotelephone transmitters. The Distortion & Noise Meter measures the a-f distortion in transmitters or audio equipment such as line and speech amplifiers. It finds many uses in communications laboratories and in production testing of radio receivers.

#### FEATURES

The TYPE 1931-A Modulation Monitor allows the following measurements to be made continuously: Percentage Modulation on either positive or negative peaks; Program-level monitoring; Measurement of shift of carrier when modulation is applied; Transmitter audio-frequency response.

Requires r-f input of only 0.5 watt; carrier frequency range 0.5 to 60 Mc; terminals for remote indicator; distortion less than 0.1%; 600-ohm audio output circuit for audible monitoring; modulation percentage range 0 to 110%; flashing over-modulation lamp operates over 0 to 100% on negative peaks; overall accuracy at 400 cycles is 2% of full scale at 0% and 100% and 4% at any other modulation percentage; a-f frequency response of meter indication is constant within 1.0 db between 30 and 15,000 cycles when used with the TYPE 1932-A Distortion & Noise Meter.

Type 1931-A Modulation Monitor \$395.00

#### FEATURES

The TYPE 1932-A Distortion & Noise Meter is continuously adjustable over the audio-frequency range and can be set to any frequency quickly, since it has only one main tuning control plus a small trimmer. With it measurements can be made on a-f distortion in radio transmitters, line amplifiers, speech amplifiers, speech input equipment to lines; noise and hum levels of a-f amplifiers, wire lines to the transmitter, remote pick-up lines and other station equipment are made with ease.

Full-scale deflections on the large meter read distortions of 0.3%, 1%, 3%, 10% or 30%; range for carrier noise measurements extends to 80 db below 100% modulation, or 80 db below an a-f signal of zero dbm level. The a-f range is 50 to 15,000 cycles, fundamentals, for distortion measurements and 30 to 45,000 cycles for noise and hum.

Type 1932-A Distortion & Noise Meter . . . \$575.00



**GENERAL RADIO COMPANY** Cambridge 39, Massachusetts

90 West St., New York 6

920 S. Michigan Ave., Chicago 5

950 N. Highland Ave., Los Angeles 38

**This is actual  
SOUND-ON-FILM  
RECORDING  
performance**



When you can secure the quality of results shown in these graphs, can you afford to use any recording equipment that does not approach such a standard?

On the basis of definite performance, the Maurer 16-mm Recording Optical System — the only postwar designed equipment of its kind on the market — is unrivaled in its field regardless of price.

And the Maurer 16-mm System has already been selected by two of the four major radio networks for their television requirements.

• • •

Anticipating a demand for finer quality of recording, including the higher frequencies, the Maurer Recording Optical System was designed to produce an extremely fine line image that makes possible the recording of frequencies beyond 10,000 cycles, with very low distortion. The galvanometer of the postwar Maurer Model 10 System is tuned to 12,000 cycles. This is the model that has been sold to the trade for two years.

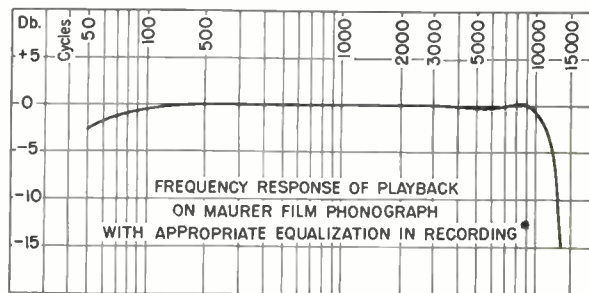
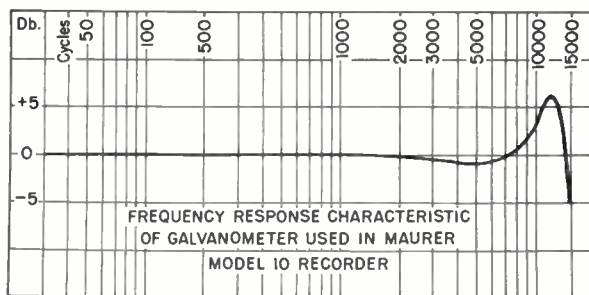

\*For those who may have been educated to believe that such a result is not possible with 16-mm film, we shall be glad to demonstrate that it not only is possible, but practical commercially NOW.

**16mm  
maurer**

**J. A. MAURER, INC.**

37-01 31st Street, Long Island City 1, N. Y.

Professional Motion Picture Cameras and Recording Equipment for the Production of Industrial, Educational and Training Films



## — Letters —

[from page 8]

Thus to me, high fidelity means reproducing any material available, limited or frr, which to my own ear sounds as its most natural reproduction. The material which isn't more or less frr usually doesn't get played!

I doubt if there are many ears which hear flat, but there are no doubt many trained ears to detect unnaturalness and distortion. Let your musical sense determine the curve and your engineering its ultimate reproduction result.

Let's keep AUDIO ENGINEERING "audio"!

Acoustically yours,  
J. P. Cook,  
2609 Buena Vista,  
Bakersfield, Calif.

## News

### Federal Promotes Stone

● The election of Rear Admiral Ellery W. Stone (USNR) as president and General William H. Harrison as chairman of the board of both the Federal Telephone and Radio Corporation and its world-wide manufacturing and sales subsidiary, the International Standard Electric Corporation, was announced today by Colonel Sosthenes Behn, chairman and chief executive officer of the International Telephone and Telegraph Corporation, parent concern of the two companies. Fred T. Caldwell, formerly president of Federal Telephone and Radio and International Standard Electric was elected vice chairman of the boards of both corporations. These appointments become effective September 1.

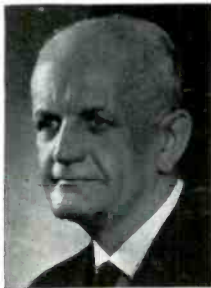

Admiral Stone, since 1931, has served in various executive capacities with the I. T. & T. System, most recently holding the post of executive vice president of Federal Telephone and Radio, domestic manufacturing subsidiary of I. T. & T. General Harrison, vice president in charge of Operations and Engineering of the American Telephone and Telegraph Company, recently was elected president of I. T. & T., also to become effective on September 1. During the war he served as a Major General, acting as Director of Procurement, Army Service Forces, Washington, D. C.

In addition to various campaign medals for service during World Wars I and II, Admiral Stone also holds both the United States Navy and the United States Army Distinguished Service Medals. He is a Knight Commander of the British Empire, a Knight of the Grand Cross of St. Maurice and St. Lazarus (Italy), a Grand Officer of the Crown of Italy, and a Knight of the Grand Cross of San Marino.

# Now Available High Q TOROIDAL COILS

The solution of filter network problems, has been greatly simplified through the use of toroidal coils wound on molybdenum permalloy cores. Design engineers have learned to depend upon them since discovering that only these toroids possess all the necessary qualities of a good high "Q" coil.

*Of the 30 different items now being manufactured, the most available types now being supplied are:*

TYPE	RANGE
TC-1	Any Ind. up to 10 HYS
TC-2	Any Ind. up to 30 HYS
TC-3	Any Ind. up to 750 MHYS

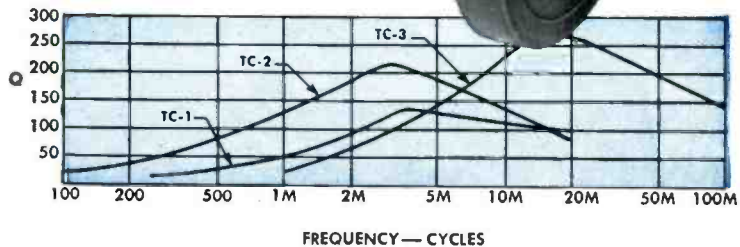

## FILTERS

We are producing toroidal coil filters which consistently demonstrate the value of toroidal coils. These filters cannot be matched in stability, accuracy and sharpness by filters made with the usual laminated type of coil.

Orders for samples or production quantities are equally respected. All inquiries will be promptly handled.

### Burnell & Co.

DESIGNERS AND MANUFACTURERS  
OF ELECTRONIC PRODUCTS

45 WARBURTON AVE. • YONKERS 2, N. Y.

# Pick the **POWER** you need

take the performance for granted

8 WATTS



755A

Combines outstanding quality with low cost and small space requirements. Frequency range 70 to 13,000 cycles. Coverage angle 70°. 8 $\frac{3}{8}$ " in diameter, 3 $\frac{1}{8}$ " deep. Requires only 2 cubic feet of enclosure space.

20 WATTS



756A

Ample power capacity for the great majority of applications—*plus peak* performance. Frequency range 65 to 10,000 cycles. Coverage angle 60°. 10 $\frac{1}{4}$ " in diameter, 3 $\frac{1}{4}$ " deep. Enclosure space 2 $\frac{1}{2}$  cubic feet.

30 WATTS



728B

Ideal for use wherever extra high power is needed. Frequency response 60 to 10,000 cycles. Coverage angle 50°. 12 11/32" in diameter, 3 25/32" deep. 3 cubic feet of enclosure space.

**T**HREE direct radiators will meet practically all your requirements—in broadcast stations, wired music, program distribution and sound systems, high-quality home radios and record players. Pick the ones you need on the basis of *power requirements*. You'll find superior *quality of reproduction* in all of them.

Get the full story of this Western Electric line from your local Graybar Broadcast Representative—or write Graybar Electric Company, 420 Lexington Avenue, New York 17, N. Y.

DISTRIBUTORS: IN THE U. S. A. —  
Graybar Electric Company.  
IN CANADA AND NEWFOUNDLAND—  
Northern Electric Company, Ltd.



## Western Electric

—QUALITY COUNTS—

AUDIO ENGINEERING OCTOBER, 1948



# MAGNETIC TAPE RECORDER

## *Of Broadcast Quality*

HAROLD LINDSAY\* And MYRON STOLAROFF\*

Design details of a new high-fidelity instrument for exacting applications.

**M**AJOR EMPHASIS in designing the Ampex magnetic-tape recorder has been on the production of unsurpassed recordings with reliability and continuity of performance to satisfy the most rigid professional standards. Production model 200A, shown in Fig. 1, has the following capabilities:

- a. *Full coverage of the audible spectrum* ( $\pm 1$  db from 30 to 15,000 cps).
- b. *Low distortion.* From input to output terminals the system shows 4 per cent intermodulation distortion at peak meter reading—with harmonic distortion not exceeding 5 per cent 10 db above peak meter reading.
- c. *Great dynamic range.* The over-all unweighted noise level of the system (measured flat from 30 to 15,000 cps) is 60 db below full modulation, or 5 per cent harmonic distortion.

The significance of the above statements is that reproduction on this system is, for all practical purposes, substantially perfect. The use of separate recording and playback heads and amplifiers allows essentially instantaneous monitoring and makes possible extremely critical comparisons between recordings and original programs—comparisons which cannot be readily made with other systems. Such a comparison—where the output of the recorder is directly compared with the material being recorded—has been given the term "A-B Test." The incoming signal is fed into the recorder. The monitoring amplifier is then bridged alternately across the recorder input and output terminals.

When live programs are recorded—using the best possible input equipment—and when monitoring with the highest-quality amplifier and speaker systems, critical listeners have not been able to determine which is the original program and which the reproduction. Comparable results with other methods of recording can generally be

obtained only under carefully-controlled laboratory conditions.

### **Overload Characteristic**

Another advantage of tape recording results from the gentle overload characteristic. Unlike other methods of recording, tape distortion increases gradually as the signal level is increased to the point of saturation. Because of this, severe transient overloads do not cause breakup and therefore do not spoil the program. This feature allows considerable latitude in setting up for recording and eliminates the necessity for rigid monitoring of the input signal.

Other outstanding features of magnetic-tape recording—such as permanency of record without deterioration,

simplicity of editing, and re-use of the medium, have been amply covered in previous literature.

### **Recorder Details**

The electronic system consists of four plug-in chassis units: the power supply, a relay chassis for controlling all operations, the recording amplifier, and the playback amplifier. The input of the recording amplifier and the output of the playback amplifier are 150 or 600 ohms. The whole chassis assembly is resiliently mounted.

The power supply consists of a 360-volt plate-voltage source for the erase, bias, and playback output tubes, and a regulated 300-volt supply for the recording and playback amplifiers, the oscillator, and erase and bias screens.

Fig. 1. Author Lindsay takes some measurements on the Ampex tape recorder.



\*Engineers, Ampex Electric Corp., San Carlos, Calif.

In addition, there is a d-c filament supply for the playback amplifier, a 36-volt a-c output to provide—through a selenium rectifier—24 volts d-c for all relays and selenoids, and filament supply for all tubes.

The essential problem in the recording amplifier is to convert the signal voltage into proportional current in the head. This is accomplished by the circuit shown in Fig 2. A 6AC7 was chosen for the output tube because of its high mutual conductance. The current output of this tube is further increased by a transformer. The secondary current is fed back through the cathode of the output tube. This assures that the current through the recording head is proportional to the signal voltage and is free of distortion. Ample undistorted recording current is provided for any of the commonly-available tapes under any desirable mode of operation.

The design of erase and bias circuits is extremely critical from the standpoint of achieving the lowest possible tape noise. With a properly-designed system, the residual tape noise caused by erase and bias currents will be below that of the playback amplifier. It has been found that the quietest erasure can be made by placing the entire roll of tape in a powerful gradually-decreasing 60-cycle field. The erase and bias currents in the recorder should not measurably increase the noise level of the tape above that obtained by this type of tank erasure. This result is achieved

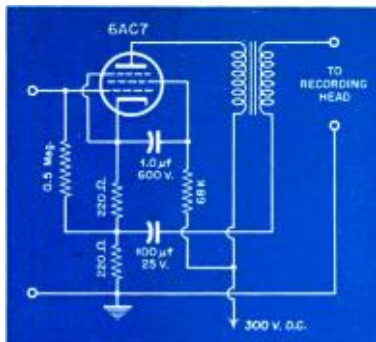

Fig. 2. Circuit of the output stage of the recording amplifier. Current feedback arrangement shown here contributes to proportionality of head current.

by proper design of heads and excellent current waveforms.

The actual setting of the bias is not critical as the same undistorted output is obtained (4 per cent intermodulation distortion) over a wide variation in bias current once a definite minimum value is exceeded. Over-all sensitivity is reduced with higher bias, as it takes greater recording current to supply the same output, but since the recording amplifier has ample capacity this is of no consequence. The bias is normally set slightly above that value giving maximum output for constant recording input and thus is conveniently set by ear. At lower tape speeds the bias setting becomes more critical, as high values of bias reduce the high-frequency response.

There is one bias setting which, at first, seems very attractive. It usually occurs at a value of bias just below the current giving maximum response, and results in a dip in the over-all intermodulation distortion. The setting is quite critical, but, for the same limiting distortion, 8-db higher output can be obtained. Because of this apparent increase in dynamic range, the bias was always adjusted to this value during the early stages of this development. However, it has since been discovered that this setting results in a poor overload characteristic. When A-B tests were made it was found that, at the point where differences between program and reproduction could be detected, the output level was higher with the higher bias current in spite of the fact that the critical setting resulted in 8-db

Fig. 3. View of units suspended from top plate shows rewind assembly, left rear, capstan drive, center, and takeup assembly, right rear. Brakes can be seen below both turntable drives.

higher measured dynamic range. Therefore, the dip setting was abandoned.

#### Playback Noise

The main problem on playback is to obtain best signal-to-noise ratio. The maximum signal obtainable from a given design of playback head is limited by capacitive loading of the head at high frequencies. Therefore, the maximum number of turns is placed on the head for which loading does not occur within the desired frequency range. Because of the tremendous amplification required for the low frequencies, great care has been taken to eliminate hum pickup. The playback head is contained in two mu-metal shield cans with a copper can in between, and the entire head placed in a cast-iron head housing. Matching caps cover the front of the playback head when the head gate is closed into the playing position. Direct current is used on tube filaments to eliminate hum from this source.

Wide-range frequency response is not a problem at 30 inches per sec., as 15,000-cps response is readily obtained at lower speeds. However, considerable equalization is necessary to achieve flat response because the voltage induced in the playback head is proportional to frequency and because of demagnetization effects in the tape at shorter wavelengths. For maximum signal-to-noise ratio, the recording current must be equalized to provide equal probability of overload at all frequencies. The exact nature of this equalization requires careful study as the energy distribution of program material may vary widely with different types of pick-ups. This problem has now been studied for a considerable time and it has been found that the low-frequency end can be boosted 5 db at 50 cps with a 50-microsecond pre-emphasis on the high end without overload under a wide variety of program material. The playback amplifier is equalized to provide flat over-all response.

#### Tape Types

Several varieties of tape are now available in this country. In general, the lower-force tapes have proved most satisfactory for broadcast applications because they are easier to erase and more quiet, and have lower modulation noise. Tapes in this category are made by Audio Devices, Inc., and Minnesota Mining & Mfg. Co. (Type RR). Type RR is outstanding because of its uniform coating which results in low modulation noise and extremely uniform magnetic properties and output. In the latter property, this tape sur-

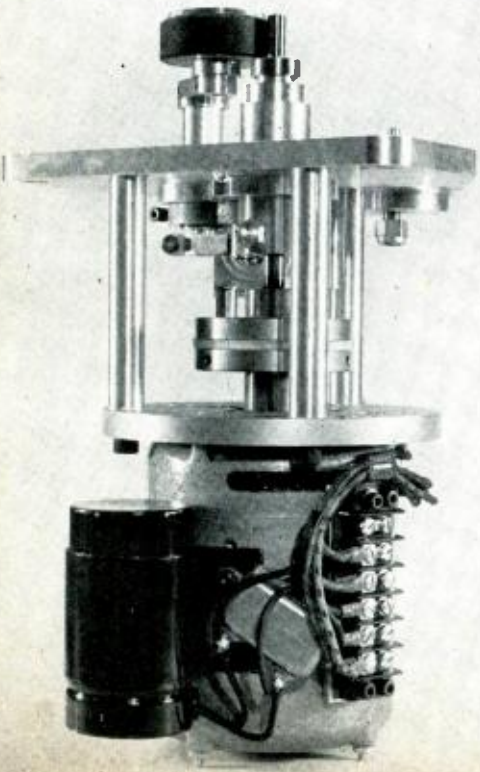



passes samples obtained from Germany where this method of recording saw its early development.

Higher coercive-force tapes, such as Minnesota Type A or Type B, have 10-db higher output for the same distortion but also have greater modulation noise and are difficult to maintain quiet. A great deal of research is being conducted to improve tape characteristics further and promising results have already been obtained. They indicate that the dynamic range of the medium will continually improve.

#### Tape Speed

Use of the 30-in. speed warrants some justification. Very excellent results have been obtained at half this speed. In fact, it is possible to obtain flat response to 15,000 cps with the same intermodulation distortion and unweighted noise level as quoted for the 30-in. speed. To obtain 15,000-cps response requires 15-db additional gain at 10,000 cycles in the playback amplifier, which brings up the hiss level and harmonic distortion accordingly. The measured noise level is not increased because the noise in the system consists primarily of low-frequency components and at 30 inches per sec. the hiss level is more than 15 db below the components which produce the noise reading. While it is still impossible to distinguish recorded material from the original in A-B tests at 15 inches per sec., the higher hiss can be detected on the reproduction during quiet passages when monitoring at original orchestra level.

Because of the higher noise level and harmonic distortions, it is not practical to make re-recordings at the lower speed as these deficiencies are doubled in the copy. Therefore, for the highest-quality recordings which can be re-recorded without detectable deterioration, 30 inches per sec. is indicated as the best choice.

Further advantages of the higher speed are as follows:

- a. *Extremely low hiss level.* Although the measured noise level is the same as at 15 inches per sec., because of the ear characteristic at low levels, the noise background actually heard on programs is predominantly tube and tape hiss. Therefore, at 30 inches the "listening" dynamic range is considerably greater.
- b. *Ease of editing.* At 30 inches, it is possible to remove syllables from words or clicks and pops from a recording without disturbing the actual program. This would be difficult or impossible at lower speeds.

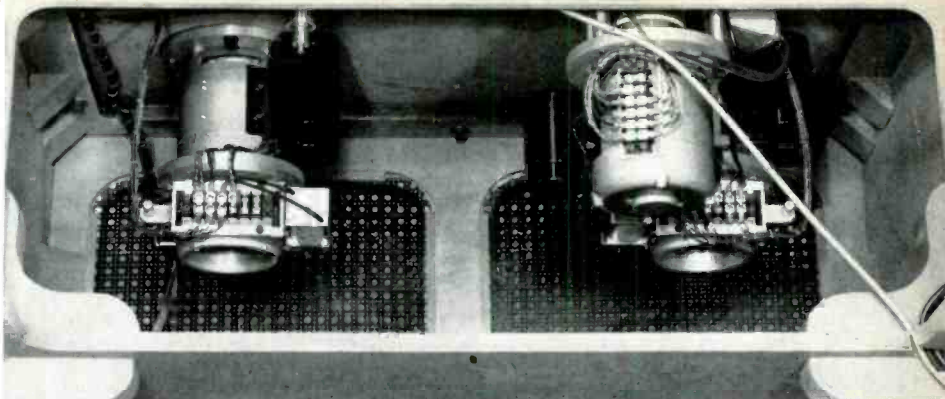

Fig. 4. Capstan drive includes resilient coupling, above motor, and crank-actuated idler which presses tape against driving shaft, above top plate. Assembly is adjustable for tape alignment.

- c. *Uniformity of frequency response.* At extremely short wavelengths the response of tape varies considerably between rolls and even within a single roll. At 30 inches, the shortest wavelength used is still long enough not to exhibit these inconsistencies. This is proved by the fact that all available tapes, though varying greatly in magnetic properties, give exactly the same frequency response with no change in equalization at 30 inches per sec.
- d. *Independence of bias setting.* As explained above, the bias setting is not critical and at 30 inches high values of bias do not affect the high-frequency response. At shorter wavelengths the bias tends to erase high frequencies and it is necessary to set the bias more critically.
- e. *Greater stability of motion.* The 30-inch speed contributes greatly to the achievement of a steady tape motion, resulting in undetectable wow and flutter content even in the most susceptible program material.
- f. *Head alignment less critical.* In order for recordings made on one machine to play back on another without losing high-frequency response, all the gaps of recording and playback heads must be very critically aligned perpendicular to the tape. The higher the speed the less critical is this adjustment. At 30 inches, there is little danger of heads becoming misaligned as they wear.

#### Mechanical Features

A synchronous drive with very positive tape coupling characteristics gives playback time reproducible to 0.5 sec. per half hour of program time. This

permits, in broadcast operations, the use of machines in close synchronism in pairs, to afford complete program protection.

That the handling of the necessarily substantial quantities of tape required for high-quality performance might be sufficiently convenient to satisfy practical requirements, very high rewind and fast-forward modes of operation have been provided. These speeds have been made as great as possible without exceeding the maximum safe operating tension for the tape during acceleration and without reaching temperatures when passing over tape guides that would cause thermoplastic deformation of the tape.

Total rewind time for 36 minutes of program material is approximately 1 minute, 45 sec. This same rate of speed is available as the fast-forward mode of operation and is particularly useful where it is required to pick up selections within a program. During these high-speed functions the tape will, at times in its transport from one reel to another, acquire velocities of about 760 inches per sec. Stopping the tape, reels, turnables, etc., when traveling at these speeds requires very effective and consistent brakes. They are capable of making a stop from maximum reeling speed in 5 sec., or from normal playing speed in 0.2 sec.

The drive system consists of a removable supply and take-up reel, each mounted on a turntable carried on the vertically-extending shafts of the rewind and takeup drive assemblies; a capstan-drive assembly with its tape-locking idler; a reel idler; and compensating tension arms.

On the German Magnetophon, tape was reeled onto plain hubs without side flanges and was thus removed from the equipment as a solidly-packed self-supporting roll. In the design of the Ampex machine it was

necessary to take into account the fact that the reels were to hold over 50 per cent more tape than Magnetophon reels and would consequently be much less safe to handle as self-supporting rolls. Accordingly, tape is handled on reels consisting of a plastic hub (4-in. diam. by 3/8-in. thick) mounted on a single 14-in. diam. (0.050-in. thick) aluminum flange—providing, when wound to within 3/8 in. of full diameter, storage space for 5400 ft. of 0.002-in. thick recording tape—36 min. of continuous program time.

In operation on the recorder, these reels are placed on turntables carrying a central extended centering-spindle and three equally-spaced drive pins. The centering spindle is somewhat longer than the drive pins to facilitate centering and positioning of the reel. The hub carries three equally-spaced 5/8-in. diam. holes, each centered with respect to a corresponding flange-drive-pin (3/16) hole. A radially-placed tape-measure slot 3/32-in. wide connects each of the 5/8-in. diam. hub holes with the hub periphery.

In threading, the tape is held between thumb and index finger to form a short narrow loop, the short end of which is next to the hub, and inserted through a hub slot and over a drive pin to form a hitch. This threading hitch is rapidly done and is self-freeing on runout.

While this type of reel does not require a hold-down device, editing knobs are provided. They slip on the

portion of the spindle projecting through the reel hub and are pin-keyed to the hub for manual reeling of tape in editing and threading.

#### Drives and Brakes

The rewind, or supply-reel assembly, located to the left rear of the top plate of the recorder, is illustrated in Fig. 3. It consists of a specially-designed vertically-mounted ballbearing two-phase capacitor-type induction motor with double shaft extensions and flanged end bells. Electrical design of the motor is such that the maximum torque is developed at or near zero speed to effect a uniform tape tension throughout the reel. The upper flange serves as a means of attachment to the supporting structure while the lower flange carries the brake assembly.

Brakes are spring-applied and solenoid-released external-band-and-drum type, the drum being carried on the lower motor shaft extension. The brake design has been worked out to effect a differential braking ratio of approximately 2:1, using the self-energizing effect of band wrap. Rewind and take-up assemblies (which are substantially identical otherwise) are arranged so their brakes are self-energizing in opposite directions of rotation and in such order that regardless of which direction the tape is traveling, the reel supplying the tape will always receive the stronger braking action.

Obviously the brakes must operate in unison and this is assured by the solenoid control, which when combined

with the differential action, provides a braking system allowing rapid stops without tape being broken or snarled from the throwing of slack loops. The spring-energized brakes offer considerable advantage here over the use of dynamic braking. Reels are not too free to turn but offer some resistance to the removal of tape. This is particularly important when the machines are used in remote operation where, at rest, the tape will not lose tension and stall the machine through operation of the tape-runout switch associated with the takeup tension arm.

The function of the capstan-drive assembly shown in Fig. 4 is to maintain constancy of tape speed during recording and playback operations. This is effected by the use of a synchronous motor driving, through a mechanical filter system, a precision-ground capstan shaft. This runs in precision bronze sleeve bearings, grooved and graphited and provided with a generous lubricating system. A close-coupled non-slip drive from capstan to tape is obtained by clamping the tape between a rubber-tired ball-bearing idler and the capstan surface. The idler is carried on the end of a bell-crank arm and is solenoid operated.

Including synchronous motor, capstan shaft and housing, capstan idler with bearings and linkages, solenoid, motor capacitor, and terminal strip, the complete assembly is mounted on a common base plate. This is suspended on the under side of the main top plate with spring-loaded spherical-joint bearings arranged for critical adjustment of tape tracking.

On either side of the centrally-located head housing are the tension arms. The one on the left is associated with the reel idler while the right-hand arm is combined with a cutoff switch. The spring-loaded tension arms serve to momentarily equalize sudden changes in tension during starting or stopping and the lesser fluctuations resulting from the passage of a splice. They also preserve tension on the tape while the equipment is at rest.

#### Maintenance

Ease of servicing and maintenance has been provided in the arrangement of the functionally-styled front-access-type console. Further, the general design facilitates simple removal of units for replacement by spares. All chassis units are withdrawn from their plug-in connections and replaced by the combined action of a special leadscrew and crank. The complete head housing is also of plug-in design—held in place by a pair of crank-operated screws.

Fig. 5. Closeup of chassis units shows plug-in arrangement with leadscrew and crank for insertion and removal. Entire base plate is shock and vibration-mounted.

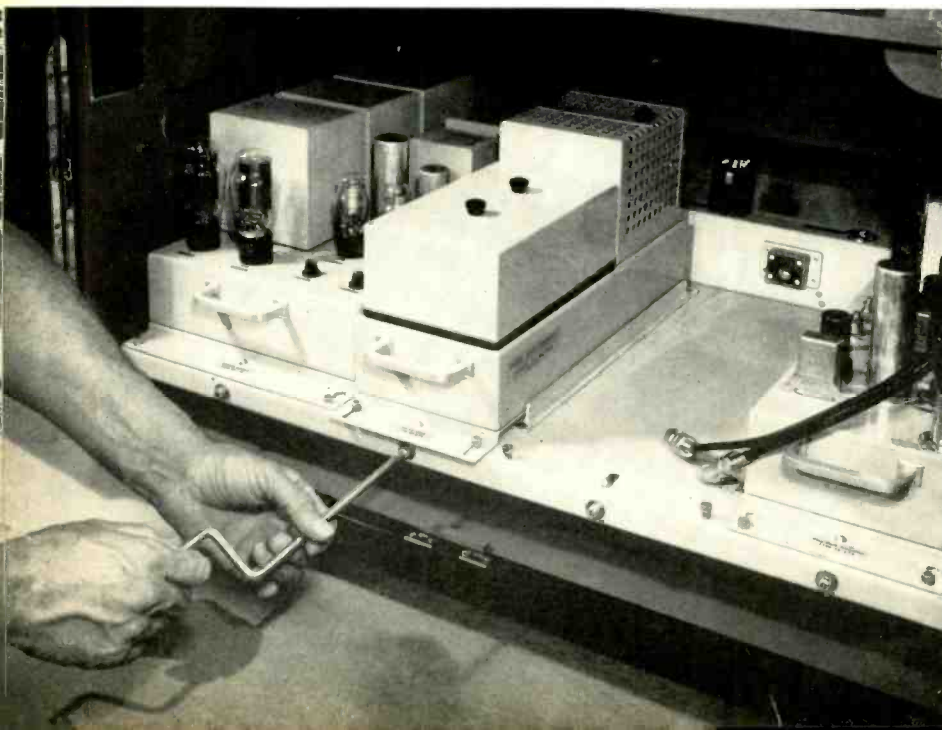



# Intermodulation and Harmonic Distortion Measurements

J. AVINS\*

It has long been recognized that non-linear elements may produce considerable distortion which cannot be correctly evaluated by harmonic distortion measurements. This distortion takes the form of cross-modulation or intermodulation of the component frequencies in the signal, and as a result new sum and difference frequencies are produced which impair the quality of reproduction.

Both harmonic distortion and intermodulation distortion are caused by the same non-linear elements. When a system has a characteristic which does not vary with frequency, therefore, the degree of non-linearity or the distortion can be measured by either the harmonic-distortion or the intermodulation-distortion method with substantially identical results. In the more usual case when the amplification varies with frequency, the harmonic method may not provide a correct measure of distortion. Here the intermodulation method is the more flexible means for measuring the distortion present. Its very flexibility, however, leads to difficulty in interpreting the results obtained, since these results are a function of the choice of frequencies, their relative amplitudes, etc., and to date no satisfactory standards exist which are generally applicable.

## Harmonic and Intermodulation Distortion

If a single frequency is applied to a non-linear system, the output contains distortion components at the harmonic frequencies. If, on the other hand, two signals of different frequency are applied simultaneously, then the output will contain new frequency components which are due to intermodulation of the two frequencies. The intermodulation components produced have frequencies equal to the sum and differences of integral multiples of the original frequencies. Since non-linearity produces harmonic distortion as well as intermodulation distortion, it appears to be a matter

\*RCA License Laboratories, 711 5th Ave., New York City.

of convenience and convention as to whether harmonic distortion or intermodulation distortion is used as a measure of the system non-linearity. For reasons which are described below, intermodulation-distortion measurements are now being used more extensively than heretofore to supplement harmonic distortion measurements and in some instances to supplant them.

At the present time there are two principal methods used to measure intermodulation distortion. These may be referred to conveniently as the "modulation method" and the "wave-analyzer method".

In the modulation method, a low audio frequency  $f_1$  of the order of 100 cps and a high frequency  $f_2$  of the order of 4,000 cps are applied simultaneously to the system. The amount of intermodulation distortion is then observed by noting the extent to which the high-frequency signal has its output amplitude modulated by the low-frequency signal. As shown in the block diagram, Fig. 1, this measurement can be made by using a band-pass filter to separate the high-frequency wave and its sidebands in the output, rectifying them, and observing the amount of low-frequency modulation in the rectified output. The percent intermodulation distortion is usually referred to the upper frequency  $f_2$  which commonly has one-fourth the amplitude of the lower frequency  $f_1$ .

In the wave analyzer method of measuring intermodulation distortion, measurements are made at a number of points throughout the audio-frequency range. The amplitude of  $f_1$  and  $f_2$  may be equal and the frequencies may be varied in such a way that the difference frequency  $f_2 - f_1$  is held constant. The relative amplitude of the intermodulation component at the difference frequency  $f_2 - f_1$  is then considered a measure of the intermodulation distortion. Where a wave analyzer is not available, the difference frequency may be chosen equal to 400 cps to permit the use of standard filters. However, without a wave an-

alyzer, the second order intermodulation component at 800 cps cannot be readily measured. Measurement of the second order intermodulation component is particularly necessary where the non-linearity is symmetrical. A block diagram of this method is shown in Fig. 2.

## Amplification Independent of Frequency

The simplest type of non-linear system is one in which the non-linearity is the same at all frequencies, i.e., the transfer characteristic is independent of frequency. For this condition Warren and Hewlett<sup>1</sup> have demonstrated analytically and experimentally that the system distortion may be expressed in terms of either harmonic distortion or intermodulation distortion. Depending upon the type of non-linearity—whether it is representative of a single-ended amplifier characteristic, a symmetrical push-pull amplifier characteristic, etc., the distortion as measured by harmonic distortion will be approximately one-third the distortion as indicated by intermodulation distortion. Thus, there is a good correlation between the degree of non-linearity as expressed by either harmonic or intermodulation distortion, and it is a matter of convenience and convention as to which measure is used.

## Effect of Frequency Characteristic

When the non-linearity of the system is a function of frequency, there is no longer a correlation between the distortion as measured by harmonic distortion and as measured by intermodulation distortion. The principal reason for the lack of correlation is that if we attempt to measure the non-linearity at a particular frequency in terms of the harmonics which are produced, the harmonics may be attenuated (or amplified) with respect to the fundamental as a result of the frequency characteristic, and therefore the harmonic distortion terms in the

<sup>1</sup>W. J. Warren and W. R. Hewlett, "An analysis of distortion methods by the intermodulation method", *Proc. I.R.E.*, Vol. 36, pp 457-466, April 1948.

output do not represent accurately the distortion or non-linearity at the fundamental frequency.

In general, the intermodulation distortion method is more flexible and can be used to provide a measure of the non-linearity even when a frequency characteristic is present. Thus the non-linearity may be explored by applying two appropriately chosen input signals one or both of which are in the vicinity of the frequency at which the non-linearity is being measured. Clearly, the figures obtained by thus measuring the distortion cannot be interpreted readily on an *absolute* basis because of their dependence on several parameters, principally the frequencies used and their relative amplitudes.

#### Limitation of Harmonic Distortion

The following example will show a typical case in which harmonic distortion measurement fails to evaluate properly the non-linearity present. Consider a radio receiver in which the second-detector design is such that high distortion is produced at high modulation percentage at frequencies above 2,500 cps. The cutoff frequency of the audio amplifier will be assumed to be 4,000 cps. Under these conditions, the second and higher harmonics are outside the passband and therefore harmonic distortion measurements, which must be made with the fundamental above 2,500 cps, will not reveal the distortion in the system. Nevertheless, in operation, distortion is present as revealed by the presence of intermodulation terms in the output, extraneous frequencies which—unlike the harmonic distortion components—lie within the receiver passband.

If an intermodulation distortion test is made in this receiver using the wave analyzer method, the distortion will show up readily if two frequencies of equal amplitudes at 3,000 and 3,400 cps are used to modulate the signal generator. The distortion then is indicated in terms of the first order intermodulation component at 400 cps and the second order component at 800 cps. Since the response at these

two middle frequencies is usually flat, no correction is required.

#### Effect of Pre-emphasis

Measurement of the over-all distortion in frequency-modulation receivers is indicative of the problems which occur where the transfer characteristic is a function of frequency. If, for example, distortion takes place before de-emphasis (for example, in the frequency discriminator), the intermodulation components produced by high-frequency terms will be effectively emphasized with respect to the terms causing the distortion. Thus, if two frequencies at 8,00 and 8,400 cps are applied, intermodulation components at 400 and 800 cps are produced. These are not de-emphasized, but the 8,000 and 8,400 cps components are. It follows that the intermodulation distortion will be 12 db higher than if the same distortion occurred following de-emphasis.

In the above example, the modulation method using a low frequency and a high frequency to modulate the signal generator would not yield results which are as direct as those obtained by the wave-analyzer method. In particular, it cannot be assumed here that the high-frequency component is modulated by the distortion present at low frequencies.

#### Low-Frequency Distortion

Consider an example of low-frequency distortion such as may be produced by an output transformer at high levels. For this case it is clear that either harmonic distortion measurements made with the fundamental in the non-linear range or intermodulation distortion measurements with at least one of the frequencies in the non-linear range will serve as a measure of the distortion. The choice as to which method is to be used here will depend upon the equipment available and the current practice.

#### Sources of Error

In general, there will be many instances where the amplification varies with frequency in such a way as to make harmonic distortion measure-

ments inadequate. For example, in circuits using tone controls, noise suppression circuits, filters, or crossover networks, non-linearity may be present and the conditions may be such that when testing by harmonic distortion methods the harmonics fall outside the passband. Under these conditions, it is clearly difficult to correlate harmonic distortion measurements with intermodulation distortion measurements on the basis of the approximately 3 to 1 ratio which obtains when the transfer characteristic is independent of frequency.

The special case where an amplifier is divided into two or more frequency channels requires comment. For example, consider an amplifier having a "bass channel" extending to 1,000 cps and a "treble channel" handling frequencies above 1,000 cps. It will be assumed that non-linearity is present in both channels. If the modulation method is used to check intermodulation distortion, with applied frequencies at, say, 100 and 4,000 cps, it is clear that no intermodulation will be observed. In actual operation, however, intermodulation of the frequencies within each channel will be present, and hence, the modulation method gives a misleading result.

On the other hand, the wave analyzer method will give a useful indication so long as the two exploring frequencies are chosen properly, so that these frequencies and the resulting intermodulation components lie in the channel under test.

#### Conclusion

The extent to which a particular intermodulation distortion measurement will reveal the existence of distortion is determined by the frequencies used, their relative amplitudes, the number or order of the intermodulation distortion components which are measured, and the variation in the transfer characteristic with frequency.

In general, the measuring of intermodulation distortion by exploring the spectrum with two signals which are

[Continued on page 55]

Fig. 1 (left). Setup for modulation method of measuring intermodulation distortion, and Fig. 2 (right), same for analyzer method.

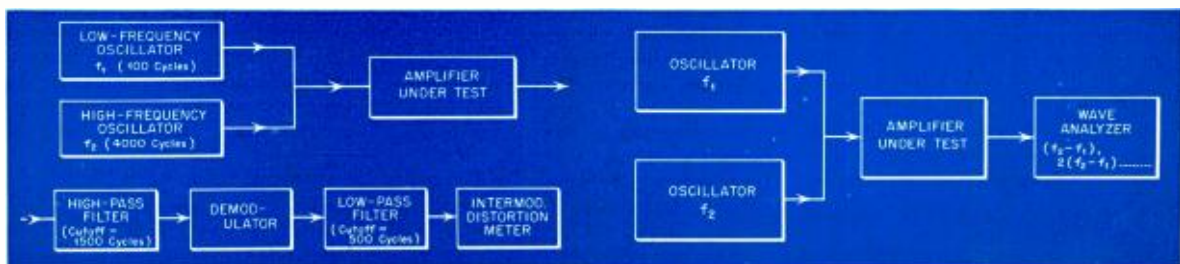



# Simple Method of Determining Internal Resistance

WALTHER RICHTER\*

How to find the internal resistance of an audio amplifier or similar apparatus.

**A**N AMPLIFIER can be considered as a generator, or source of electric power, the output voltage (or current) of which is at any given instant proportional to the value of the signal voltage applied to the input terminals of the amplifier. In the early days of radio and amplifier design, it was generally believed that two amplifiers capable of furnishing the same amount of audio power over the same frequency range, when excited from an audio frequency generator, would produce identical results so far as reproduction of music was concerned. But listening tests showed that although two amplifiers may have identical frequency response curves and identical power output, they may still produce different tonal results, one of them giving muddy reproduction while the other one gives crisp and clear results. The most important reason for this phenomenon is the internal resistance of the amplifier.

## Hangover

When a generator furnishes electric power to a purely resistive load, the internal resistance of the generator—apart from the possible influence on its efficiency—is of no importance. When, for instance, the generator suddenly ceases to produce a voltage, the current in the resistive load will drop suddenly to zero. But when such a source of electric power is operating a loudspeaker, the situation is considerably more complicated. Upon sudden cessation of the current through, or the voltage across, the voice coil of the loudspeaker while the cone is in motion, the cone will not instantly come to rest, but will make a few oscillations which evidently will not represent a reproduction of the input signal to the terminals of the amplifier. This effect is known as the "hangover". Because it is undesirable,

it should be reduced to a minimum. During the time that the loudspeaker cone describes this undesired oscillatory movement, a voltage is generated in the voice coil. Because the latter moves in a strong magnetic field, the voltage will produce a current which, according to Lenz's law, will be in such a direction as to oppose the movement. This current, therefore, represents a force tending to damp out the unwanted movement. The amount of current which will flow due to this voltage generated in the moving voice coil will depend on the resistance of the circuit in which it is flowing. It is evident that the internal resistance of the source is part of the total re-

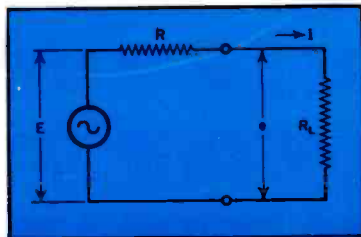

Fig. 1. Equivalent circuit of an amplifier.

sistance, and we can therefore expect that an amplifier with a low internal resistance will give us better damping than an amplifier with high internal resistance. (For oscillograms showing this effect, see: Olson "Elements Of Acoustical Engineering", Second Edition, pages 162-163.)

The loudspeaker is connected to the amplifier through the usual output transformer. The primary of this transformer is connected to the plate resistance of the output tubes reflected into the voice coil circuit in the ratio of the square of the turns-ratio of the output transformer. This is the reason why a straight pentode

amplifier gives results inferior to that of a triode amplifier; the plate resistance of a pentode tube is very high, which causes the voice coil to "look back" into practically an open circuit. A conventional triode circuit generally is designed so that the load resistance is equal to twice the plate resistance of the output tube; consequently, in such a stage the load is "looking back" into a resistance approximately one-half of the load resistance itself. This means that an 8-ohm speaker, operated from an amplifier with triodes in the output stage, and connected to the 8-ohm tap of the output transformer, will "look back" into a resistance of approximately 4 ohms. Compare this with the condition prevailing for a pentode, for which the manufacturer recommends, for instance, a load resistance of 5,000 ohms while the plate resistance is approximately 50,000 ohms. In such a case, the 8-ohm speaker would be "looking back" into a resistance of approximately 80 ohms, instead of 4 ohms!

When negative feedback came to be recognized as a powerful tool of improving amplifier performance, an analysis of it showed that one of its advantages was the apparent reduction of internal resistance of an amplifier employing it. By employing negative feedback, it is quite possible to reduce the internal resistance of an amplifier using pentodes to a value near or even below that shown by triodes. (The author definitely does not wish to enter the presently raging controversy between pentodes versus triodes in the output stage of an amplifier; he does not wish to state that an amplifier with pentodes in the output stage, and employing sufficient feedback to reduce its apparent internal resistance to a value near that of a triode-operated stage, will produce identical tonal results. He wishes only to state that without such feedback, the pentode amplifier will not even have a chance

\*Electronics Section Allis-Chalmers Mfg. Co., Box 512, Milwaukee, Wis.

to give results comparable to that of a triode-operated amplifier.) In few cases does the manufacturer see fit to give the value of the internal impedance of an amplifier, or the amount of feedback employed. Even if the feedback were given, few of us are sufficiently acquainted with the relations between it and the reduction of output impedance so that we could readily calculate the apparent output impedance. It is, however, an easy matter to determine the actual output impedance of a given amplifier by means of a simple measurement, the basis of which is developed in the following:

Referring to Fig. 1, a generator with an internal resistance  $R$  furnishes power to a load with a resistance  $R_1$ . Let  $E$  be the internally produced voltage of the generator, which in the case of a vacuum tube would be  $\mu x$  the let the load  $R_L$  assume two values of resistance, namely  $R_1$  and  $R_2$ . Let the current through, and the voltage across the load, when the load has the value  $R_1$ , be  $i_1$  and  $e_1$  respectively, whereas current and voltage in the case of  $R_L = R_2$  be  $i_2$  and  $e_2$ . Since in both cases the current multiplied by the total resistance in the circuit, i.e.  $(R + R_L)$  must equal  $E$ , we have

(1)  $E = i_1 (R + R_1) = i_2 (R + R_2)$   
From this follows

(2)  $R(i_2 \cdot i_1) = R_1 i_1 \cdot R_2 i_2 = e_1 \cdot e_2$   
which results in

$$(3) R = \frac{e_1 \cdot e_2}{i_2 \cdot i_1} = \frac{e_1 \cdot e_2}{e_2/R_2 \cdot e_1/R_1}$$

The internal resistance of the generator can therefore be obtained by simply dividing the change of voltage occurring when the resistance of the load is changed by the change in current taking place due to this change in load. For the determination of  $R$ , it is therefore only necessary to apply a constant signal of suitable frequency to the input terminals of the amplifier and to observe the two output voltages  $e_1$  and  $e_2$  resulting when the load resistance is made equal to  $R_1$  and  $R_2$ .

The result expressed in equation (3) can be brought into a somewhat different form, as follows: Let us assume that we make the load resistance at first  $R_1$ , and then reduce it to a value  $R_2 = p R_1$ , where  $p$  is a number less than unity. Due to the reduction of load resistance from  $R_1$  to  $p R_1$ , the load-voltage  $e_2$  will be smaller than the voltage  $e_1$ . Let this also be expressed by a "reduction factor" in other words, let  $e_2 = q e_1$ . If  $R_2$  and  $e_2$  are introduced into equation (3), we obtain

$$(4) R = \frac{e_1 (1-q)}{-e_1/R_1 + \frac{q e_1}{p R_1}} = \frac{e_1 (1-q)}{\frac{e_1}{R_1} \times \left(\frac{q}{p} - 1\right)} = R_1 \times \frac{1-q}{q/p - 1}$$

According to this equation, we connect a resistive load  $R_1$ , preferably equal to or a little larger than the rated value, to the amplifier and observe the voltage existing across it, and then reduce the load in the ratio  $p$ . The voltage across the reduced load will also be lower, and the internal resistance  $R$  will then be given by equation 5.

#### Level

The measurements are preferably taken at reduced output, in order to be sure that no overloading takes place. As an example, let it be required to find the internal resistance of an amplifier supposed to furnish 10 watts of power to a speaker with a 20-ohm voice coil. According to the formula  $P = E^2/R$ , a voltage of 14.1 volts across 20 ohms would produce rated output. We replace the speaker with a 20-ohm resistance, and adjust the signal applied to the amplifier, so that the voltage appearing across the 20-ohm load will be well below 14.1 volts, for instance, 5 volts. We now must reduce the load resistance to a new value; this can be accomplished most conveniently by simply placing an additional resistance in parallel to the 20 ohms. If we make this parallel resistance also equal to 20 ohms, the new load resistance  $R_2$  represented by the two 20-ohm resistors in parallel, will

[Continued on page 53]

## Audio Engineering Society, San Francisco Section

Nearly 100 members of the newly formed San Francisco Section, Audio Engineering Society, attended the August meeting when they made a comparison test of twenty types of commercial loudspeakers.





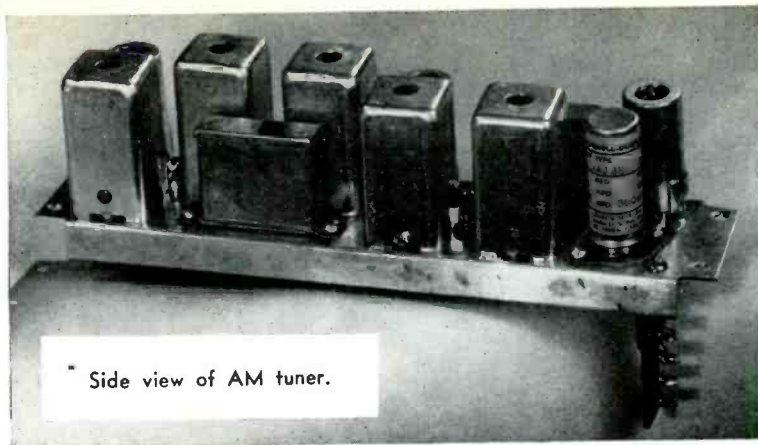

# Elements of RESIDENCE RADIO SYSTEMS

C. G. McPROUD\*

PART II

Continuing the description of units suitable for a high-quality Residence Radio installation.

**A**N ideal AM tuner for a Residence Radio System may naturally take one of many forms, but the quality enthusiast is most certainly likely to insist on a t-r-f tuner to ensure complete listening satisfaction. Wide range t-r-f tuners are complex instruments, and while it is not difficult to design such a tuner, the execution of the design may be somewhat more involved. To be sure, several such tuners are available commercially, either as complete units or in kit form. However, for the system covered by this series, a different arrangement was desired.

The reasons for the development of the fixed-station tuner units to be described are several. Primarily, the particular installation planned by the writer required that four AM stations be accommodated, and that they be selected by push buttons which actuated relays. Additionally, fixed station tuners permit a large residence installation to be made with provision for feeding an audio signal from each desired station throughout a home, with a selector switch and an individual amplifier and speaker at each listening point. This allows a number of listeners to choose their own program fare without disturbing others'

\*Managing Editor, AUDIO ENGINEERING.

choices. A still further application for the fixed tuner is for recording studios which need high-quality receivers for off-the-air recordings. A separate tuner may be set up for each station frequently recorded, with the assurance that the audio signal is optimum for each.

A single station tuner has at least two advantages over a conventional receiver. It may be tuned carefully and accurately, with the band-width set to the best value for the conditions

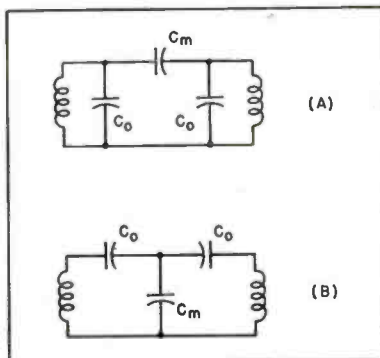

Fig. 1. Two methods of obtaining band-pass coupling by the use of two tuned circuits and an impedance common to both. (A). High-impedance capacitance coupling; (B). Low-impedance capacitance coupling

involved, and it is always ready for instant service simply by switching its output to the recording or audio amplifier. The principal disadvantages are the cost and the space required, but the design shown reduces the cost considerably, and the units are small enough that a six-station assembly can be mounted behind a single 5/4-inch rack panel with ease. For recording studios which must record several programs simultaneously, the strip-tuner arrangement is actually less expensive, since the conventional arrangement would require a complete receiver for each recording channel, which actually duplicates the facilities. For example, ten strip tuners will provide service from ten stations to any number of recording machines at greatly reduced cost over an equal number of conventional receivers which would be necessary to record the ten separate stations simultaneously.

The quality requirements, together with those of simplicity, dictate the use of a t-r-f circuit for the single-station tuner, and an infinite-impedance detector serves adequately for the purpose. Because no more than one station is to be received at any time, no audio stage is included, and

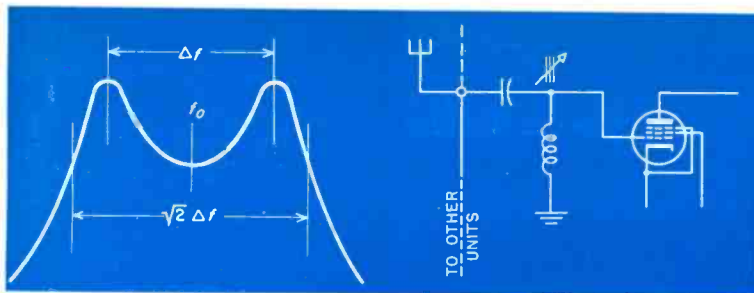

Fig. 2 (left). Curve resulting from over-coupled circuits of Fig. 1. The usable band width is represented by the limits  $\sqrt{2} \Delta f$ . The valley between the peaks can be filled by using a single-tuned circuit in conjunction with the double-tuned circuits. Fig. 3 (right). Method of coupling the antenna to each of the tuner strips. This enables tuning the antenna circuit for each station and provides adequate signal input to the first stage.

the switching from station to station is done by switching the plate supply from unit to unit, as will be described. This method eliminates complicated switching arrangements, and functions perfectly. For good quality, the interstage coupling is band-pass, using low-impedance capacitance coupling. The circuits of Fig. 1 represent two methods of band-pass coupling, using capacitance for the common impedance. The tuned circuits are both adjusted to the frequency of the desired station, and the coupling capacitance  $C_m$  adjusted for optimum—or the maximum usable—band width. Actually, with this form of coupling, a change in the value of  $C_m$  causes the two resonant peaks to move apart, but not equally from the previous single peak. However, they may be set properly during alignment, and no trouble arises from this effect.

The response curve of either circuit of Fig. 1 is shown in Fig. 2, with  $\Delta f$  being the separation between the peaks. The usable band width can be shown to equal  $\sqrt{2} \Delta f$ , and  $\Delta f$  is approximately equal to  $Kf_0$ , where  $K$  is the coefficient of coupling. For the circuit of (A) in Fig. 1,  $K$  is roughly equal to  $C_m/C_0$  when the two inductances have equal values of  $Q$ . Since a 20-kc band width at 1,000 kc gives a  $\Delta f$  of  $20/\sqrt{2}$ , or 14.14 kc,  $K$  becomes  $14.14/1,000$  or .014, and  $C_m$  is a relatively small value of capacitance when practical values of  $L$  and  $C_0$  are used.

For the circuit of (B) in Fig. 1,  $K$  is approximately equal to  $C_0/C_m$ , so  $C_m$  becomes considerably larger, and thus easier to adjust easily. This type of coupling is known as low-impedance capacitance coupling, and is employed in the tuner strips.

Fig. 4. Switching between channels is accomplished by simple switching of plate supply. Since  $R_{10}$  is common to all channels, the a-f output is developed across it for the one channel which is provided with plate supply.

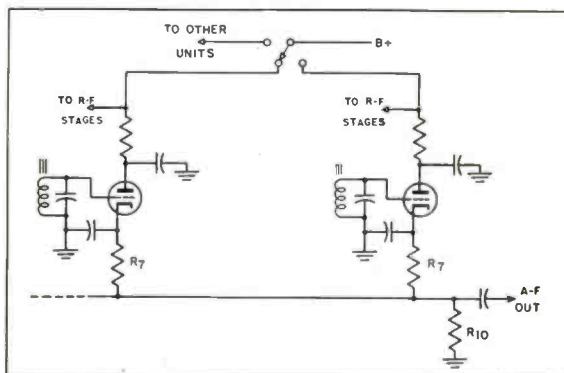

In order to reduce the effect of the valley between the two peaks, a single tuned circuit is employed for the antenna coupling, as shown in Fig. 3. The coils used have adjustable cores, and the tuning capacitances are fixed. Since a number of tuners are to remain connected to the antenna at all times, the coupling to the antenna is such as to load the circuit only at the frequency of operation, rather than throughout the entire band. Thus a

series resonant circuit is used for tuning the input, and the peaks of the over-coupled circuits are flattened out appreciably. The tuning circuits are seen to consist of a peaked series resonant circuit ahead of the first tube, a band-pass circuit between the two r-f stages, and another band-pass circuit between the second r-f stage and the detector.

#### Station Switching

The method used to select the desired channel is quite simple, involving only the switching of the plate supply. This is made possible by using an infinite-impedance detector for each channel, and making a part of the cathode-ground resistance of each detector common to all channels, as shown in Fig. 4. Then, when the plate voltage is switched, the detector in the active channel passes current, with the common portion of the cathode-ground resistor serving to develop the signal voltage. This voltage is then fed to the audio amplifier.

Since the value chosen for the common section is 18,000 ohms, while the remaining section is 82,000 ohms, the shunting effect of the remaining channels is negligible. Holding relays of the type described in Part I are used to switch the plate supply in the four-channel unit being used in the complete system.

The audio output level is fixed with respect to the detector, and since no AVC is used, the gain is adjusted by

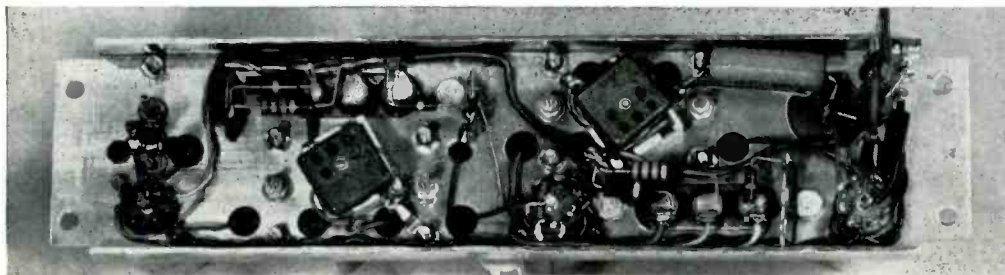

Bottom view  
of  
AM tuner.



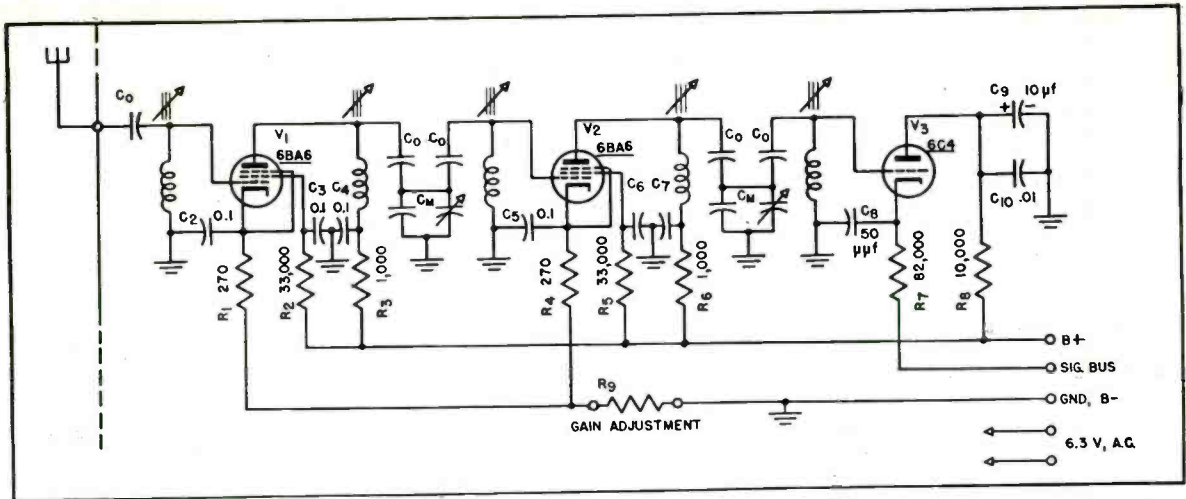

Fig. 5. Over-all schematic for the AM tuner strip. Values for  $C_0$  and  $C_m$  are given in the text, Table I, and Fig. 6.

varying the bias on the r-f stages. Each r-f stage has an isolating minimum bias resistor, with the common section being selected for suitable signal to the detector.

**Construction**

Convenient mounting of a number of strip tuners demands that they be reasonably small, with a  $2\frac{1}{2} \times 10$  in.

**TABLE I**  
Turns of wire to be removed for various ranges

Freq. Range	$C_0$ $\mu\mu\text{f}$	Turns Removed
550-800	50	0
800-1,000	50	40
960-1,175	50	70
1,075-1,300	50	90
1,300-1,550	25	80
1,500-1,700	25	100

chassis being about the minimum for the necessary parts. Five coil shields are required, together with space for three tubes and a filter capacitor for the detector plate supply. The necessary bypass capacitors are in two inverted cans, each containing three 0.1-mf sections.

The complete schematic is shown in Fig. 5. For the r-f coils, CTC<sup>1</sup> permeability-tuned coils type LSM are used. These coils are made in several inductance values, the 1-mc coils being used for this application. Since the inductance variation is not large, turns must be removed from the coils to make them suitable for the ranges in the broadcast band. The number of turns to be removed are shown in Table I for use with a 50- $\mu\mu\text{f}$  capacitor for  $C_0$  from 550 to 1,300 kc, and 25- $\mu\mu\text{f}$  capacitors for  $C_0$  for frequencies above 1,300 kc. The relative small

tuning capacitances provide a high LC ratio, and the gain is fairly constant for all the bands. The approximate values for  $C_m$  for a 20-kc band width are shown on the curves of Fig. 6, and for convenience in adjusting, it is suggested that  $C_m$  be composed of a fixed mica capacitor of suitable value paralleled with a 320-to-1,000  $\mu\mu\text{f}$  mica padder. This will permit a reasonable adjustment of band width.

The coil shields are 1- $\frac{1}{8}$  in. square by 2- $\frac{1}{8}$  in. high, and are sufficiently large to allow for good performance from the coils. The construction is straightforward, and after laying out the chassis, should offer no difficulties. There is no reason why several such tuners should not be built on a single

conventional chassis since only one operates at a given time, and there is no chance of interaction between them.

**Adjustment**

Satisfactory alignment almost demands the use of a frequency modulated oscillator and an oscilloscope if proper adjustment of band width and correct flat-topping of the response curve is to be obtained. The second coupled pair of coils should be aligned first, feeding the signal to the grid of the second r-f stage. After the desired response is obtained, shift the oscillator to the antenna terminal and align the coils between the two r-f stages. For convenience, a potentiometer

[Continued on page 48]

Fig. 6. Curve showing values of  $C_m$  for 20-kc band width with the coils recommended, and the values given for  $C_0$ .

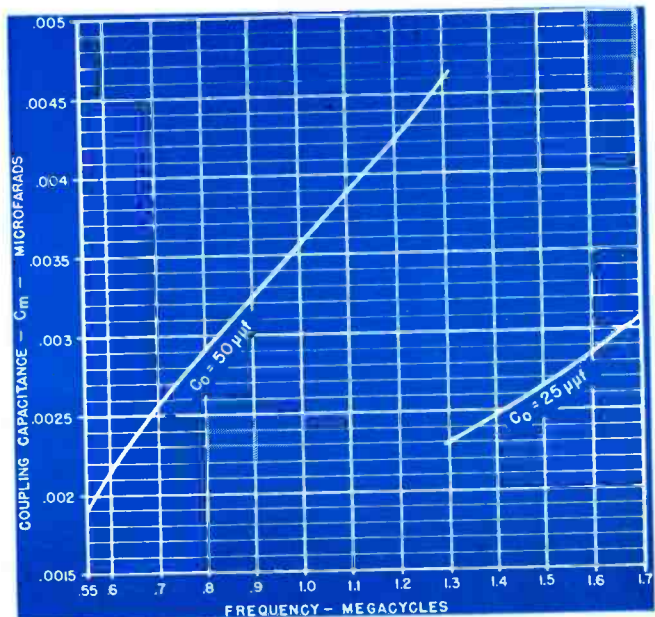

<sup>1</sup>Cambridge Thermionic Corp., 445 Concord Ave., Cambridge 39, Mass.



Author with complete cabinet.

# High Quality Speaker Enclosure

HERBERT G. EIDSON, JR.\*

Constructional data for an excellent speaker cabinet.

**T**HE following speaker cabinet was conceived after several commercial types and one home-made one were found lacking in naturalness of speech reproduction and low-frequency response of musical reproductions after several months of listening tests. In the writer's opinion, a cabinet which encloses an excellent speaker should serve one main purpose: To allow the speaker to operate as though it were mounted in an infinite baffle. In this way, the full true quality of the speaker may be realized, with no restrictive dampening of the rear side of the cone

\*Chief Engineer, WIS, WIS-FM, Columbia, S. C.

by too small an air chamber, no re-radiation of the sound by the baffle or speaker cabinet, or speaker diaphragm, and no false bass emphasis created by resonant sound chambers.

One company states, in relation to one of their main line 12" speakers<sup>1</sup> "Enclosure required: three cubic feet." The cabinet was designed with this figure in mind, for it is felt there is little to be gained by making the enclosure larger and a bulky appearance would then result.

The outer enclosure is made of one-half inch pine plywood and all sections were purchased already cut to specifications,

<sup>1</sup>Western Electric 728-B

from a local lumber company. The sections follow:

One Front	30x23 inches
One Back	29½x22 inches
One Bottom	22x16 inches
One Top	23x12¼ inches
Two Sides	29½x(16½-12½) ins.

#### Associated Material Needed:

- 1 Speaker baffle (made of ½ inch Celotex, 19x27 inches)
  - 2 Wood Strips 27x1½x¼ inches.
  - 2 Wood Strips 19x1½x¼ inches.
  - 6 Welding rods (brass) 36x3/16 inches.
  - 1 Grill cloth (silver and black) 19x25 inches.
  - 2 Back molding strips 16½ inches.
  - 2 Back molding strips 22¾ inches.
  - 1 Kimsul sound-proofing material. (Enough to cover 13 square feet.)
  - 2 Base boards 11½x3½x¾ inches.
  - 2 Base boards 19x3½x¾ inches.
  - 15' Wood stripping one inch square.
  - 6 Sheets #1 flint paper.
  - 6 Sheets #180-C carborundum waterproof paper.
  - 1 Box fine steel wool.
  - 2 Two inch paint brushes.
  - 1 Pint turpentine.
  - 1\* Small can wood putty.
  - 1\* ½ pint can paste wood filler, transparent.
  - 1\* Pint enamel paint, medium gray.
  - 1\* ½ pint enamel paint, black.
  - 1\* ½ pint satin finish varnish.
  - 1\* ½ pint clear varnish.
- \* Sherwin-Williams products.

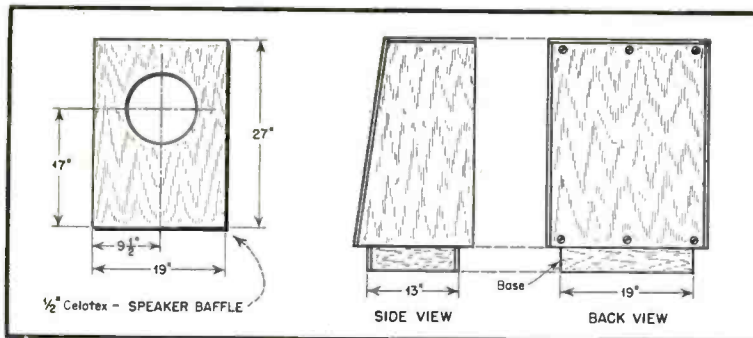

Above: Front, side and back dimensional drawings of speaker cabinet.  
Right: Detail drawings of outer parts of cabinet.

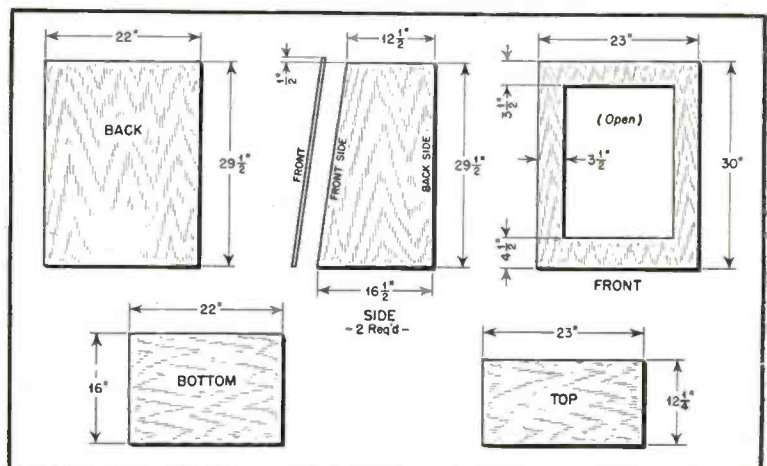



The cost of construction of this speaker cabinet is much less than a good commercial cabinet and it is felt that performance is much better. The local lumber company's bill for lumber and cutting cabinet pieces to size was \$16.00. If the plywood were purchased in one sheet and cut with a hand saw, the price would be about \$8.00. The rest of the material listed cost approximately \$10.00. So it is possible that the cost could be held to \$18.00 or less.

#### Construction

All edges of the different sections are thoroughly sanded down with #1 sandpaper. The front and top pieces are first nailed together, using finishing nails 1 3/4" long. Care should be exercised in fitting the two to form a smooth joint. The two sides are nailed on next, then the bottom. One-inch square reinforcing strips are nailed in the inside top and bottom sections (across back end) for back to fasten to (see photograph of interior of speaker enclosure). Also the same type strips are nailed in the inside of the cabinet at junction of sections for further rigidity.

The four boards that form the base are nailed together and then centered with the bottom of the cabinet and nailed into place.

Using a six-penny nail as a punch, drive all finishing nail heads below the surface of the wood about 1/8 inch. Mix about three tablespoons of wood putty and fill in all holes left by the above operation. Fill in all cracks that may have been left by improper fitting of sections. After twenty-four hours, to allow for drying, sand cabinet thoroughly with #1 sandpaper and finish with fine sandpaper.

#### Preparing For Painting

Stir wood filler so as to mix well and add turpentine if necessary to obtain a consistency of thick cream. Using two-inch brush, apply wood filler over all outside surfaces, brushing across grain at all times. After five minutes, to allow for absorption, rub with large clean cloth across grain, thus removing all excess wood filler. Beware of wood fillers that require no rubbing! They will not give the desired results. Allow filler twenty-four hours to dry. Now, using fine steel wool, go over the outside lightly, leaving a smooth, flat surface.

#### Painting and Finishing

Stir new can of grey enamel well. Thin with 1/5 volume turpentine. This will allow paint to flow more freely. Apply one coat, using long even strokes with the grain of the wood. When cabinet is covered, stroke the edges over, to be certain no paint is running.

Allow one full day for drying. Now sand lightly with fine grade paper, go over surface with moist cloth, let dry and apply second coat of grey enamel. When this is dry, work well with fine steel wool, wipe with moist, clean cloth, let dry and apply coat of satin finish varnish with new, clean brush. This last coat will tone down the lustre produced by the enamel and give the cabinet a finished look.

During the painting and drying cycles of the cabinet, the base should be treated with wood filler as the cabinet has been and given two coats of black enamel, lightly sanding after the first coat. The enamel should be thinned with turpentine in the same manner as the grey enamel.

The four back molding strips should receive the same treatment as the cabinet. It will be noted in the picture that their ends are cut at 45° to insure neat and tight fitting.

If a medium-dark golden oak finish is desired rather than the gray enamel finish, purchase the following:

- 1 Pint Golden Oak Stain  
(Sherwin-Williams)
- 1 Pint clear varnish  
(Sherwin-Williams)

After the cabinet has been sanded (with all nail holes and cracks filled with wood putty), brush wood filler carefully on *only* the exposed edges of plywood and wipe as previously described. After twenty-four hours, brush on golden-oak stain, being careful that stain does not run. After twelve hours, go over lightly with fine steel wool, wipe with moist cloth, allow to dry and apply second coat of stain. When dry, go over again with steel wool and moist cloth, let dry and apply two coats of clear varnish, using steel wool and cloth after each. The final coat is that of satin finish varnish, applied with *new, clean* two-inch brush. The base and back molding is given the same treatment as the cabinet.

#### Final Details

Although the rods which protect the front grill need be only 2 1/4 inches long, the standard length welding rod is 36 inches, so each brass rod will have to be cut to its proper length. The rods are made clean and bright by rubbing with fine steel wool, then dipped into clear varnish so that oxidation will not dull this lustre. Dipping was done in the following manner:

A burned-out, 40-watt fluorescent tube was cut in half by applying nearly one turn of #20 Nichrome wire around its half-way point. Six volts with high current was applied to the iron wire, and after being red-hot for about thirty seconds, this point of the tube was dipped in cold water,

[Continued on page 52]

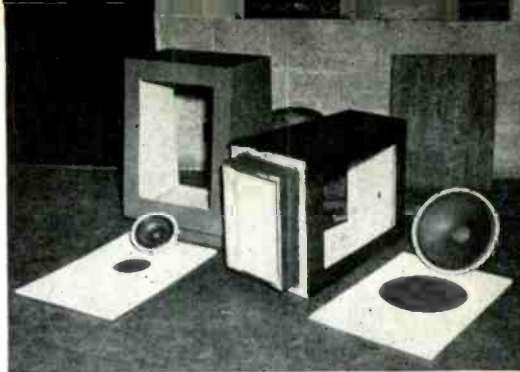

Above: Cabinets with front and rear portions removed. Enclosures for 8 and 12-inch speaker units are shown. For best results, speakers should be especially designed for operation in this type of cabinet.

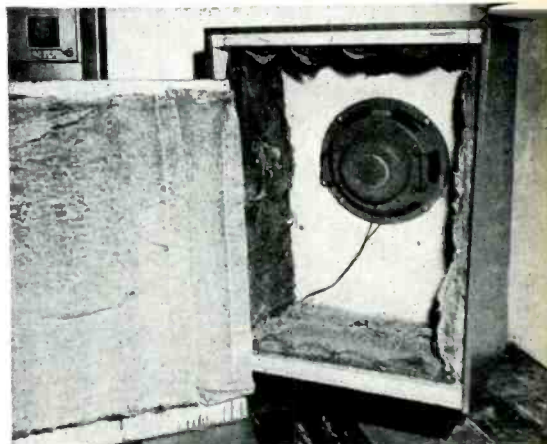

Above: Interior of speaker enclosure, showing 12-inch Western Electric loudspeaker mounted in place.



Above: Painting the speaker enclosure. Details are given in the text. Below: Back molding strips and new Western Electric 755-A 8-inch speaker, designed especially for enclosure of this type.

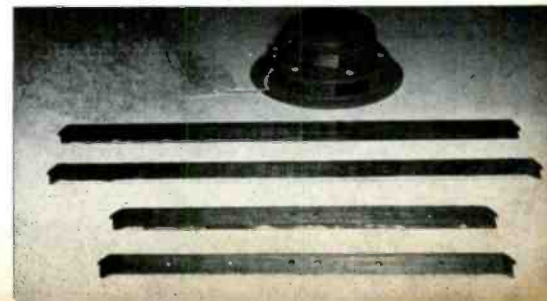

**NEW  
LOW  
PRICES**

*On RCA Top*



**RCA 15-watt  
DE LUXE AMPLIFIER MI-12295**

**NOW  
ONLY  
\$87<sup>50</sup>**

List price  
complete with tubes

• You've never seen a value like this distinctively styled RCA 15-watt All-Purpose Amplifier. You can't beat it for high quality performance, compactness, beauty, and simplicity of operation under all sorts of operating conditions.

Electronically engineered to give top performance. Frequency response (30 to 15,000 cycles). Two high impedance microphone input channels 116 db. gain (RMA), each with individual volume control. Two hi-impedance phono channels, one for hi-level and one for low-level pickups. Can be used with popu-

lar low output magnetic pickups. Phase inversion and inverse feedback used to obtain low distortion and uniform frequency response for various load conditions. Unique balanced tandem tone control circuit. Choke filtered power supply for minimum hum and uniform regulation. Large functionally designed control knobs. Accessible output terminal board and replaceable cartridge type fuse conveniently located in rear. Set of locking-type 3 pin Cannon plugs and receptacles for each microphone input. Also available with 2 low impedance inputs (250 ohms).

15 watt push-pull Output—  
Noise-free electronic mixing—  
Switch for high-low power  
output requirements— Under-  
writers-approved.

Additional Unparalleled  
Amplifier Values

RCA 50-watt De Luxe Hi-Impedance Amplifier MI-12293 \$197<sup>50</sup>  
Complete with RCA Tubes. . . . . Now only

RCA 30-watt De Luxe Hi-Impedance Amplifier MI-12296 \$115<sup>00</sup>  
Complete with RCA Tubes. . . . . Now only



**SOUND PRODUCTS  
RADIO CORPORATION of AMERICA  
ENGINEERING PRODUCTS DEPARTMENT, CAMDEN, N.J.**

In Canada: RCA VICTOR Company Limited, Montreal



# Quality Sound Equipment

## COMPARE...BE CONVINCED!

**More business for you because it's RCA...  
More profit because of these new values**

### RCA SPEAKER

MI-12422



12-inch high efficiency, Alnico V, Cone Type Mechanism. Special cone provides a selected listening characteristic—a result of thousands of listeners' reactions over the past 10 years. 10-watt capacity. 15 ohm voice coil.

**\$12<sup>50</sup>**

Also available with matched 10-watt multi-tap line transformer as MI-12421.

**\$18<sup>00</sup>**

### RCA MOLDED SPEAKER Baffles



Molded Plasticized Fibre Baffle with attractive gray hammeroid finish and contrasting grille cloth, 12" x 15" x 5½", sloping front, strong, moisture-resistant, and non-warping. Available for 5", 6½" and 8" mechanisms as MI-6378, MI-6379, and MI-6380, respectively.

**\$3<sup>75</sup>**

Similar baffles for 5", 6½", 8", 10" and 12" mechanisms also available in molded Bakelite and wood.

All prices shown are suggested list prices subject to normal dealer discounts.

### RCA VARACOUSTIC MICROPHONE

MI-6204-C



Three microphones in one. Here you have the popular cardioid microphone (unidirectional) *plus* standard velocity microphone (bi-directional) *plus* standard pressure microphone (non-directional) all in one general purpose unit. Variable characteristic obtained by ingenious slider mechanism on rear of housing. Quality and performance found heretofore only in more expensive polydirectional Broadcast Microphones. High sensitivity, shock mounted, high impedance. 30 feet of cable.

**\$67<sup>50</sup>**

Make the RCA  
Sound Products Distributor  
in your area your  
SOUND HEADQUARTERS.

### NEW BANTAM VELOCITY MICROPHONE

MI-12080-B

Smaller than a pack of cigarettes. First used at all 1948 political conventions. Broadcast quality. Built-in voice-music switch. 15 feet of cable.



**\$60<sup>00</sup>**

**MAIL THIS COUPON FOR FREE CATALOG**



**BUY  
THE BEST  
FOR LESS**

84 pages of sound products—microphones, amplifiers, speakers, recorders, intercoms, portable P.A. and numerous other profitable items. Send for your FREE copy today.

RCA SOUND PRODUCTS (Dept. 7-J)  
Radio Corporation of America  
Camden, N. J.

Please send me free copy of RCA's new Catalog on complete line of matched sound products and price list.

Name \_\_\_\_\_

Company \_\_\_\_\_

Type of Business \_\_\_\_\_

Address \_\_\_\_\_

City \_\_\_\_\_ State \_\_\_\_\_

# The Problem of Sound Distribution

O. L. ANGEVINE, JR.,\* and R. S. ANDERSON\*\*

## PART III

Valuable data on planning sound installations.

**I**N the two previous articles, general data were presented for planning a sound system. This article will give examples showing the use of such data in specific problems, and those presented illustrate some of the common types that occur. References will be made to figures in the other two articles.

A logical sequence in planning a sound system without retracing steps is:

1. Determine what the system is supposed to do.
2. Select the speakers.
3. Compute the electrical requirements.
4. Determine the location of the speakers.
5. Decide what, if any, frequency shaping is needed.

Minor adjustments in speaker placement and level can be made after the installation has been completed. Some provision for reserve power should be made to take care of these adjustments, and doubling the power provides a 3 db margin for this purpose.

### Small Rooms

Music is distributed to large numbers of small rooms in such buildings as schools, hotels and hospitals. The average classroom is about 24 feet wide by 30 feet long by 12 feet high and will seat 36 to 40 pupils. The volume of this room is 8640 cubic feet. As was pointed out before, a peak sound-pressure level of + 80† db is required for adequate coverage of speech, and + 95 db† for reproducing a small orchestra. If 2%-efficient cone-type loudspeakers are used, *Fig. 1* shows that these levels would require .1 watt and 3 watts, respectively, of electrical power capacity. Since the sound level must be kept low enough so as not to disturb adjoining rooms, the commonly used figure for classrooms is 1/2 watt, which produces a level of 87 db. Although this level is 8 db below the optimum level required for even a small orchestra, it is quite satisfactory, especially since the high

reverberation usually found in classrooms would be more objectionable at higher levels.

A similar example is the hotel room where the usual power is 0.1 watt, corresponding to a sound-pressure level of 86 db in a room of 1600 cubic feet (see *Fig. 1*). Here again it is necessary to keep the levels low enough so as not to disturb neighboring rooms. A like situation occurs in a hospital room.

The home radio receiver, another example of a sound system in a small room, ranges from approximately 1/2 watt for the small table models which are used for reproducing speech and music at low levels. *Figure 1* gives a

power of 10 watts to produce a level of 105 db (symphonic orchestra) in a living room 12 feet by 20 feet by 8 feet—this level may be reduced by adjacent apartment dwellers pounding on the wall.

In the examples given, a single cone-type loudspeaker is normally used and is located where convenient. Usually it is mounted at the front of the room, high enough from the floor so that high frequencies are not obstructed by furniture or people.

While the reverberation time of a small room may be above optimum, it is not generally so bad that shaping of the system frequency response is required. Likewise, rooms of this type are quiet and so do not require variations of frequency response to override noise.

### Large Rooms

Music distribution in a large room will be illustrated by examples in an industrial plant which presents a wide range of noise and acoustical conditions. The same approach can be used for sound systems in stores, restaurants, and for many applications of wired music.

Assume an office 50 by 100 by 12 ft.

Volume = 60,000 cu. ft.

Average noise level = 70 db.

Entire office to be covered with "music-while-you-work."

Reverberation: Somewhat higher than optimum, as the floor, walls and ceilings are hard and the furniture is made of wood.

A number of cone-type loudspeakers will be distributed throughout the room to produce a uniform sound level. Since the music is background music only, the level will be chosen as 10 db above the noise. While in actual use the people listening to the program may desire a somewhat lower level, the 10-db figure given provides enough margin for any case. Music selected for this type of service generally has a restricted dynamic range without either extremely low passages which cannot be heard, or extremely loud passages which will require more power.

From *Fig. 1*, an 80 db level in a

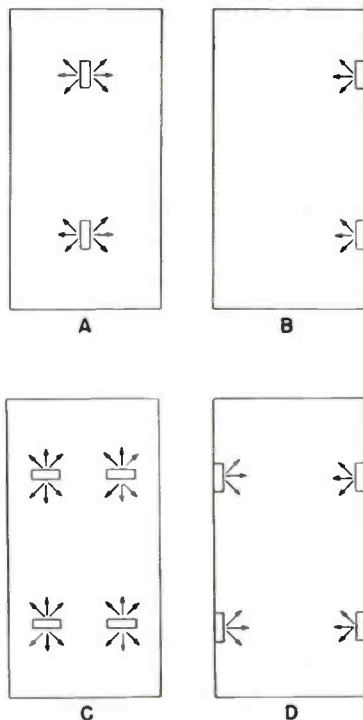

**Fig. 11.** Four possible speaker placements in an office 50 x 190 feet. A & C—cone speakers in two-way baffles. B & D—cone speakers in wall mounting baffles.

\*Chief Sound Equipment Engineer, Stromberg-Carlson Co.

\*\*Acoustical Engineer, Stromberg-Carlson Co., Rochester, N. Y.

†Error in Part I of this article makes these levels read minus instead of plus.



room of 60,000 cubic feet requires an electrical power of 0.35 watts. This power may be divided between two speakers as shown in Fig. 11, A and B. A solution providing more even distribution is the use of four speakers shown in C and D of the same figure. If open-back housings are used, very nearly the same amount of sound will be radiated in both directions, so they may be considered two-way baffles, as illustrated in A and C of Fig. 11. Although the small open-back housing has a low-frequency response usually considered adequate for this application, an extended low-frequency response requires a larger open-back baffle than the equivalent closed-back housing.<sup>17</sup>

The speaker location will determine the amount of wire required for connection, and some layouts are more economical of wire than others. In Fig. 11, C will use less wire than D. The only frequency shaping required for this type of installation is compensation of high-frequency line losses if wired music is used.

The same solution will suffice for speech. The 80-db level used, is the recommended level for speech, and the frequency response and speakers satisfactory for music are certainly adequate for speech.

For an example of music distribution with a high background noise, assume the same size room full of textile looms producing a noise level of 104 db. This is an example of the case discussed earlier where a program level 10 db higher than the noise level approaches the threshold of pain. Since the noise is continuous and the people exposed to it have become conditioned to it, it is not necessary or desirable to provide a level of more than 102 db. This example has been taken from an actual installation.

Horn speaker having a cut-off of 250 cycles will be selected for this application as the high noise level precludes any advantage that may obtain if lower frequencies are radiated. Note, however, that the low-frequency output of the amplifiers should be reduced so that the speakers will not be driven below their cut-off frequency. Figure 3 shows that an electrical power of 6 watts is required to produce a program level of 102 db.

Because the program is being reproduced at a level somewhat below the noise, at least four speakers will be necessary to keep the sound distribution uniform, arranged as shown in Fig. 12, A or B. Again this approach applies equally well with speech, except that a slightly higher level should

be provided in the aisles, so that strangers who have not been conditioned to the high noise level can be paged. Although the over-all system response

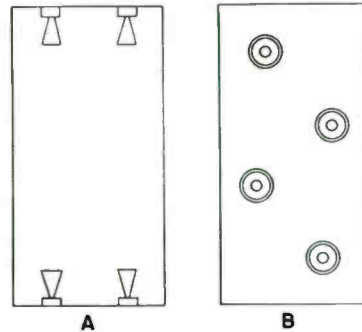

Fig. 12. Two possible horn locations in a factory building 50 x 100 feet. A—straight reentrant horn-type speaker. B—360° radial re-entrant horn-type speaker.

should rise 3 to 6 db per octave for good speech articulation, speakers of the type chosen generally have an adequate rising characteristic.

#### Large Rooms with Bad Acoustics

In large rooms with hard walls and high ceilings such as railroad stations, gymnasiums, and sports arenas, the reverberation time is extremely long and distinct echo is usually found. In rooms of this sort acoustic treatment can be very helpful, and if installed at the time of construction of the building the cost is not necessarily expensive. In addition to simplifying the sound system installation, acoustic treatment will reduce the noise to a more comfortable level.

In such rooms, the usual use of the sound system is for paging and announcing, with an occasional need for music. The people paged are more likely to be passing through the room than regular occupants. Frequently word articulation is very important—in a railroad station the garbling of a few words can mean a long wait for the next train.

There are two approaches to these rooms, and the type of speaker selected is dependent upon which is used. One approach is the use of a large number of cone-type speakers operating at low levels and located near the listeners, permissible where the architecture allows permanent mountings for the speakers. This method is so similar to the previous problem that it will not be carried out in the example. The second approach is to use a single cluster of horn speakers, or horn and cone speakers combined if music is to be reproduced.

The example chosen is a sports arena 300 by 200 by 50 feet.

Volume = 3,000,000 cu. ft.

Average Noise Level = 80 to 90 db—if the crowd is enthusiastic, the noise level may be considerably higher.

Entire arena to be covered with speech and incidental music.

To override the noise, the program level must be 10 db higher or 100 db. From Fig. 3, 75 watts is required for the horn speakers and from Fig. 2, 250 watts for the cone speakers. Horns will be chosen that have a low frequency cut-off at 200 cycles so that the horns may be used alone for the reproduction of speech. When the cone speakers are used in addition to the horns, a level 3 db higher than that stated in the problem will exist in that portion of the frequency range where both types of speakers are radiating. To reproduce symphonic music at the recommended level of 105 db, additional power must be used, but this is inadvisable in a room so excessively reverberant and is not usually attempted. If it must be done, acoustic treatment of the room is imperative.

Figure 13 shows a cluster of cone and horn speakers to provide proper distribution of sound in a sports arena. The horn speakers are 40° by 80° cellular horns and have been aimed to provide an overlap of the radiation patterns in the direction of greatest "throw." Emphasis has been placed on beaming the highs to all parts of

TABLE I

	Square of Path Length (feet)	Multiplied by No. of Speakers	Power per Speaker (watts)	Total Power (watts)
2 End Speakers	120 <sup>2</sup> = 14400	28800	14400 x 75 = 18 61700	36
4 Side Speakers	80 <sup>2</sup> = 6400	25600	6400 x 75 = 8 61700	32
4 Floor Speakers	40 <sup>2</sup> = 1600	6400	1600 x 75 = 2 61700	8
1 Center Floor Speaker	30 <sup>2</sup> = 900	900	900 x 75 = 1 61700	1
Sum of Squares of all Path Lengths =		61700		77

the arena to keep the articulation high at every seat in the auditorium. As the high frequencies play a major part in maintaining good articulation, any seats that are slighted will be poor seats for a listener even though the loudness level may be adequate. When the articulation is poor due to lack of high frequencies, the natural reaction is to desire more level, although raising the level may only increase the reverberation and further decrease the articulation. What is really needed in this case is an increase in the high frequency response at those seats.

Even distribution of the sound to all parts of the arena will require that various amounts of power be fed to the horn speakers, depending upon the length of "throw" that each speaker has to make. The power required for

each speaker is proportional to the square of the length of the sound path. Thus the proportion of the total horn speaker power required for each speaker in this example is computed in *Table I*.

The square of the path length of a particular speaker divided by the sum of the squares of the path lengths of all of the speakers is the proportion of the total power that should be allotted to that speaker. Therefore, this proportion multiplied by the total power will give the power required for that speaker.

The computed values may need some adjustment after the installation has been completed. Likewise the balance adjustment of cone speakers to horn speakers must finally be made by ear, therefore it is necessary that suffi-

cient flexibility be provided so that this adjustment can be made after the system is installed.

Since the cone speakers are non-directional at the low frequencies they are to reproduce, it is necessary only that they be aimed outward from the cluster at the center of the arena.

*Figure 14* shows the portion of the frequency response contributed by the cone speakers. This figure also shows that the low-frequency response must be reduced to match the apparent increase in loudness due to greater reverberation at low frequencies. Although this correction has made the system response flat over the frequency range, it has not changed the shape of the reverberation curve, and as the room is excessively reverberant at the mid frequencies, it will be much worse at the low frequencies. If the low frequency response is not still further attenuated, this reverberation will manifest itself as long rolling echoes. The range of the bass control must be adequate to allow adjustment for the changes in reverberation time as the audience size varies.

**Fig. 13.** Sports arena: Horn speaker array using 40° vertical, 80° horizontal cellular projectors. A—Overlap of directional pattern used to obtain coverage along axis of greatest throw. B & C—Speaker directed downward may be switched off to permit use of a microphone in the center of the floor with minimum feedback. Overlap in B is accidental and not serious.

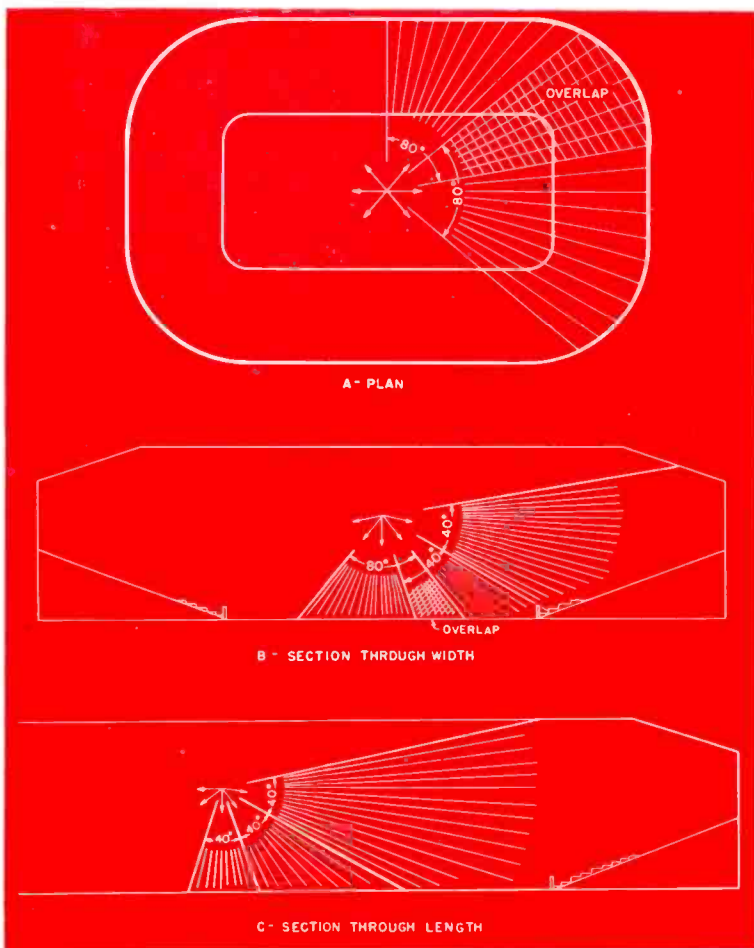

#### Auditoriums—Indoor

In auditoriums the usual application of sound equipment is voice and music reinforcement, and buildings that have been designed for the presentation of speeches, stage plays, and concerts usually have fairly good acoustics. The example which follows is an auditorium which has a volume of 500,000 cu. ft. and is irregularly shaped in accordance with the best design principles for good acoustics and visibility.

It is desired to reinforce voice and solo instruments of a symphony orchestra and to maintain the impression that all sound is coming from the stage. If this objective is attained, the audience will be unaware of the reinforcing system. Too often the sound system is required to produce an artificial effect in order to satisfy the performers and management that the system is working.

For reinforcement of solo instruments, a sound pressure level of 95 db is recommended. Since this is not background music but is the reason for the audience being present, and since the program is originating in the presence of the audience, a high-quality sound system is necessary to reproduce the full range of the reinforced sound. Therefore, theater-type two-speaker systems will be employed. As these speakers have an efficiency of approximately 5%, from *Fig. 2*, an electrical power of 20 watts will produce a sound pressure level of 95 db. If voice reinforcement only is the purpose, *Fig. 2* shows that



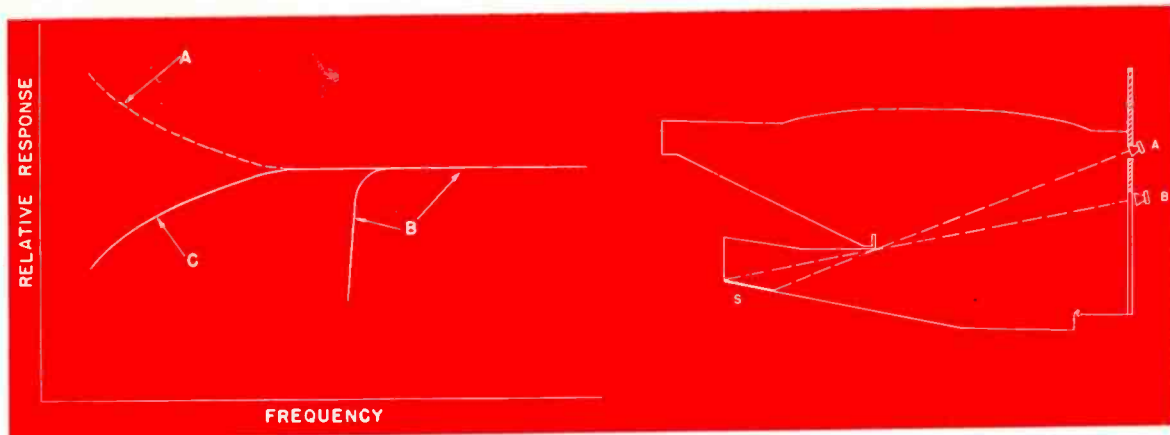

Fig. 14 (left). System response in highly reverberant room. A—Apparent frequency response using a flat sound system. Enhancement of bass is due to increasing reverberation time at low frequencies. B—Contribution of horn speakers. C—Contribution of cone speakers attenuated to compensate for effects of reverberation. Fig. 15 (right). Elimination of acoustic shadow in indoor auditorium. A—Location of speaker at A throws shadow at S. B—Location of speaker at B eliminates shadow.

the same speakers would need less than one watt to produce a sound pressure level of 80 db. On the other hand, if remote pickups or recordings of a full orchestra are to be reproduced, 200 watts of electrical power will be necessary for a level of 105 db.

While the exact location of the speakers is not important and is dependent on the architecture, they must be kept near the stage so that the sound coming from them merges with the sound coming from the stage rather than appearing to come from separate sources. The speakers must be kept far enough from the microphones to allow an adequate amplifier gain before acoustic feed-back occurs. Obviously, concealing the speakers will further heighten the illusion that all sound comes from the stage.

As in the previous example of the sports arena, the bass response must be reduced, but because the acoustics of the auditorium are better, much less bass attenuation need be used.

A not uncommon problem in auditoriums is "acoustic shadows." Since the higher audio frequencies essential to good voice articulation and naturalness in music travel in straight lines similarly to light, there may be "shadows" if an obstruction such as a balcony gets in the "beam" of the speakers. Thus, it may be necessary to restore the high frequencies to seats under the balconies. The best and least expensive approach to this problem is to relocate the speakers so that the balcony will not cast a shadow—see Fig. 15. If this cannot be done satisfactorily, several directional, high-frequency speakers may be placed to beam the sound into the shadowed area. This solution may introduce

echoes in the seats that receive sound from both the main and auxiliary speakers if there is a large difference in the length of the sound path from the two sources. Care in placement of the speakers and choice of level will minimize the effect.

The case of voice and music reinforcement can be handled similarly to the above example whether the hall is a smaller auditorium, a church, or a night club. Of course the smaller auditoriums may not warrant the expense of theater-type speakers, and those chosen must be the best compromise between cost and the quality required. There may be more of an acoustic problem in these halls, and a further reduction of the bass response may be needed to keep the reverberation from being too annoying.

As a temporary installation in small halls, a portable sound system can be an entirely adequate method of reinforcing solo instruments and voice, although a permanent system will do a somewhat better job. While the small baffle of the typical portable speaker does not permit radiation of the very low frequencies, this deficiency is offset by the facts that the primary need in such halls is high-frequency reinforcement and that the bass response may need reduction anyway. Unfortunately, most portable systems are horribly misused because of a complete misunderstanding of their application by the people using them. The speakers are often located too close to the microphones because of the short speaker cords supplied, and acoustic feedback results. The operator stops the feedback by turning down the treble control and thus loses the high frequencies so

badly needed. Any sign of feedback encourages the performer in his conviction that the only way to use a microphone is to "cuddle" it, and his confidential whispers to the microphone sound nothing at all like his natural voice. If the user avoids this error, he is likely to put the speakers so far from the microphone that the sound comes from several different directions and the illusion of the single source is lost. Of course, many of these poor installations are the result of a hasty job which is to be only temporary.

#### Outdoor Sound Systems

Single-horn speakers may be employed in many outdoor sound systems such as ship hailing systems, systems for directing fire fighting, and mobile systems mounted on police cars. To determine what can be done with such a system, assume a conventional re-entrant horn having an 80° coverage angle and 150-cycle cut-off. With 25 watts of power available, Fig. 5 shows a 95-db sound pressure level on the axis of the speaker at 80 feet and 80 db at 440 feet for speakers of 30° coverage. To obtain the same levels with the 80° speaker mentioned above, it is necessary to multiply the power required by the square of the ratio of the respective coverage angles:  $25 (80/30)^2 = 177$  watts. In this case, however, the power is given, so to determine the levels produced by an 80° speaker, divide the given power by the squared ratio:  $25/(80/30)^2 = 3.5$  watts. Using this value for power, read from Fig. 5 a sound pressure level of 95 db at 28 feet and 80 db at 160 feet. For speakers with different horizontal and vertical coverages angles, multiply the power first by the (unsquared) ratio, using

[Continued on page 47]

# Experimental Data on Germanium Crystal Amplifiers

S. YOUNG WHITE\*

Further data on the characteristics of amplifying crystals.

**T**HE writer has made an intensive effort to investigate the fundamental characteristics of crystal amplifiers, with the obvious objective of finding those points of similarity with vacuum tube theory that would allow maximum utilization of this well-developed art. It must be confessed that many more dissimilarities were found than had been expected, so that the writer at the moment is in a somewhat confused state of mind, which doubtless will be reflected in this article. After thirty years of daily work with electronic tubes it is difficult to reverse many concepts, and in addition, many characteristics are shown by at least certain crystal spots which are very new, and have no parallel in amplifier work.

After several attempts at a universal set-up for gain and impedance measurements, the circuit of *Fig. 1* was developed and seems to meet the requirements rather well. From the grid we have a low resistance inductance of about 2 henries and 30 ohms. This is to provide a d-c path for the grid current, and if most measurements are made at 1 kc. the impedance is sufficient to be a bridging value.

A convenient source of variable bias on the grid is a ten ohm potentiometer across a No. 6 dry cell, which allows zero to 1 1/2 volts to be applied, and it is desirable to have the d-c resistance of the inductance  $L$  low so that no allowance need be made for the d-c voltage drop in it, as from time to time we shall put up to 15 ma range and a one ampere shunt, for

The audio generator (a Hewlett Packard) has a 500-ohm output and about 30 ohms d-c resistance. It will provide over 30 volts output. In series, we have  $R_2$  which can be a 2500-ohm wire-wound pot, or a decade box of 10 to 1000-ohm steps. A vacuum tube voltmeter is arranged to switch across

the total output of the generator or the drop across the grid circuit. The ratio of these voltages and the value of the setting of  $R_2$  give us the input impedance. It also allows us to put any signal voltage on the grid that the vtvm can measure, so we can measure the impedance at a variety of input signal values. The meter  $M$  is a 10-ma type.

The plate circuit utilizes an oversized output transformer. This is a push-pull to 500-ohm line, 10-watt unit, and has good coupling characteristics. Calibrate it for stepdown ratio, which will run from 6 to one to 2 to one on the various taps. By varying the secondary load  $R_4$  from about 1,000 ohms down to 100 or so, we can load our plate from about 36,000 ohms to 400 ohms, a sufficient range for treated crystals.

The plate milliammeter has a 5 ma range and a one ampere shut, for flashover conditions. Resistance  $R_3$  can be cut in to limit the surge on flashover, if desired, and may have a value of 10,000 ohms or less. Condenser  $C$  is to by-pass this resistor, and may be 2  $\mu$ f or more.

The plate potential is shown as a tapped battery. A tap every 5 or 6 volts is sufficient to run curves. If you use a normal power supply with a potentiometer across it, be sure the system is clear of grounds, as it is used with polarity reversed and the normal practice of grounding the negative may cause difficulty. If such a source is used, by-pass it adequately.

For preliminary investigation we use 1 kc, and no attempt is made to make anything uniform over the spectrum. Our work indicated the transistor itself is flat over the band of 20 to 15,000 kc, so after taking a good look at this characteristic we concentrated on 1 kc.

#### Testing

The output vtvm can be clipped on the high impedance side of the trans-

former for convenience of having higher readings.

Testing procedure is in several steps. Set the grid to plus 0.5 volt. (A side remark might be in order—we never find the optimum gain or overload condition at 1 volt, so far in our work—it always lies between 0.4 and 0.6 volts, and we always seem to end up at 0.5.) It is not necessary to adjust closer than 0.1 volt to the optimum value. We have a supplementary unit we plug in from time to time to check grid performance from plus 22 to minus 22 volts, but it is seldom used. Also we do not use the voltmeter shown, as we calibrate the ten-ohm pot in terms of volts and this is close enough control in most cases. A treated crystal will draw about 4 ma; an untreated one about one ma.

We then increase the plate voltage. At 40 volts, an untreated crystal will draw perhaps 3 to 7 ma; a treated one, 1 to 2 ma. Swing the grid down to zero volts and note effect on plate current. Then reverse grid and plate—that is, take the catwhisker just used for a grid and clip it on the plate supply, and also take the former plate contact and use it for a grid. Again note control.

#### Reciprocity

An effect of great importance has been noted in all our work to date, and we need a new term to describe it. We have two contacts, each of one ma area and separated about 2 mils. They may have identical contact pressures. In many cases their forward currents at one volt will be very close—say 4 ma and 4 1/4 ma respectively. Their back currents may be, at 40 volts, 2 and 2 1/4 ma each. For all practical purposes, they are identical, yet one will control the second, but the second one will not control the first. They lack reciprocity. This is not absolute—one may control the other say 1 ma, but when reversed the control is less than 25% and usually about 10%. Sometimes the control is

\*Consulting Engineer, 52-12 Van Horn St., Elmhurst, L.I., N.Y.



zero in terms of observable variation of a 3 inch meter, and yet reversal gives normal control.

We must emphasize we are using standard IN34 units and have no other source, so our remarks apply only to them.

This lack of reciprocity will be a difficulty in production, as we must have a unit we can plug in the circuit and have the grid on the grid side, and vice-versa. So if we find a nice active spot that is reversed, we must abandon it and find a new one of proper control direction.

#### Negative Grid Control

A point little discussed in the theory of the transistor is the possibility of running the grid negative. In several instances, we have found spots that exhibit decided control with negative grid, so the theory must bear this in mind. We have only found these with the shoulder gap unit, where the face (of N type crystal) is used as the plate, and the side (unpolished) is used as the grid. The phenomenon occurs when the edge of the crystal is irregular. The gap spacing used is .003 inches.

There is large interaction of the two currents, the grid current increasing from perhaps 3 ma at plus 1 volt, to 6 ma when plate current is drawn. Negative bias on the grid reduces both grid and plate currents, and at -10 volts the grid current is zero and the plate 3 ma. The grid current then reverses, the curve being linear up to -15 volts or so. With this negative grid, much higher plate voltages can be used without flashover.

#### Characteristics of Untreated Crystals

These are not of too much interest, as treated crystals are much more promising. We have hundreds of curves of these, and will briefly summarize them.

The plate impedance runs 80,000 to 40,000 ohms, and is, in general, unaffected by grid bias or plate current, being a function of plate voltage only. This is a radical departure from vacuum tube performance, of course.

The d-c control curve of the effect of the grid is this: at low plate currents and voltages the control on an active spot is negligible; at 0.3 ma plate current the control may be 5%, for instance. At 4 ma plate current, control may increase the plate current to 5 1/4 ma, a change of about 25%. The gain goes up roughly in proportion, and the plate impedance comes down. The gain with a 50,000 load may be the disappointing one of say ten in voltage, and since the input im-

pedance is in hundreds of ohms, this is a power loss.

#### Stabilizing by Tapping and Overshooting

One nice thing about all these crystals is that they withstand a very large plate wattage, not only without damage, but usually with both stability gain and increase in amplification. It has become standard practice in our tests to overshoot to 500 ma or so several times and be slow in reducing the voltage—taking a second or so to do so. At the same time, we tap the mounted crystal rather hard several times. A good point will always survive this treatment, so it is recommended as standard practice.

#### Lack of Heating Effect in the Crystal

One phenomenon that we do not like to mention, as it has very peculiar inferences we have not had time to check, is the relative lack of heating up when the crystal is passing say 600 ma at 40 volts or more. This is a current density of about half million amperes per square inch at the catwhisker tip, and rapid incandescence should occur. It does not. On a cubical basis most of the

before we can do this, while the wires we have been using have been rounded to 0.2 mil radius.

Some slight effort has gone into plating spots on the crystal to do away with the rather indefinite catwhisker contact. The small size of the spots makes for considerable difficulty here, and we have not developed a technique suitable for it.

Germanium has many isotopes, and several radioactive ones. There seems to be much room for atomic activity in it. We shall try common forms of radiation and report on the effect.

At the present time we have no idea how rapid the heating is, or how rapid the rise in plate current is when we overshoot. We are acquiring a two beam oscilloscope to study this.

#### Characteristics of Treated Crystals

First effect noted is that the current at plus 1 volt rises from an average of 3 ma for the untreated crystal to above 10 ma, another reason for running at 0.5 volts.

The plate current is about half, being two ma instead of 4 to 7 ma average for the untreated.

Fig. 1. Diagram of set-up for testing amplifying crystals.

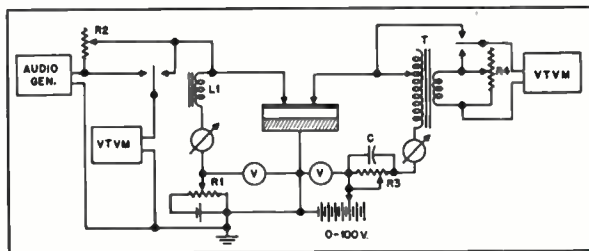

drop is probably at the reduced cross section of the tungsten, and also a very thin layer on the crystal face. Many assemblies have only a cubical volume equal to a tenth watt resistor, and if you put 20 watts in such a tiny resistor, heating is immediate, and the results spectacular. We have no such rapid temperature rise, and the unit is almost impossible to burn out.

It is noted that if we treat such a spot to this enormous power, it returns to its original condition when cooled—that is, it is still operative as a straight amplifier, and draws the same current as before the abusive treatment. So evidently we have not melted the tip, or increased its area substantially.

The G.E. welded crystal passes only 200 ma through the point, melts it with this current, and forms a large teardrop shaped end on the tungsten, which is firmly embedded below the surface of the crystal. It is interesting to note we must form a very sharp point on the wire of only a few millionths radius

The plate impedance comes down from about 50,000 ohms to an average of 9,000 ohms, which we shall call 10,000 ohms for convenience.

The plate current control by the grid follows a different law. The percentage change in plate current is a constant, broadly speaking. At 20 volts plate, for instance, the current may be 300 microamps. 0.5 positive volts on the grid will increase this to 370. At 60 volts, plate, the current may be 3 ma, and the grid at 0.5 volts will increase this to 3.7 ma. In vacuum tube terms, the first gm is 140, the second, 1,400.

The plate impedance in both cases is the same, and again is unaffected by the grid bias. This is most peculiar, but we have checked quite thoroughly.

The gain is about the same for both conditions. This is indeed puzzling.

The grid or input impedance is very largely affected by the plate. Grid impedance by the series resistance

(Continued on page 51)

# Resistor Error in Attenuators

HERBERT I. KEROES\*

How to determine resistance tolerance limits for a required accuracy of attenuation.

**F**IXED and variable attenuators are manufactured to a resistor element tolerance. This tolerance bears no easily discernible relation to the resulting attenuation error, and users of attenuators are usually at a

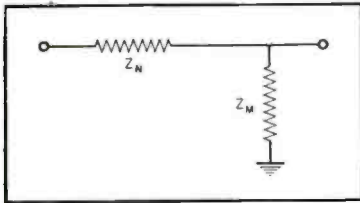

Fig. 1. The L Attenuator Circuit.

disadvantage when it becomes necessary to specify the resistance tolerance of attenuator elements. A simple relation is herewith developed which has been placed in nomograph form to facilitate rapid calculations.

Attenuation networks of the  $\Pi$ , Tee and ladder types are composed of two or more L network sections connected in tandem. The L section is shown diagrammatically in Fig. 1, the series branch shown as  $Z_n$  and the shunt branch as  $Z_m$ . The loss expression<sup>1</sup> is given by the square root of the ratio between the impedances viewed from one terminal to ground when the other terminal is first shorted to ground and then opened. The loss of the L section is one-half that of a full  $\Pi$  Tee section composed of two such sections. Let  $\theta$  be the loss of the L section expressed in nepers.

Then

$$(1a) \quad \tanh \frac{\theta}{2} = \sqrt{\frac{Z_{SC}}{Z_{OC}}} = \sqrt{\frac{Z_m}{Z_m + Z_n}}$$

$$= \frac{e^{-\theta/2} - e^{-\theta/2}}{e^{-\theta/2} + e^{-\theta/2}}$$

$$(1b) \quad \frac{e^\theta - 1}{e^\theta + 1} = \sqrt{\frac{Z_m}{Z_m + Z_n}}$$

This may be solved for  $e^\theta$  which is the ratio between the input and output voltages for the complete Tee or  $\Pi$  network.

$$(2) \quad e^\theta = \frac{\sqrt{1 + Z_m/Z_n} + 1}{\sqrt{1 + Z_m/Z_n} - 1}$$

By taking the natural logarithm of both sides we obtain;

$$(3) \quad \theta = \text{Log} \left[ \frac{\sqrt{1 + Z_m/Z_n} + 1}{\sqrt{1 + Z_m/Z_n} - 1} \right]$$

This may be differentiated as follows;

$$(4) \quad d\theta = \frac{1}{2\sqrt{1 + Z_m/Z_n}} \left[ \frac{1}{\sqrt{1 + Z_m/Z_n} + 1} - \frac{1}{\sqrt{1 + Z_m/Z_n} - 1} \right] d\left(\frac{Z_m}{Z_n}\right)$$

Upon simplifying we obtain;

$$(5) \quad d\theta = -\sqrt{\frac{Z_n}{Z_m + Z_n}} \frac{d(Z_m/Z_n)}{Z_m/Z_n}$$

The quantity under the radical sign

may be identified with that in equation (1b), and by substituting  $N$  for  $e^\theta$ , this becomes;

$$(6) \quad d\theta = -\frac{N-1}{N+1} \frac{d(Z_m/Z_n)}{Z_m/Z_n}$$

For small variations from the nominal attenuation  $d\theta$  may be replaced by the attenuation error  $\Delta\theta$

Then;

$$(7) \quad \Delta\left(\frac{Z_m}{Z_n}\right) = \frac{Z_m}{Z_n} - \frac{mZ_m}{nZ_n} = \frac{Z_m}{Z_n} \left(1 - \frac{m}{n}\right)$$

The quantities  $m$  and  $n$  are the respective percentage accuracies of resistors  $Z_m$  and  $Z_n$ .

[Continued on page 54]

Fig. 2. Chart for determining error in Pi and Tee type attenuators.

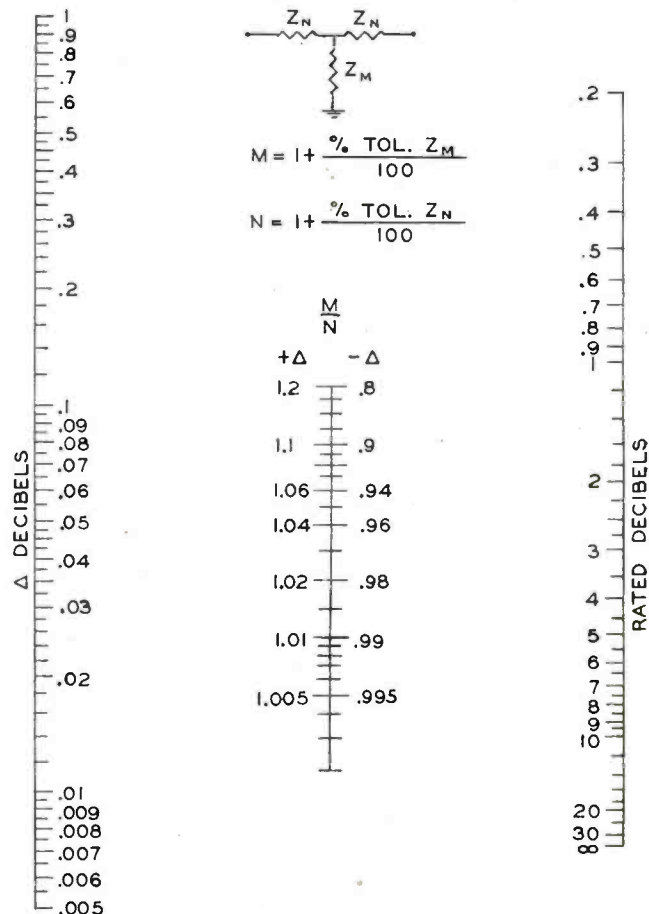

<sup>1</sup>"Electric Circuits and Wave Filters," A. T. Starr, p. 174. Pitman and Sons, N. Y. C.  
\*The Daven Co., 191 Central Ave., Newark, N. J.



ENGINEERED TO THE HIGHEST FM and AM BROADCAST STANDARDS



# NEW High Fidelity Dynamic BROADCAST Microphones



Model 650  
(Output—46 db)



Model 645  
(Output—50 db)

**FEATURES LIKE THESE  
WIN TOP RATING**  
*by Station and Network Engineers!*

*Flat out to 15 kc! Extremely high output! Impedance selector! Dual-type shock-mount! Remarkably rugged! Individually calibrated!*

Developed in cooperation with station and network engineers, the new "650" and "645" meet exacting requirements of modern high fidelity FM and AM broadcast service. Proved in studio and remote use. Polar pattern is non-directional at low frequencies, becoming directional at high frequencies. Recessed switch gives instant selection of 50 or 250 ohms impedance. Exclusive Acoustalloy diaphragm withstands toughest use. Many other important features assure the ultimate in broadcast quality. Satin chromium finish. Fully guaranteed.

Model 650. Output level —46 db. List . . . . . \$150.00  
Model 645. Output level —50 db. List . . . . . \$100.00

*Broadcast Engineers: Put the "650" or "645" to the test in your station. Know the thrill of using the newest and finest. Write for full details.*

**ELECTRO-VOICE, INC. BUCHANAN, MICHIGAN**  
Export: 13 East 40th St., New York 16, U. S. A. Cables: Arlab

NO FINER CHOICE THAN

# Electro-Voice

# DBM-IMPEDANCE CHART

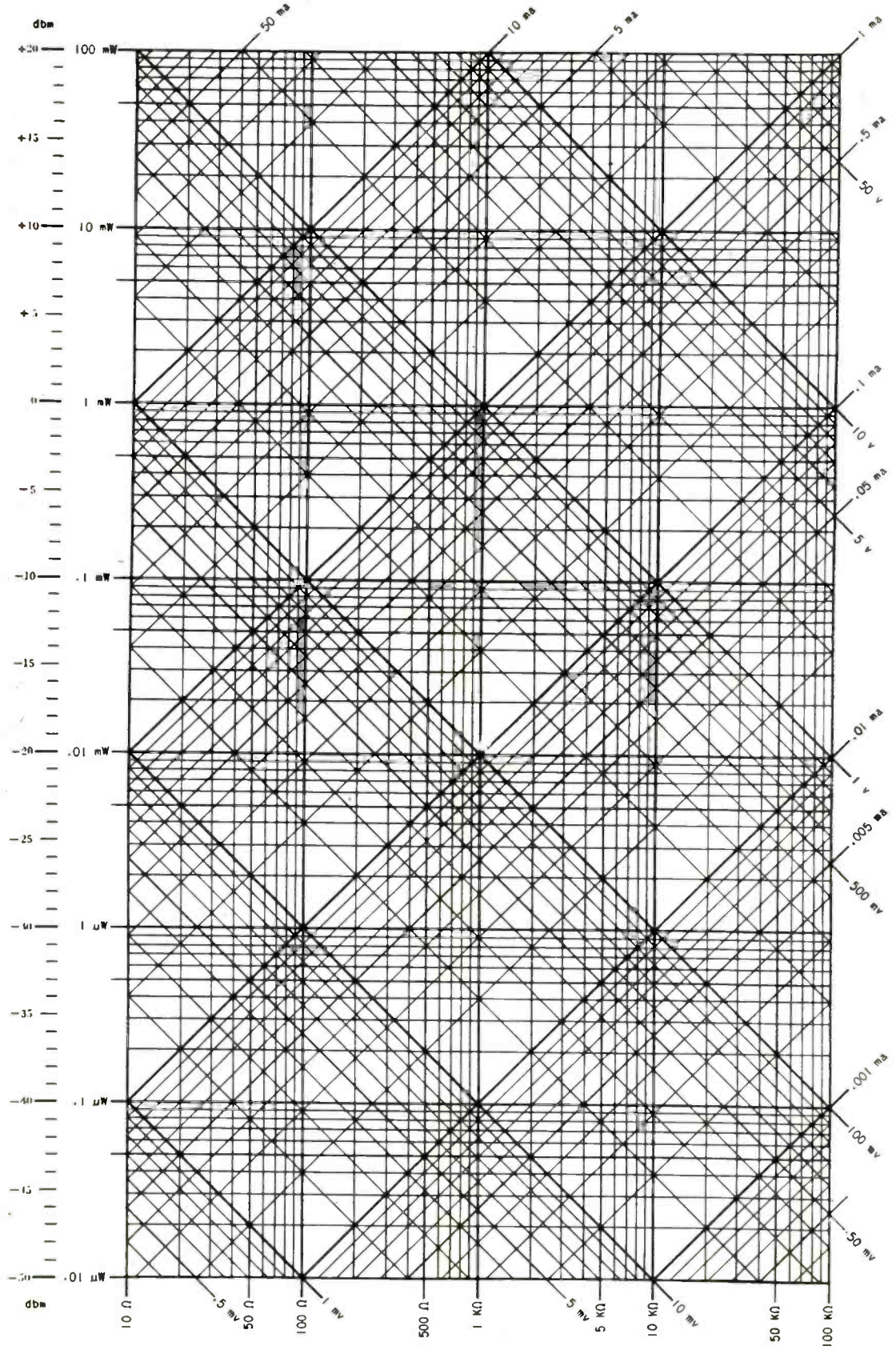

Compiled by Clarkstan Corp.



If Recorders came  
with Mileage Meters...



Presto 6N would be ***MILES AHEAD***

Yes, day after day and year after year over 3,000 Presto 6N recorders are hard at work in broadcasting stations, recording studios, educational institutions and government agencies throughout the world.

6N recorders purchased ten years ago are performing as well today as when they were new. This outstanding record of the 6N recorder in action is proof again that Presto design is built for hard, continuous duty and Presto materials are the finest obtainable.

So when you're looking for a new recorder, remember: By actual test the best recorder for the most people is Old Faithful, the Presto 6N.



RECORDING CORPORATION, Paramus, New Jersey • Mailing Address: P. O. Box 500, Hackensack, N. J.

In Canada: WALTER P. DOWNS, Ltd., Dominion Sq. Bldg., Montreal

*World's largest manufacturer of instantaneous sound recording equipment and discs*

# NEW PRODUCTS

## BRIDGE TYPE A-F METER

Discontinued during the war to permit increased production of more urgently needed instruments, the General Radio Company's bridge-type frequency meter is again available, in answer to requests from many laboratories.



The features of the bridge-type instrument are its wide range (20 to 20,000 cycles) and its high accuracy (0.5%). Precise frequency settings can be made, because of the null method used, and the null detector can be either head telephones or a vacuum-tube voltmeter. The inherent frequency response characteristics of the Wien bridge circuit also permit the instrument to be used as an adjustable-frequency filter.

For further data, write the General Radio Co., 275 Massachusetts Ave., Cambridge 39, Mass.

## L-P VARIABLE RELUCTANCE CARTRIDGE

A new variable reluctance cartridge, designed especially for the new long-playing records, has been announced by the Receiver Division of General Electric's Electronics Department at Electronics Park, Syracuse, N. Y.

The new cartridge, which features a low mass stylus assembly and high compliance for more faithful tracking, is one-third smaller than previous models, according to R. S. Fenton, sales manager for the division's component parts section.

The new, improved shape of the cartridge makes it more universally adaptable to various tone arms. It also affords greater clearance for record changers.

The stylus of the new cartridge is a sapphire, measuring one mil in diameter as required by the new microgroove recordings.

## WALL-MOUNTING ENCLOSURES

Two new wall mounting enclosures, one for 8-inch speakers and the other for 6-inch speakers, have just been announced to the trade by Jensen Manufacturing Company, Chicago, Ill.

Model H-81 Bass Reflex Sector Cabinet fits anywhere—in 90-degree corners, flat on walls, or at intersection of wall and ceiling. They may be mounted singly, in pairs, or in clusters of four around a post, to attain wide-angle distribution of sound. This enclosure is perfectly adapted to nearly all interior sound installations because of its small size and low cost. It may be used with any 8-inch speaker.

This cabinet is formed of wood composition around a frame of hard wood. Finish is of brown opaque lacquer with chrome trim. It can be covered with color to match the locale of the installation. Height, 22-1/2"; width, 17 3/4"; depth, 8-1/2".



H-81

Model J-61 is a Peri-dynamic enclosure designed to house 6-inch speakers. This cabinet is finished in simulated brown leather with grained effect and chrome trim. Height, 16-3/4"; width, 12-3/4"; depth, 6-1/4". Both of these cabinets are furnished with brackets and screws for mounting on wall or post.

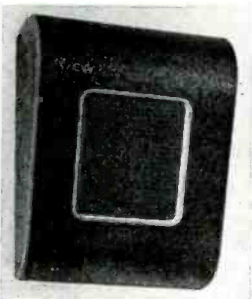

J-61

## E-V BROADCAST MIKES

Two completely new high fidelity, high output dynamic Broadcast Microphones are announced by Electro-Voice, Inc.

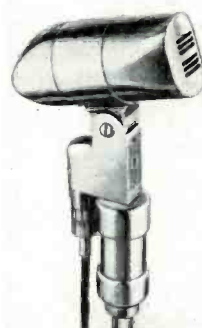

Developed in cooperation with network and station engineers, the new Models 650 and 645 are designed to meet the exacting requirements of modern high fidelity FM and AM broadcast service.

Consistently accurate wide range high fidelity response out to 15 kc, extremely high output level, and rugged shock-resistant construction make them suitable for either studio or remote pick-up. Manufactured to close tolerances, under laboratory quality control, every unit is individually calibrated.

The E-V Models 650 and 645 Broadcast microphones are equipped with a newly developed shock mount. It incorporates dual Lord shear-type mountings which eliminate undesirable vibrations transmitted from the stand, and reduce side sway of the microphone without reducing the efficiency of the isolation unit. The microphone head may be tilted through an angle of 45 degrees, yet it retains its center of gravity with respect to the shock mount and stand.

Impedance Selector Switch recessed in the front of the Microphone stud permits instant selection of either 50 or 250 ohms impedance, balanced to ground. This switch is easily actuated with the tip of a pencil or screw driver. Being recessed, it cannot be moved accidentally.

Built in Cannon XL-3 connector permits tilting of the microphone head without strain on cable or connector. The quick-disconnect cable connector permits separate handling of microphone and cable for remotes.

[Continued on page 40]

## PROFESSIONAL DIRECTORY

### C. J. LEBEL

AUDIO CONSULTANT

370 RIVERSIDE DRIVE  
NEW YORK 25, N. Y.



PRODUCT DESIGN • INSTRUMENTATION  
PSYCHO ACOUSTICS • SOUND RECORDING  
ELECTROMEDICAL • SUBMINIATURE AUDIO

### Custom-Built Equipment

## U. S. Recording Co.

1121 Vermont Ave., Washington 5, D. C.

District 1640

## Winston Wells

Designer and Consultant

Acoustical and Electronic Research

307 East 44th St.

MU 4-3487

New York 17, N. Y.



# DO YOU CUT DISCS OR DOLLARS?



Two years ago Soundcraft introduced the 'Broadcaster', a premium quality instantaneous recording disc. The "super" blank record costs more to make, is worth more to the broadcast engineer.

*Representing but a small portion of the cost of a recorded program or record release, the blank disc is yet the heart of any recording project. No platter can be more expensive than one that loses a program or originates doubtful pressings. Soundcraft knew that key engineers appreciated these facts.*

Soundcraft's judgment in offering the high-reliability 'Broadcasters' (master-selected discs in standard sizes) and the wax-like 'Maestros' (oversize discs for processing) has been vindicated by widespread acceptance on the part of makers of the best off-the-line recordings, transcriptions, and phonograph records.

*For real economy don't cut your disc budget, cut the best disc!*

Clip the coupon today for the story of how Soundcraft discs are made, the list of Soundcraft distributors, and your sample 'Broadcaster'.

*For real economy don't cut your disc budget,  
cut the best disc!*

**REEVES Soundcraft CORP.**  
10 EAST 52nd STREET • NEW YORK 22, N. Y.  
Export Address  
REEVINTER, N. Y.

To: REEVES SOUNDRAFT CORP.  
10 E. 52nd St., N. Y. 22, N. Y.  
Please send story, distributor list, and free  
sample 'Broadcaster' to

Name.....  
Company.....  
Address.....

*The 'Broadcaster' The 'Playback' The 'Audition' The 'Maestro'*

## NEW PRODUCTS

[from page 33]

Polar pattern is non-directional at low frequencies, becoming directional at high frequencies.

For further information, write for Broadcast Bulletin to Electro-Voice, Inc., Buchanan, Mich.

### SWEEP FREQUENCY GENERATOR

• The Clarkstan Corporation, Los Angeles 34, Calif., announces the Clarkstan Sweep Frequency Generator, an electronic device which shows the behavior of audio and other alternating electrical apparatus with respect to frequency and associated phenomena. It is designed to operate in the audio range in conjunction with an oscilloscope. The complex signal is produced by

scanning photo-electrically a synchronously rotating disc, modulated photographically from a precision pattern. The accuracy of the discs assures a positive signal which limits intermodulation distortion, frequency, and other discriminations.

The sweep frequency signal generated is used for instantaneous evaluation in production testing, as a tool in development laboratories, as a simplified teaching method in colleges and universities, for over-all and component checking of radio station and motion pictures sound equipment, as well as magnetic recorders, and for testing and servicing all types of aircraft and broadcast receivers and transmitters.

The specifications of the Sweep Frequency Generator, Model No. 125, are:

OUTPUT—7 volts, open circuit; 50 milliohm impedance—Internal impedance 200 ohms.

POWER CONSUMPTION—25 watts, 115v, 50 and 60 cycles.

Will operate with any standard oscilloscope.

FREQUENCY RANGE—40 cps to 10 kc with 60 cycle AC.

MARKER PULSES at 1, 3, 5, 7, 9 and 10 kc.

SWEEP FREQUENCY governed by 20 synchronizing pulses per second.

### KURMAN RELAY

• A new relay, with a split armature, called the "24", is being manufactured by Kurman Electric Co., Inc., 35-18 37th St., Long Island City 1, N. Y. This New "24" Relay was developed for automatic controls, keying, antenna changeover, burglar alarms, and closed circuit applications.

The following characteristics are incorporated in this relay:

Rated Sensitivity: .014 watts d. c.  
.3 V. A. a. c.

. Adjusts to operate at .005 Watts, and from .01 to 155 Volts d.c. or a.c.

The "24" contains the following general features:

- . Contact flexibility
- . Magnetic circuit
- . U-shaped magnetic circuit of high permeability nickel alloy, especially heat treated
- . Steep curve provides dependable constant operation at low current values

ARMATURE: balanced, solid, or split with insulated sections.

Bakelite or mycalex bases are obtainable.

### MICROGROOVE CARTRIDGE

• Engineers of The Astatic Corporation, Conneaut, Ohio, worked directly with Columbia technical experts in designing their new FL-33 Pickup and LP-33 Crystal Replacement Cartridge, for use with the new,



long playing Microgroove discs produced by Columbia Records, Inc., the pioneer pickup and microphone manufacturers have announced.

As a result, they are being manufactured to meet precisely the specifications set forth by the record manufacturer.

An outstanding feature of the Astatic equipment is that the LP-33 Crystal Cartridge, which has a permanent sapphire needle with .001-inch tip radius for Microgroove recordings, is readily interchangeable with a companion cartridge LP-78 for playing conventional 78 rpm records. The cartridges may be changed in seconds, by anyone, because they fit firmly into position in the pickup on the same slip-in principle by which cap and body of some modern fountain pens are joined together. By merely slipping in either cartridge, you have the proper pickup for 78 or 33-1/3 rpm records and at the same needle pressure of five grams.

## Ingenious New Technical Methods

To Help You Increase Efficiency

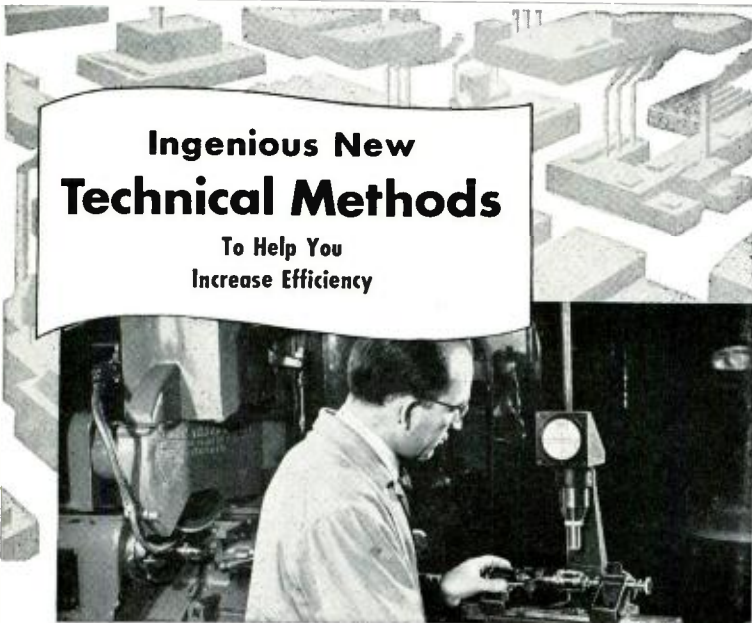

### Light Projector Increases Thread Grinding Production

Production of thread grinding machines can now be increased through the use of a light projecting device called the Thread Pick-up Projector. The thread profile appears in a viewing screen, magnified 20 times, thereby permitting accurate visual adjustments.

In operation the Thread Pick-up Projector is placed alongside the thread grinding machine. A Dalzen Thread Grinder, Model No. 1, is shown above. While the machine is grinding the thread, the operator, using the Light Pick-up Projector, adjusts a "dog" on the next piece to be ground. When the "dog" and piece are then placed in the thread grinder the thread profile is automatically in location and ready for grinding immediately.

Even the most inexperienced personnel can "pick up the thread" using this instrument after only a few minutes demonstration. Grinding is also done more accurately and the viewer permits measurements of reliefs, notches, etc. to .0005 inch.

Efficiency of production can also be increased through the use of chewing gum. The act of chewing helps relieve nervous tension and seems to make the work go easier and faster. For these reasons, Wrigley's Spearmint Chewing Gum is being made available more and more by plant owners everywhere.

Complete details may be obtained from  
Acme Scientific Company  
1457 West Randolph, Chicago 7, Illinois



Thread Pick-up Projector



AC-75



A novel design at the pickup's base is represented as eliminating tone arm resonances and providing assurance of perfect tracking. Output is approximately .5 volt; frequency range, 30 to 10,000 c. p. s.

The FL Filter, an accessory for the pickup that assures best performance with high-quality speakers, is also being produced by Astatic.

**GOODELL AMPLIFIERS**

● The Minnesota Electronics Corporation, 204 Oppenheim Building, St. Paul, Minn., has added three new amplifiers to its line of Goodell Dynamic Noise Suppressor Amplifiers.

Model NSA-2 is a six-tube Dynamic Noise Suppressor with separate range and suppression controls—two complete high-frequency reactance tube filter sections with one low-frequency reactance tube. Response is maintained under dynamic operating conditions to beyond 12,000 cycles per second with effective reduction of objectionable noise amounting to more than 25 decibels!



This amplifier has all the facilities of the larger model and is designed with ample reserve power for most home installations. Separate inputs for radio and phono with front panel switch. Tube socket connection provides power and input facilities for magnetic pickup pre-amplifier.

Model NSA-1 is two chassis construction and 18-watt output. This includes the pre-amplifier using 2-6AT6 tubes as standard equipment. This model includes dual G. E. indicator eye tube for visual observation of gate action. Dynamic Noise Suppressor, tone control sections and pre-amplifier are built on one 15"x3"x7" chassis. Power supply and power amplifier on separate chassis 17"x3"x7". Two-chassis construction minimizes hum and simplifies cabinet installation. All power-supply filter capacitors oil-filled, 600 volt paper types. Push-pull 807 output tubes conservatively rated at 18 watts.

A demand for the Dynamic Noise Suppressor in an amplifier using triode output tubes has led to the development of a special two-chassis model similar to the above in every respect except for the use of a push-pull driver stage consisting of 1-6SN7 driving 4-6B4 output tubes in push-pull parallel, conservatively rated at 18 watts.

For further data, please write the manufacturer.

**RECORDER**

● In the past ten years there have been no improved designs in recorders. The Robinson Recording Laboratories, 2022 Sanson St., Philadelphia, Pa., now intro-

**SPEAKING OF MICROGROOVE RECORDINGS**

**David Hall Says . . .**

"... the results gained from the PICKERING D-140S CARTRIDGE were 100 percent satisfactory, for we were at once relieved of the distortion and tracking troubles which we had encountered..."

The above is a verbatim quotation from an article written by David Hall for the publication "Just Records"

**D**AVID HALL is director of repertoire of Mercury Classics and also author of "The Record Book," the most complete compendium on recordings. He's an outstanding authority—he knows recordings.

You can take the experience of David Hall as fact and apply it to all Microgroove recordings. You'll find that the Pickering D-140S Microgroove Cartridge eliminates distortion and tracking troubles. It plays back exactly what has been finely engraved in the microscopic grooves, insures a good signal-to-noise ratio and has the widest frequency range of commercial reproducers.

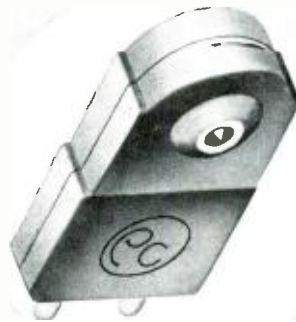

**D-140S SPECIFICATIONS**

- Stylus Radius 0.001"
- Tracking Pressure 5 grams
- Stylus Material Whole Diamonds, not chips
- Mounting Keystone Clip for Interchangeability with Standard Pickering Cartridges
- Finish Satin-Chrome

**DUE TO INCREASED PRODUCTION AND REVISED MANUFACTURING TECHNIQUES PICKERING CARTRIDGES FOR STANDARD RECORDINGS ARE NOW AVAILABLE AT NEW LOW PRICES**

For the highest standard of excellence in record reproduction, the cleanest and smoothest response, perfect tracking, minimum record wear, widest frequency and the lowest distortion, specify Pickering

Cartridges . . . they're available through leading dealers and radio parts jobbers. . . . model S-120M has a .0027" Sapphire stylus and model D-120M has a .0025" Diamond stylus.

**Pickering & Company, Inc.**

Oceanside, New York.

duce an entirely new lathe-type recorder for professional work in radio stations and recording studios.

The use of a perfected belt drive and dynamically balanced components the "wow" factor has been reduced to an unbelievable .01% or one part in 10,000 at both speeds. Individual micrometer adjustments on both 78 and 33 1/3 speeds make exact stroboscopic speeds at all times. Electronic balancing of motor armature; a twenty-pound spring mounted sub-base; with a patented "right angle" belt drive, reduce "rumble" to—65 db below recording level.

The highly precise ground thread feed screw completely eliminates the usual "feed

screw pattern". Five pitches are available with either inside or outside start. These are 88, 96, 112, 120 and 128 lines per inch. Quick feed or spiral is obtained by a large hand wheel. Automatic spiral and automatic cutter pop-up is available on special order. Provision is made for eccentrics and safety groove cutting with the advantage that eccentrics are cut at the same speed and with the same stylus used on the recording.

An accurate diameter scale, built-in mercury switch and convenient lift levers are designed for fast operation. The cutter carriage accommodates any type of cutter. A unique suction tube is mounted under the carriage.

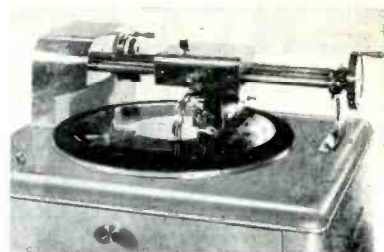

Oilite bearings with tapered shafts throughout provide adjustment for years of wear and eliminate all side play in the turntable. The maintenance required is at a minimum.

The entire machine is built of hand finished aluminum castings and chrome plated. The cabinet of two-tone Duco, provides rack panel space of 15 3/4 inches, with ample storage space below. Rubber wheel casters provide adequate floor isolation.

A feed-back Recording Amplifier, 60 watts, with high and low equalizers is also offered.

For further data, please write the manufacturer.

#### NEW RIBBON MICROPHONE

• The new Studio Ribbon Microphone by Amperite has been designed to meet the most exacting reproduction requirements of Broadcasting Stations, Recording Studios, and Public Address. The frequency range covered is 40 to 14,000 cps; output -56 db; harmonic distortion less than 1%; discrim-



ination with angle—60 to 10,000 cycles, less than 1/10th that of a diaphragm microphone.

Unit is shock-mounted in rubber. The case is unusually rugged and will withstand a great deal of mechanical abuse. Not affected in any way by altitude, moisture, or temperature. Available in 200 ohms output, 50 ohms on special order. Also available in hi-impedance.

When used for public address, the feed back is unusually low due to the fact that the frequency response of the microphone is free from peaks.

For further information, please write: Amperite Co., Inc., 561 Broadway, New York 12, N. Y.

#### LABORATORY MAGNETAPE RECORDER

• Model SP850, a ruggedly constructed, high-fidelity magnetic tape recorder, specifically designed for broadcast, recording studio, and all semi-professional applications, is the latest addition to the Magnetape Recorder



"Professional Junior"  
**COLLAPSIBLE  
DOLLY for TV  
CAMERA WORK**  
Now being used by RCA,  
NBC, CBS & DuMont  
Video Stations.

This Dolly made by specialists in custom-built TV and motion picture equipment.

Sturdily supports TV camera on tripod, also cameraman. It assembles quickly without tools. Collapses into carrying case 1' sq. by 6' long. Ideal for Studio & Location TV work.

Rentals, Sales & Repairs of all types 16mm & 35mm cameras, and editing equipment.

Representatives for Houston Developing Machines; Auricon SS camera & recording equipment; Bardwell & McAlister lighting equipment; Moviola and Micro Engineering editing equipment.



Complete staff of trained technicians available for consultation.



line, manufactured by the Amplifier Corp. of America, New York City.

This completely self-contained unit consists of an efficient tape-pulling mechanism, a recording amplifier with supersonic bias and erase oscillator, a playback amplifier, monitor amplifier and speaker, compactly housed in an enclosed relay rack cabinet, measuring 20½" high x 15" deep x 21" wide.

Additional built-in equipment includes a vacuum tube type VU meter with an adjustable sensitivity range of 18 db for indication of proper recording level on all types of magnetic tape. The meter is also used for measurements of bias and erase voltage amplitudes. An automatic program timer is also included for unattended recording of any desired program or sequence of programs.

Among the outstanding facilities offered are selection of three tape speeds for any desired degree of frequency response. At 4" per second the frequency range is 60 to 5000 cycles, ( $\pm 2$  db) with a full hour's play of standard 1250 foot roll of magnetic tape; at 7½" per second the frequency range is 50 to 9500 cycles, with one-half hour's play; at 15" per second the frequency range is 40 to 12500 cycles, with 15 minutes of play.

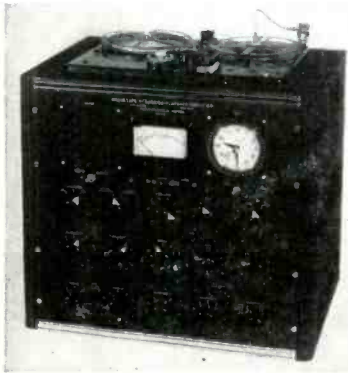

Five input channels accommodate three microphones, one phono pickup or telephone line, and a radio tuner. Individual adjustments are provided for the supersonic frequency bias and erase voltages. The supersonic bias frequency range is adjustable from 30 to 80 kc. Total recording and playback distortion at 400 cycles is under 3%.

The playback amplifier, with less than 1% distortion at rated power output of 15 watts, is equipped with individual high and low frequency controls. Treble equalization ranges from +13 db. to -10 db. at 10,000 cycles. Bass equalization ranges from +10 db. to -10 db. at 100 cycles. Twelve different output terminals, ranging from 2 to 500 ohms, are included.

For additional information regarding this laboratory magnetic tape recorder, including a complete set of technical specifications, write for free catalog # 4904 to Magnetophone Division, Amplifier Corp. of America, 398-4 Broadway, New York 13, N. Y.

#### REMOTE CONTROL AMPLIFIER

● A new remote-control model of the Brook high quality amplifier, designed especially for custom-built radio-phonographs, has recently been introduced by Brook Electronics, Inc., 34 DeHart Place, Elizabeth 2, New Jersey.

(Continued on page 44)

MAKE THE MOST OF THE

NEW SHURE

Monoplex

MODEL  
"737A"  
Available Now!

THE *Only* SUPER-  
CARDIOID CRYSTAL  
MICROPHONE



HIGH  
OUTPUT  
(-53 db)

Here indeed is *the* crystal microphone of all time—a high-output, unidirectional microphone that ranks far, far above ordinary crystal microphones. Why? Because it is a SUPER-CARDIOID microphone. What does this mean? It means that the "Monoplex" is twice as unidirectional as the Cardioid. It has wide angle pickup across the front of the microphone but it reduces sound pickup from the rear by 15 db—over a broad range of frequencies, and reduces pickup of random sound by 73%! The "Monoplex" employs the same type of acoustic phase-shifting network used in the highest-cost Shure Broadcast microphones. New "Metal-Seal" crystal. The case is pivoted at the rear and can be pointed toward desired sound or upwards for horizontal plane pickup. The "Monoplex" is excellent for high-quality public-address, communications, recording and similar applications. It will operate under adverse conditions of background noise and reverberation where a conventional microphone would be practically useless. Make the most of the "Monoplex"—it is destined for a performance record unique in crystal microphone history!

It has wide angle pickup across the front of the microphone but it reduces sound pickup from the rear by 15 db—over a broad range of frequencies, and reduces pickup of random sound by 73%! The "Monoplex" employs the same type of acoustic phase-shifting network used in the highest-cost Shure Broadcast microphones. New "Metal-Seal" crystal. The case is pivoted at the rear and can be pointed toward desired sound or upwards for horizontal plane pickup. The "Monoplex" is excellent for high-quality public-address, communications, recording and similar applications. It will operate under adverse conditions of background noise and reverberation where a conventional microphone would be practically useless. Make the most of the "Monoplex"—it is destined for a performance record unique in crystal microphone history!

Manufactured under Shure patents issued and pending.  
Licensed under patents of Brush Development Co.

SHURE

Model "737A" CODE: RUMON List Price: \$35.50

SHURE BROTHERS, INC.

Microphones & Acoustic Devices

225 W. HURON ST., CHICAGO 10, ILL. • CABLE ADDRESS: SHUREMICRO

Now you can have

## \* DYNAMIC NOISE SUPPRESSION

with Your Present Radio-phonograph or Amplifier

These 3 simple steps add realism to your music reproduction.

1. Plug in the "Little Wonder" \*Dynamic Noise Suppressor between your pick-up and amplifier.
2. Plug in the socket adapter to the power-tube socket.
3. Insert the matched low-needle-talk pick-up in your pick-up arm.

That's all that is necessary to reduce background noise with negligible loss of depth and brilliance . . . giving you a gratifying sense of "presence" in your music reproduction.

**LOW PRICE . . . . . \$82.50 list**

Includes tubes, matched pick-up, remote control, cables, fittings, adapters, instructions.

\*Licensed under U.S. and foreign patents pending and issued.



The remote control, for setting the exact degree of suppression you find most pleasing, can be mounted wherever you wish . . . at the instrument or even in another part of the room. The 3-tube suppressor unit can be placed anywhere in the cabinet.

The "Little Wonder" realizes the full capabilities of your present equipment; can be used, with suitable pick-up, on the new, long-playing records, too. For full specifications, write Dept. A. Or, even better, hear a demonstration at your distributor's.

**HERMON HOSMER SCOTT, INC.**  
 "PACKAGED ENGINEERING"  
 385 PUTNAM AVE. • CAMBRIDGE 39, MASS.

**Manufacturer makes big SAVINGS on NUTS!**

"WE HAVE LOPPED a big slice from our annual outlay for nuts," reports large appliance manufacturer . . . "By using Westfield Nuts and concentrating on fewer types and sizes. Production was speeded on assembly lines." Westfield Nuts are uniform and accurate. Standard or Custom Made, they're milled to exact specifications . . . Send drawings and data for recommendations and prices. Or have a Westfield engineer study your full requirements and suggest improvements and savings that really count. Address Department 02

**WESTFIELD METAL PRODUCTS CO. INC.**  
 WESTFIELD, MASS.

Designated Model 10C3, the new amplifier is built primarily for use in the home by music lovers and serious high-quality-audio enthusiasts; however, its audio characteristics are such that it is equally well-suited for application where highest engineering standards prevail. In designing the new model, attractiveness and flexibility were given equal consideration with electrical performance.

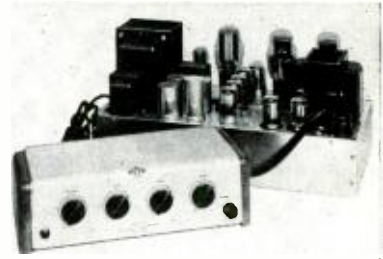

The unit follows the Brook-established practice of using low- $\mu$  triodes throughout. Frequency response is flat within 0.2 db from 20 to 20,000 cycles.

Full technical specifications and descriptive material will be supplied free by the manufacturer.

### MIDGET ATTENUATORS

• The Daven Company, of 191 Central Avenue, Newark 4, N.J., announces the addition of a new line of attenuators featuring decreased dimensions. These controls of reduced size were designed for use in high quality equipment where mounting space is limited and precision construction required. The same mechanical and electrical construction offered in the larger Daven attenuators are supplied in the new type units.

The manufacturer will gladly provide further information upon request.

### MICROPHONE BOOM STAND

• The new microphone boom stand pictured below, specially designed by RCA, permits instantaneous one-hand movement of a studio microphone over an arc up to 13 feet in radius and as high as 21 feet above the floor. The stand is adjustable in height from six to nine feet, and the boom when closed has a radius of only five feet. Consisting of

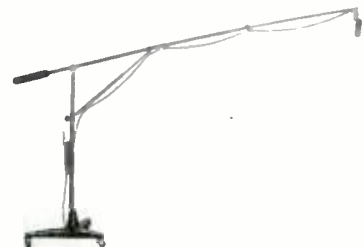

two telescoping four-foot sections, the boom (RCA Type KS-4A) has a controllable arc of approximately 180 degrees, and is counter-balanced so that it may be freely elevated and rotated to any point within its range. The sturdy stand is of all-steel construction with satin chrome finish, except for the low gravity cast iron base, which is finished in dark amber gray.



## RECORD REVUE

EDWARD TATNALL CANBY

(Because of unforeseen difficulties, we are obliged to postpone until next month Mr. Canby's interesting discussion of the characteristics of the various noise suppressors now on the market. However, his usual monthly review of recordings is presented below.)

Richard Strauss, Salomé: Dance of the Seven Veils.

Moussorgsky, Khovantchina: Dance of the Persian Slaves.

Royal Philharmonic Orchestra, Beecham.  
RCA Victor 12-0344 (1)  
12-0239 (1)

Two singles from Sir Thomas Beecham's orchestra, both with a pseudo-oriental touch, both opulently, magnificently played, both full of fine orchestral color, atmosphere, neither of much real importance musically. Technically, there is the usual mystery—both of these have gorgeous acoustics, fine big liveness, impeccable balance of various parts of the orchestra. But the Moussorgsky registers with me as having almost no higher range over 5000 or so; the Strauss seems to have useful components in the 8000 range. Theoretically the two should be a pair. Is it the music that is different? Was there in fact a difference in the recording—even if merely a wet day and a dry day? . . . In any case, neither of these can compare in range and in cleanness, especially in loud passages, with the average frr and similar recordings, but excellent acoustics, fine micro-phonings easily make up for the lack.

Tchaikowsky, June; November. (The Seasons, op. 37A)

Iturbi, pianist.

RCA Victor 12-0242 (1)

Two short and melodious piano pieces from a series of monthly tid-bits composed by Tchaikowsky about the time of the 4th Symphony. Both make attractive short-period piano listening. "June" will be familiar to most listeners as a salon-music standby of the better sort—a really lovely melody, wisely not over-exploited (at least in this, its original form) by the composer. Iturbi is good for this stuff. Piano is over-percussive; not much on the bass side.

Liszt, Sonetto del Petrarca, no. 104.

William Kapell, piano.

RCA Victor 12-0342 (1)

Another interesting short piano work, romantic, full of whipped cream finger work, but not as crudely flashy as some of Liszt's rather outdated pianistic fireworks, and this has a good deal of seriousness to it that makes it an attractive piece of its kind. Kapell might be accused of insufficient depth in the playing; personally, I prefer it; Liszt, these days, so easily gets too gushy! The piano recording here is excellent, the best Victor has produced recently, I'd say. Percussion notably absent, plenty of warmth and closeness, good brilliance too.

Bizet, Les Pêcheurs de Perles: A Cette Voix.  
Halévy, La Juive: Rachel, quand du Seigneur!  
Richard Tucker, Columbia Opera Orch.,  
Pelletier.

Columbia 72577-D (1)

A conventional French opera single, with the advantage of very fine recording. Mr. Tucker knows how to give, but he should

# Professional TAPE RECORDING

with FM QUALITY  
and EASY PORTABILITY

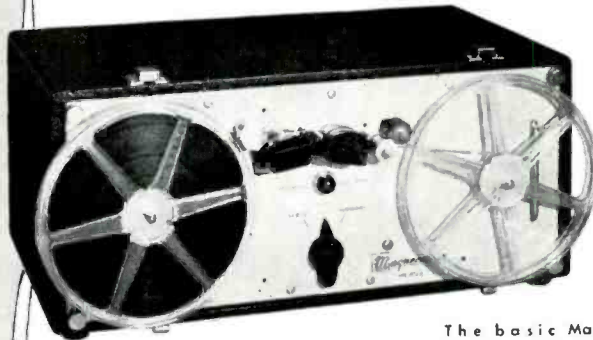

The basic Magne recorder mechanism (PT6-A)

## The New 3 Element MAGNECORDER

The Magne recorder meets the highest broadcast standards, and it costs you less. You buy and combine only the units you need:

**Magne recorder (PT6-A)** — Basic recorder mechanism.

**Portable Mixer-Amplifier (PT6-P)** — Recording and reproducing portable field amplifier. Can be used as high-quality remote amplifier. Mixes three low-level microphones.

**Rack Mount Amplifier (PT6-R)** — Recording and reproducing amplifier for studio rack mounting. With PT6-A makes complete studio recorder-reproducer.

*It's Portable! It's Flexible!*

**Weight** — PT6-A, 23 pounds; PT6-P, 29 pounds.

**Wow and Flutter** — .2%

**Frequency Response** — 40 to 15,000 cycles; + or - 2 db.

**Tape Speed** — 15 inches or 7½ inches per second (Interchangeable).

**Motor** — Synchronous 1/50 HP.

**Single Control**

**Rewind** — 45 seconds.

**Reels** — Standard 7-inch 8MM film reels.

Current failure never throws tape. Instantly interchangeable from portable to rack mounting.

Write today for detailed specifications

# Magnecord

INCORPORATED

360 N. Michigan Ave.

Dept. A

Chicago 1

Introducing...

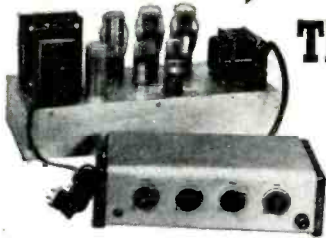

## The NEW Brook 10 WATT All-Triode Amplifier

Model 12A3—Two-unit remote-control amplifier. Decarator-styled control cabinet for living-room use. Also available as Model 12A2 for table or rack operation.

HERE it is at last—an amplifier of incomparable performance—built up to the highest standards of Brook engineering—in the moderate price field.

Within the range of its power rating the new Model 12A3 is equal in all respects to the world-renowned Brook 30-watt amplifiers.

The use of low- $\mu$  triodes in all stages, together with Brook-designed transformers available in no other amplifier, permits the cleanest amplification ever achieved... with

intermodulation and harmonic distortion reduced to the vanishing point at any power up to maximum. Frequency response is flat within 0.2 DB from 20 to 20,000 cycles.

Now for the first time, the distortion-free all-triode performance which the Brook Amplifier alone provides is available at a new low cost. Orders will be filled as rapidly as production permits.

Write TODAY for copy of detailed Distortion Analysis and Technical Bulletin AK-10!

Dealer Inquiries Invited—Standard Discounts Apply

## The BROOK High Quality Amplifier



— Designed by LINCOLN WALSH

BROOK ELECTRONICS, Inc.,

34 DeHart Place, Elizabeth 2, N. J.

## INTERMODULATION and HARMONIC ANALYSIS

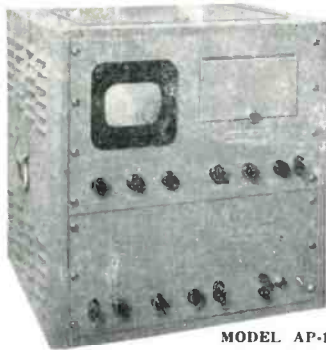

MODEL AP-1

### •Faster •Simpler •More Complete with the PANORAMIC SONIC ANALYZER

Backed by over 15 years of Panoramic know-how and ingenious forward looking engineering, the Panoramic Sonic Analyzer now introduces the many time-saving advantages of the Panoramic technique to the field of audio measurement. The Panoramic Sonic Analyzer Model AP-1 is a scanning instrument which automatically measures the frequency and amplitude of audio components between 40 and 20,000 cps... thus distortion analysis with the AP-1 is

**Faster...** a continuous overall view of the audio spectrum is displayed in one second... the effects of changes in design parameters or audio voltages can be instantaneously evaluated

**Simpler...** tedious point by point tuning is eliminated... the instrument is highly stable and requires minimum balancing

**More complete...** a self contained intermodulation analyzer section enables measurement of individual envelop components rather than just total cross modulation distortion... distortion as low as 0.1% is measurable... tuning by and missing weak components is eliminated... wide range voltage readings —50 $\mu$ v-500v

Investigate the advantages of using the AP-1 for your audio problems.

WRITE NOW for Complete Technical Data.

- For Use In**
- Audio Research Laboratories
  - Recording Studios
  - Broadcast Stations
  - Sound Film Studios
  - Universities
  - Production Lines
- Other Uses**
- Noise study
  - High frequency vibration analysis
  - Acoustic investigation

Be sure to visit us in Booth #7 at the National Electronics Conference

## PANORAMIC RADIO CORPORATION

92 Gold Street • New York 7, N. Y.

mind his French accent. There is much singing about "La noowee" here that will make French students blanch with horror. (The French probably wouldn't mind a bit.) The Bizet is a nice sob-song, the best of the two by far.

Debussy, (1887)

La Demoiselle Elue (The Blessed Damozel). Bidu Savão, Rosalind Nadell, Women's Chorus of Univ. of Penn. Philadlphia Orch. Ormandy.

Columbia MM 761 (3)

A beautiful performance of an early work of Debussy, highly impressionistic, atmospheric, reminiscent of "The Afternoon of a Faun" in style. Bidu Savão, well known for her more joyous performances of opera, is surprisingly fine here in the extremely French music. The chorus has been trained well and blends perfectly into the prevailing nostalgic atmosphere. The music is a bit diffuse and perhaps too long-drawn-out, but few of us will mind that, in view of the purity and sincerity of style it shows. A difficult piece to record—long silences, stretches of very low level, little to cover up when the 78 rpm "rhythm" so annoying when you can hear it. Everything here is exposed to the worst that the phonograph medium can do. Considering this, the album is excellently done from the technical viewpoint, though perhaps it might have been better to bring up the level in the low spots, in spite of Debussy. (Incidentally, this is an excellent recording on which to experiment with various forms of noise suppressors, since the removal of hiss and especially of pounding 78 rpm effects is vital to the music.)

Songs of the Auvergne.

Madeleine Grey, orch. conducted by M. Elie Cohen.

Columbia MM 758 (3)

This is a reissue, brought about directly by a surprising wave of public demand fostered by our publication-in-law (via this column!), the *Saturday Review of Recordings*. Interesting to find that such a campaign by individual record buyers actually influences a big company. These are most interesting French folk songs, sung capably by Madeleine Grey in the best French manner, with a very elaborate and coloristic orchestral accompaniment. Personally I don't like the latter; I feel that folk music of any sort, (unless flatly borrowed as thematic material for larger works) is much better left to tell its own musical story—which it can very well do. But if you don't object to elaborate settings, you will find these songs worthwhile and unique. The recording is clear, but limited in range and somewhat distorted. Nothing to bother a music lover. Some signs of worn masters.

Diamond, Music for "Romeo and Juliet". Little Orchestra Society, Thomas K. Scherman.

Columbia MM 751 (3)

"Romeo and Juliet" is re-interpreted on the stage, according to latest ideas, every few years—and in music the same seems to be inevitable. But though the 1880 "Romeo" would no doubt seem preposterous on our present-day stage, in music the style in Romeos and Juliets has long been set by Tchaikowsky and it's not easy for many listeners to swallow any other conception. Diamond's—which compares interestingly with Prokofieff's music for the same—is in a sense deflationary: after Tchaikowsky, any "Romeo and Juliet" music is bound to have that character. It doesn't exult and lament and strut. The music is not particularly complex nor very dissonant; it is pre-



vailing modal, a harmonic tendency not common among American composers though the English have long been addicted to it. (Play a scale, white notes, from E to E on the piano for the type of modal scale Diamond uses.) Orchestration is rich and conventional. Recording here is good wide range, but not as expansive in its liveliness as the music could stand.

## — News —

### WARD PROMOTED



by A. C. Travis, Jr., Vice-President. Formerly with Audio Devices and Muzak, Mr. Ward joined Reeves Soundcraft in 1946 as Assistant Sales Manager.

• As a result of increasing company activity in the recording disc field, Donald E. Ward has been appointed Sales Manager for Reeves Soundcraft Corporation, 10 East 52nd Street, New York City, it has been announced

## SOUND DISTRIBUTION

[from page 31]

the vertical coverage angle, and then again by the ratio using the horizontal coverage angle.

If the coverage angle is unknown, it may be approximated for speech by moving off the axis of the speaker until the articulation is no longer satisfactory. Twice this angle off the axis is the coverage angle. In general, speakers of this sort become more directional with increase in frequency<sup>17</sup> and loss of articulation is a fair measure of the reduction of high frequency response. This is a very practical solution as well, since it approximates the actual use of the system. Three precautions must be taken in using this method of determining coverage angle. The speaker must be mounted in free space far enough from reflecting surfaces to eliminate noticeable echo; the observer must be at least 25 feet and preferably 50 feet from the speaker and must maintain the same distance as he circles the speaker throughout the test; the level at the observer's position must not exceed that of normal conversation. Returning to the 80° speaker, notice that the sound level increased from 80 db at 160 feet to 95 db at 29 feet from the speaker. To avoid exposing the nearby listeners to uncomfortably loud levels, the speakers should be located some distance above ground.

The principle of using coverage an-

# RACON ADVANCED ENGINEERING Gives you RACON SUPERIOR PERFORMANCE

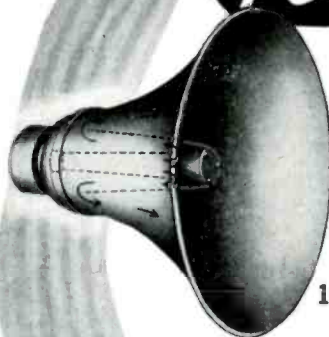

1

A horn or speaker of conventional type may resemble a Racoon horn or speaker in outward appearance. But close examination of a Racoon unit reveals internal differences—refinement of design, better mechanical construction, sturdier materials and other special features that represent **ADVANCED ENGINEERING**. It is these exclusive features that give you superior performance in any Racoon unit. Higher efficiency over wider ranges. Freedom from distortion. Uninterrupted service. The long life that protects your investment.

### 1-RACON RE-ENTRANT TRUMPET RE-15

Designed to deliver highly concentrated sound over long distances. Occupies small space yet has an air column of 18". Inside tone arm of aluminum castings; center section and bell heavy gauge aluminum spinnings. Very efficient; free from resonant effects. Ruggedly built, practically abuse proof.

Length 9-7/8"; bell diameter 8-3/4". Swivel type wall bracket.

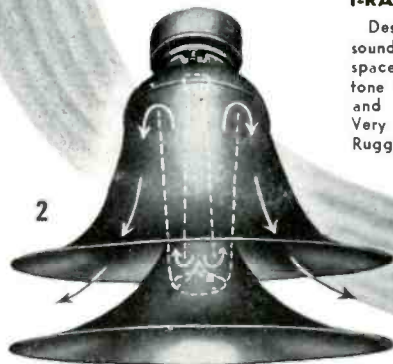

2

### 2-RACON RE-ENTRANT RADIAL TRUMPET SR-35R.

Has all of the construction features of RE-35 such as non-vibratory center section, heavy aluminum castings, etc. All reflecting surfaces of **RACON PATENTED ACOUSTIC MATERIAL** to prevent resonant effects prevalent in all large reflecting surfaces. Delivers sound with even intensity over a 360° circumference. Length 16"; width 17". Type SR-60R length 34 1/2"; width 36".

### 3-PERMANENT MAGNET HORN UNITS

Highly popular in all types of service. Many improvements. Two groups with Alnico V Magnets and Alnico Blue Dot Magnets. Steel parts plated to prevent corrosion. Also fitted with corrosion proof metal or plastic diaphragms. Voice coil



3

impedance on all units: 15 ohms, except dwarf size—which is 8 ohms. Special ohmages on request.

### NOW FURNISHED WITH WATERPROOF CASING

All units may now be had with heavy spun aluminum cases, forming a hermetically sealed, watertight housing for outdoor use, at slight extra cost.

Write for Catalog of complete Racoon line.

RACON ELECTRIC CO., Inc., 52 E. 19th St., New York, N. Y.

# RACON

Speakers  
Horn Units  
Horns



Looking for a tape recorder?

# RANGERTONE

is the ONLY magnetic tape recorder that is commercially ready NOW to meet the new N A B recording speed standards. You can switch at will to any one of the three; 7 1/2", 15" or 30" a second.

- ★ Total harmonic distortion does not exceed 1% overall for any frequency from 100 to 6,000 cycles and 2% from 30 to 100 cycles. Other specifications on request.



**RANGERTONE, Inc.**

73 WINTHROP ST. • NEWARK 4, N. J.

## Square Wave Generator



**MODEL 71**

### SPECIFICATIONS

**FREQUENCY RANGE:** 5 to 100,000 cycles.  
**WAVE SHAPE:** Rise time less than 0.2 microseconds with negligible overshoot.  
**OUTPUT VOLTAGE:** Step attenuator giving 75, 50, 25, 15, 10, 5 peak volts fixed and 0 to 2.5 volts continuously variable.  
**SYNCHRONIZING OUTPUT:** 25 volts peak.  
**R. F. MODULATOR:** 5 volts maximum carrier input. Translation gain is approximately unity—Output impedance is 600 ohms.  
**POWER SUPPLY:** 117 volts, 50-60 cycles.  
**DIMENSIONS:** 7" high x 15" wide x 7 1/2" deep, overall.

MANUFACTURERS OF  
 Standard Signal Generators  
 Pulse Generators  
 FM Signal Generators  
 Square Wave Generators  
 Vacuum Tube Voltmeters  
 UHF Radio Noise & Field Strength Meters  
 Capacity Bridges  
 Megohm Meters  
 Phase Sequence Indicators  
 Television and FM Test Equipment

**MEASUREMENTS CORPORATION**

BOONTON  NEW JERSEY

gle and "throw" to determine a coverage area for a single speaker can be used to locate speakers in a multiple speaker system. In many systems in which the direction of the sound source is not important (for example, a system to cover a parking lot), a number of speakers may be spotted over the area to be covered. The outdoor auditorium or concert bowl is a complex problem. Rettinger and Stevens<sup>18</sup> have indicated some of the difficulties involved in an installation of this type, although theirs were aggravated by the unusually large size of the bowl.

### Conclusion

The above examples do not illustrate all the types of systems that a sound engineer may be called upon to install, but they do illustrate many of the problems he will face, however. The engineer must still undertake his own jobs with good judgment and a willingness to experiment. Experience with actual installations will teach him more than this or any other article.

### References

17. O. L. Angevine, Jr. and R. S. Anderson, "Facts about Loudspeakers" Part II, *Audio Engineering*, Vol. 32, No. 3, p. 25, March, 1948.
18. M. Rettinger and S. M. Stevens, "Sound Reinforcement in the Hollywood Bowl", *Audio Engineering*, Vol. 32, No. 2, p. 15, February, 1948.

## RADIO SYSTEMS

[from page 23]

meter should be connected in place of the gain-setting resistor,  $R_g$ . The antenna coil should be adjusted when all the individual tuners are connected together and to the common antenna terminal, though for flat-topping it will be necessary to make preliminary adjustments on the single chassis. If an f-m oscillator and scope are not available, the tuner can be aligned approximately by ear, although it is doubtful if the response curve will have the ideal flat-topped shape. However, if no other means is available, fair results can be obtained by this method of alignment and the quality of its output should be at least as good as that of a conventional receiver.

After the channels are all aligned and installed, they may be adjusted to equal audio output levels by selecting a suitable value for  $R_g$  in each. Probable values for use in metropolitan areas will range from 1,200 to 2,700 ohms. Too low a value may cause oscillation, but the proper point at which



the detector should work is the important parameter, and it is doubtful if it will be necessary to reduce  $R_b$  below 1,000 ohms. Each r-f stage is essentially a tuned-grid, tuned-plate arrangement, and such a circuit is prone to oscillate if external feedback is sufficient or if the gain of the stage increases too greatly. The d-c voltage at the cathode of  $V_3$  should be from 15 to 20 volts for a 200-volt plate supply, and this value is dependent upon the r-f signal applied to the grid.

With a number of these channels it is possible to select stations by means of a single-gang rotary switch, all filaments being heated whenever the system is turned on. For use in recording studios, however, an additional stage should be added, together with a tube-to-line transformer, as indicated in Fig. 7. One section of the

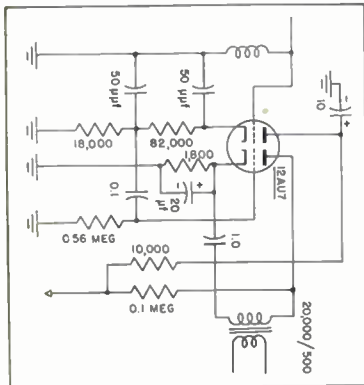

Fig. 7. Alternative output arrangement suitable for use in recording studios where several channels may be used simultaneously. Transformer matches output tube to 500-ohm line.

12AU7 twin triode is used for the detector, while the other is the audio output stage. Some such arrangement is required if it is necessary to record more than one station simultaneously.

For a large residence installation, the low-impedance outputs of several fixed tuners may be fed at approximately zero level throughout a home, with a selector switch and an amplifier at each room where a speaker is desired, or any of a number of switching arrangements may be employed. There is practically no limit to the applications to which the fixed tuner strip may be put, and their use will depend upon the ingenuity of the constructor. The cost for each tuner should be somewhere around \$10.00, without the transformer, and for those who wish convenience and quality, they are considerably superior to more conventional receivers.

# GOODELL

announces 3 important  
new developments in  
audio electronics

## THE GOODELL MAGNETIC NOISERASER

Conditions New Tape • Restores Old • Increases Dynamic Range

The Goodell Magnetic Noiseraser consists of a carefully engineered tuned magnetic circuit designed to eliminate all signals and background noise from entire reels of magnetic tape in a few seconds. Recommended for use with brand new tape before recording to minimize inherent random noise. A few seconds in the Noiseraser will completely remove saturation signals. Restores tape to new condition and permits indefinite useful life with minimum background noise.

**SPECIFICATIONS:** Aluminum chassis, bakelite top, 7" x 15" x 3". **POWER REQUIREMENTS:** Operates on 110-120 volts, 60 cycles. On-off switch, pilot light and fuse . . . Magnetic tuned circuit designed for optimum demagnetizing fields through the tape. Oil-filled paper capacitors and double glass insulated coils insure trouble-free operation.



MODEL N-7 for 7-inch reels, net. . . . . \$57.60 MODEL N-14 for 14-inch reels, net. . . . . \$97.50

## THE GOODELL DUPLEX REPRODUCER ARM

For Use on Both Standard and LP Records

The new Goodell Duplex Reproducer Arm is designed to carry simultaneously two high quality magnetic cartridges for standard and micro-groove records. Diamond for LP micro-grooves. Special consideration has been given in selecting optimum suspension structures, compliances and bearings to provide perfect tracking with minimum stylus and record wear, as well as maximum stability.

Write for prices and descriptive catalog sheet.

The Goodell

## DYNAMIC NOISE SUPPRESSOR AMPLIFIER

Here is the perfect monitoring and audition amplifier, ideal for custom built radio-phonograph installations, for schools, industry and homes, including every feature desired by the audio enthusiast. The GOODELL six-tube version of the Dynamic Noise Suppressor effectively reduces objectionable noise while maintaining wide range response.



Licensed under Hermon Hosmer Scott Pat. Pend. for use only in phonograph and phonograph distribution systems.

MODEL NSA-2 without pre-amplifier. . . . . \$147.50  
MODEL NSA-2 with pre-amplifier. . . . . \$154.50

The Minnesota Electronics Corporation • St. Paul 1, Minn.

# TECHNICANA

## • NOTES ON A 6AS7G AMPLIFIER

FOR a few months, I have been using a 6AS7G amplifier. The final stage is practically identical to the final stage of the amplifier described in the March issue of *AUDIO ENGINEERING*. Previously, I was using a pair of 2A3s. The 6AS7G is superior to the 2A3s in every respect. The amplifier is used most of the time with an FM tuner, in New York City. It has relatively little pre-amplification. My experience has been that most amplifiers have too much pre-amplification, with a corresponding increase in hum, distortion and noise. With a single push-pull triode stage, using two 6C5s, I have too much volume for a large living room. The interstage transformer is an UTC LS-22. The amplifier is so silent that, the tuner being cold, the ear has to touch the speaker before the slightest noise can be perceived.

Another feature of the amplifier is that it is push-pull throughout. No inverter is used. The problem is solved by grounding the middle point of the discriminator. The de-emphasis circuit is split into two symmetrical resistors and two symmetrical condensers. I have never seen it done, but it is, it seems to me, the most natural solution. A similar solution could be

used on AM, but, at the present time, I have no AM tuner and do not need any. For listening to records, I use a crystal pick-up which directly gives me a push-pull output: I unsoldered the grounded end of the pick-up and connected a second wire.

The best bet for the music lover, at least in New York City, is to listen to FM transmissions of live concerts. A "disadvantage" of the high quality amplifier is that the listener perceives the difference between records and live music much more than on an ordinary radio.

Triodes, to my ear, sound better and cleaner than anything else. I have listened to directly-coupled push-pull 6L6 amplifiers, with plenty of feedback, and my conclusion is that a beam power amplifier always lacks

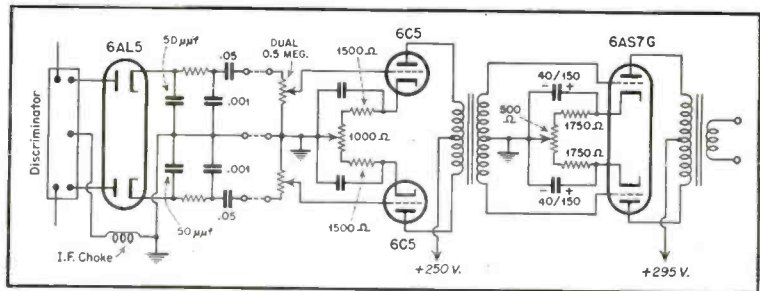

# AUDIO ENGINEERING

# BINDERS \$2<sup>50</sup>

- Backbone gold stamped with Audio Engineering and year.
- Center channel to keep magazines fastened in position.
- Round corners, hinges and backbone fully reinforced.
- Rich blue Dupont Fabricord—stainproof and washable.
- \$2.50 postpaid. Foreign orders add 50c.

★ ★ ★ Here at last is a binder using modern postwar materials at prewar prices. Designed to provide instantaneous reference to your monthly copies of *Audio Engineering*. An unusually fine library finish that will stand up under constant use.

- Rigid backbone with bound-in metal support.
- Light weight tarnishproof aluminum ends.
- Coil springs built in at each end to securely position spring steel wire holders.

RADIO MAGAZINES, INC.

342 MADISON AVE.  
NEW YORK 17, N. Y.

AUDIO ENGINEERING  
BINDERS

1947     1948

Enclosed find \$ ..... for ..... Binders

Name .....

Address .....

City ..... State .....



something that a triode amplifier— with 2A3s or, *a fortiori*, a 6AS7G,— has. The triode amplifier gives a much more *natural* sound, while even the best beam power amplifier gives the impression that the sound is “reconstructed”. The only instrument I use is an old voltmeter; hence, I cannot give figures on distortion for my amplifier, but, to my ear, it sounds better than any commercial or custom amplifier I have heard until now. The reproduction, on voice or music, is remarkably clean and natural.

— JOHN VAN HEIJENOORT

## — News —

### ALTEC MOVES

• Offices of Altec Service Corporation and its manufacturing subsidiary, Altec Lansing Corporation, have been moved from 250 West 57th Street to 161 Sixth Avenue, New York 13 as of June 28th. The new telephone number is Algonquin 5-3636.

The warehouse and electronic laboratories now at 533 West 57th Street will be moved to the new address on July 23rd.

The Altec Service and Altec Lansing offices will occupy the entire eleventh floor at 161 Sixth Ave.

The New York district of Altec Service Corporation remains in their present offices at 250 West 57th Street.

## GERMANIUM CRYSTALS

[from page 33]

method has three conditions. At zero bias, zero signal, and no plate voltage, the impedance is 600 ohms. With 0.5 volts positive bias, but no plate voltage, it falls to 150 ohms.

As the plate voltage is raised from zero, the grid impedance rises from 125 to as high as 2,000 ohms. This is with plate loaded and signal in both grid and plate, and with signal effective across the grid of 0.1 volt rms.

This series of apparently unrelated facts is so unusual that it takes quite a while to readjust our thinking and attempt to design the equivalent network for the crystal. One single help is that apparently reactive components can be neglected at 1 kc, so we apparently must build our equivalent circuit with meshed one-way non-linear resistors and an occasional two-way resistor. Apparently feedback inside the crystal also takes a rather unusual form.

With the setup of Fig. 1, after you have established which contact controls the other, and have overshoot and tapped the crystal, remove the secondary load from the output transformer. Put in an 0.1 volt signal, run

the plate current up to a mil or so, or raise the plate voltage to 40 or more. Read the output voltage. Insert enough secondary load to bring this voltage down to half. The plate impedance is then matched. The secondary load (say 500 ohms) times the square of the step-up ratio of the transformer (for example, 4<sup>2</sup>) gives 8,000 ohms plate match.

In the general case, the load is now matched for all plate voltages so long as it is above 30 or so. Incidentally, the treated crystals will often work well at 100 volts on the plate.

As the plate voltage is varied, check

the grid impedance at various settings. Knowing this, the set-up can be adjusted for maximum power step-up.

It is obvious from the above data that there is an advantage in operating at high plate values. The gain is no more in terms of voltage in and out, but always bear in mind the input circuit consumes power. As the plate voltage rises the input impedance goes up markedly, so we gain in power ratio by the lessening grid driving power. The higher grid impedance also makes it easier to cascade units.

[Continued on page 52]

## Exclusive WARD LEONARD VITREOUS ENAMEL Insulates and Protects VITROHM RESISTORS

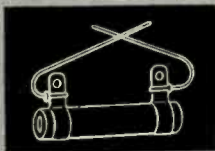

*Tough! Crazeless!  
Acid and Moisture  
Resisting!*

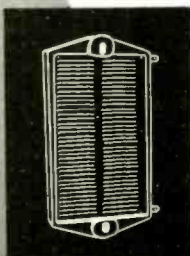
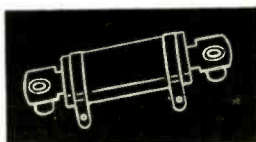

The extra service you get from Vitrohm Resistors is due in great measure to the exclusive vitreous enamel coating developed and produced in the WARD LEONARD laboratories. This Vitreous enamel forms a perfect bond with the core, the wire and the terminals . . . quickly conducts away generated heat . . . insulates and protects the winding. It is the ideal armor against mechanical and electrical breakdown. Vitrohm Resistors are available in a wide range of types and sizes for every need from your WARD LEONARD Distributor.

Radio & Electronic Distributor Division

WARD LEONARD ELECTRIC CO.

53-R West Jackson Blvd., Chicago 4, Ill., U.S.A.

SEND FOR CATALOG D-130

Gives quick, helpful data and information on the many stock types and sizes. Also includes Radio Amateur Relays.



Basic 3 R's in Current Control

## WARD LEONARD

RELAYS • RESISTORS • RHEOSTATS



### Control After Flashover

The treated crystal shows control at high plate currents about one-third the time. For instance, with a thousand ohms in series with 120 volts, dc., grid variation of one volt gives plate variations from 40 to 60 ma, a dc gm of 20,000. This lasts about 45 seconds on an average, and then the assembly heats up and becomes inoperative. There are many applications where the amplifier is used at a low duty cycle and for short periods where this would be usable.

On cooling off for about a minute,

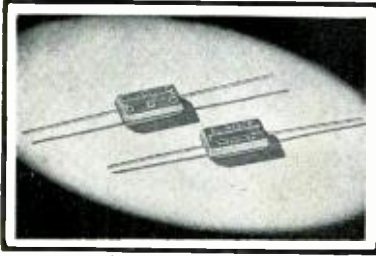

... SPECIFY

No product is better than its weakest component. That's why more and more manufacturers specify El-Menco—the mica capacitor that always gives customer satisfaction and builds better reputations.

#### CM 15 (9/32" x 1/2" x 3/16")

For Radio, Television, Other Electronic Applications

2 to 420 mmf. capacity at 500v DCA

2 to 525 mmf. capacity at 300v DCA

Temp. Co-efficient  $\pm 50$  parts per million per degree C for most capacity values.

6-dot standard color coded

after a 45 second series of tests, it again becomes operative.

The writer regrets that full time on this job has produced more confusion than light. However, we have had as a primary objective the production of a mechanical design we have confidence in and that allows instant change of crystals without extensive manipulation of catwhiskers. We now are lucky enough to have such a structure, so our number of tests per hour can be greatly increased. We feel this subject is important enough to warrant a real basic effort to understand

the fundamentals. We also have several other holders we shall show in the next issue.

It is obvious that circuit design is going to be difficult. We must come up with simple circuits of few components. One very promising feature is the apparent unlimited life of the unit, which can easily be made shock-proof.

We have done considerable work using the overshoot characteristic as a basis of working a relay and also for counter circuits, but since this is an audio engineering magazine, this application is beyond our scope.

At this stage we must do much spade work, particularly in understanding the basic apparent disadvantages of the unit, so we can either design around them or turn them to advantage. It is well to remember that the field of electronics is so extensive that we have endless possibilities of taking these unusual characteristics and putting them to work.

BETTER COMPONENTS  
BUILD  
BETTER  
REPUTATIONS

# El-Menco

CM 20 Available in "A", "B", "C" and "D" characteristics

2 to 1500 mmf. in tolerances down to  $\pm 1\%$  \* or .5 mmf. at 500 D.C. working voltage  
6-dot color coded \*Whichever is greater

CM 35 Available in "A", "B", "C", "D" and "E" characteristics

Minimum tolerance 1%  
500 D.C. working voltage  
6-dot color coded

#### ARCO ELECTRONICS

Sole Distributors for Jobbers and Retailers

in United States and Canada.

135 Liberty St., New York, N. Y.

Write, on firm letterhead, for samples and catalog.

## THE ELECTRO MOTIVE MFG. CO., Inc. Willimantic, Conn.

STATEMENT OF THE OWNERSHIP, MANAGEMENT, CIRCULATION, ETC., REQUIRED BY THE ACTS OF CONGRESS OF AUGUST 24, 1912, AND MARCH 3, 1933 OF AUDIO ENGINEERING, published monthly at New York, N. Y., for October 1, 1948.

State of New York }  
County of New York } ss.:

Before me, a Notary Public in and for the State and county aforesaid, personally appeared John H. Potts, who, having been duly sworn according to law, deposes and says that he is the Editor of AUDIO ENGINEERING, and that the following is, to the best of his knowledge and belief, a true statement of the ownership, management, etc., of the aforesaid publication for the date shown in the above caption, required by the Act of August 24, 1912, as amended by the Act of March 3, 1933, embodied in section 537, Postal Laws and Regulations, to wit:

1. That the names and addresses of the publisher, editor, managing editor and business manager are: Publisher, Sanford R. Cowan, 1620 Ocean Ave., Brooklyn 30, N. Y.; Editor: John H. Potts, 1737 York Avenue, New York, N. Y.; Managing Editor, C. G. McProud, 7 Peter Cooper Road, New York, N. Y.; Business Manager, S. R. Cowan, 1620 Ocean Ave., Brooklyn 30, N. Y.

2. That the owners are: Radio Magazines, Inc., 342 Madison Ave., New York 17, N. Y.; John H. Potts, 1737 York Avenue, New York, N. Y.; and Sanford R. Cowan, 1620 Ocean Ave., Brooklyn 30, N. Y.

3. That the known bondholders, mortgagees, and other security holders owning or holding 1 per cent or more of total amount of bonds, mortgages, or other securities, are: None.

4. That the two paragraphs next above, giving the names of the owners, stockholders and security holders, if any, contain not only the list of stockholders or security holders as they appear upon the books of the company, but also, in cases where the stockholder or security holder appears upon the books of the company as trustee or in any other fiduciary relation, the name of the person or corporation for whom such trustee is acting, is given; also that the said two paragraphs contain statements embracing affiant's full knowledge and belief as to the circumstances and conditions under which stockholders and security holders who do not appear upon the books of the company as trustees, hold stock, and securities in a capacity other than that of a bona fide owner; and this affiant has no reason to believe that any other person, association, or corporation has any interest direct or indirect in the said stock, bonds, or other securities than as so stated by him.

(Signed) JOHN H. POTTS, Editor.

Sworn to and subscribed before me, this 8th day of September, 1948.

(Seal) HARRY N. REIZES, Notary Public.

In the State of New York, Residing in Kings County, Kings Co. Clk's No. 634, Reg. No. 612-R-9; N. Y. Co. Clk's No. 779, Reg. No. Term Expires March 30, 1949.

## SPEAKER ENCLOSURE

[from page 25]

resulting in a clean break. A rough cleaning powder, mixed with sand and water is swished around in the half tube remaining, thus cleaning the inside. Clean varnish is then poured into the tube and the rods dipped. Withdraw the rods slowly, and at the same time, blow softly and evenly at the point the rod emerges from the varnish. This removes all air bubbles. Stand rods on end to dry.

The next step is to mount the speaker baffle and to finish the inside of the cabinet. Fold a heavy blanket about four times and place newly painted, but dry cabinet, front side down on it to do the following work:

Around the edges of the speaker aperture and inside, screw the four wood strips which are 1/4-inch thick and 1 1/2-inches wide. These give greater rigidity to the front section and also set the speaker baffle and grill back about 1/4-inch to allow room for the back mold to fit into place later. Tack the grill cloth at the four corners first, then tack along edges every three inches. Cut round hole of proper size in Celotex speaker baffle, mount speaker firmly and fasten baffle, with speaker, against grill cloth into the four wood strips mentioned above, with eight wood screws. The speaker mounts just above center of the baffle board to decrease the possibility of any resonant effect.

For complete sound-proofing, Kimsul strips are cut to fit all sides of the inside of the cabinet except the front and



held into place with the use of small nails, backed with cut-out pasteboard washers. The back is held tightly in place by the use of six wood screws fastened into the one-inch square wood strips which run across the inside of the top and bottom sections of the enclosure. The cable from the speaker terminals comes out at the bottom center, about an inch from the back but outside the base board.

Examination of the photograph of the back molding pieces shows how 3/16-inch holes are drilled in the two shorter pieces which support the grill rods. The molding is press-fitted into place. The rods also are held into place by friction.

After six weeks of operation of this new cabinet, all who have listened carefully to high-quality program material have agreed that the reproduction is extremely good.

## INTERNAL RESISTANCE

[from page 20]

simply be 10 ohms. This means that  $p = .5$ . Let us assume that we observe a drop of voltage from the original 5 volts to 3.6 volts; the voltage reduction  $q$  is consequently  $2.6/5 = .72$ . Substituting the values for  $R_1$ ,  $q$  and  $p$  into equation (4) results in  $R = 12.8$  ohms. This amplifier, as far as internal resistance is concerned, therefore approaches the condition of an amplifier with triodes in the output stage, where we could expect an internal resistance of 10 ohms, when looked "back" at from the 20-ohm output tap.

In the case of a straight pentode amplifier, it will be found that the reduction of the load resistance to one half will reduce the voltage across the load very nearly in the same ratio, which is easily understandable, since a pentode is essentially a constant current generator, rather than a constant voltage generator. This means that  $q$  is very nearly equal to  $p$ , which results in  $R = \infty$ .

It may be of interest to use equation (4) to calculate what  $q$  will be observed in the case of a triode amplifier designed in such a way that the load resistance is equal to twice the plate resistance. Under this condition, the internal resistance observed when looking back into any of the output taps of the output transformer should be equal to one-half the load resistance for which the particular tap is designed. Looking back into a 10-ohm tap for instance, we should see 5 ohms. If, for the purpose of our test, we

## ALTEC LANSING NOW "PACKAGES" ALL COMPONENTS FOR A COMPLETE HIGH FIDELITY RADIO-PHONOGRAPH SYSTEM TO BUILD INTO YOUR HOME

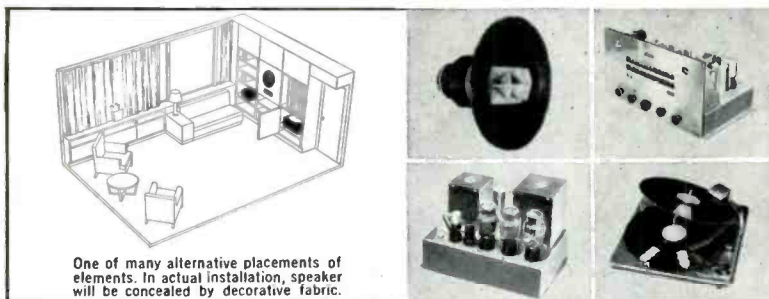

One of many alternative placements of elements. In actual installation, speaker will be concealed by decorative fabric.

The Altec Lansing Custom-in-Built Music System consists of the famous Altec Lansing Duplex speaker, a special Altec Lansing amplifier, a newly designed TRF Altec Lansing AM-FM tuner, and the Webster 70 record changer with GE variable reluctance pick-up. Integrated with the structure of your room, this system transcends completely the inherent acoustical and electronic limitations of conventional radio-phonographs, eliminates radio "furniture," and reproduces the

full range of sound (35 to 16,000 cycles). It achieves the highest faithfulness to living sound now known to science. Built-in Altec Lansing Day-light Television can also be included. Complete installation instructions come with each system.

*A brochure will be sent on request.*

**ALTEC**  
LANSING  
*custom-in-built  
home music system*

161 Sixth Avenue,  
New York 13, N. Y.  
1161 N. Vine Street,  
Hollywood 38, Calif.



**NEW...IMPROVED**

**PRECISION ATTENUATORS**

**by TECH LABS**



TYPE

850-A 850-B

The units illustrated represent a complete redesign of our older precision attenuators for laboratory standards. Flat for all frequencies in the audio range. Reasonably flat to 200 k.c. up to 70 db.

Bulletin sent on request.



Manufacturers of Precision Electrical Resistance Instruments  
337 CENTRAL AVE. • JERSEY CITY 7, N. J.

## New ATLAS SOUND ALNICO-V-PLUS

A great step forward . . . Atlas Alnico-V-Plus Super-efficient magnetic assembly. Energy per unit volume over three times as great as any used before. Traditional Atlas Quality and Fidelity to Precision are incorporated in all these new developments. Keep step with Sound Advancement with Atlas Sound.



PD-8V New Atlas streamlined Hi-Fidelity Alnico-V-Plus Driver Units.



TP15V New Atlas Alnico-V-Plus Dual Projector. Also in larger model TP24V.



PD-5V All Atlas PD-V Driver Units are completely Magnetically Shielded . . . entirely Hermetically Sealed.



HU-24V All Atlas Speakers have new unbreakable Alnico-V-Plus Driver Units.



HU-15V Maximum efficiency as reproducer, utmost performance as microphone in talk-phone.



PD-3V All Atlas PD-V Driver Units have full phenolic unbreakable diaphragms.



Write for New Illustrated Catalog.

MICROPHONE STANDS—Atlas is outstanding in Quality, completeness and variety of models produced.



MULTIPLE SPEAKER SUPPORT STAND

Atlas Sound's dual purpose value. Perfect for powerful outdoor (collapsible tripod model) or indoor (illustrated) array. Portable. Quick, convenient, practical.

**ATLAS SOUND CORP.**

1445-39th STREET  
BROOKLYN 18, N. Y.

make  $R_1$  equal to the rated load resistance value of the particular tap. For instance 10 ohms, and then reduce it to one-half of this value by placing 10 ohms parallel to it,  $p$  will be equal to .5. With  $R = 5$  ohms, and  $R_1 = 10$  ohms, equation 5 can be solved for  $q$  as follows:

$$(5) \quad 5 = 10 \times \frac{1-q}{9/5-1} \cdot .5 = \frac{1-q}{2q-1}$$

and therefore  $q = .75$

This shows that in an amplifier with a properly designed triode output stage the voltage should drop to 75 per cent. when we change the load from the rated value at any given output tap to one-half of this value. If it should drop further, the amplifier is not as good from the damping point of view as a well-designed triode output stage. If the voltage drops less than 25%, the internal resistance is less than one-half the load resistance.

## ERRORS IN ATTENUATORS

[from page 34]

The attenuation error given by equation (6) is in nepers. To obtain the result in decibels, the right side must be multiplied by 8.68. By substituting (7) in (6) we obtain the following expression which relates the decibel error to the resistance error and nominal loss of the network.

$$(8) \quad \Delta \delta = -8.68 \frac{N-1}{N+1} \left(1 - \frac{m}{n}\right)$$

The quantity  $N$  may be obtained from the nominal loss of the network by the following identity;

$$(9) \quad N = \text{Antilog } \frac{\delta}{20}$$

Equation (8) is shown in nomograph form in Fig. 2. The nomograph is directly applicable to  $\Pi$  and Tee, attenuators, and in each case  $Z_m$  is to be considered as the series branch and  $Z_n$  as the shunt branch. If for a Tee network the two series branches are assumed to have different tolerances, or if this condition is assumed in the two shunt branches of a  $\Pi$  network, the network may be broken into two L sections and each section individually treated. The error for the L section will be one-half that of a full Tee or  $\Pi$  composed of two such sections. The value of the nominal attenuation applied to the chart should therefore be taken on the basis of that of a full section.

Several interesting applications of the chart will now be considered. For example, let it be required to find the maximum decibel error of a 20 db type Tee attenuator which is variable in 1 db steps and is constructed of 2% re-

## The ONE-STOP Store for PRODUCTION EQUIPMENT

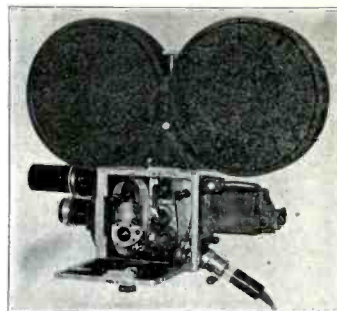

### 35mm or 16mm Single System Soundfilm Cameras

**Auricon Pro TV Special Kit** — Self blimped 16mm soundfilm recording camera exactly as furnished to ABC, CBS, NBC, WPX and leading TV film producers. Complete to the Nth detail. **\$2213.50**

**Coming Soon — Auricon Pro TV Transcription Recording Camera** Makes 16mm Soundfilm off-the-tube for 24 f.p.s. showing, 1200' magazine runs for full half hour. Write for details!

### SPECIALS FROM OUR \$250,000 STOCK

B. Maurer compl. 16mm recording system .....	\$2275.90
Comb. 16mm film phonograph & tape recorder .....	1995.00
200 Watt Fresnel spots with heavy yoke .....	57.50
B & H 35mm Unit Eye Shuttle .....	650.00
Arriflex motorized Newreel Camera, 4 lenses, worth \$1250. Complete .....	895.00
Cinephon motorized Newreel Camera, 4 lenses, worth \$1800. Complete .....	1295.00

**STUDIO, EDITING & LAB. SUPPLIES**  
Lights, mikes, booms, dollies, lenses, background process, movielas, etc. Send for Catalog Sturelab-7—thousands of good buys.

**S. O. S. CINEMA SUPPLY CORP.**  
Dept. AE 692 W. 52nd St. New York 19

## PRECISE AUDIO MEASUREMENTS

Pickering and Company, Inc., leaders in the audio field, make available to the industry their specialized facilities for audio measurements.

We are prepared to make guaranteed measurements on any type of audio equipment for manufacturers, dealers, or consumers.

**PICKERING & CO. Inc.**  
Oceanside, N. Y.

**VERTICAL LATERAL REPRODUCERS RECONDITIONED**  
Types 9-A, 9-B, D-93306, MI-4856, MI-4875-G  
Complete Stock of New Replacement Parts for All Types

This service is being used by leading radio stations and wired music companies from coast to coast. Factory prices prevail.

**VIBRATION SYSTEMS, INC.**  
1040 W. Fort St. Detroit 26, Michigan

## WANTED

G. I. Flyer motor model 818 double field two speed; also Blue Flyer model E. Contact **W. Dacosta, Sound Dept., WOR**



sistors. The maximum error will occur with full attenuation and when the series resistors are 2% high and the shunt resistor 2% low. The quantity  $m/n$  then equals .96 and the decibel error will be  $-28$  db.

Next, let us consider a ladder attenuator for this application, also with 2% resistors. The maximum decibel error will occur when all of the series resistors are 2% high and the shunt resistors 2% low. For one step of 1 db the error will be  $-.018$  decibels and for the twenty steps the total error will be  $-.36$  db. It is thus seen that the total error exceeds that of the Tee type attenuator. It is very unlikely, however, that all of the series resistors will be high and the shunt resistors low. Instead, it would be expected that the resistors will vary randomly about the nominal value for each step, and that the maximum total error will not differ greatly from that of a single step. On this basis, the ladder would provide a greater overall accuracy than the type Tee attenuator.

If the application calls for operation at low temperatures, it is of interest to make another comparison. In type Tee attenuators, the resistors are commonly all of wirewound construction, and the wire used has a more or less uniform temperature coefficient of resistance. In the ladder attenuator, however, the construction would consist of a wirewound series element and carbon composition shunt resistors. At a temperature of  $-40^{\circ}$  C., one could expect the type of carbon resistors used to change by  $+15\%$ . The corresponding change in a nichrome wire series element would be  $-1\%$ . The ration  $m/n$  then equals 1.16, and the error per step will equal  $+ .075$  db. The total error will be  $+ 1.5$  db, and at the twenty decibel setting the actual attenuation will be 21.5 db. It is thus seen that when operation over a temperature range is a consideration, the Tee attenuator will provide a much greater accuracy than the ladder.

## DISTORTION MEASUREMENTS

[from page 18]

close together and analyzing the resultant intermodulation products with a wave analyzer seems to offer a more direct approach to the problem of distortion measurements when the transfer characteristic is a function of frequency. It is apparent, however, that further experience with intermodulation distortion measurements is required before standardization of techniques can be attained.

## MAKE YOUR OWN WIRE-WOUND RESISTORS!

This kit contains all the necessary components for the construction of wire-wound, non-inductive resistors. You can make meter multipliers, shunts and non-inductive resistors for use in audio circuits. Values up to 100,000 ohms may be easily wound by following the instructions.

The large variety of wire sizes and alloys that are included in the No. 200 Resistance Wire Kit makes it invaluable to laboratory technicians and experimenters who find the need to make resistors on the spot.

Resistors of 5% accuracy may be made without instruments by referring to the "Ohms Per Foot" marked on each wire spool label.

**CONTENTS:** 8 spools of assorted resistance wire, bobbins, fiber cards, eyelets, pigtail leads, emery paper, cerise wax and complete instructions.

JOBBER INQUIRIES INVITED



No. 200 Resistance Wire Kit  
List Price \$6.50; Net Price \$3.90



**CINEMA**  
ENGINEERING COMPANY  
1510 W. Verdugo Ave. Burbank, Calif.  
Cable Address: CINENG BURBANK

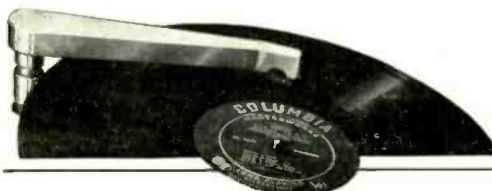

## Astatic FL-33 PICKUP FOR COLUMBIA MICROGROOVE RECORDS

● Here is no mere version of what a pickup for use with Columbia Microgroove Records should be—but the actual playing arm designed to meet the precise requirements of Columbia's new recordings. This new Astatic Pickup is manufactured to meet the specifications by Columbia, to insure maximum quality performance of the Columbia LP Microgroove Record. Available, then, in the Astatic FL-33 Pickup and LP-33 Crystal Replacement Cartridge, is the ultimate of Microgroove companion equipment... alone capable of getting the most out of LP Records.

ALSO AVAILABLE is the LP-78 Cartridge that fits the FL Arm, but having a .003" radius needle for playing 78 RPM Records.

**FL FILTER:** For best performance with high quality speakers. Controls pickup response—Eliminates high frequency peak.

## FEATURES OF ASTATIC'S FL-33 PICKUP

- 1 Five-Gram Needle Pressure;
- 2 Permanent Sapphire Needle with .001" Tip Radius;
- 3 Approximately One-Half Volt Output;
- 4 Frequency Range 30 to 10,000 c.p.s.;
- 5 Novel Design at Base Eliminates Tone Arm Resonances and Assures Perfect Tracking;
- 6 LP-33 Cartridge, with replaceable, permanent sapphire needle.

LISTED IN RADIO INDUSTRY RED BOOK

Astatic Crystal Devices Manufactured Under Brush Development Co. Patents



**SPECIAL PROBLEMS**  
demand  
**SPECIAL TREATMENT**

Engineering judgment is often the most important ingredient in the design and construction of apparatus for your specific needs. We specialize in—

— one-of-a-kind instruments for electronic or electro-acoustic measurements

— recording or reproducing systems with special characteristics

— subminiature audio for

Laboratory, Production Testing, Broadcast Station, Recording Studio, or Discriminating Home

**Audio Instrument Company**

1947 Broadway, New York 23, N. Y.

**FREE!** send for our  
**RADIO BUYING GUIDE**  
a complete and diversified line-up of:

- electronic equipment
- sound systems
- recording equipment
- amateur gear
- television components and kits
- replacement parts
- laboratory and service test equipment

Save time and money—buy direct from distributor! Consult the NEWARK radio buying guide, featuring all standard makes—a value-packed listing of 20,000 essentials for expert servicemen, engineers, soundmen, experimenters, teachers, hobbyists, amateurs!

**24 HOUR SERVICE ON ALL ORDERS**  
Free technical advisory service!

JUST MAIL THIS COUPON TO GET YOUR CATALOGUE  
Newark Electric Co., Inc., Dept. 21  
242 West 55th St., New York 19  
Please send me the FREE Newark Buying Guide of fine radio equipment.

Name \_\_\_\_\_  
Address \_\_\_\_\_  
City \_\_\_\_\_ State \_\_\_\_\_



3 GREAT STORES  
115 W. 45th St., 6712 Fulton St., NEW YORK  
and 323 West Madison Street in CHICAGO  
MAIL ORDER DIVISIONS  
242 West 55th Street, NEW YORK 19, N. Y.  
323 West Madison Street, CHICAGO 6, ILL.

**ADVERTISING INDEX**

Allied Radio Corp.....	56
Altec Lansing Corp.....	53
Arnold Engineering Co.....	5
Astatic Corporation, The.....	55
Atlas Sound Corp.....	51
Audio Development Co.....	3
Audio Devices, Inc.....	Cover 2
Audio Instrument Co.....	56
Brook Electronics, Inc.....	46
Burnell and Co.....	11
Camera Equipment Co.....	12
Chicago Transformer Corp.....	7
Cinema Engineering Co.....	55
Daven Company, The.....	Cover 3
Electro Motive Mfg. Co., Inc.	52
Electro-Voice, Inc.....	35
General Radio Company.....	9
LeBel, C. J.....	38
Magnecord, Inc.....	45
Maurer, J. A. Inc.....	10
Measurements Corp.....	43
Minnesota Electronics Corp.....	49
Newark Electric Co., Inc.....	56
Panoramic Radio Corp.....	46
Pickering & Co., Inc.....	41, 54
Presto Recording Corp.....	37
Professional Directory.....	38
Racon Electric Co., Inc.....	47, 56
Radio Corp. of America (Broadcast Equip. Div.)	Cover 4
Radio Corp. of America (Sound Equipment Div.)	26, 27
Rangertone, Inc.....	48
Reeves Soundcraft Corp.....	39
Scott, H. H. Inc.....	44
Shure Brothers, Inc.....	43
Simpson Electric Co.....	6
S.O.S. Cinema Supply Corp.	54
Sylvania Electric Products Inc.....	1
Tech Laboratories.....	53
United Transformer Corp.....	2
U. S. Recording Co.....	38
Vibration Systems, Inc.....	54
Ward Leonard Electric Co.....	54
Wells, Winston.....	38
Western Electric Co.....	12
Westfield Metal Products Co., Inc.....	44
W O R.....	54
Wrigley, William Jr., Co.....	40

**WANTED**

12 sets of ARC5 equipment as follows:  
R25 Receiver (1.5-3 mc.) MT7A Receiver  
Rack MT5 Receiver Base T18 Transmitter  
(2.1-3 mc.) MT69 Transmitter Rack MT68  
Transmitter Base MD7 Modulator DY8  
Dynamotor MT76 Modulator Base MT77  
Relay Base T17 Microphone HS33 Headset  
E39 Receiver local tuning knob PL152 Plug  
PL147 Plug PL151 Plug PL148 Plug 9377  
Plug. Box 90, Audio Engineering.

Introducing  
**Cellular Grand**  
by **RACON**

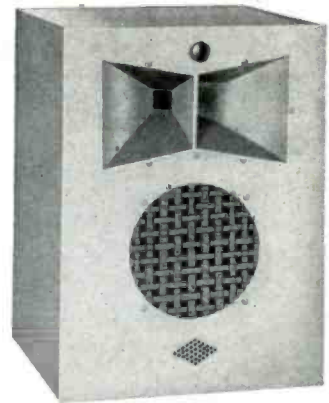

A HIGH FIDELITY reproduces that sets a new standard of efficiency in electro-acoustical conversion. Small enough to fit into the home console. Sound output ample for studio and industrial requirements. Has 120° horizontal angular dispersion. Special type cone speaker for low reproduction, and cellular speaker for wide angle coverage. High frequency response, and many other exclusive features. Frequency range 50 to 12,000 cps. Size 11"x15"x11" deep for 6 watt operations, size 15"x21"x12" deep for 20 watt operations.

Write for free catalog  
**RACON ELECTRIC CO., INC.**  
52 E. 19th St. N. Y. 3, N. Y.

**FREE**  
**ALLIED'S**  
**NEW 1949**  
**RADIO**  
**CATALOG**

Everything in Radio and Electronic Supplies  
Complete, Expert Service for Radio Engineers

You'll find everything you need in radio and electronic equipment for laboratory and development work, in the new 180-page ALLIED Catalog. Rely on one dependable source for the world's largest stocks—thousands of parts, tubes, tools, books, test instruments, sound apparatus—ready for instant expert shipment at lowest market prices. Write today for your FREE copy of ALLIED's newest Buying Guide.

**ALLIED RADIO**

ALLIED RADIO CORP., Dept. 17-K-8  
833 W. Jackson Blvd., Chicago 7, Ill.

□ Send FREE New ALLIED Catalog.

Name \_\_\_\_\_  
Address \_\_\_\_\_



# DAVEN

## ENGINEERING LEADERSHIP

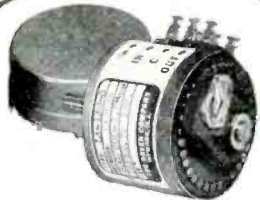

**MINIATURE ATTENUATOR — TYPE LA-130**  
30 STEPS — DIAMETER 1 3/4 INCHES

30 step ladder network, provided in a minimum of space . . . recommended for use in high quality equipment requiring a wide range of attenuation, where mounting space is limited.

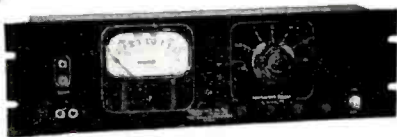

**FREQUENCY METER TYPE 838**

. . . frequencies read directly to 100,000 cycles with an accuracy of  $\pm 2\%$  of full scale in use . . . 7 ranges available . . . low input voltage requirements . . . large, easy-to-read illuminated meter . . . mounted on a 5 1/4" relay rack panel.



**TRANSMISSION MEASURING SET — TYPE 10A**

Direct reading instrument . . . meters and associated range controls can be used independently as VU meters . . . range +26 to -100 DBM . . . total attenuation 111 DB in steps of 0.1 DB.  
(Pat. Pend.)

Here are 4 of the more recent DAVEN "firsts". DAVEN long has been known for leadership . . . particularly in engineering and design. Many of our developments have been incorporated in the equipment of broadcasting stations, sound recording studios, and electrical laboratories throughout the world, and are specified as standard.

The DAVEN Engineering Department will be glad to discuss these new developments with you. Your inquiry is invited on the units shown or on any other DAVEN product.

THE

CO.

# DAVEN

191 CENTRAL AVENUE  
NEWARK 4, NEW JERSEY

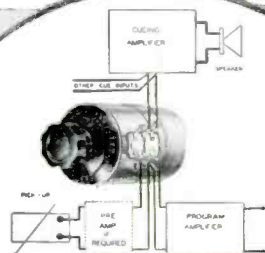

**ATTENUATORS WITH BUILT-IN CUEING CONTROLS**

. . . eliminate the need for auxiliary switching mechanisms . . . also available with built-in switchette for a pilot light . . . may be obtained on Ladder, "T", Potentiometer, and Ladder Fader controls.  
(Pat. Pend.)

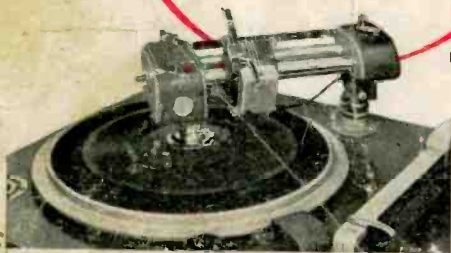
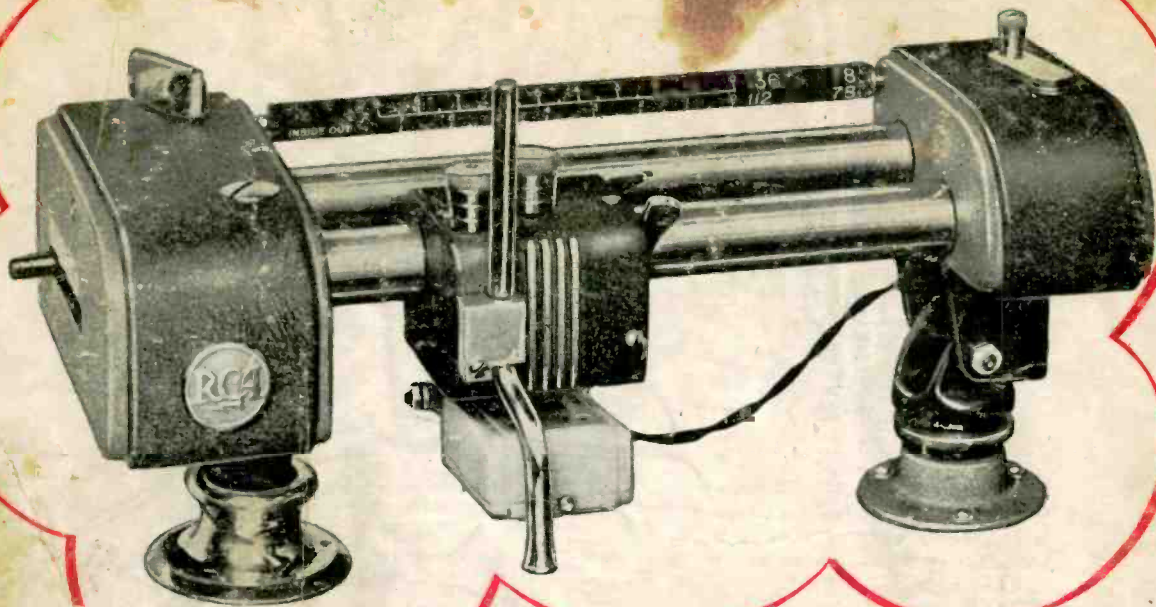

The RCA Recorder mounted on a Type 70-D1 turntable

... makes your RCA turntable  
a high-fidelity recorder  
*-inexpensively*

**T**HIS IS THE NEW improved-type studio cutter. It is designed specifically to give you instantaneous high-quality recordings with your present "70 Series" turntable—at surprisingly low equipment cost to you.

**It's uniquely flexible**—With this professional attachment you can record at 96, 112, or 136 lines per inch—and at speeds of  $33\frac{1}{3}$  or 78 rpm. You can record outside-in or inside-out—without changing gears or lead screw. You can adjust the stylus cutting angle and cutting depth during recording.

**It's simple to operate**—A new improved cam-operated lowering device helps you lower the cutter gently to the record . . . eliminates stylus damage and deep cuts caused by sudden dropping. A spiralling hand crank enables you to in-

sert space between recordings without breaking groove continuity. Plenty convenient, too, for making starting and finishing spirals.

**It's dependable**—No driver slippage or "knocks" . . . because power coupling is made to the center of your turntable through a vertical shaft spiral gear and a three-pin driving flange. No cutter carriage riding on the feedscrew . . . because the carriage is supported on a metal tube that encloses and protects the feedscrew. No groove grouping . . . because the head rides smoothly along a tubular enclosure that protects the feedscrew.

Here, we believe, is the finest cutter yet designed for high-quality studio recording . . . at modest cost. Type 72-D is complete with a standard head, mounting base, rest-post, and suction nozzle.

Type 72-DX is complete with high-fidelity recording head, mounting base, rest-post, suction nozzle, and compensator.

For prices and details, see your RCA Broadcast Sales Engineer, or write Dept. 7J, RCA Engineering Products, Camden, N. J.

#### SPECIFICATIONS

Input Impedance to Cutter . . . 15 ohms, nominal

Frequency Response:

type 72-D . . . . .  $\pm 3$  db, 50 - 7,500 cps  
type 72-DX . . . . .  $\pm 2$  db, 50-10,000 cps

Sensitivity (groove velocity 6.3 cm/spc. 0.00079" —peak to peak) at 1,000 cps:

type 72-D . . . . . +30 dbm (1.0 watt)  
type 72-DX . . . . . +30 dbm (1.0 watt)



**BROADCAST EQUIPMENT**  
**RADIO CORPORATION of AMERICA**  
**ENGINEERING PRODUCTS DEPARTMENT, CAMDEN, N. J.**

In Canada: RCA VICTOR Company Limited, Montreal