

# AUDIO ENGINEERING

MARCH  
1949

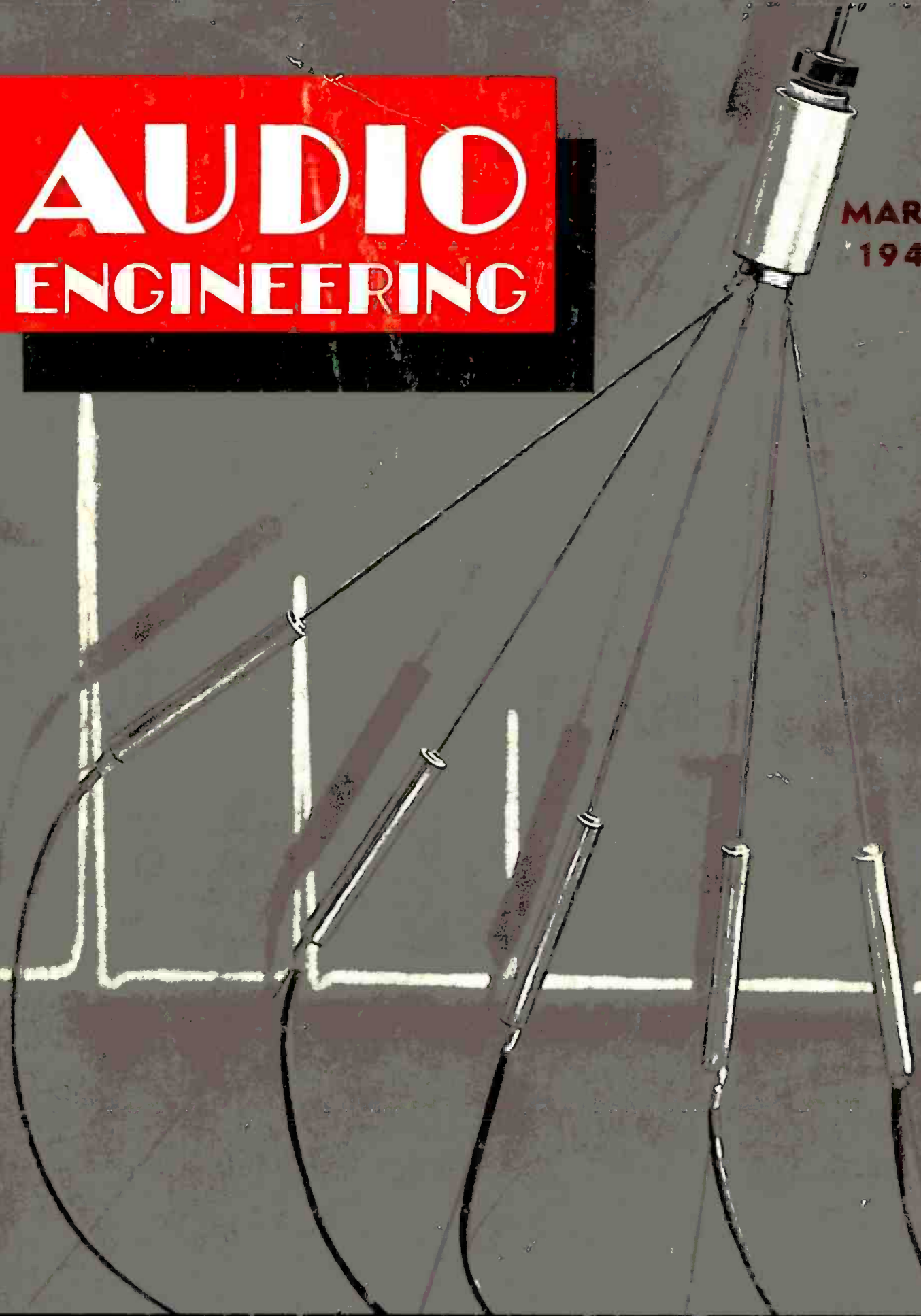

THE JOURNAL FOR SOUND ENGINEERS

# Which ingredient is the secret of **audiodisc**\* leadership?

1. NITROCELLULOSE
2. PLASTICIZERS
3. RESINS
4. OIL
5. DYE
6. SOLVENTS
7. MOISTURE RESISTING  
AGENT

THE FIRST SIX of these ingredients are to be found in *any* lacquer for professional discs. The seventh is an exclusive AUDIODISC development that provides permanent resistance to humidity. This, however, is a fairly recent improvement, and therefore does not account for the consistent uniform quality that has made AUDIODISCS the first choice of discriminating recordists for the past 10 years.

The "secret" lies not in any *one* ingredient, but in the correct selection, exact proportioning, and precise chemical control of *all* of them. In the ultra filtration, quality control, uncompromising inspection, and patented precision coating process. All of these factors, backed by continual research and exhaustive production testing, assure matchless recording quality in *every* AUDIODISC.

\*Reg. U. S. Pat. Off.

Audiodes are manufactured in the U. S. A. under exclusive license from PYRAL, S. A. R. L., Paris

**Audio Devices, Inc., 444 Madison Ave., N. Y. C.**

EXPORT DEPT.: ROCKE INTERNATIONAL, 13 EAST 40TH ST., NEW YORK 16, N. Y.

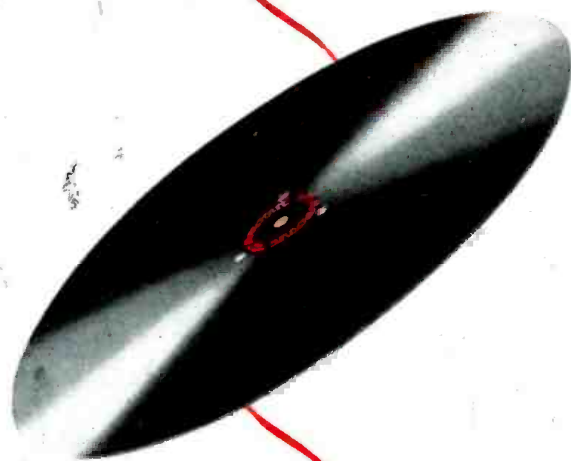

*they speak for themselves*

**audiodes**

**CITIZENS RADIO  
TRANSCIVER USES**

*Sylvania  
sub-miniature  
tubes!*



The farmer in the field and his wife at home will be able to converse with ease by using these new, lightweight transceivers equipped with Sylvania sub-miniature tubes!



Tiny Sylvania sub-miniature radio tubes, smaller than a lady's little finger, are big reasons why the Citizens Radio Transceiver measures only 6" long, not quite 3" wide, 1 1/4" deep, and weighs only eleven ounces!

Sold in sets of two, these tiny two-way transceivers with a range of several miles are tuned to 465 mc. Among the many who want these handy units are police and fire departments, surveyors, farm-

ers, hunters, industrial users, rangers and those who wish boat-to-home and auto-to-home communications.

Sylvania's extensive radio tube research and manufacturing skill have made Sylvania sub-miniature tubes the choice of Citizens Radio Corporation, Cleveland, for this revolutionary, civilian transceiver. Sylvania Electric Products Inc., Radio Tube Division, Emporium, Pennsylvania.

# SYLVANIA ELECTRIC

RADIO TUBES; CATHODE RAY TUBES; ELECTRONIC DEVICES; FLUORESCENT LAMPS; FIXTURES; WIRING DEVICES; LIGHT BULBS; PHOTOLAMPS

EL-MENCO CAPACITORS

# Leaders



Leaders because they perform reliably under all operating conditions, these fixed mica dielectric capacitors are used in electronic applications wherever long life and successful performance are demanded.

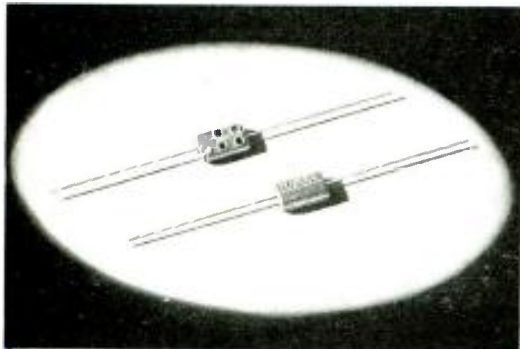

### CM 15 MINIATURE CAPACITOR

Actual Size  $\frac{3}{8}$ " x  $\frac{1}{2}$ " x  $\frac{3}{16}$ "  
For Radio, Television and Other  
Electronic Applications  
2 to 420 mmf. capacity at 500v DCA  
2 to 525 mmf. capacity at 300v DCA  
Temp. Co-efficient  $\pm 50$  parts per  
million per degree C for most  
capacity values  
6-dot standard color coded

Each tiny El-Menco Capacitor must pass life and humidity tests; meet standards set by the United States Army and Navy; pass tests at double their working voltages; prove their dielectric strength, temperature co-efficient and capacitance drift, and have their insulation resistance double-checked. These little leaders are molded in low-loss bakelite and wax-dipped for salt water immersion seal. They're available in a wide range, all impregnated, all precision-made, all JAN, RMA and RCM color-coded.

*Why not protect your product's performance with capacitors made under these rigid conditions?*

Specify **EL-MENCO**  
TESTED • RELIABLE • LEADERS!

THE ELECTRO MOTIVE MFG. CO., Inc.  
WILLIMANTIC CONNECTICUT



Write on your firm letterhead for Catalog and Samples

# MOLDED MICA **EL-MENCO** MICA TRIMMER CAPACITORS

FOREIGN RADIO AND ELECTRONIC MANUFACTURERS COMMUNICATE DIRECT WITH OUR EXPORT DEPT. AT WILLIMANTIC, CONN.  
**ARCO ELECTRONICS, INC.** 135 Liberty St., New York, N. Y.—Sole Agent for Jobbers and Distributors in U.S. and Canada



Successor to **RADIO**

John H. Potts, Editor and Publisher

C. G. McProud, Managing Editor S. L. Cahn, Adv. Director

Lawrence LeKashman, Asst. Editor H. N. Reizes, Adv. Mgr.

Louisa B. Dresser, Edit. Prod. Mgr. L. J. Devine, Circ. Mgr.

Editorial Advisory Board

- Howard A. Chinn
John D. Colwin
C. J. LeBel
J. P. Maxfield
George M. Nixon
Winston Wells
S. Young White

Representatives

- Sanford R. Cowan, Mid-West Sales
342 Madison Ave., New York 17, N. Y.
James C. Galloway
816 W. 5th St., Los Angeles 13, Calif.
Dale International Publications, Ltd.
105 Bolsover St., London W. 1, England
Harris & Floyd, 297 Swanston St.
Melbourne C. 1, Victoria, Australia

Established 1917

CONTENTS

MARCH, 1949

Vol. 33, No. 3

Table listing contents: Editor's Report (4), Characteristics of the New 15 RPM Record (6), Audio Technique in Television Broadcasting (9), A Versatile Phonograph Preamplifier (14), Compact 6AS7G Amplifier (17), Experimental Ultrasonics (20), Problems in Audio Engineering (23), WMGM Master Control Equipment Design (21), Record Revue (30), New Products (32), Advertising Index (48)

COVER

Array of springs driven by magnetostriction pulse generator feeding a 10 microsecond pulse into 5 individual pickups. Oscillograph screen pattern shows echoes as they occur when the output of the pickups is fed into the amplifier. This extraordinary photo was made by Winston Wells.

AUDIO ENGINEERING (title registered U. S. Pat. Off.) is published monthly at New York, N. Y., by Radio Magazines, Inc., J. H. Potts, President; Lawrence LeKashman, Vice Pres. Executive and Editorial Offices at 342 Madison Avenue, New York 17, N. Y. Subscription rates—United States, U. S. Possessions and Canada. \$3.00 for 1 year, \$5.00 for 2 years; elsewhere \$4.00 per year. Single copies 35c. Printed in U. S. A. All rights reserved. Entire contents copyright 1949 by Radio Magazines, Inc. Entered as Second Class Matter July 29, 1948 at the Post Office, New York, N. Y., under the Act of March 3, 1879.

# EDITOR'S REPORT

---

## ONE PICKUP FOR ALL RECORDINGS

**O**N THE HEELS of the discussion about various speeds for phonograph records comes the thought that two different pickups, or their equivalent, are required to reproduce the now existing types of recordings. Comparing the grooves used in the present three systems, it is obvious that the angle between the side walls remains the same, and the only apparent difference is in the tip radius of the cutting stylus. While a standard 3-mil reproducing stylus cannot be used on the fine grooves, there is no reason why the 1-mil microgroove stylus should not be able to follow the standard groove successfully if the tip radius of the recording stylus, about .25 mil, is maintained at approximately the same value for both types of recording. This idea is expounded more completely by "Stylus" in the article commencing on page 6.

Some experimental work has been done with the sharper stylus on standard-pitch acetate recordings, with an appreciable improvement in frequency response and over-all performance. Needless to say, a change in the recording stylus dimensions would not immediately alleviate the problem of the user, but as existing recordings are withdrawn and worn-out records replaced by those cut with the suggested stylus, it would some day be possible to play all records with a single pickup and stylus. It would, of course, be necessary to change the needle pressure for the finer groove, but this is simple to do.

## OUR NEW COVER

The new design on our cover and masthead is the work of Mr. Fred Walworth, Audio Facilities Engineer of the American Broadcasting Company in New York. Mr. Walworth, a serious student of industrial design in his spare time, pointed out that our old design was not in keeping with modern principles, and offered the new one

on his own hook and entirely without solicitation. We hope the new appearance pleases our readers as much as it did us.

## MORE AUDIO FALLACIES

In talking with W. S. Barrell, technical director of EMI, who is presently visiting this country, the matter of wide frequency range in recording was brought up. Many have wondered, he tells us, why he records up to 20,000 cycles in his HMV studios, far higher than normal hearing range. According to their tests, the ear notes a difference in a complex tone if the reproducing system is limited to a lower frequency, even if the listener cannot hear a pure tone of much lower pitch. Just why this is so will be discussed in an article now in preparation.

We believe a more thorough understanding of the nature of hearing and the manner in which the ear functions will do much to clarify our thinking in designing sound-reproducing apparatus. The familiar argument, "What's the use of going to the trouble and expense of making really fine, high-fidelity apparatus when no one can hear over such a wide range?" needs a lot of clarification. This, we are convinced, can only be done by starting all over again along the lines which Maxfield has preached, basing our thought on the results of subjective tests. There seems to be more faulty reasoning about audio engineering than in other branches of electronic engineering. In other words, many "sound" ideas are fundamentally unsound.

Our book division is now preparing for publication three books in the sound field. One will cover in detail from an engineering standpoint, disc, wire, and tape recording. The other two will deal with audio equipment design and operation of audio equipment. A more detailed announcement will appear in our next issue.

**ANNOUNCING...**  
**"Three-Sixty" Hypex**  
**PROJECTORS**



**MODEL VR-11 "THREE-SIXTY" HYPEX**  
 (above) 15 WATTS, 280 CPS CUT-OFF.  
**MODEL VR-241 "THREE-SIXTY" HYPEX**  
 (at right) 25 WATTS, 140 CPS CUT-OFF.

**T**WO new Hypex\* Projectors—designed for 360-degree sound dispersal—are now available. With sound distributed horizontally in all directions, these new models are intended for installations where coverage of relatively large areas and suspension from the ceiling are desired. Like all Hypex Projectors, these radial units incorporate the famous Hypex formula† which results in improved acoustic performance.

By the addition of the two radials to the four previously announced Hypex units illustrated below, the Hypex line now includes a model for every "sound" need, indoors or outdoors.

**Jensen**  
*Hypex*

**JENSEN MANUFACTURING COMPANY**

Division of the Muter Company

6633 SOUTH LARAMIE AVENUE, CHICAGO 38, ILLINOIS

In Canada:

COPPER WIRE PRODUCTS, LTD., 351 CARLAW AVENUE, TORONTO

\*Trade Mark Registered †Patent 2,338,262

Write for Data Sheet 143



**MODEL VH-24 HYPEX**  
 25 WATTS, 110 CPS CUT-OFF



**MODEL VH-20 HYPEX**  
 25 WATTS, 140 CPS CUT-OFF



**MODEL VH-15 HYPEX**  
 15 WATTS, 180 CPS CUT-OFF



**MODEL VH-91 HYPEX**  
 15 WATTS, 300 CPS CUT-OFF



LIST PRICE  
\$6750



Multi-Impedance Switch  
for Low, Medium or High  
Impedance.

*Each* OF THESE MICROPHONES  
HAS THE **SUPER-CARDIOID**  
PICKUP PATTERN THAT  
REDUCES FEEDBACK BY **73%**

## THE FAMOUS "55" UNIDYNE DYNAMIC

**Unidirectional Microphone.** This superlative dynamic microphone is a Multi-Impedance Microphone—you can have either High, Medium, or Low Impedance simply by turning a switch! Because it is a Super-Cardioid, the "Unidyne" kills Feedback energy by 73%—making it possible to use under the most difficult acoustic conditions. The "Unidyne" is probably the most widely used microphone throughout the world. Recommended for all highest quality general-purpose uses.



LIST PRICE  
\$3975

## THE NEW "737A" MONOPLEX CRYSTAL

**Unidirectional Microphone.** The "Monoplex" is the *ONLY* Super-Cardioid Crystal Microphone made. As such, it is undoubtedly the finest of all crystal microphones. (A comparative test will prove this statement convincingly.) The "Monoplex" employs the same type of acoustic phase-shifting network used in the highest cost Shure Broadcast Microphones. Has "Metal Seal" crystal—will withstand adverse climatic conditions. Can be used in those applications where severe background noise would make conventional microphones practically useless!

Licensed under patents of Brush Development Company. Shure patents pending.

**SHURE BROTHERS, Inc.**

Microphones and Acoustic Devices



225 West Huron Street, Chicago 10, Illinois • Cable Address: SHUREMICRO

## Characteristics Of The New 45 RPM Record By "Stylus"

**T**HERE has been widespread interest in the new 45 rpm RCA Victor record, often called "Madame X" or "X." A complete lack of official technical information has hindered public acceptance. Much of the unofficial information floating around in non-recording circles has been wildly inaccurate. Record manufacturers, radio-set designers, and record-changer manufacturers have received a certain amount of accurate information, which we have pooled to prepare this discussion.

### What it is

"X" is an attempt to develop a more compact, lower-cost record of higher quality than the ordinary shellac type. It is aimed chiefly at the popular market—which includes 80% of all disc sales.

The record is rather thin, 7 inches in diameter, and made of unfilled vinylite. The center hole is 1½ inches in diameter, and the label is surrounded by a raised plateau which keeps the recorded surfaces out of contact and free from scratches. The maximum playing time is about 5 minutes, but 3-minute records are made with the same diameter. The stop groove is concentric with the center. The price will be about ten cents less than that of a conventional shellac of the same playing time. The groove has an included angle of 83 degrees and a radius of about .25 mil; it can be played by the same recording stylus as used for LP, one with a tip radius of .9 to 1 mil.

### How it is Used

The large center hole is designed to permit the use of a new record changer design. The record stack is carried on a 1½-inch diameter center spindle, and there are no knife blades to support the outer edges. The center spindle contains most of the changing mechanism. The entire changer is therefore ultracompact—it will fit in the palm of your hand. The concentric stop groove permits the use of a lower-cost, faster-trip mechanism. As a result, the changing cycle is very rapid: The cycle itself takes about 1½ seconds. The entire changing time is longer than this by the time to play the lead-out and lead-in grooves, so that observers have checked the total at three to four seconds. The simplicity of the mechanism leads to much lower cost—a list price of about twenty-five dollars.

*[Continued on page 46]*



**MEASURE TOTAL DISTORTION**  
Between 20 cps and 20 kc



# 330B DISTORTION ANALYZER

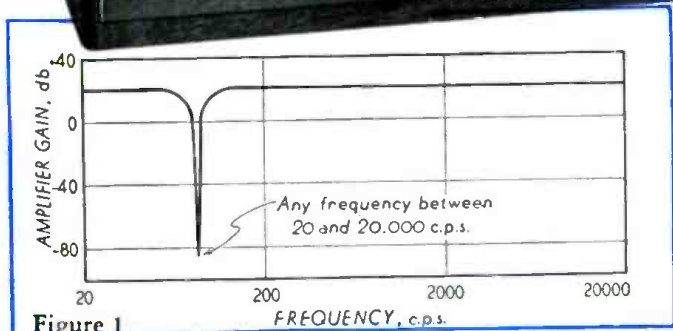

Figure 1

## CHECK THESE SEVEN IMPORTANT FUNCTIONS:

1. Measures total audio distortion.
2. Checks distortion of modulated r-f carrier.
3. Determines voltage level, power output.
4. Measures amplifier gain and response.
5. Directly measures audio noise and hum.
6. Determines unknown audio frequencies.
7. Serves as high-gain, wide-band stabilized amplifier.

This fast, versatile *-hp-* 330B Analyzer measures distortion at *any* frequency from 20 cps to 20 kc. Measurements are made by eliminating the fundamental and comparing the ratio of the original wave with the total of remaining harmonic components. This comparison is made with a built-in vacuum tube voltmeter.

The unique *-hp-* resistance-tuned circuit used in this instrument is adapted from the famous *-hp-* 200 series oscillators. It provides almost infinite attenuation at one chosen frequency. All other frequencies are passed at the normal 20 db gain of the amplifier. Figure 1 shows how attenuation of approximately 80 db is achieved at any pre-selected point between 20 cps and 20 kc. Rejection is so sharp that second and higher harmonics are attenuated less than 10%.

### Full-Fledged Voltmeter

As a high-impedance, wide-range, high-sensitivity vacuum tube voltmeter, this *-hp-* 330B gives precision response flat at any frequency from 10 cps to 100 kc. Nine full-scale

ranges are provided: .03, .1, .3, 1.0, 3.0, 10, 30, 100 and 300. Calibration from +2 to -12 db is provided, and ranges are related in 10 db steps.

The amplifier of the instrument can be used in cascade with the vacuum tube voltmeter to increase its sensitivity 100 times for noise and hum measurements.

Accuracy throughout is approximately  $\pm 3\%$  and is unaffected by changing of tubes or line voltage variations. Output of the voltmeter has terminals for connection to an oscilloscope, to permit visual presentation of wave under measurement.

### Measures Direct From R-F Carrier

The *-hp-* 330B incorporates a linear r-f detector to rectify the transmitted carrier, and input circuits are continuously variable from 500 kc to 60 mc in 6 bands.

Ease of operation, universal applicability, great stability and light weight of this unique *-hp-* 330B Analyzer make it ideal for almost any audio measurement in laboratory, broadcast or production line work. Full details are immediately available. Write or wire for them—today Hewlett-Packard Company, 1437L Page Mill Road, Palo Alto, Calif.



Noise and Distortion Analyzers	Wave Analyzers	Frequency Meters
Audio Frequency Oscillators	Audio Signal Generators	Vacuum Tube Voltmeters
Amplifiers	Power Supplies	Attenuators
Square Wave Generators	UHF Signal Generators	Electronic Tachometers
	Frequency Standards	

Wherever you Employ Magnets,  
Check with us on the  
Advantages of using

# ARNOLD

## PERMANENT MAGNETS



As electrical constituents go, permanent magnets are relatively new. They made tremendous advances within the past decade, especially in the communications and aviation industries, and in the general fields of instruments, controls, meters and mechanical holding devices.

Many of these uses were problems that just couldn't be solved until permanent magnet materials were developed to do the job—a work of pioneering to which Arnold contributed a heavy share. Many other applications were those where permanent magnets supplanted older materials because of their inherent ability to save weight, size and production time, as well as greatly improve the performance of the equipment.

To these advantages, Arnold Permanent Magnets add another very important value—standards of quality and uniformity that are unmatched within the industry. Arnold Products are 100% quality-controlled at every step of manufacture. What's more, they're available in all Alnico grades and other types of magnetic materials, in cast or sintered forms, and in any shape, size or degree of finish you need.

Let's get our engineers together on *your* magnet applications or problems.

### THE ARNOLD ENGINEERING CO.



Subsidiary of

**ALLEGHENY LUDLUM STEEL CORPORATION**

147 East Ontario Street, Chicago 11, Illinois

*Specialists and Leaders in the Design, Engineering and Manufacture of PERMANENT MAGNETS*

W&D 1296



View in WCBS-TV studio of the CBS network in New York.

# AUDIO TECHNIQUE

## *In Television Broadcasting*

R. H. TANNER\*

How TV audio technique differs from other sound pickup methods.

AN VIEW of all the exciting newness of results, circuitry and general technique, it is only natural that the video side of television has been the subject of innumerable articles during the past few years, while the problems of producing the very necessary sound program which accompanies and clarifies the picture has received little publicity. In fact, it is probable that few people, whether engineers or not, unless they are intimately connected with television, realize that TV audio presents problems often very different from those encountered in either straight sound broadcasting or in motion picture recording. Experience gained in the world's first public television service (in England prior to World War II) indicates that even in the studios themselves there are often many, principally concerned with the visual side of the business, who are apt to write off the activities of the sound staff as a necessary evil, the application of a known art, without the experimental and pioneering interest which is so obviously a part of video work. In actual fact, nothing is fur-

ther from the truth and this article is intended to survey this comparatively new audio field and to point out its difficulties, challenges and possibilities.

### Differences in Technique

First then, it must be pointed out briefly how the technique of TV audio differs from the older and more established arts of sound broadcasting and motion picture recording. In the broadcast studio, the microphone is all important and the entire energies of engineers, artists and producer are concentrated in obtaining a final sound output which interprets, as fully as possible, the producer's ideas. Any number of microphones may be used, in one or more studios, and actors, musicians and other sources of sound may be arranged and grouped with no regard whatever to the visual effect, but solely with a view to producing the desired aural result.

In motion picture recording, the situation is very different. As in television, the visual arrangement of actors, scenery, etc., becomes paramount, and the microphone has to

compete for position with cameras, lamps and so on. Except on rare occasions, it must not appear in the picture nor must its shadow be cast on the scene. But sound film engineers have several great advantages over their television counterparts. Firstly, it is the established practice in motion picture studios to record the action in short sequences lasting from a few seconds for a few minutes, and ample time is allowed for determining the best position for a fixed microphone, or for rehearsing the movements if a travelling shot is required. In the same way, time is available for the inevitable arguments between sound staff and lighting engineers on the subject of microphone shadows, with more hope of arriving at a satisfactory compromise solution. It is interesting to note that an average of three minutes of finished film per day of shooting is considered good going, whereas the staff of a television studio will probably have to produce at least one and a half hours of finished program a day, and their efforts will certainly have to stand comparison with the movies at the viewer's local theatre.

\*Audio Equipment Engineer, Northern Electric Co., Ltd., Belleville, Ont., Canada.

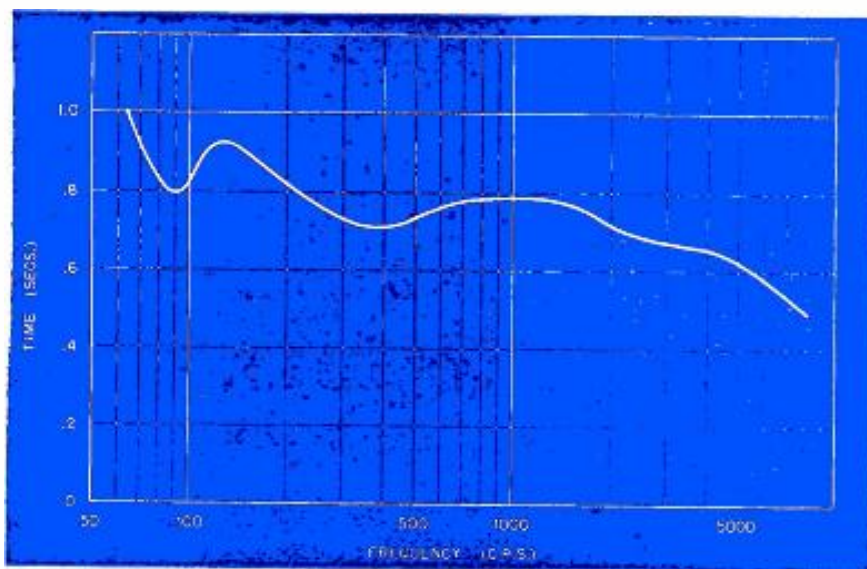

Fig. 1. Measured reverberation time vs. frequency curve of Studio A, London TV Station.

Secondly, the techniques of pre- and post-recording have reached a very high standard of perfection, and enable good results to be achieved which would be quite impossible if the sound were recorded at the same time as the scene is photographed. In general, therefore, the motion picture engineer has much more time at his disposal both during the shooting of the film and its subsequent editing.

On the other hand, the difficulties which beset the TV audio engineer are many and varied. As in the movie studio, he is competing for space with many others, except that the available space is usually even more restricted. Owing to the continuous nature of a television performance, he has no "dead" time at all in which to make adjustments once the program has started. For the same reason, lighting compromises must be achieved during the all too short rehearsal period before transmission. Obviously the microphone must be more mobile than in a motion picture studio, and the appearance "in shot" of either itself or its shadow must be avoided by a continuous display of skill on the part of the operator. This is but one of the many problems presented to the TV sound engineers; many others will emerge later in this article.

#### Acoustics of Television Studios

For both economic and technical reasons, television studios cannot be provided in such numbers, nor with such a variety of sizes and characteristics, as broadcasting studios. Thus, the London Television Station has only two, both of which are virtually identical in size and equipment. This means that all programs are

produced under the same acoustic conditions, except insofar as the properties of the studio may be affected by scenery, screens or variable wall treatment. Since it is certain that at some time or another the characteristics of a small living room must be simulated, it must be possible to make the studio practically dead, which in the absence of very elaborate means for varying the acoustics, sets a limit to the maximum reverberation achievable, without recourse to such devices as echo rooms. The measured reverberation vs. frequency curve for Studio A is reproduced in Fig. 1, from which it will be seen that the maximum reverberation time of about 1 second occurs at low frequencies, the curve showing a gradual decrease in reverberation as the frequency is increased until at 8000 c/s the period has dropped to 0.5 second.

Another fundamental difficulty may be explained by reference to Fig. 2, which shows a plan view of the same studio. In general, especial-

ly when a program was accompanied by an orchestra "off-stage", the orchestra was placed at the Control Room end, while action took place at the other. This suggests that the Control Room end should be made live and the other end more or less dead, to provide good acoustic conditions for the music. On the other hand, on occasions when the orchestra itself is televised, it will occupy the other end of the studio and exactly the reverse will hold good. In addition, it would be a disadvantage during the performance of plays to have the control room end live, since this is then the region where most of the unwanted studio noise originates, and reverberation will tend to reinforce it.

It will be seen, therefore, that a television studio should be able to provide many different acoustic characteristics. Scenery is, in general, of little assistance as it is deliberately made as light and non-rigid as possible in order to facilitate handling. It will not therefore contribute very much to the room acoustics except at the higher frequencies where it will add to the dispersion and absorption. It would seem that some form of variable acoustic treatment is required, so that not only can the reverberation time of the studio as a whole be altered, but different areas can be made live or dead as required. Experience with acoustic screens in ordinary sound studios suggests that television scenery might, with advantage, be so designed as to provide a suitable acoustic, as well as scenic, effect. Such scenery, however, would demand considerable skill in handling to give the effect desired.

One method of dealing with this problem which is attractive at first sight, is to make the studio as dead as possible and add all the reverberation required by means of an echo



Fig. 2. Plan view, Studio A, London Television Station.

room. This method is in use to some extent in the United States but has several disadvantages. Firstly, a dead studio is most depressing to actors, musicians and staff, and would almost certainly tend to reduce the standard of performance. Secondly, it is often not fully realized that the use of an echo room of long period cannot give the same result as a studio of shorter reverberation time, no matter what proportion of echo is mixed with the direct sound. This is illustrated in Fig. 3. Curve (a) shows an idealized decay of sound in a normal studio. The steady sound at a level  $OA$  is cut off at point  $B$ . The sound reaching the microphone direct disappears as indicated by the drop  $BC$  and the reverberent sound dies away along the line  $CD$ . Changes in reverberation time will alter the slope of the line  $CD$  as shown by  $CD'$ . In the case of the dead studio and echo room the decay is as shown in Curve (b). When the sound is cut off, the drop in level,  $FG$  is far greater than the corresponding drop  $BC$  if the total time of decay to some arbitrary zero level is to be kept the same. This must be so since the rate of decay in the echo room, as given by the slope of the line  $GH$ , is much smaller than the corresponding rate in the live studio (given by the slope of  $CD$ ). The slope of  $GH$  is fixed by the design of the echo room and the only control available is the proportion of echo to direct sound. An increase in this proportion will give some such decay curve as  $EFJK$ .

What would really be required, then, is a whole series of echo rooms, or sources of synthetic reverberation, possessing a range of acoustic properties. The one which simulates most closely the conditions under which the action is supposed to be taking place would then be selected and made available to the sound control engineer, who would alter the amount of added reverberation to correspond to the length of visual shot. Thus, for close-ups, little or no added echo would be needed, while for long shots the amount would be increased. The provision of, say, five echo rooms would occupy considerable space. However, if a satisfactory electrical or electro-mechanical system could be devised to perform the same function, a valuable saving might be possible.

One further question which must be considered under the subject of acoustics is the desirability of providing a studio purely for sound purposes, comparable with the sound

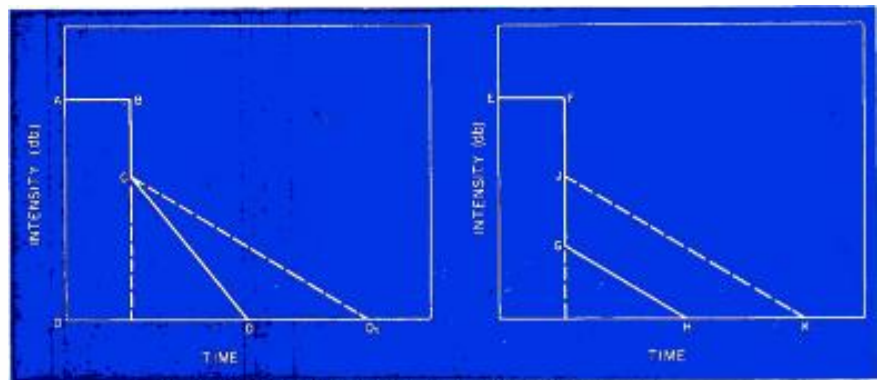

Fig. 3. In curve (a), left, idealized decay of sound in normal studio is shown. Curve (b), right, shows decay when echo room is used with dead studio.

recording stages used in the film world. This would have characteristics suitable for the size of orchestra normally used for accompanying television programs, and the conductor would be provided with headphones and a viewing screen to keep him in touch with the vision studio. This technique was occasionally used in Britain before the war, when one of the two studios was used for vision and the other for the orchestra.

#### Microphones and Microphone Technique

The main differences in microphone technique, as compared with broadcasting and film work, which the requirements of television demand, have already been outlined in the introduction. In general, it is difficult to work with the microphone as close to the performers as is desirable while keeping both the microphone and its shadow out of the picture. In this respect, matters are made worse by the fact that lighting arrangements are set for the duration of the scene and cannot, as a normal rule, be altered for individual shots in order to avoid shadows.

Apart from these mechanical difficulties, the sound engineer is al-

ways faced with the problem of ensuring that his sound matches the picture. In normal broadcasting, a whole scene between two people may be played with the actors and the microphone in the same relative positions. In television, unless the scene is very short, it will be necessary to change the view point at fairly frequent intervals by switching from one camera to another. Ideally, whenever this occurs, the sound should change as well. In practice this will usually happen only when the change of view point is considerable, as for example, when going from close-up to long shot. In this case, the change in sound is more or less automatic owing to the necessity for withdrawing the microphone out of shot before the cameras are changed.

A rather less obvious example is illustrated in Fig. 4, in which the two characters  $A$  and  $B$  are engaged in conversation. Two cameras 1 and 2 are in use alternately to give a varying viewpoint. It might be thought that, at such close quarters, the position of the microphone is unimportant, and that some such position as indicated by Mic. 3 would suffice, no matter which camera was

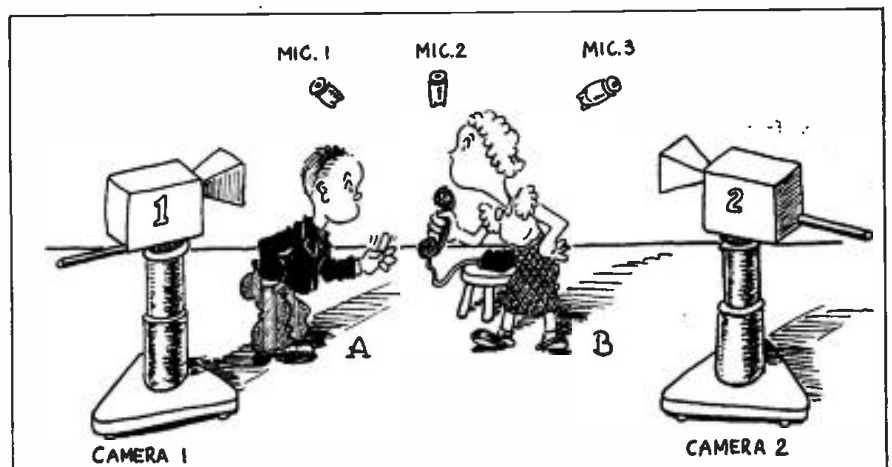

Fig. 4. Pictorial representation of microphone placement.

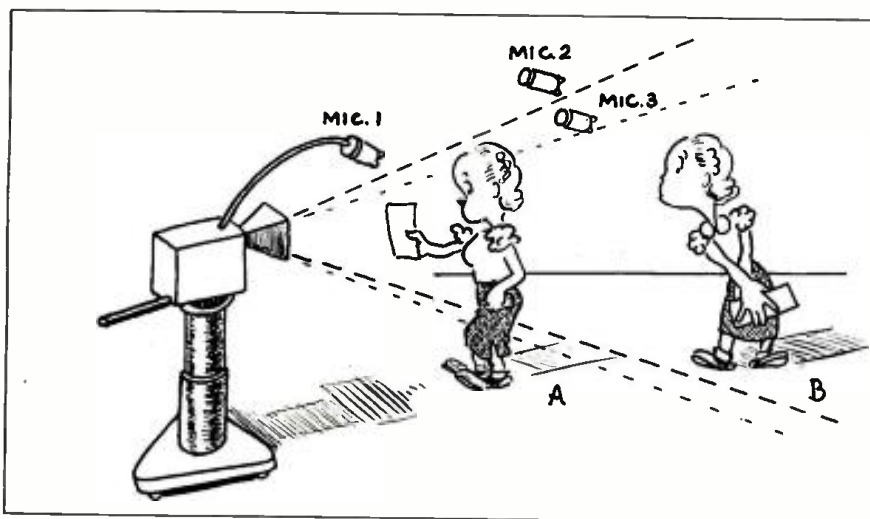

Fig. 5. Microphone placement for best signal-to-noise ratio. (See text.)

in use. This, however, ignores the polar diagram of the human head, which at the higher frequencies become quite sharp. When Camera 1 is being used, *B* is facing the camera while *A* has his back to it. Thus *B*'s speech should be crisp and clear, while *A*'s should be slightly but distinctly muffled. Changing to Camera 2 reverses the position. Unimportant as this difference may seem, for optimum results the operator should swing the microphone between positions 1 and 2 in step with the camera mixes.

Many other examples of the need for acoustic perspective might be quoted, in which the right effect helps the picture to tell its story, while the wrong one destroys the illusion. In televising dance bands, or musical scenes in general, an effort should be made to emphasize slightly the sounds made by the instrumentalists or singers actually appearing in the picture. Many movies appear to ignore this principle and present complicated angle shots of various sections of a band, the effect of which is greatly marred by the fact that the sound viewpoint remains fixed. In general, it may be said that the attention paid to sound perspective in motion pictures varies very greatly from one to another, so that in this field, as in others, television might well lead the way. In this connection it is interesting to compare what has been said above with a description of the problems encountered in foreign language synchronization of films. (See References at end of article.)

Figure 4 suggests that a microphone might be mounted on each camera so that it is just out of the line of shot, and that camera and microphone mixing might be syn-

chronized automatically. Figure 5, however, shows this to be a fallacy. The microphone position 1 is very suitable for close ups (Artist *A*) but in the case of the long shot (Artist *B*) a much better position from the point of view of signal-to-noise ratio can be found, as shown by position 2, or if as would normally happen the camera "pans down" somewhat, position 3 would be better still.

With the microphones in use in Britain before the war, the maintenance of a great enough signal-to-studio-noise ratio was always a problem. The essential presence in the studio of cameramen and their assistants, sound operators, electricians, make-up staff, scene shifters, etc., cannot fail to raise the level of background noise far above the value which would be thought normal for a broadcast studio. It would seem that the best solution to this problem is a unidirectional microphone, because in general, the unwanted noise comes from the side of the microphone remote from the players. In addition, unidirectional microphones would tend to reduce cross pick-up, that is, for example, pick-up of the orchestra on the soloist's microphone and vice versa. It would probably help also in the problem of maintaining the balance in a musical comedy between a singer moving about the set, at varying distances from the camera, and a stationary orchestra, since it could be worked at a greater distance from the singer while still providing the necessary voice-to-accompaniment ratio. Small variations in this distance will then have less effect.

Another essential requirement for the microphone which is to be used on the "boom" is that it should be possible to move it fairly rapidly

through the air without giving rise to rumbles. This would appear to put velocity microphones at a disadvantage, although they are used, in various forms, in U.S. television studios. A distinction may, however, be made between the type of microphone used on the boom, which will in general have to deal only with speech, solo singing, or possibly emphasis of soloists in dance band programs, and the type of microphone which is slung in a fixed position for orchestral programs, etc. This distinction was, in fact, made in England before the war, when pressure microphones were used on the boom, and velocity microphones slung for the stationary pick-up purposes. In addition, it would normally be permissible to insert a certain amount of low-frequency attenuation in circuits with moving microphones without any appreciable deterioration in quality, since the sources mentioned above for which a moving microphone is used are not rich in the lower frequencies. Even the microphone used to emphasize soloists will normally be mixed with a stationary one giving a general balance of the band or orchestra, and the emphasis or definition is conveyed mainly, if not entirely, by the higher frequencies, so that attenuation of the bass is again permissible.

#### Concealed Mikes

On various occasions, when visual difficulties make it impossible to adhere to the normal technique, it becomes necessary to resort to concealed microphones. Our experience is that these are seldom successful, since they are inevitably placed in close proximity to a variety of objects, all of which play havoc with the resulting acoustic effect. Therefore, such concealment should only be employed under the most extreme pressure of circumstances, or perhaps to cover a very short interval needed to swing the boom from one set to another. Even in this last instance, it is unconvincing to open a scene with one tone quality and then, a second or two later, to replace it with another.

It would seem that the technique of pre-recording, which has already been mentioned briefly, would be of great help to the television sound engineer. The requisites are a good sound studio, and an excellent recording system. In the motion picture world, pre-recording is used for nearly all complicated musical scenes, in which the action may be photographed many times from a

wide variety of distances and angles. The sound is recorded first, usually on vertically cut discs, and replayed onto a loudspeaker during "shooting," so that the cast may synchronize their movements to the sound. Then when all the required shots have been taken, the director can decide on the method in which they shall be "cut" and pieced together to form the final sequence. Lastly, the sound will be recorded onto film in such a way that it matches the picture. It is at this stage that the careful sound engineer will introduce artificial reverberation into the sound accompanying the longer shots, and so adjust his volume levels as to suggest a sound perspective in agreement with the picture.

In television, the technique could be very similar, except that, of course, the marriage of sound and picture would have to take place at the moment of transmission, and that the continuous nature of the television programme would again make heavy demands upon the skill of the sound staff. Great importance would have to be attached to the performance of the recording system used, since it should be impossible to detect in the listener's home whether or not a recording is being used. In view of the wide audio-frequency range transmitted, it is doubtful if any existing system would be really satisfactory but developments in sound recording systems should soon enable this condition to be met. In addition, very great care would have to be taken, to ensure that the quality and acoustic characteristics of the recorded sound agreed closely with the live sound immediately preceding and following the record, unless, of course, there was a change of scene. The arrangement for playing the record back into the studio, to secure synchronization, in such a way as to avoid the possibility of howl-back when the studio microphone is faded up, is already well established and was in fact in use in England before the war.

#### Other Sound Sources

Quite apart from the possible use of pre-recording, the standard disc, whether a commercial pressing or direct recording, is so valuable a source of incidental music or sound that its use must be tolerated in spite of the ease with which, at present, such use may be detected by the listener. It would obviously add vastly to the already considerable expense of, for example, a television

play, to insist that all accompanying music and effects should be transmitted "live." However, since the modern direct recording is capable of giving considerably better results, both from the aspect of bandwidth and noise level, than the commercial pressing, it might be well worth arranging a system whereby perhaps once a week, a resident Television Orchestra or other suitable combination recorded as much of the incidental music for forthcoming shows as came within their scope. In the same way a library of sound effects could be built up, new recordings being made as producers required them.

Another sound source which must be catered to is the sound track of motion pictures. Again this will compare unfavorably with live sound direct from the studio, but in general, movies will form separate items in the program and therefore it is probable that the lower standard of quality can more readily be tolerated. However, it is likely that to an increasing extent specially photographed film excerpts will be included in television plays. Open air and other scenes difficult to reproduce in the studio may well be shot in advance and included in the program at the appropriate moment, as was done on several occasions even before the war. In these cases, the greatest care must again be taken with the sound recording to avoid making the change from studio to film too obvious. In fact, it may well be preferable to reverse the technique of pre-recording, by having the actors speaking the lines in the studio, under suitable acoustic conditions, synchronizing their words to the mouth movements of the film. In this way, although the visual half of the program is recorded, the sound will be transmitted "live."

#### Balance and Control

While it is very difficult indeed to fix the point at which microphone technique ends and balance and control begin, we may for the purpose of this paper make a division as suggested by the duties of the two engineers concerned, the "studio sound" engineer and the "sound mixer." The former is concerned mainly with the positioning of microphones relative to the performers while the latter mixes the outputs of various microphones in the correct proportions, and at the same time controls the output level to within the dynamic range set by the limitations of broadcast transmission and reception. Once again, the balancing of the various microphone outputs will be more difficult than in sound broadcasting, since, as has been pointed out in the previous section, the microphones will seldom be in the optimum positions for sound pick-up, so that correction for this must be attempted at the mixing desk. The use of the moving microphone does not make matters any easier, since it will be very difficult for the operator to keep it at a fixed distance from the performer. The maintenance of a satisfactory balance between a moving singer picked up on a moving microphone and a stationary orchestra picked up on a stationary microphone is a task which often presents itself during floor show programs or in musical comedies. When it is realized that, in addition, the sound mixer must contrive to modify this balance somewhat to keep in line with the varying lengths of picture shot, it will be appreciated that a high order of skill is called for, and that sound mixer and boom operator must work in very close harmony. As has been suggested earlier, further complica-

[Continued on page 41]

Fig. 6. Typical arrangement for televising a dance band.

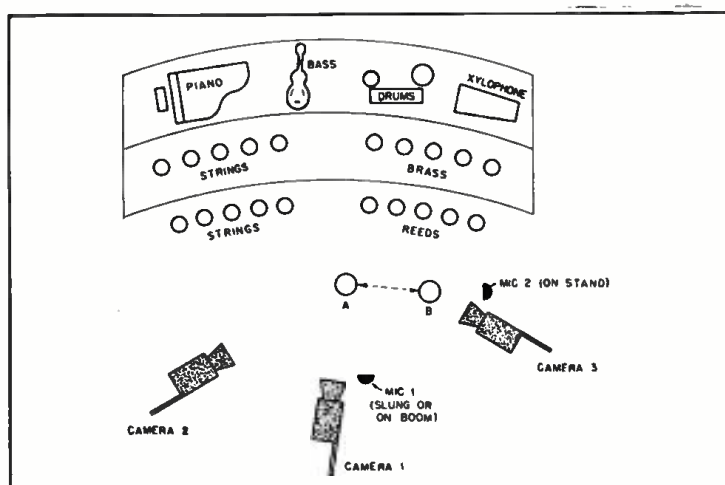

# Versatile Phonograph Preamplifier

PAUL W. ST. GEORGE\* and BENJAMIN B. DRISKO\*

Design data for an excellent preamplifier.

**A**T THE COST of adding one more article to the mounting list of those intended to solve the phonograph preamplifier-equalizer problem, the writer offers a more detailed analysis and a more versatile solution than has yet come to his attention.

Before launching into a description of the unit, let us consider briefly the purpose of a preamplifier in a reproducing system. This done, we can deal with the design problems more intelligently.

It is our belief that in any A-B test, if a listener finds two units (or two settings of a given unit) which sound different, yet he has no particular preference for either—then it is safe to conclude that neither is the correct answer.

During a long period of experimentation efforts were constantly made to obtain the actual recording characteristics. It was of course obvious from the first that if these are available, the whole design problem is vastly simplified and most of the cut-and-try method—which is cumbersome and time-consuming at best—would be eliminated.

Such data are not easy to obtain.

\*63 Melcher St., South Boston, Mass.

however; but after protracted effort, including tapping all known sources of information, the following table was built up. It is not necessarily accurate but represents the best known estimate of current recording curves:

	Low Freq. Turnover
Columbia 78	300
Columbia 33 $\frac{1}{3}$	500
Decca frr	400
R. C. A.	500
Technicord	650
Mercury	300

It is worthwhile at this point to consider the actual purpose of a preamplifier in a reproducing system. A preamplifier should bring the level of a device up to some standard. At this point in the system, switching generally occurs. The output level of the preamplifier should be comparable to that of the other units, such as AM and FM tuners, so that no appreciable change of main gain control setting will be needed on switching from one program source to another, and all sources should be nominally flat at the point of switching.

Rather careful compensation has to be included in a preamplifier to make records sound "right." Listening tests have evolved a series of

corrective networks which does a far better job than the first fixed-curve system. With at least semi-certain information to design from, a unit can be built to fit the needs of the day.

Hi Freq. Preemp. db per octave	Freq. at which Preamp begins
6	1590
6	1590
3	3000
2.5	1000
6	2500
	7000

Our problem is, then, to use this information to design a simple, inexpensive preamplifier versatile enough to do its work of bringing a low-level pickup output up to some standard level and, at the same time, to produce a nominally flat response curve from the program material. Since a number of curves seem to be in use, the standard single-network preamplifier will not suit our needs. To do this, we place two equalizers, one a low-frequency type with five positions and one a high-frequency type with four positions, in the circuit with an isolating tube between. We now find that by proper choice of constants, we can complement all of the above curves either quite closely or with at most a 2 db error, as Fig. 1 illustrates.

## Gain Requirements

Fortunately, pickup performance data are easier to obtain than record curves. We find that to bring a Pickering, Clarkstan, or similar cartridge up to about 5-volt level under average conditions requires a gain, in the flat portion, of about 28 db. A GE pickup will require nearer 40. (If we have about 5 volts at our switch point, the AM tuner diode—to deliver this—is being fed a signal large enough to minimize those distortions which plague diodes at low levels.)

We want, further, enough extra gain to complement the curve which needs the most boost, and this requires about 30 db more gain. The total is more than high-gain triodes can supply without loss of quality and without the feedback (with its attendant advantages) falling dan-

Fig. 1. Response curves of preamplifier with and without feedback.

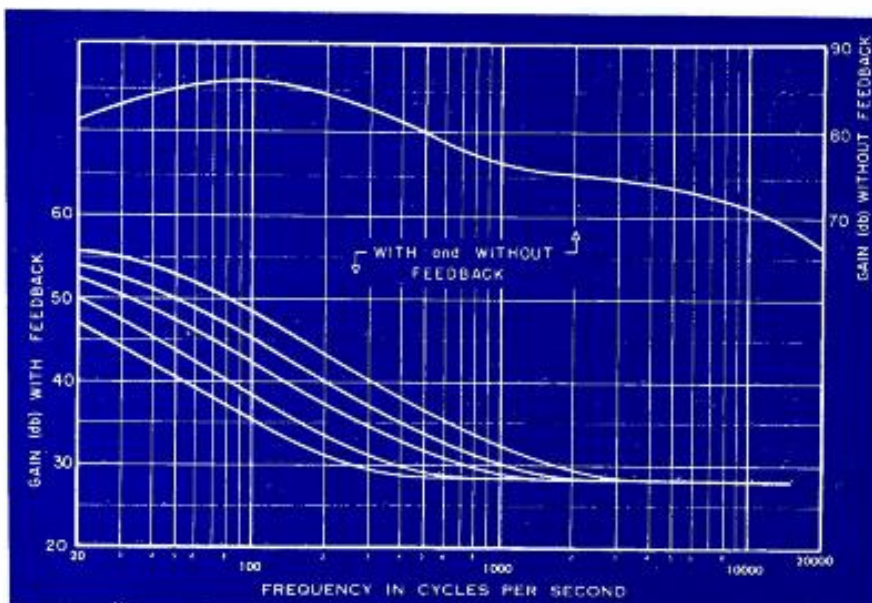



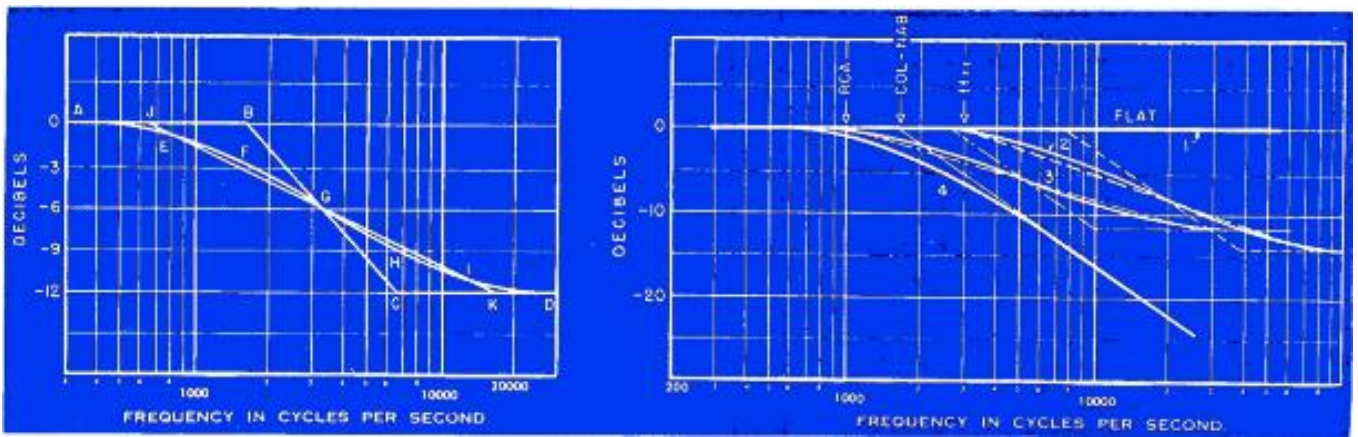

Fig. 2 (left). Effect of resistor in series with shunt condenser. Fig. 4 (right). Derivation of actual high-frequency roll-off curves from graphical (dotted lines) construction.

gerously low at the bottom end. So we decide on a pair of pentodes.

The 6J7 is an excellent tube for the first stage, having low hum and little noise, yet it is inexpensive and readily available. In the second stage, a 6SJ7 eliminates the gridcap. We choose constants which give high gain consistent with freedom from erratic behavior on changing tubes. We adjust voltages to meet our output requirements and to minimize intermodulation without feedback (as evidenced by d-c plate voltage shift vs. signal level).

Operating the first heater on d.c. was found unnecessary; a variable center-tap and variable positive bias, as shown, suffice. Now we apply feedback to reduce the gain in the flat portion to that desired—28 db in this case. We allow the gain to rise at a 6 db rate by a conventional RC combination. But we supply five such

combinations for the five curves. We also use screen bypass values which seem unnecessarily large until we consider that we are bypassing not a screen dropping resistor alone, but it and screen resistance in parallel. Furthermore, we feel that it is desirable not only to make the amplifier stable on the low end but also to achieve critical damping. This requires a 6 db per octave droop below the useful frequency range and on down to the point where the gain approaches unity.

Note that the low-frequency turn-over selector switch is a shorting type. Otherwise opening the feedback loop between switch points results in a sudden and extremely annoying rise in level—about 30 db! The 10-megohm click suppressors are not merely gingerbread; the sharp transients generated in their absence create extremely high peaks in the

power amplifier and speaker.

We now have a high-gain, low-noise, low-distortion, low-frequency-compensating preamplifier of simple construction, but one which still does not correct the upper end of the record spectrum. If we applied the feedback approach here, we would run into several difficulties: our gain when on the NAB-type curve would run perilously close to unity at the extreme high end, and our feedback would rise appreciably, with attendant disadvantages.

Further, there is no objection to a conventional loss in this application. We can feed it directly by the pickup and its design is simplified by being isolated by a tube. For the first we examine the NAB characteristic, which is a simple 6 db/octave rolloff, beginning at 1590 cps. This calls for a simple RC network, with a product of 100 microseconds;

Fig. 3. Complete schematic of pre-amplifier.

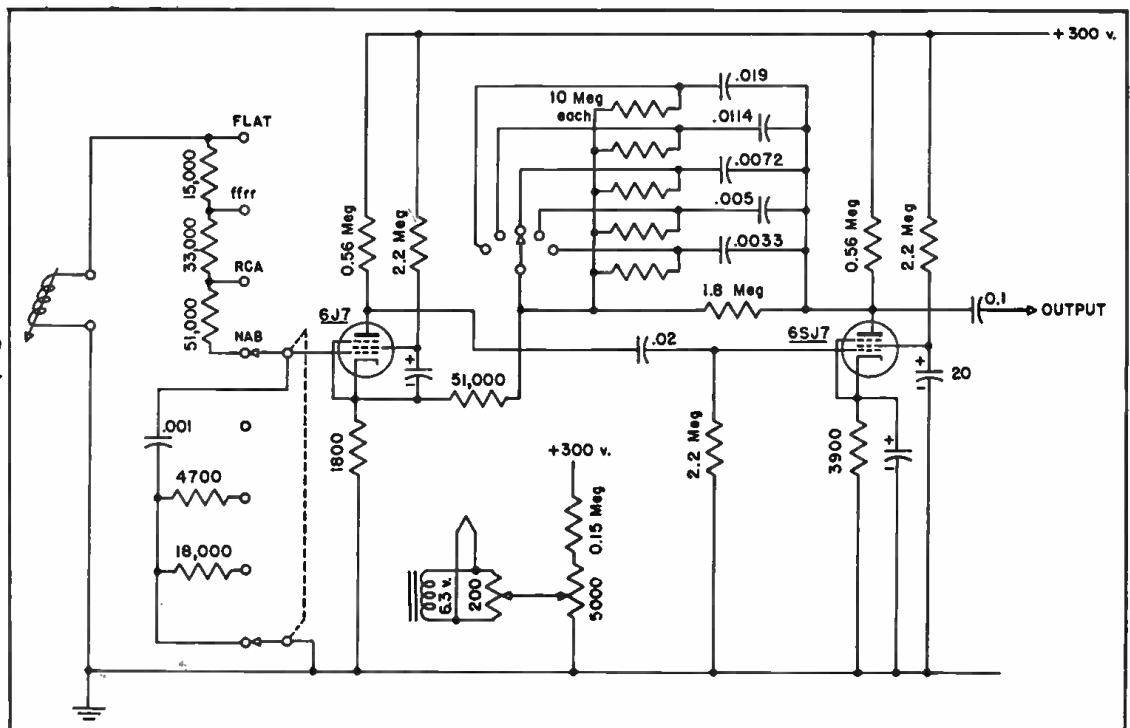

0.1 meg and .001  $\mu$ f is a good combination. With too small an  $R$ , we need to figure in pickup resistance and inductance. Since these vary with manufacturer, and we are designing a universal preamplifier, this is not desirable. At the opposite or high-impedance extreme we may run into hum pickup and tube input capacitance begins to cause some trouble.

A brief examination of the curve produced by the above and all other such networks shows us that at the nominal turnover frequency we are 3 db below the original level, and at exactly one octave either side are 1 db down from the respective asymptotes. The slope of the curve increases at the rate of 6 db per octave. This slope is fixed in character and cannot be changed; however, it can be stopped along its travel. Since we need other curves of less slope (2.5 db for RCA, 3 db for Decca), they can be obtained by stopping the 6 db curve at some empirically determined point.

Suppose we insert a resistor in series with the shunt condenser to give a second turnover two octaves above the first—as in Fig. 2. The asymptotes are the line  $abcd$ ; as would be expected, the actual curve falls 3 db below  $b$  and above  $c$ . The actual curve is  $aefghid$ ; and if we

lay a rule along this curve, we find its closest approximation is line  $jgk$ , which has a slope of 2.5 db/octave with respect to a new pseudo turnover frequency which is about 0.39 times the mathematical turnover. It is easily seen that if  $b$  and  $c$  were farther apart, the realized slope would have been steeper, and in this manner we arrive at the constants shown in Fig. 3.

Now to the measured performance of the preamplifier. About a half-dozen have been built using 10% tolerance resistors picked at random rather than selected for exact value. Three amplifiers were carefully tested. The best of the lot had 93 db gain without feedback (100  $\mu$ f across the first stage cathode resistor) and 30 db on the flat portion of the curve with feedback. The curves shown happen to be for the worst of the three, as are the performance data. With a Ballantine model 300 meter (0.5 meg) and a Dumont 208 scope (2.0 meg) as load, the maximum output was +20 dbv (db relative to one volt)—a peak-to-peak swing of 28 volts. At 1200 cycle turnover, which gives maximum bass boost, the output with a 600 ohm attenuator across the input, and no further signal, was -88 dbv. Since the gain at 60 cycles is 52 db this says that the hum voltage referred to the grid is about

-120 dbv, or about one microvolt. It is not possible with ordinary test equipment to measure lower, which justifies the hum-bucking circuits used rather than the d-c heater supply with its attendant expense and bulk. The one-microvolt figure was attained in each case with the second 6J7 tried; the first, however, gave only about 10 db more, which is still in the excellent-performance bracket.

The  $RC$  time constants in the feedback path are, however, rather critical. It is not easy to measure a 1.8 megohm resistor with accuracy; hence the following procedure was followed. The amplifiers were assembled with parts out of the bin; in one case four of the five constants were correct, in another, three, as plotted curves showed. Examination of the curves showed clearly which capacitors to change, and in which direction and amount to achieve the intended result.

Such an equalizer has been in use nearly a year in conjunction with an amplifier-speaker system which we confidently believe to be  $\pm 2\frac{1}{2}$  db from 48 to 13000 cycles and reasonably free from transient defects. The one outstanding change that appeared to coincide with the installation of the equalizer was that listeners started, for the first time, com-

[Continued on page 40]

Left: A complete audio amplifier with the versatile preamplifier described in the text installed in the upper left-hand corner. The two controls below the 6J7 and 6SJ7 preamplifier are the high-frequency de-emphasis and tweeter vernier gain control. The program level control for the amplifier itself is alongside the preamplifier controls. Right: Bottom view of complete amplifier, with the preamplifier wiring in the upper left-hand corner. The two controls are the high-frequency de-emphasizing control and the tweeter vernier gain control.

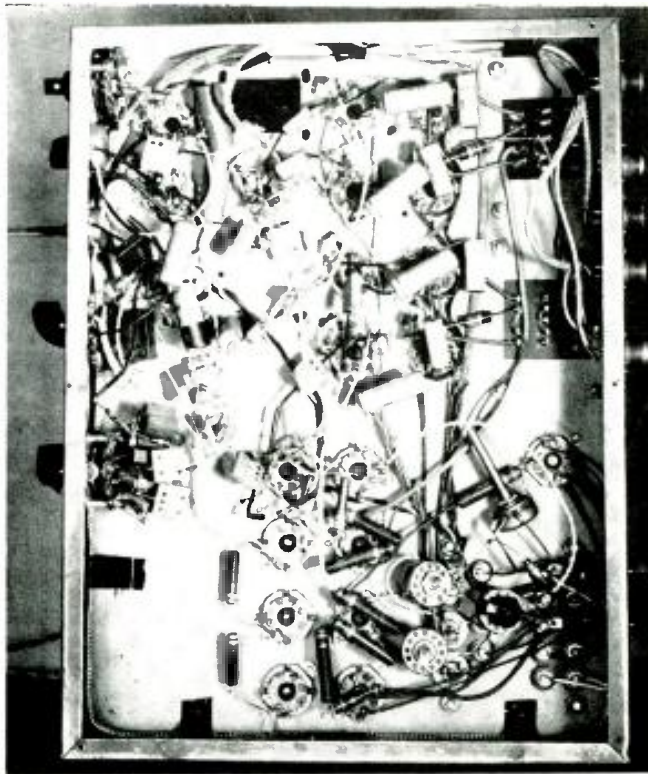
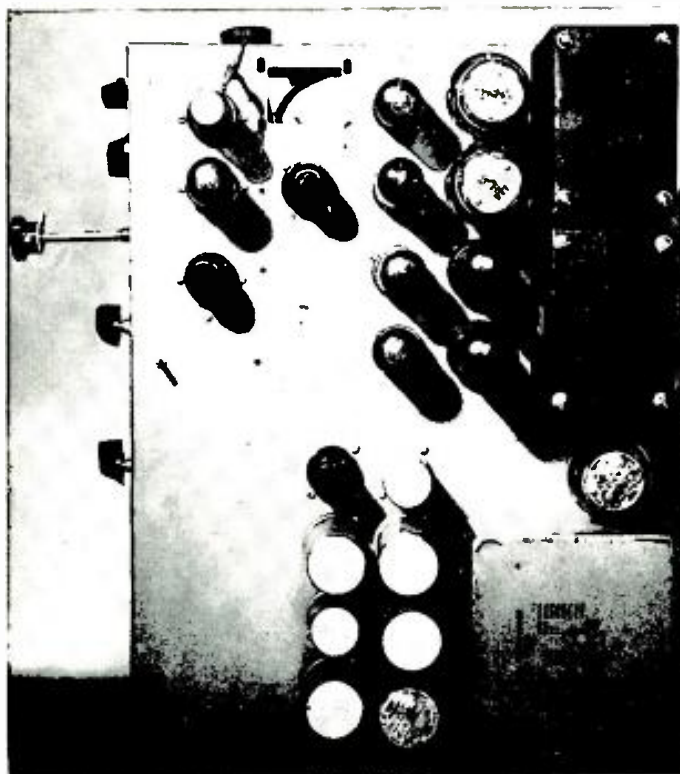

*In fine custom-built  
studio control systems...  
RCA can make anything*

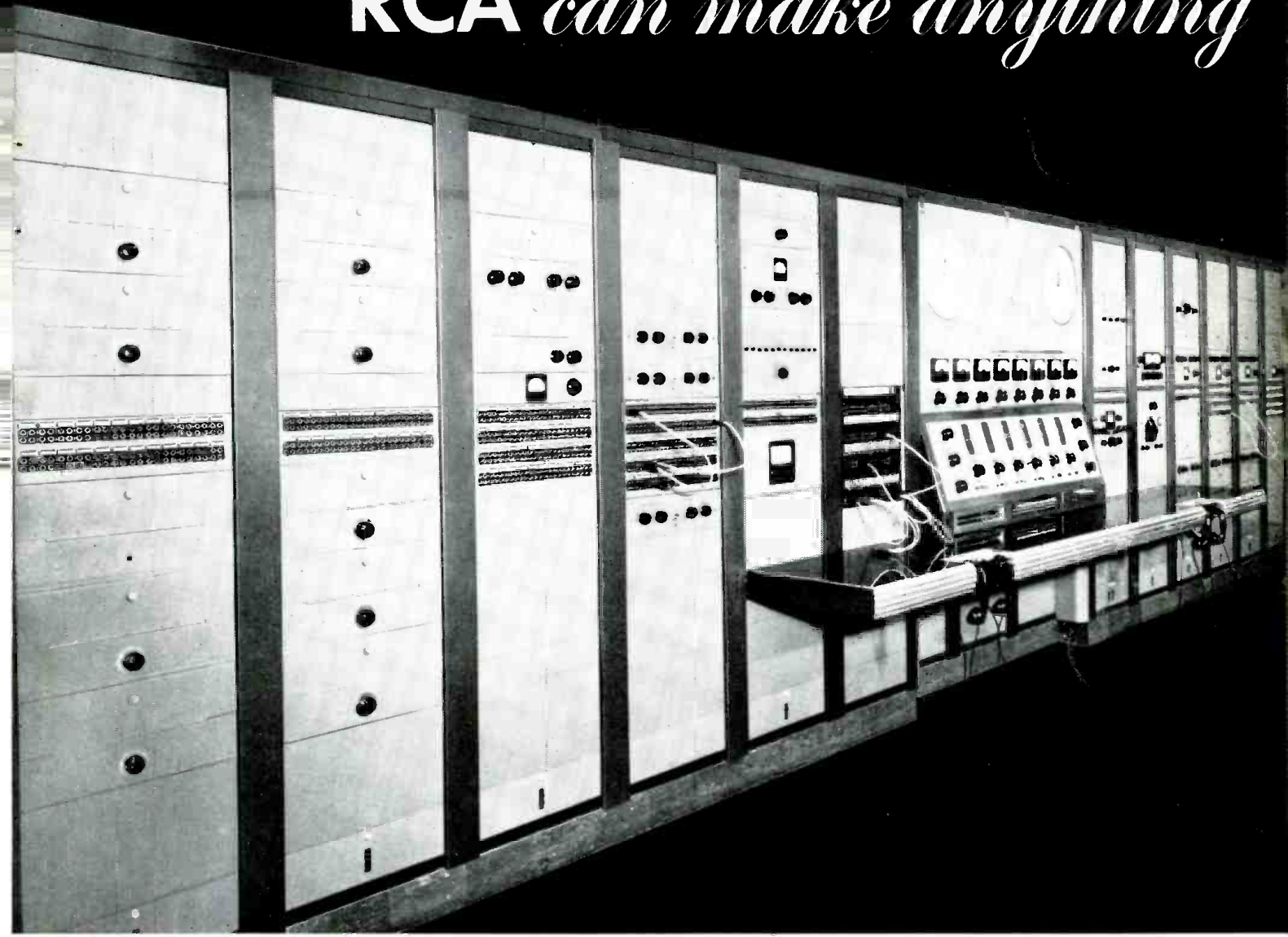

WMGM, New York. This master control console, including 12 deluxe audio equipment racks, is just one item of WMGM's modern million-dollar 6 studio layout, custom-built by RCA. Designed for AM, FM and TV operation, this console handles 10 studio inputs and feeds 6 channels simultaneously, or individually by a preset relay system.

**I**N ADDITION to the comprehensive line of standard studio-control equipment so familiar to the industry, RCA specializes in designing and building studio-control installations to meet the individual needs of stations and networks. Speech-input systems of this type are tailor-made with just the right facilities for handling all studio-control operations required by the individual station.

A few of these custom-built installations are pictured on these pages. They range from special equipment for medium-size stations to complete speech-input systems for the largest network installations. These systems have been worked out with the nation's leading station and network engineers. They incorporate every conceivable facility for controlling program operations and reproducing high-fidelity sound.

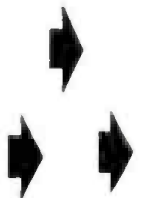

# The finest custom-built control

...are

**WFAA, Dallas.** This control console—with its 8 de luxe audio equipment racks (in-line) behind the master desk—is one unit of WFAA's up to date 5 studio setup, custom-built by RCA. Complete flexibility for multiple programming—simultaneous or independent control of 10 inputs to 6 outgoing channels. Preset switching and complete ringdown facilities provided.

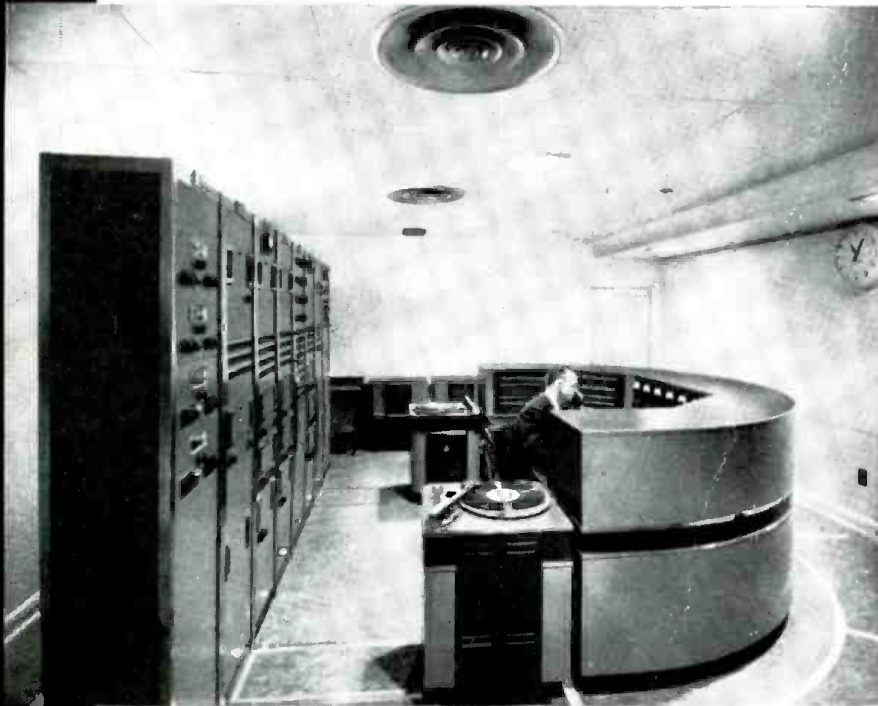

**WNEW, New York.** This master control console—in WNEW's modern 7-studio lineup—is custom-built by RCA. The console is flanked on each side by 5 de luxe audio equipment racks. It has complete facilities for control and preset switching of 7 studios to 10 outgoing lines...and for feeding cue from any channel to any studio.

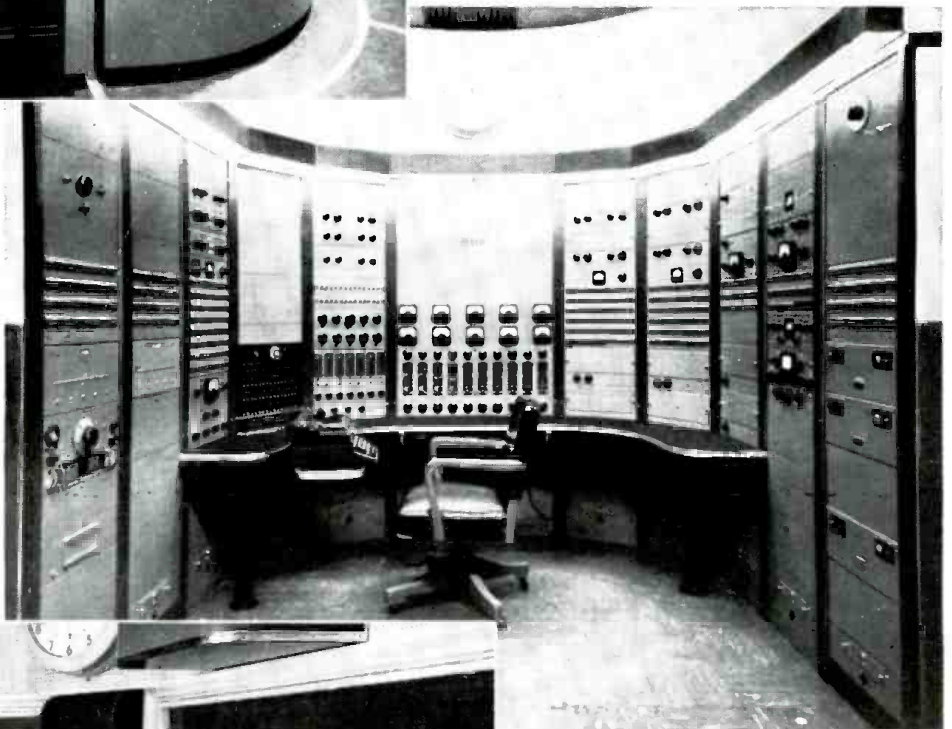

**WJPG-FM, Green Bay.** One of the specially-built studio-control consoles in WJPG-FM's 4-studio arrangement—custom-built by RCA. Complete two-channel operation (AM and FM), simultaneous audition and broadcast from any combination of studios, remote lines, cueing and talkback are provided.



# studio installations RCA



**WISH, Indianapolis.** This master control desk with 6 deluxe audio equipment racks (in-line), visible at rear, is only a part of *WISH's 4-studio installation*—custom-built by RCA. It provides complete push-button control (independent or simultaneous) for 4 program channels. Five master desk panels, left to right: Studio "A" control, MCR/NET-REM control, master monitoring and switching, Studio "B" control, and Studio "C" control.

**CBS, New York.** Here is a specially designed auditorium-type studio control console complete with monitoring and program amplifier equipment. It represents one of several such consoles used in *CBS's expansive installation*, custom-built by RCA. Control of 8 input circuits (6 microphone circuits and two remote lines) is provided. Mechanical design affords unobstructed studio view.

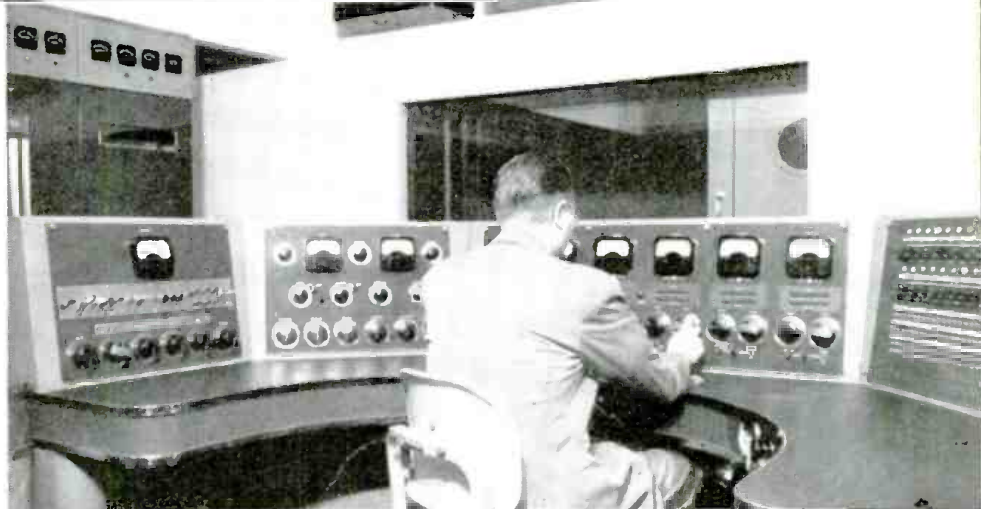

**KOMO, Seattle.** This master control console—with 9 deluxe audio equipment racks (at rear; not visible)—is one unit of *KOMO's completely new and modern 7-studio system*, custom-built by RCA. It incorporates complete center panel switching for 10 studios and 6 outgoing channels (KOMO-AM, KOMO-FM, network plus 3 emergency).

# RCA "tailor-makes" speech-input control systems to meet every individual station's need



WBAL, Baltimore. The master control console and 6 de luxe audio equipment racks in WBAL's "World of Tomorrow" 10-studio installation—custom-built by RCA. Control of seven program originating points extends switching facilities to any of 4 outgoing channels (AM, FM, audition, and utility).

RCA "Custom-Built" equipment service is available to every AM, FM and Television station—and on almost any working arrangement desired. For example, if you want a station studio survey and a detailed layout proposal, RCA Broadcast Engineers will be

glad to do it. Or if your specifications are already down on paper, RCA will be glad to work from them.

Your RCA Broadcast Sales Engineer is at your service. Call him. Or write Department 407, RCA Engineering Products, Camden, New Jersey.

*The One Equipment Source for Everything in BROADCASTING—is RCA*



**AUDIO BROADCAST EQUIPMENT  
RADIO CORPORATION of AMERICA  
ENGINEERING PRODUCTS DEPARTMENT, CAMDEN, N.J.**

In Canada: RCA VICTOR Company Limited, Montreal

Fig. 1. Compact, two section amplifier with control section arranged for mounting in small panel area.



C. G. McPROUD\*

Part I—A new amplifier of exceptional performance especially designed for modernization where cabinet space is limited.

## Compact 6AS7G Amplifier For Residence Audio Systems

**M**ANY AN EXPERIMENTER or audio hobbyist has the desire—and often a definite need—for a high-fidelity amplifier, but is at a loss for sufficient space to install it in an existing cabinet or piece of furniture. So far, many of the writer's amplifier designs have been adequate for good quality reproduction, but none was arranged specifically for use by anyone desirous of modernizing a reproducing system because they were all laid out with a view to accommodating the components in a normal amplifier arrangement.

To solve any problem, it is first necessary to recognize its existence—the rest follows naturally. For a modernization problem, the requirements may be stated as follows:

**Electrical:** Around 5 to 6 watts of high-quality audio power.

Switching to select standard and microgroove phonograph pickups, and two additional positions for AM and FM radio inputs.

Sufficient gain and low-frequency equalization for low-level magnetic pickups.

Separate high- and low-frequency tone controls.

To these may be added as desirable features a volume control compensated for loudness levels, and means for equalizing the levels of the various inputs so the compensated volume control works at its optimum position and to avoid undesirable level changes when switching between inputs.

**Physical:** Amplifier and power supply small

enough to fit into reasonable spaces.

Control facilities which may be mounted on a small panel space separate from the amplifier.

Considering these requirements separately, the first is fairly obvious. The reason for modernizing is to obtain a better quality of reproduction. This demands good components, and sufficient power to handle peaks without danger of overload. Since it is more economical and usually provides better overall quality to use a high-quality loudspeaker with a good reproducing system, a fairly high efficiency is generally encountered. Most high-quality speakers will provide plenty of volume for home use with much less than one watt of *average* power although more is necessary, of course, to handle the peak levels. Therefore, it is felt that five watts should suffice for practically any home system. It goes without saying that frequency response should cover the range from 30 to 15,000 cps, and that distortion must be held to an absolute minimum. The hum level should be so low that no sound is audible from the speaker in the absence of signal.

### Multiple Inputs

Practically every reproducing system is used for more than one input. Since the advent of long-playing, microgroove records, it seems logical to include an input for a second pickup, with a single selector switch connecting the chosen input source to the amplifier.

Low-level magnetic pickups are

firmly established, and any good amplifier must be designed to accommodate them without the need for an external preamplifier. As is well known, these pickups require equalization of the low-frequency spectrum, in addition to considerable gain to make their output comparable to that of a radio tuner. The microgroove pickups are slightly lower in output in most instances, due largely to a lower level on the record itself.

Although not generally known, a conventional crystal pickup can be fed into an equalized preamplifier, and will often sound better than if used with a high-impedance input. As far as the frequency response is concerned, this is easily explained. A crystal pickup may be regarded as a generator of zero impedance in series with a capacitance. An average crystal pickup, for example, has a capacitance of around 1500  $\mu\text{f}$ . When such a pickup is fed into a resistive load, it has a natural droop of 6 db/octave below the frequency at which its reactance equals the value of the resistance into which it feeds. Thus, it has a "turnover" frequency of 500 cps when fed into a 0.2-meg load. Now, while a crystal pickup is a constant-amplitude device and delivers a constant voltage into a high resistance load up to the turnover frequency (of the record) from a disc cut with the normal 6 db/octave droop below the turnover, the low-resistance load causes a loss in bass

\*Managing Editor, AUDIO ENGINEERING

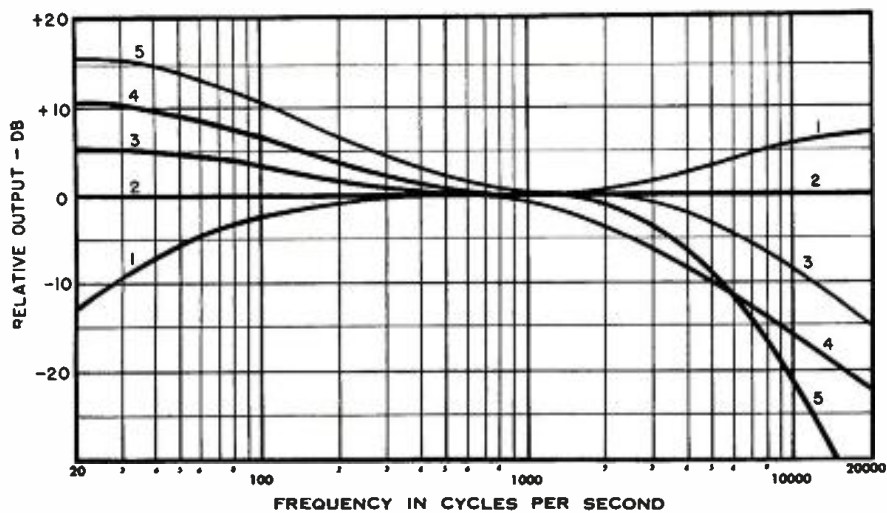

Fig. 2. Tapped high-and low-frequency tone control switches provide fixed response curves.

response equivalent to that of a magnetic pickup. But the preamplifier corrects for this loss, so the output is again "flat." The voltage output of the crystal is higher than that of the magnetic pickup, so the loss due to the low-resistance load may be accepted readily. Since high-frequency equalization is still necessary for the crystal pickup, it is still necessary to add a resistor shunted by a capacitor in series with the high side of the pickup to make it workable with a high-gain preamplifier, if wide-range reproduction is to be obtained. Therefore, this type of preamplifier is reasonably suitable for crystal pickups.

Most users want some tone controls so as to be able to obtain desired response curves. While the compensated volume control reduces the need to a large extent, satisfactory reproduction of phonograph records demands some roll-off control, and also a sharper cut-off for particularly noisy records. Varying degrees of bass boost are also desirable. Therefore, both low- and high-frequency tone controls are employed, providing five curves for each as shown in Fig. 2. These are step controls rather than continuously variable potentiometers because more suitable curves are obtainable. The low-frequency control provides a 5-db droop at 50 cps, a flat position, and boosts of 4.5, 9, and 13 db at 50 cps. The high-frequency control provides a boost of 6 db at 10,000 cps; a flat position; a roll-off down 3 db at 4400 cps and 8 at 10,000; an NAB roll-off down 3 db at 1600 cps and 16 at 10,000; and a cut-off down 5 db at 3500 cps and 21 at 10,000. Listening tests have adjudged these steps to be desirable.

The particular type of fully compensated volume control used is that

previously described in these pages.<sup>1</sup> The level adjusting is accomplished by means of three 0.5-meg potentiometers, with the microgroove pickup having no built-in adjustment, since the overall amplifier gain is designed to fit this input. If further adjustment is required, it may be accomplished externally.

The amplifier, shown complete in Fig. 1, is built in two sections—one is the output stage and the power supply, while the other is the control unit, with all the other stages. The power section is built on a standard 5 x 10 x 3 chassis, while the control section is housed in a 3½ x 7 x 2

<sup>1</sup>"Full-Range Loudness Control," Winslow, February 1949.

Fig. 3. Schematic of power amplifier section of the two-unit amplifier.

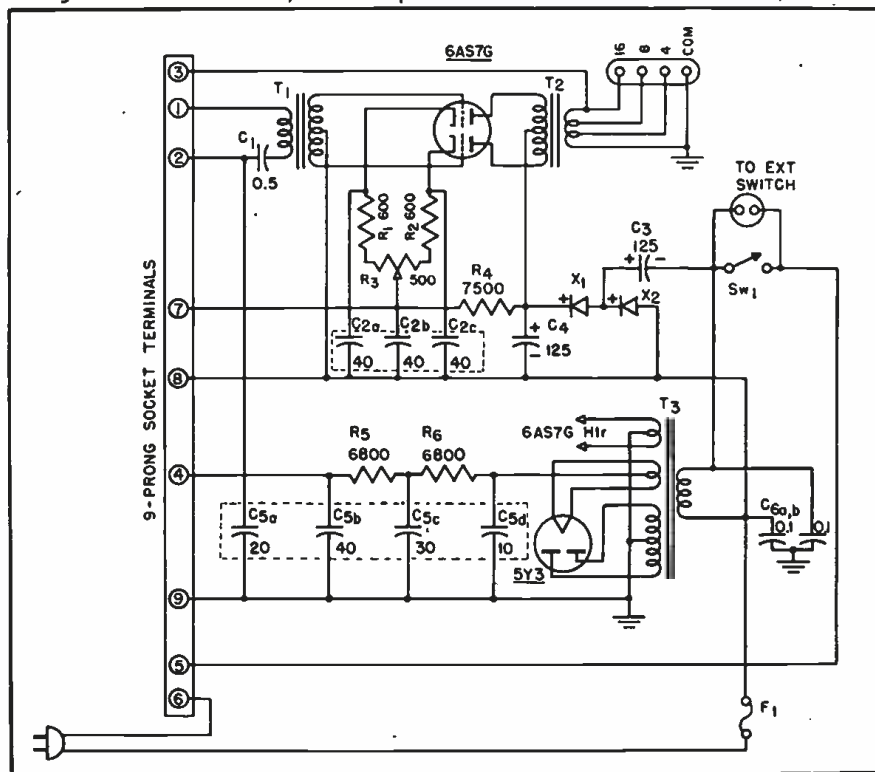

chassis, made from 7 x 11 x 2 standard aluminum chassis. The two sections are connected by a three-foot cable which carries all power and signal circuits except for the a-c switch line, which is separate. The a-c switch is not a part of the control section, but is to be mounted at a convenient location on the panel.

### Circuit Description

In general, amplifier design progresses backward, first involving the selection of the output stage, then adding the earlier stages to provide sufficient gain to drive the output tubes. Because the 6AS7G has so many advantages as a power output tube, it was chosen again for this application, in spite of the fact that it is relatively hard to drive.

It may also be said that the power supply requirements for this tube are fairly severe since it draws a rather heavy plate current. Normally, this necessitates a large power transformer and one or more large filter chokes. However, one of the requirements of the tube may be considered an advantage—because it needs an input transformer, the output stage can be completely isolated from chassis ground, thereby permitting the use of a voltage-doubling selenium rectifier circuit, as shown in the power section schematic, Fig. 3. This arrangement furnishes up to 150 ma at approximately 300 volts from a 117-volt a-c line. The 6AS7G draws about 120 ma, and an additional 30 ma is fed



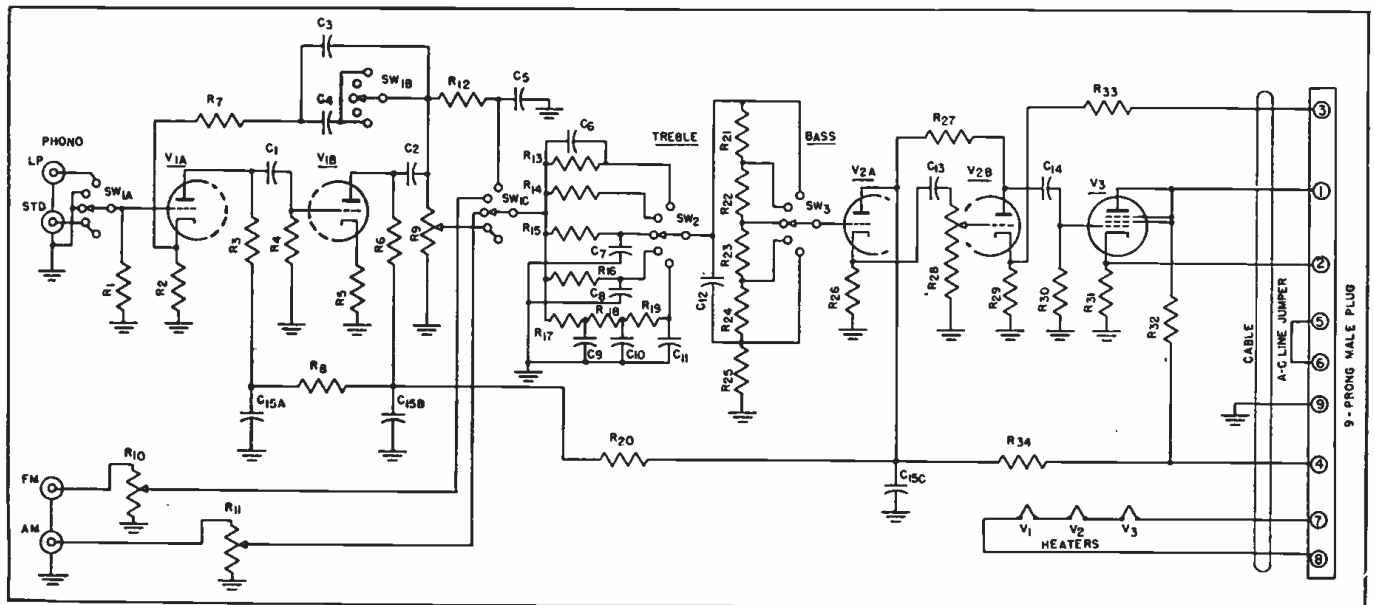

Fig. 5. Schematic of the control section.

through a bleeder for heater current of the three input tubes. Thus the low-level heaters are energized by rectified alternating current. Considering the use of a push-pull output stage, the capacitor provides sufficient filtering for humless reproduction.

The input stages require a d-c supply which may be grounded to the chassis, and in addition, the 6AS7G heater must be energized. Thus a small power transformer is used with a conventional rectifier and an RC filter circuit. The 6.3-volt filament winding on the transformer is used only for the 6AS7G, since the other tubes have a d-c heater supply.

The output transformer is massive and occupies a large portion of the chassis area. The space underneath the output transformer is occupied by the two 125- $\mu$ f capacitors on a bracket; the channel-type, push-pull input transformer is also under the chassis, as are the coupling and line bypass capacitors. The selenium rectifiers are mounted on Bakelite strips above the chassis, and are protected by a perforated screen cover. The capacitors in the voltage doubler power supply—the two 125- $\mu$ f units and the triple 40- $\mu$ f unit used for cathode bypass of the 6AS7G—are insulated by cardboard tubes. All connections except the output are made on one end of the chassis: a 9-prong socket for the control section feed; the a-c line cord, fuse, and switch; and a small two-prong socket for a remote power switch which is in parallel with the chassis switch. This permits a pair to be run up to a panel-mounted power switch, thus eliminating any a-c circuits from the interconnecting cable.

### Control Amplifier

The control amplifier is of unique design, since three controls are mounted on the front apron of the chassis, and one on the end, and with the tubes on the rear apron projecting away from the panel. The controls are arranged so the unit may be mounted either vertically or horizontally, thus being adaptable to almost any cabinet space available. The selector switch is on the end of the chassis, with an operating lever which extends through the panel. Also mounted on the end are the two pickup jacks and the level-adjusting potentiometer for the standard pickup. The decoupling capacitor and the two radio input jacks are mounted on the rear apron along with the tubes, while the radio level-adjusting potentiometers are on the "top" of the chassis. The power cable comes out of the end opposite the selector switch.

To simplify wiring into the circuit, both tone controls are assembled

completely on their switches as shown in Fig. 4. All resistors connecting to ground are wired directly to the tube sockets, and connections are made point-to-point where convenient. A resistor strip is mounted on the volume control, using the long screws of the switch assembly to hold it in place. This strip carries most of the plate and decoupling resistors.

The assembly of the control section in such a small chassis is somewhat tedious, but there is plenty of room, and the object of the whole amplifier was to make it convenient for mounting.

Inverse feedback is used around the last three stages, primarily to reduce the output impedance to a minimum. The output transformer has 4, 8, and 16-ohm taps, with the latter supplying the feedback voltage. Good frequency response, power, and phase-shift characteristics are readily obtainable with a transformer de-

*(Continued on page 40)*

Fig. 4. Assembly of tone controls on standard switches to provide units easily wired into the control section. Left—bass control; right—treble control.

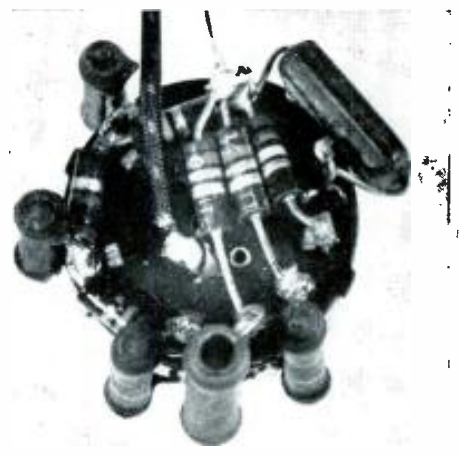



Testing Hartmann whistle in parabolic reflector.

# Experimental Ultrasonics

S. YOUNG WHITE\*

## Part I—Design, construction and operation of the Hartmann whistle.

**T**HE SERIES of articles<sup>1</sup> on the commercial application of ultrasonics aroused considerable interest among various groups of engineers. One reaction was a desire to do some investigation of the phenomena in their own shops at home, so as to become acquainted with this odd form of energy. One place to start is with a Hartmann ultrasonic generator, or whistle.

The Hartmann design shown in the photograph was invented in 1927, and proved to be able to put out about 6 watts of acoustic power in the range from 15 to 40 kilocycles, using as a source of compressed air an ordinary one-third horsepower paint-spray compressor. With more power it is capable of over 60 watts output when driven by a compressor of about 3 or 4 hp. The device appears so simple that we could ask why it does not sell for about \$5 in the model shops, thus allowing anyone with a paint spray outfit to play with ultrasonics with this wattage and in this fre-

quency range. On investigation, it seems that the design is quite complex and the operating principles hard for the average experimenter to grasp. There are also some difficulties in adjusting it for optimum output.

It is always a pleasure for an electronics man to investigate some other field and find his familiar problems of negative resistance, impedance

equivalent of this high-power sound source, there are several peculiarities of air coming out of an orifice that must be reviewed for those of us who have forgotten the laws of fluid flow. The basic jet is formed by a "thin plate orifice" of Fig. 1, this being merely a hole, usually considered to be circular, in a plate so thin it is assumed to have no effective dimension. Air under pressure forms a jet as shown.

There are two points to keep in mind. Since the air reaches the hole from the side as well as from the axis of the jet, there is a squeezing action which rounds off the jet at the orifice edge. The area of the jet is about 66% of that of the orifice. In Fig. 2 we see a conventional rounded orifice, where the sides merely follow this line of natural flow. The jet diameter is then 100% of the orifice diameter.

The second thing to bear in mind is that air cannot be emitted from an orifice at velocities higher than sonic velocity, in this case 1100 ft/second. As you increase the pressure from zero gauge the velocity increases more or less linearly until at critical pressure—in this case 13.6 lb/sq. inch gauge—sonic velocity is

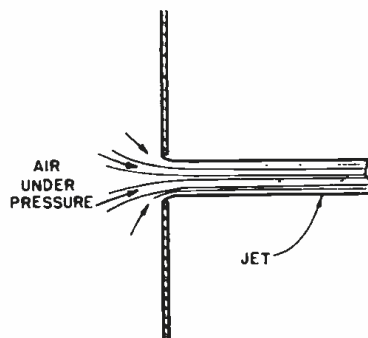

Fig. 1. Thin plate orifice. Area of jet = 66% of orifice. Max  $v = s.v.$  (13.6 lb./sq. in. gauge).

match, resonance and so on in a new form, but still responding to the same treatment. The Hartmann whistle is a good example of a rather complex phenomenon quite understandable to an audio engineer, if put in electronic terms.

Before we reach the electronic

\*% Radio Magazines, Inc., 342 Madison Avenue, New York 17, N. Y.

<sup>1</sup>AUDIO ENGINEERING, June, July, Nov., 1947. Jan., Feb., April, June, 1948. Our supply of these issues is exhausted but these articles will be reprinted later in book form.

reached. No amount of pressure will increase this velocity, but of course more air will be forced through the orifice as at higher pressures it is more dense.

About a hundred years ago it was found that some such jets had a curious internal detail of crossovers, as in Fig. 3. This was maximum when the velocity was sonic and the orifice was designed to exaggerate the side injection, as indicated in the drawing.

In 1927, Hartmann suggested that the slopes of this internal detail represented positive and negative resistances, and that if a resonant organ pipe be placed in a negative resistance region, oscillations would occur. This is done usually as shown in Fig. 4, with the cavity tunable over some range. So we apparently have a novelty item that could be made of duralumin or perhaps brass, connected to a paint spray compressor, and provide 5 watts of high audio or ultrasonic frequency with which to experiment.

When Hartmann actually inserted such a cavity he found that the air packed into the cavity and then blew out again in slugs whose section,

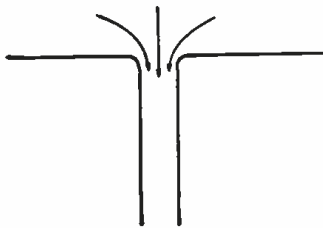
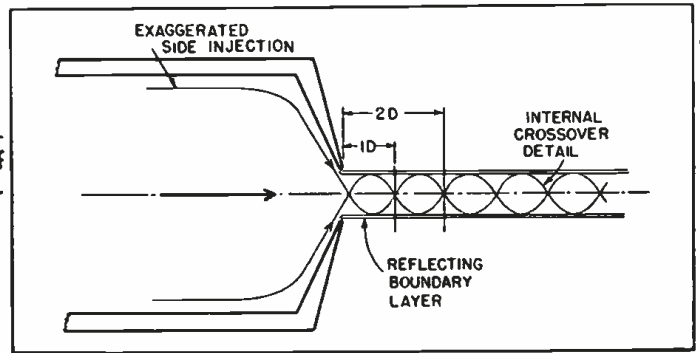

Fig 2. Standard shaped orifice. Area of jet = 100% of orifice.

viewed from the side, was diamond-shaped. It was found the best efficiency obtainable was about 4%. It theoretically blows at any pressure above 13.6 lbs. per square inch, but in practice it is difficult to obtain oscillations below 20 lbs. pressure, and many refuse to blow at pressures below 50 or so. At 90 lbs. they are quite easy to operate and adjust, but at 30 are rather critical at some settings. The curve, Fig. 5, shows that the action is more complex than a simple organ pipe as the length of the pipe has a complex relationship to the frequency. Greatest power output is developed when the cavity is from half a diameter to about two diameters deep.

The frequency does not vary too much with pressure, but at low pressure operation the spacing between jet and cavity is quite critical, and a change of 25 to 30 lbs. might stop

Fig. 3. Cross-sectional view of whistle with crossover indicated.



oscillation entirely, while a change from 80 to 100 requires little or no adjustment of the spacing. At all times the spacing has a great effect on the waveform, but usually it can be adjusted to give a fairly pure waveform.

To appreciate the difficulties, let us design such a unit. We shall make it as simple as possible, of the most economical materials, and match it to a conventional one-third horsepower paint spray compressor giving about 40 pounds pressure. By going to 90 pounds pressure, the same unit will deliver about 5 to 10 times greater output, because only the spacing between the jet and the cavity needs to be changed.

By making a few trial models with dural or brass, we find the edges of the cavity and jet are critical in design. They cannot be feather edges, as too much of our output then forms "white noise,"<sup>2</sup> and if the generator is set for above audibility we do not want to be annoyed by this hissing sound any more than necessary. By blunting the feather edges to a definite thickness of between one-half and one and one-half thousandths, we can minimize the white noise. About this time we find these edges take quite a beating and erode badly in a half hour or so, and the generator ceases to function. Evidently we need a material that will stand this erosion much better. We also notice

<sup>2</sup>Random noise covering entire frequency range being investigated, so called because it forms a solid white pattern on an oscilloscope.

that, since we are discharging compressed air, a good deal of moisture forms on very part of the generator, so we also require a completely corrosion-free assembly.

A little calculation shows that particles of dust or moisture coming out of the jet at sonic velocity have a striking power of about 5 to 10 tons per square inch. It takes quite a tough material to stand it indefinitely. Let us see what we cannot use.

Chrome plating is of no help, as it rounds the edges. Cyanide or other case hardeners usually require re-grinding to establish the definite edges we wish, and when we break the skin of a case-hardened job we are not sure what we have, and it will probably rust quickly. (If we oil the unit to prevent rust, the oil is scoured off in a minute) . . . 18-8 stainless steel is not tough enough.

A good material is Ohio Airdy—a standard tool steel of high chrome content and, properly heat-treated, will show a compressive strength in excess of 500,000 lb./sq. in. It is a little difficult to work, and it must be sent away to be heat-treated, but it is about the best material available for the purpose. It will save time and money if the model is made in dural and its performance checked as long as it lasts, and then a duplicate in the tool steel is made.

#### Calculating Jet Size

How do we calculate the jet size? We consult a table in the "Compressed Air Handbook" which gives the cubic feet per minute for orifices of various size. We then ask the manufac-

Close-up view of the Hartmann whistle.

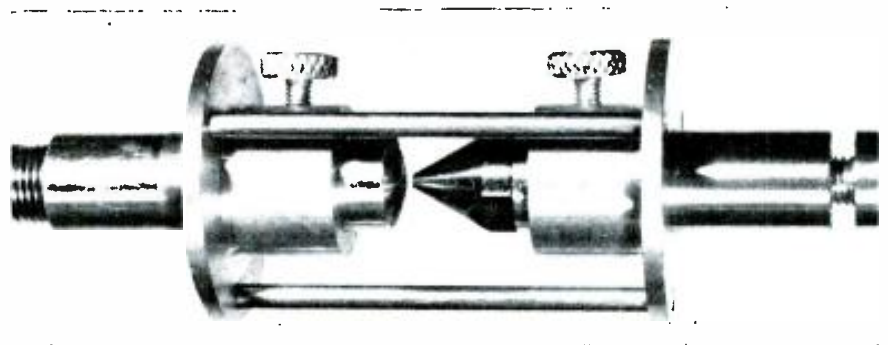

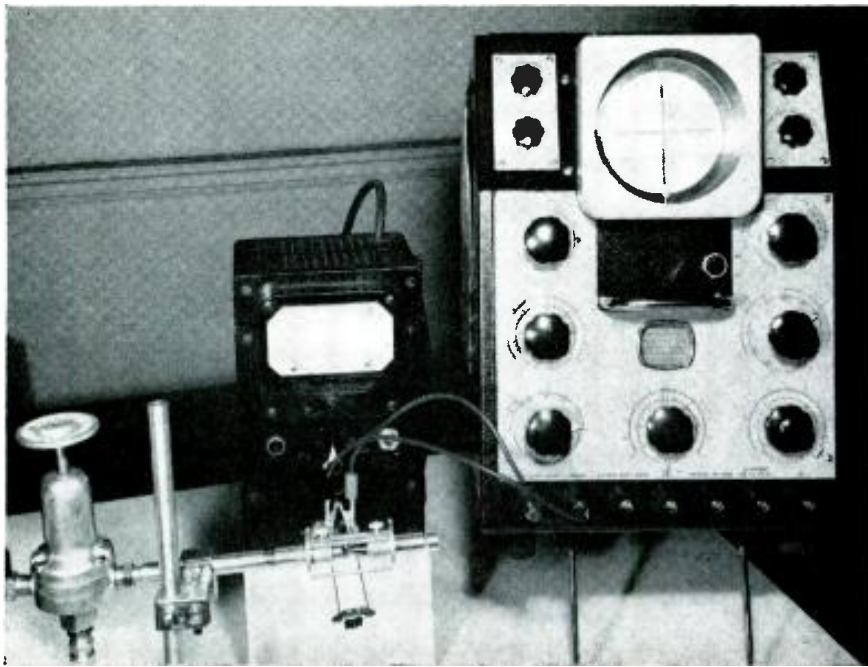

Checking waveform of ultrasonic whistle output.

turer of several compressors how many cfm they deliver and receive not very definite replies. It seems that with standard air under ideal conditions the delivery into a certain load is so much, but in actual field conditions the output may be rather widely different. Some responsible manufacturers rate their product in cfm displacement, and we are free to choose our own percentage of air actually delivered, which may be from 90% down to a lowly 60%. A ½-hp compressor at 40 pounds should deliver about 2 cfm. That works out at about a 42 thousandths orifice. Since compressors are single-cylinder affairs in this range, a regulator should be used to smooth out the pulsations, so the jet should be designed for about 35 pounds actual operating pressure.

Because the orifice is not designed to follow the natural flow, some inefficiency in volume delivered is to be expected, so a correction of about 20% is in order, giving us an orifice of about 44 thousandths as the actual size.

Thus, for the resonant cavity design, we arrive at a diameter of .044 inch. General experience shows that the diameter of the cavity should be slightly greater than that of the jet, and .062 is a standard drill size, so we make it .062., although a ratio of about 1.25 is optimum, which would call for a diameter of .055. Material would be the same. It should be obvious that only that part of the assembly directly in the path of the high-velocity air must be hard material—the rest of the assembly can be any non-corrosive substance.

The frame holding the two in line axially must be as transparent to sound as possible, yet hold the parts in very accurate alignment. It must also allow the cavity to be easily slid forward and back from the jet, as the position for optimum oscillation is quite critical.

The adjustment screw that allows variation in the depth of the cavity must permit the piston to come flush with the edge of the cavity, as many times the cavity collects dirt that is otherwise quite difficult to clean out. Oscillations start when the cavity is about half a diameter deep, and continue for several diameters. A typical tuning range is from 14 kc to 50 or 60 kc, with maximum output of about 6 watts from 18 to 35 kc, a very useful ultrasonic range. The screw con-

trol must be smooth, and a reference mark on it allows setting to a desired frequency. A cross-section view, Fig. 4, shows an exaggerated piston diameter. The spring forces it against the screw, and an enlarged end on the piston retains the spring and also aligns it with the cavity so it will not bind when being adjusted. Stainless steel drill rod, unhardened, seems to stand the erosion all right, and in the model discussed is  $\frac{1}{8}$  D.

This same unit will operate with full output of about a 1½ hp compressor at 90 lbs. pressure, with no modification, except for spacing between jet and cavity.

#### Checking Operation

Three instruments can well be used in this range, as well as several transducers.

A simple and readily available combination is a Rochelle salt bimorph crystal from a new or broken phonograph pickup, feeding an ordinary oscilloscope. The crystal should be shortened by cutting with a razor blade to a length of about  $\frac{3}{8}$  inch. The response will be full of peaks, but it will give comparative output, and if we adjust the generator to emit a sine wave, the crystal will tell us so.

A PN crystal from Brush will also work, a half-inch cube being suitable. If held 2 inches below the generator, the output will be as much as a volt or two, so ample trace on the scope is had. About the same reading will be given if a parabolic reflector is used, focussed on the crystal.

One misleading effect is that if the crystals be unloaded, such as by a thin rubber diaphragm under some tension, they will give sine wave output on white noise at their natural period. This is pretty low level and should not prove too bothersome.

Fig. 4. Frequency is varied by adjusting piston.

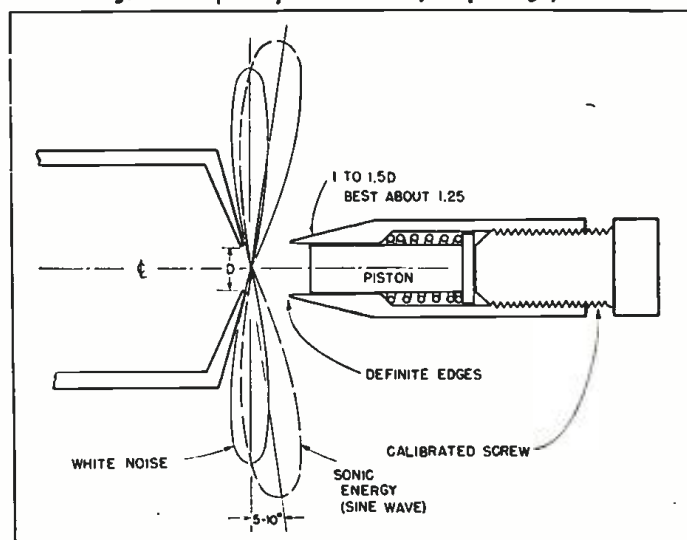

A Boonton voltmeter is flat to 200 kc and works well with these crystals, but the 'scope is more useful as it gives the peculiar wave forms you are able to obtain by improper adjustment of the generator.

A Navy or Coast Guard long-wave receiver can be easily modified for this use. Take out all but one tuned circuit and replace with wide band amplifiers. Even one tuned circuit gives too much selectivity for most uses.

#### Other Equipment

A source of compressed air, filters and regulator and gauge are necessities. About 30 feet of hose will allow the compressor to be some distance away, although enclosing it in a sound-proof box is also worth while. If you go downtown to buy some air compressor fittings please check that you have enough for the right kind of connectors and so on, as they are often different from standard pipe thread fittings.

#### Starting the Generator

If you are sensitive to high level sounds at the threshold of audible pitch, have some cotton handy to stuff in your ears, as there is always a tendency to tune the whistle down into audibility.

Fig. 5. Frequency and power output of cavity of varying depth. Cavity diameter = .062".

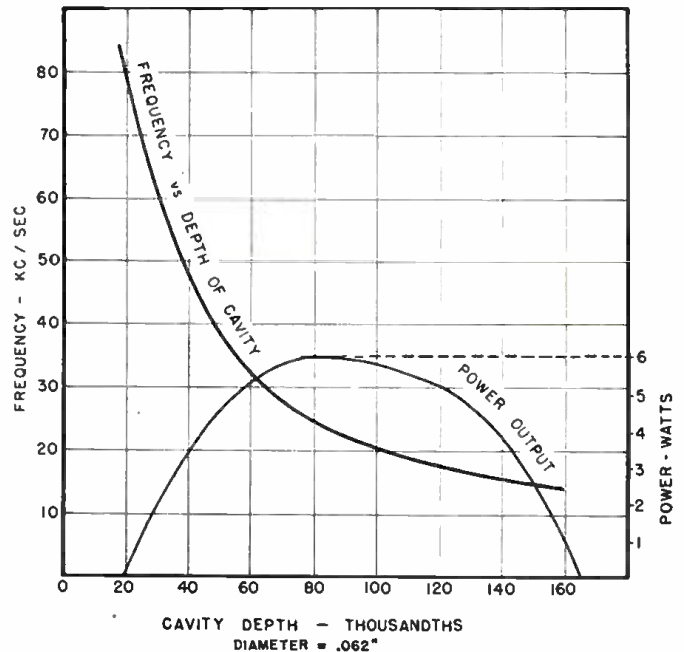

Start the compressor and adjust the jet to about 35 lbs. pressure. Have the jet exposed on the end of the hose. You will now find that the cross-over type of jet will drive at resonance anything with a crevice in it. Point the jet at the edges of the pages of a closed book, and tunes can be played on them by squeezing the book together so as to vary the pres-

sure. The same effect can be had if you hold your hand out flat with the fingers pressed tightly together and play the jet along the crevices between the fingers. But for widest controllable range, squeeze the thumb and forefinger together and play the jet into the joined surfaces. By varying finger pressure we can play from

[Continued on page 44]

# Problems in Audio Engineering

LEWIS S. GOODFRIEND\*

Details of an audio engineering course to appear serially in this magazine.

**A**UDIO ENGINEERING is that branch of engineering that deals with the generation, transmission, and hearing of sound. It is based on acoustics, psychology, and electronics, and when the study or application of any one of these phases is neglected or over-stressed, as electronics often is, the result is of questionable value.

In selecting subject material for a course of study in audio engineering it is therefore necessary to cover all three phases. It is not difficult to find two possible points of departure with the choice determined by the background of the students. In planning a course for a college of engineering it is best to begin with material related to prior courses in physics and vibrations which are stressed in such an institution. The starting point in this way is fixed at the generation of sound waves, and their transmission to the ear. For courses to be given to

a group having no fixed background other than a strong interest in the field, it is best to start with the method of hearing and the operation of the ear, and it is at this point that the present series, "Problems in Audio Engineering," will begin. The study of the ear includes application of the decibel and the general background of units of sound power, including the Weber-Fechner law.

Once the student thoroughly understands the phenomenon of hearing, he will find it possible to analyze with ease many of the seemingly complex problems of audio. A survey of the next important phenomena, the methods of sound generation and transmission in an elastic medium, may begin. It is at this point that care in the selection of material must be exercised, or the remainder of the course will be completely devoted to the minutia involved in the theoretical considerations. A close examination of point and dipole sources is in

order, but acoustical couplers and impedance-matching devices should be left to a later time when they may be compared to their electrical equivalents. It is here, however, that such topics as the energy and intensity of sound waves should be treated, and the definitions of terms such as displacement, amplitude, rms, mean, octave, frequency, period, as well as the fundamentals of musical instruments, should be carefully discussed.

#### Architectural Acoustics

The next logical step is the consideration of the general field of architectural acoustics followed by a detailed study of decay, reverberation, liveness, sound insulation, and a comprehensive analysis of the spectra of music, speech, and noise. Problems of correcting existing acoustical conditions of buildings may be considered here, but design of new auditoria

[Continued on page 34]

\*Stevens Institute of Technology, Hoboken, N. J.

# WMGM Master Control Equipment Design

M. E. GUNN\*

Technical data on a modern, high-power, broadcast station installation.

**A**LTHOUGH THERE are many services and functions performed by master control, probably the most important is the switching of programs (remote or studio) to outgoing lines. In addition, monitor facilities are required for offices and lobbies. Moreover, remote line terminations with associated equalizing networks are necessary, and telephone lines must be maintained for communicating to operators handling remote programs. Test gear should be available for making measurements of frequency response, noise, and distortion, of outgoing programs.

At WMGM, multiple output switching is accomplished by a master control pre-set system which performs all operations by means of relays. This system permits the operator to set up the succeeding dispatching circuits ahead of time. Then, during

\*Audio Engineering Section, Engineering Products Dept., RCA Manufacturing Co., Camden, N. J.

a station break interval (sometimes by the operation of a single switch) he can execute comparatively complex switching schedules in a minimum of time and without the chance for error that would exist if each studio had to be switched independently. This system is flexible in that channels can also be operated individually if it is necessary to switch a channel at some time other than a quarter-hour interval when most program changes are made. With the improved performance obtained, and considering that there is less likelihood for operating error, this type of pre-set system is a sound investment.

At the present time there are six studios in operation at WMGM and these, as well as three remote program circuits, can be switched to one or all six outgoing channels. In addition, there is one spare program input which may be used as an emergency input or may be reserved for future expansion of studio facilities.

All of the master control equip-

ment is mounted in standard cabinet racks which are bolted together to form a single unit as shown in *Fig. 1*. The switching system is composed of six identical sets of controls, relays, and lights (one set for each output channel). The counter, approximately 13 feet long, provides working space and gives all the operating conveniences of a desk-type control system. The counter top is covered with burn-proof mica and the edge is trimmed with 4-inch aluminum moulding. The counter assembly is fastened to the racks by means of heavy angles, thus making it unnecessary to have any legs for support. Cutouts in the counter edge serve as convenient locations for telephones.

All master control racks are mounted flush with the wall. Thus, space at the top and ends is closed off and a door is provided at the left end, leading to the area in back of the racks. Three J.C-1A monitor speakers are built into the wall above the racks and are splayed to a degree to give optimum listening advantage. Al-

Fig. 1. Master Control Room layout for WMGM showing pre-set switching system in the center and six racks of de luxe associated audio equipment on each side.

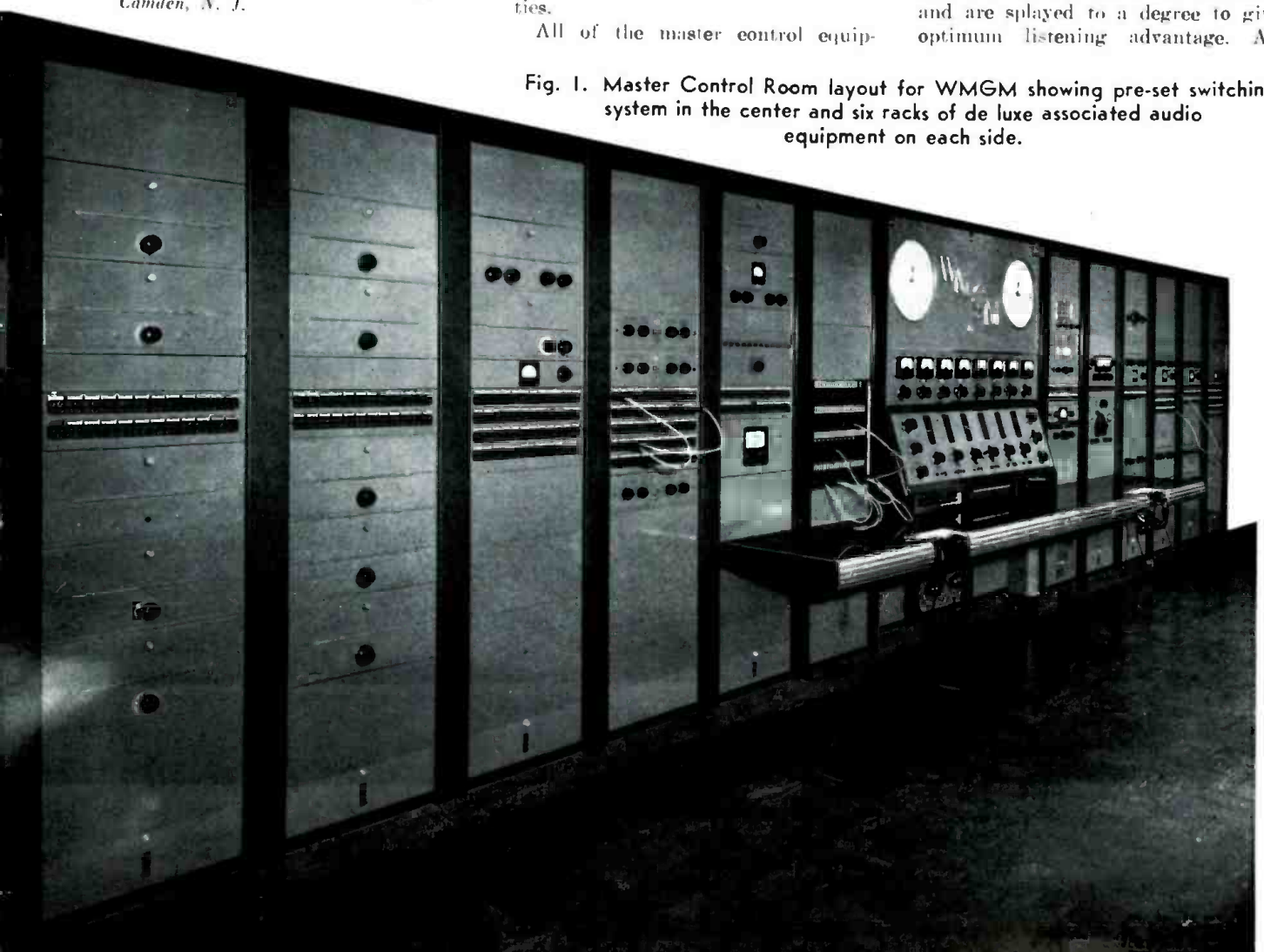

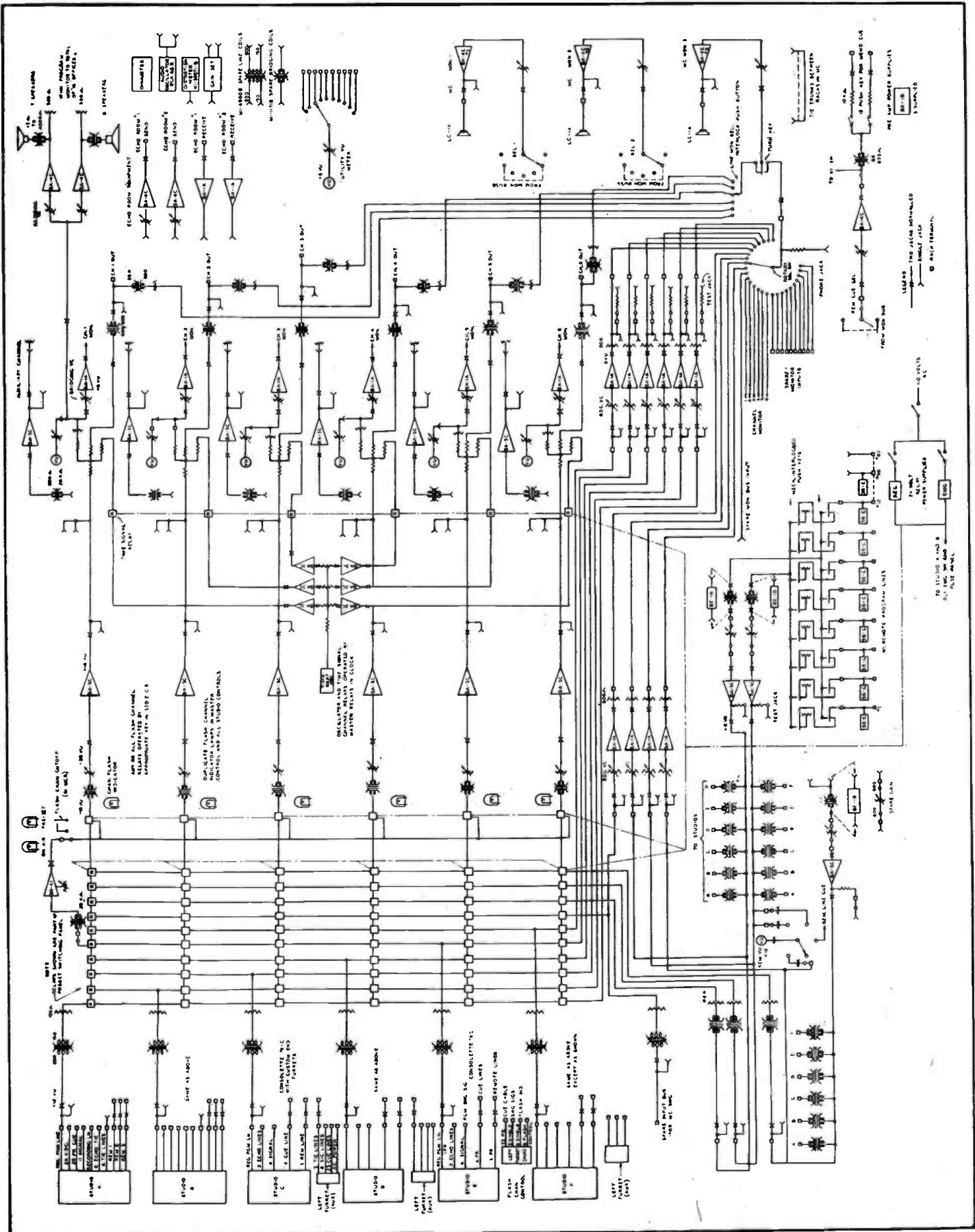

Fig. 2. WMGM Master Control Block Diagram.

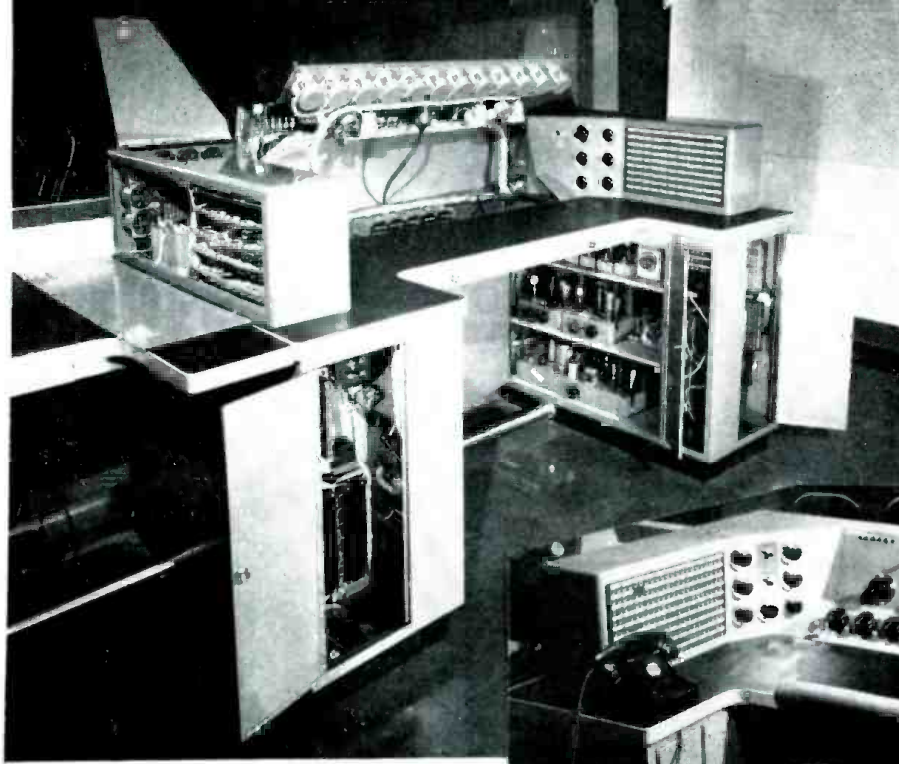

Fig. 4 (left). This view of the Studio A console shows how panels and doors may be opened to provide easy access to all components. Compartments with doors opening to the front contain terminal blocks.

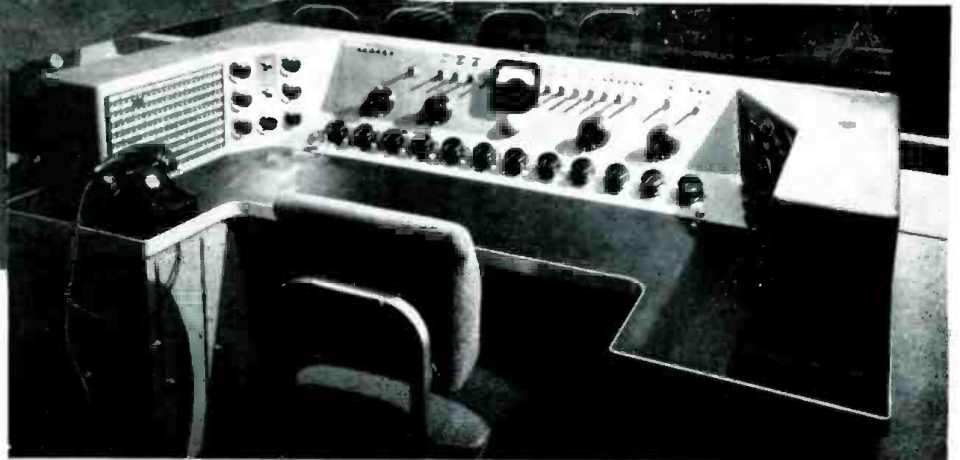

Fig. 3 (below). View of de luxe Studio A control console illustrating convenient location of all controls.

though this installation was made in a room having a concrete floor, what might have been a problem of running conduits and cable troughs to the various racks was easily solved. RCA cabinet racks have 4-inch removable bases. These bases were removed and the racks mounted on two 5-inch steel channels which were laid on floor. These channels extend across the room in a continuous line (with a 6-inch offset for the center section). A false floor of wood is laid flush with the top of the 5-inch channels in back of the racks. Space under this is adequate for all the required conduits and cable troughs.

On the wall in back of the racks are located separate junction boxes for telephone, power, signal and audio circuits. All circuits coming into master control are cross-connected to terminal blocks in these boxes. Each studio has a block for audio and a block for signal circuits with the same arrangement for leads for all studios, both at the master control junction box and at the studio end. This makes for ease in tracing and remembering circuits.

#### Output Channel Switching

Referring to the block schematic, Fig. 2, there are ten inputs to the relay switching system with a possibility of feeding six output channels. A transformer converts the 600-ohm incoming circuits to 150 ohms for switching. These are terminated by a 150-ohm resistor. This termination is necessary, since all output channels are bridging and several (up to six) channels may take the same program. Each output channel consists of a bridging transformer, a master gain control, a BA-3C line amplifier, and a dividing network which feeds the regular line

and a monitor circuit. A VU meter, which is also fed from the dividing network, indicates the signal level to the line.

Each monitor circuit contains a BA-1A amplifier with a bridging volume control input. This prevents line disturbances in the monitor system from reaching the regular program channel. In addition to the six regular output channels there are six emergency circuits, each consisting of a bridging transformer and a BA-3C amplifier. Both ends of these circuits are terminated on jacks, thus providing complete stand-by protection for all channels in case of any emergency.

#### Remote Pickup Circuits

The handling of incoming remote programs involves two considerations, one being to maintain communication with announcers or operators at remote locations. This is done with a talking circuit usually referred to as an "order wire." The other consideration is to receive the incoming remote on a separate line, equalize it if necessary, and route it either direct to the master control switching system, or to a studio (depending on how the schedule is set up).

WMGM has 60 incoming remote lines, 30 of which have individual RCA type 56-C equalizers. Three type BE-1B variable equalizers are supplied to correct the characteristics of lines other than those which are permanently equalized. Twelve of

the lines are permanently normalised to two banks of mechanically interlocked push keys. The common output of each bank of push keys feeds a separate remote amplifier circuit which enables the signal to be adjusted to the proper level for feeding the switching system. The input to a third remote circuit is not connected to any switching device, but is terminated on jacks. Bridging transformers feed the remotes to all studios so that they may be handled in conjunction with a regular studio program. It is impossible to select the same incoming program on both switches at the same time. This requirement is necessary to maintain the proper load impedance and to preclude the possibility of a mismatch to the line, and is accomplished by having one set of switches wired in series with the other.

An amplifier circuit using a BA-4C is provided to feed cue to the remotes. By means of a selector switch, any one of the monitor buses may be fed to this remote cue amplifier.

#### Monitor System

There are three monitoring circuits, each consisting of a BA-4C amplifier and an RCA LC-1A high fidelity speaker. Input selectors to these amplifiers are connected to a monitor bus system consisting of 16 circuits with isolation amplifiers. Monitoring points available are the ten switching inputs and the six outgoing channels. To provide an additional check on



the over-all channel circuits, a bridging transformer is connected to the terminals where each channel output terminates in the rack. These six outputs appear on a six-position, mechanically-interlocked push-button switch, the output of which can be switched to the input of one of the monitor amplifiers to provide a final program check. Jacks are also available to provide means for additional checking and monitoring.

#### Other Features

A beat-frequency oscillator, feeding six BA-3C amplifiers, provides time tone signals which can override any regular program or announcement on each of the six output channels. Relays operated by the master clock provide "on-the-hour" tone beats.

Another feature at WMGM is that one of the studios (Studio "E") can interrupt the regular program on one or all output channels and feed those channels directly with a special announcement. This by-passes the preset selector system and normal operation is not restored until control is released by Studio "E." There is, however, a cutoff switch in the master control room which can take this control away from the studio. To preclude unwarranted program interruption through misuse of the Studio "E" channel-operate keys, power to actuate the override relays is fed to the studio only by order of station management. Lights in all studio control rooms as well as master control indicate when any channel is interrupted by Studio "E."

Amplifying equipment for two echo rooms is supplied. Each equipment consists of a BA-4C echo speaker amplifier, and a BA-1A echo microphone pre-amplifier. Tie trunks make

it possible to connect the echo circuits to any desired studio.

Two BA-4C amplifiers are bridged across output channel No. 1 and are used for feeding speakers in 15 offices.

Ample test equipment is supplied to provide the station with all the necessary facilities for measuring frequency response, noise, and distortion of any program circuit. Tie lines to the various studios make it possible to pipe studio circuits to master control to utilize this equipment. Spare line and bridging coils, as well as fixed pads of various losses, are provided and can be used as an aid in making measurements.

#### Studio Equipment

A deluxe studio desk, *Fig. 3*, was designed to provide in a single unit all operating facilities for the control of Studio A, which is one of two auditorium type studios in the WMGM operations. It was intended that this studio console should offer the maximum in fidelity, flexibility, reliability and operating convenience. Appearance was also to be of utmost importance considering the prestige of the station.

The desk is constructed entirely of steel and completely replaces conventional rack equipment with its associated console by providing a housing for all the amplifiers, power supplies, relays, etc. These components are mounted and housed in two pedestals which in a conventional type of desk would be reserved for drawer space. Each pedestal has a 2" x 6" opening in the back which is connected to an air conditioning duct in the wall. This provides enough cool air to prevent abnormal temperature rise due to heat from the amplifiers. An air filter is placed over the

duct opening to keep dirt from the pedestal out of the ducts.

Each pedestal has three compartments. Doors to these compartments are flush-fitted and each is supported by a continuous piano hinge, as seen in *Fig. 4*. In the left pedestal there is one large compartment with a door opening to the inside of the desk. There are three shelves in this compartment on which are mounted eleven preamplifiers, two power supplies, and several line and bridging transformers. Amplifiers and power supplies are of the plug-in type. Therefore the removal of these units for any reason is a simple matter.

Another smaller compartment, opening to the inside, contains two circuit breakers and pilot lights, a switch for emergency relay voltage and a meter for checking the amplifier tubes. Two selector switches pick up the metering terminals of these amplifiers.

The third compartment contains terminal blocks for connecting to external a-c and d-c power circuits as well as incoming microphone lines. This placement of terminal blocks facilitates trouble-shooting when it is necessary to check external circuits to the desk. Needless to say, the desk installation was less of a problem than with the terminal blocks in some out of the way place.

The large compartment in the right pedestal has 3 shelves, contains six booster amplifiers, two program amplifiers (one regular and one emergency), one power supply, and a studio monitor amplifier.

A second compartment contains a small jack field for all speaker circuits. Since these are high level circuits, this location affords the isolation desired and keeps all loudspeak-

**Fig. 5.** In Studios C and D, a standard RCA 76-C consolette is used in conjunction with auxiliary custom-built side turrets (jack bay at right—and sound effect filters, echo controls, cue selector and supervisory lights at left). Space is provided for turntables at each side of the operator's position.



er jacks out of the main jack field. The studio speaker volume control is in the voice coil circuit and is located in this compartment for the same reason. The balance of space is used for the storage of patch cords when they are not in use.

The third compartment contains audio terminal blocks and speaker relays as well as a volume control for studio headphones. The terminal blocks are placed so that external wiring connections are easily made. Conduits which carry wiring to the terminal blocks come up into the terminal block compartments and are stubbed about two inches above the floor.

The sides or ends of the desk pedestals which are fastened with concealed screws were removed during the time the desk was being wired to provide easy accessibility to all amplifier plug terminals.

Mounted on the desk top is a continuous turret which extends from the left of the operator around to his right. Since the height of this turret is only 39 inches above the floor, adequate visibility into the studio is enjoyed by the control operator while seated at the desk.

The most essential controls are mounted on a panel directly in front of the operator. This panel is hinged at the top for access to any parts requiring maintenance. Two slopes to this control panel provide maximum operating convenience.

There is a jack bay on each side of the control operator, each bay containing 99 pairs of jacks. Access to jack wiring is gained by removing a panel in the back of the turret. Each jack bay turret is joined to the center panel turret thus providing enclosed space for mounting additional equipment, such as PA volume controls, echo mixers, sound effects controls, etc. These controls require

only occasional adjustment, so they need not be part of the main panel. Access to each side compartment is by a hinged lid, flush-mounted in the top.

#### Producer's Desk

An added feature of this studio control equipment is a producer's desk, *Fig. 6*, which is styled similar to the control desk, except it has no over-all control turret. The left end of the desk has a pedestal exactly the same as the pedestals on the main console. The right end fastens to the main console so that it becomes part of it. In the left pedestal are mounted two auditorium PA speaker amplifiers and one client's speaker amplifier, both of type BA-4C. This compartment also has connections to an air-conditioning duct.

The producer's controls consist of a studio talkback microphone with associated "operate" switch and an interval timer used principally for timing shows during rehearsals. These producer's controls are mounted in a small turret placed on the desk.

#### Program Control Facilities

All mixing, amplifying, monitoring and special-effect facilities required to produce and control a program are contained within the control console. A twelve-position mixer which permits simultaneous mixing of ten studio microphones and two incoming remote lines is incorporated in the design. The first six mixer circuits are controlled by one program key and each of the other six mixers has an individual key for cutting the circuit in or out. This feature is especially advantageous for the control of large programs using an orchestra with a multiple microphone pickup. It is possible to cut in single microphones for announcers or vocalists while fading the entire orchestra down with a single control.

Each bank of six mixers feeds into

a separate booster and master gain control. The outputs of these gain controls are combined by a matching network to feed a single channel into a BA-3C amplifier. A spare channel is available for emergency service. A key is provided to feed either channel to master control.

A three-position echo mixer circuit with bridging transformer inputs and a BA-1A booster is supplied. Reverberation characteristics may be applied to as many as three microphone channels by patching from a pre-amp output multiple to one of the bridging transformer inputs. The BA-4C for feeding this signal to the speaker in the echo chamber is located in master control. The echo microphone pre-amplifier, which is also in master control, feeds the signal back to the studio on a tie line. As this is a 600-ohm circuit, it must be patched into an unused mixer position to be combined with the normal program. Two sound-effects filters are supplied to obtain a wide variety of effects in conjunction with the reverberation facilities.

Another three-position mixer circuit with bridging inputs is provided to reinforce certain microphones for the benefit of the studio audience. Microphone reinforcement is often desired by certain radio artists as well.

The output of this mixer system and associated booster amplifier feeds two BA-4C amplifiers, each driving an LC-1A speaker concealed in the proscenium. Gain of the PA amplifiers may be controlled by a person in the back of the auditorium, thereby assuring the proper speaker level for any size audience and at the same time preventing acoustical feedback. Usually it is necessary only to reinforce dialogue, sound effects, vocalists, announcers, or special features and not an entire orchestra playing on the stage.

There are three input possibilities to the monitor amplifier feeding the control room speaker and a studio speaker. The input is normally connected to a dividing network in the output of the program amplifier as a regular monitor. A key transfers the input to a rotary switch for selecting a cue for the studio from any of 16 monitor buses in master control. The studio talkback circuit is connected to the monitor amplifier through a relay which disconnects either the cue or monitor circuits. Two microphones are provided, one on the console control panel and one on the producer's desk. Each is connected to the talkback circuit by a key which operates the talkback relay. When either talk-

[Continued on page 39]

Fig. 6. Closeup view of producer's turret as used in studios A,B,C, and D.

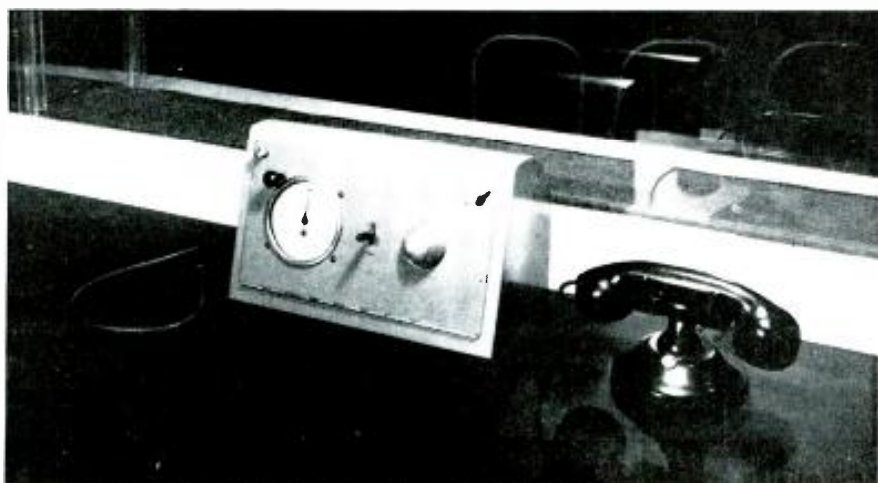

KNOW ABOUT

# Acoustalloy?

Acoustalloy  
Diaphragm  
Product of  
E-V Research



ALONE  
HAS IT!

IT BRINGS  
BETTER  
MICROPHONE  
PERFORMANCE!



**Smoother, Wider Range Response  
Extremely Rugged Service**

*ACOUSTALLOY* is the amazing new *non-metallic diaphragm* developed by *Electro-Voice* engineers and utilized so effectively in *E-V* dynamic microphones. Its remarkable characteristics create a new concept of performance. It makes possible *higher output level* and *smoother wider-range frequency response*. It is practically indestructible . . . withstands high humidity, extreme temperatures, corrosive effects of salt air and severe mechanical shocks. There's a better *E-V* microphone for every need.

*Write for information.*

**ELECTRO-VOICE, INC., BUCHANAN, MICH.**  
Export: 13 East 40th St., New York 16, U. S. A.  
Cables: Arlab

NO FINER CHOICE THAN

## Electro-Voice



The "650"  
Broadcast Dynamic



The "645"  
Broadcast Dynamic



The "CARDYNE"  
Cardioid Dynamic



The "600-D"  
Dynamic Mobil-Mike

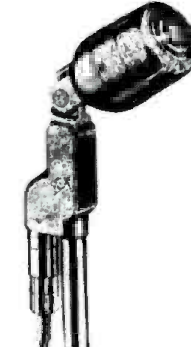

The "635"  
High Fidelity Dynamic

# RECORD REVUE



EDWARD TATNALL CANBY\*

**P**ENDING actual distribution (April) of the Victor 45-rpm record a large amount of somewhat futile discussion is going on as to (a) which system, 45 or 33, is better technically, and (b) which company is the best justified (or the most damned) in its position. It is over this last that the general public is very hot and bothered, not to mention the trade. This department has some private views but it seems at this point an excellent idea for all of us to put aside the question of blame entirely, as a practical consideration. Not a thing can be done about it now anyway. Nor is there the slightest hope that any of us will be able to get to the bottom of the highly complex inside negotiations and maneuverings that have been going on these many years past in respect to new-type records, before any public announcement was made. I have heard statements of responsible officials on both sides: they emphatically do not agree, even as to points of plain fact. The discrepancies aren't worth investigating nor is there any use expecting agreement, for by now this whole schism has become such a matter of personalities, of company prestige, justification and rationalization, that it would take a congressional investigation and more to establish the whole story in objective terms—and to what purpose?

Rather, let's concentrate on the facts of the present, on the merits and demerits of the divergent systems—there's plenty of room for argument from now until doomsday and, for that matter, not a little fun in the arguing for those of us who are in the sound field. (A lot of us, strictly on the Q.T., of course, are taking a certain ill-disguised pleasure in the complications of the new three-speed era!)

It's a good moment, then, with LP well established and the Victorgroove record still unmarketed, to take a bit of stock on the LP records, as I'm finding them in constant everyday usage. As a musician—and this I can't say too strongly—I am more than enthusiastic about the long-playing achievement. Space-saving, yes. But it is hard for a non-musician to realize how much the *unbroken* performance of a longer work adds to musical enjoyment. I wouldn't have believed it myself. The LP record is something more, it seems, than merely a longer record. It takes recorded music right out of its own field, into the "actual performance" feeling of a radio or a live concert. The difference is startling. The constant 4-minute breaks (however short) of the old system, manual or with changer, the intense awareness of the progress of the pickup across the record,

so rapidly, back and forth, back and forth, the subtle sense of timing one develops, anticipating nervously the inevitable approach of each side's end simply by the sense of elapsed time, so that an extra-long side has one on edge with tension, waiting for it to end—these familiar disturbances, almost unnoticed after years of conditioning to short records, suddenly turn out to have been of vital psychological significance in the listening process, now that they are vanished. Play a whole, unbroken, LP side for yourself, of a familiar piece, and see. The long-playing record is, for all lovers of music-at-length (as opposed to those who can enjoy only short slices) an absolutely fundamental advancement. Worth all the troubles, major or minor, that may crop up. This is no plug for an individual record company but a heartfelt and purely subjective reaction, and you will find it widespread right now. I will be curious to see how Victor's quick-action changer stacks up in the hearing against this competition—but let that wait until April.

The troubles of course do come. I haven't had LPs long enough to be conscious of wear, though my sapphire (Astatic FL-33) is supposed to be better in this respect than the metal LP points. I am occasionally disturbed by a good many ticks and swishes not supposed to be heard on LP. Pressing trouble. But two much more serious troubles are scratching and dust. Scratches are painfully easy to make and their sound is magnified by micro-groove. Merely pulling the records from their cardboard casings seems to do damage. Even finger marks may sound in the playing. As to dust, the records, so far, have arrived dusty, and in typical plastic fashion have immediately picked up all the free dust available in the nearby air. I've been using a damp soft cloth—even so, the dust clings and the rubbing of it into the grooves is a dangerous business, wet or dry. Blowing or shaking is quite useless, I've even taken to flowing tap water across the record to wash out as much dust as possible without rubbing. A nuisance.

It is right here, I suspect, rather than in matters of technical quality, that the greatest trouble with both LP and Victorgroove records will be found for most of us collectors. These records just can't be treated as casually as shellacs, in spite of their unbreakability. The small, close groove, the quiet surface which, paradox-

ically, shows up the slightest added noise (where noise was drowned in the shellac hiss), the relatively soft and scratchable material, above all the static charge that sticks the grit on—all this means that we'll have to treat plastic, small-groove records with extreme care if we plan to keep them for a reasonably permanent library. I suspect that a good many record collectors will continue to patronize the shellac market for these very reasons.

Engineers at this point are busy with slide rule or equivalent arguing as to whether RCA or Columbia has the better groove speed for optimum performance, taking in all factors. The question would seem a fairly simple one, and yet it is over just such simple matters that the scientific mind can get most het up! Again, I've run into what seem to be directly contradictory statements here. The question is interesting. My impression is, at the moment, that LP loses to Victorgroove in its inner portion, but being a much larger record—the 10 and 12 inch sizes—it has a considerable outer area in which the groove speed is better than Victor's or as good. (The Columbia 7 inch record is another matter.) Columbia claims that, even so, its inner grooves are far better than those of the standard 78 record. As always, this department dodges all mathematics in favor of the ear. So far, my ear definitely confirms Columbia. I have yet to hear an LP record that was noticeably bad at the inside, or even noticeably different between inner and outer grooves; whereas 78 rpm records with poor inner grooves are as we all know painfully common even in the best circles. (Ouch!) But in any case, note this well: that though technically and on paper the 45 rpm record may well show a better overall potentiality than the 33, the slight difference in quality attributable to this factor will be far less noticeable to the ear than many grosser differences in the qualities of the original recordings. Of this I am quite sure. Whatever the technical answers, I continue to be astonished at the music that comes forth from the LP record and in the long run, in spite of difficulties, I find it clearly preferable to most 78 rpm music, from which it has been dubbed! So it stands, pending trial of the Victor record.

Though that record itself isn't with us yet, I feel that some points made in advance by RCA are at least open to question, if I interpret rightly. One point, as I get it, is the implication that records at 33½ were tried by Victor and not accepted by the public. There can be no possible comparison between the Victor Long Playing record of 1933 and the present micro-

[Continued on page 36]

\*279 W. 4th St., New York 14, N. Y.

# 66-G

## Here's the Recorder You asked for!

The best features of Presto's dual motor gear drive with the overhead mechanism and turntable of the famous Presto 6-N.

YES, engineers have often asked us for a compact, economical yet high-quality recorder. Now you may have it in the Presto 66-G for standard and microgroove recording.

Here is a unit ideally suited and priced for the typical broadcast station or large transcription manufacturer. List price, Standard Model, \$996! (\$70 additional for microgroove.)

Here's perfection in total speed regulation and very low mechanical disturbance, thanks to the standard Presto dual motor gear drive. Here's high-quality recording, too, for the 66-G, of course, includes the Presto 1-D cutting head.

You'll find 66-G equal to the most exacting recording tasks when used with suitable amplifiers such as Presto 92-A recording amplifier and 41-A limiter amplifier.



### FOR HIGHEST FIDELITY... IT'S PRESTO DISCS

Microgroove, even more than standard recording, demands a perfect disc. The answer is Presto. For, sixteen years ago, Presto made the first lacquer-coated discs... and today Presto discs are first in quality.



RECORDING CORPORATION

Paramus, New Jersey



### READY NOW: Magnetic Tape Recorder

Presto will show its new super quality magnetic tape recorder at Booths 25-26 at the I.R.E. Show, March 7th. Be sure to see it!

Mailing Address: P. O. Box 500, Hackensack, N. J.  
In Canada: WALTER P. DOWNS, LTD., Dominion Sq. Bldg., Montreal

# NEW PRODUCTS

## NEW SCOTT SUPPRESSOR

New changes in the output transformer and chassis finish of the H. H. Scott 210-A Laboratory Amplifier with Dynamic Noise Suppressor have resulted in substantial improvements in its performance and appearance, without sacrificing any of the compactness and fine design that characterize the unit.



The new oversize output transformer provides remarkable freedom from distortion and reduces hum level to 86 db below maximum power output under normal operating conditions, the actual hum power level being only 0.05 microwatt. Such a rating is generally achieved only in equipment manufactured for broadcast use.

A new anodized aluminum chassis eliminates tarnishing, and is extremely durable against the rubbing and chafing of constant use.

The 210-A's functional design is accentuated by the massive transformer, and the chassis finish provides a much sleeker appearance.

## SOUND PROJECTOR

An important addition to the line of Hypex projectors designed and built by



Jensen Manufacturing Company, is the new Model VR-241 ST-789 Hypex projector, the first of the "Three-sixty" series

of radial projectors. The Hypex flare formula gives improved acoustical performance, particularly at the lower frequencies. With sound distribution over a complete circular area, this projector is intended for installations where coverage of relatively large areas and suspension from the ceiling are desired.

## ISOLATION TRANSFORMERS

Three isolation transformers, with 50, 150, and 250-VA capacities respectively, have just been announced as new catalog items by Chicago Transformer Division, Essex Wire Corporation, 3501 W. Addison St., Chicago, 18, Ill.

Designed for dual purposes, they are suitable either for (1) adjusting high or low line voltages to operate radio, television, and other equipment on a normal 115 volts, or (2) promoting safer, more efficient servicing or experimental work on electronic gear by isolating chassis grounds from line grounds—particularly



useful in eliminating shock hazard on AC-DC television sets. Besides providing a standard 115 volts, the secondaries of these transformers will also supply 125 or 105 volts for use in locating faulty set components. Complete description and prices on request.

## CERAMIC-ELEMENT MIKES

Just started through the Astatic production lines is the new Cardinal Microphone with ceramic element, a multi-purpose, compact unit streamlined for hand-held use like an electric razor. A felt padded back lets it lie flat on desk or table, where it may be talked across. Accessories include a base that serves as a desk stand; an adapter for attachment to all conventional floor stands; a hang-up bracket for mobile communications, etc. The heat-immune feature of the ceramic element is of obvious importance in the latter applications, due to high temperatures of car interiors in summer months. An off-on switch adds convenience to the Cardinal's wide utility.

The Cardinal has substantially flat response from 30 to 10,000 cps. Output



level is -62 db. Recommended load impedance, 5 meg.

Somewhat less universal but also a convertible type is the Astatic Velvet Voice Microphone. Case and handle lift from a circular, desk-stand base for hand use or attachment to floor stand. The Velvet Voice model will be recognized by many as one of the most popular Astatic products in crystal and dynamic types. The same smooth, even response that prompted the name of the original units is claimed for the new ceramic model. Frequency response of the Velvet Voice Ceramic also is 30 to 10,000 cps.

The Model "QC" Pickup Cartridge with ceramic element is announced as offering



a new level of physical ruggedness, in addition to its other advantages. It has a frequency range of 50 to 10,000 cps. a needle pressure of one ounce.

Immediate availability on all three products is offered by the manufacturer.

[Continued on page 34]

## PROFESSIONAL DIRECTORY

**C. J. LeBEL**  
AUDIO CONSULTANT

370 RIVERSIDE DRIVE  
NEW YORK 25, N. Y.



PRODUCT DESIGN - INSTRUMENTATION  
PSYCHO-ACOUSTICS - SOUND RECORDING  
ELECTROMEDICAL - SUBMINIATURE AUDIO

Custom-Built Equipment

**U. S. Recording Co.**

1121 Vermont Ave., Washington 5, D. C.

STerling 3626

**Winston Wells**

Designer and Consultant

Acoustical and Electronic Research

307 East 44th St.

MU 4-3487

New York 17, N. Y.

**This is actual  
SOUND-ON-FILM  
RECORDING  
performance**



When you can secure the quality of results shown in these graphs, can you afford to use any recording equipment that does not approach such a standard?

On the basis of definite performance, the Maurer 16-mm Recording Optical System — the only postwar designed equipment of its kind on the market — is unrivaled in its field regardless of price.

And the Maurer 16-mm System has already been selected by two of the four major radio networks for their television requirements.

• • •

Anticipating a demand for finer quality of recording, including the higher frequencies, the Maurer Recording Optical System was designed to produce an extremely fine line image that makes possible the recording of frequencies beyond 10,000 cycles, with very low distortion. The galvanometer of the postwar Maurer Model 10 System is tuned to 12,000 cycles. This is the model that has been sold to the trade for two years.

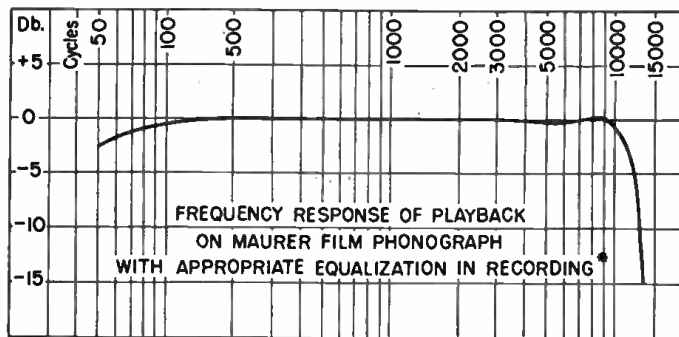
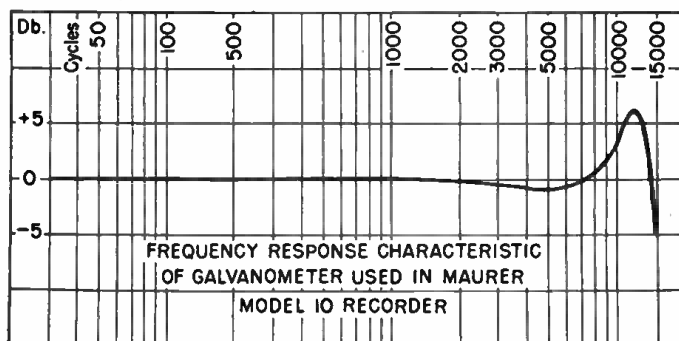

\*For those who may have been educated to believe that such a result is not possible with 16-mm film, we shall be glad to demonstrate that it not only is possible, but practical commercially NOW.



**J. A. MAURER, INC.**

37-01 31st Street, Long Island City 1, N. Y.

Professional Motion Picture Cameras and Recording Equipment for the Production of Industrial, Educational and Training Films

**THE TURNER MODEL 22**



**PREFERRED FOR PERFORMANCE**

**Time-tested general-purpose crystal or dynamic microphone**

The most popular general purpose microphone on the market. The Turner Model 22 has an exceptionally smooth response that appeals to discriminating users yet the price is moderately low. A great favorite with amateurs and widely used in paging and call systems, recording, and general sound work indoors or out. Fully shielded to prevent r-f pickup. Distinctive modern styling and rich satin chrome finish. Equipped with full ninety-degree tilting head and quick-change removable cable set.

**MODEL 22X CRYSTAL**

high quality humidity protected crystal in mechanical shock proof mounting. Response: 50-9000 c. p. s. Level: 52 db below 1 volt/dyne/sq. cm. List . . . . . **\$20.00**

**MODEL 22D DYNAMIC**

featuring high quality Alnico magnets in well balanced acoustic circuit. Response: 50-9000 c. p. s. Level: 24 db below 1 volt/dyne/sq. cm. at high impedance.

200, 500 ohms, or high impedance . . . . . **\$25.50**  
50 ohms. List . . . . . **23.50**

**ASK YOUR DEALER**

**TURN TO TURNER FOR SOUND PERFORMANCE**

**THE TURNER COMPANY**

929 17th STREET N. E. • CEDAR RAPIDS. IOWA



**MICROPHONES BY TURNER**

Licensed under U. S. patents of the American Telephone and Telegraph Company and Western Electric Company, Incorporated. Crystals licensed under patents of the Brush Development Company.

**NEW PRODUCTS**

[from page 32]

**LP RECORD PLAYER ATTACHMENT**

A new LP record player attachment has been developed which fits all types of existing record players, manual or automatic, without requiring installation.



Full information and detailed literature may be obtained by writing to American Microphone Co., 370 South Fair Oaks Ave., Pasadena 2, Calif.

**AUDIO PROBLEMS**

[from page 23]

and studios should be left until later when the associated electronic problems can be included.

Only after establishing a firm foundation in the first two phases of audio engineering is it worthwhile to begin a general study of the applications of electronic devices to problems in audio engineering. This study should not include any material on electronics itself, but should result in a set of specifications for various units of electronic equipment needed for optimum audio results. Included should be a study of optimum conditions for pick-up, transmission, and reproduction of sound, and an analysis of the meaning of high fidelity.

It will be necessary to review the fundamentals of electronic components, basic circuits including equalizers, amplifier theory, amplifier operation, and the basic principles of transducers, but before going on to amplifier design, a more complete study of transducers must be made. To do this it is possible to use either dynamic analogies or classical electro-mechanical theory. In view of the excellent treatment of dynamical analogies by Dr. H. F. Olson in his book bearing that title, it is possible to do a thorough job on this subject and one which can be related easily to electronic circuit theory. Once the operation of transducers is understood we must make some revisions in our specifications for the electronic units which were discussed above. The study of amplifier design may then be undertaken.

In the work on transducers the subject of musical instruments, acous-



tical impedance-matching systems, and resonant systems should be included, and comparisons should be made with their electrical equivalents. While electronic equipment is an important tool of the audio engineer, it is not the only one and should not be weighted heavily. Electronic engineers are available who have far more knowledge of their field than the average audio man will require, so that the highly complex problems involving transient response, feedback, and servo systems should be left for advanced study in the field of audio or electrical engineering. These items and their application and effects should be noted, however, and some simple examples should be included in the course.

#### Sound Transmission Systems

When the study of electronics has been completed it will be possible to examine complete sound transmission systems involving microphone pickup, transmission by electronic equipment, and reproduction of the amplified signal at remote locations. Here, an investigation of audio facilities for sound reinforcement, broadcasting, and recording may be made. This should include a review of the requirements for such facilities, the practices normally used in the industry, including the vu, measurement equipment, and the types of measurements normally made, along with their significance. A well-rounded course may include, if time permits, a detailed review of the problems involved in the specialized phases of audio engineering, which covers the special requirements of hearing aids of all types, recording equipment, specialized forms of audio-frequency modulation such as used in FM, television, and pulse time; articulation testing, and so on. However, there may not be time to cover many of these topics, and in this event the student should be given a list of references, or better still a complete bibliography covering them.

One of the most important subjects in audio engineering is the design of auditoria and studios. In covering the material on their design, there are many ancillary problems which the audio man must be prepared to handle. These problems include lighting, heating, ventilation, and seating. Unless certain limits are placed on the architecture of the structure it may be acoustically perfect, but useless for audio purposes because of the psychological or physical discomforts forced upon the audience. The artists who perform in the studios are subject to the same considerations.

Table I shows briefly two possible



"Equalizes 'em all!"

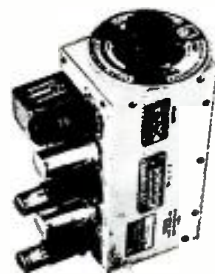

It is no longer necessary to use a separate equalizer for each pickup. The 622 Six Position Equalizer, usable with any and all modern pickups, mounts on your transcription table in place of your present equalizer. You can now experiment with various pickup cartridges knowing you are getting the best available performance from each. Both lateral and vertical transcription arms can be connected and selected without switching—by simply using the proper setting of the 6-position control knob. A Micro-Groove arm may also be added. This Fairchild Preamp-Equalizer precludes obsolescence; frees one preamplifier; provides for cuing and monitoring; eliminates low level hum problems; and is an investment in economy. Write for complete details.

### FAIRCHILD PROFESSIONAL TAPE RECORDER



The Fairchild Professional Tape Recorder is the only top quality equipment designed from the start to deliver the ultimate in performance at a tape speed of 15 instead of 30 inches per second. New and advanced theory and design have resulted in performance which exceeds the requirements set by the latest proposed NAB specifications and formerly thought possible only at 30 inches per second. No compromise has been made in meeting the most exacting requirements for signal-to-noise, frequency response or minimum distortion limits. This means double the continuous recording time, half the cost of tape and

nicer controls of starting, stopping, spotting, editing, etc. 7½ or 30 inches per second operation may, of course, be included for special applications.

Nothing has been left undone to make this the finest professional tape recorder. However, despite its performance which we believe exceeds that of any other equipment regardless of price, it is being sold at the lowest figure our anticipated production will permit. Currently, orders are being scheduled for delivery in approximately 30 days at its present low price of \$2,750. Details are available for prospective users.

### MICRO-GROOVE RECORDING . . .

Are you aware that Fairchild Synchronous Disk Recorders and Transcription Arms are handling the rigid requirements of recording and reproducing Micro-Grooves for the most critical users? Write for detailed information.

### LIP SYNCHRONOUS Sound-on-Film

Synchronous disk recording and playback for use with motion pictures and television is available with the Fairchild #539 Portable Disk Recorder.

Used in making "Louisiana Story", one of the top ten movies of 1948! Write for details.



We're  
at the  
I.R.E.

154TH STREET AND 7TH AVENUE, WHITESTONE, NEW YORK

# Floating Action!

## for all TV Cameras

### "BALANCED" TV TRIPOD

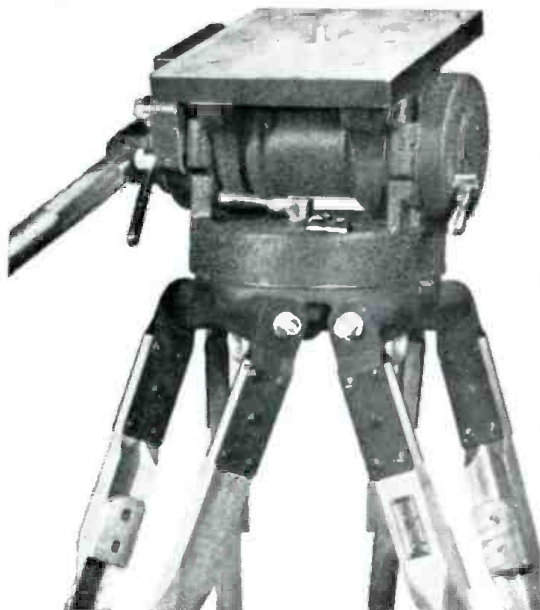

Pat. Pending

This tripod was engineered and designed expressly to meet all video camera requirements.

Previous concepts of gyro and friction type design have been discarded to achieve absolute balance, effortless operation, super-smooth tilt and pan action, dependability, ruggedness & efficiency.

Below:

3 wheel portable dolly with balanced TV Tripod mounted.

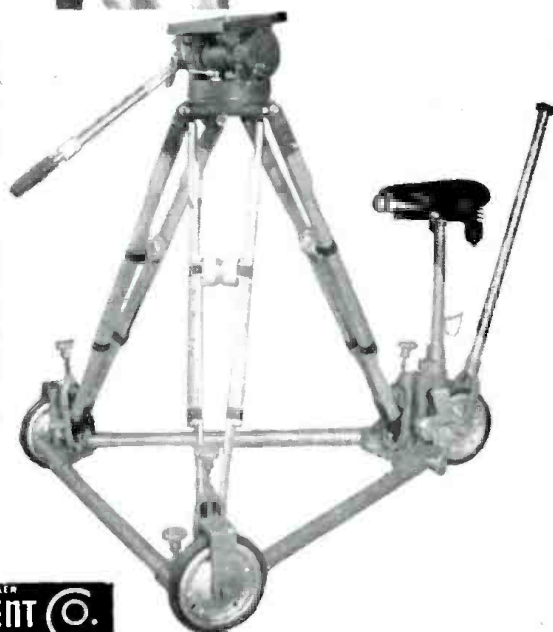

Complete 360° pan without ragged or jerky movement is accomplished with effortless control. It is impossible to get anything but perfectly smooth pan and tilt action with the "BALANCED" TV Tripod.

Quick-release pan handle adjustment locks into position desired by operator with no "play" between pan handle and tripod head. Tripod head mechanism is rustproof, completely enclosed, never requires adjustments, cleaning or lubrication. Built-in spirit level. Telescoping extension pan handle.

Write for further particulars

FRANK C. ZUCKER  
**CAMERA EQUIPMENT CO.**  
 1600 BROADWAY NEW YORK CITY

**BUY**  
 ★ U.S. ★  
**SECURITY BONDS**  
**NOW!**

#### WANTED

Western Electric Vacuum Tubes, Types 101F, 102F, 272A or B, 310A or B, 311A, 313C, 323A, 328A, 329A, 348A, 349A, 352A, 373A, 374A, 393A, 394A, 121A Ballast Lamps. Box 100, Audio Engineering.

#### WANTED

W. E. Carrier Telephone and Carrier Telegraph Equipment and components. Filters, repeating coils, transformers, equalizers. Type CF1, CF2, H, C, and other carrier equipment, telephone and telegraph repeaters. Box 101, Audio Engineering.

methods of arranging material for the course as outlined above.

#### TABLE 1

##### Hearing

Definition of sound—structure of the ear—mechanism of hearing—characteristics of the ear—Weber-Fechner law—decibels—pitch scales—musical sounds—articulation—intelligibility.

##### Sound Waves

Definition of terms—plane wave motion—the wave equation—energy in a plane wave—intensity—point source—dipole source—strings, pipes, and plates—musical instruments—speech.

##### Architectural Acoustics

Decay of sound—reverberation—treatment of enclosures—insulation—liveness, articulation, intelligibility.

##### Sound Spectra

Music—speech—noise.

##### Requirements for Electronic Devices

Microphones—amplifiers—loudspeakers—attenuators—filters and equalizers—high fidelity.

##### Circuits and Components

Components—equalizers—amplifier theory—amplifier operation—distortion, noise, isolation.

##### Dynamical Analogies

Components—analogies—the transducer group—ear—filters—resonators—musical instruments—impedance matching systems.

##### Amplifier Design

Theory—practice—feedback—transients.

##### Sound Transmission Systems

Review of requirements—conditions of pick up—audio facilities—reproduction equipment—practice—vu—measurements—recording systems—audio-frequency modulation—hearing aids.

##### Design of Auditoria and Studios

Requirements—acoustical design—lighting—heating—ventilation—seating.

(For engineering colleges the first and second groups may be reversed.)

This article is an outline of the fundamental considerations in the selection of material for a course in audio engineering. There are other possibilities, but this outline has proved effective in the author's course at Stevens Institute of Technology. It is hoped that the material will be of value both to instructors interested in preparing courses in audio and to the audio neophyte who would like to study audio, but does not know where to begin.

#### RECORD REVUE

[from page 30]

groove LP. The old record was quite inadequate in quality, since it compared unfavorably with equivalent 78 rpm repro-

duction of the same recordings. (I made comparisons at the time.) But above all, it used a standard groove, and the necessary compromise between length of play and quality was impossible from the start—the first records were poor in quality; the latter ones, improved, ran barely eight or nine minutes a side. Two standard sides, compared to a maximum of six on the present I.P. No stigma can be attached to this failure—equipment was inadequate all along the line then and the effort was a futile but highly enterprising and progressive one. Nevertheless, there is no possible comparison between the old record and the present LP development.

The other point I question is that, as I understand the argument, RCA is contributing to standardization in the industry by offering a record and player expressly designed for each other. Standardization—yes, on RCA lines; but hardly standardization in the usually accepted sense, which means an agreement between many parties on what is almost inevitably a compromise between divergent viewpoints, divergent necessities. Whether it is Victor or Columbia that is acting unilaterally is an undecided question.

#### Recent Recordings

Hindemith, Quartet in E flat (1943).

Budapest String Quartet.

Columbia MM 797 (3)

● Here is a fine example of wide-range recording of four stringed instruments. There have been a number of Budapest Quartet albums since the war, all wide-range, but often rather badly done from the acoustic viewpoint. The instruments are seemingly too close and sharp, the liveness not live enough. This one (perhaps it is the music itself) has a fine, live sound, but still is nicely sharp and edgy. The quartet seems big and round, as it should be. The music is not too difficult—it is solid, uncompromising. "pure music"—that is, without extra-musical effects, story, etc. But after a few hearings it comes out friendly and rich to the ear, with easily recognized themes, treated directly and simply.

Rachmaninoff, Rhapsody on a Theme of Paganini.

Artur Rubinstein; Philharmonia Orch., Susskind.

RCA Victor DM 1269 (3)

● This is a rip-snorting set of variations for huge orchestra and huge piano, a late work of Rachmaninoff but hardly what is normally called "modern". The catchy tunes in some of these variations have turned up as themes for radio shows, which'll give an idea of their category. Rich as a chocolate malted. (with whipped cream and nuts), expertly made, fabulously difficult to play, entertaining to listen to, but in the long run pretty empty music—considering the number of notes! This is technically the top performance, with beautiful piano and orchestra; there are other RCA versions by Rachmaninoff himself and by Moiseievitch—the latter most likely the best musically of all.

Beethoven, Egmont Overture.

Boston Symphony, Koussevitsky.

RCA Victor 12-0288

Brahms, Academic Festival Overture.

Boston Symphony, Koussevitsky.

RCA Victor 12-0377

Weber, Jubilee Overture.

Minneapolis Symphony, Mitropoulos.

Columbia 12891-D

# FEATURES NEVER BEFORE AVAILABLE IN A V.U. METER MULTIPLIER

FIVE STEP STRAIGHT "T" CIRCUIT

ONLY 1 3/4" DIAMETER

IN ATTENUATOR "OFF" POSITION:

1. Extra pair of Terminals for separate use of V.U. Meter.
2. "T" Network completely disconnected from line and meter.

TWO STANDARD ATTENUATION RANGES:

1. 0 (1mw) to +16 V.U. and OFF in 4 V.U. steps
2. +4 to +20 V.U. and OFF in 4 V.U. steps

CONTACT SPACING:

30° between adjacent steps

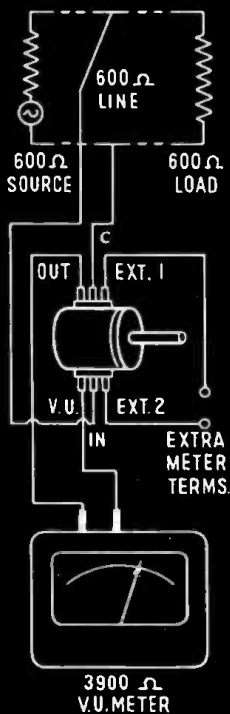
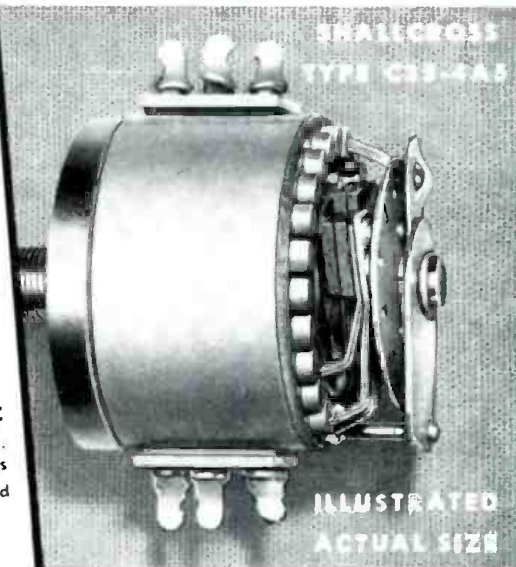

The ingenious electrical-mechanical design of these new type C35 V.U. Meter Multiplier Attenuators provides five step Straight T performance in a control size normally limited to ladder and potentiometer circuits.

A pair of extra terminals greatly increases the utility of this unit, since in the OFF position the V.U. Meter Multiplier network is automatically disconnected from the line which it normally bridges, and the V.U. Meter—completely isolating both.

As illustrated in the circuit at the left, the V.U. Meter is connected to the auxiliary pair of terminals on the Multiplier when in the OFF position, thus enabling the meter to be used for volume indication on another line, for tube checking and other purposes. Use of additional V.U. Meter Multipliers permits a single meter to be used for any number of lines with each line isolated from all others. The size and technical features of this new unit suit it ideally for use in consolettes.

Prices and delivery of this unit as described or as modified to meet your requirements available on request. Address: Dept. A-39, Shallcross Manufacturing Company, Collingdale, Pa.

# Shallcross

## Introducing

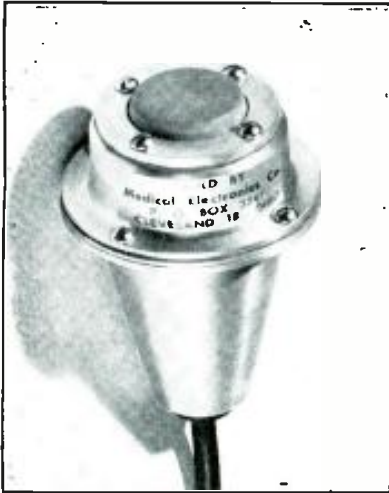

**The Model 102 Contact Heartbeat Microphone**, possessing high output level and uniform frequency response. Sturdy but lightweight aluminum housing is acoustically treated to reduce feedback and external noise.

Useful for detecting heart and other physiological sounds, or for experimental purposes.

For further information write  
**MEDICAL ELECTRONICS COMPANY**  
 P. O. Box 3541 Cleveland 18, Ohio

Mendelssohn, Ruy Blas Overture.  
 San Francisco Symphony. Monteux.

RCA Victor 12-0657

• A whopping group of overtures, each on a single record, each one split in the middle! All of these are separate works, written for special occasions or as introductions or incidental music, all are tuneful, brilliantly-ended. Egmont and Ruy Blas are more in the tragic vein, Jubilee and Academic Festival in the triumphant. All of them will make a fine show on your big phono outfit. The two Boston recordings are Victor's best pre-war, with good highs, fine brass and cymbals, a metallic brilliance, considerable distant-mike confusion and blur that, however, goes very well with the music. The Minneapolis Jubilee is closer, with a sharp wide-range sound, relatively deader acoustics—a bit too dead. Terrific cymbals, brass. Perhaps the best of all is the San Francisco Ruy Blas (it is decidedly the finest performance). This RCA West-Coast recording is big and resonant like the Boston records but softer textured, with better detail work, a broader, rounder perspective.

Copland, Piano Sonata (1941).

Leonard Bernstein, piano.

RCA Victor DM 1278 (3)

Schumann, Symphonic Etudes.

Alexander Brailovsky, piano.

RCA Victor DM 1272 (3)

• If you want a fine cross section of Victor's biggest and best piano recording, these two albums will do the trick—and you can triangulate by adding the Victor Horowitz "Pictures at an Exhibition" album. Victor's piano is peculiar to Victor, no question about it. A huge, triumphant, concert-hall sound, tremendous in overtones, richly clanging. It is particularly suitable to the Schumann album, and does

well by the dissonant Copland piece (though musically I prefer the Concert Hall Society recording by Leo Smit of the same.) The Schumann work is symphonic in the sense of being a big, broad showy work, unlike the more personal and intimate piano music that Schumann most often wrote. The last etude is one of his best known piano show pieces. The Copland sonata is dissonant, angular, quite harsh, but the sheer sound Copland gets out of the piano is interesting to most ears, as well as the strong rhythm and clean, un muddy construction.

Milhaud, Le Boeuf sur le Toit

("The Nothing Doing Bar") (1919).

Minneapolis Symphony. Mitropoulos.

Columbia MX 308 (2)

LP: ML 2032 (One side 10")

• A highly amusing piece right out of the early flapper days—corn, pure and simple, but so ingeniously dressed up musically and instrumentally that it's a very high grade vegetable. Semi-popular sounding tunes, served with plenty of old-style brass, faintly dixieland, an dlots of outlandish dissonance. It was put on as a wild stage show (with Jean Cocteau) in 1920—the famous Paris joint was apparently named after the show, not vice versa. The LP version is backed by a thoroughly worthwhile performance of one of Ravel's nicest works, the *Tombeau de Couperin*, a collection of short dance movements.

Debussy, Prelude a l'Apres-midi d'un Faune.  
 Philadelphia Orchestra, Ormandy.

Columbia 12891-D (1)

• A new, wide-range recording of one of the most popular orchestral works on records—but thinks to abnormally low-level music, the widened range doesn't do too much good. This is an example of the kind of music that suffers more in the wide-range playing—plus hisses that spoil its magic—than in a restricted-range playing that cuts out all highs, but leaves the music free of distractions. 99 musicians out of 100 would prefer it without the highs. Try especially the beginning and ending. The best effect is with a cutoff of around 3000! On LP this recording may be something else again: little hiss to mar the tonal edge. But as long as it is pressed on shellac it must remain a "low-fidelity" piece.

Beethoven, Cello Sonata in A, Opus 69.

Pierre Fournier, cello; Artur Schnabel, piano.

RCA Victor DM 1231 (3)

• Most people shy away fast from cello music, but here's one case where, if you like Beethoven, you'll like the cello. For once, the piano part in this cello-piano collaboration is given its proper value—in fact, the piano is actually stronger than the cello in the mike pickup (as, of course, it is in the live state, though most engineers make the cello sound like a ten-foot monster and the piano some tinkling miniature in the background!) The reason for this excellent balance is perhaps the presence of one of the greatest Beethoven pianists alive, Artur Schnabel. Nothing like a big name to raise the db's. In any case, the resulting sound is absolutely first-rate. This is a suave, easy-going piece with nice broad melodies—little of the hectic and the explosive that turn up in some Beethoven. Hamlet.

Laurence Olivier in excerpts from the film. Music by William Walton; Philharmonia Orch. Mathieson.

RCA Victor DM 1273 (3)

• Though the speech here is perfectly intelligible, the recording does not speak

## DESIGNED ESPECIALLY FOR TELEVISION MANUFACTURERS\*

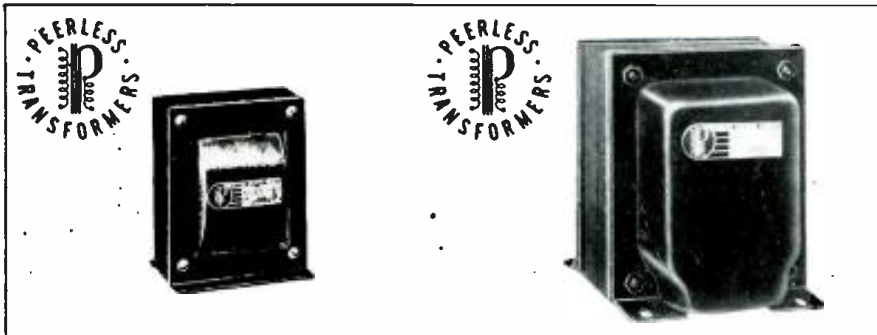

### Model 13837 CHOKE

5.5 H., 225 ma. DC. 70 ohms resistance. Size: 2 1/4" x 2 3/4" x 3 1/4"—Weight: 2 3/4 lbs.

PRICE—quantities of 500—\$1.68 ea.

Special quotations for larger quantities.

\*Changes in specifications will be made to meet individual manufacturers' requirements.

### Model 5678 POWER TRANSFORMER

Primary—115 volts 60 cycles  
 Sec. No. 1—800 volts CT, 225 ma. DC.  
 Sec. No. 2—6.3 volts, 8 amps.  
 Sec. No. 3—6.3 volts, .6 amps.  
 Sec. No. 4—5 volts, 3 amps.  
 Sec. No. 5—5 volts, 2 amps.  
 Size: 4" x 5" x 4 1/4"—Weight: 11 lbs.

PRICE—quantities of 500—\$5.72 ea.

Special quotations for larger quantities.

## PEERLESS ELECTRICAL PRODUCTS DIVISION

6920 McKinley Ave., Los Angeles 1, Calif.  
 161 Sixth Avenue, New York 13, N. Y.  
 Frazer & Hansen, 301 Clay St., San Francisco 11, Calif.  
 Exclusive Export Agent



too well for the present state of sound-on-film in England, as compared to disc recording. This comes "direct" from the sound track of the film—trouble might be in the copying. Whatever the reason, the tonal range is conspicuously less than in the fine British recording we usually hear today, the voice is a bit tinny; nothing to bother anyone but an engineer. The excerpts are wonderful for those who have seen the film; not so good for those who haven't, because Olivier naturally acts for the eye (the camera) as much as for the ear, and minus the picture itself his speaking part, all on its own, seems rather colorless and inexpressive. Even so, if you are a Shakespeare reader you will find this most absorbing, and the music (several sides' worth) is excellent, as movie music goes.

## WMGM Master Control

[from page 28]

back switch is operated, the control room speaker is disconnected and the studio speaker is turned on. Whenever the program line switch is operated, the power circuit to the studio speaker relay is broken, thus preventing talkback while the studio is feeding master control. During these periods, a talkback microphone booster is connected to headphones on the stage. These may be used by an announcer or a musical director for taking instructions from the booth during a broadcast. Also, as these headphones are normally in the monitor circuit, a musical director can hear the program as it is fed to master control. One BA-4C amplifier is provided to feed program material to a clients' booth which overlooks the studio.

Supervisory lights on the console are automatically controlled by the pre-set switching system and indicate to the operator when his studio has been pre-set as well as when his studio has been switched to an outgoing channel. When the operator closes his program key a light in master control is energized showing that the program circuit is complete from microphone to channel output.

### Facilities for Other Studios

The facilities for studio "B" are essentially similar to those for "A" but the remaining studios are equipped with standard RCA 76-C consolettes as the nature of program in these studios is not as complex as in Studio "A" and "B."

In "C" and "D," auxiliary equipment consisting of a jack bay, echo controls, sound-effects filter and a 24-position cue selector is supplied. This equipment, shown in Fig. 5, is built into two turrets with sloping panels, one turret located on each side of the consolette.

Studios "E" and "F" do not have a

# HERE IT IS!

## The New Somerset

### NOISE SUPPRESSOR\* PREAMPLIFIER

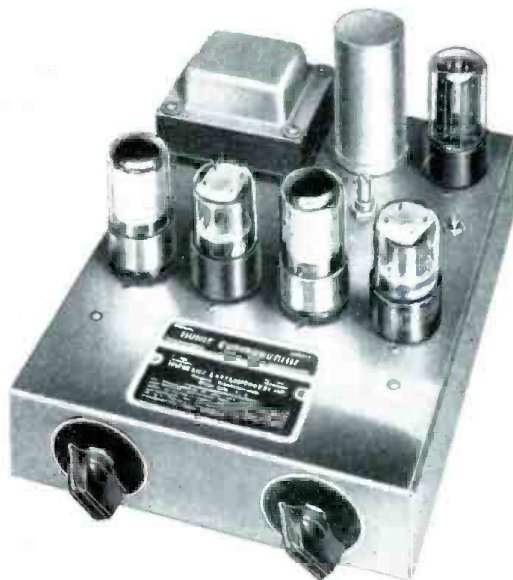

- Accomplishes a high degree of noise reduction — maintains natural brilliance and realism — essential overtones are reproduced at all volume levels.
- Introduces no unnatural tonal qualities in the reproduction.
- Can be used with most existing record players and FM or AM tuners.
- Installation and operation require no technical skill.

### SPECIFICATIONS:

**Power supply** — 115 volts, 50-60 cycles, a. c.

**Frequency range** — 40 to 15,000 c.p.s.

**Gain** — .01 volts input produces .8 volts output to volume control of .25 to 1 megohm.

**Input sources** — magnetic or crystal pickups, and FM or AM detector output.

**Tube complement** — 2-6SL7GT, 1-6SK7GT, 1-6SJ7GT, 1-5Y3GT.

**Size of chassis** — 7" x 9" x 2".

Also supplied in combination with a high quality power amplifier for custom and commercial installations.

For broadcast and other exacting applications, special designs are available.

Exhibited at I. R. E. Radio Engineering Show, Booth

"E" Grand Central Palace, New York City, March 7-10

\* Patents Pending

**SOMERSET LABORATORIES, INC.**  
**1701 Palisade Avenue,**  
**Union City, New Jersey**

## YOU CAN TELL THE QUALITY OF THE PLUG BY THE EQUIPMENT IT CONNECTS ↓

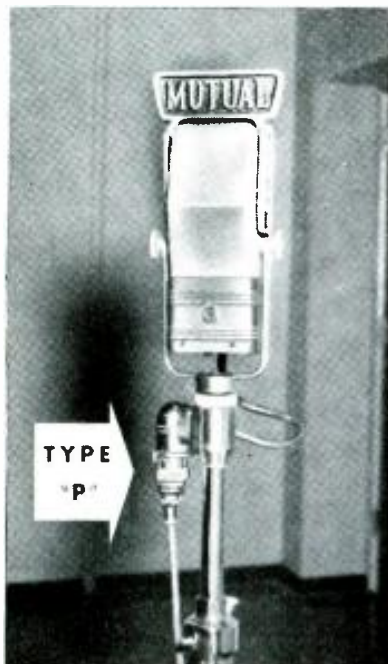

RCA microphone with Type P3-CG-11S Plug and P3-42 Receptacle on P-41b special curved mounting base in Radio Station KHJ of the Mutual Network in Hollywood.



The Type "P" Series is widely recognized by radio stations and sound technicians everywhere as not only the standard, but the leading series of microphone connectors. Prominent among its many desirable qualities is the patented latchlock which provides positive engagement and requires only the slight pressure of the thumb for release to disconnect. It will not pull apart accidentally.

Stocked or available from such radio parts distributors as Hughes-Peters in Dayton, Specialty Distributing in Atlanta, Lew Bonn in Minneapolis, Almo Radio in Philadelphia and more than 250 others.

For full information on the Type P, ask for Bulletin PO-248... And for prices RJC-2... Address Department C-109.

SINCE 1915

CANNON

↓

ELECTRIC

Development Company

3209 HUMBOLDT ST., LOS ANGELES 31, CALIF.  
 IN CANADA & BRITISH EMPIRE:  
 CANNON ELECTRIC CO., LTD., TORONTO 13, ONT.  
 WORLD EXPORT (Excepting British Empire):  
 FRAZAR & HANSEN, 301 CLAY ST., SAN FRANCISCO

jack bay or a sound-effects filter. However, Studio "E" does have the channel override controls mentioned previously.

A producer's desk and control turret similar to that in Studio "A" and "B" is furnished in both "C" and "D."

### Acknowledgement

The design of the above station facilities has resulted from combining the experience of WHOM engineers with the engineering and manufacturing resources of the Radio Corporation of America. All the equipment is of the latest design to assure the station high standards of performance, dependability and service.

## 6AS7G Amplifier

[from page 19]

signed for feeding a speaker or a 500/600-ohm line, but it is difficult to obtain optimum performance from a transformer designed for both types of output load. Consequently, the output transformer has only one output winding covering three speaker impedances.

### Control Section

The three tubes in the control section actually constitute five stages.  $V_1$  is a dual triode in a conventional preamplifier circuit, with feedback equalization to supply turnover frequencies of 350 and 500 cps. One section of the input selector switches the pickup, or grounds the first grid. The second section varies the turnover frequency, and adjusts it to 350 cps for microgroove records. The third section connects the amplifier to the phonograph level-adjusting potentiometer at the output of the preamplifier in positions 1 and 2, to the AM and FM potentiometers in positions 3 and 4, and to the preamplifier through a roll-off circuit in position 5 for microgroove records. Thus the long-playing records are normally reproduced on the position 2, the "flat" settings of the tone controls. Victor and Decca frr records reproduce best on position 3 of the high-frequency control, Columbias on position 4, and exceptionally noisy records on position 5. The treble control is numbered counterclockwise, the bass control clockwise.

The two tone controls are designed to work together and into a grid with no resistance loading, as is the volume control. Since feedback is introduced at the stage ahead of the driver, the volume control is placed between the two sections of  $V_2$ , the first section acting as a cathode follower.  $V_3$  is triode connected, and is shunt fed with the coupling capacitor in the cathode leg. This capacitor and the

cathode bypass for  $V_3$  are located in the power section.

The 6AS7G circuit is similar to those previously employed, with the 600-ohm 5-watt resistors in separate circuits, the 500-ohm potentiometer serving to balance plate currents, and the three heaters in series being connected between the arm of the balancing potentiometer and the negative side of the supply circuit. The 600-ohm value is used in the cathode circuits because of the drop across the heaters. The 7500-ohm resistor bleeds the additional 30 ma for the control section heaters.

Subjective listening to this amplifier has indicated excellent performance, but since thorough measurements are not yet available from the testing laboratory, they will be presented next month in Part II, along with details of chassis layout and wiring. A complete list of components will be furnished to anyone desiring them. Address your request to AUDIO ENGINEERING, 342 Madison Ave., New York 17, N. Y.

## Phonograph Preamplifier

[from page 16]

paring the music to the original rather than to some other reproducing equipment with which they were familiar.

Even though the curve of a particular record is not known, a little listening experience enables one to select quite readily the proper equalizing characteristic; indeed, in the case of many records, only one setting sounds at all satisfactory, others being very obviously wrong. Occasionally a record turns up for which no settings will provide any illusion of realism.

After having lived with this preamplifier for several months, we feel tempted to conclude somewhat as follows: The input data, upon which the whole design was based is certainly in error by much more than 2 db in certain frequency ranges and on certain recordings. The probable error in over-all equalization in the next record played will very likely be well over 3 db, which is about the maximum deviation between characteristics obtainable with the foregoing circuits. This says that further progress is impossible or unwise until more reliable input data is on hand.

The finished product is compact, simple to construct, and inexpensive. It does not demand critical tolerances nor particularly careful physical layout. It will accommodate any current low-level wide-range cartridge and correct any current

known or alleged response curve. Its hum, noise, and distortion content are a lot better than most commercially available equipment.

## AUDIO TECHNIQUES

[from page 13]

tion arises during musical transmissions, where views of the complete orchestra will be interspersed with shots of various sections or soloists. Here the picture demands that the balance of the accompanying sound shall be altered so as to bring the featured instrument or instruments into prominence, an alteration which may or may not be musically acceptable, according to the care taken by the producer to fit his varying viewpoints to the music. Once again skill and musical knowledge are required in order to achieve a reasonable compromise.

As regards the control of level, much wider variations are to be expected in television than are normal in sound broadcasting. A concrete example may make the reason for this clear. *Figure 6* illustrates a typical arrangement for televising a dance band, where Cameras 1 and 2 are used for long and medium shots of the band and Camera 3 deals with solo items and announcements. The band will be picked up on Mic. 1 either slung or on boom, while announcements will be taken on Mic. 2 on a stand. The conductor normally occupies Position A, but at the end of a "number" will move to Position B and announce the next item. He will be much further from the microphone than he would be in a sound studio, but will probably not speak any more loudly, so the output level will be very low. His announcement will be followed instantaneously by the first chord of the new number, and unless the output of Mic. 2 is cut very rapidly, the level will be sufficient to cause severe over-modulation, and an unpleasant burst of sound.

Thus it will be seen that both microphone balance and level control are greatly affected by the requirements of vision, and whereas in sound broadcasting, balance may frequently be left set for a complete programme, and slight control exercised on the output level, in television the continually changing conditions in the studio require constant alterations in the settings of the various controls.

The question of the ratio between speech and accompanying music is

# See and Hear THESE 3 NEW PRODUCTS ... AT TERMINAL

## REK-O-KUT "CHALLENGER" PROFESSIONAL RECORDER



12"2-speed recorder with precision overhead lathe mechanism. Automatic speed change lever from 78 to 33-1/3 rpm. Machined and balanced aluminum turntable, cast aluminum frame. Heavy duty precision-balanced motor. Overhead feed mechanism incorporates a safety cutting head feature which lifts cutter from record as center of record is approached, thus preventing double cutting and damage to styli. Wide range, distortion-free amplifier, built-in volume level meter. High fidelity 8-inch speaker. Transcription arm plays back discs up to 16" size. Inputs for high impedance microphone, phono and radio. For 115 volts 60 cycles AC. Well-made luggage-type carrying case is finished in attractive grey leatherette. Size is 25 x 22 x 12 inches.  
Price ..... **329.95**

## Advanced Model 180 WEBSTER-CHICAGO Portable Wire Recorder with Exclusive Record-O-Magic Controls



The new Webster-Chicago "Electronic Memory" is easy to use! Automatic Stops shut off motor before wire can run off either spool in either direction. Resets automatically when Lock-fast Operating Lever is returned to center position. Push-pull output Expanded Range amplifier allows recording of voice and music with excellent fidelity. Built-in Elapsed Time Indicator permits accurate timing, cueing and editing. New, powerful erase circuit. Removable Take-up Drum permits fast reload of recordings longer than one hour. Has radio input and external speaker or amplifier outlets. Compact luggage case measures 17 3/8" x 11 3/8" x 7 1/2". Carrying weight is 27 lbs. Operates on 105-120 volts. 50 or 60 cycles AC. Complete with microphone, 3 spools of recording wire and instructions.  
Price ..... **149.50**  
Many useful accessories available to enhance versatility—write for complete catalog!

## BROOK Model 12A3 HIGH QUALITY AUDIO AMPLIFIER



Within the range of its 10 watt power rating, Model 12A3 is equal in all respects to the famous Brook 30-watt amplifiers.

Along with virtually distortionless reproduction, Model 12A3 features a measure of operating flexibility and convenience which is unique in the field of high-precision amplifiers. Although designed primarily for home use as the heart of custom-built radio-phonographs, its incomparable audio characteristics make it equally suitable for laboratory or commercial application where exacting engineering standards prevail.

Complete with separate pre-amplifier and control cabinet

**169.50**  
net

**FREE!** WRITE FOR YOUR COPY OF OUR NEW 1949 CATALOG OF HIGH QUALITY SOUND EQUIPMENT

# TERMINAL

RADIO CORPORATION

Distributors of Radio & Electronic Equipment

85 CORTLANDT ST.—NEW YORK 7, N.Y. • Phone-WORth 4-3311 • Cable-TERMRADIO

probably as difficult to decide in television as it is in sound broadcasting. In general, the producer, who not only knows the play or program but has the script in front of him as well, will demand a higher level of music than the viewer, trying to understand the dialogue at first hearing, would desire. The addition of the picture, particularly if lip movements are visible, will probably help to decrease the apparent masking effect of the music.

**Remote Pickups**

The problems faced by the sound engineer during Remote Pick-ups will often be greater than those confronting his studio counterparts. His arrangements for suspending or supporting microphones will be cruder and his acoustic conditions will vary over even wider limits. Only in the case of the running commentary from an invisible commentator will his task be relatively easy. Relays from theaters will make the same stringent demands from microphones as they do in sound broadcasting, although here again the picture may help to clarify some point which sound alone would miss. But in general, remote pick-ups will be chosen for pictorial interest to such an extent that technical deficiencies in the

accompanying sound will probably be excused or pass unnoticed.

**The Future: Binaural Reproduction**

Mention has already been made in previous sections of various ways in which the present techniques might be improved. The development of methods of providing variable acoustic conditions in the studio, the design of a microphone with characteristics more suited to the special requirements of television and the introduction of the technique of pre-recording have all been suggested as desirable future achievements. Even if all these could be accomplished, however, many of the problems of television sound would still remain. In my opinion, the solution or amelioration of most of the remaining difficulties lies in the development and introduction of some form of binaural reproduction. It must be remembered that even the most perfect single channel reproduction bears to the original sound somewhat the same relationship as does an excellent color photograph to the scene it portrays. The ears have to a large extent lost the power of concentrating on any particular source of sound to the exclusion of all else. The simple experiment of listening to conversation from across the table

in a noisy restaurant, with first one and then both ears will confirm this statement. Thus, in monaural reproduction the salient features of the musical scene must be exaggerated and brought into relief by manipulation of the balance. This will result, in general, in the use of microphone positions nearer to the soloist than the direct listener using both his ears would chose. In the same way, background noise of any sort is far more noticeable in monaural reproducing systems than it is in real life. It has already been pointed out that the maintenance of the microphone sufficiently close to the sound source, and the reduction of studio noise, are both very real problems in television, and it would seem that the adoption of a binaural system would go a long way towards solving both.

Two distinct methods of binaural reproduction are possible. The first employs two microphones mounted on either side of a block of wood of similar size to the human head. The outputs of these are taken through completely separate transmission chains to two earphones worn by the listener. The second method increases the spacing of the two microphones to several feet and reproduces the sound from two loud-

**It's Tops!**

Surveys show that AUDIO ENGINEERING is preferred over all other technical magazines read by the best informed in the sound field—the broadcast engineers. Each issue brings you outstanding articles on five or more of the following subjects:

- Broadcasting
- Sound on Film
- Recording
- Phono Reproduction
- Public Address
- Industrial Sound equipment and applications.
- Acoustic treatment of studios, rooms, auditoriums etc.

In addition, each month Audio Engineering presents latest improvements in sound reproducing equipment design, test methods, and technical news from here and abroad. The editorial staff includes top authorities in the sound field.

**Subscribe NOW! Don't miss an issue!**

Please write for details of our special group rate covering 6 or more Subscriptions.



AUDIO ENGINEERING  
RADIO MAGAZINES, INC.  
342 Madison Avenue, New York 17, N. Y.

Sirs: Here is my  check (or  money order) for \$..... Enter my subscription order to AUDIO ENGINEERING for the next.....issues. Subscription Price: In U.S.A., Canada and Pan America—12 issues \$3—24 issues \$5. All others \$1.00 more per year. Please check one:  New Subscription  Renewal

Name (please print).....

Address.....City.....State.....

Occupation (give title and department).....

Firm Name.....



speakers preferably spaced the same distance apart. The headphones method gives a more perfect illusion, though it suffers from the psychological disadvantage that when the listener turns his head the whole acoustic scene moves round with him. In watching a television program, however, it is probable that viewers will tend to keep their heads reasonably still.

The reversion to headphone listening would doubtless be considered a retrograde step in many quarters, and experiments would be needed to determine how effective the loud-speaker method could be made, using a spacing which could reasonably be achieved in the modern home. It is surprising how little work has been done so far on the whole subject of binaural reproduction. Several isolated trials have been carried out and written up, as for example, the relaxing of a concert by the Philadelphia Symphony Orchestra from Philadelphia to Washington, using three wideband channels but no other systematic investigation of the problem, appears to have been undertaken.

The most usual argument advanced against the use of binaural reproduction is that it is uneconomical to double the bandwidth occupied by one program. This argument is, of course, of much less weight at the frequencies at which television transmission takes place. Several methods of providing the two channels present themselves. Two separate transmitters, above and below the vision signal in frequency, could be used, giving the possibility of producing simple receivers in which only one sound channel is provided. Another method would be to use a single pulse transmitter, with the two channels modulating alternate pulses. Here again, a simple single channel receiver could probably be produced which would give merely a mixture of the two.

In short then, it would seem that whereas from the general point of view, a program of research into the whole question of binaural transmission is overdue, the results of such an investigation might find their most beneficial use in helping to solve some of the problems of television sound.

#### Conclusion

It is hoped that sufficient has been said to make it clear that, although somewhat naturally the problems of vision technique have occupied the forefront of interest and discussion

# ...and again we say THE ANSWER IS ADVANCED ENGINEERING

In outward appearance there is little difference between a horn or loud speaker of conventional type and its counterpart in a Racon model. But under the surface there are many subtle differences and improvements.

It is these invisible features—the product of Racon **ADVANCED ENGINEERING**—that give Racon units their outstanding superiority in volume, range, clarity and freedom from resonant effects.

**(Top)—Permanent Magnet Horn Units**  
These units, popular for all types of service, embody improvements developed during the war. Higher power handling capacity and greater efficiency. Designed for practically lifetime service. Two groups: one with Alnico V Magnets, one with Alnico Blue Dot Magnets. All steel parts plated to prevent corrosion. Corrosion-proof metal or plastic diaphragms. With heavy aluminum watertight case at \$2.50 extra. Type illustrated is Junior Giant with Alnico V Magnet, watertight case. Operates at 30 watts.

List Price.....**\$50.00.**

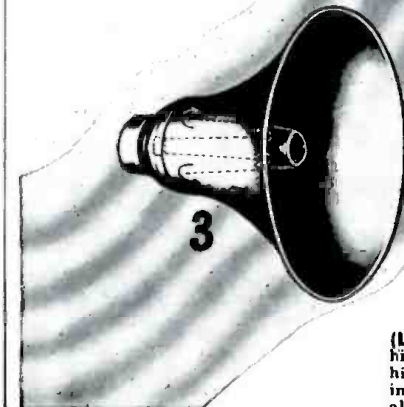

**(Center)—Double Re-Entrant Marine Speakers**—For long range reproduction and pick-up, all types of service—Marine, Railroad and

Public Addresses. Waterproof; immune to extreme temperatures. Heavy aluminum spinning with heavy aluminum casting for base. Four models: Miniature Marine, bell diam. 6¾"; Midget Marine, two sizes, both 9½" bell diam.; Regular Marine, bell diam. 14". Approved by Bureau of Marine Inspection and Dept. of Commerce. Type shown, Regular Marine, bell diam. 14". List Price. **\$130.00.**

**(Lower)—Double Re-Entrant Trumpet**—Delivers highly concentrated sound over long distances with highest efficiency. Free from resonant effects. Base and inside tone arm aluminum castings; bell heavy gauge aluminum spinning. Seven models, bell diameters 10½" to 25½"; also four radial models in widths 9" to 36". Type shown, RE-35, bell diam. 19". List Price. **\$32.50.**

**DON'T BE SATISFIED WITH "ORDINARY PERFORMANCE".  
GET A RACON AND YOU GET THE BEST!**

Write today for new catalog of complete line

**RACON ELECTRIC CO., INC.**

52 E. 19th Street., New York 3, N. Y.

# RACON

*Speakers  
Horn Units  
Horns*



**America's  
leading  
engineers  
of important  
industrial  
organizations**

**SWITCH**

to

**NEWARK**

for

● **TV, Radio, Sound and  
Recording Equipment,  
Replacement Parts and  
Electronic Tubes**

● **because...**

**NEWARK** has the most complete on-the-spot stock of all standard equipment... from the tiniest replacement part to the most complete installation... on hand in 3 giant centrally located stores, and tremendous warehouses!

**NEWARK** equipment is tops in quality, dependability, and performance. Everything is Newark-tested and Newark-backed, so you know it's the best!

**NEWARK** delivers the goods...but fast! 24-Hour mail-order service...faster on phone or telegraph orders.

**NEWARK** offers the most complete essential reference book...148 illustrated pages full of data on over 20,000 standard brand items, including

Standard and L-P pickups and changers • Wire, tape and disc recorders • Hi-Fi sound and P.A. equipment • Speakers • Mikes • Accessories etc.

Send  
**TODAY**  
for **FREE**  
new 1949  
**NEWARK**  
**CATALOG**



Also featuring a complete line of **RADIO AND TELEVISION KITS, SETS, PARTS and ACCESSORIES** for homes, hams and hobbyists!

**24-HOUR MAIL-ORDER SERVICE**

**3 GREAT STORES!** Uptown at 115 W. 45th St.  
Downtown at 212 Fulton St. in **NEW YORK**  
323 W. Madison St. in the heart of **CHICAGO**



**MAIL NOW!**

Dept. C21

**NEWARK ELEC. CO.**, 242 W. 55th St., N. Y. C.  
Please send **FREE** 1949 Newark Catalog to:

Name \_\_\_\_\_

Address \_\_\_\_\_

City \_\_\_\_\_ State \_\_\_\_\_

among television engineers, the provision and maintenance of a high quality sound accompaniment to the picture is by no means a simple straightforward task. Much still remains to be done in the way of research, development and training. This article has attempted to indicate some of the fields in which work may be particularly needed.

**References**

1. D. C. Birkinshaw and D. R. Campbell - "Studio Technique in Television" - *J.I.E.E.*, Part III, Sept. 1945.
2. Townsend - "Contemporary Problems in Television Sound" - *Proc. I.R.E.*, Jan. 1943.
3. R. H. Bolt - "Studio Acoustics" - *Radio News*, Jan. 1946.
4. W. A. Pozner - "Synchronization Technique" - *J.S.M.P.E.*, Sept. 1946. Page 197.

**Experimental Ultrasonics**

[from page 23]

about 20 cycles to over 8 kc, but with any pressure it will not be possible to prevent the jet of air from forcing its way between the fingers and causing oscillations.

Now look at the scope and, if some high frequency sine waves appear on the screen, do not assume the jet is oscillating; the white noise is merely exciting the crystal at some mode of oscillation.

Next, assemble the generator and set the cavity at about one diameter deep. If the cavity is .062, this will be approximately 24 kc. Jam it lightly up against the jet and retract it slowly. About one jet diameter from the jet an oscillation will appear. Pull it out another diameter and another oscillation, somewhat weaker, will occur. Go back to the first position and lock the cavity in position as closely as possible to the optimum oscillation point. The cavity-depth adjustment screw can now be adjusted and the air pressure varied slightly to obtain vernier action on the frequency and wave form. Have the generator about 2 inches or so directly over the pickup crystal. A whole variety of wave forms will be noticed.

When the regulator is wide open, or the generator operating directly off the compressor, the variation in pressure due to the single cylinder of the compressor will provide frequency-modulated signals that will be quite fuzzy on the oscilloscope.

After becoming familiar with the frequency range of the generator, set it at some mid-frequency point and slip on the parabolic reflector. It should focus to a circle less than three inches in diameter at 8 feet, and the field strength should be about the same as the generator 2 inches from

**Announcing the Panoramic  
Ultrasonic Analyzer Model SB-7**

for easy, fast ultrasonic analysis

An entirely new instrument, the SB-7 is engineered to meet the urgent demands for panoramic reception of ultrasonics for...

- Carrier system monitoring
- Feedback system studies
- Harmonic analysis
- Transmission line investigation
- Telemetry
- High frequency vibration analysis

The SB-7, an automatic scanning receiver, graphically presents frequency and level of ultrasonic signals. Special control features enable selection and spreading out of any narrow band of highly detailed examination.

**FEATURES**

- Direct reading
  - Linear frequency scale
  - Continuously variable scanning width
  - Linear and 40 db linear log amplitude scale
  - Continuously adjustable selectivity
  - Stabilized frequency calibrations
  - Wide input voltage range
- Write Dept. HR for complete specifications

On display at the March I.R.E. Convention, Booth 241-2.

**PANORAMIC RADIO CORP.**  
10 South Second Ave. Mt. Vernon, N.Y.

**TV REAR PROJECTION?**

... As Always S.O.S. Leads the Way  
GET "HOLLYWOOD" EFFECTS,  
MOVING BACKGROUNDS,  
NO PAINTED BACKDROPS  
NO SPECIAL SETS.



**S.O.S.**  
"Know How"  
Pays Off

Also a Complete line of Studio, Recording and Laboratory Equipment.

For details and catalog write

**S.O.S. CINEMA SUPPLY CORP.**  
Dept. G, 602 W. 52nd St., New York 19

**AUDIO ENGINEERING SCHOOL**

A practical Audio Engineering course in Sound Fundamentals; FILM and MAGNETIC Recording; Transmission Measurements; Monitoring and Mixing. Laboratories contain: Transmission Sets, Oscillators, Distortion Sets; Harmonic Analyzer; Intermodulation Analyzer and other eqpt. Recording Studio assimilating Broadcast, Motion Picture and Commercial Sound Recording. H. M. TREMAINE, Pres-Dir.

Approved for Veterans and Foreign Visas  
**HOLLYWOOD SOUND INSTITUTE Inc**  
1040-A No. Kenmore Hollywood 27. Calif.

**2nd ANNUAL PENNY SALE!**

For 1¢ more, you get 2.

For Example: HI FIDELITY 20,000 ohms to 600 ohms 2" d x 3 1/2" h Raytheon No. CRP 303/5A. Suitable from preamp. plate to line or phones. Flat from 15 to 20,000 CPS. No. TX240 Ship. wt. 2 1/2 lbs. \$2.29—2 for \$2.30.

Send for complete PENNY SALE LISTINGS. Prices net f.o.b. our plant. Include postage & insurance.  
**UNIVERSAL GENERAL CORP.**  
345 Canal St., N. Y. 13 (Dept. A) Walker 5-9642

the crystal, but without the reflector.

The average generator will focus somewhat differently for maximum white noise and maximum sine wave. This is because the white noise field pattern is usually at dead right angles to the jet, but the sine wave is about 5 degrees away from the jet. Both their half-power points are about 15 to 20 degrees on a polar diagram. This means the center of the parabolic reflector is of no use.

Another advantage of using the parabola is that close to the jet there is quite a current of air from the jet, but about ten feet away along the beam this is negligible.

You will find that you can make a good reflection shot from a wall or a sheet of aluminum, for instance. The loss is undetectable. At 25 kc four layers of a handkerchief will lower the signal about 30 db, and at 50 kc only one layer will do the same.

#### Technique

This power is insufficient to do a good job on smoke precipitation, but by putting some in a large glass jar with a wide-open top, and suspending the reflector over it some work can be done. With a one-hp compressor, the smoke should clear in a very few seconds.

In working with insects and birds you usually focus down and place a large barrier in the path of the beam, with a hole accurately cut to size to pass just the beam, which can then be considered of uniform energy for a foot or so. To weaken the signal, do not cut the power on the jet but put an attenuator, such as one or several layers of cloth, in the beam.

The writer has always had a wish to try one experiment in particular. Since our furred, feathered and insect friends usually respond to quite high frequencies, will someone direct some high-power 20-kc output down a complicated series of rat holes, such as exist in so many barns? It might be well to have some suitable dogs at the far end, and let me know how the party comes out?

**Warning**—since many generators go as low in frequency as that of many experimenters' hearing range, try to avoid working for more than a few minutes at a time at, say, 14 kc. The annoyance is cumulative, and at this power nausea and headache can result without warning. It is also a good idea to have a "backboard" of a blanket or the like on which to focus the energy, as otherwise it will reflect endlessly and go around many corners, and may cause distress to a dog or canary at some distance. Dogs are seldom affected above 26 kc, but a young canary can be distressed at 36 kc.



## AMERICAN AIRLINES CHOOSES ALTEC LANSING 8" SPEAKERS FOR FAMOUS FLEET OF DC-6s

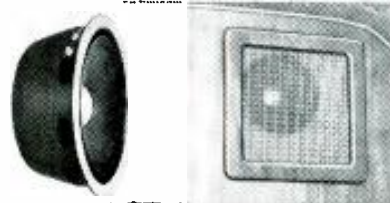

#### 400B DIA-CONE SPECIFICATIONS:

Power Rating . . . . .	12 watts
Voice Coil Impedance . . . . .	8 ohms
Required Amplifier Output Impedance . . . . .	4-8 ohms
Voice Coil Diameter . . . . .	1 3/4"
Speaker Diameter . . . . .	8 1/4"
Speaker Depth . . . . .	3 1/8"
Weight . . . . .	4 lbs.

After exhaustive competitive in-flight operating tests of Altec Lansing and other speakers, American Airlines' communications division engineers reported: "Observers all voted for the Altec system on the basis of quality and clearness." Entire passenger fleet of DC-6's will be Altec Lansing 8" 400B Dia-cone equipped.

Send for brochure describing entire Altec Lansing line of speakers, containing frequency response curves.



161 Sixth Avenue,  
New York 13, N.Y.

1161 North Vine St.  
Hollywood 38, Cal.

Booth **X** . . . I. R. E. Show

Transcription

Sound Effects

LP

Broadcasting Equipment

**THE GRAY RESEARCH & DEVELOPMENT COMPANY, Inc.**

16 ARBOR STREET • HARTFORD, CONN.

MODEL  
12

# SUBMINIATURE PREAMPLIFIER

for the  
640AA CONDENSER MICROPHONE

- HIGH GAIN — 34 db
- RESPONSE — Down 1 db at 40 cps; down 0.5 db at 20 kc
- OUTPUT Z — 250 ohms; no change in response for loads from 250 ohms to
- SMALL SIZE — 1 1/8" dia. x 10" long
- LIGHT WEIGHT — Only 12 ounces
- POWER REQUIREMENTS — 70 ma at 1 1/4 v; 2.5 ma at 135 v.
- LONG BATTERY LIFE — Virtually immune to changes in battery voltage; change of A voltage from 1.4 to 1.0 reduces gain 1 db; B voltage from 135 to 105, 0.6 db.

The greatly improved performance inherent in this new instrument is made possible by our extensive experience in subminiature techniques

## Audio Instrument Company

1947 Broadway, New York 23, N. Y.

## NO OBSOLESCENCE

ONE AMPLIFIER for ALL RECORDS  
... plus \*Dynamic Noise Suppression



New developments in recording, regardless of turntable speed or pick-up point, will not obsolete the H. H. Scott type 210A amplifier because it already includes every feature necessary for faithful reproduction of recorded or broadcast music.

And in addition, the built-in \*Dynamic Noise Suppressor assures freedom from rumble, hiss, and the scratch that inevitably increases with each playing of any record.

Brilliant, realistic reproduction of every record, 33, 45, or 78 RPM . . . and of FM and AM broadcasts as well . . . is certain now and for many years to come with the H. H. Scott 210A amplifier.

Hear it TODAY and you'll agree that it satisfies tomorrow's requirements. For complete technical data, write Dept. 903AE2.

### GUARANTEED FOR A FULL YEAR

\*Licensed under U.S. and foreign patents pending and issued.

**HERMON HOSMER SCOTT, INC.**  
**"SH" "PACKAGED ENGINEERING"**  
 385 PUTNAM AVE. • CAMBRIDGE 39, MASS.

## 45 RPM Records

[from page 6]

### The New Speed

The new speed of 45 rpm was not adopted to complicate the commercial situation; it was picked after considerable testing, to permit of better sound quality than could be achieved at 33 1/2 rpm. The engineering reasoning is best developed through a comparison with a 7" 33 1/2 rpm LP. If we assume both have a maximum recording diameter of 6 1/2 inches, and a pitch of 240 lines per inch, we find that at the outer groove X has 1.35 times the linear groove velocity of the 7" LP. If we record for 5 minutes we find that the LP will be recorded in to 5 1/8 inches diameter, and X is in to 4 3/8 inches. The groove velocity at the inside will be 22% higher in the case of X. If the LP recordings were made at a finer pitch, the advantage of X could be reduced. For a 3-minute record, the advantage in favor of X is 28%. Further out, the advantage will approach 35% as a limit.

We find, then, that for equal processing care, the Victor record will have a 22 to 35% greater frequency range available. This assumes, correctly, that both manufacturers use recording equipment with wide-frequency range, and that the reproducing stylus tip is the bottleneck.

The increase in available frequency range is interesting, but nowhere near as significant as the decrease in distortion. We may expect processing to cause some increase in distortion, and "tracing distortion" at high levels will be of importance. Both these factors are reduced by an increase in linear groove speed, and the reduction in distortion will be proportional to the square or cube of the increase in groove velocity. This means that the amount of distortion in the reproduction of X will be 40 to 55% of that incurred in reproducing LP, at the same diameter, if both processing plants are equally careful (or careless). It is believed that the improvement in fidelity was the factor which led Victor to retain the higher speed, in spite of the sales advantage of 33 1/2 rpm.

### Comparison of LP and X

A most thankless task is that of making an engineering comparison of the two seven-inch designs. No matter what we say, both sides will complain vigorously about the author's astigmatism.

The comparison is valid only if we study nominally similar discs, that is, seven-inch against seven-inch. Some of

# 216

## Exhibiting Manufacturers

are showing this label on their letters, literature and advertising. The spot-light is on the NEW at the Radio Engineering Show, come and see—

### Audio Equipment

Registration \$3. non-members,  
\$1. to IRE members.



## PRECISE AUDIO MEASUREMENTS

Pickering and Company, Inc., leaders in the audio field, make available to the industry their specialized facilities for audio measurements.

We are prepared to make guaranteed measurements on any type of audio equipment for manufacturers, dealers, or consumers.

**PICKERING & CO. Inc.**  
Oceanside, N. Y.

VERTICAL LATERAL  
**REPRODUCERS RECONDITIONED**  
Types 9-A, 9-B, D-93306, MI-4856, MI-4876-G  
Complete Stock of New Replacement Parts  
for All Types

This service is being used by leading radio stations and wired music companies from coast to coast. Factory prices prevail.

**VIBRATION SYSTEMS, INC.**  
1040 W. Fort St. Detroit 26, Michigan

### 8 WIRE SHIELDED CABLE

Two No. 16, Six No. 20 tinned, stranded, copper, rubber insulated, coded leads. Waterproof rubber jacket. Tinned copper armor shield overall. New material—No. AES. Lengths to 400 ft. Price 10c/ft., \$90/Mft., \$700/10Mft. FOB Chicago warehouse.

**Trans-World Radio-Television Corp.**  
6639 Aberdeen St. Chicago 21, Ill.  
Phone: AUstin 7-4888 ENglewood 4-4484

the unwary have compared seven-inch RCA with twelve-inch Columbia. This is incorrect, for they fall in entirely different price classes, fit different markets, and cannot fairly be compared. It should also be pointed out that almost no ten- or twelve-inch LP records have been recorded to five-inch diameter. Most of those seen by the writer stop at six or seven inches.

At the risk of being classed as a hopeless cynic, we are inclined to look on Columbia's seven-inch LP as an RCA X with most of the original features removed to make it easier to market. This is not meant to be critical, for the present slump in the phonograph record field makes expediency more significant than it usually is.

#### Processing

It is easier to get acceptable processing quality in X, but this is not a guaranty. Processing quality in America has always been erratic, and poor processing can ruin a record in spite of the original design engineering. In short, the contest between LP and X is a battle of processing departments as much as of recording rooms. The low price of the seven-inch record will not permit scrapping many pressings, so quality control must anticipate rather than follow production. In this respect particularly the citation of factory experience with twelve-inch LP production is fallacious, for there is a 500% difference in list price. A factory simply cannot pamper a ninety-cent record as much as one selling at nearly five dollars.

In all the argument three men have been pretty well ignored. It was the rigorous mathematical study of tracing distortion by Pierce and Hunt, in 1938, which gave a firm foundation of fundamentals to ideas of groove dimensional change. René Sneyvangers played a significant part in the development of X just before the war. This was put on the shelf when war conditions made vinylite in short supply. After the war, with the brilliant Peter Goldmark, he again played a part in fine groove development. This time it was in the Columbia research laboratory.

It was predicted that the author would earn the obloquy of both sides of the argument. Now for a suggestion which will get the third side (the public) angry too. Why not reduce the radius of the standard 78-rpm record groove to ¼ mil? This could be played interchangeably by a standard 3 mil needle, or by a 1 mil micro-groove stylus. Under the latter condition, the quality would be simply superb.

## MODEL 1360 JACK MOUNTING PANEL

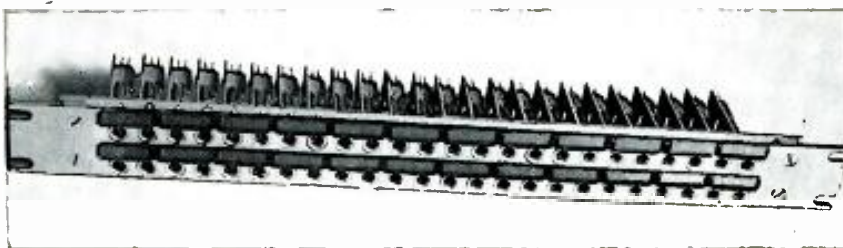

**Requires Only 1<sup>3</sup>/<sub>4</sub>" of Panel Space!**

The Type 1360 JACK MOUNTING PANEL is the only double row jack panel made to fit the dimensions of a standard rack multiple (1<sup>3</sup>/<sub>4</sub>" high). All others require 2<sup>1</sup>/<sub>8</sub>" of vertical panel space.

Another feature is the use of a designation strip over each row of the 24 jacks.

The unit is constructed of heavy dural, precision drilled and machined to take standard jacks. It is finished in light grey or satin black as you require. Special finishes are optional and may be obtained for a slight extra cost.

NET PRICE (less jacks) \$12.75

F.O.B. Burbank, Cal.

Type 1399-B Jacks (with normal "Make" contacts) \$.77 each



**CINEMA**  
ENGINEERING COMPANY  
1510 W. Verdugo Ave. Burbank, Calif.  
Cable Address: CINENG BURBANK



## INDUCTANCE CONTINUOUSLY VARIABLE



*Lenkurt knows how*



**LENKURT ELECTRIC CO.**  
SAN CARLOS • CALIFORNIA

Ampex Electric Corp., manufacturer of the new Ampex broadcast-type tape recorder, uses a Lenkurt Adjustable-Core Molded Pot Assembly for peaking the erasing oscillator to required frequency. Inductance is adjustable, stepless, in a 20 per cent range up to 3 henries.

Other advantages are improved Q, simplified shielding, economy of space and weight, and the possibility of mounting parts closer together. Write for data.

# AMPERITE

Studio Microphones  
at P.A. Prices

Ideal for  
BROADCASTING  
RECORDING  
PUBLIC ADDRESS

"The ultimate in microphone quality," says Evan Rushing, sound engineer of the Hotel New Yorker.

• Shout right into the new Amperite Microphone—or stand 2 feet away—reproduction is always perfect.

• Not affected by any climatic conditions.  
• Guaranteed to withstand severe "knocking around."



Models  
RBLG—200 ohms  
RBHG—Hi-imp.  
List \$42.00



"Kontak" Mikes  
Model SKH, list \$12.00  
Model KKH, list \$18.00

**Special Offer:** Write for Special Introductory Offer, and 4-page illustrated folder.

AMPERITE Company, Inc.

561 BROADWAY • NEW YORK 12, N. Y.

Canada: Atlas Radio Corp., Ltd., 560 King St. W., Toronto

## THE HARTLEY-TURNER MODEL 215 SPEAKER

The wide-spread response of American music-lovers to our first advertisement has evoked some good-natured doubts about our claim that the 215 Speaker gives better reproduction than any other at any price. "Have we," they ask, "forsaken the traditional British genius for understatement so that our voice can be heard the better?" To that we answer. "Emphatically No."

We are convinced that high prices are not necessary for high-fidelity—at any rate in the home. We believe that an engineer who really understands technology and music, and who is not content to copy others, can produce a speaker of superlative performance at a modest price. We believe it because thousands of British users say we have achieved it in the Hartley-Turner.

But to make the matter clearer we have prepared a leaflet treating of this in greater detail. A copy of this and our catalog is yours free for the asking. Better still, send \$1 today for "New Notes in Radio," an authoritative handbook on the whole subject of high-fidelity, and we will also keep you supplied with technical data sheets all designed to help you achieve new thrills and pleasures from radio and records.

We shall be glad to co-operate with a limited number of dealers and custom-built manufacturers on an agency basis. Write today for full details, stating the territory you cover.

**H. A. HARTLEY Co., Ltd.**  
152, HAMMERSMITH ROAD,  
LONDON, W. 6, ENGLAND

## ADVERTISING INDEX

Altec Lansing Corp.....	45
Amperite Co., Inc.....	48
Arnold Engineering Co.....	8
Audio Devices, Inc.....	Cover 2
Audio Instrument Co.....	46
Brook Electronics, Inc.....	48
Camera Equipment Co.....	36
Cannon Electric Dev. Co.....	40
Cinema Engineering Co.....	47
Daven Company, The.....	Cover 3
Electro Motive Mfg. Co., Inc....	2
Electro-Voice, Inc. ....	29
Fairchild Recording Equip. Corp. ....	35
Gray Research & Dev. Co.....	45
Hartley, H. A. Co., Ltd.....	48
Hewlett-Packard Co. ....	7
Hollywood Sound Institute.....	44
Institute of Radio Engineers....	46
Jensen Manufacturing Co.....	5
LeBel, C. J.....	32
Lenkurt Electric Co.....	47
Maurer, J. A. Inc.....	33
Medical Electronics Co.....	38
Newark Electric Co., Inc.....	44
Panoramic Radio Corp.....	44
Par-Metal Products Corp.....	48
Peerless Elec. Prods.....	38
Pickering & Co., Inc.....	46
Presto Recording Corp.....	31
Professional Directory .....	32
Racon Electric Co., Inc.....	43
Radio Corp. of America (Broadcast Equip. Div.) 16-A, 16-B, 16-C, 16-D	
Scott, H. H. Inc.....	46
Shallcross Manufacturing Co.....	37
Shure Brothers, Inc.....	6
Somerset Laboratories, Inc.....	39
S. O. S. Cinema Supply Corp.	44
Sylvania Electric Products Inc.	1
Terminal Radio Corp.....	41
Trans-World Radio-Television Corp.....	46
Turner Company, The.....	34
United Transformer Corp. Cover 4	
Universal General Corp.....	44
U. S. Recording Co.....	32
Vibration Systems, Inc.....	46
Wells, Winston .....	32

Here It Is!...

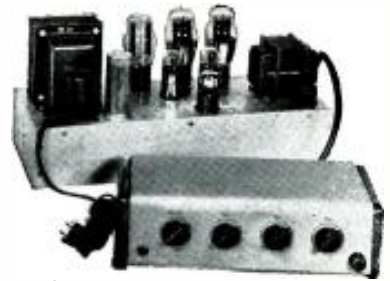

## ... THE NEW BROOK 10 WATT AMPLIFIER

Yes, this is it—a genuine Brook High Quality Amplifier in the moderate price field. An amplifier of incomparable performance . . . equalling Brook 30-watt models in all respects.

Use of triodes in all stages—together with Brook-designed transformers, permits cleanest amplification ever achieved. Distortion is reduced to the vanishing point.

No matter how discriminating you are, this new Brook All-Triode Amplifier will surpass your most exacting expectations. Hear this finest of amplifiers at your dealer's NOW!

Write TODAY For Free Copy of Technical Bulletin and Detailed Distortion Analysis

## BROOK ELECTRONICS, Inc.

Dept. AC-9, 34 DeHart Place  
Elizabeth 2, New Jersey

BUILD BETTER ELECTRONIC EQUIPMENT  
with STANDARDIZED



READY-TO-USE  
CABINETS  
•  
CHASSIS  
•  
PANELS  
•  
RACKS

for  
ALL  
P. A.  
NEEDS

Par-Metal Equipment is preferred by Service Men, Amateurs, and Manufacturers because they're adaptable, easy-to-assemble, economical. Beautifully designed, ruggedly constructed by specialists. Famous for quality and economy.

Write for Catalog.

**PAR-METAL  
PRODUCTS CORPORATION**

32-62—49th ST., LONG ISLAND CITY 3, N. Y.  
Export Dept.: Rocke International Corp.  
13 East 40 Street, New York 16

# TWENTY YEARS OF ATTENUATOR PROGRESS

BY

# DAVEN

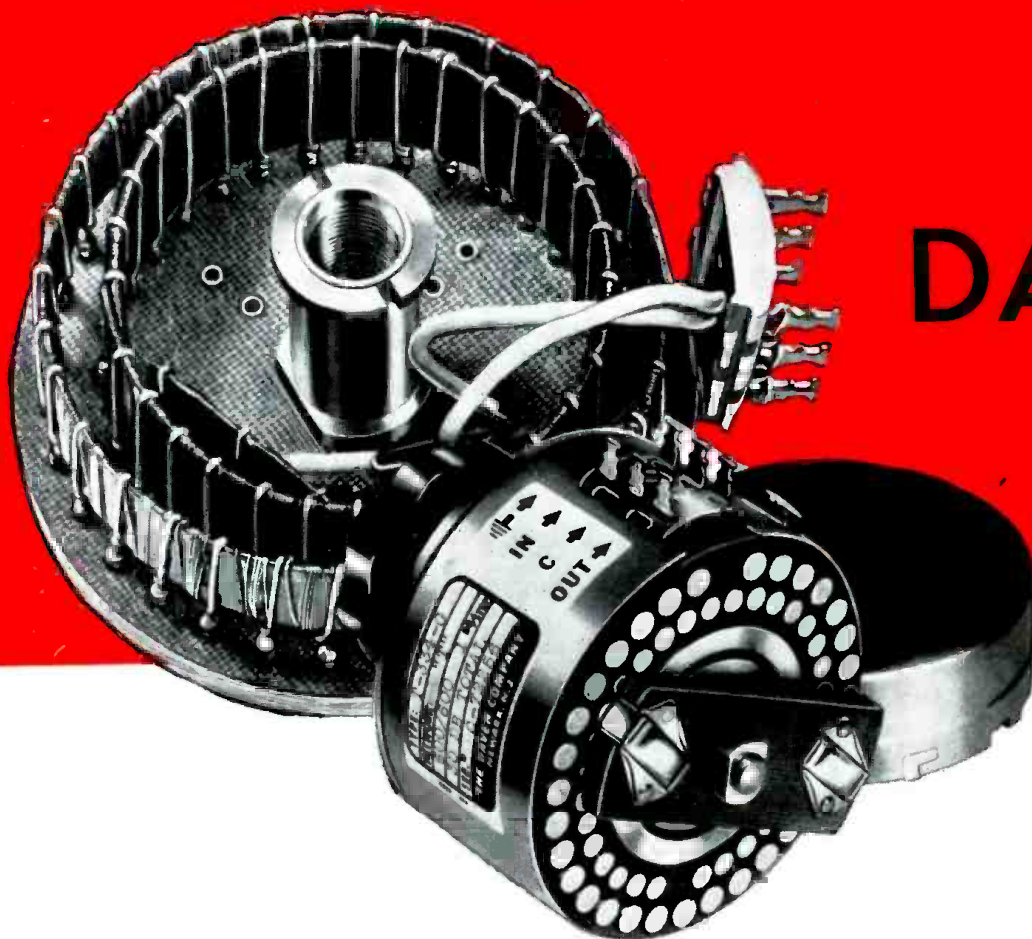

As one of the oldest and most progressive manufacturers of attenuators, we take pride in presenting our recent contribution to the users of fine volume controls . . . the "Knee-Action Switch.\*" This revolutionary type of rotor is now being offered on Daven attenuators and switches at no additional cost.

For longer life and uninterrupted performance, we offer a switch with the following advantages:

- ★ Multiple wiping blades of the "Knee-Action Switch" are enclosed in a tamper-proof housing.
- ★ Each blade conductor is individually spring loaded, giving a perfect balance to the entire conducting surface.
- ★ Uniform pressure on the contacts and slip rings is assured, resulting in low, even contact resistance, over the life of a unit.
- ★ The considerably shorter rotor arms result in lower over-all switch resistance, due to the reduced conducting path.
- ★ For specialized switch applications, where space is limited, this new type of switch construction permits up to 6 poles on a  $2\frac{3}{4}$ " diameter deck. A greater number of poles may now be obtained than heretofore, on all smaller diameter units.

\* PATENTED

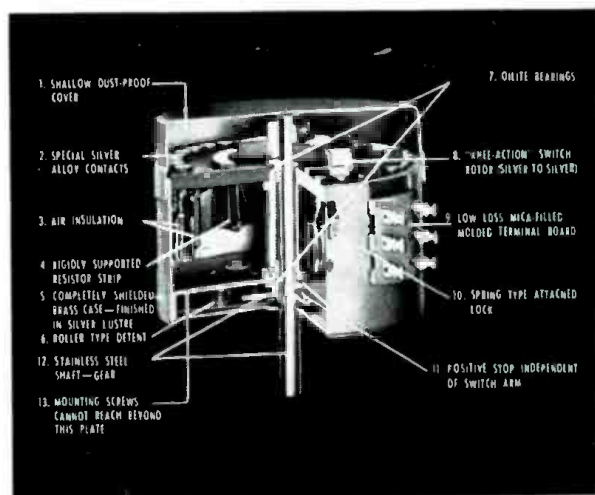

For Further Information Write to Dept. A-6

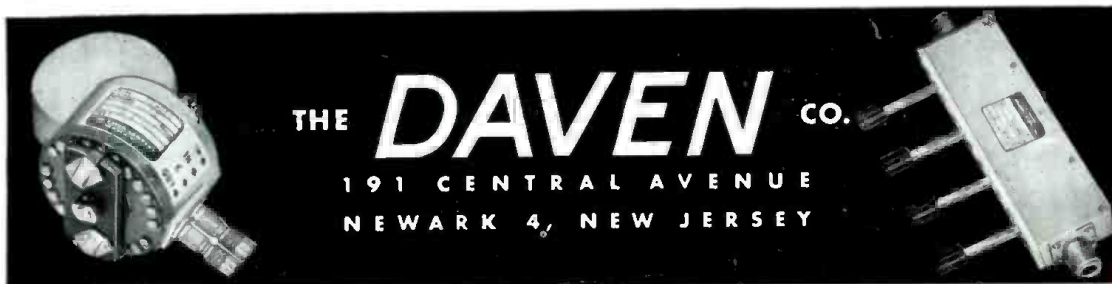

THE **DAVEN** CO.  
191 CENTRAL AVENUE  
NEWARK 4, NEW JERSEY



# FOR HIPERM ALLOY TRANSFORMERS

The UTC Hiper alloy audio transformers are specifically designed for portable and compact service. While light in weight and small in dimensions, neither dependability nor fidelity has been sacrificed. The frequency characteristic of the Hiper alloy audio units is uniform from 30 to 20,000 cycles. These units are similar in general design and characteristics to the famous Linear Standard audio Series.

## UTC Hiper Alloy Transformers Feature

- True Hum Balancing Coil Structure**... maximum neutralization of stray fields.
- Balanced Variable Impedance Line**... permits highest fidelity on every tap of a universal unit... no line reflections, or transverse couplings.
- Reversible Mounting**... permits above chassis or sub-chassis wiring.
- Alloy Shields**... maximum shielding from induction pick-up.
- Multiple Coil, Semi-Toroidal Coil Structure**... minimum distributed capacity and leakage reactance.
- High Fidelity**... UTC Hiper Alloy Transformers have a guaranteed uniform response of  $\pm 1.5$  DB from 20,000 cycles.



## FOR IMMEDIATE DELIVERY

From Your Distributor



Typical Curve for HA Series

Type No.	Application	Primary Impedance	Secondary Impedance	$\pm 1$ db from	Max. Level	Max Unbal. DC in primary	List Price
HA-100	Low impedance mike, pickup, or multiple line to grid.	50, 125, 200, 250, 333, 500 ohms	60,000 ohms in two sections	30-20,000	+22 DB	5 MA	\$19.00
HA-100X	Same as above but with tri-alloy internal shield to effect very low hum pickup.	50, 125, 200, 250, 333, 500 ohms	120,000 ohms overall, in two sections	30-20,000	+22 DB	5 MA	24.00 22.00
HA-101	Low impedance mike, pickup, or multiple line to push-pull grids.	50, 125, 200, 250, 333, 500 ohms	120,000 ohms overall, in two sections	30-20,000	+22 DB	5 MA	27.00 19.00
HA-101X	Same as above but with tri-alloy internal shield to effect very low hum pickup.	50, 125, 200, 250, 333, 500 ohms	120,000 ohms overall, in two sections	30-20,000	+22 DB	5 MA	16.00
HA-108	Mixing, low impedance mike, pickup or multiple line.	8,000 to 15,000 ohms	135,000 ohms 1.5:1 ratio, each side	30-20,000	+22 DB	0	18.00
HA-106	Single plate to push-pull grids	8,000 to 15,000 ohms	50, 125, 200, 250, 333, 500 ohms	30-20,000	+32 DB	5 MA	20.00
HA-113	Single plate to multiple line.	5,000 to 10,000 ohms	50, 125, 200, 250, 300, 500 ohms	30-20,000	+32 DB	5 MA	19.00
HA-134	Push-pull 89's or 2A3's to line.	3,000 to 5,000 ohms	30, 20, 15, 10, 7.5, 5, 2.5, 1.2	30-20,000	+32 DB	5 MA	
HA-135	Push-pull 2A3's to voice coil.	3,000 to 5,000 ohms	30, 20, 15, 10, 7.5, 5, 2.5, 1.2	30-20,000	+32 DB	5 MA	

The above listing includes only a few of the many Hiper Alloy Transformers available... write for catalog.

# United Transformer Co.

150 VARICK STREET  
 EXPORT DIVISION: 13 EAST 40th STREET, NEW YORK 16, N. Y.  
 NEW YORK 13, N. Y.  
 CABLES: "ARLAB"