

AUDIO ENGINEERING

OCTOBER
1952
35c



THE WORLD OF SOUND

NEW 7" REELS OF
audiotape* give you

EXTRA VALUE

at no extra cost!

GUARANTEED SPLICE-FREE

SPLICE-FREE

SPLIT-SECOND TIMING with New 2 $\frac{3}{4}$ " Hub

Timing errors are virtually eliminated by this improved reel design which minimizes tension and speed changes throughout the winding cycle. Ratio of O.D. to hub diameter is the same as on the standard NAB aluminum reel.

PERFECTED ANTI-FRICTION PROCESS.

Reduces head wear—eliminates annoying tape "squeal" — prevents "tackiness" even under extreme temperature and humidity conditions.

MAXIMUM UNIFORMITY OF OUTPUT.

All 7" and 10" reels of plastic-base Audiotape are guaranteed to have an output uniformity *within* $\pm \frac{1}{4}$ db — and reel-to-reel-variation of less than $\pm \frac{1}{2}$ db. What's more, there's an actual *output curve* in every 5-reel package to prove it.

With Audiotape, all of these extra-value features are *standard*. There's no extra cost — no problem of separate inventories or variations in tape quality.

For there's *only one* Audiotape — the finest obtainable anywhere. Test it — compare it — let Audiotape speak for itself.

The new 7-inch plastic reel with large diameter hub for greater timing accuracy is now being supplied on all orders unless otherwise specified. Because of increased hub diameter, maximum reel capacity is slightly over 1200 feet. Older style Audiotape reels with 1 $\frac{3}{4}$ " hub and 1250 feet of tape will continue to be furnished on request at the same price.

**Trade Mark*

AUDIO DEVICES, Inc.

444 Madison Ave., New York 22, N. Y.

Export Department, 13 East 40th St., New York 16, N. Y., Cables "ARLAB"

audiodiscs • audiotape • audiofilm • audiopoints

NEW!

The turntable
that you helped
us design!



Model
B-16H

REK-O-KUT 3-SPEED, 16" Transcription Turntable FOR BROADCAST AND RECORDING STUDIOS

The new B-16H three-speed, 16" transcription turntable is not a modification of a two-speed machine, but a completely new design, with operational controls suggested by leading engineers. Now you can play all three speeds—33 $\frac{1}{3}$, 78 and the popular 45—with equal facility.

The B-16H can be quickly and easily fitted into your present 2-speed transcription consoles or cabinets. The base is drilled and tapped for mounting Audak, Grey or Pickering arms. Maintenance is simple . . . turntable, motor pulley and idlers are easily accessible.

OUTSTANDING FEATURES:

- 45 RPM Adapter . . . disappearing type, built into hub of turntable.
- Aluminum Base . . . square shape, radial ribbed for utmost rigidity.
- Speed Changes . . . instantaneous for all three speeds—controlled by selector.
- Speed Shift . . . Mastermatic, self-locking. A REK-O-KUT exclusive.
- Speed Variation . . . Meets the N.A.B. standard for speed variation and "wow" content.
- Turntable . . . 16" cast aluminum: lathe turned, with extra heavy rim for balanced flywheel action. Sub-mounted in base.
- Motor . . . Hysteresis Synchronous, 60 cycles AC, 115 volts. Available in other frequencies and voltages at extra cost.
- Dimensions . . . 1 $\frac{1}{2}$ " above base, 6" below, 20" wide x 18 $\frac{3}{4}$ " deep. Shipping weight, 30 lbs.

MODEL B-16H \$250.00 net.

Available at Leading Radio Parts Distributors. Write for detailed literature.

REK-O-KUT CO.

38-01 Queens Blvd., Long Island City, N. Y.
EXPORT DIVISION: 458 Broadway, N. Y. C. U.S.A.
Canada: Atlas Radio Corp., Ltd., Toronto 28, Ont.



AUDIO PATENTS

RICHARD H. DORF*

TWO POWER-AMPLIFIER CIRCUITS invented by Harry W. Becker of Chicago provide interesting possibilities for achieving high output and low distortion together with rather unusual economy of materials and size.

The first is a single-tube output stage with, according to the inventor, the advantages of push-pull, negative feedback, and low source impedance normally present only in much more elaborate circuits. The patent is numbered 2,595,443 and the schematic is shown in Fig. 1.

The principal "gimmick" here is an output transformer with two primary windings and extremely simple but ingenious circuitry in connection with it. The tube is a beam tetrode—perhaps a 6L6 or something similar. The high end of the input signal is connected to the grid through blocking capacitor C_1 in the usual manner and the other end of the input source may be grounded. The lower end of grid-leak R_1 is connected to the lower end of cathode-bias resistor R_2 , which is bypassed in the usual way by C_2 . The junction of the two resistors is not connected directly to ground, however, but through winding B of the transformer. Winding B is thus the load element of a conventional cathode-follower of the type in which the grid leak is usually connected to a tap on a cathode resistor.

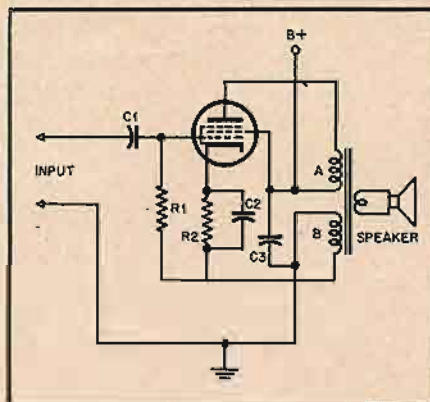

Fig. 1.

At the same time winding A is used as the load element for the plate in the standard manner. The screen is simply connected to the B-plus line and is bypassed to ground in the usual way by capacitor C_3 . As it stands, then, we have a stage acting simultaneously as a cathode follower and as a plate-loaded amplifier, with the outstanding departure from the norm that the load elements are also coupled to each other magnetically.

Forgetting for the moment about screen current—when the grid goes positive, plate current flows downward through winding

A (using the convention more common to electronics that current flow and electron flow are identical) from plate to power supply. At the same time the cathode current flows downward through winding B from ground to cathode. The two windings are thus in series aiding, with inverse voltage drop relations with respect to ground. The latter is so because actual ground is connected to the end of winding B nearest the center of the primary and a.c. ground (we assume the power supply is conventionally bypassed by its filter) is connected to the end of winding A nearest the center. This is the same condition as occurs in an ordinary push-pull stage.

Winding B, however, is the load element of a cathode follower. As such, the voltage across it is in phase with the input voltage and the net voltage across it is the differential. The resulting feedback tends to reduce distortion, as in any cathode follower, and increase the effective input impedance of the stage. Because of the magnetic coupling with the plate winding A, noise and distortion generated within the stage itself is reduced even further.

So far the amplifier should give good results with enough excitation to produce rated output. The output may be increased well above normal rating, however, without increase in distortion because of the screen current. Screen current is, as usual, out of phase with plate current; that is, when the grid goes positive and plate current increases, screen current decreases. The a.c. component of the screen current passes through C_3 , through winding B, to the cathode (through the bias bypass capacitor). Passing through winding B in opposite phase to the plate portion of the cathode current, it is sufficient to cancel the distorted portion of the plate current.

As an additional bonus, winding B is connected to a low-impedance source (the tube cathode) and provides a high damping factor on the loudspeaker load connected to the transformer secondary, thus reducing the distortion normally resulting from the use of tubes with high plate impedance.

Used as a power amplifier there would probably be no voltage gain, especially if these windings A and B were identical. The inventor points out, however, that the circuit can be used for a voltage amplifier if winding A is given a larger number of turns than winding B. The voltage amplifier would retain the advantages of simulated push-pull operation and negative feedback. What the actual relative number of turns is when the circuit is used as a power amplifier is not stated, but the language of the patent specification leads the writer to believe them identical, which means that a conventional split-primary transformer could be used.

Double Push-Pull System

The second Becker patent, No. 2,595,444,

* 255 W. 84th St., New York 24, N. Y.

**SILECTRON
"C" CORES**
*for quick
delivery*
**IN
PRODUCTION
QUANTITIES**

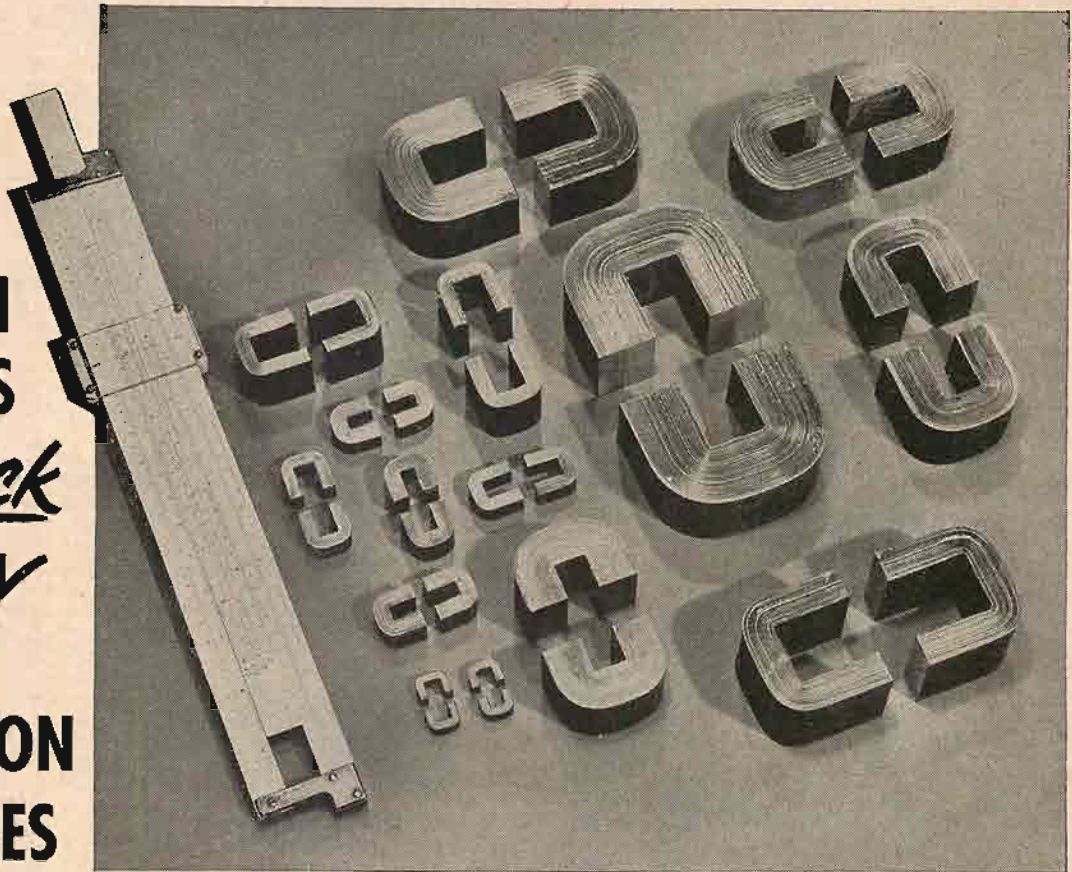

... wound from strip as thin as 0.00025"

*Quality-Tested
and Proved*

- ★ Arnold "C" Cores are made to highly exacting standards of quality and uniformity. Physical dimensions are held to close tolerances, and each core is tested as follows:
- ★ 29-gauge Silectron cut cores are tested for watt loss and excitation volt-amperes at 60 cycles, at a peak flux density of 15 kg.
- ★ 4-mil cores are tested for watt loss and excitation volt-amperes at 400 cycles, at a peak flux density of 15 kg.
- ★ 2-mil cores are tested for pulse permeability at 2 microseconds, 400 pulses per second, at a peak flux density of 10 kg.
- ★ 1-mil cores are tested for pulse permeability at 0.25 microseconds, 1000 pulses per second, at a peak flux density of 2500 gauss.
- ★ 1/2 and 1/4-mil core tests by special arrangement with the customer.

Now available—"C" Cores made from Silectron (oriented silicon steel) thin-gauge strip to the highest standards of quality.

Arnold is now producing these cores in a full range of sizes wound from 1/4, 1/2, 1, 2 and 4-mil strip, also 29-gauge strip, with the entire output scheduled for end use by the U. S. Government. The oriented silicon steel strip from which they are wound is made to a tolerance of plus nothing and minus mill tolerance, to assure designers and users of the lowest core losses and the highest quality in the respective gauges. Butt joints are accurately made to a high standard of preci-

sion, and careful processing of these joints eliminates short-circuiting of the laminations.

Cores with "RIBBED CONSTRUCTION" can be supplied where desirable.

Ultra thin-gauge oriented silicon steel strip for Arnold "C" Cores is rolled in our own plant on our new micro-gauge 20-high Sendzimir cold-rolling mill. For the cores in current production, standard tests are conducted as noted in the box at left—and special electrical tests may be made to meet specific operating conditions.

● **We invite your inquiries.**

*Manufactured under license arrangements with Westinghouse Electric Corp.

WAO 4211

THE ARNOLD ENGINEERING COMPANY



SUBSIDIARY OF ALLEGHENY LUDLUM STEEL CORPORATION

General Office & Plant: Marengo, Illinois

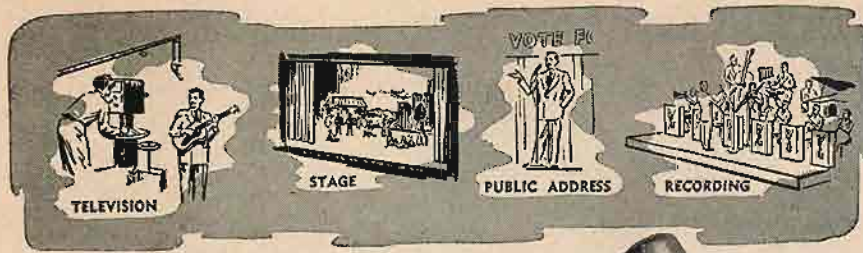

It's New!

The TURNER 51D



The new Turner Model 51D (similar to the Model 50 Aristocrat) offers exceptionally high quality performance at a new low cost. The Model 51D is essentially non-directional in operation — equally effective for individual or group pickups. A unique ball swivel coupler permits fast change from stand to hand or vice versa.

Use the Model 51D anywhere, indoors or out — it's blast-proof, and not affected by variations in humidity or temperature. Advanced circuit design with high output dynamic generator requires no closely associated auxiliary equipment for outstanding results.

For TV, FM, AM, recording and public address specify the Turner Model 51D — the outstanding dynamic microphone in its field.

SPECIFICATIONS

- Frequency Response:** 60 to 13,000 c.p.s. substantially flat.
- Output Level:** 58 db below 1 volt/dyne/sq. cm. at high impedance.
- Impedance:** Choice of 50, 200 or 500 ohms connected for balanced line output; high impedance (25,000 ohms) connected for single ended output.
- Polar Pattern:** Essentially non-directional in any position.
- Transformer:** Magnetically shielded for minimum hum pickup.
- Diaphragm:** Special aluminum alloy.
- Case:** All metal rich umber grey finish.
- Mounting:** Ball and swivel type, tilts in any direction. Standard $\frac{5}{8}$ " — 27 thread.
- Dimensions:** $1\frac{5}{8}$ " maximum diameter, $6\frac{1}{2}$ " long (less cable connector).
- Weight:** 16 oz. (less cable).
- Cable:** 12 foot high quality two conductor shielded cable with Cannon quick-disconnect plug.
- List Price:** \$85.00.

THE TURNER COMPANY

929 17th St. N.E. • Cedar Rapids, Iowa

IN CANADA:
Canadian Marconi Co., Ltd.
Toronto, Ont., & Branches

EXPORT
Ad. Auriema, Inc.
89 Broad Street, New York 4

consolidates the gains of the first and parlays them into a double push-pull circuit in which two tubes do the work of four. The circuit, shown in Fig. 2, gives the details.

The grids of the tubes are excited by the output of any standard phase splitter in the usual way. Consider first V_1 and its connections, looking for cross-reference at Fig. 1. Windings A and B of the output transformer correspond in the two figures. Examination shows that if V_2 and its circuits, along with windings A' and B' were eliminated, the remaining components and connections would be identical to Fig. 1. Now the inventor adds two more windings, A' and B', together with tube V_2 —the circuitry of which is identical to that of V_1 —and excites the grids out of phase. The result is, of course, the same as in Fig. 1 but twice as much of it, plus, for the Thomases who doubted the possibility of real balance in the early circuit, assuagement of their doubts, for the later idea is certainly genuine push-pull. And, says the inventor, the power delivered by two tubes in this circuit at a given distortion (the actual phraseology of the patent uses the word "undistorted," about as vague as exists in audio today) is approximately twice what the same tubes would deliver in a conventional push-pull amplifier!

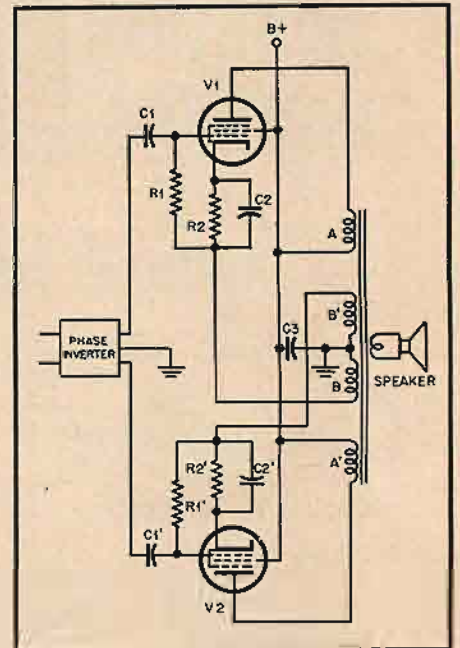

Fig. 2.

A.F.C. Discriminator

There are few complaints the writer has heard more from both lay audio fans and technical personnel than those concerning FM tuner drift, especially on weak stations. There are, of course, tuners now with a. f. c. but many an old tuner can fairly easily be converted to automatic frequency control. The satisfying result is that you tune somewhere near a station and suddenly it drops into place; no more delicate tuning for the exact center and no more getting up every ten minutes to retune. Clyde J. Norton has invented an a. f. c. discriminator which is simple but accurate, and is effective over a good deal wider deviation range than usual. The patent, assigned to Sylvania, is No. 2,581,968, and the circuit is diagrammed in Fig. 3.

L_1-C_1 and L_2-C_2 are a pair of series-resonant circuits connected in parallel with each other and across a source of r. f.

[Continued on page 68]

DEPENDABLE

GATES

SPEECH INPUT EQUIPMENT

Meets Your Requirements Today - and Tomorrow!

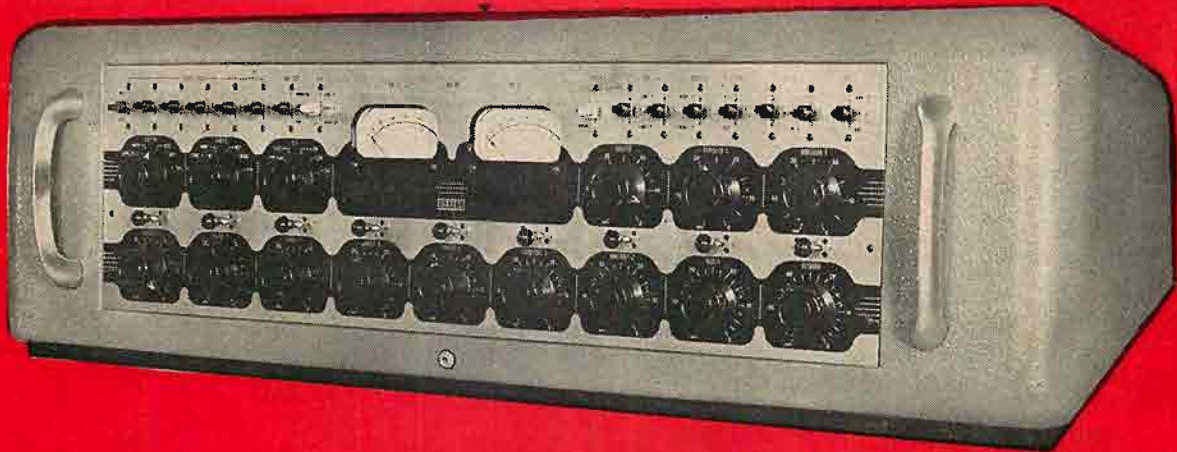

GATES SA-50 DUAL SPEECH CONSOLE

Typical of a comprehensive GATES Speech Input system is the SA-50 Dual Speech Console illustrated above.

Consisting of the main console and power supply unit, the SA-50 provides almost unlimited facilities for smooth uninterrupted studio operation of the most complex nature. Nine mixing channels: five for microphones, two for turntables and one each for remote and network service. Separate PBX type keys allow selection of any mixing channel into one of two program amplifiers.

NINE AMPLIFIERS

Five 2-stage preamplifiers and two 4-stage high gain program amplifiers are contained within the console. A ten watt low distortion monitoring amplifier and a two watt cueing amplifier are part of the separate power supply unit. Space is provided in console for two additional preamplifiers if needed. Sub-chassis units are individually removable for servicing without disrupting operation of balance of console.



SA-40 SPEECH INPUT CONSOLE

Similar in size and symmetry to the SA-50, the SA-40 Console is characterized by its extreme flexibility of operation. Of modern design, it is generously equipped for a most comprehensive installation.



Nine channels are provided; five for preamplifiers, three for turntables and one for net-remote. Seven amplifiers include five 2-stage preamplifiers, one 4-stage program amplifier and one 3-stage monitoring amplifier. Provision is made for connecting external cueing amplifier. Cabinet construction follows that of the SA-50 and features easy accessibility of all components.

Whether for video or standard broadcasting, Engineers, with an eye to the future, will appreciate the exceptional versatility of GATES Speech Input Equipment. Here is equipment with unusual adaptability to the ever-changing demands of programming techniques. If you are planning a studio installation today — think of tomorrow, and consider the flexibility, the **expandability** of GATES Speech Input Equipment.

Space prevents fully describing the circuit handling capabilities of the three consoles shown. You are invited to write for the GATES SPEECH INPUT CATALOG where functional block diagrams and additional data will better acquaint you with these versatile GATES Consoles — truly, Speech Input Equipment With A Future.



52-CS STUDIOETTE

Ideally suited for small station studio applications or as part of larger master control type installation, the GATES 52-CS Studioette has all of the necessary facilities for complete studio operation and will fulfill the most rigid requirements of fidelity, low noise and distortion. Facilities include four mixing channels, Two preamplifiers, one program amplifier and one monitoring amplifier plus complete power supply are self-contained.

Send for GATES SPEECH INPUT CATALOG Today.

GATES

GATES RADIO COMPANY, QUINCY, ILLINOIS, U. S. A.
MANUFACTURING ENGINEERS SINCE 1922

2700 Polk Avenue, Houston, Texas • Warner Building, Washington, D. C. • International Division, 13 E. 40th St., New York City
Canadian Marconi Company, Montreal, Quebec

CANNON PLUGS

for laboratory and switchboard



CSR Tandem Receptacle
CSP Plug

Here are a few examples of Cannon's Experimental Laboratory and Switchboard Connectors. They are used extensively throughout industry, public utilities, sound studios, broadcasting stations, college and university physics and chemistry laboratories, in AC network analyzers and electronic analog computers. They may be applied wherever quick disconnect switching

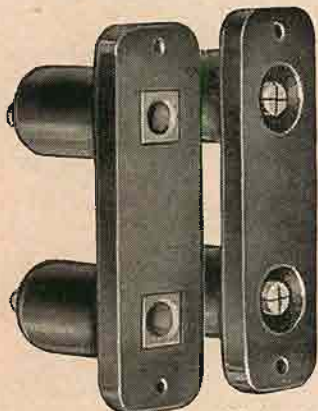

SDR Receptacle

SDP Receptacle

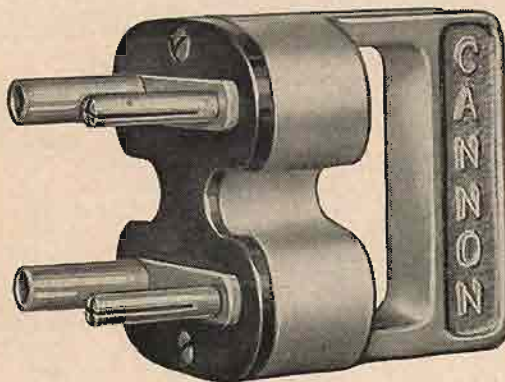

SWPR-4 Switching Plug having both
pin and socket contacts



SR Receptacle

and patch cord plugs are required. High grade materials are used throughout. Molded phenolic of high dielectric strength is used for insulation. Both pin and socket contacts are machined from solid brass. Some are silver plated. All are rated at 75 amps. Pin contacts are split for low loss seating in tapered bore sockets. Single contact fittings are supplied in either red or black phenolic to designate direct or alternating current circuits respectively. Two-contact and larger plugs have sand-blasted cast aluminum shells and handles with clear lacquer finish. Various combinations of pin and socket contacts are used as a polarizing guide. For further information write for Bulletin LS5-1951.



SCR Plug

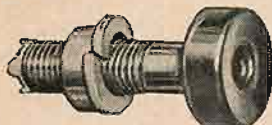

SRB Receptacle



SCP Plug

CANNON ELECTRIC

Since 1915



Factories in Los Angeles, Toronto, New Haven, Benton Harbor. Representatives in principal cities. Address inquiries to Cannon Electric Company, Dept. J-109, P. O. Box 75, Lincoln Heights Station, Los Angeles 31, Calif.

LETTERS

Oscillator

Sir:

Now and then an author proceeds from a soundly-reasoned base to theoretical conclusions which are so obviously true that he fails to check them against practice. Unfortunately, when theory and experimental fact are in collision, it is theory that must be revised.

We fear that Dunford A. Kelly, in the August issue, has made this unhappy mistake. Referring to the SMPTE intermodulation test, he reasons that "Thus the results do not correspond to audible distortion." We are sorry to have to point out that the motion picture industry, through many listening tests, showed about fifteen years ago that the SMPTE intermodulation test results *do* correlate with aural judgements of distortion. They have, therefore, continued to rely on this method for system and equipment tests.

We note, also, that he has fallen into the pitfall of believing that "predictable ratios correlate harmonic and intermodulation levels." While this is true in some cases, in most cases it is simply not so. As a single example, consider an amplifier which consists of a wide-band non-linear first stage followed by a linear low-pass second stage which cuts off sharply at 15,000 cps. Harmonic analysis will indicate that the system generates no harmonics when the input frequency is above 7,500 cps, and that it generates no harmonics other than the second when the input frequency is between 5,000 and 7,500 cps. Intermodulation tests, however, when properly applied, will indicate non-linearity of *all* orders for frequencies nearly up to the cutoff point. It is clear, therefore, that any correlation between the results of the various distortion tests must depend strongly on the frequencies at which the tests are carried out.

Aside from our criticisms, we wish to congratulate Mr. Kelly on an excellent piece of design work.

C. J. LeBel,
Audio Instrument Company, Inc.
133 W. 14th St.
New York 11, N. Y.

AMPLIFIER

Sir:

Since publication of my article on the "Williamson Up To Date," I've received a considerable amount of correspondence relative to other transformers and circuit modifications. Accordingly, I believe it may be desirable to supply a few additional details in order to help answer these questions for all interested readers.

As for transformers, the one specified was used originally because it is satisfactory, and I had one immediately available. The output transformer in the 100-watt amplifiers mentioned was built by Freed, and the characteristics and performance are outstanding. Many other excellent units are available, and suitable performance should be expected from any of the better-quality lines.

Several manufacturers supply excellent non-inductive wire-wound resistors. Two-watt composition units are really quite good, and it is likely that use of such units in a power amplifier would not cause any difficulty.

Recent discussions on the Williamson amplifier have indicated a potential increase in output with reduced IM when a tapped



Sound Survey Meter



portable
accurate
inexpensive
easily operated

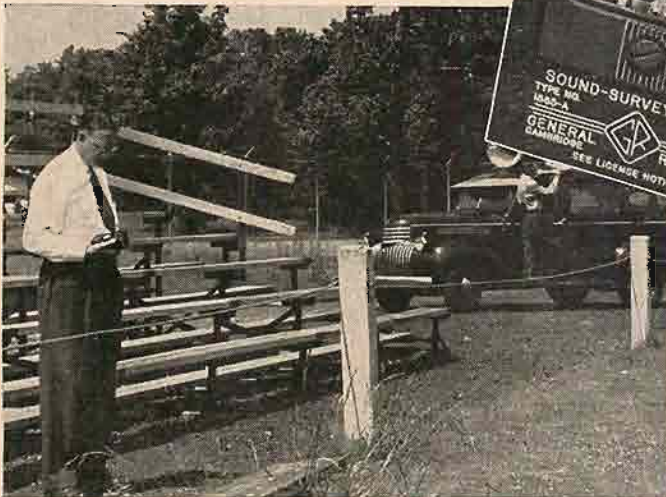

Locating "dead spots" with Sound Survey Meter. Assistant repositions speakers to improve coverage.

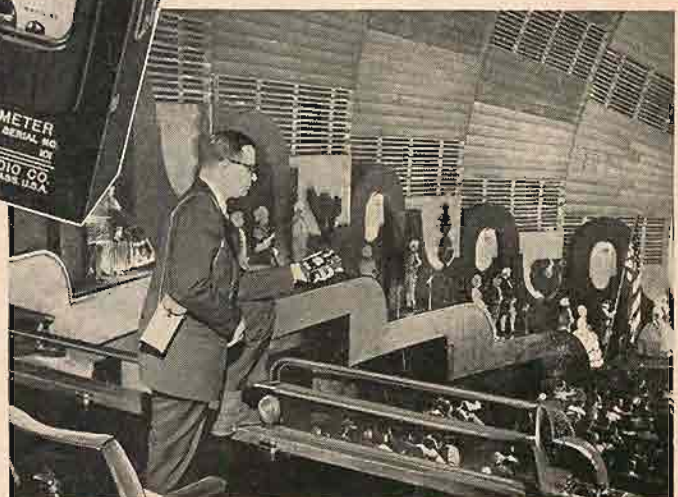

Mr. Warren Jenkins, Sound Engineer at Radio City Music Hall, checks performance of sound reinforcement system at this theatre.

The G-R Type 1555-A Sound Survey Meter saves time and improves quality of sound system installations at plants, offices, theatres, halls, churches, public buildings, schoolyards and playgrounds, recreation centers and outdoor gatherings.

This handy, versatile instrument simply and accurately measures the intensity of sound at any given point. It is very useful for both the measurement of background noise preliminary to public address, theatre or high fidelity system installation, and for checking the level of reproduced sound from such systems. By simply passing oscillator test tones or recorded voice through the amplifier-speaker system and noting the Sound Survey Meter indication at various locations, the installer can readily:

- ★ Set volume to override background noises and cover all of desired area.
- ★ Locate speakers to eliminate "dead spots".
- ★ Determine adequate system frequency response for the particular sound—music, voice or other—to be amplified.

The Sound Survey Meter also finds wide use for determining sound levels of appliances, machinery and office equipment, for measuring acoustic reference levels when recording, and response characteristics of loudspeakers and rooms, and for preliminary checks to ascertain existence of noise levels harmful to hearing in factories and offices.

G-R Type 1555-A Sound Survey Meter consists of a microphone, a calibrated attenuator, an amplifier, an indicating meter, and weighting networks.

- ★ Continuous level control and large panel meter permit reading at a glance
- ★ Fits in trousers pocket; dimensions are 6 x 3 $\frac{1}{8}$ x 2 $\frac{1}{2}$ inches
- ★ Weighs only 1 lb., 14 oz. with batteries
- ★ Can be operated on a bench, tripod, or in hand by anyone
- ★ Range is from 40 to 136 db above standard reference level
- ★ Three frequency characteristics approximate response of the ear at 40 db, 70 db, and levels above 85 db. Uniform response to all frequencies between 40 and 8,000 cycles also provided.

TYPE 1555-A Sound Survey Meter . . . \$125
TYPE 1555-P1 Leather Carrying Case . . . \$10



GENERAL RADIO Company

275 Massachusetts Avenue, Cambridge 39, Massachusetts, U. S. A.
90 West Street NEW YORK 6 920 S. Michigan Ave. CHICAGO 5 1000 N. Seward St. LOS ANGELES 38

here's

absolute reliability

for heavy duty
audio
amplification

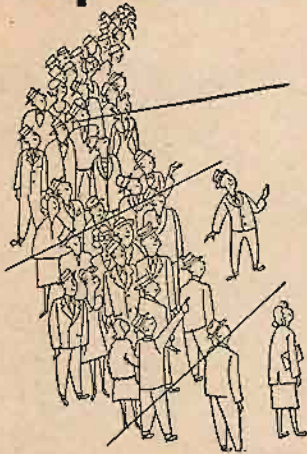

TUNG-SOL

5881

**BEAM
POWER
AMPLIFIER**

If you've been looking for an audio output tube that's stable under the most severe conditions—completely dependable—then this is it! The Tung-Sol 5881 is rugged both mechanically and electrically—and directly interchangeable with the 6L6.

In creating the 5881, Tung-Sol engineers have made lavish use of the design and production techniques which have proved themselves over the past fifteen years—zirconium coating over the carbonized metal plate and pure barium getter to effectively absorb gas for the life of the tube—gold plated wire to minimize grid emission. These are but a few of the major design improvements in the 5881.

Tung-Sol produces the 5881 under laboratory conditions, to assure peak efficiency and maximum uniformity. You'll find this tube has the stuff to take the whole range of audio service requirements from protracted standby periods to repeated heavy overloads. So, if absolute reliability is essential in your audio circuits, the Tung-Sol 5881 is a "must." Order it from your regular supplier.

Write for characteristics and performance data

TUNG-SOL ELECTRIC INC., NEWARK 4, N. J.

Sales Offices: Atlanta • Chicago • Culver City (Calif.)
Dallas • Denver • Detroit • Newark

Tung-Sol makes All-Glass Sealed Beam Lamps, Miniature Lamps, Signal Flashers, Picture Tubes, Radio, TV and Special Purpose Electron Tubes.

transformer is used. The majority of circuits can be slightly improved by this means, but the gain may be offset by the reduced damping that inevitably results when the screen-connected circuit is used.

Due to the inherent stability of the basic "up-to-date" circuit which employed adequate interstage decoupling and a power supply of relatively low impedance, the screen connection may be made readily without the necessity of modifying the original feedback-loop components or the interstage coupling circuits. Note that 40- μ f electronic capacitors were used in lieu of the original 10- μ f units. The use of paper units in this application is not practicable.

Tests were made by connecting the screens to the Peerless transformer taps as suggested in the Sarsar-Sprinkle article (*Æ*, July 1952). It was found that at a 26-watt level, inclusion of the 100-ohm resistors in the circuit dropped the IM from 8 per cent to 7 per cent. (The screen impedance and voltage dropping action of the series resistor apparently provide a more nearly correct voltage ratio on the screens.) The use of an 80- μ f cathode bypass capacitor on the 807's dropped the IM from 16 per cent to 9.5 per cent at a 27-watt level, but had no measurable effect at power levels below 12 watts. A 300- μ f capacitor provided a bit better performance at low frequencies.

Use of the 12AY7 and 5687 stages with the components specified in the "Up-to-Date" amplifier is entirely practicable with the Ultra-Linear output circuit, and the general design principles are, of course, suitable for any similar power amplifier. The feedback loop should use the greater amount of feedback as shown in the writer's article, and for minimum distortion and maximum output should use the 250-ohm bias resistor in lieu of the 300-ohm unit shown in the Ultra-Linear modification in the July issue.

Almost any desired pair of output tubes—807's, 5881's, 1625's, or KT-66's—may be used with but negligible difference in performance. The use of d.c. on power amplifier heaters is not apparently necessary, and no measurable improvement is effected.

M. V. Kiebert, Jr.,
Eclipse-Pioneer Division,
Bendix Aviation Corporation,
Teterboro, N. J.

Tuners

Sir:

Recent letters to the Editor have touched upon the poor quality of transmission from FM stations and the poor state of repair of FM sets as a probable reason for the less-than-satisfactory FM reception too frequently encountered.

Dismissing for the moment the special problems of fringe-area transmission and reception, it seems to me that both of the FM faults alluded to above flourish even in places where they have no business to be found—namely, in and around large cities.

To begin with, many FM tuners are in a poor state of repair because they are primarily products of impoverished design (electrical and mechanical), and built to low or no standards. In contrast to the several superb amplifiers that are available at reasonable prices, and the host of creditable or satisfactory ones that are available at lesser cost, there is only one superb FM tuner available at any price, and perhaps only two satisfactory ones in the \$150 price range.

There are available, however, any number of calibrated proximity fuses which fortuitously—certainly not by design—can furnish an FM input signal of some sort, with the help of a subpoena. This electronic sow's ear is then required to be processed into an acoustically silken purse, with inevitably disappointing results. Mere inspection reveals these "FM tuners" to be endowed with a haphazard physical layout reminiscent of an impromptu North African bazaar. Superimposed on this heap of poorly-shielded trash is a dial designed to take the place of a bank reference, which it never quite succeeds in doing. The whole is then studded with knobs that guarantee acceptance in an exclusive after-shave-lotion club.

The plain fact is that the minds and hearts of those best qualified by training and personal standards to design and produce good r.f. equipment for the quality conscious have, since the war, been devoted primarily to the improvement of the various audio components of quality sound systems. Enough progress has been made, I believe, to justify a change in emphasis to permit r.f. to catch up with a.f. There is no reason, with the myriad engineering talents which exist within and without the framework of commercial organizations catering to the audio fraternity—and despite the often-short-sighted and sometimes even shabby attitudes of the management that employs them—why there should not be available on the market a mass-produced FM tuner in the \$150 price class that possesses the following among its attributes:

1. Stable circuits, effectively shielded; functions based upon less spectacular but more dependable tubes.



hear that...?

It's recorded on **SOUNDCRAFT TAPE!**

The best radio entertainment
is recorded on the best tape...

SOUNDCRAFT MAGNETIC RECORDING TAPE

Radio experts know the importance of using quality tape in recording the programs they produce. They accept only the best in sound performance. And that's precisely the reason why so many of the fine radio programs you hear are recorded on Soundcraft Tape.

Because Soundcraft has everything you could ask for in recording tape: superior quality and fidelity — uniformity — sensitive high frequency response — resistance to temperature and humidity changes — smooth, curl-free operation.

Choose Soundcraft . . . and you choose the only tape manufactured by specialists with 20 years of continuous experience in the sound recording field. You choose tape of professional quality . . . for professional performance!

REEVES

SOUNDCRAFT CORP.

10 East 52nd Street, N. Y. 22, N. Y.

THE ONLY RECORDING MATERIALS
PERFECTED AND MANUFACTURED
BY RECORDING SPECIALISTS

Please write Reeves Soundcraft for additional information.



Visit us at:
The Audio Fair
Room 508

EVERYBODY'S TALKING ABOUT NEWCOMB'S
"AUDI-BALANCE"

PATENT APPLIED FOR

"The greatest amplifier improvement in recent years" . . . A godsend to both owner and service man." . . . "It used to take me hours to do what Audi-balance does in seconds." . . . "Does even better than I've been able to do with meters, this balances tubes dynamically." . . . "The problem has plagued us for years, it is now possible to keep perfect balance in output tubes consistently for lowest distortion." . . . "Audi-balance is the perfect solution."

Just one of the features that make the brand new Classic amplifiers by Newcomb so exciting. Write for catalog of 8 completely new home music amplifiers priced from \$39.50 to \$269.50 audiophile net.



NEWCOMB

DEPT. T 6824 LEXINGTON AVENUE, HOLLYWOOD 38, CALIF

15 years of quality leadership

The World's Largest Distributor

of

Minnesota Mining & Mfg. Magnetic Tape

is the



Audio & Video

PRODUCTS CORPORATION

730 Fifth Avenue, New York 19, N.Y. • Plaza 7-3091

Exhibiting at the Audio Fair — Rooms 614 & 615

2. For large metropolitan areas, a model with crystal-controlled discontinuous tuning.
3. For fringe areas, a model with variable sensitivity and effective noise suppression between stations; a tuning mechanism that does not depend on a piece of string.
4. Tuning controls that permit mounting in various positions on panel boards of various thicknesses; demountable gain controls and a.c. switch for installations where they are not needed. (Note the ascendancy of the pre-amp master control center.)
5. Hardware and assembly that can withstand a 5-m.p.h. breeze with occasional 10-m.p.h. gusts.

It will be argued immediately by most manufacturing members of the "hi-fi" industry that what I want cannot be made to "retail" for \$150 and yield a fair profit. Let me say that the cost of components and labor going into, say, a Williamson amplifier, may easily be committed by less talented designers to produce an amplifier whose performance bears no more relationship to that of the Williamson than cattle to cantaloupes. Electronics, like mathematics, is a language—a means of expressing ideas—rather than a science. Using resistors, inductors, capacitors, and other characters of the electronic alphabet, it is possible to fashion components and phrases of circuitry that possess clarity, elegance, wit, economy, subtlety, or—in lesser hands—the banality, crudeness, stupidity, bluntness, and waste of greeting card poetry or prose.

Samuel Miller,
 122 E. 78th St.,
 New York 21, N. Y.

Records

Sir:

I am about to confess to something approaching complete bafflement. I am trying to find out how to equalize a pickup, and can't get to first base. Or rather, I get to six different first bases. Comparing the various articles on the subject in the *AUDIO ANTHOLOGY*, I can find no agreement on what we are trying to equalize.

What are the modern, commonly met recording characteristics? Surely it cannot be true, as some say, that the recording characteristic of any given record depends upon the whim-of-the-moment of some obscure recording technician. One embittered friend suggests that modern recording consoles are equipped with two roulette wheels, mounted on multiposition free-acting switch shafts—one marked TRNVR FREQ and the other PRMSS, IF ANY. Are things as bad as this?

Please understand that I would know how to design a suitable network if I only knew what I was trying to design. Perhaps you know if any records are available from the larger manufacturers which are cut on their "usual" equipment, with a sine-wave voltage of constant magnitude applied to the input of the recording console as the frequency is swept over the audio spectrum. (Yes, they are. Ed.) Such records might take this whole matter of equalization out of the realm of crystal-gazing, entrail-divination, and rune casting.

I will very much appreciate any advice and comfort you can offer me. At least, perhaps you will say that everyone is as confused as I am.

Eugene Altman,
 63-61 99th St.,
 Forest Hills 74, N. Y.

(We so say. Our advice always is to provide adequate flexibility of controls, and then so adjust them that the resulting sound output pleases the ear. Ed.)

"This new 7-inch Professional reel gives big reel results!"

Norman P. Keel

Chief Engineer, WEBC,
Duluth, Minn.

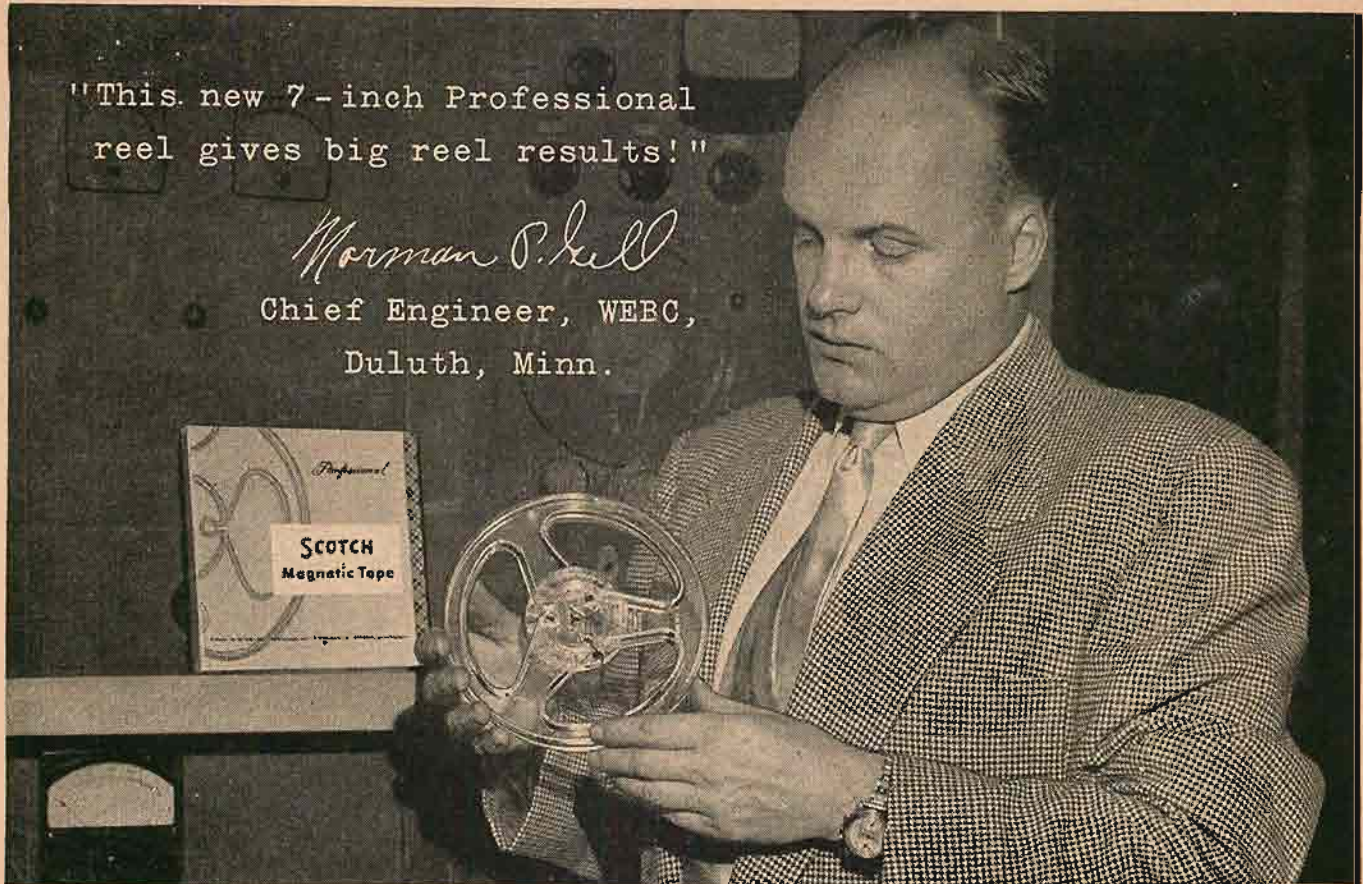

It's the new large-hub 7-inch professional reel of "SCOTCH" Magnetic Tape!

- ✓ **CUTS TIMING ERRORS!** New larger hub reduces tension changes, cuts timing errors 50%.
- ✓ **REDUCES PITCH CHANGES!** Lower hub-to-outside-diameter ratio means a marked reduction in pitch changes between spliced portions of broadcasts.
- ✓ **LESS VIBRATION, FASTER REWIND!** Bigger hub produces 10% faster rewind speed, yet rotational speed is lower than that of the standard reel. Operation is so smooth that wear on equipment is cut, with resulting maintenance savings.

The term "SCOTCH" and the plaid design are registered trademarks for Sound Recording Tape made in U. S. A. by MINNESOTA MINING & MFG. CO., St. Paul 6, Minn.—also makers of "Scotch" Brand Pressure-sensitive Tapes, "Under-seal" Rubberized Coating, "Scotchlite" Reflective Sheeting, "Safety-Walk" Non-slip Surfacing, "3M" Abrasives, "3M" Adhesives. General Export: 122 E. 42nd St., New York 17, N.Y. In Canada: London, Ont., Can.



New improved tape matches reel improvements!

Supplied on the new 7" professional reel is a new type of magnetic tape that offers many technical advantages:

- New "Dry Lubricating" process eliminates tape and head squeal, produces a tape that turns in a faultless performance under conditions of extreme heat and humidity.
- New thinner construction allows more than 1200 feet of tape to be wound on the new 7" reel despite larger hub. Magnetic properties of this new tape are identical in every respect to the older "Scotch" Brand #111-A tape, the industry's standard of quality.
- Tape supplied on the new reel is 100% splice-free.
- Output variation is guaranteed to be less than plus or minus ¼ db at 1,000 cps within the reel, and less than plus or minus ½ db from reel to reel.

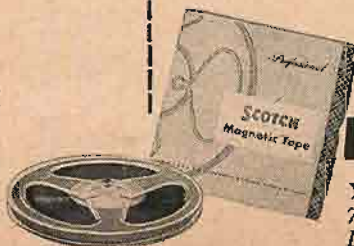

RIG U S PAT OFF
SCOTCH
BRAND
MAGNETIC TAPE

Your supplier has the new "Scotch" Brand 7" professional reel with the new Dry Lubricated tape. See him today!

Available from stock
at TRIAD
jobbers!



"The World's Smallest Hermetically Sealed Transformer"

Miniaturization has become increasingly important in the design of all types of electronic equipment. Use of improved core materials and better winding techniques in our JAF series permits these great reductions in size and weight of low level audio transformers. TRIAD JAF Transformers, as listed below, are "the world's smallest hermetically sealed transformers." All have 45 db. shielding and are available in MIL standard AF case as shown above. Carried as stock items at all Triad jobbers.

Type No.	Impedance		Req. Resp.	List Price
	Primary	Secondary		
JAF-1	600/250/50	50000	100-10000	\$14.50
JAF-2	600/250/50	250000	300-3000	15.30
JAF-3	600/250/50	60000 C.T.	100-10000	15.30
JAF-11	15000	50000	100-10000	13.60
JAF-12	15000	60000 C.T.	100-10000	14.50
*JAF-13	15000	95000 C.T.	350-5000	15.30
JAF-21	15000	600/250/50	100-10000	14.50
*JAF-22	15000	600/250/50	350-5000	14.50
JAF-23	20000 C.T.	600/250/50	100-10000	15.30
JAF-31	600/250/50	600/250/50	100-10000	14.50
JAF-101	50 h.-1 Ma.			11.60

Maximum level +10 dbm.
except JAF-1, 2 and 3 (0 dbm.)

*DC in primary.

Write for Catalog TR-52C

Plant, General Offices: 4055 Redwood Ave.
Venice Area, Los Angeles, Calif.
Address correspondence to: Box 17813
Los Angeles 34, Calif.

London Letter:

The British National Radio Exhibition

LEONARD CARDUNER*

An eye-witness account of an annual event at which most of us would be present if it were not so far away, written with the American viewpoint.

LONDON, SEPT. 1, 1952: A few years ago, when I last visited the British National Radio Exhibition then being held in Olympia, London, the British radio industry was just getting back on its feet after the war. At that time there was little activity in television and the 78-r.p.m. record player was still standard even though 33 1/3 r.p.m. had already become an impressive trend in the American phonograph industry. This year, however, the Exhibition indicated the wide-awake, up-to-date attitude which has been reflected by the success of certain British electronic and audio products in our own country. For example, British three-speed record players are now virtually standard in England, and indeed such machines as the Garrard (well known to American enthusiasts) are seen not only in high-fidelity arrangements but are furnished with the radio-gramophone combinations of the major radio manufacturers.

No longer at Olympia, the National Radio Exhibition was held for the second year at much larger quarters, in Earl's Court, London. This additional room made possible various elaborate demonstrations aimed at giving the visitor a sense of almost personal participation in the processes of radio manufacturing, television broadcasting, and military communications.

England's radio show is one of the three most popular public exhibitions in Great Britain. It is the largest radio show of any held in the world, and in fact, has no counterpart in the United States. Every effort seems to have been made to keep the exhibits fresh, lively, and topical—entertaining as well as informative. For example, one fascinating exhibit, of the type one never sees in American shows, was by the manufacturers of Multicore Solders. A television camera was actually being assembled with some 10,000 soldered joints being made on each equipment. These Pye television cameras, after the Show, will be sent back to their Plant at Cambridge for test. I am informed that it was the largest practical working demonstration ever seen at the radio show.

Walking through the busy floors among the thousands of people, who obviously are the general public not connected with the industry, I almost had the same impression I used to get at the great American automobile shows before the war, when everyone went to see the new cars whether he was buying or not and whether he made cars, sold them, or merely rode in them. About a quarter of a million visitors pay to see the British Radio Show each year.

In the United States, we now have the Audio Fairs to interest the ever increasing numbers of people who want to listen to the finest in home musical reproduction.

* British Industries Corp., 164 Duane St., New York 7, N. Y.

Except for the Audio Fairs, however, there are few trade exhibitions designed to attract the man on the street, and most of those that do exist are held as private showings by individual manufacturers or retailers. Our trade shows, of course, are rigidly closed to the public.

The Radio Show in London, however, is not merely an exhibition of equipment, it is a place where people are invited behind the scenes of radio and television, meet quite a few of the entertainment people they normally see or hear from afar, and talk directly with those who design and manufacture the sets. Quoting from a recent description of the show, "It is the recognized annual get-together of the listening and viewing public, the B.B.C., and the manufacturers and dealers, and a celebration of the opening of another Autumn and Winter season of good listening and viewing." No amount of advertising and merchandising ingenuity can describe the sound of high fidelity reproduction; no illustration or description of the clarity of television pictures can do as much to sell television as an actual demonstration. During the past few days, I have seen almost every British radio receiver of any importance, as well as broadcasting and communication equipment, short wave, short range communication for professional and business purposes, navigating aids, industrial and medical electronic equipment and components and tubes.

I do not remember any radio show, trade or otherwise, where there was so much to interest the technical man as there is here in Earl's Court this year. The Radio Industry Council's control room suite for example, is the nerve center of all the television and radio demonstrations at the radio show. Through this control room pass all the signals for the television programs seen throughout the show, as well as the sound programs and announcements heard on the loudspeakers. This Control Room suite is divided into three parts, and has glass walls so that visitors can see all that happens within.

The Announcer's Studio, which is fitted with twin turntables, is occupied throughout the Show by attractive girl announcers, who link together the various television and sound items which are heard through hundreds of television sets in the Exhibition.

An innovation this year is that public announcements are seen as well as heard, for a television camera is installed in this Studio. Another section of the suite housed the elaborate television distribution amplifiers. This enables the output from five different sources to be fed through to all the sets in the Exhibition. The sources are the B.B.C. television programs as transmitted daily from the main transmitters, which now cover 80 per cent of the population of Great Britain; the Announcer's Studio de-

THE NEW Webcor® HF SERIES



*America's Newest
High Fidelity Diskchanger*

From the research laboratories of Webster-Chicago comes the new HF series Diskchangers—designed and engineered especially for the challenging task of gently, quietly and quickly changing records in the finest high fidelity installations.

Wherever one sees the handsomely designed Webcor HF Diskchanger, it is the symbol of both quality and luxury. No other changer made delivers the satisfaction that comes with the trouble-free operation of the master mechanical part of any HF installation.



- Webcor HF is a "push-off" type changer considered by experts to be the most gentle method of changing records.



- Webcor HF features the new Webster-Chicago Velocity Trip mechanism for fool-proof, jam-free operation with a minimum of lateral needle pressure.



- Webcor HF has one simple speed control, conveniently located. It is easily accessible in all types of installations.



- Webcor HF has an exclusive "muting switch" for silencing the amplifier during the record changing.



- Webcor HF series has the Webcor exclusive electrostatically flocked turntable which forms the thickest carpet to provide the softest cushion for record drop.



- Webcor HF series has an extra heavy mainplate made of 18 gauge steel. A bridge-like construction assures that the mainplate will never warp.

The HF series is available in five models:

Webcor 127-HF—a base pan model equipped with turnover crystal cartridge.

Webcor 127-27-HF—a base pan model equipped for use with individual plug-in magnetic or variable reluctance cartridges.

Webcor 127-270-HF—a base pan model equipped with a G.E. Triple Play variable reluctance cartridge.

Webcor 126-HF—a replacement Diskchanger equipped with turnover crystal cartridge.

Webcor 126-27-HF—a replacement Diskchanger for use with individual plug-in magnetic or variable reluctance cartridges.

© w/c 1052

All music sounds better on a

Webcor
by WEBSTER-CHICAGO



2672

New LABORATORY INSTRUMENTS for Precision Measurement at Moderate Cost

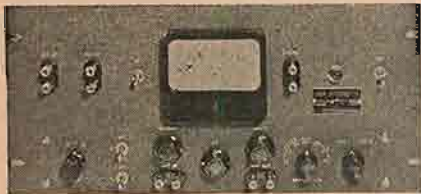

INTERMODULATION METER Professional Flexibility and Precision at Reasonable Cost

Model 165 IM Meter is especially suited for laboratories, broadcasters, recording studios. Combines signal sources, analyzer, voltmeter in single compact case. Reads amplifier output voltage, %IM directly on meter. Provides for use of oscilloscope to

determine causes of IM; full graphic instructions supplied. Wide range of test frequencies: 60 cps internal, 40-200 cps external for LF; standard 2, 7, 12 kc internal, 2-20 kc external for HF. Selectable voltage ratio of 4:1 for LF testing and 1:1 for more accurate HF testing. Less than 0.1% residual IM thru use of accurate bridge-type mixing circuits and toroidal-core filters. 8 $\frac{3}{4}$ " x 19" rack-type panel; 8 $\frac{1}{2}$ " deep. Price \$250.00. Model 165D provides for 40-400 cps external LF signal, for disc reproducer and hearing aid measurements. Price \$350.00.

More Accurate Readings with NEW BRIDGER Only 3 mmf Input Capacity

In bridging measuring instruments across high-Z circuits, minimum possible loading is vital. New Model 100B Bridger with improved cathode follower and special double-shielded cable has negligible effect. Input Z at tip of 3 ft. cable; now 70 megohms shunted by only 3 mmf. Output Z; 200 ohms. Output/input voltage ratio: 0.99. Usable to several hundred kc. Price \$96.50.



ULTRA-SPEED RECORDING with the LOGGER

direct-writing oscillograph providing convenient low-cost inked record. Chart scale is linear in db, with pen speed adjustable up to 10 to 20 times faster than usual high speed level recorders. Also available without oscillograph.

Logger shown consists of new stabilized converter, linear rectifier, VTVM, oscillograph-driving DC amplifier. System is insensitive to temperature variation; is inherently logarithmic and independent of tube characteristics. No motors, clutches, thermostats. Models 121, 122, 124 with 50 db range; 121W, 122W, 124W with 60 db range. Available for DC and RF, and with other db ranges.

MINIATURE PREAMPLIFIERS for Kellogg Condenser Microphones (below) Also available for 640AA.

Stability, linearity, and low noise level of best condenser microphones are available at moderate cost with these units. Models 12, 14, 16: for AC or battery operation; available with insert resistor for convenient calibration. For acoustical laboratory or precision recording, these miniaturized units, only 1 $\frac{1}{8}$ " o.d., offer minimum disturbance of the sound field. Prices from \$130.00.

KELLOGG MIDGET CONDENSER MICROPHONES.

Performance-proved for over 15 years. Feature spring-controlled diaphragm tension with long-term calibration stability. Reasonable cost and prompt delivery, calibrated if you wish. We are authorized dealers for these excellent microphones and will be glad to advise you. Phone or write us.



GALVANOMETER PROTECTOR

Model 170-Galvo-Protector increases speed and convenience of bridge measurement and protects galvanometer from damage through overload. Automatic non-linear network with no moving parts reduces galvanometer sensitivity when bridge is unbalanced, but affords maximum sensitivity near point of balance. Price \$24.50.

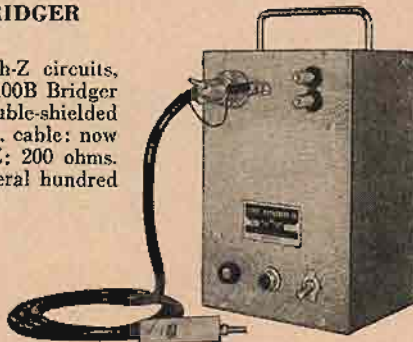

For reverberation tests, experimental phonetics, propagation studies, any fast-changing widely-varying phenomena. Logger feeds direct-writing oscillograph providing convenient low-cost inked record. Chart scale is linear in db, with pen speed adjustable up to 10 to 20 times faster than usual high speed level recorders. Also available without oscillograph.



scribed above; a section on the ground floor of the Exhibition where celebrities are interviewed; a film scanner in the Radio Industry Council Control Room, which provides film programs when no others are available, and rehearsals of transmissions from the giant B.B.C. Studio, which is situated elsewhere in the Exhibition.

This Studio, which cost nearly \$60,000 is the largest in Europe, has been specially built for the ten-day run of the Exhibition and has a thousand free seats. Items for the B.B.C. Television programs are rehearsed in this Studio during the day under the eyes of visitors, and then transmitted in the evening through the B.B.C. national network. Naturally, arrangements have been made that the rehearsals can be seen on the television sets in the Exhibition.

The layout of the Exhibition is divided roughly into four sections, namely the main booths in the center of the hall, which are most elaborately decorated, the approximate cost of most of them being in the region of \$12,000. Most of these booths would have at least a dozen television sets in operation. Many of the manufacturers occupying these booths also have elaborate sound-proof demonstration rooms and suites of Sales Offices. One whole wing of the Exhibition is occupied by separate exhibitions of the Navy, Army and Air Force, including the first display of a radio-guided missile, and two demonstrations of underwater television including one in which divers are seen descending and ascending to and from a wreck. Other electronic novelties include radio controlled model ships in a giant tank; an electronic "Doorman" who greeted foreign visitors in any one of 16 languages and gave particulars of what was on in the show each day, and a practical demonstration of how the British General Post Office, with a mobile truck, detect British viewers who have not paid their license fees.

The trend of development in England is affected to a considerable extent by the purchase tax which is 66 $\frac{2}{3}$ per cent of the wholesale price of all radio, phonograph, and domestic electrical equipment other than amplifiers. Nevertheless there was shown an extremely wide range of television receivers. One characteristic of the British range of sets is the number of projection models which were on show at Earl's Court. This included one television set giving a picture 4 x 3-ft. and the whole apparatus being housed in one cabinet, the picture being transmitted from the rear. There were several equipments giving pictures of similar size involving front projection.

Binaural Demonstration

The demonstration of greatest interest to the high-fidelity enthusiasts was one staged by the British General Electric Company, to demonstrate the high fidelity obtained by their KT66 valves. It was an impressive "Binaural" Sound demonstration. Sitting in a comfortable seat in the large room, I heard two people play a duet on a single tambourine. I could hear the tambourine being thrown from one side of the room to the other. A dance band played some of the latest tunes, and I could clearly detect that the violins were on the right and the drums on the left. A piper marched up and down from one side of the room to the other. It was impossible to determine that the reproduction was undertaken by mechanical means. In fact, the whole program had been recorded by using two input channels on dual-track tape, which was then reproduced

Audio INSTRUMENT COMPANY INC.
Dept. 7, 133 WEST 14th STREET, N. Y. 11, N. Y.

Write now for Catalog A.

See us at the Audio Fair.

[Continued on page 81]

to the **E. E. or PHYSICS GRADUATE**

with experience in

RADAR OR ELECTRONICS

*Hughes Research and Development Laboratories,
one of the nation's large electronics organizations, is now
creating a number of new openings
in an important phase of its operation.*



Here is what one of these positions offers you:

1. THE COMPANY

Hughes Research and Development Laboratories is located in Southern California. We are presently engaged in the development of advanced radar devices, electronic computers and guided missiles.

2. THE NEW OPENINGS

The positions are for men who will serve as technical advisors to the companies and government agencies purchasing Hughes equipment. Your specific job would be to help insure the successful operation of our equipment in the field.

3. THE TRAINING

Upon joining our organization,

you will work in our Laboratories for several months until you are thoroughly familiar with the equipment you will later help the Services to understand and properly employ.

4. WHERE YOU WORK

After your period of training (at full pay), you may (1) remain with the company Laboratories in Southern California in an instructional or administrative capacity, (2) become the Hughes representative at a company where our equipment is being installed, or (3) be the Hughes representative at a military base in this country—

or overseas (single men only). Compensation is made for traveling and for moving household effects, and married men keep their families with them at all times.

5. YOUR FUTURE

You will gain all-around experience that will increase your value to the company as it further expands in the field of electronics. The next few years are certain to see a large-scale commercial employment of electronic systems—and your training in the most advanced electronic techniques now will qualify you for even more important positions then.

HOW TO APPLY

If you are under thirty-five years of age, and if you have an E. E. or Physics degree, with some experience in radar or electronics,

write to:

HUGHES

RESEARCH AND DEVELOPMENT LABORATORIES

Engineering Personnel Department

CULVER CITY, LOS ANGELES COUNTY, CALIFORNIA

*Assurance is required
that relocation of the applicant will not cause
disruption of an urgent military project.*

introducing a

new era

in field recording

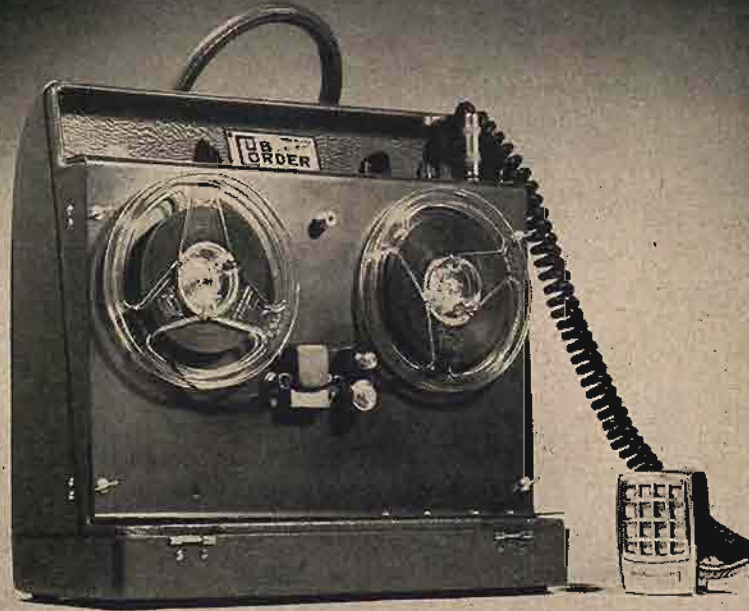

the

**CUB
CORDER**

Field recording till now has posed a real problem for the engineer. He has either been saddled with cumbersome equipment that required power lines involving hours of installation time or has been provided with a so-called "portable" tape machine, either spring or battery driven, with wide speed variation, considerable distortion and short life power supply.

But, the new CUB CORDER brings a new era to field recording. With its light weight (only 12 $\frac{7}{8}$ pounds), compact size (smaller than a portable typewriter case), exceptional speed accuracy and rugged dependability, it becomes the most useful of all portable tape machines.

Take the CUB CORDER anywhere . . . to the local airport to interview a V. I. P. . . . to a disaster scene to interview witnesses . . . to the stadium to record the color of a football game. Wherever you take it, the CUB CORDER is ready for *instant use*.

The CUB CORDER is an indispensable piece of equipment for every broadcast station, newspaper, recording company and school and has a multitude of uses in almost every industry.

Write today for the new booklet describing the CUB CORDER . . . *America's handiest, most useful, truly portable tape recorder.*

What other portable recorder has these features?

- Self-contained power supply from rechargeable wet batteries.
- Batteries easily charged from automobile cigarette lighter outlet.
- Precision, constant speed motor.
- Two standard tape speeds.
- Frequency response to 6,000 cps.
- Light in weight—12 $\frac{7}{8}$ pounds.
- Smartly styled, leather-grained case with shoulder strap.
- Instant operation—easy maintenance.

ELECTRO, INC. DELAWARE 1, OHIO

FORMERLY CIRO CAMERAS, INCORPORATED

Book Review

Television Engineering, by Donald G. Fink. New York: McGraw-Hill Book Co., Inc., 1952. xiv + 720 pp., \$8.50.

Although this book is presented as the second edition of the well-known classic "Principles of Television Engineering," it is practically an entirely new volume. Over 90 per cent of the text is new, as is some 85 per cent of the illustrations. The only resemblance the present book bears to the original is the excellence of the presentation, the coherence of its contents, and the clarity of the exposition.

The text covers the basic principles of television systems, the analysis and synthesis of television images, cameras and picture tubes, scanning and synchronization methods, the transmission and reception of television signals, and an exceptionally excellent presentation of color fundamentals for television engineers and a description and analysis of the various color television systems that have been proposed.

Each chapter of the book is supplemented by a very complete and lengthy bibliography covering both other books and the contemporary literature. In addition, a series of exercises are appended to each chapter. Finally, an author and a subject index both extensive, are included.

Television has grown to the extent that it is no longer possible to present within the confines of one volume a complete dissertation covering all facets of the science. This book, however, presents in the clear style that is characteristic of all the author's writings the fundamentals of both monochrome and color television. It is a book that should be in the library of every engineer and student concerned with television.

—H. A. Chinn

Television Explained, by W. E. Miller. London, England: Iliffe & Sons, 1951. 104+xxiv pages. 5 shillings.

Television Principles, by Robert B. Dome. New York: McGraw-Hill Book Co., Inc., 1951. 291+xii pages. \$5.50.

Together, these two books present a most interesting coverage of the television technique as it exists today. As its title would rightfully suggest, *Television Explained* is the simple story of what happens in a television receiver, and it is as applicable to us in America as it is in its native habitat, with the exception of the change in line and frame frequency, and of course the reference to the BBC test card, which is carefully analyzed to show the faults it will expose in a receiver not correctly adjusted.

On the other side of the picture, Mr. Dome enters deeply into the higher mathematics of design of circuit parameters and the needs imposed on them by the wide pass band they must accept. This is a book for the man who is as facile with mathematics as with eating, and should not be attempted by one seeking rudimentary data. But in its scope it is well worthy of a position on the engineering bookshelf of the designer of TV sets both for today and for some while in the future.

Chapter endings contain review questions and answers, and there is a generous inclusion of tables of reference data, curves and charts. These clarify the points of the text which cover the history of the art right up to the state of development, at the time of printing.

—LBK

Coming Up- Perfect Precision Prints

PREPARATION

Here your film receives its first, careful inspection. Experienced workers examine it for defects, check over splices, perforations, synchronism of sound track general condition. Your printing instructions are carefully correlated to the film itself.

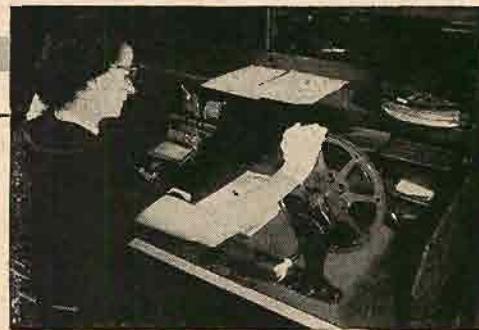

YOUR ASSURANCE OF BETTER 16mm PRINTS

15 Years Research and Specialization in every phase of 16mm processing, visual and aural. So organized and equipped that all Precision jobs are of the highest quality.

Individual Attention is given each film, each reel, each scene, each frame — through every phase of the complex business of processing — assuring you of the very best results.

Our Advanced Methods and our constant checking and adoption of up-to-the-minute techniques, plus new engineering principles and special machinery

enable us to offer service unequalled anywhere!

Newest Facilities in the 16mm field are available to customers of Precision, including the most modern applications of electronics, chemistry, physics, optics, sensitometry and densitometry—including exclusive Maurer-designed equipment—your guarantee that only the best is yours at Precision!

Precision Film Laboratories — a division of J. A. Maurer, Inc., has 14 years of specialization in the 16mm field, consistently meets the latest demands for higher quality and speed.

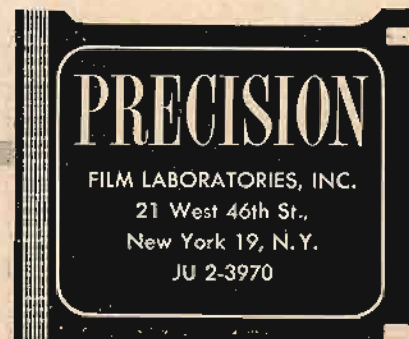

EDITOR'S REPORT

THE AUDIO FAIR

COMES OCTOBER, and along with the falling leaves comes The Audio Fair—each year bigger and better than it was before. Bigger this year in that it lasts for four days instead of the three in the past years; and better in that there are more exhibitors with more products to show. There is no question that the public is becoming more quality-conscious with respect to its musical reproduction—as well it might after many years of accepting what is offered by the set manufacturers.

Some of this we may attribute to TV, for while the newest art is certainly popular, there are still many who are not amused by combined sight-and-sound entertainment. Notice, for example, how many more hours of valuable evening listening time have been devoted to concerts of both light and classical music on the radio networks.

Thus with more good music on the air, there is more reason than ever before to investigate the new items in the audio world—and plenty of opportunity during the four days of the Fourth Audio Fair—October 29, 30, 31, and November 1. The Place?—Hotel New Yorker, in New York City. Details of exhibit hours will be found on page 83.

Along with the Audio Fair will be held the Fourth Annual Convention of the Audio Engineering Society—same place, same days. An impressive program of technical papers has been arranged, and for a list of these papers, turn to page 58.

REGIONAL AUDIO SHOWS

While the Audio Fair—as above—will undoubtedly remain the principal focus of interest from the standpoint of exhibits, not everyone is privileged to attend—for any number of reasons. But this does not lessen the desire to visit a showing of audio equipment—and to hear it—regardless of the fact that the trip to New York may not be feasible. The solution—as already put into operation in a number of centers—is the regional show. One very successful one was held recently in Memphis under the auspices of a local distributor, and another is being held in Philadelphia under the combined banners of three distributors.

This event—the Second Annual High Fidelity Conference and Audio Show—will be held in the Crystal Rooms of the Broadwood Hotel in the City of Brotherly Love on October 8 and 9. The first annual etc. etc. held last year was completely successful, and points the way to more such regional shows throughout the country. We salute those with sufficient faith in the future of audio to make the effort to acquaint the public with what the industry offers. Every step in this direction is a step forward.

MEN BEHIND MIKES

We note a recent issue of *Newsweek* (September 8) in which the work of the men responsible for modern phonograph records is finally recognized, the occasion being the 75th anniversary of the first announcement of

the phonograph. Like most inventions of a complicated nature, the phonograph has come a long way in its three quarters of a century. The modern home sound installation bears but little resemblance to the earliest sound-reproduction apparatus—either physically or in the quality of its sound output. Originally conceived as a business machine, the phonograph plied that market for many years before it made its way into the living room. And while it is now firmly established in the living room—also nursery, soda parlor, tavern, and even the broadcasting station—it is still a force in the business world. Many of us in audio for entertainment applications are completely unfamiliar with the advances in related fields.

Audio is not limited in scope. Audio techniques are employed in many fields. Much of the glamour is related to music and broadcasting and other aspects of entertainment, but we must not lose sight of telephones, business machines, medical applications, military uses, hearing aids, acoustics, and the other fields in which audio is important.

All of us like recognition for our work, particularly when it is completely unfamiliar to most people. And on behalf of the recording technicians who turn out the constantly improving platters, we thank *Newsweek* for considering that branch of our industry worth the space required to present this feature story.

HOME CONSTRUCTION

We had never before particularly regretted our inability to read Japanese, since there is still much in more familiar languages which we have yet to read. Not, that is, until we received the current issue of *The Radio Craft Monthly*, which shows in detail how to construct a capacitance-type phonograph pickup. Whether we could build one or not from the pictures alone is not known, but it seemed like an interesting project.

This particular magazine devotes a lot of space to construction articles—reminiscent of the radio magazines in this country in the 20's and early 30's. One *Æ* reader from "down under" gave us to understand recently that experimenters and hobbyists in his country wouldn't buy anything that they could build—as a matter of pride, so it seems. Having gone through those stages many times, we know just how he feels. As a matter of fact, we always have more things planned for the future than we ever expect to get around to building, but it is refreshing to plan—at least, life is never dull.

Somebody of course, hand-built the first phonograph pickup, the first transformer, the first loudspeaker. Maybe it would be interesting to go back to those days occasionally, although it is probable that the manufactured product is far superior to those we might turn out in the home workshop. But let us not lose sight of the fact that the entire hi-fi industry stems from the desire of many early experimenters to have something better than was available commercially. The manufacturers have pretty well caught up with the experimenter—if not passed him in most lines. But there's still plenty of room for both the man who builds his equipment and the man who buys it ready made—and both will continue to get pleasure out of the final result.

PICKERING

RECORD PLAYING EQUIPMENT

*For flawless reproduction
of the works of the masters*

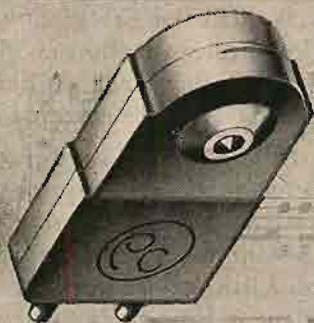

Pickering diamond stylus pickups and related components are the exclusive choice of musicians and lovers of music who insist upon the finest. Engineers acknowledge Pickering audio components as the best available. In every test and performance comparison, they demonstrate their superiority; recreating all the music pressed into modern recordings with the fidelity and realism of a live performance.



Pickering components are created for listening pleasure by Audio Engineers who know music and who know the tastes of discriminating listeners.



Pickering diamond cartridges have no equal. The wear and fracture resistance of the diamond styli in these cartridges is many times greater than that of styli made of sapphire, the next hardest material. Because resistance to wear preserves the precise shape of the stylus point, the life and quality of your valuable record collection is insured.



Don't impair the musical quality of your priceless records.

Use Pickering diamond stylus cartridges . . . they not only wear longer *but, more important*, they preserve the musical quality and prolong the life of your record library.

By all measures, Pickering diamond stylus cartridges are more economical.



PICKERING & COMPANY, Inc.
Oceanside, L. I., N. Y.



Pickering High Fidelity Components are available through leading jobbers and distributors everywhere; detailed literature sent upon request. Address Department A

Same wires— many more voices

Connecting new multi-voice system to open-wire lines, near Albany, Georgia. With new system, 150,000 miles of short open-wire telephone lines can be made to carry up to 16 simultaneous messages economically.

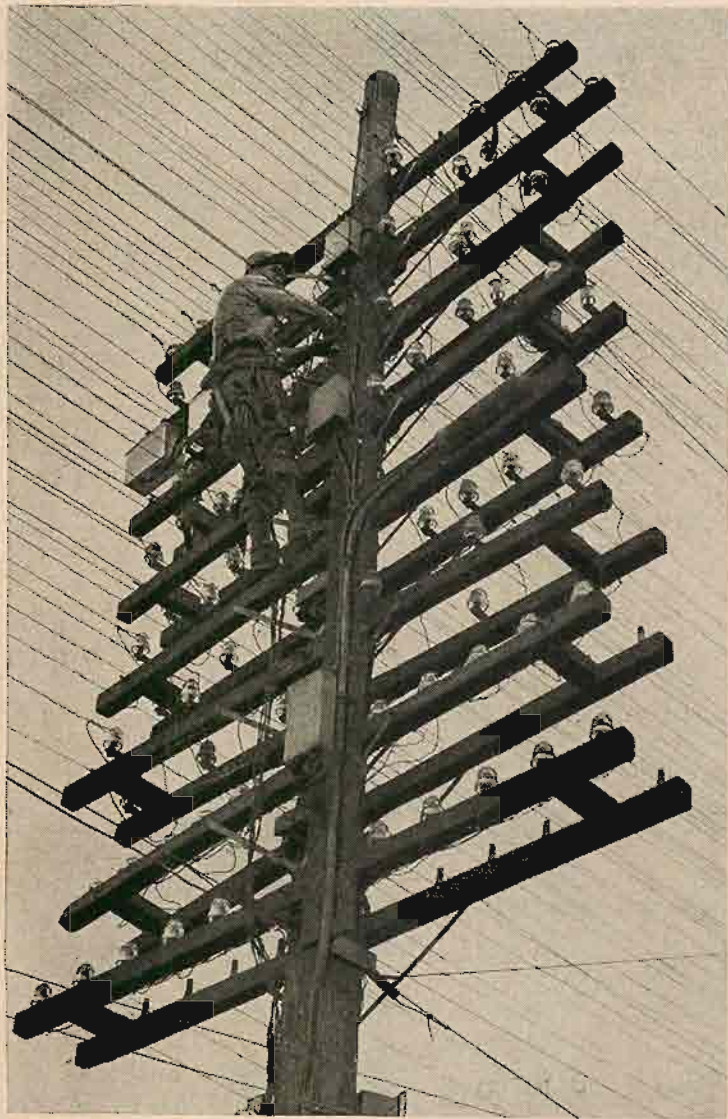

MUCH of your Long Distance telephone system works through cable but open-wire lines are still the most economical in many places. Thousands of these circuits are so short that little would be saved by using elaborate carrier telephone systems which are better suited for long-haul routes. But a new carrier system . . . the Type O designed especially for short hauls . . . is changing the picture. It is economical on lines as short as 15 miles. With Type O thousands of lines will carry as many as 16 conversations apiece.

Type O is a happy combination of many elements, some new, some used in new ways. As a result, terminal equipment takes up one-eighth as much space as before. Little service work is required on location; entire apparatus units can be removed and replaced as easily as vacuum tubes.

Moreover, the new carrier system saves copper by multiplying the usefulness of existing lines. For telephone users it means more service . . . while the cost stays low.

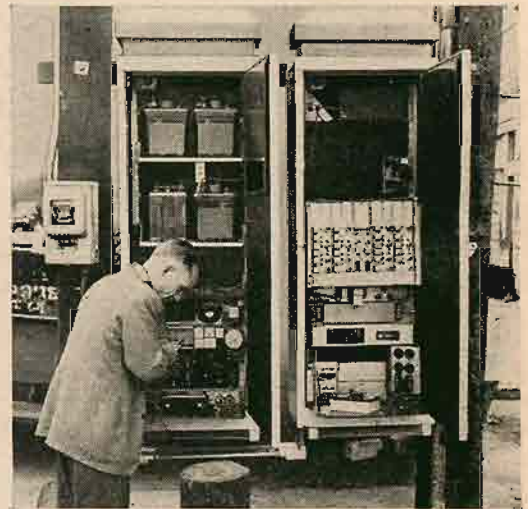

Repeater equipment is mounted at base of pole in cabinet at right, in easy-to-service position. Left-hand cabinet houses emergency power supply. System employs twin-channel technique, transmitting two channels on a single carrier by using upper and lower sidebands. A single oscillator serves two channels.

BELL TELEPHONE LABORATORIES

Improving telephone service for America provides careers for creative men in scientific and technical fields



Intermodulation Distortion

RICHARD C. HITCHCOCK*

A brief and frank discussion of this form of distortion, and the description of some simple devices which will enable the experimenter to make his own measurements with a minimum of equipment expense.

ONE WAY TO TEST an audio amplifier is to play records at full volume, and listen for "muddy" or "harsh" tones in the upper register. These happen when a high-frequency tone is affected by a low-frequency tone.

Testing the amplifier by listening is the final authority, of course. But it would be desirable if tests could be made to find out how much distortion the amplifier introduces. Even the best amplifier has some distortion. The only questions are, how much, and what kind?

As a start, let's consider three notes on an 88-note piano. The highest note, No. 88, is C. Note No. 87, next lower¹, is B. If you should strike these adjacent notes at the same time, you probably

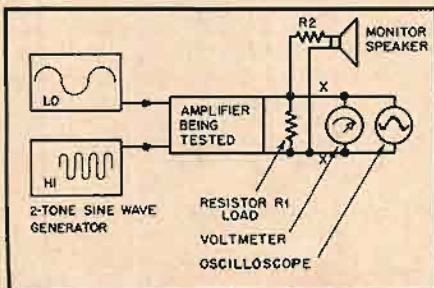

Fig. 1. Basic circuitry used in preliminary set-up.

would call the result a "discord." You would hardly think an amplifier was very good if, when called on to reproduce the note C of the piano, it also gave the adjacent B, a few hundred cps lower. Yet this is what a poor amplifier does do—and here we arrive at an important fact. The amplifier adds the extra note, the B, only when a certain low-frequency tone A is played at the same time.

To go over this again, a poor amplifier, called on to reproduce Numbers 38 and 88 on a piano, gives 38 (A#), 88 (C), plus the extra and unwanted notes 87 (B), and an even higher one which we may call No. 89 (C#) a half tone higher than is on the piano. The reason for this is the low-frequency note, No. 38 on the piano, the note² A#. This is one kind of intermodulation distortion.

* Buhl Planetarium, Pittsburgh 12, Pa.

¹ For A=440, the vibrations per second for Numbers 88 and 87 are 4143 and 3910 respectively. Their difference is 233 vibrations per second.

² For International Pitch, A# is 238 vibrations per second.

Fig. 3. Transmission curves for high- and low-pass filters used in the author's measurements.

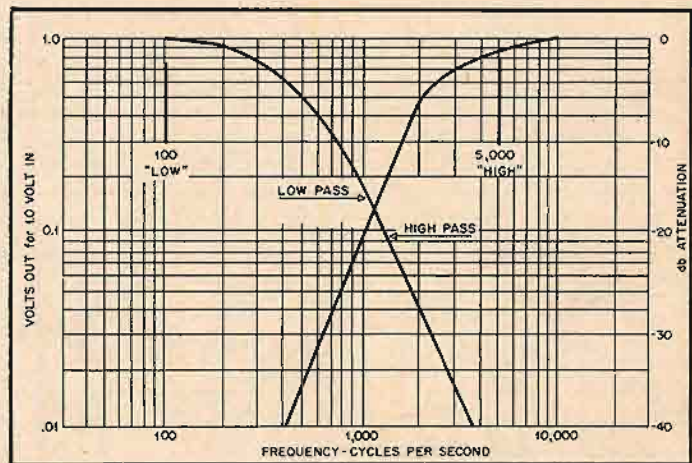

Most music on records includes more than one tone at a time. The interacting of these tones cause more or less intermodulation distortion. For measurement, it is much simpler to consider only two pure tones, one high and one low. Working with these will give us some idea of amplifier distortion.

Incidentally, there is no accepted standard of a "high" or of a "low" tone. One company publishes data³ on its amplifier tested at 60/7,000 and 40/12,000 cycles per second, with a low-to-high-note ratio of 4:1. Another⁴ shows 40/2,000; 40/7,000; and 40/12,000 all with 4:1 ratios. An excellent article⁵

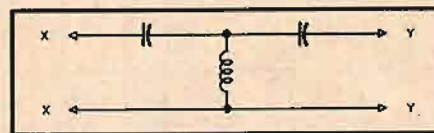

Fig. 2. High-pass filter configuration.

from which many valuable ideas were taken for the tests indicated here, recommends 40/4,000 cycles with 4:1 low-to-high ratio. A recent paper⁶ suggests 60/4,000 with any of three ratios; 4:1; 1:1; or 1:4. A test record⁷ (33

³ Transformers in Williamson High-Fidelity Amplifier, Form 382, Standard Transformer Corp.

⁴ Ultra-Linear Williamson Amplifier, Acro Products Co.

⁵ Thomas Roddam, "Intermodulation distortion," *Wireless World*, April 1950.

⁶ Pierce J. Aubry, "Intermodulation testing," *AUDIO ENGINEERING*, Dec. 1951.

⁷ Cook Series 10 Test Record.

r.p.m.) is available, using 100/7,000 cycles per second 4:1 ratio. It might be mentioned, in passing, that a record introduces another variable in an already complicated situation, and that the test of the amplifier alone is the best step to take first. Further, a test record wears, whereas an oscillator will work for a much longer time.

Preliminary Procedure

With the equipment of Fig. 1, play a high-frequency sine wave and notice that the amplifier output is a good sine wave, too. Set the timing rate of the 'scope so that it gives a full wave (or more) of the low tone, and with the high tone still playing, add the low-frequency tone. The picture on the 'scope will be pretty, but difficult to analyze. So next we open the circuit at XX and insert a high-pass filter, Fig. 2. This will allow only the high frequency to pass to the oscilloscope, in accordance with the transmission of the filter, shown in Fig. 3, and we can see what happens to the high note when the low note (blocked by the filter) is varied in volume. If you are doing this for the first time, you will be astounded to see how ragged the formerly smooth high note becomes.

Through the high-pass filter will go the notes 87, 88, and 89 of our example but No. 38, the one which causes these extra 87 and 89 notes, will not get through. We can now see the effect of the low tone on the high one, but still we want to measure this effect, this distortion.

Now add a rectifier and low-pass filter, Fig. 4. The rectifier cuts off half the waves and the low-pass filter takes

A Critical Feedback Analysis

HAROLD KLIMPEL*

The author presents a simple and easily understandable concept of the effect of feedback on input and output impedances of tubes around which a feedback path is provided.

ONE OF THE EARLIEST applications of positive feedback occurred when regenerative detectors made possible the reception of weak signals with only one- or two-tube sets. Even today, some receivers still use regenerative intermediate frequency stages to obtain greater pulling power.

The use of negative feedback began in the earliest days of the vacuum tube when neutralization was employed to stabilize radio frequency amplifiers in both receivers and transmitters. The development of multigrid tubes eliminates the necessity of neutralization, although all triode transmitter stages today still

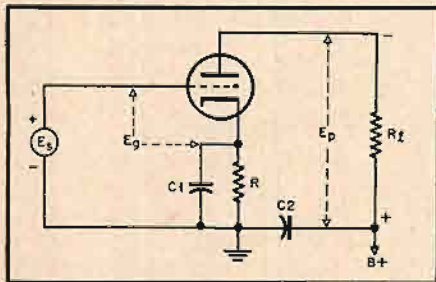

Fig. 1. Basic amplifier circuit without feedback.

incorporate one of several methods of neutralization—circuits in which varying magnitudes of out-of-phase plate voltages are coupled back to grid circuits to obtain cancellation of grid-plate interaction. The entire field of electronics today demands greater stage stability, wider band response, and lower noise and distortion levels. Along with other precautions, all of these requirements can be approximated by the judicious application of negative feedback.

A sizeable amount of literature has appeared during the last few years on the impedance changes that take place in an amplifier with feedback, notably that associated with the cathode-follower. A study of this material discloses a marked divergence of opinion among several members of the profession on various principles that underlie the operation of a feedback amplifier, among which are the following:

1. The manner in which gain reduction takes place.
2. Impedance changes, if any, of tubes within a feedback loop.
3. An exact mathematical procedure for determining the improvement attributed to feedback.

It is the intent of this paper to outline the effects of energy interchange between amplifier grid and plate circuits.

The points wherein this analysis differs from that published in some papers of the past are as follows:

1. The mathematical sign of β is never negative.
2. Feedback affects only the input, not the output impedance.
3. Feedback, either negative or positive, does not affect the plate resistance of any tubes in a feedback loop.

To review briefly an amplifier without feedback, Fig. 1 is a circuit of a 6J5 triode which has a plate resistance of 7,700 ohms and a μ of 20. The gain of any stage is expressed by the familiar

$$A = \frac{\mu R_l}{R_p + R_l} \quad (1)$$

where μ = amplification factor of the tube
 R_p = plate resistance of the tube
 R_l = plate circuit load

If the plate load for the 6J5 is made equal to the plate resistance, the gain from Eq. (1) will be

$$A = \frac{-20(7,700)}{7,700 + 7,700} \quad (2)$$

$$= \frac{-154,000}{15,400}$$

$$= -10.0, \text{ equivalent to } 20.0 \text{ decibels.}$$

In any plate-loaded amplifier calculations, the phase turnover must be accounted for; the amplifier gain A must appear in all work with a negative sign since the output is 180 deg. out of phase with the input. For all audio and r.f. applications where the electron transit time does not enter into calculations, the μ may be written as $\mu/180^\circ$. In Eq. (2), the μ is understood to be $20/180^\circ$, or simply $-20 + j0$. A plate current change through R_l will produce an output voltage

$$E_p = AE_g \quad (3)$$

where E_g = the grid-to-cathode input voltage.

Referring to Fig. 1, the grid circuit terminology includes E_s and E_g , denoting source and sink voltages respectively.

Figure 3 shows the 7,700-ohm load line that the 6J5 of Fig. 1 is working under; a plate supply of 275 volts will drive a 6.0-ma current through the load and also produce a bias of 8.0 volts across a 1333-ohm bias resistor. A 5.0-volt signal E_s will produce a 5.0-volt drop, E_g , across the input resistance R_g of the tube so the output voltage from Eq. (3) will be

$$\frac{E_p = -10(5.0)}{= -50.0 \text{ volts.}} \quad (4)$$

Introducing Feedback

To make the amplifier of Fig. 1 degenerative, the load resistor is divided into two parts. R_o and R_c , the grid return being made to the junction of these two resistors, thereby making the voltage E_c , common to both grid and plate circuits. The amount of feedback in this stage will be governed by the amplitude of the feedback voltage E_o which, in turn, is determined by the ratio R_c/R_l also known as β , since β itself can be defined as the percentage of the total output voltage that is fed back for feedback purposes. Mathematically this is

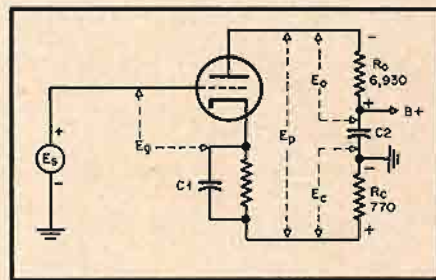

Fig. 2. Rearrangement of circuit elements to provide feedback and to clarify operation of circuit.

$$K = \frac{R_c}{R_l} = \frac{E_c}{E_p} = \frac{E_o}{AE_g} \quad (5)$$

from which the resistors R_o and R_c are computed as

$$R_c = KR_l \quad (6)$$

and

$$R_o = R_l - R_c \quad (7)$$

The values of β can be chosen between the limits of unity and zero since it is always an expression of percentage. In view of this fact, the sign of β is never negative since none of the quantities in Eqs. (5), (6), or (7) are negative in sign. A degenerative amplifier has its feedback voltage arranged to oppose the input signal, whereas, a regenerative amplifier allows the feedback voltage to assist the signal by being in phase with it.

To make an analysis of the Fig. 2 amplifier, let

$$K = 0.10, \text{ (10 per cent of output voltage fed back)} \quad (8)$$

To assist in comparison, calculations with feedback will retain the same 7,700-ohm total plate load to keep $A = -10.0$. The bias resistor from Eq. (6) will be

$$\frac{R_c = 0.10(7,700)}{= 770 \text{ ohms}} \quad (9)$$

from which by Eq. (7)

* 803 Broadacres, Compton, Calif.

61.4-ohm load, which is the parallel combination of 500 and 70 ohms. The amplifier gain A with this load from Eq. (1) will be

$$A = \frac{-20(61.4)}{7,700 + 61.4} \quad (20)$$

$$= -0.1582$$

This tube, even if it were plate-loaded, would be an attenuation amplifier since its load is so small that it operates at less than unity gain. An equation for output voltage can be obtained by rearranging several previously developed equations for the voltage E_o when all the load is made up of the bias resistor. Using Eq. (5) with substitutions from Eqs. (7) and (12), we have

$$E_o = \frac{AE_g(1-K)(1-AK)}{A(1-K)} \quad (21)$$

$$= E_g(1-AK) \text{ or } E_g = \frac{E_o}{(1-AK)}$$

which substituted in Eq. (5) for E_g

$$E_o = \frac{KA E_s}{(1-AK)} \quad (22)$$

This is an accurate statement of the voltage developed across an unbypassed bias resistor in a cathode-follower stage when the input E_s , the gain A , and the β factor are all known.

From Fig. 3, a grid drive of approximately 2.5 volts is indicated since anything greater will drive the tube into nonlinear operation. A 2.5-volt drive will swing the plate current between 2.5 and 15 milliamperes. The output E_o will be

$$E_o = \frac{(1.0)(-0.1582)(2.5)}{[1.00 - (-0.1582)(1.0)]} \quad (23)$$

$$= \frac{-0.39550}{1.1582}$$

$$= -0.34148 \text{ volts.}$$

This voltage is in series opposition to the signal E_o , so the actual voltage E_g will be $2.50000 - 0.34148$ or 2.15852 volts. To check the accuracy of the previous equations, the voltage E_g times the gain A should produce the output voltage E_o . Carrying this out to seven places, the answer is -0.3414778 volts.

The ability of a cathode-follower to counteract changes in the load it faces can be demonstrated by assuming the previous 70-ohm load changed to 700 ohms which is equal to a 20-db change. The new gain A from Eq. (1)

$$A = \frac{-20(291.6)}{7700 + 291.6} \quad (24)$$

$$= \frac{-5832}{7991.6}$$

$$A = -0.7297$$

where the parallel combination of the 500-ohm load resistor and the 700-ohm line is equal to 291.6 ohms.

Assuming the same 2.5-volt input signal, the output by Eq. (22) will be

$$E_o = \frac{-0.7297(1.00)(2.5)}{[1.00 - (-0.7297)(1.0)]} \quad (25)$$

$$= \frac{-1.82425}{1.7297}$$

$$= -1.0546 \text{ volts.}$$

This amounts to an increase of 3.09 times that of the 70-ohm load, equivalent to 9.90 db. The 20-db change in line impedance is not all reflected to the tube since it is in parallel with R_o . Actually, the tube looks into a variation of only 13.56 db. The amount of feedback under any feedback conditions is equal to $(1-AK)$, the change in gain that occurs in the grid circuit. For negative feedback, the gain is always negative; positive feedback, or regeneration, permits a higher voltage to reach the grid than that which is fed in. This same factor, $(1-AK)$, is also the amount by which noise and distortion are attenuated in a negative feedback amplifier. Under the 700-ohm load, the grid-cathode voltage E_g will be $E_s + E_o = 2.5000 - 1.0546 = 1.4454$ volts. The feedback will be

$$20 \log \frac{E_s}{E_g} = 20 \log \left(\frac{2.5000}{1.4450} \right)$$

$$= 20(0.239) = 4.78 \text{ db.} \quad (26)$$

The amount of feedback at the 70-ohm load will 1.28 db, nearly one-fourth that with the 700-ohm load. Larger amounts of feedback result by using beam pentodes such as the 6AG7 and 6AH6 will give a gain of four. With driving signals of 3.0 volts, the output E_o at video line impedances of 70 ohms will be approximately 2.4 volts. Between 10 and 12 db of feedback are the advantages gained by using higher conductance pentodes.

The use of voltage feedback in an amplifier, diagrammed in Fig. 4, is accomplished by bridging two resistors,

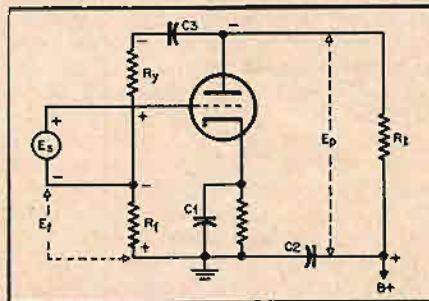

Fig. 4. Method of introducing voltage feedback in series with source of signal.

R_b and R_f , across the normal plate load R_L . There are several other variations possible when using voltage feedback—using R_b and R_f themselves as a load, or the simple expedient shown in Fig. 5.

In Fig. 4, resistors are proportioned so

$$K = \frac{R_f}{R_f + R_b} \quad (27)$$

Assuming the total plate load is still 7,700 ohms, the gain A will also be -10.0 . Assuming R_b and R_f in series at 50,000 ohms, R_f will have to be increased to 9,102 ohms so the combination will equal 7,700 ohms. The β factor, K , will then be 0.10 if R_b is 45,000 and R_f is 5,000. There is no division of the plate-circuit output voltage E_p as was the case with Fig. 2; there is no $(1-K)$ factor. The output E_p will be -50.0 volts if the grid E_g receives 5.0 volts. The input must, however, be 10.0 volts to overcome the

-5.0 volts of feedback across R_f . The over-all gain of this stage is

$$20 \log \left(\frac{50.0}{10.0} \right) = 13.9794 \text{ db.} \quad (28)$$

This is a difference of 0.9151 db over Fig. 2, accounting for the $(1-K)$ plate-circuit factor.

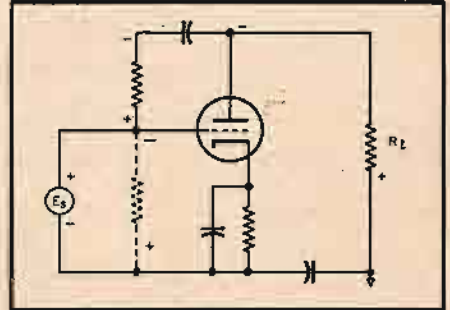

Fig. 5. Rearrangement of Fig. 4 to show introduction of feedback in parallel with source.

Reduction of Noise and Distortion

The remainder of this paper will be devoted to an explanation of how both current and voltage feedback reduce noise and distortion. Figure 6 shows two feedback paths around the 6J5 tube using $E_g = 5.0$ volts. $R_f = 7,700$ ohms and $E_p = -50.0$ volts. The grid circuit equation will be

$$E_s + E_g + E_f + E_c = 0.00 \quad (29)$$

Identifying K_1 with the current-feedback circuit and K_2 with plate-voltage feedback, the following are true statements:

$$E_c = K_1 E_p \quad (30)$$

and

$$E_f = K_2 E_p \quad (31)$$

Assuming $K_1 = 0.100$ and $K_2 = 0.200$, the above equation with substitutions are:

$$E_c = (0.100)(-50.0) \quad (32)$$

$$= -5.00 \text{ volts}$$

and

$$E_f = (0.200)(-50.0) \quad (33)$$

$$= -10.0 \text{ volts.}$$

The input signal E_s by Eq. (29) with this substitution will be

$$E_s = -(-5.0) - (-10.0) - (-5.0) \quad (34)$$

$$= 20.0 \text{ volts.}$$

Since there are -15.0 volts of feedback potential opposing E_s , the input must

[Continued on page 66]

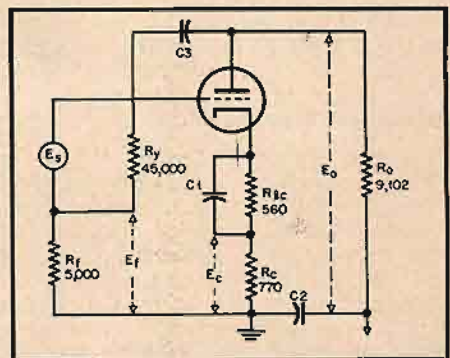

Fig. 6. Typical circuit involving voltage feedback in series with source and current feedback due to unbypassed cathode resistor.

Stereophonic Reproduction

JAMES MOIR*

A basic discussion of the reasons behind our ability to locate sounds simply by hearing them, together with practical requirements of stereophonic sound systems.

HERE IS LITTLE DOUBT that the best examples of current sound reproducer equipment meet most of the known criteria for a high quality monaural system and in consequence there does not appear to be a great deal of opportunity for further improvement in subjective quality if present techniques are merely subject to greater refinement. For example an amplifier having a frequency characteristic flat to .01 db and a distortion content below .01 per cent is not subjectively better than an alternative design flat to 0.1 db (or even 1 db) and a distortion content of 0.1 per cent. In spite of this state of (pseudo) perfection no competent critic would consider that the best possible monaural reproduction of anything but a soloist could be mistaken for the real thing, and until we can deceive most of the people for most of the time there is room for improvement in techniques.

The pleasure derived from listening to a live orchestra is compounded of many factors, most which are adequately dealt with by a laboratory type of monaural reproducer system, but if we are to have a *perfect reproduction* of the original there are many marginal factors that require further attention. An orchestra generally occupies a platform 60 to 100 ft. wide and 20 to 30 ft. deep and this spatial distribution contributes to the pleasure derived from listening. There is merit in mere size. An orchestra that makes use of all the instruments all the time is flat and uninteresting and is rarely employed. Instead the listeners' interest is excited and maintained by constant change in the prominence given to the various instrumental combinations. Thus the centre of the listeners' interest moves about the stage, the remaining instruments forming a pleasant but unobtrusive background to the focal zone on which the listeners' immediate interest is concentrated.

Reduction of Source Width

A monaural reproduction is completely unsatisfying in this respect, the whole of the 100 by 30 ft. source being compressed and strangled to emerge from an 8- or 10-in. diameter hole, with the result that there is no possibility of identifying or appreciating the individual instruments or sections of the orchestra on the basis of their spatial distribution. The pleasure to be derived

from the movement of the sound source is irrevocably lost.

A similar result is obtained from a monaural reproduction of the normal movement of actors about a set or stage. Movement in depth is moderately well reproduced if the reverberation conditions are satisfactory but all movement across the stage is reproduced as movement in depth. Thus all the action appears to take place in a tunnel with a microphone at its mouth.

Current microphone techniques aim to hide this defect by such procedures as employing a microphone boom to support the microphone just out of the picture and over the head of the speaker—the standard film and TV practice.

A monaural system is at a further disadvantage in that a single microphone is unable to discriminate against room noise or reverberant sound, with the result that all recording and broadcast studios must be acoustically treated to obtain a reverberation time much below that known to be optimum if a tolerable result is to be obtained with a monaural reproducer system. Similarly, noise from the audience coughing and shuffling appear to be enormously enhanced when heard over a monaural system. A simple but remarkably satisfying demonstration of the magnitude of this effect can be obtained by anyone with normal hearing and access to a hearing aid of the normal monaural type. Conversation that is easily understood and appears to be without any noticeable background when using two ears, appears against a marked background of reverberation and other room noises requiring considerable concentration if it is to be understood when the monaural hearing aid is used. Kock has shown that the human hearing mechanism automatically discriminates against noise when it approaches the head from a direction which differs from that taken by the desired sound. This binaural discrimination in favor of the wanted sound amounts to as much as 10 to 15 db, and is entirely lost when a monaural system is used.

A further and somewhat unsuspected result of this binaural discrimination is a marked increase in the clarity of speech and an apparent decrease in intermodulation distortion when reproducing music from a large source such as an orchestra. In fact it gives to the reproduction of a large orchestra the degree of clarity characteristic of a small orchestral combination.

It is suggested that Chinn's preferred frequency range tests using reproduced program material cannot be compared with Olson's tests using live material as in the latter tests the audience were listening "binaurally." The difference in conclusions largely represents the difference between monaural and binaural reproduction.

It is apparent that at the present time few of the advantages of a stereophonic system can be expressed numerically and recourse must be made to expressing opinions until such time as we have some system of indicating the overall subjective appeal of a reproducer system. A number of organizations have worked on the problems of stereophony both in Europe and in America and have recorded their opinions on the advantages of stereophonic systems.

Thus, tests by Bell Labs indicated that a stereophonic system having an audio bandwidth (per channel) of 3750 cps was considered by an audience to have the same aesthetic appeal as a monaural system 15,000 cps wide. J. P. Maxfield of Bell Labs has stated "I would rather hear a two channel reproduction flat to 6,000 cps than a single channel system flat to 15,000 cps; it is more pleasing, more realistic, more dramatic." This is a concise indication of the writer's opinion after more than a year's work on the subject, with the opportunity of hearing the systems developed by three of the leading European concerns.

Explanation of Stereophony

Without further discussion of the virtues of a stereophonic system, the mechanism of the stereophonic effect will be discussed as this is probably the best approach to an understanding of the technical requirements of a stereophonic system.

Mother Nature has provided us with two ears and these enable us to sample the sound field at two points spaced apart by the width of the head. From the differences that exist at the two ears and with the benefit of long experience, the ear - nervous system - brain combination can estimate the position of a sound source with remarkable accuracy, giving the same three-dimensional significance to the acoustic environment as the possession of two eyes gives to the visual environment.

For any sound source not in the median plane the sound at the left ear will differ from the sound at the right

* 87, Catesby Road, Rugby, England.

ear in three major respects.

1. Referring to *Fig. 1* it will be seen that a sound from a source on the right side will strike the right ear before the left ear, the time difference being a maximum when the source is on one side and in line with the two ears. In this position the time difference is .00063 sec corresponding to an ear separation of 21 cm.

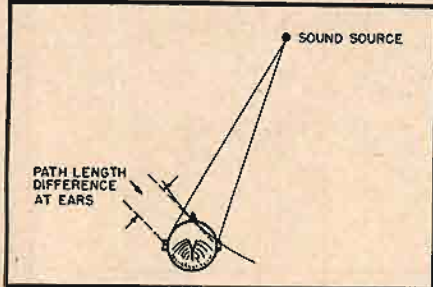

Fig. 1. Difference in path length and time of arrival when sound source is not in median plane.

2. There will be an intensity difference at the two ears, this difference being a function of the frequency of the sound. The intensity difference is frequency dependent as it is mainly the result of diffraction round the head.

3. Most everyday noises have a complex frequency spectrum and as the diffraction losses are a function of frequency the frequency spectrum at the two ears will also differ.

These differences justify further discussion. The reason for the difference in time of arrival at the two ears is evident and requires no further explanation, but the question immediately arises as to which part of the sound-wave cycle is accepted by the ear as determining the time of arrival at that ear. On an impulsive sound having a steep wave front it may be assumed that the arrival of the wave front is recognized, but on a repetitive waveform there is difficulty in understanding just how the ear recognizes the difference between successive cycles with identical waveform. A high-frequency wave passing from right to left will have several cycles pass the right ear before the first cycle reaches the left ear, and the right ear may not know just how many cycles have passed at the instant the first cycle reaches the left ear. This rather suggests that there may be difficulty in fixing the position of a high-frequency source having a frequency such that more than half to one cycle of the wave can be accommodated in the space between the ears. Taking the velocity of sound as 33,000 cm/sec and the ear spacing as 21 cm, it might be expected that frequencies above 800 cps (half wave=21 cm) might present difficulties in location and it is worth noting that this is found to be the case in practice.

Using a very elegant test technique, Galambos has taken simultaneous photographs of the sound waveform and the nerve response that results from the sound, and these show that the nerve discharge always occurs at the first positive peak. This suggests that the brain

has adopted the first positive peak as a reference point and that in measuring time intervals to fix the position of a sound source in space, it notes that interval between the first positive peak arriving at the left and right ears. This process must be repeated at fairly frequent intervals if a moving source is to be followed and it is suggested that the intervals between syllables might well form the convenient gaps from which to commence each new measurement of "time of arrival" difference.

The loudness difference at the two ears is mainly due to the presence of the head between the ears. Any obstacle placed in a sound field distorts that field, producing an increase of pressure on the side facing the oncoming sound wave and a decrease in pressure on the reverse side—a process known as diffraction. The pressure difference between the two sides is a function of the ratio of obstacle diameter to wavelength of incident sound, and for a given size of obstacle will increase as the frequency of the incident sound rises (i.e., wavelength falls). An exact calculation of the field distortion is a problem of great difficulty but as we are only interested in diffraction around a human head, Weiner's measured results are satisfactory. These are shown in *Fig. 2* and

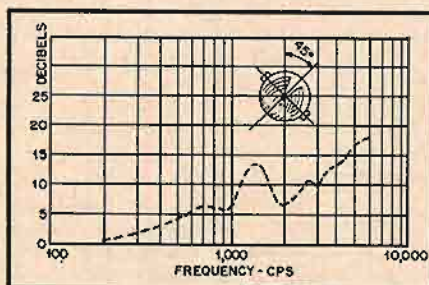

Fig. 2. Ratio of sound pressure (in db) at ears for an angle of 45 deg. to the source.

indicate that the pressure difference at the two ears has risen to 8 db at 1000 cps and 17 db at 6000 cps. Pure tones are not of significant importance in everyday life where the usual sounds—such as speech, music, and noise—have energy scattered throughout the whole frequency spectrum. On a complex sound the resultant pressure difference at the two ears will obviously depend upon the frequency spectrum of the energy in the sound. Steinberg has calculated the pressure difference and hence the loudness difference for normal speech and his results are shown in *Fig. 3* from which it will be seen that up to angles of 40 deg from the median the loudness difference in db is almost directly proportional to the angle turned through by the head.

The third major difference noted is that as the diffraction effects are a function of frequency, with a resulting difference in the frequency characteristic of a sound at the two ears. With experience the brain may be able to use this difference to provide a clue to localization.

For sounds originating in the median plane all these differences vanish as the

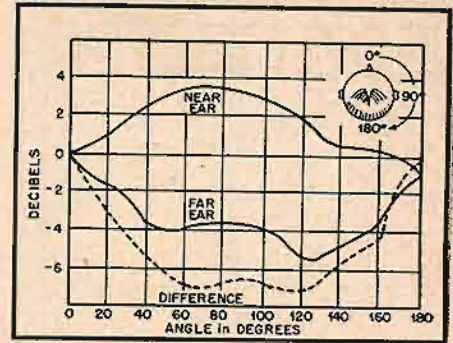

Fig. 3. Variation in loudness as a speech source is rotated in a horizontal plane around the head.

source is then symmetrically disposed with respect to the two ears, a condition that holds at all angles of elevation. It is to be expected that the precision of location in the vertical plane would be poor and in practice this is found to be the case. Discrimination between back and front is also found to be poor unless the head is free to make some exploratory movement. The slightest rotation of the head provides adequate discrimination between front and rear, presumably as a result of the brain noting the direction of the change in the time differences at the two ears.

It will be seen that there are three main differences in the sounds at the two ears—a time of arrival difference, a loudness difference, and a frequency-characteristic difference. At present there is no conclusive proof as to which of these provides the real clue to localization in practice. It seems highly likely that all three make contribution, with time and loudness differences providing the major clues.

Practical Stereophonic Systems

Consideration can now be given to methods of achieving stereophonic reproduction via an electrical reproducer system, knowing that we must maintain the time and amplitude differences present at the pickup points in the studio. There are two approaches to this problem, the first that of taking two samples of the sound field and transferring these two samples to the remote listener's ears through completely separate electrical systems and two headphones as shown in *Fig. 4*. Two entirely separate systems are obviously necessary as the left- and

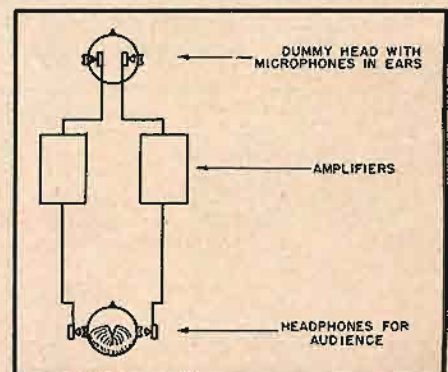

Fig. 4. Stereophonic reproduction with headphones.

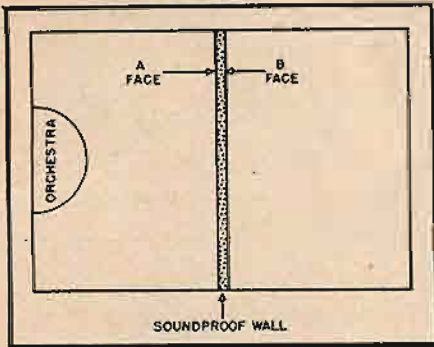
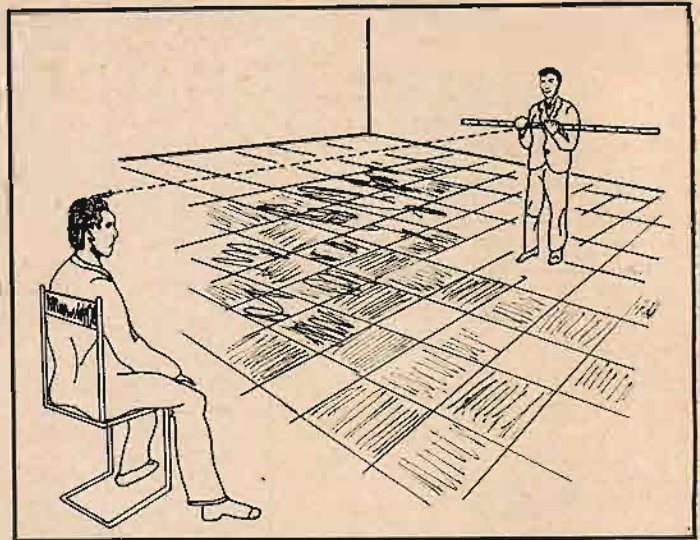

Fig. 5. A wall can be rendered sound transparent if face A is covered with microphones connected through individual amplifiers to loudspeakers on face B.

right-ear signals cannot be allowed to contaminate each other. At the transmitter end the sound pickup consists of two high-quality microphones mounted in a space model of the human head to simulate the acoustic field distortion produced by the head in practice. After amplification the signals are conducted by two separate channels to the two earphones. The results of this are extremely impressive but the necessity of wearing headphones militates against its use and it would appear unlikely to find favor with the general public unless the

Fig. 8. Method of error measurement in sound location tests.



If the listener's ears cannot be transported to the studio it is possible to adopt the alternative approach and transport the acoustic field to the listener. The principles involved will be understood by referring to Fig. 5 showing a long hall divided into two separate sections by a soundproof transverse wall at A. This wall can be rendered sound transparent (unidirectionally) by cover-

ing the A face with a large number of microphones each connected through an amplifier to a loudspeaker on the B face of the wall. Any sound field approaching the A face would be reproduced on the B face and the audience in the B section would be unaware of the dividing wall. While this procedure would be reasonably effective it is commercially impractical, as a separate line and amplifier are required between each microphone and its associated loudspeaker. Some means of reducing the number of microphones and loudspeakers is required.

In the vast majority of stage plays and most films the action is largely concentrated at ground level and as localization in the vertical plane is rather poor in any case it seems reasonable to assume that the "vertical" information need not be transmitted. This eliminates the need for all the loudspeakers except the bottom row, a very considerable simplification. With present techniques two or three separate channels are all that can be accommodated on tape, disc, or film, so it appears advisable to check the performance of two- and three-channel systems.

In a simple two-channel system, localization is weakest in the center just where it is desirable that it should be at its best and the addition of the third

[Continued on page 69]

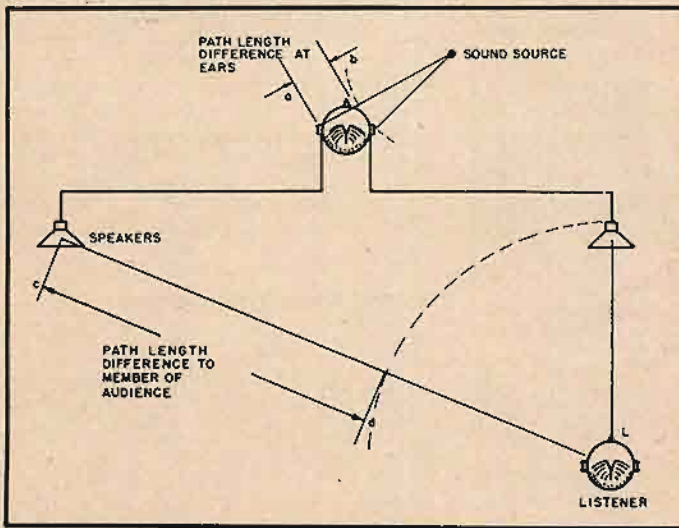

Fig. 6. Path-length discrepancy using closely spaced microphones and two-speaker system.

headphone cords are dispensed with. This could be accomplished by introducing two local (domestic) low-power radio transmitters with miniature receivers mounted on the headband—a procedure fairly common in film and TV studios for transmitting instructions to the operators of mobile cameras monaurally.

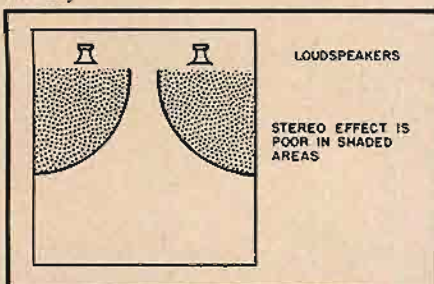
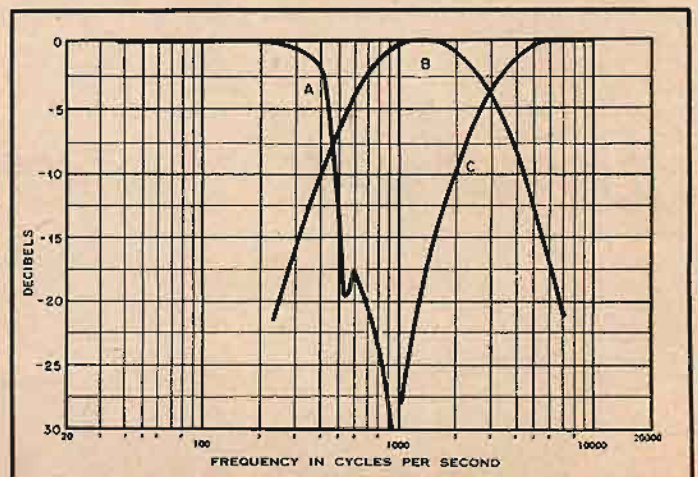

Fig. 7. When close-spaced microphones are with loudspeakers, the stereo effect is limited to the clear area.

Fig. 9. Filter characteristics. (A) low-pass filter; (B) band-pass filter; and (C) high-pass filter.



Design for Clean Bass

EDWARD J. GATELY, JR.*

The search for better loudspeaker enclosures centers around improvement in low-frequency radiation in small spaces. The author presents a simple and effective design.

THE MODERN TREND towards extension of reproduction into the upper limits of human hearing sounds thin and shrill if a corresponding extension of the bass range is not made simultaneously. There are many methods of extending bass reproduction, but most of these have inherent disadvantages and give rise to false or synthetic bass and annoying boom.

Truest reproduction has been accomplished only by the use of large exponential horns. This is because the exponential horn acts as an impedance matching transformer enabling the loudspeaker to set in motion the large amounts of air necessary for true reproduction. The exponential horn greatly reduces the motion of the loudspeaker, thus reducing distortion and increasing the power handling ability of the speaker system.

At low frequencies a loudspeaker operates as a constant velocity transducer. That is, for constant radiated power, the velocity of the cone remains constant as the frequency is halved, but the amplitude is doubled. In the lower audio spectrum extremely large amplitudes are required to radiate even small amounts of power. These large amplitudes give rise to distortion due to the non-linear suspensions of the cone and non-linear flux densities in the air gap. A horn greatly increases the air loading on the cone and reduces the amplitude the cone must travel to radiate the same amount of power. This materially reduces distortion.

A true exponential horn is a passage-way whose area doubles along discrete increments of length. Two factors govern the success of a horn operated at low frequencies. First, the taper of the horn should be such that the propagation of low frequencies through the horn is accomplished easily. For good low-frequency reproduction, the taper should be very gradual. Second, the mouth area of the horn must be adequate if smooth response is to be realized. If the mouth area is inadequate, reflections occur at the mouth and the response tends to resemble a picket fence. The above criteria may be expressed mathematically as

$$A = A_0 e^{2mx}$$

where A = area at any point along

- horn axis
- A_0 = area of throat of horn
- x = distance along axis of horn
- $m = \frac{4\pi f_c}{c}$ constant denoting taper rate of horn
- f_c = cut off frequency of horn
- c = velocity of sound in air

The mouth area of the horn should equal approximately the area of a circle whose diameter is $1/\pi$ times the wave length of the lowest frequency to be reproduced.

If we desire to make a true horn with an 80-cps cut-off, then the rate of taper should be such that the area doubles every 9 in., and the mouth should have an area of approximately 2110 sq. in. If we desire to operate this horn from a 12-in. driver having an effective cone area of 75 sq. in., then the horn must be nearly 4 ft. long. If a lower cut-off frequency is desired, then the taper will be slower and a larger mouth area will be required, and the length will be greatly increased. Thus it is easy to see that straight horns are impractical for home use. Many ingenious methods of folding horns have been developed, but the complexities of construction have made them relatively expensive, and the maintaining of an optimum mouth area has made these types of units too large for home use.

The Super Horn (patent pending)

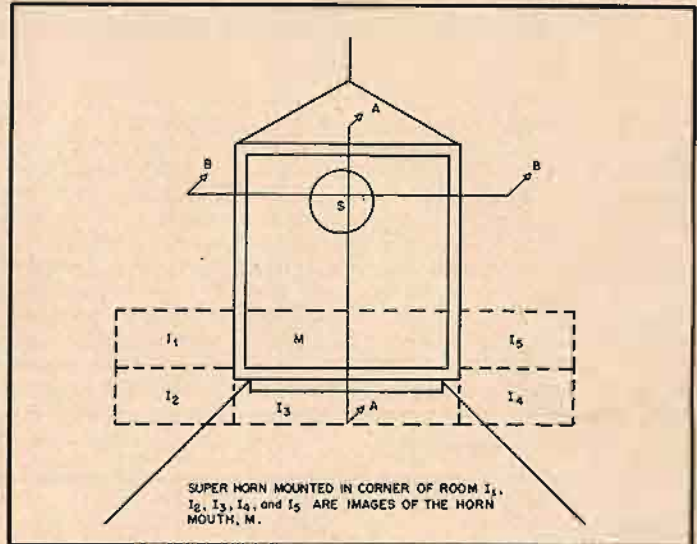

Fig. 1. Images of horn-mouth opening effectively multiply actual opening when speaker is corner-mounted.

has been developed to overcome all these difficulties and still meet all the above requirements of a true horn. By operating a horn where three mutually perpendicular surfaces intersect such as in the corner of the room, the walls and floor (or ceiling) act as an extension of the horn mouth giving rise to images $I_1, I_2, I_3, I_4,$ and I_5 (See Fig. 1). Thus, the effective mouth area equals six times the true mouth area.

The construction of the Super Horn is such that panels 1, 2, 4, and 5 act as an exponential horn following a true exponential within one per cent. (See Figs. 2, and 3). The throat of the horn (T) is formed by the top edge of panel 2, and panels 4 and 5. The mouth (M) is defined by the bottom edge of panel 3, the bottom edge of panel 1, and edges of panels 4 and 5. V_c acts as a coupling chamber to keep high frequencies out of the horn. X_1 and X_2 indicate the distance over which area of the horn doubles. The area at Q is double that of the throat and the area of the mouth is double that of Q. Once a flare-rate is chosen, the rest of the dimensions of the cabinet may be determined geometrically.

Two models of the Super Horn are presently available. One designed for 12-in. speakers has a taper rate to give a 78-cps cutoff and has an effective mouth area of 1728 sq. in. This satisfies very closely the above requirements of

[Continued on page 92]

* Gately Development Laboratory, Box 2, Clifton Heights, Pa.

Planning and Building a Radio Studio

EUGENE F. CORIELL*
Major, USAF

Part 5. Concluding this series with the finishing touches on wiring and cabling, a discussion of grounding, and suggested tests upon completion of the installation.

THE PRECEDING INSTALLMENT covered six of the audio planning steps in studio design. These were: 4. Rack layout; 5. Relay systems; 6. Rack internal cabling layout; 7. Interconnection cabling layout; 8. Cable list; and 9. Audio conduit diagram. The remaining steps will be discussed in this final installment and include: 10. Grounding diagram; 11. Running sheets; 12. Interconnection sheets, and 13. List of construction materials. There will also be a brief discussion of the testing of the newly-completed audio system.

resulting when, for example, the shield of a cable pair is grounded at both ends. It will be noted from Fig. 2 that multiple grounding forms a coil of one turn, in which a voltage may be induced by any nearby a.c. field. Since the pair shield is part of the loop or turn, noise may thereby be induced in the conductors.

Another grounding principle is to tie together the racks and the console chassis with a heavy ground conductor, insulated #10 or larger, which is run to station ground. It is sometimes necessary to slip a bare copper braid over this

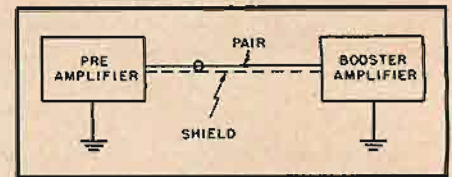

Fig. 2. Ground loop resulting from grounding shield to chassis at both ends of pair.

the reasoning holds nevertheless. Such grounding between racks and console also reduces capacitive effects between units, and cuts down r.f. pick-up.

A third—but very tentative—rule is to ground the shield of the input pair to the amplifier chassis; the shield of the output pair should be grounded to the frame or chassis at destination as shown in Fig. 3. This works out well in simple systems but is not always practical in more complex layouts, or when jack fields are involved.

Jack frames are usually bonded together and grounded to the rack itself which in turn is tied to studio ground. One reason for bonding the jacks is to reduce capacitive coupling between circuits. Another reason is to permit the shields of all pairs within the rack to be grounded to their respective jack frames. (Fig. 1) This avoids the complexity of carrying all the shields through the rack terminal blocks (while keeping the shields insulated from each other) for eventual grounding at the console or elsewhere. The same advantage applies when rack connections are made to the console through separable Jones plugs instead of fixed terminal blocks. It is essential, of course, that grounding instructions appear on the running sheets and interconnection sheets for the guidance of the wireman.

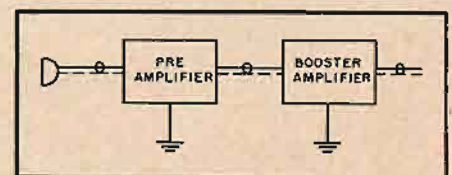

Fig. 3. Grounding arrangement for very simple system. Shield of input pair to each amplifier grounded to that amplifier. Shield of output pair grounded at destination.

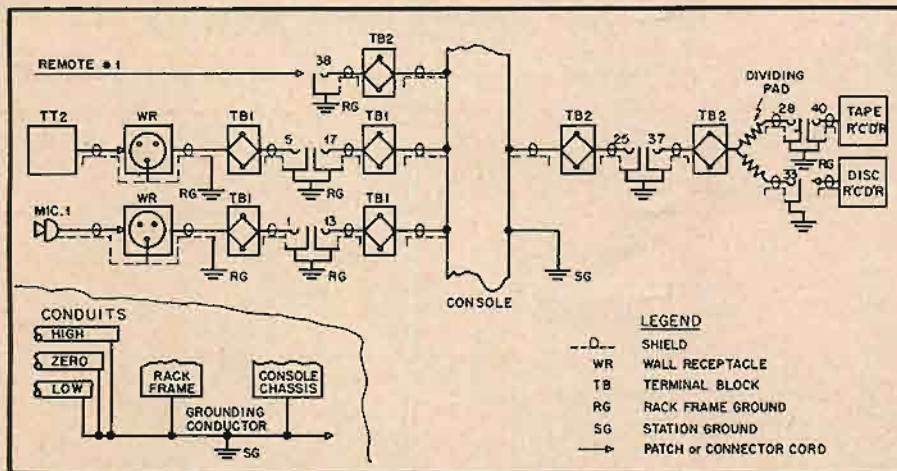

Fig. 1. Portion of the grounding diagram for the sample studio illustrated in this series. Note that no shields are carried through the terminal blocks. Shields of pairs in rack are grounded to their respective jack frames which are bonded to the rack. Shields of pairs coming to rack from consoles are grounded to console. Note also (inset) the separate grounding conductor which ties conduit, rack, and console together and goes to station ground. All rack amplifiers (not shown) have their chassis grounded to rack.

Starting with step 10, a good grounding system should reduce noise and hum, r.f. pick-up, high-frequency oscillation or singing, crosstalk, and danger of electrical shock. Since improper grounding may increase one or more of these hazards, the grounding system should be planned as carefully as the audio wiring itself and should appear in detail on the grounding diagram, Fig. 1.

The basic rule of audio grounding is, of course, the familiar precept: Use one-point grounds to avoid the ground loop

wire and ground it to station ground. Such a conductor does several things. It eliminates the temptation to use the shields of the interconnection cables as inter-rack grounding bonds, with resulting ground loops. It also reduces the danger of shock from the building a.c. service, which always has one side grounded. Section 2541 of the 1951 National Electric Code states: "Exposed conductive materials enclosing electric equipment, or forming part of such equipment, are grounded for the purpose of preventing a potential above ground on the equipment." While this section is not directed specifically at audio racks,

*Radio Technical Officer, Armed Forces Information School, Fort Stocum, New York

Guard against ground loops from patch cords by making sure the shields are grounded to the plug body only at one end of the cords. Also look out for unexpected loops resulting from capacitive coupling. Even a turntable motor housing may show considerable capacitance to nearby a.c. circuits.¹ Experimenting with various grounding points will usually help this condition. This points up a construction precaution for which the writer, at least, has always been grateful: Provide for permanent access to all grounds. Since grounds must sometimes be added as well as removed, it should be possible for a technician to reach the ends of all cable shields and other probable ground points without tearing out adjacent wiring. To facilitate this, it's a good idea to leave a pigtail taped up on the ends of pair shields not originally planned to be grounded.

R.F. Interference

R.f. pickup can be a most annoying phenomenon. By r.f. is meant not only electrical machinery interference such as motor and generator commutator sparking, but also the signal from nearby broadcast transmitters. And it doesn't matter whether the transmitter is yours or a competitor's. The writer recalls a studio near a super-power transmitter antenna wherein not only the installed audio equipment but also the portable tape recorder, the intercom, and even the p.a. system gave forth with the programs of our giant neighbor. The trouble is due to the low-level lines from microphones, turntables, etc., acting as antennas and feeding r.f. energy to the audio gear where any one of several conditions causes rectification. In aggravated cases, the resulting speaker output over-rides the desired signal.

There are several solutions or partial solutions, in addition to the usual audio grounding procedures and precautions. 1. Keep a.c. power and low-level input circuits as short as possible. 2. Orient the a.c. power plugs for minimum pick-up. 3. Use r.f. chokes with or without shunting capacitors between low-level sources and their preamplifiers. 4. Connect a capacitor and/or a resistor between chassis and one end of either the primary or secondary of the preamplifier input transformer, but check the effect on the high-frequency response. 5. Insert a 1:1 isolation transformer (having electrostatic shield between windings) between microphones or turntables and their preamplifiers. 6. Replace preamplifier input transformer with one having an electrostatic shield. 7. Use a grounded bare copper braid as a second shield over low-level pairs. 8. Build a grounded copper-screen box around preamplifiers and turntable filters.

Grounding Diagram

There should be a layout of the entire grounding system, including the con-

¹ Oliver B. Read, "Recording and Reproduction of Sound" (2nd Edition), p. 670.

duits. Some engineers prefer to show the grounding arrangements on the block diagram itself. It has been the writer's experience that superimposing complete grounding data on the block diagram seriously impairs the legibility of both. However, a spare copy or print of the block diagram can be used as a work sheet on which the grounding can be worked out by cut and try. The layout can then be redrawn in whatever form seems best. The grounding diagram in Fig. 1 somewhat resembles the block diagram but is to larger scale, includes terminal blocks and grounding notes, and

anced systems is best determined by trial; this puts a premium on accessibility of such ground connections after installation.

The grounding diagram also shows the various level-group families of conduit connected to station ground. These conduits should not be grounded to the building a.c. conduit. However, the hazards of construction often result in such grounds being not removable. In such cases, the audio ground may have to be removed from the conduit and should therefore be readily accessible to the technician.

LEVEL GROUP: LOW			RUNNING SHEET STUDIO "C"				SHEET 1 OF 9 SHEETS	
NOTES: RED MEMBER TO R.H. TIP SEEN FROM REAR, AND TO ODD NUMBERS ON TERMINAL BLOCK "X" DENOTES SHIELD GROUNDED TO FRAME, CHASSIS, OR BUS INDICATED TB = TERMINAL BLOCK								
PAIR NO.	CABLE LETTER	CIRCUIT	FROM		TO		SKETCH NO.	CHECKS
			EQUIPMENT	TERMINALS	EQUIPMENT	TERMINALS		
1	B	MIC. 1	JACK 1 X	1,2 T 3,4 N	TB 1 JACK 13	1,2 3,4 N		
2	B	MIC. 2	JACK 2 X	1,2 T 3,4 N	TB 1 JACK 14	3,4 3,4 N		
3	B	MIC. 3	JACK 3 X	1,2 T 3,4 N	TB 1 JACK 15	5,6 3,4 N		
4	B	TT1	JACK 4 X	1,2 T 3,4 N	TB 1 JACK 16	7,8 3,4 N		
5	B	TT2	JACK 5 X	1,2 T 3,4 N	TB 1 JACK 17	9,10 3,4 N		
6	B	LL ANN. BOOTH UTILITY #1	JACK 8 X	1,2 T	TB 1	11,12	1	
7	B	LL ANN. BOOTH UTILITY #2	JACK 9 X	1,2 T	TB 1	13,14	1	
8	B	LL TRUNK # 1 TO MIC.	JACK 12 X	1,2 T	TB 1	15,16	2	

Fig. 4. Sample of typical running sheet for audio cables.

LEVEL GROUP: LOW			INTERCONNECTION SHEET STUDIO "C"				SHEET 1 OF 4 SHEETS	
NOTES: RED MEMBER TO MIC. AND TT RECEPTACLE # 1 "X" DENOTES SHIELD GROUNDED AT TERMINAL INDICATED TB = TERMINAL BLOCK; WR = WALL RECEPTACLE; RG = RACK GROUND; MCG = MASTER CONTROL GROUND								
PAIR NO.	CABLE LETTER	CIRCUIT	FROM		TO		SKETCH NO.	CHECKS
			EQUIPMENT	TERMINALS	EQUIPMENT	TERMINALS		
1	J	MIC. 1	TB 1	1,2	WR 1	1,3 (2X)		
2	J	MIC. 2	TB 1	3,4	WR 2	1,3 (2X)		
3	J	MIC. 3	TB 1	5,6	WR 3	1,3 (2X)		
4	J	TT1	TB 1	7,8	WR 4	1,3 (2X)		
5	J	TT2	TB 1	9,10	WR 5	1,3 (2X)		
6	J	LL ANN. BOOTH UTILITY # 1	TB 1 (RG-X)	11,12	ANN. BOOTH WR 1	1,3	1	
7	J	LL ANN. BOOTH UTILITY # 2	TB 1 (RG-X)	13,14	ANN. BOOTH WR 2	1,3	1	
8	J	LL TRUNK # 1 TO MC	TB 1	15,16	MC-TB-3	9,10 (MCG-X)	2	

Fig. 5. Sample of typical interconnection sheet. This carries on to their destinations the rack circuits shown on the running sheet, Fig. 4, as terminated in Terminal Block #1.

may show transformer windings where necessary. The grounding layout illustrated also includes an inset showing the grounding conductor between racks and console. It is essential to keep this conductor in mind since decisions as to which shield is grounded where must be based on its existence. The grounding system illustrated assumes all amplifier chassis in the racks are firmly bonded to the rack shell, and that all circuits are balanced to ground. In the writer's opinion, the proper grounding of unbal-

Care must be taken in regard to the microphone, turntable, and other low-level circuits. The cable should, of course, have insulation over the shield which should not contact the conduit at any point. Noise and hum in such circuits can sometimes be reduced by using the ground wire in the conduit (suggested in the previous installment) to place a ground on either the shield or the conduit at destination.

[Continued on page 74]

A Corner-Mounting Infinite Baffle

M. V. KIEBERT, JR.*

A presentation of some of the problems involved in loudspeaker enclosures for high-quality reproduction, and the author's solution with a suitable design to house an LC-1A speaker mechanism.

PAST EXPERIENCE has all too often made us painfully aware that what was often called a "loudspeaker" was just exactly that and not the "reproducer" that it should have been.

In order to attempt to satisfy a very critical listener who happens to be a rather exacting engineer by profession and an out-of-hours musician by hobby, but who knows what he likes when it comes to musical reproduction, a survey was made of the over-all reproduction problem. Seven years of test, exploration, and development followed. Not only was it necessary that it must not offend the eye, it was also required that the assembly should be capable of being moved from place to place as the engi-

neering business dictates, a brick or stone enclosure thus being ruled out.

In casting about for a suitable device it is immediately apparent that there were but two basic design paths to follow; the horn-loaded unit, and the direct-radiator system.

The problem of power output was next considered. Measurements of the acoustic power levels of the various instruments were reviewed; a sound-level meter was used to survey typical levels encountered at choice locations at several Philadelphia Philharmonic and Lewisohn Stadium concerts.

Noise-level surveys at these concerts were also made and compared with typical home listening levels in order to assess more accurately a scale factor which would provide equal desired-signal-plus-background to background lev-

els and hence comparable dynamic ranges. Consideration was given to the effect of monaural listening as compared to binaural listening and to the aural discrimination intrinsically present when sight is used to supplement sound.

With monaural listening it appeared that an acoustic level of one to two acoustic watts could do a satisfactory job, but that an additional 10 to 20 db of dynamic range would be desirable. The measured dynamic ranges of direct (live concert of the Philadelphia Symphony) performances were surprisingly low (presumably because of the averaging due to reverberation in the hall). Twenty to twenty-five db appeared to be a maximum.

This study provided initial clues as to the required optimum design trends. Early experience with theatre horns and their 20 to 25 per cent conversion efficiency, indicated that an amplifier with a clean 4.5 watts of electrical output would do a good job covering 600 to 1500 people. Typical direct radiator systems have conversion efficiencies of 3 to 16 per cent so the power amplifier must have between six and thirty electrical watts output to do the same job in a satisfactory manner.

From our point of view the low-efficiency, power-demanding, direct-radiator system is not good design. The lower efficiency units generally are that way either because of inadequate magnetic circuits, or as a result of diaphragm break-up—both being cases to be avoided if IM is to be kept to a low value. The higher more efficient direct-radiator units such as the Altec 604C or the RCA LC-1A permit a good design compromise by only requiring a nominal six- to twelve-watt power amplifier which is relatively easy of attainment with low-voltage, low-cost power supplies and rather nominally rated and operated power output tubes.

Frequency Range

The next item for consideration was frequency range and the sound distribution patterns desired for average installations.

Many engineers and hobbyists rather indiscriminately add high-frequency and low-frequency units into a system and frequently do achieve some measure of frequency balance insofar as level as a

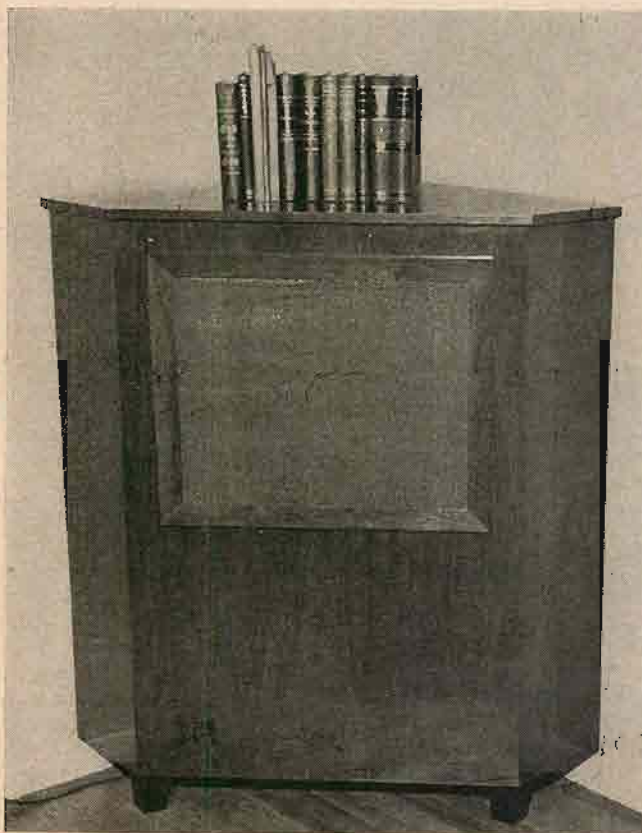

Fig. 1. A simple yet neat appearance characterizes the author's speaker enclosure which provides for a 15-in. single-unit speaker mechanism.

function of frequency is concerned. However from the writer's point of view this procedure would be analogous to having an artist paint a background in one picture, the theme or object in another, and the high lights in a third. Then by hanging all three pictures side by side we should get the integrated Whole. Leonardo Da Vinci didn't do it—so we're not trying to do it either.

Considerable experience in the design of directional antennas (which may be likened to acoustic radiating systems) emphasized the distorted spatial distribution patterns that always occur when space separation exists between two sources of radiation even when these are in phase. Add some phase variation and the spatial pattern becomes all the more non-uniform.

From the foregoing it appeared that horns and multiple-unit systems were not too desirable and in fact critical listening tests by musicians and non-musicians always seemed to favor the single-source direct-radiator system when this was given A-B comparison tests with multiple-unit horn-type systems. During these tests the observers did not know which system was in operation. The almost universal response was that one system seemed "smoother" than the other.

One axiom in enclosure design is this: if when you touch the enclosure you can feel the low notes, it's not good!

G. A. Briggs of Whartedale got around this difficulty by using a brick enclosure. John V. L. Hogan minimized this difficulty in an early (around 1936) WQXR receiver by heavy cross-bracing of the enclosure. The greater portability of the latter arrangement appealed to us and according this design procedure was followed.

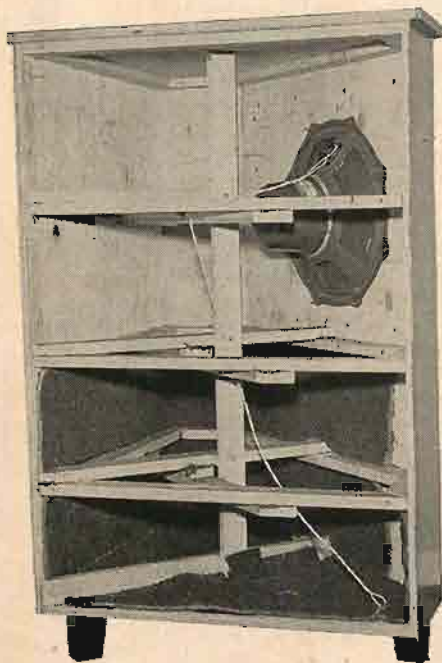

Fig. 3. Internal view with one back panel removed to show cross bracing and unsymmetrical mounting of the speaker. Also note start of Ozite lining in lower part of cabinet.

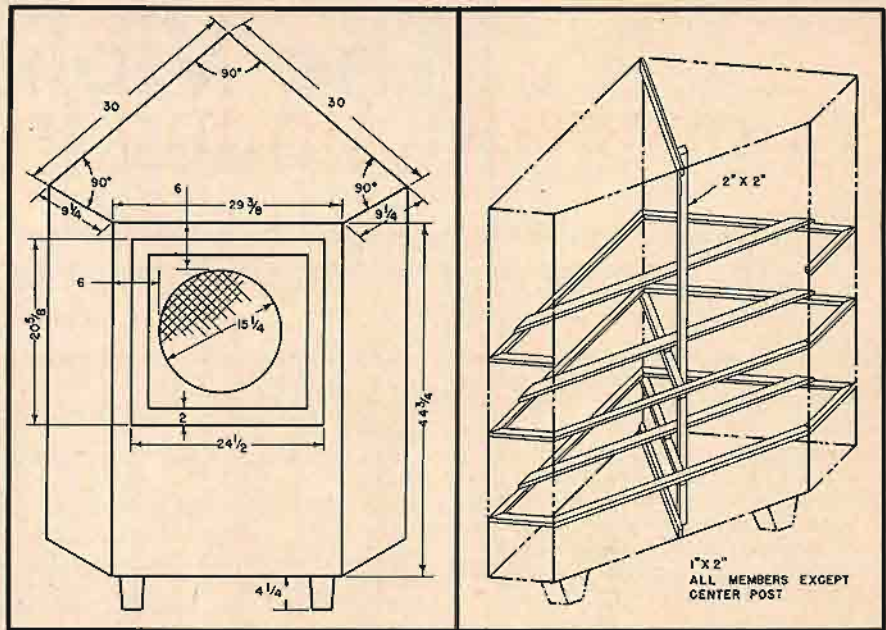

Fig. 2. Constructional details for the corner-mounted infinite baffle.

For our requirements a corner speaker held several desirable advantages. The corner design improves the radiation characteristics, as is well known; the triangular design permitted very rigid construction; the design easily permits asymmetrical speaker mounting and consequent avoidance of spurious peaks, and the system presented a minimum decoration problem insofar as integration into a living space was concerned.

With a low-frequency cone resonance of between 35 and 40 cps, and a desire to minimize the rate of roll-off below this resonance as well as to ensure smooth low-frequency curve immediately above it, a volume of approximately 15 cu. ft. was decided on, and a completely enclosed structure was considered essential. Fig. 1 is front view of the enclosure.

Construction

In order to fit snugly against the wall, three legs $4\frac{1}{4}$ -in. high were used in order to raise the cabinet above the average baseboard. This is not too desirable because of the small resonance peak occasioned by the cavity formed between the enclosure and the floor. For this reason the legs are removable and we ultimately visualize installation of the enclosure against the ceiling.

The enclosure is made of $\frac{7}{8}$ -in. plywood with construction details as shown in Fig. 2. Assembly is with wood screws and casein glue with particular care taken to insure a rigid and air-tight assembly.

All peripheral and cross brace stiffeners were made of 1×2 -in. fir. The top-to-bottom member was 2×2 -in. fir tied into the three sets of interior cross braces by cemented-in blocks aided by wood screws.

The speaker mechanism chosen—the RCA LC-1A, more commonly known as the Olson speaker—is mounted asymmetrically in order to break up all re-

inforcing reflection paths which might otherwise degrade the response curve. The unit is mounted near the top of the cabinet in order to provide the optimum spatial distribution with the sound source as close to ear level as possible.

The interior is lined with ozite cemented on with rubber cement. Additional absorption was utilized by draping strips of ozite across the internal cross-bracing members as shown in Figs. 3 and 4.

The performance of this speaker mechanism in this particular cabinet is considered adequately rewarding for the work involved in designing and constructing the enclosure, and it is felt that the complete system is as good as the writer can make it—until the urge to redesign shall again arise to start the entire cycle over again.

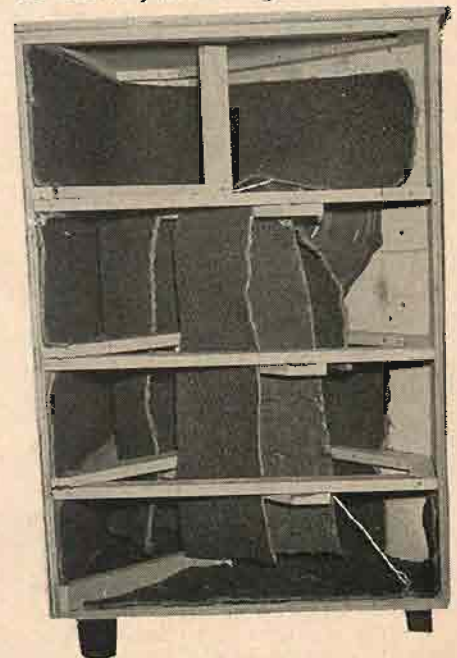

Fig. 4. Scrap strips of Ozite lining are draped over internal bracing to further dampen the cabinet.

The Violin

ALBERT PREISMAN*

Part 2. Continuing the discussion of one of the most important instruments in music. This installment covers the basic construction of the body of the instrument.

IN LAST MONTH'S installment, the history of the violin was discussed briefly, and some of the basic characteristics of the tone-producing operation were described. While the violin is apparently an instrument which is reasonably familiar to most laymen, many will be surprised as the intricacies of its construction. It will be seen that this instrument is not just "a cigar box with a handle on it."

The Bridge

Figure 5 shows the shape of the bridge as finally determined by Stradivarius. The name bridge is very apropos, for it acts as a bridge over which the vibrations of the string may pass to the body of the violin, thence to the confined air, and finally out through the *f*-holes to the air in the room.

The bridge is at a node of the string; indeed, it establishes a node in the string where the latter passes over it. But this does not mean that there is no vibration whatsoever at the bridge; rather it means that the impedance to the propagation of the vibrational energy is much higher in the bridge than in the string. As a result of such an impedance discontinuity, reflections and standing waves are set up in the string, but some of the energy does pass on through the bridge and into the body of the violin.

Figure 6 indicates the action of the string on the bridge. The lowest or G string is shown. The bow causes it to vibrate laterally as is indicated by the double-headed arrow *F*. It causes the bridge to rock on foot A as a fulcrum, and foot B presses down on the top of the violin body setting it into vibration. The moment of the string is the force *F* it exerts on the bridge multiplied by the lever arm *a* (assuming for the moment that the bridge acts as a rigid body).

The top or belly of the violin reacts with a counter force at B, which has for its lever arm distance *b*. The two moments, of course, are equal and opposite; the force at B is equal to Fa/b . The question may arise as to why the bridge does not rock on foot B, and set the belly of the violin into vibration at point A. The reason is that the belly under foot A is stiffer and resonant to a higher frequency than the part under B, so that for the low-frequency G string the vibration is as indicated.

*Vice-President in Charge of Engineering, Capitol Radio Engineering Institute, Washington 10, D. C.

The E string is located over foot A. When it vibrates, it causes the bridge to rock, presumably on foot B as a fulcrum, and the foot at A causes the belly of the violin to vibrate, because the belly here is more nearly resonant to this range of frequencies. With regard to the A and D strings located in between the G and E strings, the probability is that the fulcrums are somewhat less clearly defined, and both feet rock and cause the belly to vibrate to some extent beneath them. In short, the bridge is not a well-defined bell-crank lever, and is probably caused to rock more or less on both feet, depending upon the frequency involved.

The incisions in the bridge, shown in Fig. 5, undoubtedly introduce a certain amount of compliance or "give" in the bridge. Such shunt compliance tends to break up the vibratory mass of the bridge into separate sections, thus forming a number of low-pass filter sections in cascade. This is the same principle as

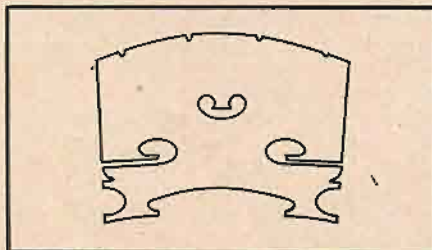

Fig. 5. The bridge.

that employed in the original orthophonic Victrola and in the double-voice-coil speaker of Olson; namely, to extend the frequency response by dividing one large mass into two or more smaller masses with shunt compliances interposed between them. The result is a more extended frequency response than would perhaps be obtained from a solid bridge. It is remarkable that Stradivarius and even those before him hit upon this expedient without actually knowing the scientific reasons behind it.

The bridge is not glued to the belly of the violin, but its feet must fit the belly precisely, otherwise the compliance at the point of contact will be too great and the higher frequencies particularly will not be transmitted to the body of the violin. The tone is then "hollow and dull."

The height of the bridge is important. If it is too high, lever arm *a* of Fig. 6 is too great relative to lever arm *b*, and presumably the impedance match

between the string and the belly of the violin is impaired, particularly for the higher frequencies. At any rate, the tone is dull and "sluggish," which means it lacks higher frequencies. On the other hand the tones are fairly loud.

If the bridge is too low, the tone is not as loud, but is harsh and piercing, which means that the higher harmonics are unduly accentuated. It is said that a high bridge accentuates the faults in a

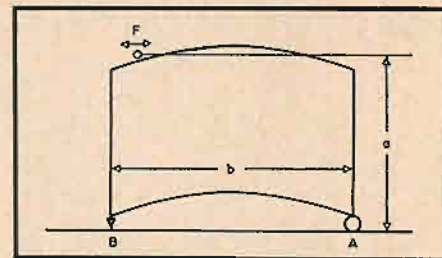

Fig. 6. Lever arms involved in bridge action.

fiddle, which faults are glossed over by a low bridge.

The Body

The body is a composite structure of pine or spruce and maple, and is the heart of the instrument. The top or belly is made of pine, usually with two pieces glued together edge to edge to form a seam running down the middle of the violin. This is also the direction in which the grain of the wood runs; if the grain ran cross-wise, the tone would not be as brilliant.

The back and sides are made of maple, although pear and sycamore wood have also been used. The back is also usually made of two pieces of wood glued edge to edge, and for the same reason: it is more difficult to obtain one single piece of wood of the proper characteristics.

The ratio of stiffness to mass is higher in pine than in maple, so that an identical shape would have a higher pitch when set into free vibration. However, the presence of the *f*-holes in the pine belly tends to lower its pitch in spite of the bass bar, and the maple back is made thicker so that its pitch is about one note higher when struck or bowed like a string.

This difference in tone between the top and bottom before they are glued to the sides appears to be important to the final tone of the violin. If the back is made thinner so as to have the same tone as the belly, the violin is found to give a feeble and unsatisfactory tone. Even if there is a difference in pitch, but the difference is less than one tone, the

sound of the instrument is found to throb. However, if the difference is greater than one tone, the results are said to be even more unsatisfactory. More will be said about this presently.

The thickness of the wood is important. It must not be too thin, otherwise the tone is weak and feeble. This depends, however, on the shape. The old German violins were high-breasted (highly arched), which made their top and bottom structurally stiffer. In order to have the correct pitch, the wood had to be made thinner. In this case the main disadvantage is that the instrument tends to be too weak to withstand the pull of the strings. This, by the way, corresponds to a total pull of 68 pounds, and the vertical pressure on the bridge is about 26 pounds. Yet the entire violin weighs but $8\frac{1}{2}$ ounces!

If the wood is too thick, the tone is sluggish and dull, which indicates suppression of the harmonics. Nevertheless, a violin with thicker wood will develop in time with continued playing, and will probably withstand the ravages of time more successfully than a violin made of thinner wood (within reason, of course).

The body encloses a certain volume of air, which must be correct so as to resonate at the proper fundamental frequency. This corresponds to about 300 cps, which is in the range of the G string.

The comments of musicians concerning the proper volume is of interest: If the air volume is too great, the low notes are weak and dull and the high notes are sharp and thin. If the volume is too small, the low notes are coarse and those of the E string lose their brilliancy. We note, in passing, that in the case of the cello, the depth is relatively greater than that of the violin, in order to avoid too large an instrument.

When the body is glued together, it shows a strong resonance peak around B flat on the A string. This can be distressingly strong, in which case it produces a tone that varies cyclically in intensity, and is known as a "wolf note" from its ululant nature. Cellos are particularly plagued by this phenomenon.

Experiments by Kessler indicate that it corresponds to a particularly strong mode of vibration of the pine belly of the instrument, with one node coinciding in part with the bass bar under the G string, and another node under the E string and passing through the sound post.

Elimination of the wolf note is not easy; in the case of a violin it is a fairly sharp peak, and if it can be made to fall between two adjacent notes of the instrument, it will be less objectionable. In the case of the cello it unfortunately is a broad resonance peak and embraces approximately four notes, so that its elimination is exceedingly difficult.

Directly under the G string, and running for $10\frac{1}{2}$ inches of the length of the instrument, is the bass bar, Fig. 7. It is made of pine, cut to fit the contour of the belly, and glued to its under side. Its action appears to be that of adding stiffness to the belly along its line of contact and therefore to raise its fre-

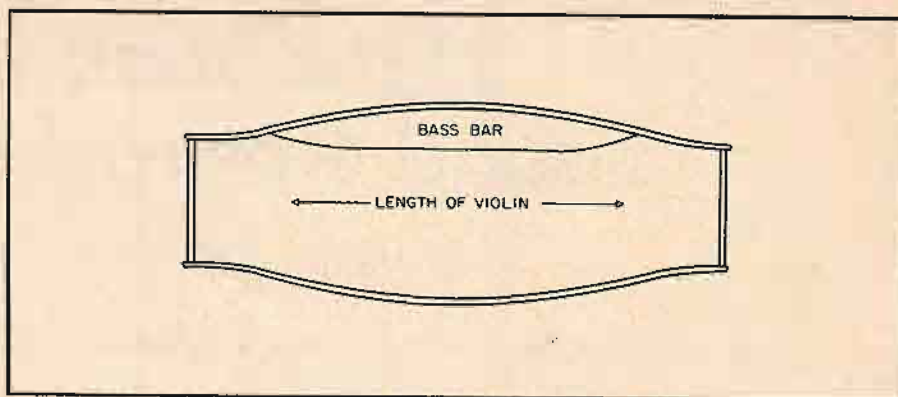

Fig. 7. Side cross-sectional view showing the bass bar.

quency. This effect compensates for the lowering of the stiffness and hence natural frequency of the belly when the *f*-holes are cut; the bass bar restores the natural frequency back to approximately C, or 512 cps once more. It also prevents segmental vibrations of the wood in this region, in contrast to the sound post.

The sound post is a $\frac{1}{4}$ -in. rod or dowel of white pine, which is inserted vertically as a kind of prop inside of the body between the belly and back of the violin. As is indicated in Fig. 8, it rests in a line with the right foot of the bridge (directly below the E string). Actually it is set about $\frac{1}{4}$ -in. behind or below the foot of the bridge, with its grain at right angles to that of the belly.

This is perhaps the most important element in the instrument; upon its setting and thickness depends the tone of the instrument. In the first place, we note that it is not glued to either the belly or back, but merely wedged between the two. As such its action appears to be similar to that of the finger on the string when playing a harmonic; the finger is pressed lightly so as to establish a mode for the desired harmonic and to kill any fundamental vibration of the string.

In the same way the sound post appears to force the wood to vibrate in segments such that where it presses against the wood a node is established. Thus the right foot of the bridge rests on a part of the belly that is constrained to vibrate at the higher frequencies by the sound post, whereas the left foot rests over the bass bar where a lower natural frequency of the wood occurs, and segmental higher-frequency vibra-

tions are prevented by the stiffening action of the bass bar.

It is for that reason that the bridge was stated to rock about the right foot for low-frequency vibrations, and about the left foot for high-frequency vibrations, for in either case the other foot finds the wood it is resting on can "give" and vibrate at the frequencies to which it is approximately resonant.

We note that a poor violin is often improved by placing the post nearer the bridge, although it requires very careful playing to render the tone even. On the other hand, if the tone is even but rough and harsh, the post must be moved back a little (thereby presumably de-emphasizing the higher frequencies).

If the high strings are weak and the low ones are harsh, the post should be moved a little outwards toward the *f*-hole. If the low notes are weak and the high ones shrill, the post should be moved slightly toward the center.

It is possible to simulate the action of the sound post by pressing with a weight on top of the belly, as was discovered by Professor Savart, a famous French investigator of the violin. This indicates its nodal action in the violin.

Perhaps one of the most striking features of the action of the sound post is that it deadens the sounds of plucked strings (*pizzicato*). For that reason it is absent in the mandolin and guitar; this is perhaps as important a difference between these instruments and the violin as their method of being energized, that is by plucking rather than by being bowed.

The final important feature of the body of the violin is the *f*-holes. These

[Continued on page 67]

Fig. 8. Cross-sectional view through the middle of the violin, showing sound post and position of the bass bar.

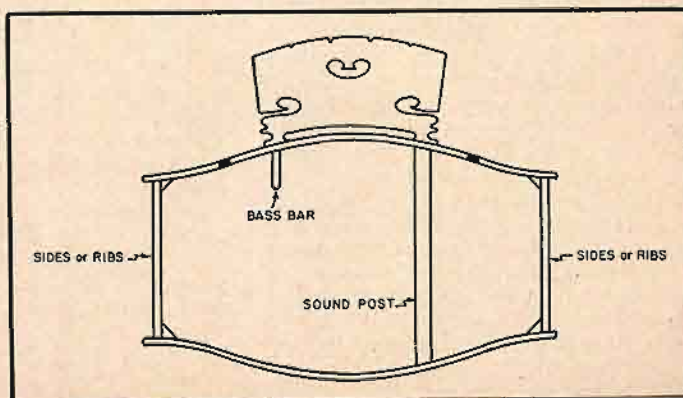

Handbook of Sound Reproduction

EDGAR M. VILLCHUR*

Chapter 5—Musical Instruments and the Human Voice

A discussion of the methods by which sound is produced by various familiar musical instruments. The author shows how air is set in motion by vibration of some part of the sound producing device.

MOST SOURCES of musical sound, including the human voice mechanism, are complex systems, containing a primary vibrating source plus a system of resonators and acoustical couplers. The primary vibrating element—reeds, strings, and air streams flipping back and forth across hard edges are common types—provides the initial oscillatory energy for the fundamental tones and a spectrum of harmonics. In the case of the triangle, the cymbal, and a few other percussive instruments, the primary source comprises the entire system, but ordinarily this source is coupled to and partly controlled by resonators which selectively emphasize certain harmonics and give the sound its characteristic timbre. The majority of instruments, with the notable exception of members of the flute family, also have a sounding board or horn to increase the efficiency with which oscillatory energy is coupled to the air.

The various instrument families will be discussed along the lines of the general functional breakdown indicated above.

The Bowed Strings

The primary vibrating source of a bowed string instrument is the mechanical mass-elasticity system formed by a stretched string, which is normally set into vibration by drawing a rosin-coated hair bow across it. The bow tends to drag the string along with it, and succeeds in displacing it transversely until the elastic restoring force of the system exceeds the frictional coupling between bow and string. At this point the string is released and springs back, and the bow does not catch again until the string has exhausted its momentum in the opposite direction. Since the friction between moving surfaces is less than that between surfaces at rest with respect to each other, the resonance characteristics of the string are able to determine the period of time required for the bow to regain its grip and to carry the string on a forward journey once again.

It can be readily seen that the vibrations induced in the string will not be of pure sine form; the stimulating force

has a saw-toothed wave shape and is applied over a very small part of the total length, causing a deformation far different from that which would be associated with a pure sine-wave fundamental vibration. The multiresonant properties of the string create a primary tone with strong harmonics which reach into the higher orders.

The various intercoupled mechanical and acoustical resonant systems of the body of the instrument respond to this stimulation rich in harmonics, producing a tone such as the typical violin wave form illustrated in Fig. 5-1. The belly, back, and ported enclosure serve a dual function as resonators and as air couplers.

Although the resonator formed by the enclosure and the *f*-holes (so named because of their traditional pattern) is of the Helmholtz type, without overtones, it is highly damped due to the viscosity of its internal surfaces, and it tunes broadly and reinforces the tone of a large band of frequencies in the lower range. In addition the dimensions of the body relative to the wave lengths of the sounds produced is such that various air column resonances also come into play. The distribution and relative strength given to harmonics are what determine the difference between a high-quality instrument and a poor one.

If the main body resonance is a sharp one the instrument may vibrate so violently at the corresponding frequency that it produces a very unpleasant howling effect called the "wolf note." Measures taken to counteract this effect include damping and careful adjustment of the resonant frequency of the body. There is a clear parallel between this difficulty and similar troubles occurring in loudspeakers.

The design differences between the different members of the bowed string group are along the lines that we would anticipate from the earlier discussion of principles governing freely vibrating systems. We would expect the low-frequency double bass, for example, to have strings of high mass and low stiffness, for its Helmholtz enclosure to have large volume, and for the sounding boards formed by the belly and back to be great in area. The last expectation follows from the fact that the excursion of air

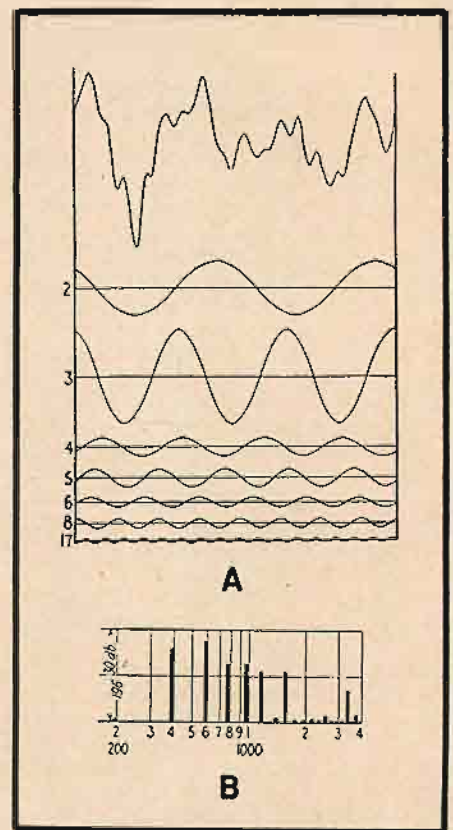

Fig. 5-1. (A) Wave form and dominant harmonics of typical violin tone at 196 cps. (B) Relative intensity, in db, of components of the tone. (Courtesy McGraw-Hill Book Co. from *Psychology of Music*, by Carl E. Seashore.)

molecules must be increasingly greater, for the same sound power, as the frequency of vibration is decreased. Since the vibratory excursion of the instrument's belly and back is obviously limited, the radiation of sound power at low frequencies is kept up by moving a larger number of air molecules over the shorter path. This is the equivalent, from the point of view of power transferred to the medium, to moving a smaller number of air molecules over a longer path, and results in the relatively strong and deep fundamentals voiced by the bowed or plucked double bass. The same principles applied to speaker systems make possible the efficient reproduction of bass.

* Contributing Editor, AUDIO ENGINEERING.

Instruments of the bowed-string class allow the performer to control timbre by different techniques of bowing which deform the string in different ways. In addition the player, by changing the length of string left free to vibrate, has exact and continuous control of pitch. He is able to use natural pitch intervals and can apply frequency and amplitude vibrato.

Plucked Strings

The plucked string group includes the guitar, the harpsichord, and the harp.

The harpsichord is a keyboard instrument similar to the modern piano, but with a lever-actuated plectrum of leather, fiber, or tortoise shell which plucks rather than strikes the strings. The harpsichord proper, also called the *clavicembalo*, ordinarily has two manuals or keyboards. Occasionally a third keyboard and a pedal board are included. Each manual has more than one set of strings, and each set of strings is controlled individually by a stop, as on the organ, so that the timbre of notes is under the control of the player, who can introduce or delete sets of resonating strings. In all models the coupling between the vibrating strings and the air is aided by a sounding board with which the strings are in contact, greatly increasing their effective area of radiation surface.

The harpsichord was the principal solo keyboard instrument, and held an important place in the orchestra, until the close of the 18th century. At that time it was superseded by the piano. Recently, however, there has been a re-birth of interest in this instrument, which has ceased to be regarded as an old-fashioned piano and is accepted as an instrument of unique quality in its own right. The timbre of the harpsichord includes a much more extended range of higher-order harmonics than that of the piano.

The modern harp is a multistringed instrument in which the strings are plucked by hand, and in which the effective length of each string can be shortened in two semitone steps by a system of pedals. Although the harp is one of the most ancient of musical instruments, having been used by the Egyptians of the 13th century B.C., the modern pedal version is less than 250 years old. Its characteristic "ethereal" quality is largely a function of the relatively small sounding board which forms its base. The decreased area of the radiating surface, compared to that of the keyboard stringed instruments, does not couple as much air resistance back into the vibrating system; the amplitude of the tone is decreased, and the poor damping allows the tone to persist for a longer period of time.

Struck Strings

The piano and the clavichord are members of the group of stringed instruments which operate by a striking action. The piano has more than one active string for each key (except for the lower bass notes); the five upper octaves use plain steel strings, while the strings

of the lower notes are wrapped in order to secure the greater mass required by a low-frequency vibratory system. The vibrations of the strings are coupled to the air by a sounding board.

The key mechanism of the piano works as a launching device. When a key is depressed the hammer is driven towards the appropriate string, but is released from its driving mechanism, like a projectile for a sling, before the key has reached its bed. The hammer is thus

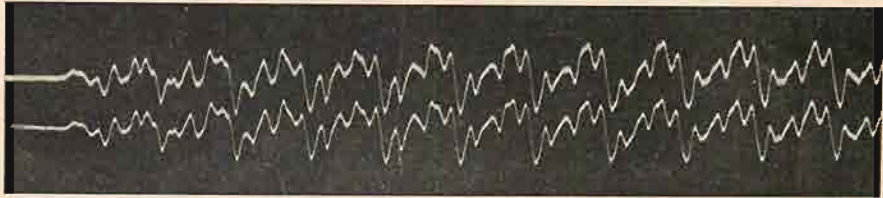

Fig. 5-2. Single piano tone produced by a concert performer, compared to the tone produced by allowing a weight to fall on the same key. (Courtesy J. Acous. Soc. Am.)

free at the point of striking, and it rebounds and remains poised a short distance from the string as long as the key is kept depressed. At the same time that the string is struck its damper is removed. When the key is released the hammer returns to its normal rest position and the damper is again brought to bear on the string.

The piano tone may be controlled in a limited manner by pedals. These operate by adding or removing dampers, by reducing the length of the hammer stroke, or by shifting the position of the hammers so that fewer strings are struck.

The mechanical system of a piano is such that the player can exert no control over the action of the keys other than determining when, how hard, and for how long the key will be depressed. There is no such thing as artistic "touch" relative to a single note.¹ Figure 5-2 illustrates the identity of tones produced by a concert performer striking a key and by a weight falling on the same key. Descriptions of the quality of a piano performance which employ terms referring to the artist's "tone" or "touch" are not fallacious, however, because the overall quality of the sound of a piano is formed by the relationships, in intensity, timbre (as a function of intensity), and duration, between the individual notes. A particular performance may be thought of as having a "brittle" or a "singing" tone, but these qualities are not based upon the wave form produced by the individual strings, which at a given intensity is unchangeable.

The vibrations of the piano string do not have a large content of higher-order harmonics because of the nature of the hammer, which is felted and which has a rounded striking surface. The strings are thus not deformed to an angular shape, and do not produce a wave form with as much high-frequency content. The richest timbres are in the bass (the energy content of the very low notes

¹The pianist can contribute a greater noise component to the tone by a percussive stroke, and there is a trick, of no artistic significance, in which partial damping is attempted by momentary release and a second stroke.

consists almost exclusively of harmonics), while the higher notes contain a progressively weaker harmonic structure. Like the violin, the piano may be plagued by a wolf note, which in this case is more properly called a clang tone. The bass strings may form standing waves at relatively high frequencies (stimulated by the initial hammer impact) which are harmonically unrelated to the fundamental.

In contrast, the brass strikers of the

clavichord produce a tone which resembles that of the plucked harpsichord. The clavichord is a smaller instrument, sometimes made as a table model, and does not have as intense a sound as either the piano or the harpsichord. The striking of the strings of the clavichord is achieved with an entirely different mechanical system from that of the piano: the brass tangent which strikes the string simultaneously marks off the length of the vibrating section, and the key does not lose control of the string as it does in the piano. The player thus "makes" his own notes, like a violinist or guitar player, and the introduction, from the keyboard, of subtle variations of pitch and of vibrato are possible.

Reedless Wind Instruments

The flute, piccolo, and pipe organ are the main instruments of this category. The fife, flageolet, and recorder are similar to the flute in that they make use of air-column resonance, while the ocarina (sweet potato) and police whistle use enclosure resonators which are of the Helmholtz type.

All of the instruments mentioned receive their stimulating energy from a steady stream of air. This stream is directed against a hard lip, and eddies of whirling air currents are formed, alternately on each side of the lip, as illustrated in Fig. 5-3. The effect is the same as that of an actual reed vibrating back and forth; for this reason these instruments are sometimes referred to as belonging to the *air-reed* class.

The primary, non-sinusoidal oscillation thus produced is called the edge tone. By itself the edge tone would have a natural fundamental frequency determined by the velocity of the air current in relation to the diameter of the edge, but the primary vibratory system does not operate independently. It is strongly influenced and almost controlled by the air resonator to which it is coupled, whose fundamental-harmonic resonances force the frequency of vibration of the "air reed." The frequency of oscillation of the air column or cavity is also pulled

[Continued on page 88]

New York's Newest Shrine to Audio—

Arrow's Audio Center

Several innovations in demonstration methods and displays will attract many newcomers to the ranks of Hi-Fi enthusiasts—and will please many an Old-Timer in the art.

BETWEEN THE MANUFACTURER of audio equipment and the ultimate user is one important link—the jobber. Here it is that the equipment is shown and demonstrated, prepared for easy and efficient interconnection, planned by the buyer and the salesman—who is generally somewhat of a hobbyist himself if he is to be a success in his work—and finally packaged in a manner which will fit into the preconceived system which the user envisages.

Here too is where the customer learns the difference between pickups, record changers, amplifiers, tuners, speakers, and speaker enclosures. It is only by careful inspection and aural comparison that many buyers can be satisfied. Such an institution is the new Audio Center recently opened by Arrow Electronics in the heart of New York's famous Radio Row—Cortlandt Street between Greenwich Street and the Hudson River. Only two blocks long, this street has long been known as the center of radio in Manhattan, even though several other streets in the same vicinity have absorbed the overflow.

Many jobbers—or distributors, as they are more properly known—have recognized the need for adequate facilities for the proper demonstration of audio equipment, but it remained for Arrow to open a second store devoted entirely to audio. Their other store a block closer to the river handles capacitors, transformers, resistors, jacks, switches, and the general run of radio part store merchandise.

But the new Audio Center means just what the name implies—and Audio is certainly its central theme. The entire store—which occupies the first and second floors of Arrow's five-story building—is brand new from its new entrance and display windows to the back of the studio floor. *Figure 1* shows the exterior, and *Fig. 2* shows the view which greets the customer as he walks into the building. Along the right is a conventional counter which provides sales space for the smaller items, such as pickups, replacement styli, recording tape and wire, accessories, and similar merchandise. At the rear can be found the "package" items, such as phono players, turntables, portable sets, PA equipment, and the lower priced tape and wire recorders. The staircase at the left of the photo leads to the studio floor, one flight up, where most of the hi-fi equipment is to be found.

The Studio Floor

The second floor consists of three rooms—two studios which are essentially identical, and the entrance foyer. This latter, shown in *Fig. 3*, provides a comfortable waiting room so that each visitor may have the use of a studio all to himself, so to speak, during his demonstration. Here, too, is a display of a typical system in a typical living room environment—one which might give the customer some ideas that he could incorporate into his own home, unless he has planned his own system thoroughly in advance.

As the customer enters the demonstration studio, he is faced with practically every amplifier, speaker, tuner, record player, and tape recorder on the market, all arranged for ease of interconnection so that any combination of equipment can be heard—just name it and you can hear it. But the unique part of the demonstration floor is that there are two—count 'em, two—studios, almost identical. Both are soundproof, both are air conditioned (as is the entire store), and both equipped with the same demonstration set-up. Thus it is possible for the customer to hear the equipment in which he is interested without interference from some other customer—or, conversely, without interfering with some other customer. With audio becoming such an important part of everyday life, the traffic in most demonstration rooms is becoming so great that it is almost impossible to enjoy a demonstration without at least one "kibitzer."

Figure 4 shows one of these demonstration-studios as seen from the foyer. At the back can be seen the "Merry-Go-Sound," a new idea developed by Charles M. Ray, manager of the sound division of Arrow Electronics, Inc. This unit provides space for 24 different loudspeakers to permit comparative selection. These speakers are mounted six on a side, and the entire unit rotates—controlled remotely from the switching panel—to face six different speakers toward the listener at a time, thus making choice of speaker perform-

Fig. 1 (below). Exterior of Arrow's new Audio Center, located in the heart of New York City's famed Radio Row at 65 Cortlandt Street. Two floors of Audio indicate that Audio has come of age.

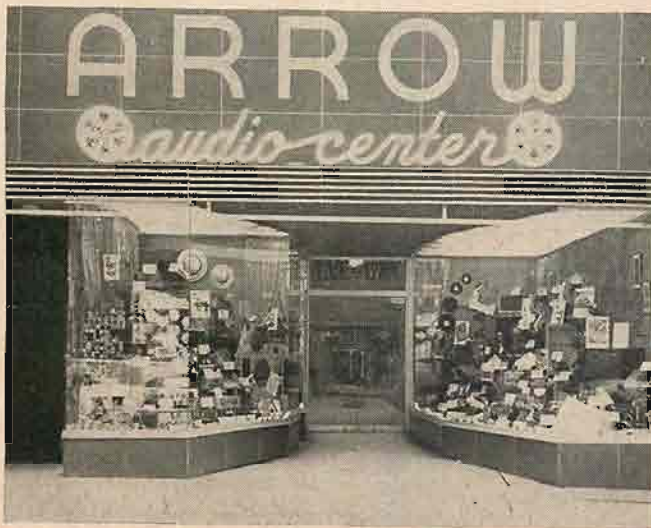
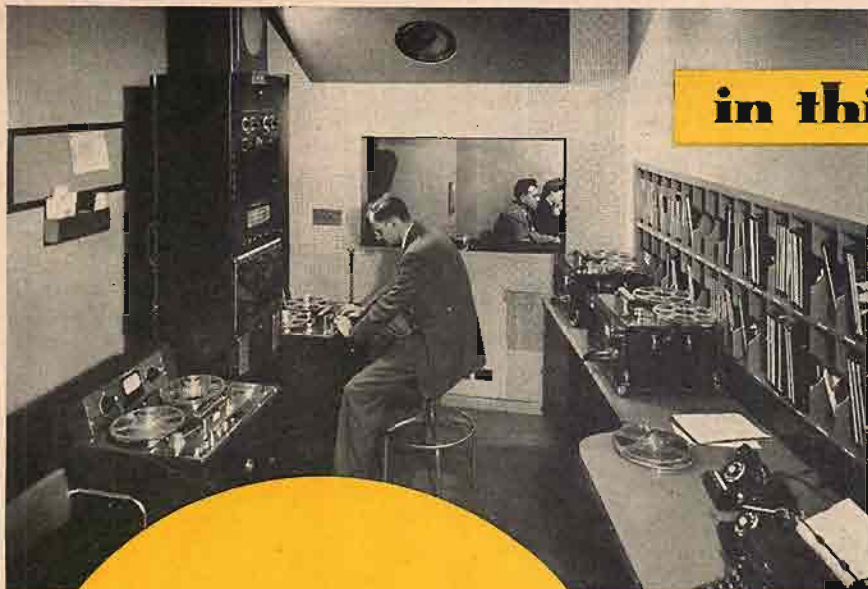

Fig. 2 (above). First floor showroom of the Audio Center, where the customer may buy a replacement stylus for his phonograph pickup—or a complete portable phonograph—or most any audio accessory.



in this room...

there's no room for doubt

There can be no room for doubt in the continuity and fidelity of your broadcast. Precisely the reason you demand—and get—the best in transmitting and studio equipment.

Nor should you compromise with quality in the tape recorder you select.

In AMPEX Recorders you will find the same matchless reliability and performance you expect of your transmission equipment... and for the same reason—they are engineered to the highest *professional* standards.



AMPEX

brings you these cost-saving operating advantages:

- **UNINTERRUPTED SERVICE**

Under the demand of heavy-duty programming, AMPEX Recorders deliver thousands of hours of unbroken service. Recently a set of AMPEX heads was returned from Honolulu for routine replacement after 11,000 hours continuous use, 17 hours a day. The heads were still within AMPEX specifications for new heads and had several thousand more hours of use remaining.

- **MINIMUM "DOWN TIME"**

AMPEX Recorders are designed for thousands of hours of continuous operation with minimum "down time," resulting in low maintenance costs and protection from sudden broadcast failures.

- **ACCURATE TIMING**

AMPEX split-second timing accuracy protects your programs and commercials from embarrassing time overlaps.

- **HIGHEST FIDELITY**

Even when programs are repeatedly transcribed from one tape to another, there is no noticeable build-up of noise level, "wow" or distortion.

- **LONG LIFE**

AMPEX Recorders are designed and built for years of service dependability. Its recordings match established NARTB standards. When you have an AMPEX, you have a machine built for years-ahead performance.

IF YOU PLAN FOR TOMORROW, BUY AN AMPEX TODAY

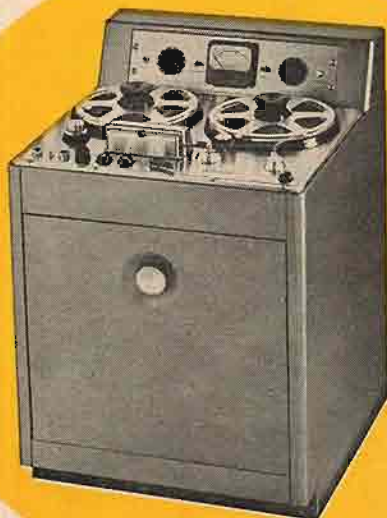

AMPEX

MAGNETIC RECORDERS

AMPEX ELECTRIC CORPORATION
934 CHARTER STREET • REDWOOD CITY, CALIF.

But, unfortunately, one stairway led directly into the blazing fire area on a lower floor, and many of the children were trapped. It was not possible to modify the pre-defined alarm signal to direct the entire floor to use the safe stairway.

There is also the uncontrollable psychological reaction of undrilled people to the wail of the siren, the clang of the alarm bell, and the startling staccato of frenzied whistle blasts when these signal devices are restricted to emergency warnings. In American life these sounds mean danger. Coming with sudden unexpectedness, they shock the heart with apprehension. The first reaction is to drop everything and run—unorganized—anywhere. Even when their use is restricted to disaster signals, and all are well-informed of their meaning, they breed fright and terror, particularly where masses in enclosed areas are involved. Nothing can be more serious in factories, office buildings, apartment houses, and other structures housing many persons and having a limited number of elevators and exits.

The great uncorrectable weakness of these signals lies in the uncertainty which follows their use and their inability to follow through with detail instructions that everyone can understand and follow with confidence. This weakness, more than any other, is making coded signals unacceptable in the new tense Defense Era that has been ushered in by the Atomic Age.

The Logical Solution

To survive in this new era, we are going to have to rely upon many coordinated precautions. There seems to be only one way to achieve this vital coordination at the civilian level—local communication networks of loudspeaking electronic systems that can sound the standard alert signals and then follow through with detailed *spoken* instructions which will calm human fears and direct orderly teamwork under any emergency situation.

Consider the many situations which may have to be dealt with in a medium-sized plant or office building in case of enemy air attack, and how a Voice Sound System throughout the premises would be the Defense Coordinating Officer's most valuable tool for minimizing danger to human lives and company property.

Here are some of the directions the Defense Coordinator—acting as a master dispatcher—must get over quickly, clearly, and in a manner to inspire confidence:

1. Sound the standard alert signal to gain attention. Then follow through with a vocal explanation to assure that everyone, including visitors, understands the significance of the signal. By being able to give a spoken explanation, it is less necessary for drills on costly company time.
2. Call upon workers to shut down their machines, unplug soldering irons, turn off chemical processes, and so on, before leaving their posts, to prevent possible fires or other damage while unattended.

Only at-the-moment voice instructions can assure this being done.

3. Direct people, including undrilled visitors, to different safety shelters; and then possibly re-direct them, later, to other shelters because of the development of close-by danger. Simple signals could never do this.

4. Caution employees and the public to move in an orderly manner to their designated shelters so as to restrain hysteria or stampede. Recently there has been released a 16-mm film entitled "Target U.S.A." designed to instruct plant employees how to act under conditions of an enemy air attack. The film portrays the sounding of the air raid alarm and the wild rush to designated shelters. It shows developing panic as people madly scramble through bottle-neck doors and corridors, but only the commentator in the film is able to caution the rushing mob to "take it easy." How simple it would be if the Defense Coordinator, with the facilities of a Voice Sound System, could do this very thing.

5. It will be easier to confine people in shelters for a prolonged time if the Defense Coordinator can cut in on shelter loudspeakers periodically and reassure the occupants. If this is not done, uncertainty may breed panic. The situation is no different than that on a man-o'-war in battle, when the battle announce system is used every few minutes to acquaint those below deck how the fight is going. Knowledge that the rocking blast on the port side was close but not damaging makes it a hundred times easier to stick to their posts.

6. Call rescue workers from one part of the premises to another to administer to first-aid cases resulting from either attack or hysteria. The need for more stretchers or more smelling salts can be communicated only by spoken directions.

7. Direct trained and equipped crews direct to points of need, such as to turn off broken water, chemical, or electrical mains or to prevent other equipment hazards that might develop while unsupervised.

8. Instruct the Wardens to vary ventilating controls throughout the premises in the case of radiological, chemical, or biological attack, or to provide isolation of highly combustible materials in case of fire or explosive attacks.

9. Route de-contamination crews from point to point to clean up hazardous conditions and report on their safety.

10. And last, to call on wardens and emergency crews to report back and assure that safety exists before the All Clear signal is sounded and employees or public are allowed to return to their normal activities.

Sirens, whistles, horns, bells, gongs and buzzers—even when ably supplemented by telephone and message runners—cannot do this man-sized job. They are as puny as voice tubes.

Up-to-Date Requirements

A loudspeaking electronic system capable of transmitting the standard Alerts, plus Voice and Music, is required in every good-sized building to discharge the safety responsibilities of this new Atomic Age. Sound Systems designed to perform this special service have been dubbed "Survival Sound Systems"—not a warning system, not a disaster system, but a system designed for Survival.

In addition to being built to life-saving specifications, such a system also can

serve day-in-and-day-out the purpose of an ordinary sound system, as an efficiency tool of limitless application in routine industrial and commercial operations.

Design Needs

The requirements of a Survival Sound System are much more demanding than those of an ordinary sound system. Its serious purpose allows little leeway for compromises in performance or price. The audio engineer planning such a system should bear the following uppermost in mind:

1. Major emphasis on speech intelligibility. Particular instructions may be issued only once; 20 per cent of the personnel may be hard of hearing, but every syllable must be instantly understood as it may mean life or death. It cannot be chanced that anyone will misunderstand instructions and run directly into the arms of disaster instead of running the other way. The best quality of equipment only will suffice—quality as relates to reliability as well as reproduction. No junk, typical of many systems for paging or music distribution use where it matters little if listeners understand only 50 or 60 per cent of the words pronounced.
2. Loudspeakers must be installed liberally, with horn types used in locations of high noise level. In addition to usual locations, speakers must also be installed in toilets, washrooms, warehouses, loading platforms, corridors, elevators, basement storage areas, and parking lots.
3. Switching provisions should be provided so that loudspeakers can be controlled by zones. It should be possible to talk to people confined in shelters separate from plant-wide direction of emergency crews. Likewise, if the Defense Coordinating Dispatcher knows that the first-aid crew is operating in Zone A, it should be unnecessary to call to all other zones to re-direct the crew to a need in another location.
4. Since many of the above speaker locations will not be utilized in routine day-to-day use of the sound systems, priority circuits must be provided whereby all speakers can be actuated and any special speech equalization cut in, in cases of emergency.
5. Microphone inputs must be provided at the Building Defense Control Center, plus inputs on each separate floor and in each building, as well as in important areas of large enclosures from which it might conceivably be desirable to direct defense activities.
6. Consideration should be given to providing emergency speaker circuits for carrying on, should one of the main circuits be damaged. This might be accomplished by wiring all circuits as loops so that input can be provided from either end.
7. An auxiliary power supply must be provided for use should the standard power mains become inoperative. Gas-driven generators appear most appropriate. The size of auxiliary power plant to operate a Survival Sound System will often be only a fraction of the size of power plant that would be required to operate other types of signaling systems.

Modifying Present Systems

Existing sound systems can profitably be resurveyed and brought up-to-date to meet these Survival System standards.

how **BIG** is the **BEST** in plug-in audio amplifiers?

— only **3½"** of standard panel space
IF you use the **NEW Langevin 5000 Series**

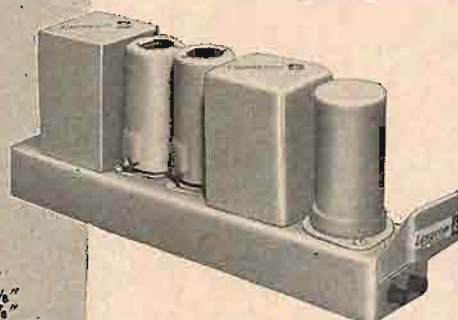

LENGTH: 9"
WIDTH: 1¾"
HEIGHT: 3¼"
WEIGHT: 1 lb. 1 oz.

TYPE 5116 AMPLIFIER
• 11 will fit across standard rack •

TYPE 5117 AMPLIFIER

A plug-in, low-noise, low-distortion, fixed-gain unit for use as a program monitor or booster amplifier in broadcast audio facilities, recording, or sound systems.

Gain: 55 db, fixed.

Input source impedance: 150/600 ohms, center tapped.

Output load impedance: 150/600 ohms, with center tap on 600 ohm position.

Output noise: equivalent to input signal of -110 dbm or less.

Output power: +30 dbm (1 watt) with less than 0.5% RMS total distortion from 30 to 15,000 cps; 39 dbm (8 watts) with less than 1% RMS total distortion from 50 to 15,000 cps.

Frequency characteristic: ±0.5 db from 30 to 15,000 cps.

Power requirements: 70 ma DC at 300 v, 1.2 amps at 6.3 v.

Tube complement: two Type 6V6, two Type 5879.

TYPE 5117 AMPLIFIER

• 6 will fit across standard rack

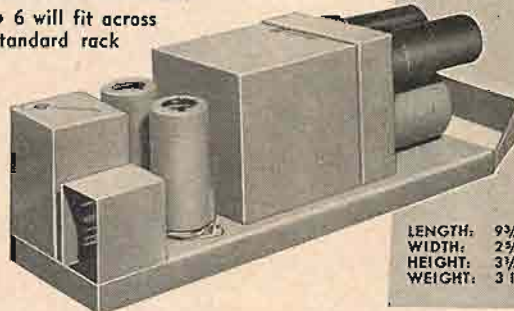

LENGTH: 9¾"
WIDTH: 2¾"
HEIGHT: 3¼"
WEIGHT: 3 lbs. 13 oz.

TYPE 5206 POWER SUPPLY

A plug-in unit capable of powering as many as 22 Type 5116 pre-amplifiers, or 10 Type 5116 pre-amplifiers plus two Type 5117 monitor amplifiers.

Load current: 210 ma DC at 300 volts.

Filament current: 6.5 amps AC at 6.3 volts.

Ripple: less than 2 millivolts pre-amplifier supply, less than 10 millivolts monitor amplifier supply.

Power requirements: 105-125/210-250 volts, at 50 to 60 cps.

Rectifier: two type 5Z4 tubes.

TOGETHER FOR THE FIRST TIME! Compactness beyond belief

• Top broadcast quality • Balanced output • Low-impedance input • Plug-in construction • Gold-plated plugs • Only 3 tube types • Tube-pull without plug-out • Plate-current-check switches.

Why not try Langevin for your transformers — custom-built to commercial or MIL-T-27 specs. Fastest delivery in the country on test samples!

SEE US IN ROOM 531 AT THE 1952 AUDIO FAIR

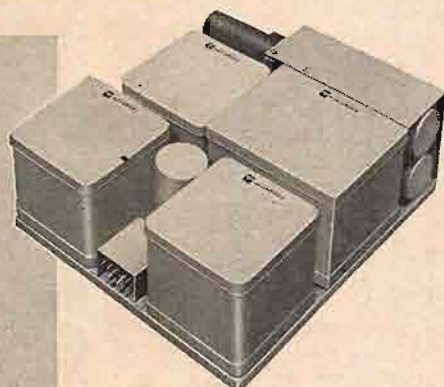

LENGTH: 9¼"
WIDTH: 7¾"
HEIGHT: 3½"
WEIGHT: 17 lbs. 6 oz.

TYPE 5206 POWER SUPPLY
• 2 will fit across standard rack •



means the finest in audio components.

LANGEVIN MANUFACTURING CORPORATION • amplifiers • transformers • power supplies 37 WEST 65TH STREET NEW YORK 23, N.Y.

Nuclei now exist in many forms which can be built up readily to provide Survival Sound System service. For instance, the addition of microphones, plus loudspeakers in shelters and other working areas of existing wired-music systems in restaurants, hotels, and offices would convert these to valuable warning and direction systems. The same applies to the already existing high-quality sound systems in motion picture theatres.

The trend towards discarding simple signals within buildings is only part of the "No Coded Signals" story. The same arguments that favor loudspeaking electronic systems within enclosures apply with equal force to outdoor warning systems for general public use.

Siren, whistle, and horn air-raid warnings only alarm, confuse, and incite panic. Their weakness lies in the uncertainty which follows their initial sounding. They cannot follow through with explicit instructions; they cannot reassure; they cannot tell the populace what to do should an unanticipated emergency occur requiring action other than that for which people have been drilled. These systems are costly to install, and, being mechanical, are relatively troublesome and unreliable. To provide them with an emergency power supply is impracticable.

Many Civil Defense officials are dissatisfied with the siren, even as an alarm device because of the possibility of confusing siren-generated Attack Warning Signals with other established emergency services. Sirens have been used for years by police, ambulances, volunteer fire departments, and penal institutions. Since all sirens sound substantially the same, disastrous mis-cues are possible.

An all-electronic public Warning System could easily sound an endless variety of distinctive non-confusing signals and at the same time offer the answer to other deficiencies of the siren. However, it appears unlikely that entirely practical electronic systems can be offered until engineering study resolves some of the well-known vagaries of transmitting sound and intelligible speech over large outdoor areas.

Under conditions of good transmission, outdoor sound can be heard many miles, while under other normally-to-be-expected weather conditions the range of the same sound may be reduced to a fraction of a mile. Building obstructions cause garbling due to reflections and dead areas due to acoustic shadows. In concentrated areas of people and traffic activity, the ambient noise which must be pierced is high and variable. These adverse factors are most troublesome in congested downtown business areas where buildings are tall, streets narrow and canyon-like, and traffic heavy.

It seems probable that such business areas can be covered reliably only by relatively low-level systems consisting of many loudspeakers at frequent locations. Two low-power horn-type speakers pointing in opposite directions at each street intersection could do the job of blanking each block with the stand-

ard alert signals, even through the heaviest traffic noises, and should understanding of subsequent voice instructions be difficult, people could quickly approach the nearest speaker, which never would be further away than a few hundred feet. If efficient speakers are used, a centrally located, remotely controlled 1-kw amplifier could feed speakers enough to checker-board an area of 100 street intersections. This would be sufficient to cover the business sections of most cities, and the number of units required for the largest cities would be within reason.

High-Level Systems

So much for low level systems. It is the high level system consisting of a few high power loudspeaking units at widely spaced locations that seems to have the most glamour appeal to municipal authorities, possibly because it mimics the existing siren practice.

The high level system poses two big engineering questions: First, can it communicate intelligible speech reliably over appreciable outdoor areas, even in residential sections? And second, can existing electronic equipment economically reproduce the required acoustic levels?

There seems to be a plausible answer to the first question. It is proposed that intelligence should be possible under adverse conditions if the message is limited to phrases of only two or three words, and these discreet phrases repeated over and over many times. For instance, it might be desirable to follow the standard warning signal with information to prepare for a fire bomb attack. The word "fire" could be repeated over and over again many times. If it should be expedient to instruct the populace of an entire area to evacuate in a certain direction, the words "Go North" could be repeated over and over again until it was reasonably certain that all people outdoors understood.

The second question, of whether present-day electronic systems can put out adequate acoustic power, is another matter, particularly in view of the fact that Civil Defense officials are continually crying for louder and louder signals. It appears probable that electronic systems can be put together with presently available equipment which will provide as strong a signal as a 2- or possibly 5-h.p. electric siren, although at an unfavorable cost ratio of two or three to one. Such systems might have a reasonably reliable radius of a quarter or maybe half a mile. Electronic systems to compete with high pressure air horns, high pressure steam sirens, and high horsepower gasoline-driven air sirens are entirely out of the question.

Conclusions

In closing, it is important to reiterate the seriousness of our immediate National Defense task and to cite two specific examples where audio can make important contributions.

[Continued on page 69]

PILOT

High Fidelity Instruments

available through these
fine distributors

CALIFORNIA
Burbank: Valley Electronic Supply Co.
Hollywood: Hollywood Electronics
Long Beach: Fred S. Dean Co.
Los Angeles:
Calif. Radio & Electronics Co.
International Radio & Television Parts Co.
Radio Products Sales, Inc.
Radio Recorders Equipment Co.
Universale Radio Supply Co.
Oakland:
W. D. Brill, Co.
Electric Supply Co.
Millers Radio & Television Supply
E. G. Wenger, Co.
Pasadena: Dow Radio, Inc.
San Francisco:
Eis-Hokin & Galvan
Hal Cox Co.
San Francisco Radio & Supply Co.
Television Radio Supply Co.
Wholesale Radio & Electric Supply Co.
CONNECTICUT
New London: Aikins Electronic Supplies, Inc.
DELAWARE
Wilmington:
Almo Radio Co.
Radio Electric Service Co. of Penna.
FLORIDA
Pensacola: Grice Radio & Electronic Supplies
ILLINOIS
Chicago:
Allied Radio Corporation
Newark Electric Company
IOWA
Des Moines: Radio Trade Supply Co.
MARYLAND
Baltimore: Wholesale Radio Parts Co., Inc.
MASSACHUSETTS
Boston:
Harty & Young
Radio Wire Television Inc.
The Radio Shack Corp.
Springfield: Regent Sales Inc.
MICHIGAN
Detroit: K.L.A. Laboratories, Inc.
MISSOURI
Kansas City: Burstein-Appelbee Company
NEW HAMPSHIRE
Concord: Evans Radio
Manchester: Radio Service Laboratory
NEW JERSEY
Atlantic City: Almo Radio Co.
Camden: Almo Radio Co.
Newark:
Aaron Lippman & Co.
Emerson-New Jersey, Inc.
Radio Wire Television, Inc.
Red Bank: Monmouth Radio Supply Co.
NEW YORK
Albany: Ft. Orange Radio Distr. Co.
Brooklyn:
Acme Electronics
Benray Electronics Corp.
Electronic Equipment Co., Inc.
Hempstead:
Davis Electronics Corp.
Hicksville: Gem Electronics Distributors, Inc.
Jamaica: Peerless Radio Distributors, Inc.
New York City:
Arrow Electronics, Inc.
Bruno, New York
Consolidated Radio Sales Corp.
E. W. Associates, Inc.
Federated Purchasers
Harrison Radio
Harvey Radio
Hudson Radio & TV Corp.
Leonard Radio, Inc.
O. & W. Radio Co.
Radio Wire and Television, Inc.
Sun Radio & Electronics Co.
Terminal Radio Corp.
Rochester: Rochester Radio Supply Co.
White Plains: Hi Fidelity Center
NORTH CAROLINA
Raleigh: Southeastern Radio Supply Co.
OHIO
Akron: Olson Radio Warehouse, Inc.
Cincinnati: Steinberg's, Inc.
Cleveland: The Progress Radio Supply Co.
OREGON
Portland: Hawthorne Electronics
PENNSYLVANIA
Allentown: Norman D. Steedle Co.
Easton: Radio Electric Service Co. of Penna.
Philadelphia:
Almo Radio Co.
Radio Electric Service Co. of Penna.
Scranton:
General Radio & Refrigeration Co.
Scranton Radio & Television Co.
Wilkes-Barre: General Radio & Electronic Co.
York: York Radio & Refrigeration Parts
RHODE ISLAND
Providence:
Wm. Dandreta & Co., Inc.
W. H. Edwards Co., Inc.
TEXAS
Dallas: All-State Distributing Co.
Ft. Worth: Fort Worth Television Service
WASHINGTON
Seattle: Seattle Radio Supply, Inc.
WASHINGTON, D. C.
Electronic Wholesalers Inc.

PILOT

World leader and pioneer in electronics...
introduces brilliant new
High Fidelity line!



NEW
PILOTUNER
FM-AM TUNER

PILOT... world renowned for 33 years as the *last word* in precision electronics...

PILOT... favored communications equipment of engineers, navigators, experts in the field...

PILOT now puts its wealth of know-how into the most brilliant FM-AM Tuner ever built! Nothing has been spared to make the new PILOTUNER truly the *ultimate* among Hi-Fi Tuners. Space permits listing only a few of the many outstanding specifications, which include:

- two stage audio amplifier with bass and treble control units
- two stage preamplifier properly equalized for use with variable reluctance cartridges
- RF stage for improved sensitivity and selectivity
- automatic frequency control. A remarkable value at ... **\$99.95**

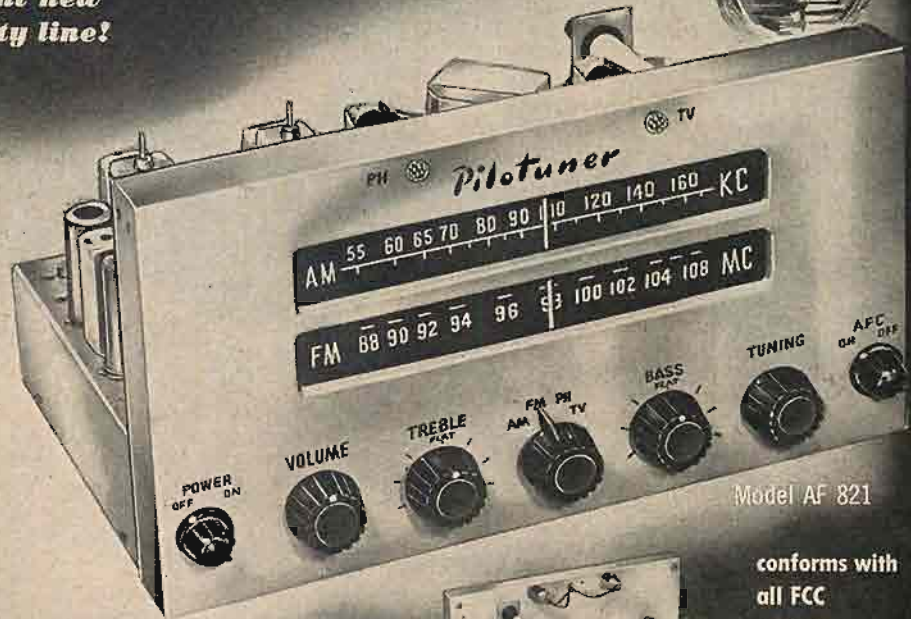

Model AF 821

conforms with
all FCC
radiation
specifications



High Fidelity PILOTONE Amplifier

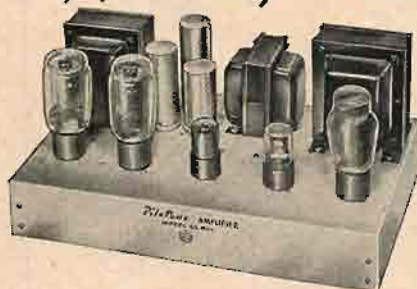

Model AA-901

Superb new amplifier with full Williamson circuit. Constructed in accordance with rigid Pilot specifications. Contains 4 amplifier tubes, 1 rectifier tube. Power output, 10 watts. Total harmonic distortion, less than .1% at 10 watts output. Sensitivity, 1.5 volts RMS input for rated output; input resistance 470,000 ohms. Speaker output, 8 and 16 ohms. Front Pilot light; on-and-off switch. Hum and noise level 80 db. below full rated output. KT 66 English Tubes. Dimensions: 14" wide; 7" deep; 7½" high.

A luxury instrument, priced at **\$99.50**

High Fidelity PILOTONE Pre-Amplifier



Model PA-911

A companion unit for PILOTONE AMPLIFIER Model AA 901. Selector switch allows quick choice of Auxiliary, TV, Radio or Phono inputs. Three positions of switch for phono input give proper compensation for records made to AES, NAB and foreign standards. Seven input jacks on back permit quick connection of various types of signal. Separate microphone input channel permits voice to be superimposed on radio, TV or phonograph. 12" long x 5½" x 5½".

An exceptional "buy" at **\$29.95**

The Pilot High Fidelity line is discussed and appraised in the practical new book, "High Fidelity Simplified," by Harold W. Weiler

Write for circular AE-1 describing these superb PILOT High Fidelity Instruments in complete detail.

PILOT RADIO CORPORATION, 37-06 36th St., Long Island City, New York

RECORD REVUE

EDWARD TATNALL CANBY*

Bass-Shy

BASS AND MORE BASS. The trend towards highs and more highs, which eventually went supersonic and so reached a relative equilibrium, is now replaced by the rush to the lower regions—along with the happy interest in small enclosures that began a year or so back.

How much bass do we want for home music? Let me say, in a few words, that I'm rapidly beginning to think we don't want "all" of it. I'm not speaking particularly of those last few bottom cycles, which like the ultra-top ones are not really of much importance in actual music (witness the difficulty of finding a "good 30-cycle bass" recording). I mean the really important bass, below that available in most good bass reflex enclosures and above too, the whole lower area, "flat," relatively, instead of peaked.

No question about the desirability of non-peaked bass. Resonances, peaks of any old sort, make for distortion. Musical distortion. Just as bad, humpy bass leads to rumble and boom from turntable motors. The best sign I know of true bass response is (a) unusually low rumble and bumble along with the big low notes and (b) similarly, a very natural, unboomy reproduction of the speaking voice. Peaked bass, à la jukebox, brings out rumble and makes a travesty of the voice.

No question, either, that from an engineering viewpoint we must strive towards the nearest thing to perfectly "flat" bass reproduction that ingenuity can devise.

But music listening, especially in the average smallish room is, I'm increasingly convinced quite another matter. Nine tenths of our listening is essentially artificial; we have no literal reproduction, quite aside from the vital absence of the binaural. We reproduce, from a single point, sounds that not only were "wide" in the original but are intended for much larger rooms, halls, at greater distances. We project the recording hall liveness into our own rooms for a double liveness effect. Altogether, a thoroughly garbled reproduction, from any literal point of view! But we are not out to be literal, luckily.

And so, with my first good try at two of the new inexpensive enclosures for 8-inch

speakers, the RJ bookshelf model and the EW modified bass reflex (16"×11"×14"), my conclusions are not quite what might be expected. I'm getting bass-shy.

Balance

The most obvious necessity, when it comes to big bass, is balance—an equivalent range and force of highs. The musical ear is far more sensitive to an imbalance of highs and lows, about a central pitch, than it is to any lack of either. Cut off the highs and lows both, and you have the average small phonograph or radio which pleases millions musically, and with good solid reason. Add more highs, you need more bass, and vice versa.

The RJ, 8-inch, as elsewhere described in this column, adds a lot more bass. My ear quickly tells me without measurement that this small box gives me more of the stuff than my old 15-inch bass reflex set-up! But, in this case, though the Wharfedale speaker has the highs to match, there is a very slight attenuation, due to the RJ principle itself. Very slight, I emphasize, on direct comparison with the same speaker in the EW direct radiator.

The EW enclosure (with internal baffles that lengthen the path and remove parallels) gets extraordinary bass for its size, far more than most large home consoles and as much as larger 12 inch bass reflexes; but not as full or as low a bass as the RJ 8-inch.

How do these two compare in a home AB listening test.

First let me throw out a much-needed scale of values here. With the Wharfedale or Permoflux, or undoubtedly with other new 8-inch speakers such as the University Diffusicone, both these boxes give a quality and fullness of musical sound that is absolutely amazing to any person not conversant with super hi-fi equipment in the large. Far better than the fanciest standard home machine I've ever heard. Easily equal to the sound of many a larger hi-fi system of past years. Volume enough for 95% of musical people, listening in homes. Distortion low enough to allow for hours of unfatigued listening. As representatives of the new trend, both these boxes (I have unfinished models, bottom priced) rate very high in the scale of musical value.

The RJ 8-inch bass on many works with big bottom, notably organ music, heavy brass and kettledrums and the like, is hard to believe. (Give Wharfedale credit too.) A sensation. The RJ's bass is relatively so huge that a really high powered high range is necessary for ideal tonal balance. This little RJ is up in the former area of the 15-inch speaker, where a tweeter was *de rigueur*. On the other hand, the EW, with somewhat less bass and a shade more in the highs, is perfectly balanced for music. Here we run into a whole new set of balance problems, created by the new areas of bass reproduction now available.

Boom

But there is more to this than balance. Big bass is extremely touchy in any room which is smaller than that in which the original music might have been played, due to standing waves and other multiplying annoyances.

It is musically risky, I feel, to introduce really low bass into any small room or even into a medium-large room of the usual home sort. It may be fine. But then again, it may not at all. Strange and disturbing booms, shakings, peaks are more than likely and, though a technician may overlook them, most musical people will be decidedly annoyed. Nothing is more distracting than a persistent resonance in the bass—and it's a lot worse in the room than in any cabinet; your ears are right in the middle of it.

RJ suffered from this at last fall's Audio Fair in the confined space of a hotel room. In my large summer cottage room, two stories high with a balcony opening off and a peaked ceiling—not the sort of room you'd expect to cause trouble—the RJ 8-inch nevertheless set off some noticeable and distracting low-bass booms on piano and other records. I am quite certain they were in the room itself. Moving the speaker changed them. The EW enclosure, with less low bass, stirred the same booms up, but to a definitely lesser extent and with less conscious annoyance in the listening.

The low-bass enclosure, in one or another of its forms, expensive or budget-priced, is bound to incur a rash of criticism on this score in the coming months, as the customers try out the bottom cycles in their

* 279 W. 4th St., New York 14, N. Y.

THE MOST WANTED REPRODUCER

For it is a fact, that of the thousands of AUDAX users, more than 70% bought the AUDAX POLYPHASE—even though they already owned other makes of pick-ups.

The revolutionary new records are so true to the original that almost any pick-up is bound to give some results . . . but—it takes a reproducer of the highest order, one sensitized to the nth degree . . . a CHROMATIC POLYPHASE—to bring out every subtle shading, every nuance so essential to the real music of which these discs are capable.



Available to fit the new compass-pivoted AUDAX arms and to fit record changers.

Never before such LISTENING-QUALITY, such FAITHFUL REPRODUCTION but YOU and only YOU can decide what sounds best and most pleasing. Therefore . . . SEE and HEAR POLYPHASE and—YOU be the judge.

One single magnetic unit plays all home records—replaceable Sapphire or Diamond styli.

Be sure to obtain a copy of 1953 ELECTRONIC PHONO FACTS from your distributor.

AUDAK COMPANY

500 Fifth Avenue New York 36

Creators of Fine Audio-Electronic apparatus for over 25 years.

"The Standard by Which Others Are Judged and Valued"

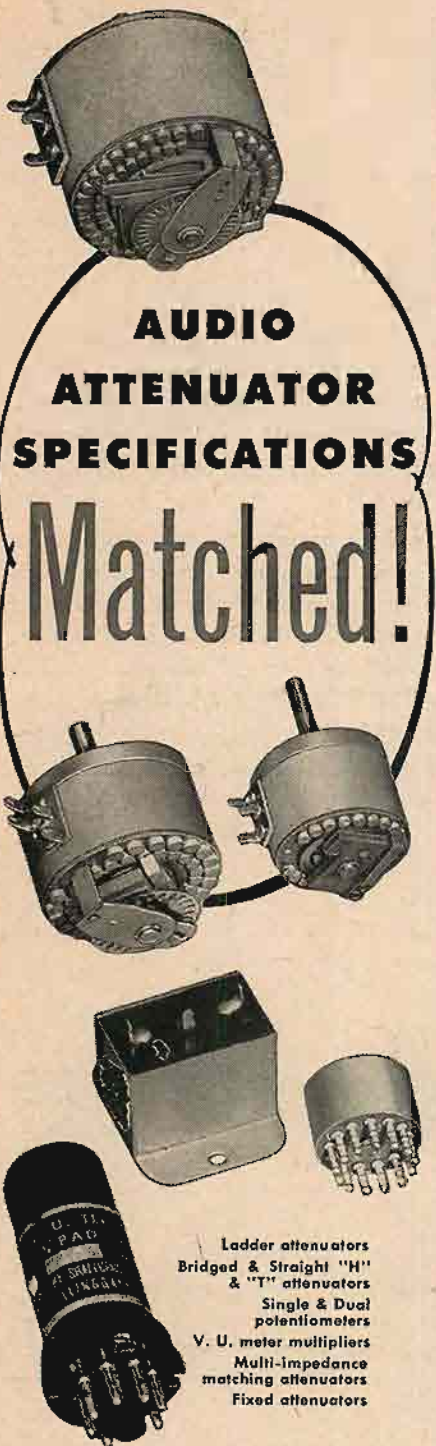

Shallcross offers a complete line of over 200 standard fixed, rotary-step, and key type attenuators to match practically any audio requirement. Complete facilities are also available for making custom-built units to specifications.

Shallcross

MANUFACTURING COMPANY

Collingdale, Penna.

small rooms. How much of it will be misdirected to the enclosure, when the room is the cause? Musically you cannot pit low bass resonances against not-so-low bass that is both balanced and unresonant. The musician will pick the latter every time.

Maybe what we need is a variable bass cut-off in our amplifiers!

The post office is not geared to summer travel and this department, operating remote-control from the country, receives a strange collection of those records which manage to survive the forwarding process—reflecting the persistence of the more enterprising sales offices who will not accept shipping defeat! Musically unrepresentative, but interesting just the same. By next month, no doubt, the fall flooding of discs will be digested to the point of description in this space—it takes time to listen. (And plenty of record dealers won't be getting the stuff in stock until months after the announcements. Just like audio equipment!) Here's what's new at the moment.

Goldsand

Schubert, Sonata in A, Op. 120; Moments Musicaux, op. 94. Robert Goldsand, piano. Concert Hall CHS 1148

Schubert, Impromptus, Op. 142. Goldsand. Concert Hall CHS 1146

Brahms, Variations on a Theme of Paganini, Books 1 & 2, op. 35. Goldsand. Concert Hall CHS 1147

Liszt, Six Grandes Etudes after Paganini. Rachmaninoff, Variations on a Theme of Chopin, op. 22. Goldsand. Concert Hall CHS 1149

An unusual piano series, matching the man to the music—as the large companies often fail to do. Goldsand is a fiery Romantic in the old sense; no apologies, no streamlinings—he takes the old boys' hair-in-the-eyes stuff as it was intended, plays it to the hilt. It's remarkable how fine the Romantic outbursts sound when they come through full power! A sensitive musician and a terrific technician, Goldsand is ideal for the biggest, loudest piano music of this type.

Liszt, Brahms, Rachmaninoff are his best meat—full blown piano. His Schubert is lovely—bringing out the more Romantic side, both the weighty pauses, the pregnant key-changes, and the stormy passages. Goldsand makes the most of the impressive but not overly profound Liszt and the gloomy Rachmaninoff variations, (on an ultra-familiar Chopin theme)—to please the touchy hi-fi fan. The Brahms and Schumann disc offers weightier fare, the Brahms a famous pianist's virtuoso piece here played effortlessly, the Schumann a tremendous and lengthy early work, hard to pull together into coherence, and beautifully flowing in Goldsand's understanding interpretation.

Excellent piano recording, a bit on the hard side with a few touches of false transient sound in the louder tones, a bit of waver here and there. Big, natural sound more than makes up for it.

Badura-Skoda

Schubert, Eight Impromptus, op. 90-142. Sonata in A, op. 120. Paul Badura-Skoda, pf. Westminster WAL 205 (2)

Mozart, Violin and Piano Sonatas, K. 377, K. 305, K. 58. Badura-Skoda and Walter Barylli, vl. Westminster WL 5145

Beethoven, Piano Concerto #4. Badura-Skoda; Vienna State Opera Orch. Scherchen. Westminster WL 5143

Another pianist of outstanding ability in the musical way, here featured in several continuing series, including his own solo work. As Goldsand centers best upon the middle to late fiery Romantics, B-S fits beautifully at an earlier focus, his best work being Mozart, to my ear, and Schubert, the early Romantic. The two men overlap very interestingly in the Schubert A major so-

nata (above). Goldsand finds Schubert not quite big enough sounding, brings out the bigger moments, emphasizes the larger Romantic mood, of which Schubert was a great pioneer. B-S brings out the equally important delicacy, the classic directness and simplicity of Schubert. Two very different interpretations—but both highly musical and decidedly valid.

The B-S Mozart sonatas, emphasizing the piano, are tops in that instrument; Barylli's violin is sweetly but not very forcefully expressive. (Try the old Krauss-Goldberg versions, Decca LP reissue, for top Mozart fare.) The familiar Beethoven Concerto is unexpectedly fine in this Scherchen-B-S collaboration; perhaps it is B-S who gives it a simplicity, a casualness, that is too much lacking in the self-consciously noisy performances we are used to. Few performers can do Beethoven without being stage-struck, like every actor when he gets to "to be or not to be!"

Recording? By Westminster—enough, now, to insure high quality. The solo B-S piano is a bit bass-heavy; I suspect a mike somewhere underneath the sounding board. But the top is liquid and natural, no false percussions. The sonata puts the violin rather surprisingly in the background, the opposite fault usually being the case. The concerto is beyond criticism.

Bach, the Arranger

Bach, Brandenburg Concertos #2 and #4. London Baroque Ensemble, Karl Haas.

Westminster WL 5113
Bach, Keyboard Concertos (Harpsichord) #3 and #6. Maria van der Lyck, hps.; Ton-Studio Orch., Michael.

Period SPLP 547

Bach's keyboard concerto #6 in F will amaze many Bach listeners—for it is the 4th Brandenburg, for two recorders, in a Bach arrangement, designed for his own use. The original was for two recorders and violin, in G; the arrangement substitutes the harpsichord for the fiddle, F for G, and Bach revamped much of the detail to allow the keyboardist (himself) to shine. If you think that the modern arranger is a mere skilled technician, you are right; Bach combined skilled arranging with skilled composing, and did both almost day by day.

The two Westminster discs are brought together and re-cut from earlier sides on two different records. The Period is part of the recent Stuttgart Ton-Studio series of Bach and Mozart. Both use the correct—and colorful—original instruments, recorders instead of flutes, harpsichord instead of piano. Gorgeous recording and perfect for hi-fi reproduction. Of the two, the Period is the heavier and more solid, a bit plodding, the Westminster players are light-footed.

Hi-Fi Froth

There's plenty of easy hi-fi listening for those as wants it, especially in the newly popular short LP 10-inchers at lower prices—just possibly intended to meet Remington and similar competition. Decca's 4000s and Columbia's AAL series are typical.

Operatic Arias played by Camarata and His Orch. (No voices!) Decca DL 4008

Romantic Reveries (organ). Virgil Fox. Columbia AAL 18

Dinner Music—Sigmund Romberg & His Orch. RCA Victor 9019

Three schmaltzy representatives of good recording—vocal arias without the voices (but with all the juice retained and sugar added), war-horse reveries for the biggest of organs—both the wedding marches, and more of the same—and, for those who like it (ugh—pardon me), the Best of Romberg with a huge, semi-jazz pops orch. Wonderful collection of hi-fi stuff.

Concert Souvenirs. (violin and piano). Louis Kaufman, Paul Ulanowski. Capitol L-8165

Encores by Zino Francescatti, with Artur Balsam, pf. Columbia ML 4534

The inevitable old favorites of the violinist's after-concert repertory. Londonderry Air, etc. Francescatti maintains the better dignity; Kaufman oils his to the dripping point. Both are good in sound, the Kaufman closer, sharper.

ROOM 646
AUDIO FAIR

Super Horn

GATELY
DEVELOPMENT LABORATORY
CLIFTON HEIGHTS, PA.

*PAT. PEND.

Some Pickup Design Considerations

P. G. A. H. VOIGT*

A discussion of one of the causes of unequal wear on the two sides of a stylus—and a suggested cure for it—by a writer who has built and sold pickups commercially over a long period.

IN THE AUGUST (1951) issue, Mr. Ginn asks if anyone else has ever put a spring on a pickup arm to counter the unwanted force which acts toward the center of the record when offset heads are used, claiming that such a spring improves matters.

He and other *Æ* readers may be interested to learn that in the pre-war German Telefunken pickup, a spring was fitted into the arm bearing and produced an outward-acting force. For its time, that pickup was of an advanced design, having the tip only of a sapphire stylus fixed into a small soft iron armature, the latter being pivoted on a V-shaped spring member.

The needle force was about 30 gms., a great improvement over the 100 gms. then customary. The frequency range, owing to the smallness of the moving parts, went well above 10,000 cps. From a Hi-Fi point of view, the main defect of that pickup was that sapphire did not have the wearing properties then claimed for it, so that "rattle" distortion gradually developed and soon became serious. Sapphire replacement was unfortunately too specialized a job for the enthusiast.

There was also a trace of hysteresis distortion which seems to be common to most moving-iron pickups. (It was not a moving-coil pickup as some people think.) In moving-iron pickups it is especially important to keep the armature midway between the pole tips. Any lateral-acting force tends to displace the armature from its central position, and there is no doubt that the outward bias spring fitted into those pickups was intended by the designer to counter the force mentioned.

It is not known whether the production department knew what the spring was for, or how critical its strength was, but in some of the Telefunken Pickups the writer used prior to the war for high-quality demonstrations the spring was much too strong. In consequence, upon reaching the eccentric groove at the end of the record, the pickup would come out of the groove and skate back across the record. Since record surfaces and sapphire points are vulnerable, this condition was somewhat less than ideal.

*Voigt Patents, Ltd., London, S.E. 26. (At present Mr. Voigt is in Toronto, Ontario.)

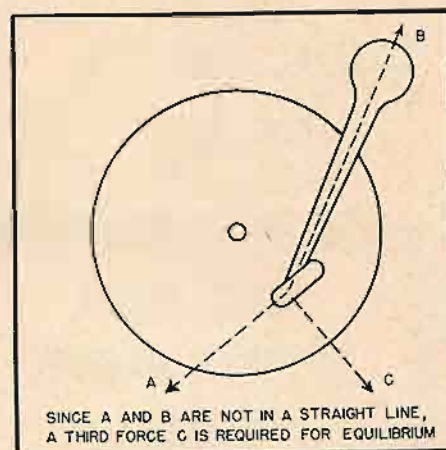

Fig. 1. Diagram of the forces acting on the stylus of an offset-mounted phonograph pickup.

Anyway, for safety sake, this user eased back the adjustment as far as possible, and if still too strong, sometimes removed the spring altogether.

The Forces Involved

There may be readers who are not clear as to the origin of the inward-acting force. In Fig. 1, *A* is the direction of the frictional force between the record and the stylus. This is along the groove at the point of contact, i.e., tangential to the record radius just there. When a pickup with offset head is correctly situated for minimum angular tracking error, that tangent is approximately parallel to the line of the head, and therefore misses the arm bearing by approximately the same angle that the head is offset.

If the arm bearing is frictionless, it can only pull, and that only in the direction from the stylus, i.e., in direction *B*. Since *A* and *B* are not exactly in line, there is a tendency for *AB* to straighten out, causing the head to move toward the record center unless a third outwardly acting balancing force such as *C* is provided to ensure equilibrium.

Normally this third force is provided automatically by the guiding action of the groove on the stylus. Figure 2 shows the mechanics involved, and that the point is pushed sideways in the process. This is undesirable.

Apart from springs, the required out-

[Continued on page 79]

See What's New...Hear What's Different!

See Leonard at the
AUDIO FAIR
HOTEL NEW YORKER
Rms 536-537
SPECIAL SURPRISES
FOR ALL

A STANDOUT SUCCESS!

PREMIER #70
TAPE-SONIC
A Professional Type
Tape Recorder



\$298.50 net CASE INCLUDED

Yes . . . your response has been so terrific we're repeating this sensational offer! Here's a complete, really professional type tape recorder at an amazingly low price. Complete specifications on request.

SUPER HORN
SPEAKER BAFFLE
\$80.00

(15" . . . mahogany)

15" blonde . . . \$85.00
 12" mahogany . . . \$75.00
 12" blonde . . . \$80.00

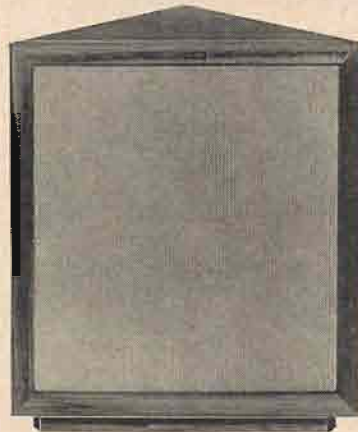

Now Super Horn brings you an entirely new type baffle that achieves thrillingly accurate reproduction of both high and low frequencies. Corner mounting reduces the necessary size of the enclosure, minimizes room resonances, and allows walls and floor to act as a horn extension.

SPECIFICATIONS: Total fold: 180°; non-resonant response down 40 cps (using 12" speaker). For 12" speaker . . . 15" from corner, 20" along wall, 34" high; for 15" speaker . . . 17" from corner, 21½" along wall, 37" high. ¾" wood throughout, frame of solid mahogany, top of mahogany veneer.

Altec Lansing Duplex Loudspeakers Model 602A

- Frequency range from 30 to 22,000 cycles
- Full 2-way system with crossover at 3,000 cycles
 - Sectionalized horn with 2 x 3 aspect ratio
- Power handling capacity: 20 w. continuous, 30 w. peak.
- 15" frame; weight, 25 pounds.



(Model 601A,
 12" frame \$89.00)

\$114.00

Markel 74P Playmaster

- 12 recordings on one loading
- . . . 7", 10", 12" records
- . . . 33-1/3, 45, 78 rpms.
- Automatic shut-off plays both sides of record in sequence or one side only.
- Pfantone "Full Range" pick-up; extremely low distortion over the entire frequency range (40 to 15,000 cps.).
- Attaches to any amplifier or radio through A7161 one tube preamplifier.



\$72.00

A7161 Preamplifier \$11.25
 Tube 1.47

Pentron Reel Extension Kit (X-302) for 10½" NAB reels \$22.50
 GE cartridge (golden) 52 22.90
 The Saturday Review Home Book of Recorded Music 4.50

LEONARD RADIO
 INC.
 69 CORTLANDT ST., NEW YORK 7, N.Y.
 CORTLANDT 7-0315 - 9 DEPT. AE10
The House Built On Service
 Send For New 48 Page Hi-Fidelity Catalog

MAIL & PHONE
ORDERS FILLED
 25% deposit
 Balance COD

NEW PRODUCTS

• **Multi-Speed Tape-Transport Mechanism.** Although low in cost, the new Pentron tape-transport unit is built to a high standard of quality and is well suited for installation in custom built home music systems. Push-button control selects either $3\frac{1}{2}$ or $7\frac{1}{2}$ ins./sec. recording or playback speed. High-speed forward and

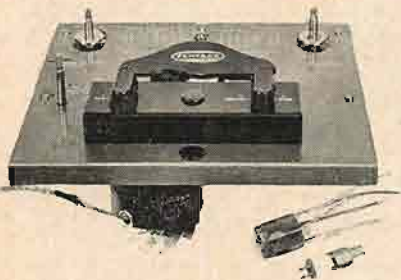

rewind. Normally supplied with twin-track recording head, interchangeability of heads permits ready adaptation to single-track recording. Mechanical drive is supplied by four-pole induction motor. Bias frequency is 32 kc. Maximum playing time with 7-in. reel is two hours. Size is $10\frac{1}{2} \times 9\frac{1}{2} \times 7$ in. Supplied with oscillator coil. Manufactured by the Pentron Corporation, 221 E. Cullerton Ave., Chicago, Ill.

• **Plastic Pliers.** Engineers and servicemen working with high-voltage circuits will welcome the long-nose plastic pliers recently introduced by General Cement



Manufacturing Company, 919 Taylor Ave., Rockford, Ill. Shockproof and sturdily constructed, the pliers are made of high-impact Bakelite. Now available through leading radio parts distributors.

• **Precision Resistors.** Accuracy, stability and long life are inherent properties of the new Hycor Series E wire-wound precision resistors. Standard tolerance is 1 per cent, with tolerances as low as 0.05 per cent available at increased cost. The



units are non-inductively wound on non-hygroscopic ceramic bobbins. Varnish impregnated for moisture protection. Hycor Company, Inc., 11423 Vanowen St., North Hollywood, Calif.

• **Battery-Operated Oscillator.** Laboratory precision in the field is afforded by the new portable low-distortion oscillator manufactured by Southwestern Industrial Electronics Company, 2831 Post Oak Road, Houston 19, Tex. The Model MB-1 oscillator derives operating power from self-contained batteries and covers a frequency range of 2 to 20,000 cps in four decade ranges. Output voltage of 5.5 volts is delivered to a 2000-ohm load, and the



instrument has an internal impedance of approximately 400 ohms. Distortion is less than 1 per cent in the audio spectrum, and the dial is accurate within 2 per cent of its reading. The unit is equipped with a switch which decreases battery drain when full output is not required. Housing is made of splash-proof welded aluminum.

• **Pin-Point Soldering Iron.** Many delicate soldering jobs will be eased by the new Hexacon Type P-25 miniature soldering iron with $\frac{1}{8}$ -in. replaceable tip. Rated at 25 watts, the iron is designed for constant duty on production lines. Ideal for



use on fine instruments, small electronic devices, and other applications which call for precision soldering. Available for 110 or 220 volts, either a.c. or d.c. Hexacon Electric Company, 266 W. Clay Ave., Roselle Park, N. J.

• **Applause Meter.** Television and broadcast stations will welcome availability of the portable applause meter recently in-



roduced by Air-Tone Sound & Recording Company, 1527 Chestnut St., Philadelphia 2, Pa. Consisting of a crystal microphone, amplifier, gain control, VU meter, and power supply, the entire unit is self-contained. It is a.c. operated. In addition to having many uses where impartial judging of contests is required, the meter may be used for certain types of noise checks as well.

• **Line-Matching Speaker Transformer.** Designed for use in multiple sound installations in schools, hospitals, hotels, and other applications where similar requirements prevail, the new RCA Type MI-12369 transformer affords a wide range of impedance combinations and a power handling capacity of 8 watts. Fre-

quency response is within 1 db from 100 to 12,000 cps. Maximum distortion is 2 per cent from 100 to 8000 cps at 5 watts.

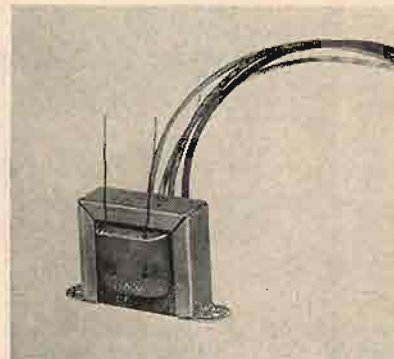

The unit weighs but 10 ounces and measures only $1\frac{1}{2} \times 2\frac{13}{16} \times 1\frac{9}{16}$ ins. RCA Victor Division of Radio Corporation of America, Camden, N. J.

• **Small Crystal Microphone.** Both compactness and high output are embodied in the new Model 54M3 crystal microphone recently announced by The Astatic Corporation, Conneaut, Ohio. Simple and at-



tractive in styling, the 54M3 measures but $1\frac{1}{2}$ in. in diameter and is only one-half inch deep. Output is minus 51 db. The unit is non-directional and has a response range of 30 to 10,000 cps—flat to 1000 cps, gradually rising to 6000 cps. Housing and handle are combined in a single die-cast frame, with a matching base furnished as standard equipment.

• **Equalizer-Preamplifier.** Announced as a companion piece to the new Fisher basic amplifier which was described in these columns last month, the new Model 50-C equalizer-preamp meets the requirements of discriminating audio hobbyists for a flexible audio control unit. Five inputs are

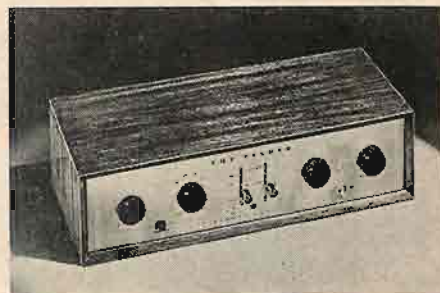

provided with independent level controls, as well as two cathode-follower outputs. Sixteen phono-equalization combinations. Loudness control. Self-contained power supply provides d.c. for all filaments. All-triode circuit with tubes shock-mounted. The 50-C can be used with any make of basic amplifier. Fisher Radio Corporation, 41 E. 47th St., New York City, N. Y.

ONLY THE
Collaro
 INTERMIX 3/522
 HAS ALL THESE
 HIGH FIDELITY

FEATURES:

- Intermixes 10 and 12 inch Records at All Speeds.
- Steady, Constant Speeds — No Rumble or Wow.
- Weighted, Rubber-matted, Rim-driven Turntable.
- Four Pole Motor with Self-aligning Oilite Bearings.
- No Hum Pickup.
- Molded Rubber Drives—No Belts to Slip or Replace.
- Stylus Pressure Adjustment — Tracks at as little as 3 grams.
- Absolutely Jam-proof Operation.
- Automatic Muting Switch.
- Ball-bearing Mounted Turntable and Tone Arm.
- Automatic Shut-off after Last Record.
- Tone Arm Clamp for Portable Applications.

Base Dimensions: 14 3/4" x 12 1/4"
 Depth Below Base: 2 1/2"

LIST PRICE \$65.00

Audio engineers and audio enthusiasts all agree that the quality of any sound reproducing system is the sum total of all of its components units. One weak link in the chain dooms the entire system to mediocrity.

In a record reproducing system, the record changer is the first consideration. If high fidelity is to be attained, the record changer should be the finest obtainable.

Consider the COLLARO. The COLLARO Intermix 3/522 was planned for perfection, and was engineered to the most exacting quality standards. It is truly the high fidelity record changer, and the perfect complement to any high fidelity system.

See the *Collaro* at the N. Y. Audio Fair—Room 607



Model 3/522
Collaro
Fully Automatic INTERMIX

**3-SPEED
 RECORD CHANGER**
 FOR 7, 10, AND 12 INCH RECORDS

Model 3/521 Fully Automatic
 Non-Intermix Model
 LIST PRICE . . . \$54.50

At your Distributor or Write for Details:

🎵 The High Fidelity Record Changer
 for High Fidelity Record Reproduction

ROCKBAR CORPORATION
 211 EAST 37th STREET, NEW YORK 16, N. Y.

SOLVE your hi-fidelity problems with University TWEETERS

WIDEST SELECTION, BEST VALUE, HIGHEST QUALITY!

HIGH FREQUENCY REPRODUCERS

MODELS 4408, 4409—600 CYCLE TWEETER. Response 600-15,000 cps. Ideal for 2 or 3-way systems as Tweeter or mid-range speaker where low crossover frequencies are desired. EXCLUSIVE "reciprocating flares" design results in wide angle distribution. Use with amplifiers up to 40 watts.



MODEL 4407 — COAXIAL SPEAKER ADAPTER. Converts conventional 12" cone speaker into a wide-range coaxial reproducer in a few minutes. Installation is extremely simple and results in a dual speaker system at relatively low cost. Model 4407 includes Model 4401 Tweeter.



MODEL 4401 — 2000 CYCLE TWEETER, response 2000-15,000 cps. Efficient and economical for extending the response of any good 8-15" cone speaker to 15,000 cps. EXCLUSIVE "reciprocating flares" design assures wide angle dispersion. Use in 2 or 3-way systems where crossover in the 2000-5000 cps range is desirable. For amplifiers up to 25 watts, woofers 6-16 ohms.



MODEL 4402 — WIDE ANGLE DUAL TWEETER. The most versatile reproducer ever available. Use of TWO independent drivers permit series or parallel connection for matching 4-16 ohm speakers. For amplifiers to 50 watts. Can be connected for medium or wide angle distribution. For 2 or 3-way systems. Response 2000-15,000.



CROSSOVER NETWORKS

MODEL 4405 — FREQUENCY DIVIDING NETWORK. An effective and economical unit preventing frequencies below 2000 cycles from entering the Tweeter circuit. Protects the Tweeter and reduces overlap in the crossover range. Includes built-in volume control.



MODELS 4410, 4420—L/C CROSSOVER NETWORKS. Segregates highs to the Tweeter and lows to the woofer. Reduces overlap response in Tweeter and woofer. Model 4410 for 600 cycle reproducers, 4420 for 2000 cycle tweeters. Can be used together as a network for 3-way systems. Volume controls included.



Write for literature describing 8", 12", and 15" extended range, coaxial and woofer type cone speakers. Address Desk A-10.

University LOUDSPEAKERS INC
80 SO. KENSICO AVE., WHITE PLAINS, N. Y.

thus leaving hands free for gestures. An impressive selection of new cabinetry, including the Peerage equipment enclosure which matches in design the well-known Royale and Aristocrat speaker cabinets, will further enhance the Electro-Voice display.

Completely assembled high-quality home music system which will be marketed at prices that complete with conventional radio-phonographs will be shown by The Sound Workshop, a new company recently formed by Electronic Workshop Sales Corp., New York, and G & H Wood Products Co., Brooklyn. Although various models of the Sound Workshop line may bear little resemblance externally, inter-

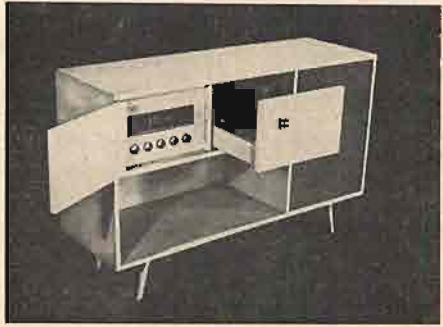

nally there are several common denominators. All, for example, will contain an amplifier with at least ten watts rated output, a three-speed Webcor record changer, a GE dual-stylus magnetic cartridge, an FM-AM tuner, and a Jensen high-quality speaker.

In merchandising the Sound Workshop line, emphasis will be placed on the suitability of the various units for "Aunt Minnie," a mythical character who sprang from the brain of Richard K. Snively, prominent advertising executive, in a note to *Æ's* LETTERS column several months ago. Throughout the SW display at the Fair will be "MINNEHIFT" signs.

The Permoflux exhibit will be highly animated, including a binaural demonstration as well as introductory showing of a number of new Permoflux speaker enclosures. Among the latter is the new Model CH-16M corner baffle which will accom-

modate either two 8-in. speakers or one 12-in. speaker.

Permoflux officials have asserted that "throughout our demonstrations we will stress the theme of 'home level' listening. By this we mean full-range reproduction at a volume level that is comfortable to hear in the living room. This is a very important point to the great majority of hi-fi listeners and we feel that it deserves a great deal of stress." (*We do, too. See "Observations on demonstration technique,"* page 84. Ed.)

The Gately Development Laboratories will present for the first time publicly its line of corner speaker enclosures known as The Superhorn. Available for 12- and 15-in.

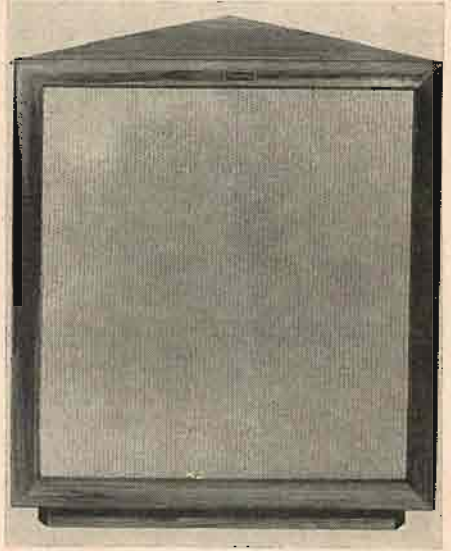

direct-radiator speakers, these enclosures are characterized by high acoustic damping, high efficiency, and exceedingly smooth response. In demonstrating the Superhorn every effort is going to be made to duplicate a typical home installation.

Stromberg-Carlson, participating in its first Audio Fair, will feature an animated showing of the new "Custom 400" line of music-reproducing equipment. Due largely to the published comments of noted musicians, Leopold Stokowski in particular, the Stromberg exhibit is certain to stimulate deep interest from lovers of fine music.

David Bogen Company, Inc., along with a new FM-AM tuner and a new line of



high-quality amplifiers, will introduce a deluxe intercom system designed especially for use in homes. Known as the Home Commu-Phone, the system contains many [Continued on page 86]

HEADQUARTERS FOR NEW IDEAS

FM, Records, Tape

Looking for ideas in FM tuners, or equipment used in conjunction with records and tape? Or ideas for installing and using them?

All over the Country, amateur enthusiasts and professional designers are working out new and constantly improved hi-fi installations. They range from simple, functional designs to those of strikingly decorative appearance. Some introduce new types of equipment; others represent unusual, special-purpose arrangements. They are reported in elaborately illustrated articles in HIGH-FIDELITY Magazine, described in the "Noted with Interest" columns, and discussed in the "Readers' Forum".

Everyone knows that interest in high fidelity, both as a hobby and a business, is spreading like wildfire, but if you want to find out just how much excitement it's creating, and the amount of new hi-fi equipment being brought out by the manufacturers, you can get the whole picture from the editorial and advertising pages in HIGH-FIDELITY.

Equipment Reports

For factual data on new equipment, the department containing the "Tested-in-the-Home Reports" is particularly valuable. These are not laboratory reports. Instead, they explain special design features, describe experiences with the equipment under conditions of use at home, and point out its suitability to particular applications.

In the opinion of many readers, such information is far more valuable than reports which presume to rate performance, and to compare products of different manufacturers, because an instrument that might be given a low rating will still outperform another of higher rating if the latter is

used improperly, or in an application for which it is not intended. As a matter of fact, we have had a great number of letters from readers who found that the Tested-in-the-Home Reports cleared up essential points about equipment which were not covered in manufacturers' instructions or literature.

Acoustics

There is a great deal of engineering data available on the subject of acoustics, but very little of it can be applied to the practical problems of home installations. A notable exception is the series of articles on speaker systems and room acoustics by G. A. Briggs. Probably the top-ranking authority on this subject in England, Mr. Briggs has the faculty of understanding what members of the hi-fi fraternity want to know. Then he has a way of presenting down-to-earth explanations, copiously illustrated, that are a joy to read because they are so easy to understand. Perhaps you are acquainted with his books on audio subjects. They are: "Amplifiers", "Sound Reproduction", "Loudspeakers", and "Pianos, Pianists, and Sonics". If so, you'll be doubly interested in Mr. Briggs series in HIGH-FIDELITY.

Installations

If you are planning a hi-fi installation for your own home, or if you are in the business of doing custom work for others, you will find an endless supply of ideas in HIGH-FIDELITY's picture sections devoted to various designs ranging from the simplest to the most expensive. In each issue a dozen or more installations are shown in big, detailed illustrations. There are modern music walls, equipment that disappears when not in use, methods for using old furniture pieces, and new

ways to mount speakers. Ideas? Why every issue of HIGH-FIDELITY is filled with them!

Audio Fair

You are particularly invited to visit us at the New York Audio Fair, Hotel New Yorker, October 29 to November 1. The FAS-2 audio system, to be described in HIGH-FIDELITY for November, will be on demonstration in Rooms 552 and 553. If you want to hear some of your own records on the FAS-2, bring them in. We'll be glad to play them for you. That is the best way to compare reproduction from the FAS-2 with your own system. Our editorial staff, now including Associate Editor John Conly, will be on hand to greet you.

High-Fidelity

This Magazine, now published on the first of every other month, not only covers all subjects related to hi-fi reproduction from FM, records, and tape, but includes a 24-page section of LP record reviews by some of the leading music authorities and critics. In each issue there is a complete discography by C. G. Burke, listing and reviewing all LP's of a leading composer. There is also information on discs and tape of interest to those who are particularly concerned with recording techniques.

The November issue, which will be mailed to subscribers on October 20, will be a special New York Audio Fair number.

HIGH-FIDELITY is a large-size magazine, elaborately illustrated, and beautifully printed on fine paper. If you are not already a subscriber, by all means order your subscription without delay. When you receive your first issue, if you are not entirely satisfied, the entire amount of your remittance will be refunded.

High-Fidelity

MILTON B. SLEEPER, *Publisher*

"THE MAGAZINE FOR AUDIOPHILES"

Charles Fowler, Editor
HIGH-FIDELITY Magazine
1310 Publishing House, Great Barrington, Mass.

Please enter my subscription to HIGH-FIDELITY for which I enclose:

\$5.00 for 1 year (6 issues) SAVE \$1.00
 \$10.00 for 3 years (18 issues) SAVE \$8.00
(Single-copy price \$1.00)

Name.....
Address.....
Foreign postage: Add \$1.00 per year.

AUDIO engineering society— Fourth Annual Convention Program

WITH THE INCREASE in the length of the AES Convention from three days to four, more time is available for the presentation of technical papers—the principal function of the annual meeting. As heretofore, papers have been grouped to facilitate attendance by those who have interests primarily centered in a specific branch of the audio field. Sessions over the four days have been arranged to cover recording, new developments, components, intermodulation distortion, speech input systems, design data, and home music systems. Because of the general public interest in the latter subject, this session is scheduled for Saturday morning, since many of those who would find something of value in these papers might not be free to attend during the week-day sessions.

According to F. Sumner Hall, Society vice-president and chairman of the Convention Papers Committee, the program is complete, and consists of the following papers:

WEDNESDAY, October 29

10:00 a.m. Annual Business Meeting of the Society.
(This meeting is open only to members.)

10:30 a.m. Technical Session

RECORDING

BINAURAL DISC RECORDING, Emory Cook, *Cook Laboratories*
METHODS OF MEASURING SURFACE INDUCTION OF MAGNETIC TAPE, J. D. Bick, *RCA Victor Division*
A NEW PROFESSIONAL MAGNETIC RECORDING TAPE, Edward Schmidt, *Reeves Soundcraft Corporation*.

2:00 p.m. Technical Session

NEW DEVELOPMENTS

CONSTANT-CURRENT OPERATION OF POWER AMPLIFIERS, Howard T. Sterling, *Waveforms, Inc.*
A NEW POCKET WIRE RECORDER, Oliver Read, *Radio & Television News*
MUSICAL THERAPY, R. L. Cardinell, *Magnetic Programs, Inc.*
SOME CONSIDERATIONS REGARDING VOLUME PRODUCTION OF ELECTRONIC MUSICAL INSTRUMENTS, George H. Hadden, *Minshall-Estey Organ, Inc.*
GUNSHOT REINFORCERS AND SYNTHESIZERS, J. L. Hathaway and R. E. Lafferty, *National Broadcasting Company*.

THURSDAY, October 30

10:00 a.m. Technical Session

COMPONENTS

THE DEPOSITED CARBON RESISTOR, Llewellyn Bates Keim, *Audio Consultant*
ELECTROLYTIC CAPACITORS—WHY AND WHEN, Mark VanBuskirk, *P. R. Mallory & Company, Inc.*
CHOICE OF TUBES FOR AUDIO CIRCUITS, W. R. Ayres, *RCA Victor Division*
REVIEW OF NEW PRINTED CIRCUIT DEVELOPMENT AND AUDIO-FREQUENCY APPLICATIONS, Arthur W. Kelly, Jr., *Photocircuits Corporation*.

[Continued on page 82]

Preview of the 1952 Audio Fair

MORE MANUFACTURERS of audio equipment will introduce more new products at the 1952 Audio Fair than have ever before been shown in a single public display.

Beginning October 29 and continuing through November 1 in the famous Hotel New Yorker, the Fair will serve as the demonstration stage for literally hundreds of amplifiers, speakers, tuners, recorders, and other audio devices which are but one step from the designing table, and which may not appear in dealers' showrooms for months to come. As in previous years, admission is free to all persons with an interest in audio.

Typical of equipment which will be shown at the Fair, although not yet available commercially are two unique recorders which will be featured in the exhibit of Harvey Radio Company, major New York jobber. One, the Cub Corder (see Cover), is a battery-operated tape recorder which affords complete operating mobility to the user. The other, known as the Minifon, is a German-manufactured miniature wire recorder. Small enough to fit into an average overcoat pocket, the Minifon also is battery operated. Considering its small size and its operating characteristics—two-and-one-half hours of recording on a single spool, and

25 hours from one set of batteries—this tiny unit brings into reality an instrument which can be regarded only in the light of fantasy until it is seen.

Altec Lansing has selected the Fair as the first major public showing in the East of its new Type 601A and 602A speakers, also the new Type 606 corner cabinet. Remarkable performance of these units makes them a matter of newsworthy interest to engineers and hobbyists alike. The 601A and 602A represent distinct improvement over the famous Altec Lansing 604B, which has been a staple in the audio field for a number of years.

Electro-Voice is another prominent manufacturer to schedule showing of an im-

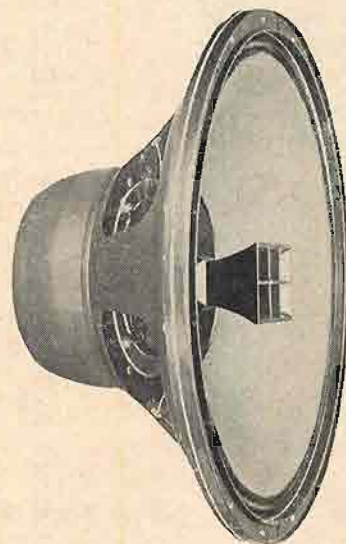

proved speaker—this one, for public address use, is known as the Compound Diffraction Projector System. Unique and exclusive, the CDPS offers increase of articulation index for speech reproduction and two-and-one-half octaves increased range for music. Electro-Voice also will introduce a new p.a. microphone known as the Lavalier. As its name implies, the Lavalier is a small unit which can be suspended necklace-fashion,

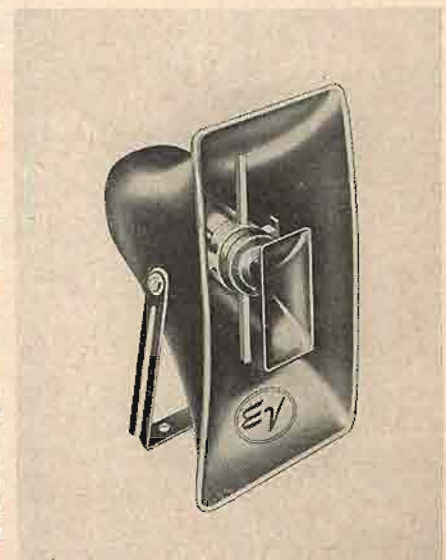

You are Invited to Attend the Fourth Annual

AUDIO FAIR

Sponsored by the

AUDIO engineering society

in conjunction with its

Annual Meeting and Convention

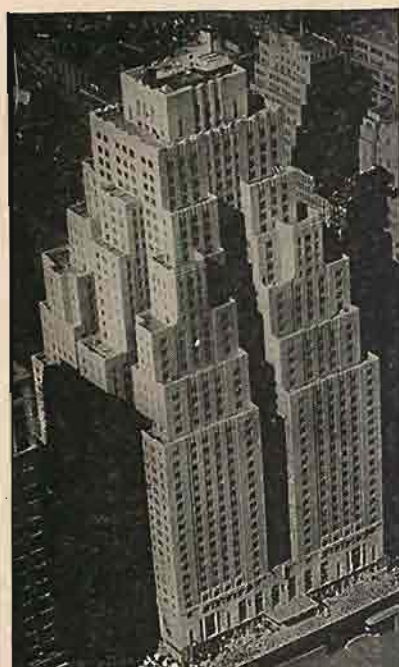

AUDIO TODAY
and
TOMORROW

of utmost interest and importance to government and military agencies. Broadcast Engineers, Recordists, Sound-on-Film Men, Public Address Operators, Audio Hobbyists, Dealers and Distributors, and lovers of HIGH-QUALITY and HIGH FIDELITY music reproduction.

**YOU WILL
SEE and HEAR**

industry-wide displays and demonstrations of the latest and BEST AUDIO and HIGH FIDELITY equipment, components, and accessories.

AGAIN UNDER ONE ROOF

Hotel New Yorker, New York City, Oct. 29, 30, 31, Nov. 1, 1952

Fifth and Sixth Floors

ADMISSION FREE to all Exhibits

Registration at 5th and 6th floor booths

EXHIBIT HOURS



Wed. October 29	11:00 A.M. to 9:00 P.M.
Thurs. October 30	10:00 A.M. to 6:00 P.M.
	(AES Banquet at 7:30 P.M.)
Fri., October 31	10:00 A.M. to 10:00 P.M.
Sat., November 1	10:00 A.M. to 5:00 P.M.

For further information and banquet reservations, write

Harry N. Reizes, Fair Manager, Room 510, 67 W. 44th St., New York 36, N. Y. MUrray Hill 7-2080

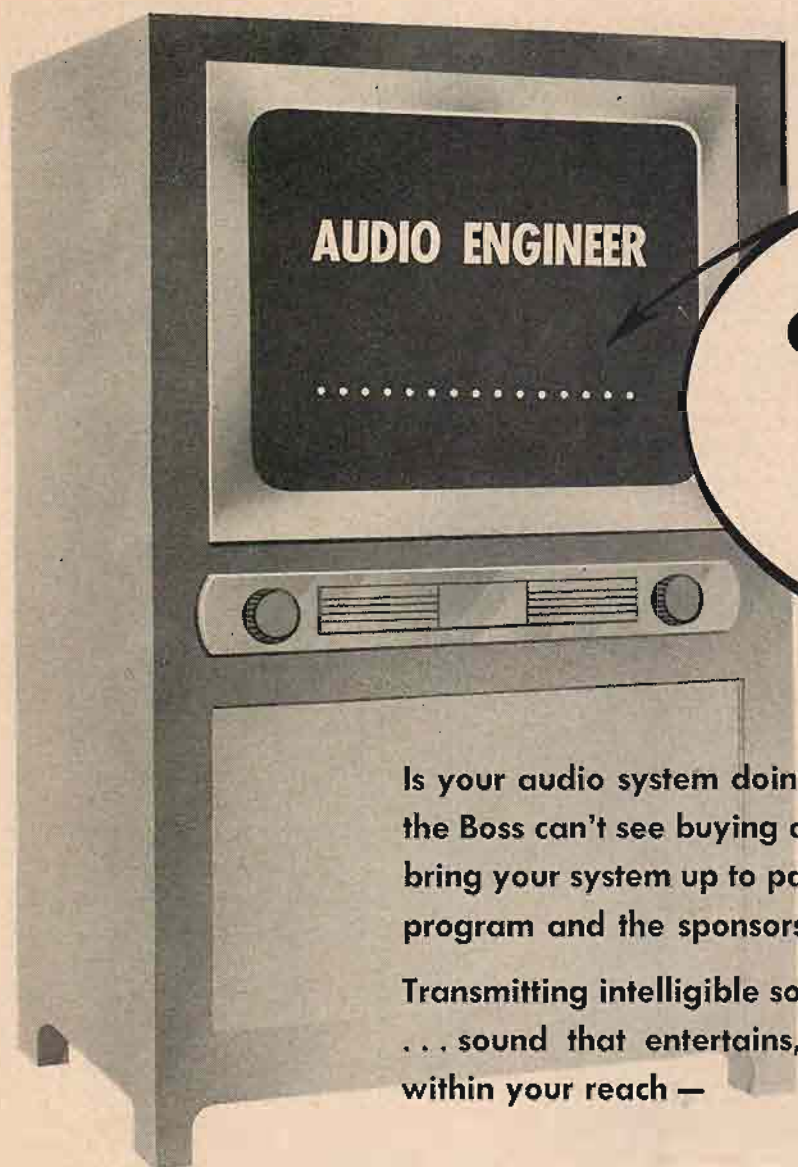

**CREDIT TITLES
IMPORTANT
TO YOU?**

Is your audio system doing justice to your experience? Maybe the Boss can't see buying a completely new system . . . Why not bring your system up to par with the kind of audio that sells the program and the sponsors' products?

Transmitting intelligible sound is an admirable accomplishment . . . sound that entertains, emphasizes, and sells . . . is easily within your reach —

THE CINEMA 4031-B
PROGRAM EQUALIZER



Used in all types of speech input equipment. The 4031-B corrective equalization saves on recording retakes; improves tonal quality; provides emphasis when needed during the program. Widely used in Motion Pictures, T-V, Recording and Military Communications.

**YOUR
AUDIO
IS
ENTITLED
TO THE
BEST**

THE CINEMA 6517-D
VARIABLE LOW AND HIGH FREQUENCY FILTER



Cut off characteristics ideal for shortening frequency range; providing sound effects, such as telephone, whispering, spooks, etc. Clickless control allows insertion upon cue. Used in Motion Pictures, T-V, and Scientific Laboratories.

Write for descriptive literature.

N. Y. Stock—Audio & Video Products Corp. • 730 Fifth Ave. • Plaza 7-3091



CINEMA ENGINEERING COMPANY
1510 WEST VERDUGO AVENUE, BURBANK, CALIFORNIA

Export Agents: Frazar & Hansen, Ltd. • 301 Clay Street • San Francisco, Calif., U. S. A.

In New York...

products of the
CINEMA ENGINEERING COMPANY

are distributed by



Audio & Video

PRODUCTS CORPORATION

730 Fifth Avenue, New York 19, N.Y. • Plaza 7-3091

Exhibiting at the Audio Fair — Rooms 614 & 615

Unparalleled

"PRESENCE"

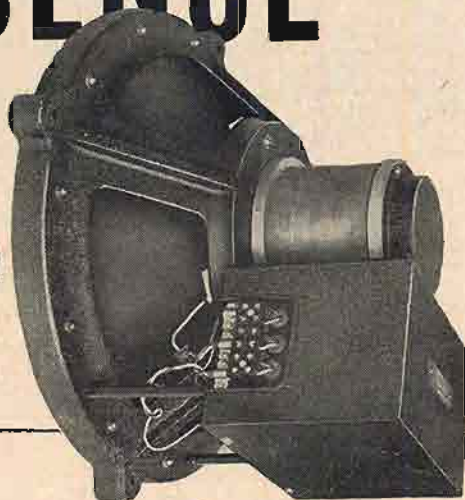
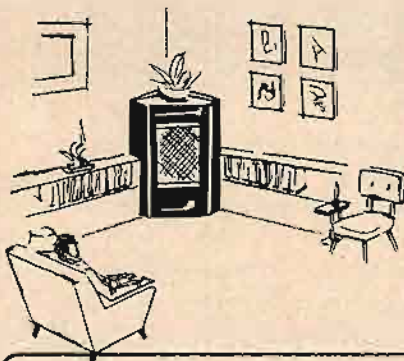

Famous

TANNOY

DUAL CONCENTRIC
LOUDSPEAKER SYSTEMS

**NOW AVAILABLE
IN AMERICA!**

Now experience the amazing listenability of wide range response in perfect balance. Hear the world famous Tannoy Dual Concentric Loudspeaker System, providing optimum fidelity at any level from the audibility threshold up to full room volume. Features of the Tannoy System include:

Substantially flat response from 40-20,000 cycles per second. Concentric sources for both HF and

LF components avoiding interference at crossover. HF horn formed by machined center pole and LF diaphragm, these combined with a special throat insure correct HF match. Intermodulation product less than two percent.

Hear it to appreciate it! Write for free brochure and name of nearest distributor today. 12" and 15" types, handling 15, 25 watts.

SOME DISTRIBUTORSHIPS STILL AVAILABLE

TANNOY

Hear Tannoy at the
AUDIO FAIR
BEAM INSTRUMENTS Rm. 603
Hotel New Yorker

BEAM INSTRUMENTS CORPORATION
350 FIFTH AVENUE NEW YORK 1 NEW YORK

there was no difficulty with this problem. But when the gain approached unity, even though there was some delay involved which should prevent feedback, residual noise on the tape often built up to feedback proportions, and would occasionally simulate a tone. The frequency encountered in this case was around 12,000 cps. A 10-ke low-pass filter cured the situation almost entirely. The gain could then be greater than unity for short periods, until it overloaded the amplifiers. At the slower speed, it was not necessary to add a separate filter to reduce the high-frequency response—the recording equalizer was simply switched to the 15-in./sec. position. The lack of high-frequency response at the slow speed provided all the filtering necessary. As will be noted in listening, there is some frequency distortion when allowing more than about three repeats. The lows are slowly lost, and the effect becomes almost "tinny" if allowed to continue. This may or may not be desirable, depending on the effect to be created.

In controlling the level of the playback, it was noted that when operating near the point of unity gain, the usual graduation of 2 or 2½ db per step was too much, and would throw the system into feedback. It was found that ½ db-per-step faders would give the desired gradation. This would make it seem stepless to the ear, and would permit working much closer to the point of unity gain without incurring the danger of so-called feedback or of spilling over into positive gain in the loop.

Any change of level should be made slowly if there is a signal in the system. If a change of more than 2 db was made during the transit time of a given point on the tape, this change will be repeated for as many times as the sound takes to decay. This gives rise to thumping at the slow speed or flutter at the fast speed.

By using a "filter mike," additional and almost amazing effects can be created. Many ethereal effects are possible, and they can add charm, humor, reverence or macabre, depending on the type of show involved. For instance, if a set of chimes—or a vibraharp with the dampers off—is played with a soft mallet and the sound run through the echo system, the effect is "heavenly." An additional feature of this system is that the recorder is still being used to record the program in its entirety. As long as the playback fader is kept closed, the recorder functions normally and captures the main program. When the echo effect is needed, merely open the fader to the predetermined position, and there is the echo. This too, becomes a part of the program material. When the echo is no longer needed, the fader is closed, and the recorder is left running to capture the rest of the program.

With a little practice, any operator should be able to familiarize himself with the techniques involved for the various effects, and indeed, to create new situations to suit his own requirements.

speed of the wire. This is obviously a rather cumbersome method and does not provide the degree of flexibility sometimes needed. In the system outlined here, the reverberation time may be changed at will with one control; in the old system, it might require up to ten adjustments. The amount of attenuation necessary can be determined quickly by experiment. In the first setup of such a system for a dramatic program, it is desirable to experiment with the amount of attenuation, and when the desired effect is obtained, simply log the setting for use in that particular show.

In trying to duplicate certain locations known to listeners, it might be helpful to remember which function duplicates which feature of the reverberation. The size is most generally indicated by the time delay, whereas the characteristics of the reflecting surface will determine the rate of decay. Also, the tonal quality of the reflected sound may be altered by the nature of the material. A soft substance will generally absorb the high frequencies and cause the sound to be "muddy" or lacking in brilliance. A tone control may be helpful in further enhancing the effect of reality. It is astounding how an otherwise good production can be ruined by poor acoustical effects, such as, in a live studio, the echo of walking feet when the scene is supposed to be outside.

Two-Machine Set-up

No mention has been made so far about the use of two machines as shown in the diagram. One machine, running at 15 in./sec., is capable of many realistic effects. By proper manipulation of the fader, almost any desired acoustical effect can be approximated, ranging from large caverns to very small hallways. But at times a lack of fullness that defies realism will be noted. Better results can be obtained if a second machine, running at $7\frac{1}{2}$ in./sec., is used. The two machines together—if properly mixed—make the effect come alive. In this event, the sound is fed back at two different delays, with both machines recording the original sound as well as both playback outputs. With both of them delaying all the sound, the effect becomes almost overwhelming. The $7\frac{1}{2}$ -in./sec. machine cannot be used to the fullest extent unless it is used alone, or the result will be an unintelligible mass of sound, completely masking the original. If used alone, however, it is effective if the illusion of vastness is needed. When used in combination, the two machines have been used to simulate Mammoth Cave, or, with moderation, the sewers of Paris. In this case, the water provided the proper effect necessary for realism, and listeners inquired as to where "recordings" of this effect were obtained.

Notes on the Use of the System

A few of the difficulties which can be encountered may be of interest. The biggest trouble was that of actual, or apparent, feedback. At high levels of attenuation around the recording loop,

You can't buy better performance at any price!



First wide range diamond-and-sapphire combination delivers frequency response from 30 to 15,000 cycles. Tracks all 3 speeds at 6 to 8 grams

THIS new 1-mil diamond and 3-mil sapphire* stylus assembly lengthens the life of your records and delivers tone reproduction *unsurpassed by any make on the market.*

The replaceable stylus is of the famous G-E "Baton" design. Multiple damping blocks filter out harmonic distortion, needle talk and needle scratch. There are no moving parts in this cartridge—nothing to

wear out. Remember—when you replace a stylus assembly in a General Electric cartridge, you replace every component that is affected by age or wear. A new stylus assembly means, in effect, a new pickup.

Ask your G-E dealer about the Golden Treasure cartridge, or write us for the nearest source of supply. *General Electric Company, Electronics Park, Syracuse, New York.*

**Synthetic*

Send for these new catalogs...

General Electric Company, Section 5492-15
Electronics Park, Syracuse, New York

Please send me the items checked:

Phono Accessory Catalog

Wide Range Stylus Folder

NAME _____

ADDRESS _____

CITY _____ STATE _____

GENERAL  ELECTRIC

Echo Effects with a Tape Recorder

R. S. HOUSTON*

Applying the principles of a reverberation generator to conventional tape machines to provide—in a limited fashion—a variety of effects not usually available.

SINCE THE ADVENT of tape recorders with a separate playback amplifier to permit monitoring of the tape while recording, enterprising engineers have seized upon the delay introduced by the playback as an effective means of producing, artificially, the effect of some sort of reverberation chamber. The usefulness of this effect in dramatic work or even on some types of spot announcements is, of course, obvious to those who have worked with such effects to any extent. While the principles outlined here are not intended to be taken as original, there are some concepts which the author thought might be of more than academic interest to the engineer who has been called upon to provide this facility. The recorders used in the original experiments were two Presto PT-900 machines. They were rack mounted in the control room, immediately behind the control console, for easy access by the operator. One machine was set to run at $7\frac{1}{2}$ in./sec., and the second machine was set at 15 in./sec. Their respective inputs were bridged across the output of the console, so they recorded everything that came from the console. The two outputs were connected to separate faders in order that they might be individually controlled as to volume. The faders then actually control the decay period, as will be explained later. The diagram, Fig. 1, illustrates the set-up used.

Theory of Operation

A short review of the principles of reverberation and echo, will clarify the problems involved and permit better understanding of the use of this system. Echo is a single return of a sound to its source, generally by being reflected from one or more surfaces so spaced and angled as to direct the sound back in the direction from which it came, much as a mirror does with light. This

* 2921 N. Woodstock, Philadelphia 32, Pa. (formerly Chief Engineer, KBNZ, La Junta, Colo.)

sound, although generally of lesser intensity than the original and changed slightly in quality and timbre, can be louder than the original if the source is large in relation to the listener and if the configuration of the reflecting surface is such as to focus the sound back to the listener. This effect is familiar to anyone who has heard his voice reflected off a cliff, or even from a nearby forest.

Reverberation is similar to echo, except that it is the *multiple* return of sound from many points of reflection, all at different distances, so that the sounds return at different times. This effect is produced also by the same sound being bounced back and forth between nearly parallel surfaces, if some of each reflection is returned to the listener. This is often noted in hallways, indoor swimming pools, and—as the ultimate—in water-filled caves, especially large ones.

An additional effect noted in reverberation is the constant attenuation of each successive wave of sound that is returned to the source. Although theoretically the sound will bounce around in a closed area forever, it is eventually absorbed and lost as heat, in actuality. Long before this occurs, however, it has become inaudible. It is the period of time from the incidence of the sound to the point of inaudibility that will concern us here. The reverberation time is governed by two main factors—the absorption coefficient of the reflecting surfaces, and the distance between them. Other factors which enter in a smaller degree are the original intensity of the sound and the dispersion of the sound; i.e., how much of the sound striking the reflecting surface is not absorbed, but sent in the direction of another reflecting surface, or back to the point of origin. Assuming a fixed decay time, it will naturally take a loud sound longer to become inaudible than a soft one.

With these facts in mind, it is easy to see the two main problems that arise

in producing artificial reverberation. First, that of providing a suitable delay for the sound originally emitted before it is heard again; and second, providing a suitable decay period before it will fade into inaudibility. The first is provided by the variable speed at which the recording is run. On the $7\frac{1}{2}$ in./sec. speed on the machine used, the delay from the recording head to the playback head is approximately 0.75 sec., while at 15 in./sec. it is just one half as long. According to Tall,¹ the ear, or the brain center associated with the ear, is incapable of distinguishing between two sounds that occur closer than about 0.14 sec. apart. Therefore, the 0.375-sec. delay provided on the faster speed seems to be about optimum. The decay period is provided by the fader on the console. Consulting the diagram, it is seen that the circuit for any one machine is a feedback loop. Such would be the case, were it not for the delay occasioned by the tape in running between the record head and the playback head. All sounds that leave the console are impressed on the recorder, so when the original sound is played back, it becomes part of the output of the console again, and is re-impressed on the recorder. This process repeats continuously until the sound has completely died out. If the total gain and loss around the circuit is unity, the sound will be re-impressed on the tape with the same volume as the original, and it will never die out. Suppose, for example, 3 db of net loss is inserted by means of the fader. This will put the second impression of the sound at a level 3 db lower than the original. When it again comes around, it will have lost 6 db, and so on. Since for broadcast use, the minimum effective usable level is about 30 db below 100 per cent modulation, the sound will make ten reverberations before being lost. At 15 in./sec.—which would mean a delay time of 0.375 sec.—it would take the sound 3.75 sec. to reach 30 db attenuation. This is a very long decay time and should be long enough to accomplish any desired purpose.

Putting Theory to Work

In some of the original magnetic-tape reverberation "chambers," a wire recorder was used with some ten pickup coils spaced at intervals along the wire. Each of these went through a variable attenuator so as to vary the decay time. The delay was varied by changing the

¹ Joel Tall, "Tape editing," *AUDIO ENGINEERING*, May, 1952.

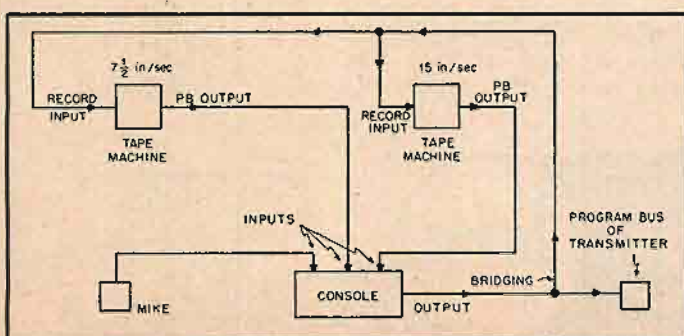

Fig. 1. Block diagram of method of connecting two tape recorders in a control room to provide reverberation effects.

...Again and Again

with the New **CUB CORDER**

Portable Tape Recorder



—————→
You will See it for the First Time at
the AUDIO FAIR, Hotel New Yorker,
HARVEY EXHIBIT — ROOM 631

Here is another 'new' in the annals of Harvey's wide-awake policy to be on the constant lookout for new developments, new ideas, and the finest of new products. This time it is a battery-operated, light-weight recorder. More compact than a portable typewriter, yet with storage space for three full 5" reels of tape, an empty take-up reel, and a microphone.

A rechargeable, non-spill wet cell and a 67½ volt B battery furnish power for the motor, erase oscillator, and amplifier. The Cub Corder may be used continuously for 2 hours before it becomes necessary to recharge the wet cell. Two models are available: for 3¾ and 7½"/sec. or for 1⅞ and 3¾"/sec. Either may be obtained for single or dual track recording. At 1⅞"/sec., the Cub Corder provides one hour of uninterrupted recording on a 5" reel.

All operations and controls have been simplified. Provided with fast forward and normal speed, specific recorded material can be quickly located. Recording operation is remotely controlled by a push-button conveniently located on the microphone. You press to record, and when the button is released, the recorder stops. Professional type erase is automatic when recording,

eliminating a time-consuming operation. Frequency response is from 200 to 6000 cycles/sec. at 7½"/sec. A sensitive dynamic microphone is furnished which 'doubles' as an efficient earphone for playback. An output is provided for playback through an external amplifier with high impedance input. The Cub Corder has made tape recording possible in fields which have thus far been denied its advantages. Weighing only 12 lbs. 14 ozs. in its handsome luggage-tan leather-grained case, and measuring only 5⅝ x 13¼ x 12¼ inches, it finds ideal applications in broadcasting and TV, industry, professions, schools, government agencies, research organizations, news syndicates, and many other fields as an indispensable time and money-saving tool.

The Cub Corder may be used anywhere, and under any circumstances. Interviews may be recorded, notes taken, reports and correspondence dictated, news events covered . . . in the air, on the ground, or at sea . . . aboard ship, in a car, a train . . . anywhere. The scope is practically unlimited.

Complete with microphone / earphone, 5" reel of tape, empty take-up reel, batteries, tubes, and instructions.

\$295

HARVEY RADIO COMPANY, INC.

103 W. 45th Street, New York 36, N. Y. • LUxemburg 2-1500

hrc

NOTE: In view of the rapidly changing market conditions, all prices shown are subject to change without notice and are Net, F.O.B., New York City.

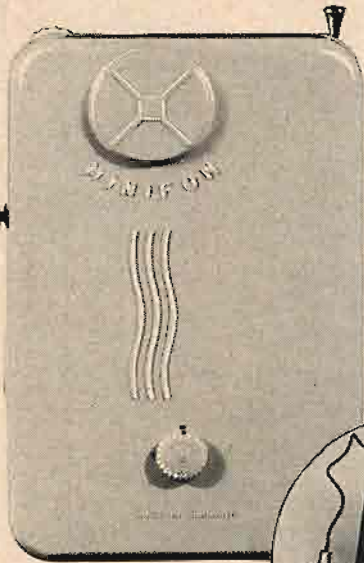

HARVEY is First

with the New MINIFON

Miniature Portable Wire Recorder

You will See it for the First Time at
the AUDIO FAIR, Hotel New Yorker,
HARVEY EXHIBIT — ROOM 631

No bigger than an ordinary camera, the Minifon is just about the world's smallest sound recording instrument. Everything is self-contained. Powered by a standard 1½ volt A battery, a standard 30 volt B battery, and seven Mallory RM-4Z Mercury batteries, this midget device records, rewinds, erases, and plays back through either an external amplifier* or a pair of stethoscope type earphones.

The Minifon is capable of 2½ hours of uninterrupted recordings on a single reel of wire. Once recorded, the wire may be re-wound and played back instantly, or it may be stored or mailed for playback at some other place or at another time, and as often as may be required. When the recording is no longer desired, the wire may be erased for another recording. In this way the wire may be used over and over again.

Measuring only 1⅜ x 4⅜ x 6⅝ inches, and

weighing only 2 lbs. 7 ozs., it may be conveniently carried about for use anywhere, and under all conditions. The Minifon will record the merest whisper, and play it back with amazing intelligibility and distinctness. A simple volume control adjusts both the recording and playback levels.

The Minifon is a valuable tool. Doctors, lawyers, engineers, business executives, salesmen, teachers, scientists, reporters, security agencies and a host of others will find this instrument an indispensable aid in their work, to be used in offices, in cars, in airplanes, in trains, on board ship, or even in subways . . . anywhere . . . wherever and whenever interviews are to be held, notes are to be taken, or records are to be made. There is hardly a job which wouldn't benefit from or which wouldn't be easier with a Minifon. The useful applications of the Minifon are practically unlimited.

Complete with microphone, stethoscope type earphones, 1 hour spool of wire, tubes, batteries and instructions.

\$250

*Output for external amplifier is transformer-coupled for 500 ohm input.

RECORDING WIRE

On spools, in dust-proof plastic containers suitable for mailing.	¼ hour.	\$ 7.00
	1 hour.	9.00
	2 hour.	17.90
	2½ hour.	21.50

VISIT THE AUDIOTORIUM. Come in and visit our new sound department . . . all these items and many more on working display at all times.



HARVEY RADIO COMPANY, INC.

103 W. 45th Street, New York 36, N. Y. • LUXemburg 2-1500



**HOW LONG?
HOW LONG?
HOW LONG DOES A
STYLUS LAST...**

before it begins to
contribute to distortion,
and to take its toll of
valuable records, in
irreparably damaged grooves.

Find the answer to this
perplexing problem
at the



There'll be more
Surprises in store
at the
Harvey Exhibit

Don't Miss It!

HARVEY's new
HIGH FIDELITY AUDIO CATALOG
will be distributed FREE
in Room 631

How often have you wondered whether the needle in your pickup, the stylus in your cartridge, has not already outlived its usefulness; whether your costly records were not being slowly, silently, but surely worn down and abraded. Nothing is permanent . . . not even a diamond, and when a stylus is worn, it will take no time at all for a record to be ruined.

You may have tried squinting at a stylus tip through a magnifier or a microscope, but it takes a boatload of experts to figure out when it's 'gone'.

There is a new, easy, and foolproof way. You can't miss. You can discover a wearing stylus before it begins the damage. And it will save you loads of dollars in favorite records.

See It for the FIRST TIME at the HARVEY Exhibit

HARVEY EXHIBIT

AUDIO FAIR

Oct. 29th, 30th, 31st, and Nov. 1st, 1952

HOTEL NEW YORKER

34th Street and 8th Avenue, New York City

ROOM 631

HARVEY

RADIO COMPANY, INC.

103 W. 43rd St., New York 36, N. Y. • LUxemberg 2-1500

hrc

ARROW'S fabulous, new *Audio Center* was designed for you!



Two of Audio Center's Modern listening areas.



Yes, Arrow's new Audio Center was created with YOU in mind. Whether you are a dyed-in-the wool High Fidelity Fan or just a neophyte, an Audio Engineer with design and development problems, or a Professional or Industrial Sound User—you'll find exactly what you're looking for at Arrow's wonderful, new Audio Center.



HIGH FIDELITY FANS—You are most interested in how well equipment sounds rather than what makes it so. You'll find Audio Center's Duplex Demonstration Studios a better and more modern place to hear what you want, under simulated home conditions and in complete privacy. Have all your questions answered by friendly experts. We welcome the opportunity of assisting you in the selection of the fine musical reproducing instrument you hope to enjoy for years to come.



AUDIO ENGINEERS—You'll find your kind of personnel at Audio Center—engineers who are efficient, courteous and helpful. Of course, Audio Center follows Arrow Electronics' tradition of having the largest stocks of everything in Audio at all times.

PROFESSIONAL & INDUSTRIAL SOUND USERS—Audio Center is your Sound Headquarters because all your sound needs can be supplied with ultra-fast service at unbeatable prices. You'll save more, and make more, when Audio Center serves you.

Visit Arrow Audio Center at the Audio Fair
Come to Room 650 for valuable Audio souvenir.

HEAR ALL THE FINE
HIGH FIDELITY PRODUCTS
OF THESE WORLD-FAMOUS
MANUFACTURERS AT
AUDIO CENTER

ACRO PRODUCTS
ALTEC-LANSING
AMERICAN MICROPHONE
AMPEX
ASTATIC
ATLAS SOUND
AUDAK
AUDIO DEVICES
BELL SOUND
BOGEN
BROOK ELECTRONICS
BROOKS
BROWNING
BRUSH
CABINART
CLARKSTAN
CONCERTONE
DUOTONE
EICOR
ELECTRO-VOICE
ESPEY
GARRARD
GENERAL ELECTRIC
GENERAL INDUSTRIES
GROMMES
HALLICRAFTERS
JENSEN
LEAK
MARKEL
MEISSNER
MINNESOTA MINING
NATIONAL HOLLYWOOD
NEWCOMB
ORRADIO
PENTRON
PERMOFLUX
PHANSTIEL
PICKERING
PILOT
PRESTO
R-J
RADIO CRAFTSMEN
RECOTON
REKOKUT
RIVEREDGE
H. H. SCOTT
SHURE
STANDARD WOOD
STEPHENS
UNIVERSITY
TALK-A-PHONE
TAPEMASTER
TECH-MASTER
TURNER
UNITED TRANSFORMER
V-M TRIOMATIC
WAVEFORMS
WEATHERS
WEBSTER-CHICAGO
WHARFEDALE

ARROW ELECTRONICS'

Audio Center

BEAUTY IN SOUND

65 CORTLANDT ST., NEW YORK 7, N. Y., DIGBY 9-4714

THE MOST COMPLETE LINE IN THE INDUSTRY...



TRANSFORMERS AND RELATED COMPONENTS

For Industrial, Military, TV, Radio and
other Electronic Applications



Stancor is, of course, one of the world's largest producers of special design transformers for use in all types of electronic equipment.

In addition, Stancor has the most complete stock line in the industry for use in your prototypes or lab equipment. If you need one or a hundred transformers in a hurry, you can probably find the type you need in the Stancor catalogued line. They are quickly available through the Stancor parts distributor in your locality.

The new 24 page Stancor catalog lists 475 transformer and related components. Ask your Stancor distributor for a FREE copy, or write us directly.

STANDARD TRANSFORMER CORPORATION

3568 ELSTON AVENUE, CHICAGO 18, ILLINOIS



JUST PUBLISHED!

FEEDBACK

[continued from page 25]

be 20.0 volts as indicated so that the drive E_p will have a net value of 5.0 volts.

The plate circuit has a loss of 5.0 volts; therefore, the output E_o will be -45.0 volts as in Fig. 2. The over-all gain is

$$20 \log \left(\frac{45.0}{20.0} \right) = 7.0436 \text{ db.} \quad (35)$$

The loss due to feedback is equal to the gain without feedback, 20.0 db, minus the gain from (35) or 12.9564 db. This is not the amount by which noise and distortion are reduced, however, since the additional plate loss of 0.9151 db does not contribute to this cause. The feedback factor for the two paths is

$$1 - A_1 K_1 - A_2 K_2,$$

and substituting we have

$$1.00 - (-10.0)(0.10) - (-10.0)(0.20) = 1.00 - (-1.00) - (-2.00) = 4.00,$$

equivalent to 12.0413 db.

For purposes of computation, assume that this amplifier without feedback would generate 10 per cent of second harmonics and has a noise level of -40 db. The noise and distortion plate-circuit voltages without feedback will be $(-50.0)(0.10) = -5.0$ volts distortion and $(0.01)(-50.0) = -0.50$ volts noise since -40 db is equivalent to .01. Feedback will improve the noise by 12.04 db while the distortion will be reduced by the factor 4.0. The noise voltage, also reduced by one-fourth, is -0.125 volts with feedback. The two β circuits will feed back 0.30 of this voltage or -0.0375 volts. This noise voltage has nothing to cancel it in the grid circuit so is re-amplified by the gain -10.0 and produces

$$nE_p = A(nE_o + nE_f) \quad (36)$$

$$= -10.0(-0.0375)$$

$$= 0.375 \text{ volts.}$$

This voltage is out of phase with the original noise voltage of -0.500 volts so will cancel all but -0.125 volts. The new hum level is

$$20 \log \left(\frac{-50.0}{-0.125} \right) = \quad (37)$$

$$20(2.60206) = -52.0402 \text{ db}$$

which checks the theory since the original noise plus the improvement equals the above value.

The distortion voltage reduction follows the same pattern; the voltage feedback will be $(-1.25)(0.30) = -0.375$ volts, which when amplified is

$$dE_p = A(dE_o + dE_f) \quad (38)$$

$$= -10.0(-0.375)$$

$$= 3.75 \text{ volts.}$$

This feedback voltage added to the distortion being generated continuously will reduce the modulation by-products by the amount of "gain" change in the input circuit.

The author hopes that this paper will aid other engineers to obtain a clearer conception of feedback principles, thereby expanding the field of uses to which both positive and negative feedback may be applied.

EASY LOW-COST WAY to own a
PROFESSIONAL QUALITY
DUAL SPEED—HIGH FIDELITY
tapeMaster
TAPE RECORDER



**PORTABLE
 MODEL PT-125**

Use with Your Own Audio Amplifier, Radio or Radio-Phono Combination, or with new tapeMaster Model SA-13 Power Amplifier and Speaker.

For the first time, a completely-flexible professional quality tape recorder like this—at such economical cost! Advanced engineering and customized design make the tapeMaster a natural choice of recording enthusiasts everywhere. Can be carried anywhere and used with an existing audio amplifier or combined with the SA-13 to make a complete tape recorder and playback assembly far superior to other more costly equipment. Ideal for home, school or commercial use.

Complete with 5" spool of plastic tape and 7" empty take-up spool, in sturdy carrying case covered with waterproof leatherette, less audio amplifier and microphone. Size: 12½" x 12" x 9½" high.

Net Price **\$9950**

Built to RTMA Standards • Dual Track—Manual Reversal • Dual Speed—7.5" and 3.75" sec. • Single Knob Instantaneous Speed Change • Fast Forward and Rewind • "A" Wind Tape • Direct Threading of Tape • Push-Pull Supersonic Bias-Erase • Response 50-8000 cps. ± 3 db at 7.5 and 50-5000 cps. at 3.75 • Inputs for Radio, Phono and Mike • Outputs for Audio Amplifier and Headphone • Full Monitoring • Neon Record Level Indicator For 105-125 V 60 cycle AC (Also available for 110-220 V 50 cycle AC) • Operates Vertically or Horizontally.

Send for FREE Bulletin 102-A

tapeMaster inc.
 13 W. HUBBARD ST. • CHICAGO 10, ILL.
 Export: Scheel International, Inc.
 Chicago 18, U.S.A. • Cable: Harscheel

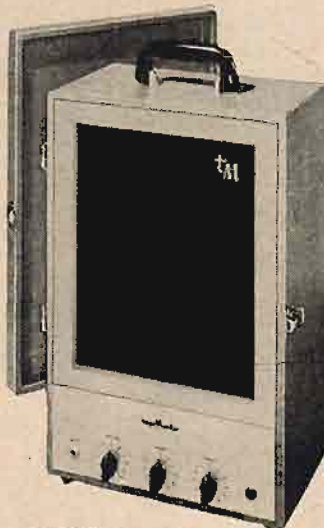

**MODEL SA-13
 POWER AMPLIFIER
 AND SPEAKER**

Portable companion to the PT-125 tape recorder. Combines a special type speaker, new amplifier design, and effective principle of baffing. Amplifier response ± 1 db 30-15,000 cps. Peak output 8 watts. Has separate bass and treble control. 12" x 9½" x 18½" high.

Net Price..... **\$7950**

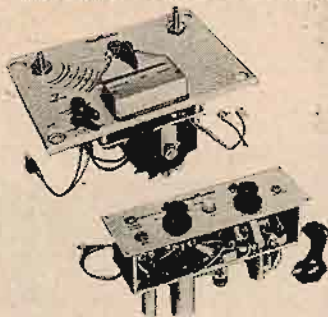

FOR CUSTOM INSTALLATIONS

Model TH-25 Dual Speed Tape Transport Mechanism with Model PA-1 Matching Pre-Amplifier and Push-Pull Supersonic Bias-Erase Oscillator. Fully wired, ready to plug in. Without spool of tape, take-up spool and carrying case.

Net Price..... **\$8850**

Units may also be purchased individually (Prices Slightly Higher West and South)

PATENTS

[continued from page 4]

voltage from the i. f. amplifier. The tuned circuits are resonated at the intermediate frequency. The center point of each tuned circuit is connected to one element of a diode; the two diodes would most conveniently be in a single envelope, such as a 6H6 or 6AL5. R_2 , probably with a reasonably high resistance value to avoid loading C_2 , merely furnishes a d.c. path to ground for the cathode of V_2 .

If the signal input to the discriminator is at the exact frequency to which both circuits are tuned, the impedance of L_1 and C_1 are identical as are those of L_2 and C_2 . The voltages at the midpoints of these tuned circuits are identical, and the equal and opposite diode currents create no voltage at the centertap of mixer resistor R_3 and across load resistor R_4 .

If the frequency of the input is higher than that to which the discriminator is tuned the voltage at the midpoint of L_1-C_1 decreases and that at the midpoint of L_2-C_2 increases due to the transposition of the L 's and C 's in the two circuits with respect to ground. The diode currents are then unequal and a voltage appears between the midpoint of R_3 and ground of a given polarity and an amplitude depending, over a limited frequency range, on the deviation. If the input frequency is too low, similar but opposite action takes place. The midpoint of R_3 is connected to a control tube—perhaps a reactance tube or simply an electrode of the local oscillator if it is of a type that can be made frequency-sensitive in that way—so that the d.c. voltage output of the discriminator tends to correct the oscillator frequency in such a direction as to bring the intermediate frequency back to the right value.

(A) and (B) of Fig. 4 shows the unusual range of control of this discriminator. The usual discriminator develops an output voltage linearly related to frequency deviation, but correction voltage drops off to practically nothing above and below a rather small band right around center frequency. The new circuit remains linear over only a similarly small band, but the correction voltage remains at a high value for (theoretically) an infinitely wide range both above and below center frequency.

A copy of any patent specification may be obtained for 25¢ from The Commissioner of Patents, Washington 25, D. C.

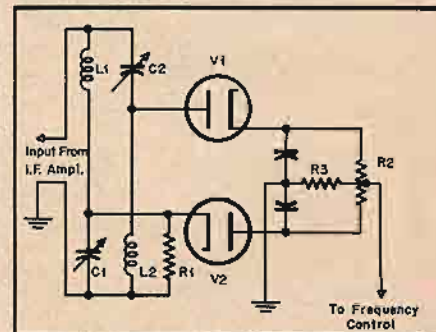

Fig. 3.

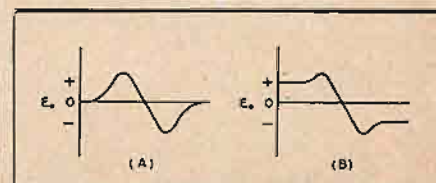

Fig. 4.

CODED SIGNALS

[continued from page 44]

A printed instruction card on what to do in case of an enemy attack is put out by the American Hotel Association and was observed in a room in one of the country's most recently built modern hotels. This instruction card is headed "SIRENS, HORNS OR WHISTLES," and then follows with the instructions:

1. Step outside of your room and close the door.
2. Immediately sit or lie near corridor wall.
3. *Await instructions.*

Await instructions from whom? From bell-hops or possibly chamber-maids? Isn't this a pitiful direction for a public hotel which may house as many as several thousand transient visitors—men, women, and children?

Another instruction card put out by a County Civil Defense and signed by the director states: "The Red Signal is a sustained warbling wail on fire sirens, or intermittent blasts by fire horns or whistles, lasting about two or three minutes. This means an air raid within eight minutes. *If this is the normal fire alarm in your community, regard it as an air raid signal only if you hear similar signals at the same time from neighboring areas.*"

Need I say more?

STEREOPHONIC

[continued from page 28]

microphone and speaker bridged across the two outer channels improves the performance in this respect, though none of the combinations tried are as good as the three-channel layout.

Trial Attempts

There have been various attempts to combine the advantages of the dummy-head microphone mounting with the use of loudspeakers, though so far without any outstanding success. From the point of view of microphone technique the dummy-head mounting has the great advantage of simplicity, two microphones in a common mount being no more difficult to handle than a single microphone. The limitations appear when consideration is given to the time differences which result in seating positions off the room axis. Referring to Fig. 6 it will be seen that at the microphone the position of a sound source is characterized by a time difference proportional to the path-length difference, and this holds for all positions on a line midway between the loudspeakers. At a point such as L well off the center line the original time difference *a-b* is completely swamped by the time difference *c-d* which is characteristic of the relative positions of the listener and the loudspeakers, and has no relation to the position of the source. It might be expected that the stereo-



Since the introduction of the original 604 speaker in 1943 the Altec 604 "duplex" has been known to all as the finest loudspeaker that money can buy. Now, after years of continuing research, the new Altec 604C "duplex" is here to set even higher standards for audio reproduction... for the 604C will faithfully reproduce tones from 30 to 22,000 cycles and handle 50 watts of peak power! Listen to the amazing Altec 604C soon. Your ears will agree it's the finest loudspeaker in the world.

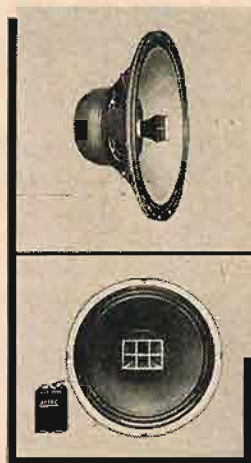

604C SPECIFICATIONS:

Power rating.....35 watts (50 watts peak)
Network impedance.....16 ohms
Maximum diameter.....15 $\frac{3}{4}$ inches
Maximum depth.....11 $\frac{1}{4}$ inches
Weight with network.....40 pounds

Don't forget to listen to these new members of the "duplex" line, the 12" 601A and the 15" 602A. They are designed especially for the home.

ALTEC
LANSING CORPORATION

9356 Santa Monica Boulevard,
Beverly Hills, California
161 Sixth Avenue,
New York 13, New York

ALL THREE SPEAKERS ARE GUARANTEED TO REPRODUCE ALL OF THE TONES FROM 30 TO 22,000 CYCLES!

IMMEDIATE DELIVERY! COMPLETELY NEW PILOTUNER

First in High Fidelity Performance and Dependability

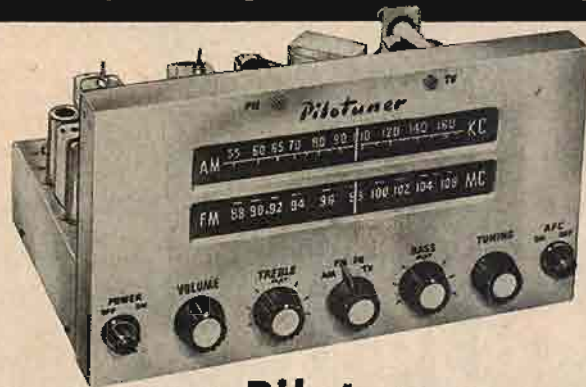

\$ **99**⁹⁵ NET

HIGH FIDELITY **Pilot** FM-AM RADIO TUNER

WEST COAST HIGH FIDELITY CENTER

"IN THE AUDIO MILE"

HOLLYWOOD ELECTRONICS

7460 MELROSE AVENUE • LOS ANGELES 46, CALIFORNIA

WEbster 3-8208

and now —

The 2nd Audio Anthology

Ready about November 1

No bigger, no better than the original Audio Anthology—in fact, it's just the same size and a perfect companion to the most authoritative book you now have on the subject of home music systems. But it contains all new material—reprints of over forty of the valuable articles which have most interested *AE*'s readers during the past two and a half years.

Advance orders are now being accepted—so make sure that you get your copy from the first printing. The board-cover edition will be printed in only a sufficient quantity to fill the advance orders—after that, only the paper-covered edition will be available.

Customary discounts to distributors.

Board Cover \$3.00

Paper Cover \$2.00

-----CUT OUT-----MAIL TODAY-----

Book Division,
Radio Magazines, Inc.,
P. O. Box 629, Mineola, N. Y.

Sirs: Enclosed is my check money order for copies of the
2nd Audio Anthology.

(Please check one) Board Cover Paper Cover

Name (print carefully)

Address

City Zone State

Features—

- Amplifiers
- Preamplifiers
- Tone Controls
- Phonograph Equipment
- Loudspeakers
- Speaker Enclosures
- Tape Recorder Amplifiers

phonic effect would not be quite so obvious in position off the axis of the room and this is found to be the case in practice. *Figure 7* is indicative of the area in which effective stereophony is obtained. Though this appears to be a fundamental weakness of all systems using close-spaced microphones, the advantages of simplicity in the microphone technique justifies further work on the system.

Figure 8 indicates the technique used in all the accuracy tests. A caller held a horizontal stave marked off in each direction from the center, and stood about 25 ft. from the subject under test. The subject wore a light head harness carrying a horizontal sighting rod which was visually lined up on the center zero of the stave at the commencement of the test. The caller took up a position on a 25-ft. radius from the blindfolded subject and read passages from a book until the test subject indicated that he was "on target" at each position. A third assistant read off the error in position on the reader's stave, along the sighting rod on the subject's head. This procedure was repeated at ten different angular positions with five different subjects and the errors averaged. For the indoor tests the same group of observers repeated the procedure in a small theater, the listening position being 55 ft. from the caller. The results of the first series of tests are set out in *Table I* and it will be noted that accuracies of the order of 1 deg. can be achieved both indoors and outdoors. A comparison with the errors made when attempting to align the eyes on the stave zero showed that the accuracy of visual alignment is not more than twice that of an aural alignment. This is surprising, as the ears are rarely used for the purpose of position fixing, a duty left to the eyes.

During the indoor tests the opportunity was taken to check the effect of frequency-range restriction on the accuracy of location. The results also serve to indicate the information carried by the various regions of the frequency spectrum. The technique remained as in the previous tests but the source was replaced by a high-quality loudspeaker reproducing speech picked up by a microphone in another studio. Three filters having the characteristics shown in *Fig. 9* were used to define the frequency range in the three tests, the results being shown in *Table II*. It will be seen that the majority of information on source position is carried by the frequency components above 500 cps though the ear can find adequate information in the small amount of energy that remains in the region above 3000 cps or below 500 cps. With the male speakers employed in these tests, speech intelligibility was zero when the band below 500 cps or the band above 3000 cps was being used.

In tests we have noted that dynamic localization (the localization of a moving sound source) appears to be appreci-

ably more accurate than the localization of a stationary source.

The final point to be considered is the technique to be used in obtaining two or three channels between studio and reproducer, probably the most difficult problem of all. For 1/4-in. magnetic tape, two solutions are fairly straightforward, the first being the use of two or three separate tracks on the same tape. Double track tapes are currently available and can be used for a two-channel system without difficulty. Three tracks each .05 in. wide are possible, though agreement will have to be reached on the relative position of the three tracks, as it is probably impossible to mount three recording or scanning heads side by side. Earlier it was noted that two channels 6,000 cps wide, or three channels 4,000 cps wide, gave results which were subjectively assessed as being equal or better than a monaural channel 15,000 cps wide, and in consequence it becomes necessary to consider how best to use a medium such as tape which can deal with a frequency band perhaps 20,000 to 25,000 cps wide. Nothing is to be gained by reproducing frequencies above 15,000 cps, and a more pleasing result can certainly be obtained by dividing the band into two or three separate channels each 6000 or 7000 cps wide and using them for a stereophonic system.

Phonograph records present a more difficult problem and as they may be superseded by tape it may never be necessary to solve that problem, but one neat solution due to A. D. Blumlein of E M I is worth noting. Blumlein proposes to record a two-channel stereophonic signal on an ordinary disc by simultaneously using lateral and vertical modulation of the single groove. Equipment was built and successfully demonstrated that this was possible. E M I have demonstrated 78 r.p.m. recordings flat to 20,000 cps and these would permit two or three channels 6000 to 9000 cps wide as suggested for tape.

Broadcast-band AM radio poses on even more difficult problem, particularly in Europe where all stations are on a nominal spacing of 9 kc. Single side-band transmission of two channels is possible as the data in Table II shows that frequencies below 500 cps are of no great importance to the stereophonic effect, permitting a double-sideband transmission of frequencies up to this point, with single-sideband transmission of the left and right signals on the upper and lower sidebands, as shown in Fig. 10.

On short waves there is no technical difficulty. The audio bandwidth of a short-wave transmitter is sufficient to provide two or three channels as suggested for magnetic tape, or the carrier may be simultaneously modulated by FM and AM signals to give two channels.

The renewed interest that has been shown both in Europe and America in the problems of stereophony indicates that it will be the next major step towards obtaining a *perfect reproduction*. Under the stress of competition from TV, stereophonic sound may appear first in sound movies and may be accompanied

flyweight or heavyweight



CHICAGO

builds the world's toughest transformers in a complete range for every need

From "flyweight" High Q Chokes to "heavyweight" Modulation bruisers, CHICAGO "Sealed-in-Steel" transformers are *really rugged*. Talk about "torture"—these units can "take it," and deliver complete dependability and continuous service under the most adverse conditions. Your electronic parts distributor can supply the *complete* range of CHICAGO *New Equipment* units for every modern circuit requirement: Power, Bias, Filament, Filter, Audio, MIL-T-27, Stepdown, etc.—all in exclusive "Sealed-in-Steel" construction.

THERE'S NOTHING TOUGHER THAN THE "SEALED-IN-STEEL" NEW EQUIPMENT LINE

CHICAGO'S one-piece drawn-steel cases are the strongest, toughest, best-looking transformer construction available. The one-piece seamless design (in a choice of 3 mountings) enclosing an electronically perfect unit, provides the best possible electrostatic and magnetic shielding, with complete protection against adverse atmospheric conditions. Whether your transformers must pass the most rigid MIL-T-27 specs, or are intended simply for average applications—*play safe*—choose CHICAGO "Sealed-in-Steel" transformers.

FREE "NEW EQUIPMENT" CATALOG



You'll want the full details on CHICAGO'S *New Equipment Line*—covering the full range of "Sealed-in-Steel" transformers designed for every modern circuit application. Write for your Free copy of this important catalog today, or get it from your electronic parts distributor.

Available in 3 Versatile Constructions

H-TYPE

Hermetic sealing meets all MIL-T-27 specs. Steel base cover is deep-seal soldered into case. Terminals hermetically sealed. Ceramic bushings. Stud-mounted unit.



S-TYPE

Steel base cover fitted with phenolic terminal board. Convenient numbered solder lug terminals. Flange-mounted.



C-TYPE

With 10" color-coded leads brought out through fibre board base cover. Lead ends are stripped and tinned for easy soldering. Flange-mounted.



CHICAGO TRANSFORMER

DIVISION OF ESSEX WIRE CORPORATION

3501 ADDISON STREET • CHICAGO 18, ILLINOIS



TRADE MARK REG.



TAKES THE "PORTERING" OUT OF PORTABLE RECORDING



THE Magnemite*

Battery-Operated Spring-Motor
PORTABLE TAPE RECORDER

Field recording can now be made with as little effort as studio or home recording. Light and compact, the tiny Magnemite is the first completely portable tape recorder! Earphone monitoring and playback facilities built in. Powered by self-contained dry flashlight batteries that last 100 operating hours. Four models are available for any speech or music recording requirement, including a model designed to NAB recording standards.

Model-
610-B

Size: 11½ x 8½ x 5½ in.

Weight, including batteries: 10 lbs.

Net Price: \$225

*Trade Mark Reg.

Write for complete literature, specifications and direct factory prices

AMPLIFIER CORP. of AMERICA • 398-2 Broadway • New York 13, N.Y.

ONLY 136 COPIES LEFT

\$1.00
1949

- June
 September
 December

\$.50
1950

- August

\$.35
1951

- March
 April
 May
 June
 October

\$.35
1952

- March
 May

AUDIO ENGINEERING, P. O. Box 629, Mineola, N. Y.

I enclose Send issues checked

Name

Address

City State

THE NEWEST **AMPEX** MAGNETIC TAPE EQUIPMENT
IS BEING DEMONSTRATED AT THE AUDIO FAIR!

Rooms 614 & 615



Audio & Video

PRODUCTS CORPORATION
730 Fifth Avenue, New York 19, N. Y. • Plaza 7-3091

Exhibiting at the Audio Fair — Rooms 614 & 615

by the introduction of a wider screen to take advantage of the new freedom.

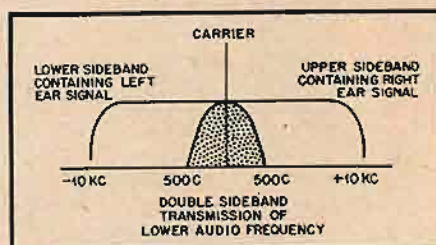

Fig. 10. Radio bandwidth usage for stereophonic transmission on AM.

TABLE I

Comparison of the Accuracy of Location in Indoor and Outdoor Environments

	Sound Source—Original Male Speech	
	Mean Error	Standard Deviation
Indoors at a spacing of 55 feet	1.04 deg.	1.15 deg.
Outdoors at a spacing of 25 feet	1.2	2.7

TABLE II

Accuracy of Location using Bands of Filtered Male Speech

Frequency Range	Avg. Error	Std. Deviation
50-500 cps	3.8 deg.	3.55 deg.
500-3000	0.9	3.8
3000-7000	0.5	3.4
50-7000	0.7	4.7

REFERENCES

- W. E. Kock, "Binaural localization and masking," *J. Acous. Soc. Am.*, Nov. 1950.
Details of an experimental determination of the amount of discrimination against noise that is given by our binaural hearing system.
- Harvey Fletcher, "Hearing, the determining factor in high-fidelity transmission," *Proc. I.R.E.*, June 1942.
An excellent paper which reviews most of the factors known to be of importance in obtaining a high-fidelity reproduction. This paper is important to anyone interested in the subject of high-fidelity.
- Galombos and Davies, "The response of single auditory fibres to acoustic stimulation," *J. Neurophysiology*, 1943, No. 6. Describes nerve voltage measurements that appear to have an important bearing on the mechanism of the stereophonic effect. Most interesting reading.
- F. M. Weiner, "Diffraction of a sound wave by the human head," *J. Acous. Soc. Am.*, Jan. 1947.
- J. C. Steinberg and W. B. Snow, "Auditory perspective physical factors," *Elec. Eng.*, Jan. 1934.
One of a group of six papers devoted to stereophony. That loudness difference is the main factor in binaural localization is not now so widely believed as in 1934, but the group of papers is required reading.
- J. Moir, "Stereophonic sound," *Wireless World*, March, 1951.
- J. Moir and J. A. Leslie, "The stereophonic reproduction of speech and music," *J. Brit. I.R.E.*, 1951 Radio Convention.
- K. de Boer, "Stereophonic sound reproduction," *Philips Tech. Rev.*, April, 1940.
An account of the factors that are of importance.

SYLVANIA
PRECISION

FREE!

The following manufacturers' products are cataloged in the 128 page Instrument & Test Equipment Section.



EMICO

JACKSON

Chicago

ELECTRONIC MEASUREMENTS

SUPERIOR

BROWNING

BARKER & WILLIAMSON



SUPREME

marion

STERLING

Industrial Instruments

precise

Hickok

RADIO CITY PRODUCTS

JAMES MILLEN

Darlington

Weston

FREED

Shurite

RODENTON RADIO

TRIPLET

BEAM



SHALLCROSS

MEASUREMENTS CORPORATION

EICO

JBI

SIMPSON

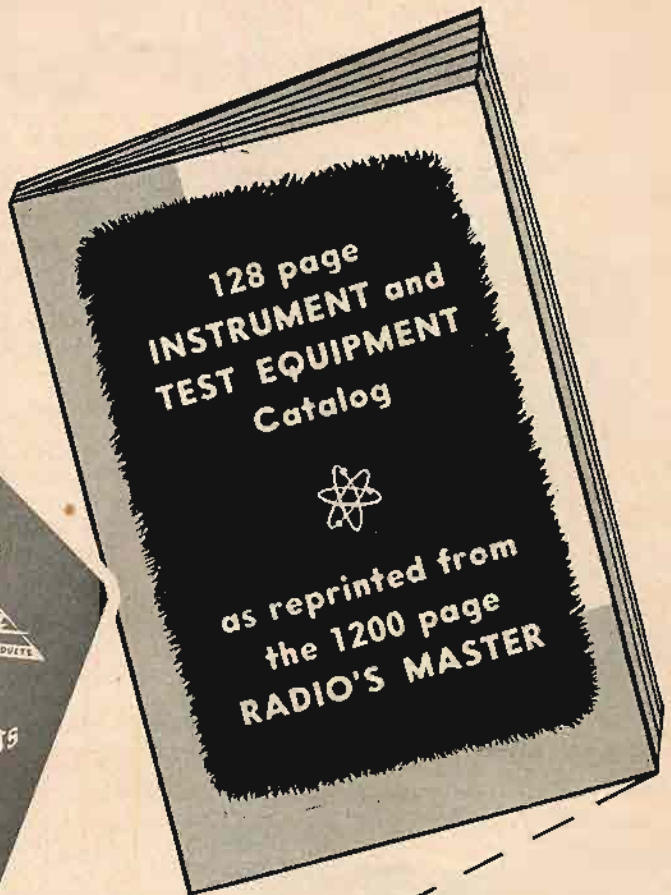

AUDIO ENGINEERING subscribers can receive, without cost or obligation, a complete 128 page catalog section on Test Equipment and Instruments, as reprinted from the 1200 page RADIO'S MASTER, the Industry's Official Buying Guide.

This section catalogs in detail the products of the leading Instrument and Test Equipment manufacturers — all in 1 handy booklet. It is complete with descriptions, specifications and illustrations as written by each manufacturer. You will find this large catalog section extremely helpful and a handy reference.

This FREE offer is made possible by a special arrangement between AUDIO ENGINEERING MAGAZINE and the publishers of RADIO'S MASTER. Be sure to get your copy . . . just mail coupon NOW.

These manufacturers do not catalog test equipment in Radio's Master. Separate catalog sheets will accompany each booklet.

- Audio Instruments Corp.
- Ballantine Laboratories
- General Radio Corp.
- Heath Company
- Hewlett-Packard Corp.

GET YOUR FREE 128 page CATALOG

AUDIO ENGINEERING MAGAZINE

P. O. BOX 629, MINEOLA, N. Y.

Please send, without cost or obligation, the 128 page Instrument and Test Equipment Catalog as reprinted from Radio's Master.

Name.....

Address.....

City.....Zone.....State.....

Always in stock
at **ALLIED**

Largest Selection of
Professional and
Home Quality Audio
Components

The new ALLIED catalog is your best buying guide to the world's largest, latest and most complete selection of audio equipment. All important high-fidelity lines are featured. All equipment, including professional quality components, is available from stock. Whatever your needs, you can count on ALLIED for quick, intelligent, complete service . . .

NEW . . . send for it . . .
236 page 1953 catalog



Virtually an "Audio Fair"

- Complete home music systems
- All famous-make amplifiers
- Hundreds of speakers and enclosures
- Widest selection of tuners
- Everything in phono components
- Tape and disc recorders
- Fullest microphone listings

If it's anything in AUDIO—
It's available at **ALLIED!**

SEND FOR
FREE CATALOG

ALLIED RADIO CORP.

833 W. Jackson Blvd., Dept. 17-K-2, Chicago 7, Ill.

RADIO STUDIO

[continued from page 31]

Running Sheets

The next step is to put down on paper the detailed wiring information needed to show the wireman the exact starting and stopping points of each rack pair, and the connections required for their shields. It's generally a good idea to start with the jack field—specifically the low-level jacks—since the jacks are the most common point for all the elements of the rack. Start with jack #1 and proceed in numerical order of jacks. A useful form for systematizing these data is the running sheet of Fig. 4 in which is shown a portion of the low-level data of the small audition studio used for illustration in this series. The form is self-explanatory except perhaps for the check columns. Since the running sheets are checked and rechecked against the interconnection sheets, block diagram, etc., by both the designer and the wireman, the numerous check marks tend to obscure the data. This is a serious source of error when the typist later retypes them for permanent record, and is avoided by providing columns for the check marks.

It will be noted from the block diagram that the tip pairs from jacks 1, 2, and 3 go to microphones. Since these are outside the rack, the pairs must be wired to the low-level terminal block. Reference to the rack cabling layout (Fig. 3 of the preceding installment) shows that the only low-level cable running down the rack to block #1 is cable B. The running sheets are therefore started as shown in Fig. 4. The jack numbers are listed in the EQUIPMENT column of the FROM group, the jack terminal numbers going under the TERMINAL column. The two tip terminals of each double jack are numbered 1 and 2, the normals being 3 and 4. Since the tip pairs for microphone jacks 1, 2 and 3 are all in cable B, they are numbered 1, 2, and 3 respectively in the pair column. At the other end, these pairs are assigned to terminals 1 and 2, 3 and 4, 5 and 6 on terminal block #1, these data being entered in the columns of the to group on the run sheet.

It's a good idea to show the connections for the normal terminals of the jacks (and any multiples) on the same run sheets as the tip connections, as this keeps all the jack wiring information together. The block diagram shows that the normals of jacks 1, 2, and 3 are wired to the normals of the preamplifier input jacks 13, 14 and 15 respectively, and this information is recorded on the running sheet on the line below the tip information for each jack. While the foregoing description is based on conventional double jacks, the run sheet would be no different for single jacks as in any case there would be the equivalent of two tip terminals (actually one tip and one ring terminal for single jacks) and two normal terminals.

So much for jacks 1, 2, and 3. Jacks 4 and 5 are the turntable output jacks and their tip pairs must also run down the rack in cable B to the same low-level terminal block #1. These pairs are numbered 4 and 5 and are assigned to block terminals 7 and 8, and 9 and 10. The normals of these jacks are shown as wired to the normals of preamplifier input jacks 16 and 17 respectively.

The next two jacks in numerical order, jacks 6 and 7, turn out to be assigned to the tape recorder microphone (inadvertently omitted from the block diagram) and the monitor head output. Since the rack cabling layout shows that the tape recorder is above the jack field, the tip pairs from these two jacks must obviously run in another low-level cable running up the rack from the field. These jacks are therefore omitted from the run sheets of the down-running cable B and we proceed with the remaining low-level jacks shown by the block diagram as wired to the terminal block or to other components located below the jack field. A check against omitting any pairs is obtained by comparing the number of pairs listed on the run sheet with the total shown on the previously prepared cable list. As soon as the wiring data is entered on the running sheet for each jack, that jack is checked off the jack-field layout rather than the much-abused block diagram (since the latter may not show every jack). In like manner, the low-level jacks whose tip (or normal) pairs are shown by the block diagram as going to rack components located above the jack field are assigned pair numbers in the up-running cable A and are entered on another set of running sheets. This system results in each set of running sheets applying only to one cable, which facilitates future reference. The running sheets should also show whether the shield of each pair is grounded to the jack frame or to a ground bus located on or near the terminal block, or to an amplifier chassis. This can be indicated by any convenient symbol, such as an "x" placed in the appropriate TERMINAL column of the FROM or TO group, with perhaps a note at the top of the sheet to identify the symbol.

The running sheets (and the interconnection sheets when you come to them) should refer by number to any separate sketches which may be required for clarity—for example, when pairs split in series connections with other pairs, or go to rack components lacking clearly-identified terminals. It is important to list the sketch in its column (Fig. 4) when the running sheets are being made up, because that's the time you are most conscious of the need for the sketch. Then the sketch number, a short descriptive title and the jack and pair numbers involved, should be entered immediately on a sketch register which serves as a guide to the draftsman. This provides reasonably good insurance that preparation of the sketch will not be overlooked until the wireman is loudly proclaiming that he cannot go on without it.

After all the jacks have been shown on the running sheets, other rack components having terminals should be listed, such as amplifiers, equalizers, tuners, etc. It is obvious that after a while, the running sheets will be calling for pairs that have already been accounted for by the earlier jack-field entries. For instance, by the time the input terminals of preamplifier #6 are listed under the FROM group as wired to the tips of jack 18, the pair in question will already have been assigned a number when the terminals of this same jack were listed earlier under the FROM group. In such cases, an asterisk on the appropriate line of the running sheets will indicate to the wireman that this pair has already been run.

So much for the running sheets for the rack. Stock consoles need no running sheets since their internal components are already wired to the console terminal blocks. However, in custom-built consoles constructed by the station staff, the various internal connections to the blocks from mixers, switches, output transformers, etc., must be prescribed on running sheets in much the same manner as for racks, except that console sheets start with the console terminal blocks instead of the rack jack field.

Rack Wiring Practices

Before discussing the interconnection sheets, it might be well to consider a few points in regard to the actual wiring of the racks from the running sheets. Ordinarily, the low-, medium-, and zero-level cables are run up and down the right side of the rack as seen from the rear, and the high-level and power circuits are run on the left side. Spacing between cables of different level groups should be a minimum of three inches between edges; more is often desirable. Before any cables are connected to the jack field, it's a good idea to put in the normal and multiple connections. It is difficult to accomplish this rather close work between jacks after their terminals are largely obscured by incoming pairs. Cables running between the terminal blocks and the jack field are best begun by soldering the various pairs to the terminal block while the latter is still on the bench. This eases the long and tiring job of working on the block after it is installed in the bottom of the rack, but incoming interconnection pairs must still be installed the hard way. The cable can then be formed in place and run up the side of the rack to the jack field which is usually at a convenient working height. (Figure 1A of the preceding installment). Cables running across and behind the jack field can if necessary be supported by and lashed to a stiff wire stretched across the rack.

Always include spare pairs in the rack cables and keep a list of the numbers of the spare pairs in each cable. They come in handy for omitted circuits and as substitutes for broken or

Westrex Distributes

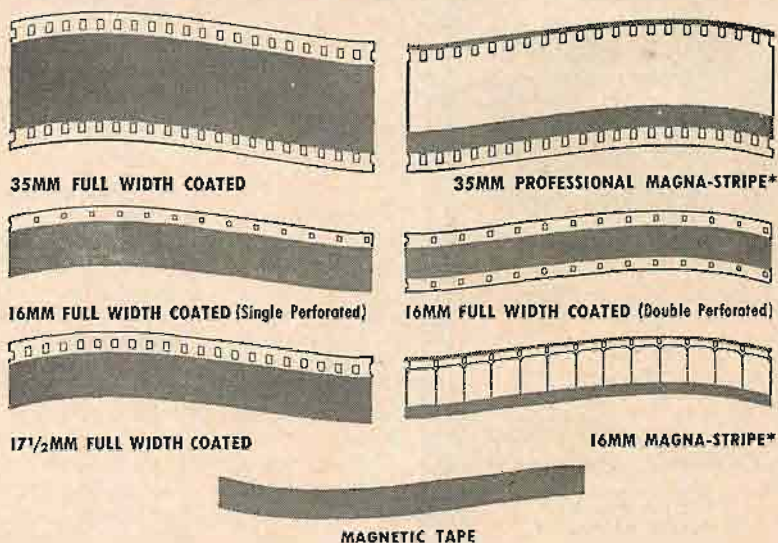

Reeves Magnetic Film and Tape, Featuring...

- **ECONOMY** of low first cost and long life.
- **CONSTANT OUTPUT** assured by electronically controlled coating.
- **GREATER DYNAMIC RANGE** because of highly uniform oxide dispersion.
- **HIGH FREQUENCY RESPONSE** conforms to industry standards.
- **POLISHED SURFACE** reduces mechanical squeal.
- **HIGH OUTPUT** because oxide dispersion is engineered for maximum sensitivity.
- **LONG HEAD LIFE** results from coating oxide particles with low-friction material.
- **LONG STORAGE LIFE** assured by use of new tri-acetate safety film base.
- **OXIDE FLAKING** or rubbing off greatly reduced due to high adherence of magnetic coating.
- **MECHANICAL UNIFORMITY** achieved by a special coating formula that minimizes curling.
- **35MM FILM EDGE NUMBERED** every foot in opposite directions as an aid in editing.
- **CUSTOMERS RECLAIMED CLEAR BASE ACETATE FILM** can be striped with a magnetic coating — an added economy measure.
- **DEVELOPED OR UNDEVELOPED PHOTOGRAPHIC FILM** can also be coated for television productions or other similar usages.

Westrex now distributes Reeves Soundcraft full-coated magnetic recording film, "Magna-Stripe*", and magnetic tape in line with its policy of providing studios with the finest recording equipment and accessories.

*Trademark of Reeves Soundcraft

Research, Distribution and Service for the Motion Picture Industry



Westrex Corporation

111 EIGHTH AVENUE, NEW YORK 11, N. Y.
HOLLYWOOD DIVISION 6601 ROMAINE STREET, HOLLYWOOD 38, CAL.



FAIRCHILD RECORDING EQUIPMENT CORPORATION

Synchronous Disc Recording & Playback Units

are available from



Audio & Video

PRODUCTS CORPORATION

730 Fifth Avenue, New York 19, N. Y. • Plaza 7-3091

Exhibiting at the Audio Fair — Rooms 614 & 615

Presenting



LOUDSPEAKERS
in the
luxurious setting
of
ARROW
ELECTRONICS'

AudioCenter

designed to
COMPLETELY
demonstrate
SOUND
in its natural
setting

UNIVERSITY
LOUDSPEAKERS,
INC.

80 S. KENSICO AVENUE
WHITE PLAINS, NEW YORK

CONGRATULATIONS

to
ARROW
ELECTRONICS'

AudioCenter

on creating
a new
and
inspiring
way to
demonstrate



BELL SOUND
SYSTEMS, INC.

555 MARION ROAD
COLUMBUS 7, OHIO

shorted pairs. Their ends can be coiled up at the jack field and at the terminal block. Be sure to number all pairs including spares, at both ends, selecting the label location where it can be visible after the pair is soldered in place. The label should show cable letter and pair number, thus: B12. Printed adhesive labels used by electricians and known as "Quik-Labels" are available for this purpose. This type of label also comes in handy for numbering all jacks with numerals visible from the rear, as a convenience to the wireman.

Since polarity is important in speech-input systems, be careful to pole all jacks and other components consistently. This can be done almost automatically by adopting a color code. For example, the red member of the pair can go to the right tip terminal of each double jack, and black to the left tip. The same rule would apply to the normal connections. For single jacks, red could go to tip and black to ring. At the terminal blocks, red may be assigned to odd-numbered terminals and black to even. Similar conventions apply to terminals of microphone and turntable wall receptacles.

Interconnection Sheets

As the rack cabling layout was the basis for the running sheets, so is the interconnection cable layout the basis for the interconnection or cross-connection sheets. This layout was shown in Fig. 4 of the preceding installment and indicates all the cables and conduits leading from the rack to the console, announce booth, etc. Preparation of the interconnection sheets (Fig. 5) should start with the terminal blocks as the most common point in the entire studio installation. The terminal block numbers are listed in the EQUIPMENT column of the FROM group and the numbers of their terminals are listed in numerical order in the TERMINAL column. The equipment and the terminals to which they are to be connected are listed in the columns of the TO group. The interconnection sheet picks up the rack internal low-level circuits at the rack terminal block where the running sheet left them and carries them out to the console, turntables and other external destinations. It is important that both the running sheets and the interconnection sheets proceed in numerical order of terminal numbers of the various terminal blocks as far as possible. As in the case of running sheets, the interconnection sheets should show shield connections by an "x" in the appropriate column. Those pairs shown as running back on themselves should be marked with an asterisk and should of course, bear the same pair numbers previously assigned.

The same form is used for both running and interconnection sheets. As illustrated, both carry the pairs of only one cable. This is deliberate for the running sheet but is true of the interconnection sheet only because there is only one low-level cable in this particular installation. Larger installations

have several cables of a given level group coming off the same block and all these cables will appear on the interconnection sheets, and not necessarily in numerical order of pair numbers.

Occasionally, in more complex installations, cables running between widely separated points sometimes include pairs which run between intermediate points and are numbered as pairs of the "parent" cable. For example, if there were six adjacent racks numbered 1 through 6 the cable carrying zero-level pairs between outermost racks 1 and 6 could also carry zero-level pairs between racks 3 and 5. In such instances, the composition of the cable is not completely described by the number of pairs it carries away from the block of rack 1. To avoid overlooking the other pairs when figuring conduit size or installing the cable, it is necessary to refer to the interconnection cable layout sketch where these turn-offs and their quantities should be shown. When there are many such turn-offs, the sketch becomes cluttered and it is helpful to keep a cable make-up sheet for each "parent" cable, listing the starting and terminating points for every pair in the cable.

Construction Materials

Having the material on hand in proper quantities and to exactly the right specifications before beginning construction can spell the difference between a first-class and a mediocre installation job. Listed below are the principal construction materials, (exclusive of audio equipment and accessories) need to install the plant.

Greenfield conduit & fittings	Mike plugs & receptacles
Wiremold conduit & fittings	Rubber-lined cable clamps
Assorted wire and cable	Brady "Quik-labels"
Terminal blocks	Cable shield terminations
Assorted terminal strips	Nuts, bolts, washers, wood screws
Jones plugs & sockets	Electrician's "Dux-seal"
Lacing cord	Spare tubes & fuses

Tests and Adjustments

There is a great temptation, after the last connection has been soldered, to turn on the power and play a record to hear what it sounds like. While this may result in cheering up the chief engineer—who by this time probably needs cheering up—there are other things to be done first. There are two phases to the check-out process: one is to check the mechanical and electrical condition of the cabling, and the other is to test and adjust the system as a whole.

It's a good idea to inspect the cables, terminal blocks and the mechanical condition of the racks and console in general for obvious breaks, sagging cables, dirty terminal blocks, scraped insulation, etc. Then comes the tedious business of checking each pair for continuity of each conductor, continuity

of the shield, shorts between conductors, shorts between conductors and shield, and polarity. Part or all of this can of course be done by the contractor who installed the conduit. There are short-cuts such as checking circuit continuity and polarity from one end to the other, instead of from jack to block, block to receptacle, etc. However such checks will not necessarily show up shorts to shield nor prove shield continuity. Neither will they disclose two polarity errors in cascade—an important point when patching into intermediate elements of a circuit for emergencies or special set-ups. Check grounding conductor continuity between racks and other grounded frames with an ohm meter between clean, bare points some distance from the conductor connections.

The patch panel deserves careful checking. Rapidly insert and remove a plug into and out of each jack several times to make sure that bent jack springs are not preventing insertion and to clear the springs of dirt and oxide. Check continuity between the tips of each pair of mutually-normalled jacks, and repeat with a patch-cord connecting the same jacks to make sure the plug properly seats in the springs. When testing single-type jacks with tone, normal intensity of signal obtained with a partially inserted plug usually indicates reversed polarity or a ground on one conductor.

It is assumed that all amplifiers, recorders, etc., were bench-tested before installation and now have no apparent defects. Turn on the power and have an announcer speak into each mike from regular script. Avoid the "Hello, test" routine which is of little use in judging the overall performance of the system. Play records on the turntables and feed their outputs through the various circuit branches. Make test recordings of program material at the main output of the system. By this time, the power supplies have been energized long enough to check for overheating. Then make a rough check for loose cable, grounds in the console by turning all channel pots and the master the monitor volume controls wide open and note whether the VU meter pointer leaps away from the pin and hangs quivering part or all the way across the dial. If it does, there is feedback which may be due to presence of a wrong ground or absence of a right one. The trouble point can sometimes be determined by probing gently among the console internal cable bundles and noting when the meter drops back to normal. It may then show some residual reading with wide open pots, due to normal hum. If temporarily clipping another capacitor or so across the power supply filter reduces the hum, make the change permanent.

After these preliminary tests to make reasonably sure the system has no major defects, checks with an oscillator, gain set and noise-and-distortion meter are made to adjust levels, align limiters and measure over-all frequency response,



MIDGET CONDENSER MICROPHONE

For Precision Sound Measurements and High Quality Sound Recording

Built to give years of service without change in calibration. Even without dessicators, Kellogg Midget Condenser Microphones show no detectable drift in laboratory service. Proven in use for optimum performance for more than 15 years.

- RUGGED CONSTRUCTION
- EXCEPTIONAL CALIBRATION STABILITY
- UNAFFECTED BY VARIATIONS IN HUMIDITY

PRINCIPAL CHARACTERISTICS

	MODEL A	MODEL B
RESPONSE (Referred to 1 volt/dyne/cm ²)	-59 db	-55 db
FLAT TO WITHIN	± 3 db from 20 to 11,000 cps, for closed cavity without grille.	± 4 db from 20 to 15,000 cps with or without grille for perpendicular incidence in free field.

Users Include government laboratories, universities, audio development laboratories, sound studios and industrial plants manufacturing sound equipment.

● SEND FOR FULL SPECIFICATIONS TODAY! WRITE DEPT. 27-J.

KELLOGG

AN IT&T ASSOCIATE

MIDGET CONDENSER MICROPHONE

SWITCHBOARD & SUPPLY COMPANY

Sales Offices:
79 W. Monroe St., Chicago 3, Ill.

An Associated International Telephone and Telegraph Corporation



IN YOUR OWN HOME
WITH A High Fidelity CABINET

BEAUTIFUL CORNER CABINET
IN BLONDE OR MAHOGANY
IN KIT FORM AND PRICED
FOR EVERYONE TO ENJOY

8" speaker cabinet size — 18" x 13" x 27"
THE MISSOURIAN (Mahog.) List Price — \$18.50
THE GLENDALE (BLONDE) LIST PRICE — \$21.50
12" speaker cabinet size — 27" x 13" x 25"
THE MISSOURIAN (Mahog.) List Price — \$21.50
THE GLENDALE (BLONDE) LIST PRICE — \$24.50

For complete details, see your Sound Dealer, or write:

Zark

WOOD PRODUCTS COMPANY
311 Park Ave., Glendale, Mo.



Now you can have a quality, high-fidelity folded corner cabinet, at a fraction of the price you'd expect to pay — because you do the assembly work yourself! These kits contain only the best of materials, and include complete, easy-to-follow instructions that will enable you to assemble your unit in less than an hour!

Here's what the kit contains:
Factory pre-cut finest quality mahogany plywood and fir.
Beautifully designed speaker grille and plastic grille cloth.
Plastic wood.
Complete assembly instructions including speaker hardware.
Wood screws and brads.
Glue

McIntosh

... designed for the Audio Enthusiast
with the Professional Ear...

available from



Audio & Video

PRODUCTS CORPORATION

730 Fifth Avenue, New York 19, N.Y. • PLaza 7-3091

Exhibiting at the Audio Fair — Rooms 614 & 615

HYCOR

TYPE 4200

Sound Effects Filter



This unit has been developed to meet present day requirements for compactness. The filter requires only 3½ inches of rack space.

Features:

- **LOW HUM PICKUP** through the use of toroid coils. The unit may be used in circuits having signal levels as low as -40 dbm without the necessity for taking special precautions against hum pickup.
- **LOW DISTORTION:** The filter may be used at levels up to plus 20 dbm with negligible intermodulation distortion.
- **RELIABILITY:** All capacitors and inductors are hermetically sealed for lifetime service. Aging effects are negligible.

General specifications:

- DIMENSIONS:** Standard rack panel, slotted, 3½" high. Maximum depth 7½".
- CONTROLS:** Low frequency cutoff selector knob, high frequency cutoff selector knob, on-off key.
- RANGES:** Both low and high frequency cutoff controls cover 100, 250, 500, 1000, 2000, 3000, 4000 and 5000 cycles.
- ATTENUATION:** Approximately 16 db, per octave on both high and low frequency cutoff points.
- IMPEDANCE:** 500/600 ohms, in-out.
- FINISH:** Engraved panel finished in medium gray baked enamel. (Special colors available upon request.)

The filter has standard input and output jacks located on the front panel in addition to the terminal block at the rear.

HYCOR

Company, Inc.

11423 VANOWEN STREET, NORTH HOLLYWOOD, CALIFORNIA • SUset 3-3860

Manufacturers of Toroid Inductors, Decade Inductor Instruments,
Wave Filters, Resistive Networks, and Precision Resistors

Eastern Representative: Burlingame Associates, 103 Lafayette Street, New York 13, New York

Send for Bulletin S

noise, and distortion. Incidentally, it is well to have the oscillator distortion measured to make sure this value is not a significant factor in the over-all system readings.

Set the microphone gain, master gain, and monitor volume controls at normal operating position—possibly half open—and feed into each input in turn a 1000-cps signal which deflects the console VU meter to zero with the meter attenuator knob set so that the net VU meter reading is 10 db above desired program peaks. The load section of the gain set is then plugged successively into the output jacks of each amplifier between the console and the limiter to permit adjustment of their gain to the required value. The limiter amplifier is then aligned in accordance with the manufacturer's instructions to provide the necessary gain at the threshold of limiting and to adjust the degree of limiting to the recommended amount—frequently 5 db. The gain settings of components beyond the limiter are then adjusted with the gain set. A standard VU meter could be used in place of the gain set provided the circuits it bridges are properly terminated.

After all gains have been adjusted, the frequency response of the over-all system can be checked with the gain set and if the results are below expectations, the response of each amplifier and other circuit components are checked individually. The same over-all and subsequent point-to-point check procedure is used for distortion at various frequencies, at the same 10 db-above-program level used for frequency-response measurements. Noise levels are determined by driving the amplifier or system under test at 1000-cps with the gain controls in normal operating position and calibrating the noise-and-distortion meter in accordance with the manufacturer's instructions. The 1000-cps signal is then removed and the noise is read from the meter-scale, modified by any attenuator settings on the instrument. Improper grounding and impedance mismatches are common causes of over-all noise, distortion, and poor response in systems whose individual components may be quite satisfactory in these respects.

The somewhat tedious gain-set method of checking response can be avoided by playing a sweep-frequency record such as the Clarkstan #1000A and 1000D on the turntable and feeding the output of the amplifier being observed into a calibrated oscilloscope.² This enables the response over the entire spectrum to be observed at a glance and also gives qualitative indications of harmonic and intermodulation distortion and transient response.

A check on stability of the over-all system can be made by boosting the level another 10 db at various frequencies. This should cause no oscillation in a stable system and little or no change in frequency response. And since the ear is

² Wayne R. Johnson, "Analyzing sweep frequency transcriptions" *AUDIO ENGINEERING*, October, 1947.

the ultimate consumer of the station's audio merchandise, listen critically to live program material over the control room monitor speaker and to the playback of recordings made from the system. Measurements may indicate everything in good condition and yet the speaker output may not sound right. Speaker hangover, speaker location, improper acoustics in studio and/or control room, and poor transient response of one or more system elements are possible causes of this trouble.

Conclusion

This completes the series of five articles on planning and building radio studios. Incidentally, it's almost as much work to write about their construction as it is to build them. The writer would like to express, belatedly, his thanks to Mr. M. J. Kodaras of Johns Manville for his friendly assistance in the preparation of some of the acoustical construction material in Part 2.

PICKUP DESIGN

[continued from page 64]

ward force can be obtained by deliberately departing from a level motor board, and so raising one side of it that the pickup will be climbing "up hill" very slightly as it plays through the record. By careful adjustment of the slope, the downhill force can be made to provide force C.

Arm-bearing Friction

Another means of achieving the same result—and one employed by the writer in a pickup designed in 1939—is to introduce deliberately a slight friction into the arm bearing. This method is only suitable for use with normal records which start at the outside. When playing such records, the head traverses the record from the outside toward the center. Any friction in the arm bearing then resists that motion and so provides an outwardly acting force during operation.

In moving-coil pickups which have no iron in the moving parts, the exact angular position of the coil is (within reason) not material from an electrical or magnetic point of view. Nor is there any unstable magnetic effect trying to

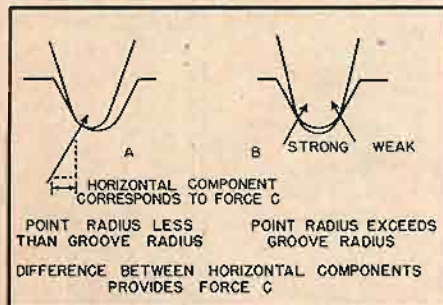

Fig. 2. Causes of uneven wear on stylus. (A) for great differences in pressure on the two sides, and (B) for small differences in pressure.

the LOWELL BACK COVER SPEAKER CAN and PLASTER RING ASSEMBLY combined with LOWELL SPEAKER BAFFLES

The Lowell steel back cover speaker can and plaster ring assembly is used for recessed speakers in new construction or remodeling for complete protection of the speaker.

Steel back speaker can is made of 22 gauge steel, and a 22 gauge steel plaster ring, with 90° spaced speaker baffle mounting holes, is spot welded to the can. Plastic roughing compound applied throughout inside of speaker can to prevent metallic resonance. Speaker leads can be brought into the assembly at any location.

Furnished with 3/4" knockouts on all sides, and all mounting hardware, including speed nuts.

Write for complete specifications and prices today!

LOWELL MANUFACTURING COMPANY

3030 LACLEDE STATION ROAD, ST. LOUIS 17, MISSOURI

Canadian Representative:

Atlas Radio Corp., 560 KING ST. W., TORONTO, ONTARIO

DC to AC Converters **Dynamotors** **Genemotors**

Recorder Converters

Inductor Alternators

Magmotors

DEPENDABLE... COMPACT... EFFICIENT
Carter Rotary Power

Carter DC to AC Converters, Dynamotors, Genemotors, Magmotors, and Inductor Alternators (inverters) are made in a wide variety of types and capacities adaptable to communications, laboratory, and industrial applications, of many kinds. Widely used in aircraft, marine, and mobile radio, geophysical instruments, laboratory work, ignition, timing and many other uses.

Carter Motor Co.
2648 N. Maplewood Ave., Chicago 47
Sales Offices in Principal Cities

MAIL COUPON FOR CATALOGS

Please send catalogs containing complete information on Carter Rotary Power Supplies.

Name _____
Address _____
City _____ State _____

*Trade Mark Registered

CONGRATULATIONS

to
ARROW
ELECTRONICS'

AudioCenter

on creating a new
and inspiring way
to demonstrate
the **NEWEST** in
HIGH FIDELITY
AMPLIFIERS
by

Newcomb

**NEWCOMB AUDIO
PRODUCTS CO.**

6824 LEXINGTON AVE.
HOLLYWOOD 38, CALIF.

CONGRATULATIONS

to
ARROW
ELECTRONICS'

AudioCenter

on creating
a new
and
inspiring
way to
demonstrate

National
HOLLYWOOD

RECORDING DISCS

**NATIONAL
HOLLYWOOD**

1475 EL MIRADOR DRIVE
PASADENA 3, CALIFORNIA

aggravate any departure from the central position. This permits extremely free mechanical mounting of the moving parts thereby reducing the forces which the groove wall must exert on the stylus at large low-frequency amplitudes. It also diminishes tendencies to set up arm resonances, and lowers their position in the frequency scale. If this freedom is overdone, however, the mounting becomes too "sloppy," and the coil may tilt excessively, causing the stylus to lean over sideward if there is any accidental unbalanced lateral force.

It must also be remembered that if forces toward or away from the turntable center predominate, one side of the stylus will be doing most of the work. Not only is the push-pull effect of the lateral-cut method of recording impaired, but only one side of the groove will be doing most of the work of moving the pickup and therefore wearing out prematurely.

Since the force A , primarily involved, is friction between the record and the stylus, it will vary with the record material and with the needle force. It therefore tends to disappear as the needle force is diminished. Since for the present, we are likely to have to continue with pickups which press down on the record even if only slightly, some trace of force A will remain. The subject of eliminating its by-product therefore warrants attention.

Simple Test for Balance

If anyone wishes to test whether the lateral forces in his own pickup are balanced, a simple approximate method is to rest the stylus on the uncut edge of a record and allow slight rotation of the turntable. Prominent inward or outward force will then cause the pickup to slide in the corresponding direction.

Since the inward force depends on the friction between the stylus and the disc, this test is only approximate, for the friction of the stylus on the plane surface may be different from that experienced when riding properly in the groove. If the stylus has been used, it may also have developed a shape causing it to "skate" in the preferred direction.

The most certain test is to examine a used stylus (not diamond) under a microscope and compare the wear on the two sides. This gives information as to the average state of affairs under the actual working conditions. (As a caution, remember that when turning points upside down and looking at them under a microscope, one's ideas of direction can play funny tricks.) With an offset head, it is usually the inside surface of the stylus which shows most wear. If so, the inward-acting resultant of A and B has not been countered sufficiently. The reader will now know what to do.

See You at **THE FAIR**
HOTEL NEW YORKER
Oct. 29, 30, 31, Nov. 1
BE THERE

EXTRA!

GOOD Transformer NEWS!

New 20-20 plus
transformers

New miniature
transformers

New—super
standard audio

New
400 cycle power

All with...
extra quality
extra flexibility
extra performance

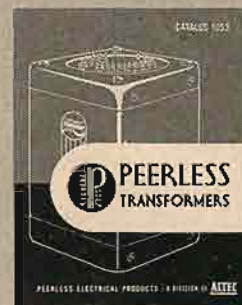

Write
today
for the
new
1953
Peerless
Catalog

It's the best transformer
news in years

PEERLESS
Electrical Products

A DIVISION OF

ALTEC
LANTIER CORPORATION

9356 Santa Monica Blvd., Beverly Hills, Calif.
161 Sixth Avenue, New York 13, New York

LONDON LETTERS

[continued from page 14]

through two output channels, using 30-watt amplifiers in each.

The Radio Show is organized by the Radio Industry Council, which in actuality is composed of four trade associations:

1. The Radio & Electronic Component Manufacturers Federation (Components, measuring and testing instruments, sound reproducing equipment, etc.)
2. Radio Communication and Electronic Engineering Association (radio and television transmitters, communication equipment, navigating aids, industrial electronics, etc.)
3. British Radio Valve Manufacturers Association (radio and television valves, cathode ray tubes, all types of electronic tubes)
4. British Radio Equipment Manufacturing Association (radio and television receivers, sound reproducing equipment, etc.)

A tremendous variety of equipment was shown at this year's Earl's Court Exhibition, and included accumulator charging equipment, aeriels and aerial equipment, amplifiers, batteries, battery chargers, cabinets, cables, cameras, capacitors (fixed and variable), car radios, cathode ray tubes, chassis, chokes, coils, tuners, etc., coil winding machines, connectors, deaf aids, electro-medical equipment, fuses, gramophone motors, needles, and pickups, headphones, industrial electronic apparatus, lenses, loudspeakers, magnets, measuring instruments, microphones, plastics, public address equipment, radar, radio phono combinations, radio receivers, record changers, record playing units, recording equipment, rectifiers, resistors, service equipment, sockets, solders, suppressors, switches, television receivers, testing equipment, time switches, tools, transformers, transmitters, valves (tubes), wholesale distributors, wires and cables.

Space does not permit the discussion of any of these products in detail, but I have noticed certain differences in emphasis between the present British market and our own. I am not certain that the figures would bear me out, but I received the distinct impression that there are more individual manufacturers of television and radio in England than in the United States. I also noticed much heavier emphasis on short- and long-wave receivers for use in the home, as well as equipment of all kinds built especially for certain climatic conditions such as the tropics. I believe that portable and small table-model radio-phonograph combinations are seen more today in England than in the United States—at least that is the impression that one gets at the Radio Show. There is a tremendous general interest on the part of the British public in the various products of the British radio industry.

It would appear to me that a great deal could be gained by both sides in our industry if there were more visits across the Atlantic in both directions. While I think our British cousins could probably profit by seeing some of our trade shows, I also strongly feel that we have quite a lot to learn from them when it comes to putting on an exhibition such as the Radio Show.

New
**WILLIAMSON
TYPE**

AMPLIFIER Features

- First Williamson Type Amplifier supplied with matching preamplifier
- Uses Altec Lansing Peerless output transformer.
- Practically distortionless — Harmonic and intermodulation distortion both less than 1/2 of 1% at 5 watts output.
- Frequency response ± 1 db from 10 cycles to 100 kc.
- Output impedance 4, 8, or 16 ohms.

The new Heathkit Williamson Type Amplifier kit is the best obtainable in amplifiers today — the choice of the really discerning listener. You can hear the difference and measurements actually bear out the superb performance. Frequency response ± 1 db from 10 cycles to 100 kc allow you to hear the highs and lows with equal crispness and clarity. Harmonic and intermodulation distortion both less than 1/2 of 1% at 5 watts output eliminate the harsh and unpleasant qualities which contribute to listening fatigue.

The circuit is similar to the one published in Audio Engineering Magazine for November, 1949, and is considered by engineers throughout the radio field as one of the best ever developed. The Main Amplifier (which may be purchased separately) consists of a voltage amplifier and phase splitter using a 6SN7, a driver stage using a 6SN7, and a push-pull output stage using a pair of 807 tubes. The output transformer is manufactured by the Peerless Division of Altec Lansing and is built to their highest standards. Output impedances of 4, 8, and 16 ohms are available. The power supply uses a separate chassis with husky Chicago Transformer power transformer and choke, and 700V Mallory filters for long hum-free operation. A 5V4G rectifier is used.

The main amplifier and power supply are each on a chassis measuring 7" high by 5 1/2" wide by 11" long.

PREAMPLIFIER AND TONE CONTROL UNIT KIT

The preamplifier kit consists of: a 12AX7 (or 12AY7) dual triode first amplifier stage with a turn-over control for LP or 78 record types, and a 12AU7 amplifier stage with individual bass and treble tone controls which each provide up to 10db of boost or attenuation. A switch on panel selects either magnetic, crystal, or tuner inputs. Preamplifier also is well suited to custom installations — it will operate in either vertical or horizontal position, and special notched shafts of the controls and switches allow a variety of shaft lengths to be selected. Dimensions: 2 1/4" high by 10 1/4" wide by 7 3/4" deep.

WRITE FOR Free CATALOG

The
HEATH COMPANY
BENTON HARBOR 25,
MICHIGAN

WA-A1 Amplifier Kit — Combination 1 — (Main Amplifier and Power Supply) complete with WA-P1 Preamplifier kit. Total Ship. Wgt., 34 lbs. (Shipped Express only) **\$69.50**

WA-A1 Amplifier kit only — Combination 4 — (Main Amplifier and Power Supply). Less WA-P1 Preamplifier. Total Ship. Wgt., 29 lbs. (Shipped Express only) **\$49.75**

WA-P1 Preamplifier Kit only. (less power supply) (Tubes included). Total Ship. Wgt., 7 lbs. (Shipped Express or Parcel Post) **\$19.75**

You save by ORDERING DIRECT!

NEW PERFORMANCE STANDARDS

with the **WEATHERS FM CAPACITANCE CARTRIDGE**

20 to 20,000 Cycles Response

W-202 or W-202-C Cartridge Set



DO YOU REALIZE WHAT LOWER STYLUS PRESSURE CAN DO FOR REPRODUCTION FIDELITY AND RECORD LIFE?????

You can operate with stylus pressures down to one gram with the new WEATHERS Cartridge!

Get the NEW W-202-C Cartridge Set for your present record player (automatic or manual to enjoy unexcelled high fidelity reproduction).



For the ultimate in record reproduction, with one gram stylus pressure, combine the standard W-202 Cartridge Set with the new WEATHERS W-12 or W-16 Reproducer Arm.

Change to the WEATHERS Cartridge NOW and preserve your records for the years to come.

WEATHERS INDUSTRIES
Box 531 66 E. Gloucester Pike
Barrington, N. J.

See your dealer or write for literature

81

NEW!

Here Is Audio's Finest Cabinetry

The
BARTOK



The
SCHUBERT

Long known as the country's leading builder of cabinets for custom-built TV receivers, River Edge now presents a distinguished series of enclosures for home music systems.

Distinctive in appearance—built to the high standards of fine furniture—acoustically engineered by C. G. McProud—these new River Edge cabinets offer no compromise with quality. Yet they are moderately priced. Available in a wide range of authentic styles. See them at your nearby sound department.

See us in Room 504 at the Audio Fair!

EXCLUSIVE FEATURES

- Speaker enclosures are horn-loading type equipped with McProud-designed "Flex-O-Port"—adjustable to match the speaker of your choice.
- All cabinets made from the original species of wood specified in the finish.
- Heavy 1 5/16-inch plywood used throughout—corners mitre-locked and reinforced with blocks.

Write today for handsomely-illustrated Brochure HR-2

RIVER EDGE INDUSTRIES

River Edge, New Jersey, ORadell 8-0900
N. Y. Showroom: 192 Lexington Ave., CHickering 4-2120



ANOTHER PENTRON EXCLUSIVE

NOW! Over 4 HOURS RECORDING & PLAYBACK

NEW

MULTI-SPEED
PENTRON
TAPE RECORDER

10 1/2" REEL ADAPTER attaches in 1 Minute

Designed for standard N.A.B. reels. Converts Pentron recorder and players . . . doubles normal playing time for professional needs. Reel adapter can also be used for smaller size reels without detaching from recorder or player.

X302
Reel Extension Kit
List \$30.00

THE PENTRON CORPORATION

221-Ar E. Cullerton St., Chicago 16, Ill.
In Canada: Atlas Radio Corp., Ltd., Toronto

CONVENTION PROGRAM

[Continued from page 58]

THURSDAY, October 30 (cont'd)

2:00 p.m. Technical Session

INTERMODULATION DISTORTION SYMPOSIUM

INTERMODULATION MEASUREMENTS, H. H. Scott, *Herman Hosmer Scott, Inc.*

MEASUREMENT OF NON-LINEAR DISTORTION, Alan Bloch, *Audio Instrument Company, Inc.*

COMPARATIVE STUDY OF METHODS FOR MEASURING NON-LINEAR DISTORTION IN BROADCASTING AUDIO FACILITIES, Donald E. Maxwell, *Electronics Laboratory, General Electric Company*

DISTORTION IN PHONOGRAPH REPRODUCTION, H. E. Roys, *RCA Victor Division.*

FRIDAY, October 31

10:00 a.m. Technical Session

SPEECH INPUT SYSTEMS

BASIC PROBLEMS IN AUDIO SYSTEMS PRACTICE, W. Earl Stewart, *RCA Victor Division*

AUDIO FREQUENCY INPUT CIRCUITS, William B. Snow, *Vitro Corporation of America*

ATTENUATOR TYPES AND THEIR APPLICATION, Chester F. Scott, *The Daven Company*

THE DESIGN OF SPEECH INPUT CONSOLES FOR TELEVISION, Robert H. Tanner, *Northern Electric Company, Ltd.*

2:00 p.m. Technical Session

DESIGN DATA

CONSIDERATION OF SOME FACTORS CONCERNING THE USE OF AUDIO TRANSFORMERS, W. E. Lehnert, *Audio Development Company*

BYPASS AND DECOUPLING CIRCUITS IN AUDIO DESIGN, Lewis S. Goodfriend, *Audio Instrument Company, Inc.*

R-C NETWORKS IN AMPLIFIER DESIGN, Edwin D. Sisson, *Bell Sound Systems, Inc.*

ATTENUATION EQUALIZERS, F. R. Bies, *Bell Telephone Laboratories, Inc.*

NETWORK TRANSFORMATIONS, Leslie Norde, *Hammarlund Manufacturing Company.*

SATURDAY, November 1

10:00 a.m. Technical Session

HOME MUSIC SYSTEMS

ANALYZING THE LP PICKUP PROBLEM, Theodore Lindenberg, *Pickering & Company, Inc.*

BINAURAL SOUND REPRODUCTION AT HOME, Harold T. Sherman, *Sherman Studio*

TESTING AND ADJUSTING SPEAKER INSTALLATIONS WITH THE SOUND-SURVEY METER, William R. Thurston, *General Radio Company*

CONCERT HALL REALISM THROUGH THE USE OF A DYNAMIC LEVEL CONTROL, John Nigro, *Madison Radio Sound*, and Jerry B. Minter, *Measurements Corporation.*

more
**LISTENING
COMFORT**

with . . .

TELEX
Lightweight
Headsets!

the only personal
part of any
communication
system!



***MONOSET**

The modern styling and the dependability and superior performance of the TELEX Monoset have made old fashioned head-phones obsolete. Magnetic.



***DYNASET**

New dynamic under-chin TELEX Dynaset, with more highs and lows of both music and speech, is the delight of radio and TV monitors. Weighs only 1.25 oz.



***TWINSET**

This lightweight 1.6 oz. TELEX Twinset pipes signal directly into the ear, blocking out ground noises and banishing listening fatigue. Magnetic.



***EARSET**

Sensitive TELEX Earset slips onto ear and is preferred by all who use single-phone headsets. Weighs only 1/2 oz. and leaves other ear free for phone calls or conversation.

Modern, lightweight, durable . . . Easily adjustable and built for hard usage, TELEX Headsets give top quality reception without the punishment of extra weight and pressure.

Office Transcribing Machines • Radio Monitoring • Tele-casting • Amateur Radio • Record Stores • Theaters • Phone-Order Boards • Wired Music Installations • Commercial Communications • Electronic Laboratories.

Telex produces headsets to manufacturers' specifications



For complete information on any of the above headsets, write

TELEX
ELECTRO-ACOUSTIC
DIV., Department, 6-B
St. Paul 1, Minnesota

In Canada
ATLAS RADIO CORP.,
Toronto

*Trade Mark Standard of
the World for
Quality
Headsets

TELEX
HEARING AT
ITS BEST

**IMITATED
but not
EQUALLED**

Aerosound★

TO-300

**THE WORLD'S FINEST
OUTPUT TRANSFORMER**

This unique and superior transformer is designed for use in Ultra-Linear² circuits. On exhibit in Room 542 at the Audio Fair. Available at leading distributors for \$24.75 net.

ACRO PRODUCTS CO., 369 Shurs Lane, Phila. 28, Pa.
*Patent pending

Last Minute Letter—

Magnetic Tape
Sir:

Mr. Latham's article, "Limitations of Magnetic Tape," (Æ, Sept. 1952), may be perfectly correct in what it says, but we are inclined to take objection to its implications and to what was left unsaid.

After checking into the matter, it appears that Mr. Latham's article was written some time ago when pre-selected tapes for instrumentation applications were not commercially available. However, during the delay in getting the article cleared for publication, considerable progress has been made with improved tapes. Minnesota Mining has been extremely cooperative and has manufactured special tapes for instrumentation uses for over a year. Contrary to his article, therefore, such tapes are not unavailable and the price is not excessive.

Many laboratories are now using magnetic tape recorders for data analysis. It would appear that any budget that precludes the spending of a few extra dollars to purchase pre-selected tape for this purpose would nullify its entire usefulness.

Maintaining an opposite view would be analogous to purchasing a Cadillac and then complaining that it does not deliver peak performance because one cannot afford to purchase premium-type gasoline.

You are cordially invited to attend our demonstration of a new Ampex 0 to 100-kc recorder at the forthcoming Audio Fair. Improved recording techniques will be shown and various tapes will be used for direct comparison studies.

Kenneth B. Boothe,
Director, Instrumentation Division,
Audio & Video Products Corporation,
New York, N. Y.



*Employment
Register*

POSITIONS OPEN and AVAILABLE PERSONNEL may be listed here at no charge to industry or to members of the Society. For insertion in this column, brief announcements should be in the hands of the Secretary, Audio Engineering Society, P. O. Box 12, Old Chelsea Station, N. Y. 11, N. Y., before the fifth of the month preceding the date of issue.

★ Positions Open • Positions Wanted
★ Sales Engineer. Technically skilled and experienced man wanted by The Audio Exchange. Selling ability desirable. Must justify good salary. The Audio Exchange, 159-19 Hillside Ave., Jamaica 32, N. Y. OL 8-0445.

★ Audio Laboratory Development Engineer, communications background, familiar with advanced design and measurement of electronic circuits, components, networks, etc. Man with initiative and originality capable of analysis from fundamentals to get practical results expeditiously. Some familiarity with electro-acoustics desirable. Excellent opportunity for right man to build up development staff in growing company. Small friendly organization, country-life surroundings. Salary commensurate with training and relevant experience. Mail or bring resume. Phone for appointment only. Audio Equipment Company, 805 Little Neck Road, Great Neck, N. Y. Phone: Great Neck 4-8481.

Presenting
PHAN-TONE
STRAIN-SENSITIVE
PICKUPS

**PHAN-WOOD
TONEARM**
in the
luxurious setting
of
ARROW
ELECTRONICS'

Audio Center

designed to
**COMPLETELY
demonstrate
SOUND**
in its natural
setting

**PFANSTIEHL
CHEMICAL
COMPANY**

WAUKEGAN, ILLINOIS

Presenting

Jensen

**LOUDSPEAKER
EQUIPMENT**

for
HIGH FIDELITY SOUND

in the
luxurious setting
of
ARROW
ELECTRONICS'

Audio Center

designed to
**COMPLETELY
demonstrate
SOUND**
in its natural
setting

Observations on Demonstration Techniques

HARRIE K. RICHARDSON*

At home or in the showroom, audio equipment must be demonstrated properly if its capabilities are to be appreciated by the listener—whether a potential buyer or merely the owner of the system.

Presenting
V-M
TRI-O-MATIC
RECORD CHANGERS
AND
PHONOGRAPHS
in the
luxurious setting
of
ARROW
ELECTRONICS'

Audio Center

designed to
COMPLETELY
demonstrate
SOUND
in its natural
setting

V-M CORPORATION
BENTON HARBOR
MICHIGAN

Presenting
SOUNDMIRROR
TAPE RECORDERS[®]
in the
luxurious setting
of
ARROW
ELECTRONICS'

Audio Center

designed to
COMPLETELY
demonstrate
SOUND
in its natural
setting

**THE BRUSH
DEVELOPMENT CO.**
CLEVELAND, OHIO

AS THE MARKET for high-quality audio equipment has expanded to include millions of music lovers whose interest in the science of sound is strictly non-technical, there has become increasingly apparent the need for improvement in demonstration technique.

Only a few short years ago, the average buyer of high-fidelity equipment was so engineeringish in character that he was perfectly satisfied to select an amplifier simply on the strength of its ability to cover a wide frequency range. Frequently, an entire demonstration set-up consisted of nothing more nor less than an audio oscillator, the amplifier in question, and a VU (pardon, it was *db* in those days) meter. On the strength of the meter's gyrations, the amplifier found a happy home or prolonged its stay on the dealer's shelf—without uttering a single sound.

Those who bought audio equipment in the ways we speak of cared very little about music in an esthetic sense. So far as they were concerned, music was but a necessary evil to be endured as a concession to friends and neighbors who refused to share their enthusiasm for curves and characteristics, also to the local fire department which found no amusement in the siren-like goings-on of an oscillator feeding a lot of watts into a batch of speakers.

Speaking in a literal sense, them days is gone forever. Figuratively, though, their influence remains, as is evidenced by the antiquated demonstration techniques which still prevail in the showrooms of many less-advanced dealers and jobbers. Also not entirely guiltless of retarding the enthusiasm of audio's newly found apostles are thousands of hi-fi bugs who evaluate a music system purely on the strength of how high and how low it will go and, more importantly, how loud it will play. This brings us to the cardinal sin of most demonstrations.

Don't Play the System Too Loud

There is no question about extended frequency response and low distortion being the prime requisites of any good music system, but both qualities are nullified if the gain control is cranked up to the extent that there is discomfort on the part of the listener. Naturally, this level will vary with the individual, and as a consequence no hard and set rule can be established—however there are a few points which can be accepted as a fairly safe guide.

First, forget all you have read about duplicating the full volume of a symphony orchestra in an average living room. Practically speaking, it can't be done—and even if you could do it you wouldn't like it. Remember, in a concert hall there is sufficient cubic volume to permit dissipation of the tremendous sound energy generated by a full symphony orchestra and, if the hall is correct acoustically, there is a pleasing ratio of direct to reflected sound which is quite apparent on well-made recordings.

To achieve identical reproduction of a symphony orchestra by electrical means, your living room would have to be as large as the auditorium in which the live performance transpired—and the walls would have to afford complete absorption in order to avoid the effect of the room's own acoustical qualities. Naturally, such idealized conditions are beyond the realm of probability.

Where small groups—such as string quartets, or soloists—are concerned, you may well attempt to duplicate the full level of the live performance. Such combinations sound best when they are heard in fairly intimate surroundings—small public dining rooms, for example—many of which approximate in size an average sound demonstration room. Here the fact that the physical dimensions of the two rooms are nearly the same—both being ideally suited for listening to a small chamber group—in-

* Associate Editor, AUDIO ENGINEERING.

icates that the sound level of the electrical reproduction may well equal that of the live performance with enjoyable results.

When music is heard through a high-quality audio system, it is most pleasant when it is reproduced at a level which delivers to the listener's ears the same magnitude of sound pressure that he would receive at the original live performance. This is not to say that the *actual sound level* of the original performance must be duplicated—but that the *effect* of the performance can be recreated if the sound output of the music system is adjusted in keeping with physical surroundings.

To the best of the writer's knowledge, there has been no complete research covering this entire question. Personal experience, however, indicates that the relationship which exists between the sound level of a live performance and that of the reproduction should closely approximate the relationship which exists between the cubic volume of the hall in which the live performance occurred and that of the room in which the reproduction takes place.

One thing is certain beyond all doubt—when music is reproduced under circumstances which do not permit the same degree of sound energy dissipation, relatively speaking, as that which prevailed at the original performance, there will be lacking the very quality of naturalness you are striving to attain.

Don't Be Afraid to Use Tone Controls

It has long been a mystery to me why there is such reluctance on the part of audio hobbyists and sound equipment demonstrators alike to make use of tone controls. The controls on a modern high-quality amplifier are precision devices in every respect—designed to compensate for the frequency deficiencies of incoming broadcast signals or recordings. Yet, from the way these useful little devices are shunned by many demonstrators, you'd think their only function was to mask shortcomings of the amplifier itself.

Recordings—even those of the same manufacturer—vary in quality all over the lot. Even though careful control is maintained over every technical operation, pick-up conditions differ, to say nothing of the likes and dislikes of various conductors and recording engineers. A good case in point is the *London Montovani* record which is enjoying such popularity at present.

Audio characteristics of broadcast stations, too, seem to vary more in keeping with personalities than with technicalities. In the New York area there are at least a dozen FM stations on the air, each of which could be recognized by its audio quality, even though its call letters were never mentioned.

In the face of all this, it is difficult to understand the audio fan or demonstrator who mentions a dozen times per minute that his amplifier is reproducing

everything from d.c. to r.f. flat within zero db, yet is apparently oblivious to the fact that the resultant sound could stand a good shot of chlorophyll—when all he has to do to correct the situation is touch a tone control.

In most modern input signals—whether from a pickup or a tuner—the weakness lies in linearity, caused by the individualities of recordings and broadcast stations. In other words, the wanted frequencies are in the signal all right, but not in the proper proportion to meet *your* listening desires. Well-designed tone controls are capable of compensating for even the most pronounced case of too much or too little bass or treble—of making the incoming signal meet *your* standard of what the music should sound like, which is not necessarily that of the broadcast or recording engineer.

Only through the use of tone controls can you be certain of achieving the response that suits you, irrespective of input signal quality. If you are a music lover, make liberal use of your tone controls to add to the enjoyment of your music system. If you are a demon-

strator, use them to clinch your sales; remember, the person entering your sound studio for the first time is there to find out for himself if high-quality audio will give him the same fine music he has heard in the homes of friends. The answer is to let him hear music as he likes to hear it—and generous use of tone controls provides the means.

* * *

The points mentioned are paramount among those which govern the success or the undoing of any demonstration of a home music system, and they are those which are most frequently abused. There are many other items which bear heavily on this subject, and which may be covered in subsequent approaches—such as choice of program material, avoidance of worn or scratched records, etc. The big thing to remember is that thousands of newcomers who are approaching the audio field for the first time are interested in music and music alone. The method of its achievement is entirely incidental. All you have to do is play a record and make it sound the way it *should*—and you've sold a bill of goods.



Music . . .

Pre-Recorded On Magnetic Tape!

The new A-V Tape Libraries catalog of magnetic tape recordings is now available.

See it! Hear it!

at the Audio Fair . . . Rooms 614 & 615

A-V Tape Libraries INC.

730 Fifth Avenue, New York 19, New York. PLAZA 7-3091

THE WILLIAMSON AMPLIFIER

The first production model endorsed and signed by the designer

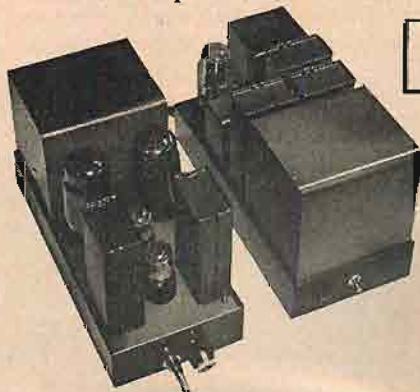

D. S. N. Williamson.

SPECIFICATIONS

- Output: 15 watt peak, 12 watt *undistorted*, within 0.2 db from 19 c/s to 20,000 c/s; harmonic distortion at full output within 0.1%; noise level better than 90 db below full output.
 - Output Impedances: Choice of 1, 4, 9, 16, 25, 36, 49 and 64 ohms by series/parallel arrangements of 8 secondary windings, so matching, without losses, a wide diversity of speaker combinations.
 - Tube Complement: Two 6SN7, two KT66, one 5Y4 rectifier.
- Construction: The power and amplifier units are on separate chassis 12" L, 3 1/2" W, 6 3/4" H. All filter condensers are oil filled paper. Transformers and chokes are specially wound and are screened in matching compound filled steel cases.
- Has output socket for supplying power to a control unit. Adjustable balancing controls and metering jacks are fitted. All jacks and sockets are of standard American type. Replacements of all specially machined parts are available in the U.S.A.

Price \$150.00 net in U.S.A.*
DEALER ENQUIRIES INVITED

Engineered in England to precise standards, this Amplifier is an integrated design and gives a guaranteed performance with reliability and consistency.

* Prices for Canada and South & Central America on request.

BRITISH RADIO ELECTRONICS, LTD.

ONE THOMAS CIRCLE • WASHINGTON 5, D. C.

BEST IN SOUND
always in Stock at

HUDSON
RADIO & TELEVISION CORP.

Super Horn
LOUDSPEAKER ENCLOSURES



Engineered
to Give You
the Most
from Your
Speaker

L TONAL REALISM

production without resonant peaks or
... is the keynote of SUPER-HORN
ring. Full bass down to 40 cps is ac-
reproduced by an exponential horn.
ights are radiated directly from the
the speaker with no tuned cavities or
produce false bass or "boom." Classic
of line is combined with rugged dura-
l panels are of 3/4" and 3/8" woods,
y braced to prevent vibration.

NET PRICES

12"	\$80.00	15"	\$85.00
12"	\$75.00	15"	\$80.00

HUDSON
HI-FI CATALOG
FREE!

complete buy-
of its kind
packed with
finest High
Audio Equip-
professional
installation.

Compare!
push button
control, over
binations of
amous high
ponents.

Ultra-Modern
Studios



Send for your FREE
Catalog today!

HUDSON
RADIO & TELEVISION CORP.

Circle 6-4060

46 WEST 48th ST. • 212 FULTON ST.
New York 36, N. Y. (Dept. D-10) New York 7, N. Y.

Please send FREE copy of 1953 Hudson Catalog
Enclosed is check M.O. \$.....
 Ship the following:

Name.....
Address.....
City.....
Zone..... State.....

FAIR PREVIEW

[from page 60]

features which are certain to popularize it with architects and builders.

As in previous years, Hermon Hosmer Scott, Inc., will attract both professional engineers and music lovers with a showing of fine equipment ranging from sound measuring devices to high-quality amplifiers. This will be the initial public display of Scott's new Type 420-A Sound Analyzer, an advanced version of the famous 410-B Sound Level Meter.

Waveforms, Inc., also will offer a display of dual interest—including the miniature Model 510-B audio oscillator for engineers, and the new Model A-20-6 amplifier for music lovers.

Although Fairchild Recording Equipment Corporation is planning to display a complete line of recording and playback equip-

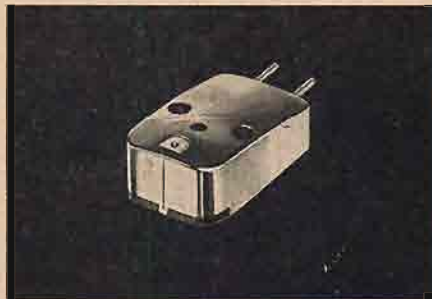

ment, interest of observers is expected to focus on the improved Fairchild miniature dynamic cartridge.

* * *

There you have it—a wee peek into some of the enchanting exhibits which are being planned to make your visit to the 1952 Audio Fair both interesting and enjoyable. Schedule of the Fair is as follows: Wednesday, October 29, 10 a.m. to 9 p.m.; Thursday, October 30, 10 a.m. to 6 p.m.; Friday, October 31, 10 a.m. to 10 p.m.; Saturday, November 1, 10 a.m. to 5 p.m.

Whether you are an engineer, a music lover, or a dealer—so long as you have an interest in audio—the Fair offers you four fabulous days you will never forget. The Audio Fair is YOUR affair — so BE THERE!

ADCOLA

REGISTERED TRADE MARK

SOLDERING INSTRUMENTS

Any Voltage Range Supplied from 6/7 to 230/250 volts. Our instruments for 110 volts are superb in making

SOUND JOINTS
for all

SOUND EQUIPMENT

Supplied to leading British electrical manufacturers and H.M. and foreign government departments.

These soldering instruments are named instruments as they are such a complete departure in design from the usual solder bolt or iron and are ideal for all modern assembly and maintenance work on telecommunications, radar, television, wireless, etc.

3/16" dia. bit Standard Models
3/16" Detachable Bit Type (Factory Bench Line)

- Heating time: 90 seconds
- Consumption: 25 watts
- Weight: 4 ozs.
- High temperature
- Handle unaffected by element temperature
- Length of instrument: 9"
- Equally suitable for daily or intermittent use
- Prices
Standard 3/16" Bit Model \$3.15
Standard 1/4" Bit Model 3.50
Detachable 3/16" Bit Model 4.20

Catalogue sent free on request.
MADE IN ENGLAND
Registered Design (U.S.A., British, & Foreign Patents)

Write direct to sole manufacturers and suppliers:

ADCOLA PRODUCTS, LTD.
CRANMER COURT
CLAPHAM HIGH STREET
LONDON, S.W. 4, ENGLAND

Standard Model 3/16" Bit Illustrated



Engineers...

for **SKL** Electronic Instruments
produced by

SPENCER-KENNEDY LABORATORIES, INC.



see **Audio & Video**

PRODUCTS CORPORATION

730 Fifth Avenue, New York 19, N. Y. • Plaza 7-3091

Exhibiting at the Audio Fair — Rooms 614 & 615

AUDIO ENGINEERING • OCTOBER, 1952

AMPERITE

Studio Microphones
at P.A. Prices

Ideal for
BROADCASTING
RECORDING
PUBLIC ADDRESS

"The ultimate in microphone quality," says Evan Rushing, sound engineer of the Hotel New Yorker.

• Shout right into the new Amperite Microphone—or stand 2 feet away—reproduction is always perfect.

• Not affected by any climatic conditions.

• Guaranteed to withstand severe "knocking around."



Models
RBLG—200 ohms
RBHG—Hi-imp.
List \$42.00



"Kontak" Mikes
Model SKH, list \$12.00
Model KKH, list \$18.00

Special Offer: Write for Special Introductory Offer, and 4-page illustrated folder.

AMPERITE Company, Inc.

561 BROADWAY • NEW YORK 12, N. Y.

Canada: Atlas Radio Corp., Ltd., 560 King St. W., Toronto

Capture the
*Missing Music*TM
With a
PFAN-WOOD
Functional Design
TONEARM!



Discover the hidden music in records—untapped by standard phonograph equipment. Use a good turntable, let the PFAN-WOOD TONEARM with a Strain-Sensitive Pickup* bring out the best in your records—old and new.

- ✓ Near Perfect Tracking gives friction-free lateral, vertical motion.
- ✓ Adjustable Needle Pressure, Tracking Angle.
- ✓ Different Woods dampen resonances, prevent transfer of vertical, horizontal vibrations.
- ✓ Adjustable Height and Vertical Alignment.

PFAN-WOOD TONEARM is equipped for the PFAN-TONE Strain-Sensitive Pickup. *Adapters available to use other pickups.

Ask your radio supply man or write today for FREE INFORMATION.

Pfanstiehl
CHEMICAL COMPANY

104 Lake View Avenue Waukegan, Illinois
NOW READY—GENUINE PFANSTIEHL REPLACEMENT NEEDLES tipped with Patented M47B Alloy, for all popular cartridges.

NEW LITERATURE

• **Miniature Precision Bearings, Inc.**, Keene, N. H. gives complete specifications on more than 120 different types and sizes of miniature ball bearings in Catalog 52B, now available on request. Although only 4 pages in size, this publication is a virtual necessity to designers and manufacturers of aviation instruments, cameras, indicating and recording mechanisms, and other precision equipment where weight, space, and friction problems are presented.

• **Dow Corning Corporation**, Midland, Mich. has prepared a thoroughly interesting 32-page book on Dow Corning 200 Fluid, the simplest of all the silicones. The product's remarkable versatility has resulted in many misunderstandings as to the nature of the fluid itself—all of which will be cleared up by this book lists all properties from boiling point to sound transmission. A most worthwhile publication if your interest lies in the field of silicones.

• **Triad Transformer Manufacturing Co.**, P.O. Box 17813, Los Angeles 34, Calif., lists more than 450 items with specifications and prices in Catalog TR-52. Included are hermetically-sealed transformers designed to MIL-T-27 specs, high-quality audio transformers, 400-cycle power transformers, toroids, geophysical transformers, and amplifier kits. Copy will be mailed on request.

• **Keithley Instruments**, 3868 Carnegie Ave., Cleveland 15, Ohio, is releasing a 2-page folder describing the company's new Model 109 electronic wattmeter. Contained in the bulletin are detailed description, specifications, and suggested uses, including transformer core loss and copper loss tests, measuring audio power to speakers, and power measurements at aircraft frequencies.

• **Precision Paper Tube Company**, 2035 W. Charleston St., Chicago 47, Ill. has published a new arbor list in catalog form, in which are described more than 1500 sizes and shapes of tubing available on regular order. The 16-page booklet will be mailed on request to industrial users.

• **Lenkurt Electric Co.**, 1131 County Road, San Carlos, Calif. describes the properties of a wide range of high "Q" toroidal inductors in Bulletin TL-P4. Included in the listings are "Q" curves of the various coils as well as representative standard values. Inductance values range from 1 mh to 80 h, and tolerance is within 1 per cent. Copy will be mailed on request.

• **Gibson Electric Company**, 3312 Franks-town Ave., Pittsburgh 21, Pa. describes properties and uses of the company's line of electrical contacts in a new, well-prepared 12-page catalog. Of particular value to engineers is a discussion of various alloys, and a section devoted to the selection of contacts for various applications. Your request should specify Catalog C-520.

• **Federal Telephone and Radio Corporation**, 100 Kingsland Road, Clifton, N. J. has produced a sound and color motion picture titled "Modern Communications with Microwave" which is available for company personnel and group showings. Described graphically and convincingly is the development of microwave radio relay and its applications in modern day industry. In preparing this film Federal has presented the electronics industry with a vital service, for which the company deserves great commendation. The film is 16 mm and runs for 20 minutes. Inquiries should be addressed to Film Distributing Department. If you don't see this you are really missing something.

• **Receiving Tube Division, Raytheon Manufacturing Company**, 55 Chapel St., Newton 58, Mass. announces six new subminiature tubes in a booklet which is now available for distribution. Included among the new tube types are a dual diode, three dual triodes, a voltage regulator tube, and a voltage reference tube. Essential interest in this book lies with design engineers. Requests should be addressed to Technical Information Service, Special Tube Section.

• **Califone Corporation**, 1041 N. Sycamore Ave., Hollywood 38, Calif. is now releasing a new 8-page 2-color catalog which illustrates and describes the company's new 1953 portable phonographs, transcription players, and sound systems. Mailed with each catalog is a combined specification and price sheet.

CONGRATULATIONS

to
ARROW
ELECTRONICS'

Audio Center

on creating
a new
and
inspiring
way to
demonstrate

Tech-Master
TELEVISION CHASSIS
TV AND AUDIO KITS

TECH-MASTER
PRODUCTS

443 BROADWAY
NEW YORK, N. Y.

Presenting

Permoflux

SPEAKERS

in the
luxurious setting
of
ARROW
ELECTRONICS'

Audio Center

designed to
COMPLETELY
demonstrate
SOUND
in its natural
setting

PERMOFLUX CORP.
4900 WEST GRAND AVENUE
CHICAGO 39, ILLINOIS

TRON

TI-SPEED
RECORDER
ACCESSORIES

to make
NARROW
TRONICS'

Center

COMPLETELY
designed to
demonstrate
SOUND
in its natural
setting

ENTRON
RATION
MULLERTON
16, ILL.

enting

forms

FIDELITY
IFIER

he
s setting

OW
ONICS'

Center

designed to
COMPLETELY
demonstrate
SOUND
in its natural
setting

SOUND HANDBOOK

[continued from page 37]

slightly towards that of the independent edge tone, and the final resultant frequency is a compromise between the two, with the air resonance very much predominant. The influence of the edge tone, however, cannot be disregarded. For example, the natural periods of the edge tone and of the air column in an organ pipe must be similar in value, or a relatively long time will be required for energy to build up in the column vibration, and the pipe will not "speak" promptly. (Adjustment of the pipe's edge-tone frequency is one of the problems of the "voicer.") Another example of the influence of the natural frequency of the edge tone may be seen in the control of pitch which the flutist can exert by varying the intensity of his blowing.

The resonant frequencies of an air column, as we have seen, depend upon its effective length rather than its physical length, and the end correction, a function of the diameter of the pipe, also varies with the order of harmonic. The pipe is thus slightly mistuned for some of the harmonic overtones, producing a discordant note. This effect may be counteracted by using a narrow pipe with a much smaller end correction, or by suppressing the higher-order harmonics in the pipe and using separate pipes with high-frequency fundamentals to inject the desired overtone directly.

The resonant frequency of an air column is dependent on the speed of sound in the enclosed medium. Since this speed varies with the temperature it is important that the flue pipes of an organ are not distributed over parts of a building which are likely to maintain temperatures different from one another. A change of 20° Fahrenheit will increase the general pitch about half a semitone. In this connection it is interesting to note that in certain types of organ pipes the primary sound generator is a reed. The vibration of the mechanical reed is not nearly as much a slave to the air column as is the edge tone, with the result that a rise in temperature which affects all of the flue

pipes in the same way has less effect on the reed pipes. The reeds may therefore seem to go sharp or flat as a group when the temperature changes.

The reed organ stops are used to create the sharper timbres. In the older organs the reed was allowed to strike the aperture which released the air stream, so that air current stoppage was both sudden and complete, and the upper harmonics were very prominent. This produced a fiery, almost savage tone which may still be heard in certain recordings. Most modern organs curve the end of the reed in such a way that the air jet is not cut off as suddenly, and the tone is smoother.

Ordinary organs produce fundamentals down to perhaps 30 cps, but a few have been built for subsonic fundamentals as low as 8 cps.

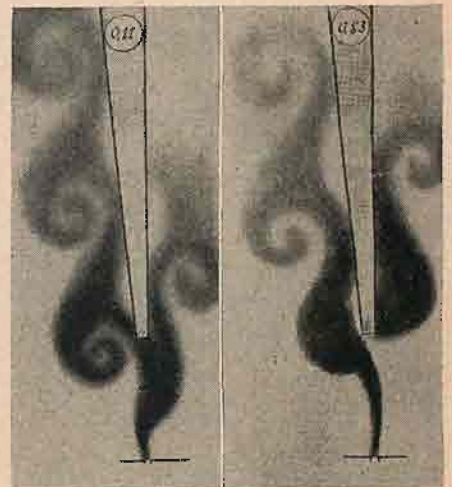

Fig. 5-3. Eddies formed at the lip of an organ pipe. The original photographs were taken by mixing fine smoke with the air. (Courtesy Journal de Physique.)

The flute and its higher-pitched sister, the piccolo, work in a similar way to the flue organ pipe. In the former instruments the edge tone is created by blowing transversely across the blow hole, and the exciting stimulus for all frequencies must be produced at the same lip. The effective length of the air column is varied by opening holes in the tube through a system of levers and keys. When the player "overblows" he

Electro-Voice

MICROPHONES • PHONO PICKUPS
HIGH FIDELITY LOUDSPEAKER SYSTEMS

are available from



Audio & Video

PRODUCTS CORPORATION

730 Fifth Avenue, New York 19, N.Y. • PLaza 7-3091

Exhibiting at the Audio Fair — Rooms 614 & 615

**New Life for High Fidelity
and Paging Systems**

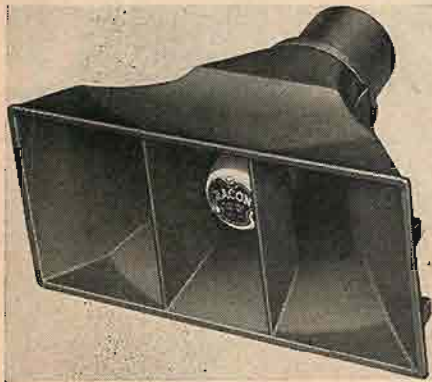

The Model COB-16 Loudspeaker. . . .

Cast aluminum rectangular horn design results in an all-useful concentrated beam of sound 35° vertically and 100° horizontally, free from disturbing reflections and echoes. Response 350 to 11,000 cycles, continuous power rating 25 watts. Available in 8, 15 or 45 ohms. For public address use or as a mid-range speaker in three-way high fidelity speaker systems. Ample space provided for transformer where required. Flush mounted. Dimensions 12 3/8" W, 6" H, 10 1/2" D. Buy it at your favorite sound distributor or order direct. Net price \$38.22.

Free catalog!

In Canada:
Dominion
Sound
Equipments,
Ltd.



For
HIGH FIDELITY
in
MINNEAPOLIS



Call **Lincoln 8678**
ELECTRONIC CENTER, INC.
107 Third Avenue North

WE FEATURE:

- McINTOSH
- RADIO CRAFTSMEN
- PICKERING
- ELECTRO-VOICE
- GARRARD
- GENERAL ELECTRIC
- WEATHERS
- GROMMES
- REK-O-KUT
- R-J ENCLOSURES
- PERMOFLUX
- And others

**SEE US for tape recorders,
tuners, amplifiers and kits.**

raises the edge tone in fundamental frequency so that it meshes with a har-

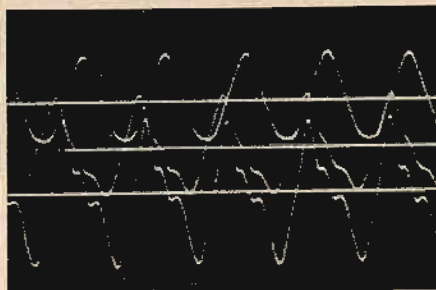

Fig. 5-4. Oscillograms of wave forms produced by a flute blown p (top), mf (middle), and f (bottom). (Courtesy Case Institute of Technology, from "The Science of Musical Sounds," by Dayton C. Miller.

monic mode of the air column resonance. The pitch thus jumps an octave on the first overblowing (since the second harmonic has a frequency ratio to the fundamental of two to one), and a fifth on the second overblowing (the third harmonic has a frequency ratio to the second of three to two).

The transverse flute is a very old musical instrument. In its primitive form the player blew across the end of a hollow reed, and later holes were introduced into the side of the reed to allow control of pitch. The immediate precursor of the modern transverse flute is the recorder, an instrument of the flute class whose edge tone is produced by blowing *into* the pipe, through a whistle head, rather than across it. In the middle of the 19th century Theobald Boehm developed the flute key mechanism and hole spacing which is used today. The Boehm system has also been adapted to the clarinet and oboe.

Flutes may be made of hard wood, brass, silver, or even gold. The material of the body of the instrument may affect its tone in two ways, by damping and by resonant vibration. *Figure 5-4* illustrates the wave forms produced by a flute blown at different intensities. The higher notes of the flute are of almost perfect sine-wave form.

Reed Woodwinds

The clarinet, oboe (that "ill wind that nobody blows good") and saxophone are reed woodwinds. Like the reed organ pipe these instruments use a mechanical vibrator to generate their primary sound. The reed may be single, as in the clarinet and saxophone, or double, as in instruments of the oboe family. The latter group includes the bassoon and an instrument with the misleading name of English horn. *Figure 5-5* shows the characteristic wave form of the oboe.

In all cases a steady flow of air is periodically throttled by a reed or reeds which vibrate in a direction transverse to the air flow. The stream of air first reduces the pressure between reeds or between the reed and the mouthpiece (an effect described by Bernoulli's theorem), forcing the passage to close; the reduced air flow of the constricted passage then allows the pressure to return to normal, and the reed springs back, inertia taking it beyond its nor-

RESCO
HAS THE NEW
GATELY
Super Horn
Increases cone acoustical damping by a factor of 3, greatly improving transient response

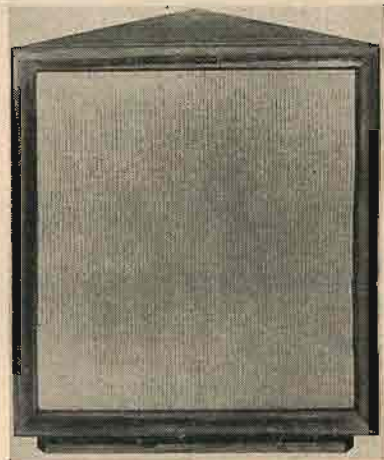

The air loading on the Super Horn operates in such a way as to increase acoustic damping of the speaker, minimizing

speaker hang over. This gives truer, cleaner reproduction. Acoustical damping combined with a lack of tuned cavities gives non-resonant response down to 40 cps, using typical 12 inch speakers. Because the Gately Super Horn is corner mounted, the walls and floor become an actual part of the speaker system.

Mahogany, 12" **\$75.00 net**

Mahogany, 15" **\$80.00 net**

Either model is available in blonde finish at \$5.00 extra.

Radio Electric
SERVICE CO. OF PENNA., INC.
7th & Arch Streets, Phila. 6, Pa.

Please ship Gately Super Horn as checked.

12 inch mahogany 12 inch blonde
 15 inch mahogany 15 inch blonde

Check or Money Order enclosed
(Shipping charges, express collect)

Name _____
Address _____
City _____ Zone _____ State _____

**Pay
LESS
for the BEST
in Amplified Sound!**



**BELL Model 2200
High Fidelity Amplifier**

No need now to hit the top price bracket for a full range, distortion-free, radio-phono amplifier. Bell's new Model 2200 gives amazing flexibility in use . . . delivers 20 watts at less than .3% distortion! Peak power is 35 watts. Here is superlative quality at a medium price for the utmost in listening pleasure!

MASTERFUL CONTROL!

Five-position equalizer switch affords ideal method for correcting recording characteristics on all types of records. Seven inputs, including radio, crystal phono, two magnetic pickups, TV, tape, and microphone, are selected by five-position switch. Bass and treble controls are continuously variable, with flat center positions. Volume control is compensated for low level listening.

MAGICAL RESPONSE!

Frequency response plus or minus 1/2 db 20 to 20,000 cycles, with controls set for flat response. Hum level 80 db below rated output. Unit has removable etched dial plate for console or custom installation, with six 1 3/4" extension shafts furnished. Three AC convenience outlets on back of chassis permit control of entire custom installation with master power switch on the amplifier.

WRITE FOR NEW HIGH FIDELITY FOLDER



BELL Sound Systems, Inc.

559 Marion Rd., Columbus 7, Ohio
Export Office: 401 Broadway, New York 13, N. Y.

IF YOU ARE MOVING

Please notify our Circulation Department at least 5 weeks in advance. The Post Office does not forward magazines sent to wrong destinations unless you pay additional postage, and we can NOT duplicate copies sent to you once. To save yourself, us, and the Post Office a headache, won't you please cooperate? When notifying us, please give your old address and your new address.

Circulation Department
RADIO MAGAZINES, INC.
Mineola, N. Y.
P. O. Box 629

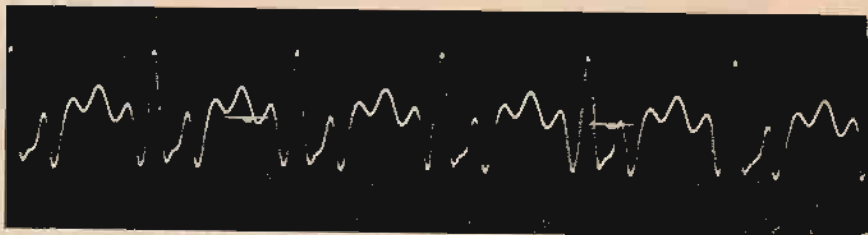

Fig. 5-5. Characteristic wave form of an oboe playing mf, at middle C. (Courtesy of Case Institute of Technology, from "The Science of Musical Sounds," by Dayton C. Miller.)

mal position. This cycle of events is repeated as long as the air stream is continued, and the throttling action is characterized by a saw-toothed wave form containing all of the harmonics. The controlled air-column resonances of the tube dominate the vibration frequencies of the reed; the coupled system creates a tone of the desired pitch and with a rich, expressive timbre. "Quacking" noises are produced by inexperienced players when the reed vibrations are allowed to escape from their coupling with the air column.

Brass Instruments

The mode of operation of various types of modern horns is illustrated by that of the simplest, the bugle. The player's lips, which are pressed against the cup-shaped mouthpiece, serve as the primary generator of alternating impulses, acting in a manner very similar to the double reed. The Bernoulli effect causes the lips to throttle the breath being forced into the bugle with a saw toothed periodicity, and the folded air column is stimulated at

several of its resonant modes. When the player changes tension on his lips he can force the fundamental frequency of the vibrating "lip-reeds" to mesh with some other resonant mode of the air column, and he therefore has command of a limited number of pitches. More complex brass instruments allow the player to change the length of the air column—by adding discrete sections of pipe through a system of valves, as in the trumpet, French horn, and tuba, or by sliding a telescopic assembly of tubes in and out, as in the trombone. It may be seen that the folded horn used for loud-speaker loading, in which a long, gradually flaring horn is made to occupy a reasonable space, is derived from the design of brass instruments like the tuba, in which a horn approximately 18 feet long is coiled into a fairly convenient shape.

In both reeds and brass the effective radiating surface is increased by the horn design.

Drums, triangles, cymbals, and like instruments are essentially mass-elas-

Fig. 5-6. Frequency and amplitude variation in the voice of singer Arthur Kraft performing a portion of "All Through the Night." Note that frequency vibrato is always present, but that amplitude vibrato is subdued and often absent. (Courtesy University of Iowa and Harold Seashore.)

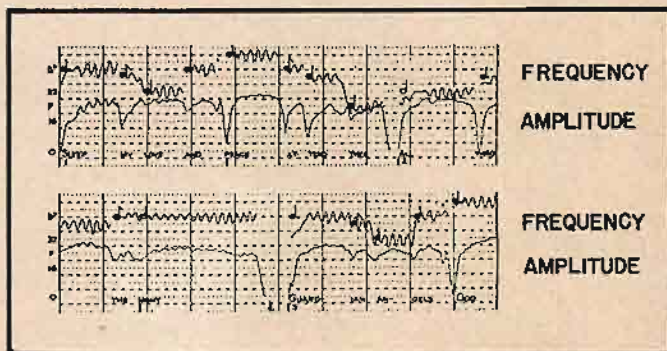
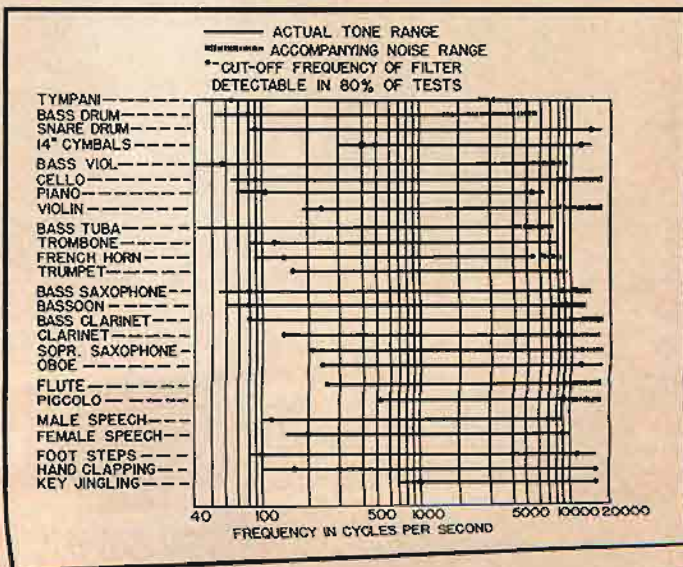

Fig. 5-7. Audible frequency range for music, speech, and noise, after W. B. Snow. (Courtesy J. Acous. Soc. Am.)



Air-Tone

HEADQUARTERS FOR SOUND EQUIPMENT

"IN PERSON" REALISM
IN YOUR OWN HOME

when you choose from our

LARGE SELECTION

- RECORD CHANGERS
- SPEAKERS
- AMPLIFIERS
- TAPE RECORDERS
- AM-FM TUNERS



NEWCOMB AMPLIFIER

Air-Tone

SOUND AND RECORDING CO.
1527 CHESTNUT ST.
PHILA. 2, PA. • RI-6-8388



have "HIGHS"
got you low?

Directional characteristics of the acoustical lens at 5000 cycles.

The new Jim Lansing acoustical lens gives the highs a smoothness your ear will appreciate instantly! The new lens, a natural development brought about by the inadequacies of the multicellular horn, distributes sound constantly and uniformly over the entire audio spectrum... giving the highs a smoothness impossible to match by any other method. Drop into your high fidelity dealer and ask for the full story today.

JIM LANSING → first in fine sound

JAMES B. LANSING SOUND, INC.
2439 Fletcher Dr., Los Angeles 39, California

AUDIO ENGINEERING • OCTOBER, 1952

ticity devices which are shock excited by a single blow and then allowed to vibrate of their own accord. Instruments like the kettle drum are tuned, producing a note which may be varied by adjusting tension on the membrane. The triangle, cymbal, and bass drum produce sounds whose harmonically unrelated partials² are so diverse that no sensation of definite pitch is created; the tone can only be identified as belonging to a general frequency area.

The Human Voice Mechanism

The human voice is produced in much the same way as is the sound of a reed instrument. The vocal cords, stimulated by a steady flow of air from the lungs, provide an initial vibration which is saw-toothed in wave form. The resonating elements of the vocal cavities can then be controlled to pick off and reinforce various harmonics, giving the sound its tonal structure.

The crooner rejects the classical use of the full singing voice and substitutes a sort of moan, which is inadequate in intensity for a public performance, but of proper amplitude to serve as the input stimulus of a public-address system. The electronic assembly of microphone, amplifier, and loudspeaker may be considered as an intrinsic part of the crooner's acoustical mechanism.

Intelligible speech is produced by varying the transient and frequency structure of successive sounds through changing the shape of the vocal cavities, especially of the mouth. The dependence of vowel identification upon frequency content is easily demonstrated; the vowel sound "ah," occurring on a phonograph record, may be changed to "aw" by decreasing the speed of the turntable. Unvoiced consonants like the hiss of the sibilants do not involve the vocal cords.

The Vibrato

Instruments differ considerably in the type and degree of control given to the performer. Where the player has continuous and immediate control of pitch and amplitude he can introduce a musical effect called *vibrato*. This consists of periodic variations, primarily of pitch but also of amplitude, subsonic in frequency, which enhance the musical value of the tone. Figure 5-6 illustrates the frequency and amplitude vibrato used by a concert singer. The "tremolo" stops on organs provide a mechanically produced vibrato.

Frequency Ranges

Figure 5-7 is a chart of the audible frequency ranges of various sounds. It is of interest to note that the theory of discord referred to in an earlier chapter, based upon the beat effect of non-coincident harmonics, is supported by the fact that certain chords may sound acceptable when performed upon instruments with limited overtones, but become intolerably discordant when sounded by other instruments with strong harmonics extending into the higher orders.

² A partial is any simple component of a complex sound.

CONGRATULATIONS

to
ARROW
ELECTRONICS'

AudioCenter

on creating
a new
and
inspiring
way to
demonstrate

Concertone
MAGNETIC TAPE
RECORDERS.

Manufactured By

Berlant Associates

4917 W. Jefferson Boulevard
Los Angeles 16, California

CLARKSTAN

ARMS AND
CARTRIDGES

help make

ARROW

ELECTRONICS'

AudioCenter

COMPLETELY

equipped to

demonstrate

SOUND

in its natural

setting

PACIFIC
TRANSDUCER
CORP.

(Formerly Clarkstan Corp.)

LOS ANGELES 64, CALIF.



Magnetic Recorders Co.

OFFERS YOU THE MOST COMPLETE LINES OF ALL TAPE RECORDERS PRICED FROM \$84.50 to \$1164.00

The West's Largest Recorder Distributors Choose from such famous lines as:

- | | |
|------------|-------------|
| AMPEX | MAGNASYNC |
| AMPRO | PENTRON |
| BELL | PRESTO |
| BRUSH | REVERE |
| CONCERTONE | SOUNDMIRROR |
| CRESTWOOD | STENO |
| DU KANE | SCRIBE |
| FLICOR | WEB-COR |
| KOTAPE | WILCOX-GAY |



(Magnasync Illustrated)

MAGNASYNC—The lightest weight, low-priced synchronous 16-mm tape recorder—yet offering fidelity comparable to the highest priced units.

—the West's most complete service facilities by trained recorder specialists, for free home demonstration.

Magnetic Recorders Company

1200 WILSON AVENUE
SANTA ANA, CALIF.
Phone Webster 3-5545

I'M RUSHING ANOTHER SHIPMENT OF FINE ELECTRO-VOICE SOUND PRODUCTS TO ARROW ELECTRONICS' LUXURY AUDIO CENTER!!



CLEAN BASS

[continued from page 29]

good horn design. The second, designed for 15-in. speakers has a taper rate to give a cutoff of 70 cps and has an effective mouth area of approximately 2500 sq. in., again satisfying the above requirements.

Figure 4 shows the impedance vs. frequency curve of a G.E. S1201D speaker mounted in an infinite baffle. The bass resonance of this combination is 54 cps. This curve and that of Figs.

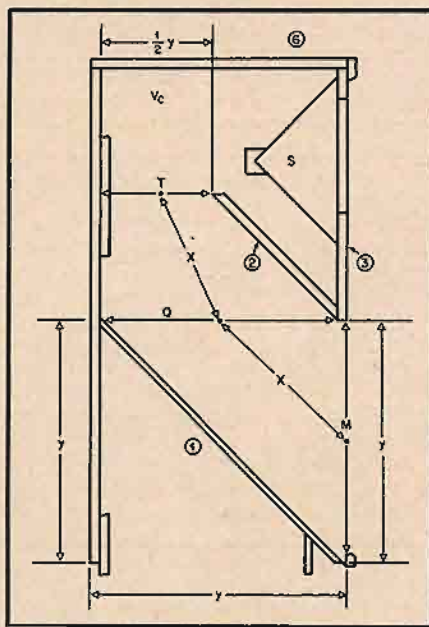

Fig. 2. Cross section of Super Horn through plane A-A of Fig. 1. Circled numbers indicate panel references in text

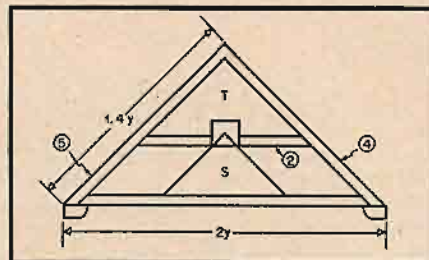

Fig. 3. Cross section of horn through plane B-B

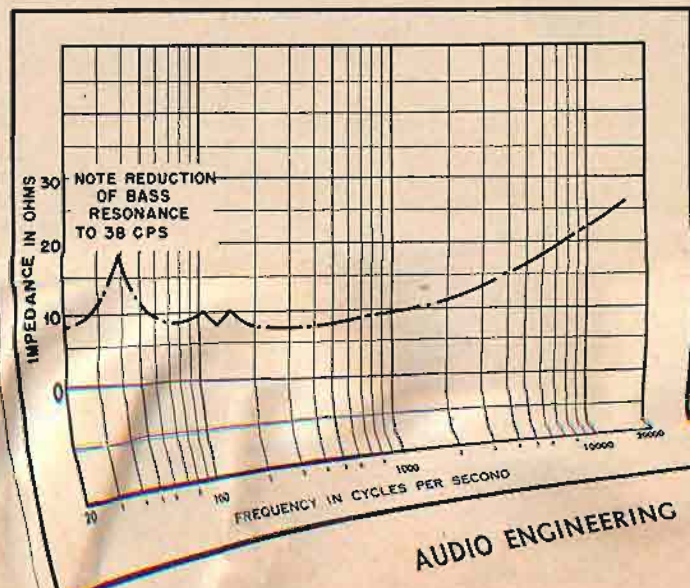

Fig. 6. Impedance curve of GE S-1201 D speaker mechanism in Super Horn.

5 and 6 were made by using the circuit shown in Fig. 7 and adjusting the decade resistance box until the voltage drop across it equalled the voltage across the speaker, thus indicating impedance directly. Figure 5 shows the impedance curve of the same speaker in a well padded enclosed box of 4 cu. ft. volume. Note that the resonance has been raised to 61 cps, or 20 per cent. Figure 6 shows the impedance curve of the same speaker in the Super Horn designed for 12-in. speakers. Note that the resonant frequency of the speaker has been reduced to 38 cps, or 27 per cent below infinite baffle mounting, or 40 per cent below that obtained in a totally enclosed box of the same approximate volume. Nearly a full octave has been added to the clean reproduction. This lowering of the resonant frequency shows that the air loading on the speaker is increased more than three times in the 40-cps region and even more at higher frequencies. Note the reduced amplitude of the resonant peak. This shows how the acoustical damping is increased.

It has been observed that radiation from the horn drops off rapidly below the cutoff frequency, but some frontal radiation from the cone of the speaker reinforces the lower frequencies and extends the reproduction. The acoustic loading is maintained down into the 40-cps region and acts as an acoustic damping on the cone, greatly improving the transient response and power handling ability of the system.

Early experimental work with this design indicated that if the best possible reproducer were to be constructed, then certain steps would have to be taken to eliminate panel vibration. The sides and front panel are made of 3/4-in. plywood. The internal panels 1 and 2 are made of 5/8-in. plywood, and these panels act as additional bracing for the sides. A spline or bone is run down the back at the intersection of the sides to give additional bracing, and to act as a back leg.

The ultimate test of any reproducer is how it sounds. When using live tape as source material, a good speaker and an Ultra Linear amplifier, the illusion of presence with the Super Horn is amazing. Organ music moves up and down

IMMEDIATE DELIVERY! NEW ALTEC DUPLEX SPEAKERS

12"

601A

\$89.00
NET



COMPLETE
WITH
NETWORK

\$114.00
NET

15"

602A

WEST COAST HIGH FIDELITY CENTER



**HOLLYWOOD
ELECTRONICS**

"IN THE AUDIO MILE"

7460 MELROSE AVENUE
LOS ANGELES 46, CALIFORNIA
WEBster 3-8208

AT THE FAIR

THE KARLSON ASSOCIATES

present

*The Karlson Speaker Enclosure
for*

Ultra-Fidelity Sound Reproduction

This new basic acoustic discovery, the exponential slot radiator, provides full range reproduction with clean flat bass from 25 cps up, resulting in a new standard of music reproduction, music you can FEEL.



Simulated "point source" provides wide angle dispersion filling room with sound, allowing enclosure to be placed anywhere in the room, and eliminating bass delay time of horns and ported boxes. "Liveness" due to greatly reduced distortion and true response to even the weakest transients. Higher outputs due to increased cone loading. A high-frequency response without stridency. Cut for either 12" or 15" coaxial speaker. Beautifully finished in Mahogany or Blonde. Small: 34½" x 22½" x 17"; under 6 cu ft inside! Price: \$94.50. Available direct.



For full information, write:

Karlson Associates
1379 EAST 15TH STREET
BROOKLYN 30, N. Y.

Pat. applied for

the scale and fundamentals are clearly reproduced. Bass transients, e.g. kettle drums, have a cleanness which only an untuned and highly damped reproducer can give. Plucked strings and the tym-

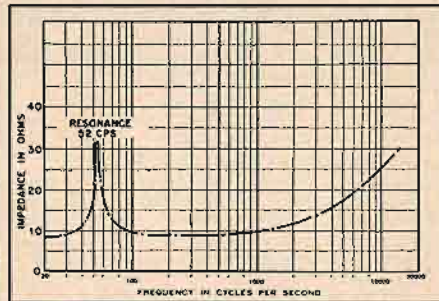

Fig. 4. Impedance curve for GE S-1201D speaker mechanism in true infinite baffle.

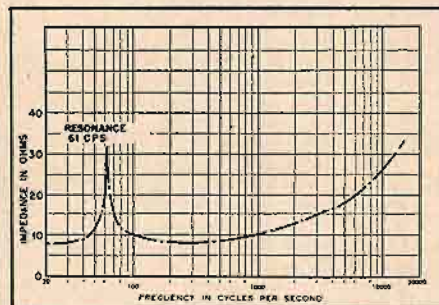

Fig. 5. Impedance curve of speaker of Fig. 4 in enclosed box.

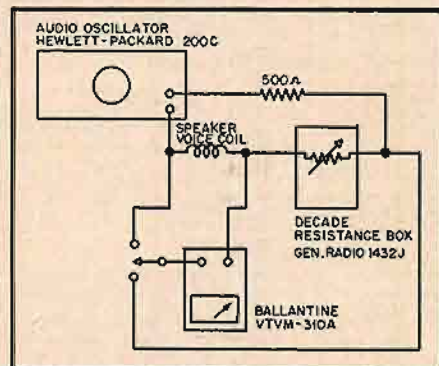

Fig. 7. Circuit used to make impedance measurements.

External appearance of the Gately Super Horn.

pani are easily separated. The smoothness of response and lack of tuning give the bass viol a rich full sound, and rid them of the Johnny-one-note sawing sound associated with some other types of enclosures. The excellent coupling between the horn and the floor gives the reproduction a presence not otherwise obtained.

BIBLIOGRAPHY

Harry F. Olson, *Elements of Acoustical Engineering*, D. Van Nostrand Company, Inc. New York, 1940.

Don't Forget . . .
THE AUDIO FAIR
Oct. 29, 30, 31, and Nov. 1
Hotel New Yorker, N. Y.

TERMINAL
Cordially Invites you
TO SEE AND HEAR
Important New Developments In
HIGH FIDELITY
Home Music Instruments

**NEW PILOT AF 821
AM-FM TUNER**



A high-fidelity receiver with a flat frequency response of 20-20,000 cps, ± 2 db. Has self-contained power supply for use on 117 V, 60 C. 8 tubes plus rectifier. 2-stage amplifier with bass and treble tone control circuits and phono input compensator. Power consumption: 50 W. Size: 14¼W, 7¼H, 8½D.

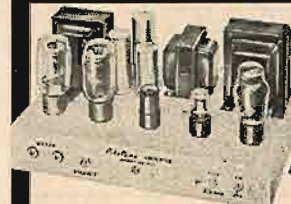

**NEW
PILOT
AA 901
AMPLIFIER**

A high-fidelity amplifier power stage for use with the PA 911 or the AF 821. Frequency response 20-20,000 flat within ± 1 db. Speaker output 8 and 16 ohms. Total harmonic distortion less than .1% at 10 Watts output. Uses KT66 power tubes.

**NEW PILOT PA 911
PREAMPLIFIER**



For use with the AA 901. Has tone correcting volume control. Full bass and treble controls, with flat positions at center setting of control knobs. Separate mike input control to superimpose voice on radio, TV or phono. Circuit specially compensated for records made to American and foreign standards.

See and hear this new equipment in our complete audio studio.

Take advantage of the liberal
TERMINAL TRADE-IN PLAN
on old standard brand equipment

Open Thursday Evenings till 9 P. M.
Ample Free Parking after 6 P. M.

**Terminal
Radio Corp.**

85 CORTLANDT ST., NEW YORK 7, N. Y.
phone: WOrth 4-3311

"WHOLESALE RADIO"
For ALL The BEST In
HI-FI

HI-FI SPEAKERS

For Faithful Concert Hall
Realism in Your Own Home

**ALTEC LANSING
15" DUPLEX PM SPEAKER**



A two way speaker system that properly blends highs with lows. Freq. response: 30 to 16,000 cycles. Power rating: 30 watts. Network imp.: 16 ohms. Speaker di.: 15-3/16". Depth: 1 1/2". Weight with network 40 lbs.

Model 604B **\$140.00**

UNIVERSITY Cobra 12	\$ 27.00
UNIVERSITY 6201 Coaxial 25 W. 12", PM	45.00
UNIVERSITY 6200 Wide Range 30 W. 12", PM	21.00
UNIVERSITY "Diffusione" Ext. range. 30 W. 8 ohm. 12"	27.00
ELECTRO-VOICE Radak Super-12. 25 W.	54.00
JENSEN 6-610 Triaxial. 35 watts	229.50
GENERAL ELECTRIC S1201D 25 watt. 12" PM	20.37

FULL RANGE HI-FI

Portable For Apartment
Small Home or Traveling

REK-O-KUT "Recitalist"



Exceptionally hi-fidelity 3-speed phonograph. Plays records from 6" to 16" broadcast transcriptions. Reproduces the full broad range of any recording at any listening level. Powerful speaker is mounted in detachable cover of carrying case with 14 foot cord. The ideal instrument for the music lover who wants accurate undistorted reproduction . . . and doesn't have space for a console.

RP-43C \$229.95

Enjoy Hi-Fi Recording Pleasure
**Duo-Speed TAPE RECORDER
PENTRON
Model 9T3C**



Complete with crystal mike, 600 ft. reel of plastic tape and empty 5" reel. **\$134.50**

Life-like reproduction. Superlative features and styling. Semi-professional in operation. At the push of a button, provides two full hours recording on a 7" reel (3 3/4" per sec.—50 to 5,000 cycles) on one full hour on a 7" reel (7 1/2" per second—50 to 8,000 cycles). Has fast forward and rewind speed, 20 to 1, or 70 sec. for 1200 ft. Five watts audio in 6" Alnico V speaker. Additional features include editing key; magic eye recording indicator; crystal mike; mike and radio input jacks; separate record and erase heads. 110 v. AC. Wt. 27 lbs. A really great portable tape recorder unmatched at this price.

GARRARD 3 speed record changer RC-80	\$ 42.30
RADIO CRAFTSMEN TUNER RC-10	131.50
RADIO CRAFTSMEN AMPLIFIER Ultra Hi-Fi. C-500	99.50

WEATHERS Pick-Up Cartridge

One gram capacitance pickup. Will replace and greatly improve any modern phono pickup. Response: 20 to 20,000 cps. Records last thousands of plays. One sapphire plays thousands of records. Universal sapphire stylus for all records—LP 33-1 1/2—45—78 rpm. Complete with ultra flexible cable, oscillator unit tube, installation hardware and instructions.

\$37.50

For Audio Values Write For Free F.Y.I. Bulletin. Address Orders to Dept. AE-10

**WHOLESALE
RADIO PARTS CO., Inc.**
311 W. Baltimore St.
BALTIMORE 1, MD.



Miscellaneous Radio, TV and Electronic Parts

CREST TRANSFORMER CORP.—Added 4 power transformers for capacitor-input filter circuits . . . 2 power transformers for reactor-input filter circuits . . . 4 filament transformers . . . 4 filter reactors . . . 2 universal audio output transformers . . . 2 heavy-duty audio output transformers.

DUMONT LABORATORIES—Withdrew series of 5, Y2 deflection yokes.

ERIE RESISTOR CORP.—Added additional disc ceramic capacitance values . . . also series of 1500, 3000, and 6000 volt high-voltage ceramics . . . series of standard printed circuits.

FEDERAL TELEPHONE & RADIO CORP.—Reduced prices on RG series of coaxial lead-in cables.

INDUSTRIAL CONDENSER CORP.—Added new series of 49 Stabelex capacitors.

KEITH RADIO—Introduced 6 new IF transformers.

MORROW RADIO MFG. CO.—Added 3 generator filter chokes, GC-6, GC-10, and GC-20 at \$3.75 net each.

SOLA ELECTRIC CO.—Decreased prices on 6 constant-voltage transformers with harmonic filter, and on 5 constant-voltage transformers.

THORARSON-MEISSNER—Added audio interstage transformer T-20A19 at \$2.46 net.

UTAH RADIO PRODUCTS CO.—Added 4 filter choke, 4 vertical output, 2 vertical blocking oscillator, 4 power, 9 audio output, and 2 line transformers.

Recording Equipment, Speakers, Amplifiers, Needles, Tape, etc . . .

ARGOS PRODUCTS CO.—Added model PC-1A, record changer carrying case, and 8- and 12-in. corner bass-reflex baffles models CB-8 and CB-12. Also the table model TV cabinets are now priced to include excise tax.

BELL SOUND SYSTEMS, INC.—Withdrew amplifiers 3715A, 3725A, 3750A, 3750A-R; mobile amplifier 3723M; PA systems PA-3715A, PA-3725A, PA-3750A; phono PA system 2078; record player 2075; microphone DY-11; and RC-47 recorder.

CRESTWOOD RECORDER CORP.—Added 3 models of "Magictape" recorders.

DECIMETER, INC.—Withdrew "professional" TV pre-amplifier models 300 and 400.

ELECTROVOX—Added model W-52TPS, Magnavox replacement needle; reduced price of 6-oz. Aerosol can of Stat-Clean to \$1.50 list.

GOLDRING GRAMAPHONE, INC.—Stylus models 260 and 270 reduced to \$1.50 net each.

JENSEN MFG. CO.—Increased price of Model PS-Q, 8-in. Alnico 5 PM concert speaker to \$17.67 net. Added "Viking" loudspeaker Model 69J10 at \$4.28 net, for automotive replacements.

MILLER MFG. CO.—Diamond styl added for Astatic cartridges (7), for Electro-Voice (1), for Philco (4), and for Webster-Electric cartridges (3).

OXFORD ELECTRIC CORP.—Added 5PAMS, 5PMS, 5PCMS, 5-in. pin-cushion type magnet replacement speakers. Also drive-in theatre speaker 5CM-51 and 4CM-13 employing a 1.47 oz. Alnico V magnet and 5BA-3 and 4AM-65 employing a 0.68 oz. Alnico V magnet.

QUAM-NICHOLS—Added tweeters: 3A15T at \$3.45 net, and 8A15T at \$3.90 net.

SIMPSON MFG. CO.—Added Wirelesstone at \$57.00 net and single stations at \$28.50 net to line of intercom equipment.

Test Equipment

ELECTRONIC INSTRUMENT CO.—Added CRA, TV picture tube test adapter for models 625 (tube tester) and 625K (tube tester kit) at \$4.50 net.

HICKOK ELECTRICAL INSTR. CO.—Decreased price of model 380, CR oscilloscope to \$215.00 net.

RADIO CITY PRODUCTS—Reduced price of deluxe multimeter No. 488A to \$61.50 net.

SHURITE METERS—a.c. ammeter, a.c. milliammeter, a.c. voltmeter series models 550, 650, and 950 increased \$.05 each. D.C. milliammeters models 550-5332, 650-5332 and 950-5332 increased \$.05 each.

SIMPSON ELECTRIC CO.—Withdrew model 380, wave-meter modulation indicator.

Tubes—Receiving, Television, Special Purpose, etc . . .

G. E.—Decreased prices on receiving tube types 6CD6G to \$4.80 list and 6I8 to \$2.90 list. Added 27EP4, a magnetic-focus and magnetic-deflection, direct-view all-glass picture tube at \$97.50 net.

RAYTHEON—Added tube types 1AX2, a 9-pin miniature diode designed for pulse rectifier service in television at \$2.65 list . . . also 6AH4GT, a high permeance triode designed to be used as a vertical deflection amplifier in TV receivers at \$2.20 list . . . also added TV picture tube 17LP4, a rectangular-face picture tube with magnetic deflection and electrostatic focus at \$25.50 net.

CLASSIFIED

Rates: 10¢ per word per insertion for noncommercial advertisements; 25¢ per word for commercial advertisements. Rates are net, and no discounts will be allowed. Copy must be accompanied by remittance in full, and must reach the New York office by the first of the month preceding the date of issue.

THE AUDIO EXCHANGE, INC. buys and sells quality high-fidelity sound systems and components. Guaranteed used and new equipment. Catalogue, Dept. AE, 159-19 Hillside Ave., Jamaica 32, N. Y. Telephone OL 8-0445.

FOR SALE: Jim Lansing 15-in. woofer, \$39; UTC LS-58 transformer, primary 1500 and 2500 ohms, multiple secondary, \$15; Presto 9C turntable, two Livingston arms, \$49; 42-in. black crackle steel cabinet, \$20. David Hancock, 70 W. 95th St., New York 25, N. Y. RIVERSIDE 9-5816.

USED SURPLUS audio and recording equipment. Some good buys. Write for list. M. E. Boyd, 903 Salmon Drive, Dallas, Texas.

30% DISCOUNT ON ALL LP RECORDS! Best mail order service in the country. All records brand new and guaranteed. Specializing in HI-FI records. Send for free catalog and literature. Southwest Record Sales, Dept. AE-1, 4710 Caroline, Houston 4, Texas.

W.E. 755A SPEAKER in R-J 8-in. enclosure, practically new, \$39. Stromberg-Carlson AR-37 phono amplifier, with bass, treble, loudness, gain, low-pass controls, \$28. Alexander Shaw, 32-25 163rd St., Flushing, N. Y.

CUSTOM 30-WATT Williamson Amplifiers—Dual Chassis, Peerless S-205-Q and R-560-A transformers, all oil-filled coupling and filter capacitors; extra power takeoff. Wt. 50 lbs., \$89.50. Dr. Nicely, Kenton, Ohio.

PROFESSIONAL RECORDISTS also require a central agency for selling, buying, and exchanging recording equipment. We are now preparing to fill this need. Write for catalog PRO-1 which gives detailed information on professional recording equipment only, or offer equipment for sale to

THE AUDIO EXCHANGE, INC.
159-19 Hillside Ave., Jamaica 32, N. Y.
OL 8-0445

FOR SALE: Tuners—Craftsmen C10, excellent condition, \$105; Browning RJ-20, good condition, \$80. Amplifier—Masco MA-10HF, good condition, \$35. Only certified check or money order accepted. Ralph Ashworth, Charlton City, Mass.

ANNOUNCING A NEW SERVICE—Highest quality discs cut from your tapes. All speeds—all sizes. Fairchild equipment, hot styl. Also monitoring off the air and special recording services. Reasonable rates. Write for prices. The Dubbling Co., 41-10 45th St., Long Island City 4, N. Y.

TAPE RECORDING WANTED, Jack Owens Show, CBS, 4:30 p.m. Tuesday, August 26th. Fred E. Miller, 3122 SE 73 Ave., Portland 6, Ore.

AS YOU KNOW, the Williamson Circuit is hard to beat. Here's an amplifier built precisely to that circuit with Linear Standard power components and an Altec output transformer. All connections on Cannon plugs. I just don't have room for the Linears. Call MU 9-4456 or write 143 E. 35th St., New York 16, N. Y. Mr. Brandwein.

PRESTO 6N with accessories, LP. Top condition. Best offer over \$425. Box CP-1, AUDIO ENGINEERING.

HARVEY WILLIAMSON KIT, fully wired, 58S1 output, CFB Partridge output transformer, two months old, guaranteed perfect condition, \$100. Model 108 Stephens driver, brand-new, \$45. Money orders only. F.O.B., N. Y. Arthur A. Priest, 34-35 76th St., Jackson Heights, N. Y.

FOR SALE: Meissner 9-1093 AM-FM receiver, Modified for GE preamp. Guaranteed in perfect condition, \$115. Gordon Cain, 30 Waverley Terrace, Belmont, Mass.

FOR SALE: Altec 604B speaker, N1000B network, excellent condition, \$110.00. Apt. 3M, 34-35 76th St., Jackson Heights, New York. Illinois 7-8649 after 6:00 p.m.

FOR SALE

All or any parts of the following equipment:

- 8—Custom made program amplifiers less VU meters
- 4—Custom made line amplifiers
- 6—Custom made pre-amplifiers
- 5—Custom made announcer studio consoles
- 1—Custom made private line telephone switchboard
- 6—Meter consoles with fader strips, monitor and switching panels, including bridge-type faders
- 1—Electronic chime
- 1—Complete McElroy Code School equipment comprising tape pullers, oscillator, and tape maker
- 1—RCA 55A amplifier
- 15—Type 33B jack strips
- 22—Type 33A jack strips

All above equipment now being used. Inspection invited. Write or wire:

L. E. Littlejohn

Radio Station WFIL, Philadelphia 7, Pa.

STOP LOOK LISTEN

Stop at the Hotel New Yorker October 29, 30, 31, November 1.

Look at the greatest collection of Audio Equipment ever assembled.

Listen to the newest developments in everything from pickups to speakers.

THE AUDIO FAIR

You're Invited Admission Free

PROFESSIONAL DIRECTORY

Custom-Built Equipment

U. S. Recording Co.

1121 Vermont Ave., Washington 5, D. C.
Lincoln 3-2705

Tape duplicating

Prices per 7" reel, any quantity,
\$1.00 if we use your tape, or \$3.50
if we supply new plastic base
Audiotape.

EMPIRE RECORDING CO.
3221 S. Acoma St., Denver, Colorado

In Southern California it's HOLLYWOOD ELECTRONICS

(in The Audio Mile)

Distributors of Hi Fidelity
Components Exclusively
Webster 3-8208

7460 Melrose Ave. Hollywood 46, Calif.

Industry People...

David O. S. Ruark is new ad manager of Audio & Video Products Corp., New York, succeeding **Leon Wortman**, resigned to enter recording business with **Robert Fine**. . . **Gil Demsky**, sound department salesman with Harvey Radio Company, New York, basking in the glory of having handsome cabinet in the new River Edge Industries line named in his honor—**Walter Godfrey**, River Edge president, plans similar distinction for other sound department representatives.

Leonard Gardner, president, British Industries Corp., New York, virtually commuting to Europe these days—he's there now accompanied by ad agent **Arthur Gasman**—expects to be gone several weeks during which time B.I.C. sales activity will be in able hands of **Mort Lee**, **Frank Hoffman**, etc. . . **E. B. Harrison** has been appointed general sales manager of Peerless Electric Products Division of Altec Lansing Corporation—other Peerless assignments include **A. A. Emley** as plant manager, **E. E. Goldsmith** as assistant plant manager, and **V. W. Staads** as supervisor of production planning. **H. S. Morris** continues as Eastern sales manager for Peerless products.

Dr. Sidney J. Stein has been promoted to director of research by International Resistance Company. . . **Gordon Robert** is director of new Concord, Mass., branch office of Henry J. Geist & Associates, Inc., New York sales reps. . . **Larry LeKashman**, vice-president, Electro-Voice, Inc., announces appointment of **Harold G. Guliksen**, industrial designer, to company's ad staff—another recent E-V appointment is **Dr. Carl F. Moen** who joins research team as senior engineer; announcement made by **A. M. Wiggins**, vice-president in charge of engineering.

Irving Greene, former sound department director, Sun Radio & Electronics Corp., New York, will be back on the audio scene soon with one of the country's more lavish sound demonstration establishments. . .

V. J. Liebler, despite gruelling recording schedule with Columbia Records, still finds time to be first to show up at monthly meetings of AES Board of Governors. . .

Joseph W. Harrison has been named technical staff assistant of Arma Corporation. . . **J. A. Renhard** has been named by broadcast equipment section of RCA as sales rep. in new Northwest sales territory. . . **C. P. Boggs** is new vice-president in charge of manufacturing of Brush Development Company.

George F. Hawley has been named manager of Sound Systems, Inc., exclusive distributor-contractors for Stromberg-Carlson in New York City area. . . **Roy Stevens**, formerly with General Electric, is new component sales manager of Lenkurt Electric Sales Company, San Carlos, Calif. . .

Lauritz Jessen has been appointed supervisor of maintenance by Precision Film Laboratories, Inc., New York.

Peter Mole, president, SMPTE, discloses that **David Sarnoff** Gold Medal Award this year will be presented to **A. G. Jensen**, director of Bell Telephone Laboratories television research. . . **Paul V. Galvin**, president, Motorola, Inc., announces appointment of **Dr. Robert E. Samuelson** as chief engineer of Motorola research lab at Phoenix, Ariz. . .

Philip E. Volz, section engineer for Westinghouse Tube Division, named winner in continuous contest for best patent disclosure out of each 50 submitted by the Division's engineers.

Hoffman Radio Corp., Los Angeles, expands sales and allied departments, with no change in personnel except for additions to staff. **M. D. Schuster** is director of sales; **Walter Stickel**, national sales manager; **E. A. Tischler**, publicity director; and **Don E. Larson**, advertising director. . .

Thomas A. Patterson, Jr., formerly in geophysics and oil well survey work, joins **Ketchum, MacLeod & Grove, Inc.**, Pittsburgh ad agency, as writer in Technical Literature department. . . **Eugene Cohn**, v-p of Secon Metals Corporation, announces acquisition of additional building at 5-7 Intervale St., White Plains, N. Y., for expanded research and manufacturing operations.

F. Sumner Hall, AES vice-president and chairman of technical papers committee, already receiving congratulations on magnificent job of assembling papers to be presented at AES convention. . . **Emory Cook**, president, Cook Laboratories, working like a beaver to complete program material for binaural demonstration of disc recording at The Audio Fair. . . Speaking of The Audio Fair, that's where we'll be seein' ya.

Presenting

GARRARD
World's Finest
Record Changer
WHARFEDALE
Loudspeakers

LEAK
Amplifiers

in the
luxurious setting
of
ARROW
ELECTRONICS'

AudioCenter

designed to
COMPLETELY
demonstrate
SOUND
in its natural
setting

Presenting

THORENS

THE RECORD CHANGER

SWISS HIGH PRECISION
WORKMANSHIP

in the
luxurious setting
of
ARROW
ELECTRONICS'

AudioCenter

designed to
COMPLETELY
demonstrate
SOUND
in its natural
setting



ALL SET FAIR

Once again you will be able to make direct contact with Hartley audio at the Audio Fair. In room 533 H. A. Hartley and some of his dealer agents will be waiting to show you that new concept of music in the home, which, depending entirely on customer-to-prospect recommendation, has steadily made its way throughout the length and breadth of the land.

Our progress since last year's Fair has been phenomenal, yet here in London we have done nothing but write a few advertisements, make good loudspeakers and amplifiers—and think! Your orders have reached us simply because we send you what we said we would—audio equipment which, in spite of ridiculously low prices, provides you with a quality of reproduction which can only be described as "the real thing."

Additionally, those who subscribe to our data service have been given an interesting story which shows that our ideas do not stop at mere technicalities. Our products are really the symbol of something more—an earnest desire to work out a way of working and living which may ultimately lead to a new and better method of making industry and science serve "economic man."

Enough of our customers have decided the time has come to put these ideas into effect, so before very long the first stage of a new and comprehensive programme will be worked out—by manufacturing Hartley Audio in the United States. In this way you will get better commodity and personal service, quicker delivery, wide-spread demonstration facilities, and a complete range of equipment and accessories, all at such reasonable prices that you will find it the simplest thing in the world to have that long-planned listening room of yours completely equipped.

Speakers, speaker housings, amplifiers, pickups, motors, record-changers, and all kinds of cabinet components, of a quality beyond criticism, will be available to please and permanently satisfy every man who is beginning to think that the quest for realism in reproduction is a will-o-the-wisp forever leading him into extravagances of price and bulk.

Call and see us at The Fair, but if you can't, see that your name gets on to our mailing list by sending for our present interim catalogue. A new and comprehensive one is being planned to describe our new activities.

H. A. HARTLEY CO. LTD.

132, Hammersmith Road
London W.6, England

ADVERTISING INDEX

Acro Products Co.	83
Air Tone Sound & Recording Co.	91
Allied Radio Corp.	74
Altec Lansing Corp.	69, 80
Amperite Co., Inc.	87
Ampex Electric Corp.	41
Amplifier Corp. of America	72
Arnold Engineering Co.	3
Arrow Electronics, Inc.	65
Audak Co.	47
Audio Devices, Inc.	Cover 2
Audio Fair	57
Audio Instrument Co., Inc.	14
Audio & Video Products, Corp.	10, 54, 72, 75, 78, 85, 86, 88
Beam Instruments Corp.	54
Bell Sound Systems, Inc.	76, 90
Bell Telephone Laboratories	20
Berlant Associates	91
British Industries, Corp.	95
British Radio Electronics, Ltd.	85
Brush Development Co.	84
Cannon Electric	6
Carter Motor Co.	79
Chicago Transformer Co.	71
Cinema Engineering Co.	55
Classified	94
Daven Co.	Cover 3
Ectro, Inc.	16
Electronic Center, Inc.	89
Electro-Voice	92
Empire Recording Co.	95
Fisher Radio Corp.	67
Gates Radio Co.	5
Gately Development Laboratory	64
General Electric Co.	53
General Radio Co.	7
H. A. Hartley Co., Ltd.	96
Harvey Radio Co., Inc.	49, 50, 51
Heath Co.	81
High-Fidelity Magazine	59
Hollywood Electric Co.	70, 93, 95
House & Garden	1
Hughes Research & Development Laboratories	15
Hudson Radio & Television Corp.	86
Hycor Co.	78
Jensen Mfg. Co.	83
Karlson Associates	93
Kellogg Switchboard & Supply Co.	77
Langevin Mfg. Corp.	43
Lansing, James B. Sound Inc.	91
Leonard Radio, Inc.	63
Lowell Mfg. Co.	79
Magnecord, Inc.	56
Magnetic Recorders Co.	92
Miller, J. W. Co.	96
Minnesota Mining & Mfg. Co.	11
National Hollywood Co.	80
Newcomb Audio Products Co.	10, 80
Ozark Wood Products Co.	77
Pacific Transducer Corp.	91
Partridge Transformers, Ltd.	96
Pentron Corp.	82, 88
Permoflux Corp.	87
Pfanstiehl Chemical Co.	83, 87
Pickering & Co. Inc.	19
Pilot Radio Corp.	44, 45
Precision Film Laboratories, Inc.	17
Professional Directory	95
Racon Electric Co., Inc.	89
Radio Electric Service Co. of Penna. Inc.	89
Radio's Master	73
Rek-O-Kut Co.	2
Reeves Soundcraft Corp.	9
River Edge Industries	82
Rockbar Corp.	61
Shallcross Mfg. Co.	48
Standard Transformer Corp.	66
tapeMaster, Inc.	68
Tech-Master Products Co.	87
Telex Electro-Acoustic Division	83
Terminal Radio Corp.	93
Thorens Co.	95
Triad Transformer Mfg. Co.	12
Tung-sol Electric, Inc.	8
Turner Co.	4
University Loudspeakers, Inc.	76
United Transformer Co.	Cover 4
U. S. Recording Co.	90
V. M. Corp.	84
Waveforms, Inc.	88
Weathers Industries	81
Webster Chicago	13
Westrex Corp.	75
WFIL	95
Wholesale Radio Parts Co., Inc.	94

PARTRIDGE WILLIAMSON OUTPUT TRANSFORMER

Built to the original specification

De-luxe model now available from stock from all important Radio Stores throughout the U.S.A. (Price \$26.00 duty paid)

This transformer is now accepted as the most efficient in the world. According to "Audio Engineering" (Nov. 1949), there is no U.S. equivalent. Thousands already sold in the U.S.A.

Partridge P.1292 16 watt Output Transformer now available is intended for use in equipment reproducing the full audio frequency range with the lowest possible distortion.

Series leakage inductance .10 mh.

(Price \$21.00 duty paid.)

The Following Stores are among those now Stocking Partridge Transformers.

Harvey Radio Co. Inc.	Electronic Wholesalers
103 West 43rd Street,	Inc.
New York 18,	2345 Sherman Ave.,
Sun Radio Corp.,	Washington, D. C.
938 F Street, N.W.,	Gates Radio Company,
Washington, D. C.	2700 Polk Avenue,
Gates Radio Company,	Houston, Texas.
Quincy, Illinois.	Wholesale Radio Parts
Terminal Radio Corp.,	Co. Inc.
85 Cortlandt Street,	311 W. Baltimore St.,
New York 7.	Baltimore 1, Maryland.

Sole Agents in Canada: Atlas Radio Corporation, 560 King Street West, Toronto 2-B.

If you are unable to purchase Partridge transformers in your city, write to us and mention the name of your dealer.

Fullest data, including square-wave tests, distortion curves, etc., together with list of U. S. stockists rushed Air Mail to you.

PARTRIDGE TRANSFORMERS LTD.
TOLWORTH, SURREY, ENGLAND



THE SENSATIONAL NEW MILLER BAND-PASS TRF TUNER USING A GERMANIUM DIODE DETECTOR



HIGH FIDELITY

- NO TUBES!
- NO POWER SUPPLY! • NO HUM!

A SIMPLE 2 TUNED CIRCUIT NEGATIVE MUTUAL COUPLED BAND PASS TUNER

- EASY TO ASSEMBLE & WIRE!

In spite of its simplicity, low cost, #585 kit is not a toy — it is a carefully designed High Fidelity Broadcast band tuner. Use it with your amplifier and speaker system for truly high quality reception.

The audio output of the tuner is proportional to the input signal and will vary from .05V to .5V for stations within a 20-25 mile radius when used with a good antenna of from 75 to 100 feet in length. A good antenna is absolutely essential to the proper operation of the #585 tuner.

The net price of the Miller #585 TRF tuner kit, including chassis, dial, and tuning condenser, is only \$11.40. The additional parts required make it possible to build the complete tuner at a net cost of less than \$15.00.

Order yours now — ask for the new MILLER — Cat. No. 585 Crystal Detector Tuner — Net \$11.40

SEE YOUR LOCAL RADIO PARTS SUPPLIER FOR THE MILLER #585 KIT AND OTHER MILLER PRODUCTS

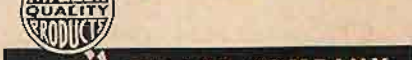

J. W. MILLER COMPANY
5917 S. MAIN ST. LOS ANGELES, CALIF.

AUDIO ENGINEERING • OCTOBER, 1952

THESE ARE THE

REASONS

WHY **DAVEN** IS THE
LEADER IN THE
AUDIO ATTENUATOR
FIELD

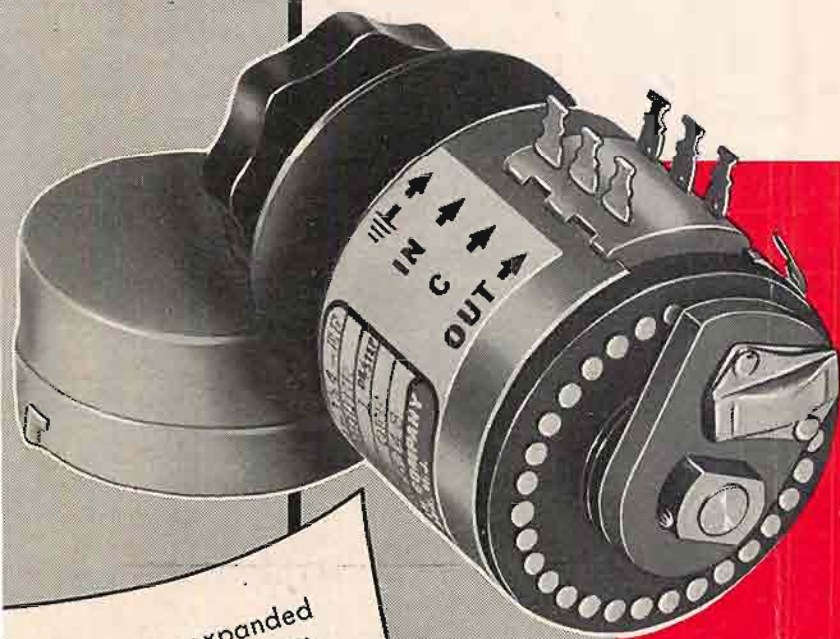

LA-130 Series,
Ladder Network
30 Steps, 1 3/4" Diameter

Greatly expanded production facilities enable Daven to make delivery from stock on a large number of standard attenuator types.



- 1 "KNEE-ACTION" ROTOR . . . gives positive contact and low contact resistance under all conditions.
- 2 BRASS CASE OF 2-PIECE CONSTRUCTION . . . gives excellent shielding and allows more compact equipment design.
- 3 "LOCK-TITE" DUST COVER . . . designed to withstand severe vibration and at the same time allow easy accessibility.
- 4 ENCLOSED ROLLER-TYPE DETENT MECHANISM . . . gives positive indexing, but does not increase depth of unit.
- 5 LOW-LOSS MOLDED TERMINAL BOARD . . . has high resistance to leakage.

Write for complete catalog data.

THE **DAVEN** CO.

WORLD'S LARGEST MANUFACTURER OF ATTENUATORS

185 Central Ave., Newark 4, N. J.



MINIATURE COMPONENTS FROM STOCK...

SUBOUNCER UNITS

FOR HEARING AIDS...VEST POCKET RADIOS...MIDGET DEVICES

UTC Sub-Ouncer units fulfill an essential requirement for miniaturized components having relatively high efficiency and wide frequency response. Through the use of special nickel iron core materials and winding methods, these miniature units have performance and dependability characteristics far superior to any other comparable items. They are ideal for hearing aids, miniature radios, and other types of miniature electronic equipment. The coils employ automatic layer windings of double Formex wire...in a molded Nylon bobbin. All insulation is of cellulose acetate. Four inch color coded flexible leads are employed, securely anchored mechanically. No mounting facilities are provided, since this would preclude maximum flexibility in location. Units are vacuum impregnated and double (water proof) sealed. The curves below indicate the excellent frequency response available. Alternate curves are shown to indicate operating characteristics in various typical applications.

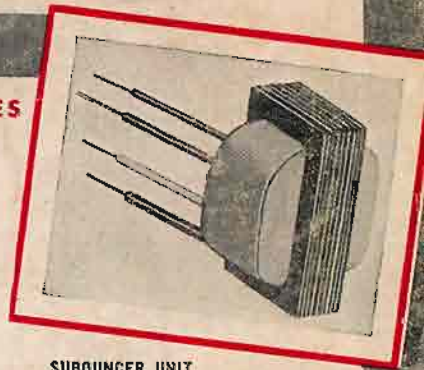

SUBOUNCER UNIT
Dimensions...9/16" x 5/8" x 7/8"
Weight03 lb.

Type	Application	Level	Pri. Imp.	D.C. in Pri.	Sec. Imp.	Pri. Res.	Sec. Res.	List Price
*SO-1	Input	+ 4 V.U.	200 50	0	250,000 62,500	16	2650	\$ 6.50
SO-2	Interstage/3:1	+ 4 V.U.	10,000	0	90,000	225	1850	6.50
*SO-3	Plate to Line	+ 20 V.U.	10,000 25,000	3 mil. 1.5 mil.	200 500	1300	30	6.50
SO-4	Output	+ 20 V.U.	30,000	1.0 mil.	50	1800	4.3	6.50
SO-5	Reactor 50 HY at 1 mil. D.C. 3000 ohms D.C. Res.							5.50
SO-6	Output	+ 20 V.U.	100,000	.5 mil.	60	3250	3.8	6.50

*Impedance ratio is fixed, 1250:1 for SO-1, 1:50 for SO-3. Any impedance between the values shown may be employed.

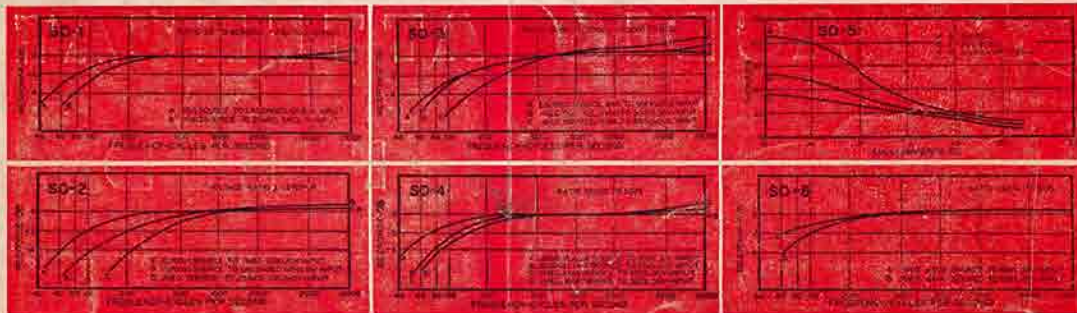

SUB-SUBOUNCER UNITS

FOR HEARING AIDS AND ULTRA-MINIATURE EQUIPMENT

UTC Sub-SubOuncer units have exceptionally high efficiency and frequency range in their ultra-miniature size. This has been effected through the use of specially selected Hiperm-Alloy core material and special winding methods. The constructional details are identical to those of the Sub-Ouncer units described above. The curves below show actual characteristics under typical conditions of application.

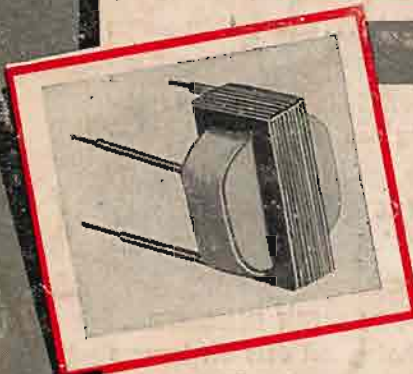

SUB-SUBOUNCER UNIT
Dimensions...7/16" x 3/4" x 5/8"
Weight02 lb.

Type	Application	Level	Pri. Imp.	D.C. in Pri.	Sec. Imp.	Pri. Res.	Sec. Res.	List Price
*SSO-1	Input	+ 4 V.U.	200 50	0	250,000 62,500	13.5	3700	\$6.50
SSO-2	Interstage/3:1	+ 4 V.U.	10,000	0	90,000	750	3250	6.50
*SSO-3	Plate to Line	+ 20 V.U.	10,000 25,000	3 mil. 1.5 mil.	200 500	2600	35	6.50
SSO-4	Output	+ 20 V.U.	30,000	1.0 mil.	50	2975	4.6	6.50
SSO-5	Reactor 50 HY at 1 mil. D.C. 4400 ohms D.C. Res.							5.50
SSO-6	Output	+ 20 V.U.	100,000	.5 mil.	60	4700	3.3	6.50

*Impedance ratio is fixed, 1250:1 for SSO-1, 1:50 for SSO-3. Any impedance between the values shown may be employed.

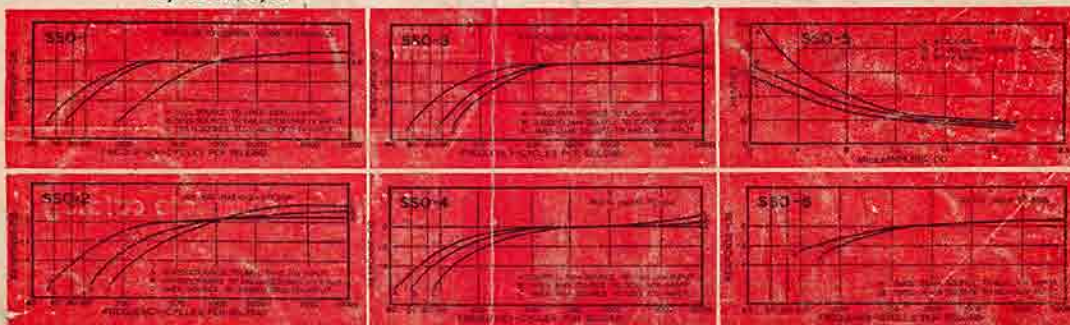

United Transformer Co.

150 VARICK STREET NEW YORK 13, N. Y.
EXPORT DIVISION: 13 EAST 40th STREET, NEW YORK 16, N. Y. CABLES: "ARLAB"