

dB

THE SOUND ENGINEERING MAGAZINE

MAY 1968 75¢

Architectural Acoustics—Sound Systems
Why Do We Hear What We Hear—Discussion
The NAB Convention—A Picture Gallery



ALBERT B. GRUNDY JR.
INTERNATIONAL ELECT. INC.
233 6TH AVE.
NEW YORK, N.Y. 10014

Don't drop this amplifier into your coffee.

It may look like a sugar cube, but it tastes like an amplifier.

An operational amplifier to be specific. One of the many at Harvey's. And despite its tiny size, it's a no-compromise piece of equipment with low noise and low distortion.

The audio field, in general, will probably be seeing a lot of these sugar cube amplifiers in months and years to come. But Harvey's customers have had a taste of them for some time already.

The product specialists at Harvey's have been recommending and using these operational amplifiers as a matter of course lately.

And Harvey's has been making available and recommending a lot of other fantastic products of miniaturization too.

The new FET limiters, for example. In addition to being ultra-compact, they're also ultra-fast with ultra-low distortion. And although they're not exactly ultra-cheap, we bet they cost a lot less money than you're probably afraid you'd have to spend.

And we've got the new FET condenser microphones. And all the new tape recording equipment you've been reading about.

(Harvey's is prepared to supply you with complete 24-track tape set-ups, high-speed duplicators, and packaging equipment for cassettes and cartridges faster than you can decide where you're going to put them.)

Call Harvey's often. And if you're not already on our mailing list, get on it.

Harvey's can keep you in touch with products so new, you may find some of them a bit hard to swallow.

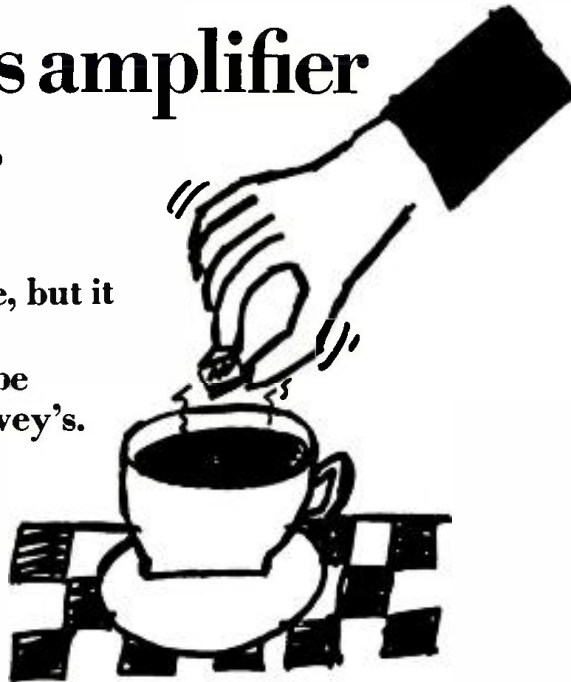

Harvey Radio Co., Inc.

Professional A/V Division, 2 West 45th St., New York, N.Y. 10036 (212) JU 2-1500

Circle 10 on Reader Service Card

Coming Next Month

● June will feature a big picture-and-text story on the AES Convention.

A number of articles are currently in preparation, among them one on the development and applications of a new ribbon microphone; a report on a small, portable console; round-table discussions of broadcast automation and of studio console design; an authoritative article on the problems of stereo (compatible) records at broadcast stations; the story of a new compact 50-watt monitor amplifier; and a study of field-recording problems. Look for some of these in June, along with our regular columnists, George Alexandrovich, John A. McCulloch, Norman H. Crowhurst, and Martin Dickstein.

Next month in *db*, the *Sound Engineering Magazine*.

About the Cover

● What's new in consoles from RCA, Collins, Ward Electronics, McCurdy Radio, Gates, Visual Electronics, Altec Lansing, Sparta, and Norelco . . . as displayed at the NAB convention. See picture story on page . . . 22

db

THE SOUND ENGINEERING MAGAZINE

May 1968 • Volume 2, Number 5

Table of Contents

FEATURE ARTICLES

- Architectural Acoustics — Sound System Design
David L. Klepper 13
- Why Do We Hear What We Hear? 18
- The NAB Convention — A Picture Gallery 22

MONTHLY DEPARTMENTS

- Letters 2
- The Feedback Loop
John A. McCulloch 4
- Theory and Practice
Norman H. Crowhurst 6
- The Audio Engineer's Handbook
George Alexandrovich 10
- Editorial 12
- Sound With Images
Martin Dickstein 26
- New Products and Services 28
- Classified 31
- People, Places, Happenings 31

EDITORIAL BOARD OF REVIEW

George Alexandrovich
Sherman Fairchild
Norman Anderson
Prof. Latif Jiji
Daniel R. von Recklinghausen
William L. Robinson
Paul Weathers

db, the Sound Engineering Magazine is published monthly by Sagamore Publishing Co., Inc. Entire contents copyright © 1968 by Sagamore Publishing Co., Inc., 980 Old Country Road, Plainview, L. I., N.Y. 11803. Telephone: (516) 433-6530. Subscriptions are issued to qualified individuals and firms in professional audio. Application must be made on an official subscription form or on a company letterhead. Interested readers may subscribe at \$6.00 per year (\$7.00 per year outside U.S. Possessions, Canada, and Mexico). Single copies are 75¢ each. Controlled circulation rates paid at N. Abington, Mass. 02351. Printed in U.S.A. at North Abington, Mass. Editorial, Publishing, and Sales Offices: 980 Old Country Road, Plainview, New York 11803. Postmaster: Form 3579 should be sent to above address.



THE
NEW
SONY
C-22 FET
CONDENSER
MICROPHONE

Capture the Strength and Delicacy of Every Sound For Only \$99.50!

Now at last! You can have the professional sound of your favorite recording artists, that only a condenser microphone can deliver . . . for under \$100!

Until now, you had to pay over \$300 for a Sony condenser microphone! Sony, who makes the world's finest condenser microphones, has changed all that with an important design breakthrough . . . the New Sony C-22 FET Condenser Microphone, that costs only \$99.50!

The C-22 FET has the exceptional uni-directional cardioid pattern with a high front-to-back rejection ratio, and flat frequency response (from 40 Hz to 20,000 Hz), free of peaks and dips, that professional recording artists rely upon for the unsurpassed tonal quality that their performance deserves.

Solid-state design, incorporating a revolutionary Field Effect Transistor (FET), eliminates external power supply to give you power cable-free flexibility. A replaceable 9-volt battery powers the C-22 FET for 300 hours of continuous operation, and you have the flexibility of three switch-selected impedances.

From its slim-tapered miniaturized design, which ideally suits it for every purpose from solo performer to small groups, choral groups and full orchestra, to its unheard of low price, the New Sony C-22 FET Condenser Microphone is everything you want for professional results. Go professional for only \$99.50, with the Sony C-22 FET Condenser Microphone!

© SUPERSCOPE INC 1968



8150 VINELAND AVENUE • SUN VALLEY, CALIF. • 91352

Circle 17 on Reader Service Card

Letters

The Editor:

I received the January issue of *db* and found it loaded with information. Two associates and I have been producing musical radio jingles and I have been responsible for any engineering involved. We have recently begun construction of a new recording studio, the total cost of which will be in the neighborhood of \$20,000. I expect the problems to be quite staggering to my limited intellectual resources. I would like very much to continue receiving your magazine; its assistance has already been invaluable.

Stan Bumgarner
Algen Productions
Hickory, N.C.

The Editor:

Let me say that your magazine has been arriving and is very much appreciated. I try to read everything in each issue.

The round table on Audio Facilities with Burden, Joel, Krochmal, Giovanelli, and Kobrin was really good — it put a lot of information in a tight format.

James M. Orre
Technical Supervisor
WATS
Sayre, Pennsylvania

The Editor:

I read with particular interest the letter to the editor by Mr. David Hubert in the February issue. I echoed a loud *amen* regarding the quality of t.v. audio. With the capability of the television station for excellent audio response it is almost criminal what is foisted on the audience in the way of sound. Having worked for some 27 years in both television and radio stations, I believe I can safely say that in many cases, the aural facilities of a t.v. operation are treated as the unwanted stepchild. If we, who are in radio only, treated our microphone-to-transmitter facilities in this fashion, we'd soon be out of listeners and out of business.

John E. Hall
Chief Engineer
WONE
Dayton, Ohio

What Mr. Hall says is tragic but true. But where lies the fault? Is it really, as the t.v. people say, that the public is satisfied with the audio it gets; or can part of the blame be placed on the engineers themselves who have allowed this degradation of quality to continue? Surely, television does not suffer any greater lack of skilled audio men than other media. Why then is the product so poor? And, more to the point by far — what can be done about it.

Let's hear from those of you in t.v. audio. Ed.

Are you taking advantage of *db's* Classified Advertising?

It's the low cost way to reach prospective buyers or sellers of equipment, potential employees or employers. And if you do not wish to be contacted directly, you can use a box number at no extra charge. Get results with a classified ad in *db*.

Moving?

Have you sent us a change-of-address notice? It takes time for us to change your plate so let us know well in advance of your move. Be sure to send us the complete new address *as well as your old address*. Include both zip numbers. Keep *db* coming without interruption!

Robert Bach
PUBLISHER

Larry Zide
EDITOR

Bob Laurie
ART DIRECTOR

Marilyn Gold
COPY EDITOR

Charles N. Wilson
ASSISTANT EDITOR

Richard L. Lerner
ASSISTANT EDITOR

A. F. Gordon
CIRCULATION MANAGER

David Pollens
ASST. CIRCULATION MGR.

SALES OFFICES

New York

980 Old Country Road
Plainview, N.Y. 11803
516-433-6530

Chicago

Gerald L. Taylor
333 N. Michigan Ave.
Chicago, Illinois 60601
312-332-7683

Denver

Roy McDonald Associates, Inc.
846 Lincoln Street
Denver, Colorado 80203
303-825-3325

Houston

Roy McDonald Associates, Inc.
3130 Southwest Freeway
Houston, Texas 77006
713-529-6711

Tulsa

Roy McDonald Associates, Inc.
2570 S. Harvard Ave.
Tulsa, Oklahoma 74114
918-742-9961

Dallas

Roy McDonald Associates, Inc.
Semmons Tower West
Suite 411
Dallas, Texas 75207
214-637-2444

San Francisco

Roy McDonald Associates, Inc.
625 Market Street
San Francisco, California 94105
415-397-5377

Los Angeles

Roy McDonald Associates, Inc.
1313 West 8th Street
Los Angeles, California 90017
213-483-1304

Portland

Roy McDonald Associates, Inc.
2035 S.W. 58th Avenue
Portland, Oregon 97221
503-292-8521

There are 50 sound reasons why you should look to FAIRCHILD for Professional Audio Components...

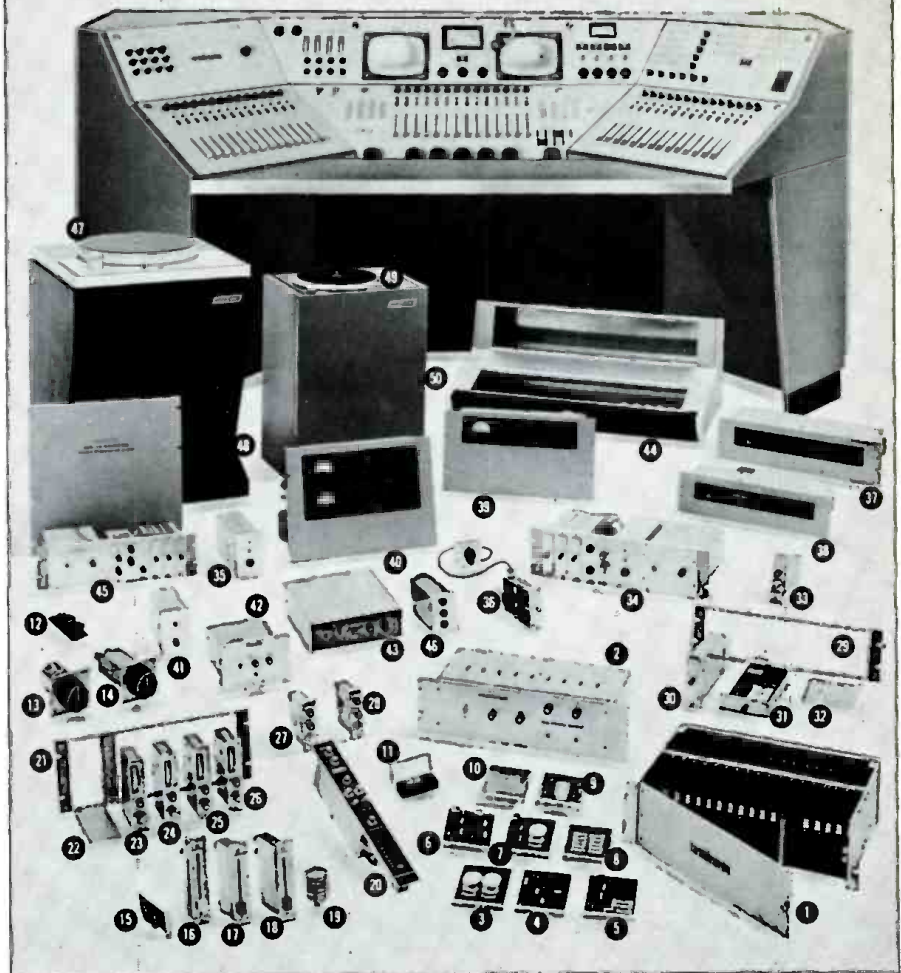

and here they are!...

1. Integra I Card Cage (692 RM)
2. Integra II Power Supply (624)
3. Double Remote Attenuator Card (692 D/2)
4. Remote Compressor Card (692 AGC)
5. Remote Equalizer Card (692 EQ)
6. Double Preamp Card (692 AD/TX1)
7. Preamp, Remote Attenuator, Relay & Mix. Net. Card (692)
8. Ten SPST Relays with Mix Net Card (692 SW-10)
9. Five DPST Relays with Mix Net Card (692 SW-5)
10. Mixing Network (692 MX)
11. Mono Cartridge (225-A)
12. Remote Stereo Board (669 ST)
13. Rotary Attenuator (669 II)
14. Rotary Stereo Attenuator (669 ST)
15. Remote Attenuator Board (668 RAB)
16. Slide Actuator (668 ACT II)
17. Slide Attenuator (668 II)
18. Slide Stereo Attenuator (668 ST II)
19. Remote Attenuation Cell (668 RAC)
20. Integrated Mixer Control Module with EQ, AGC, and other features (FICM)
21. Rack Frame (663 RM)
22. Blank Plate (663 BP)
23. De-Esser (675)
24. Ambient Noise Control Unit (653)
25. Dynalizer, Automatic Loudness Control (673)
26. Compact Compressor (663)
27. Passive Program Equalizer (664)
28. No Loss PGM Equalizer (664 NL)
29. Rack Mtg Frame (662 RM)
30. Preamp, Line Amp (662)
31. Preamp, with 2 Remote Attenuators (692)
32. Blank Plate (662 BP)
33. Autoten, Signal Controlled Switch (661 TL)
34. Industrial "Handoff" Gain Shift Intercom Electronics
35. 10-Watt Monitor Amp (610)
36. Phono Equalized Preamp with HF. Equalizer (676 A/RO)
37. Single Channel HF. Limiter, Conax (600)
38. Stereo Conax (602)
39. Mono Limiter (660)
40. Stereo Limiter with Matrixing (670)
41. 100 MA Power Supply (667 B)
42. 6.3V 3A DC Regulated Power Supply
43. 24V 2A DC Regulated Power Supply
44. Custom Shell for Mixing Console
45. Reverberation Device, Complete (658 A)
46. Reverberation Generator (658 B)
47. 16" Professional Turntable 2 and 3 spd. (750)
48. Turntable Base (751)
49. 12" 2-speed Turntable (755)
50. Turntable Base (756)

... AND MANY OTHERS!

Write to FAIRCHILD - the pacemaker in professional audio products - for complete details.

FAIRCHILD

RECORDING EQUIPMENT CORP.
10-40 45TH AVENUE • LONG ISLAND CITY,
NEW YORK 11101 • PHONE (212) 784-6163

Circle 16 on Reader Service Card

The Feedback Loop

—JOHN A. McCULLOCH

The Feedback Loop invites your questions on any subject pertinent to professional audio. Address your queries to THE FEEDBACK LOOP, *db Magazine*, 980 Old Country Road, Plainview, N.Y. 11803. Please enclose a stamped, self-addressed envelope. Mr. McCulloch will answer all letters in this column or by mail.

● A letter from Mr. R. E. Pickett Jr., of WEEW in North Carolina, prompted me to make a review of echo and reverb devices. And . . . the review turned into a search, the search into a project—which is by no means complete. Yet, at this point, it is possible to answer, in part, the questions Mr. Pickett raised.

He asks; "What reverb equipment is primarily in use by stations large and small across the country?". He might also be asking which devices are most like the natural acoustical reverberation. Before we can attempt to answer any questions it is necessary to define our terms, and to determine what effect we want to achieve.

Reverberation is the natural smooth decay of sound in an enclosed space. Larger volumes will have longer periods of decay, and will be more reverberant. Time of decay is not necessarily uniform with frequency. *Echo* is the distinct, time-delayed repetition of the original sound, reduced in amplitude. Amplitude of repetition is not necessarily uniform with frequency.

Lets take echo first, if that is your desired effect. Probably the most simple means by which the repetition of

a signal may be obtained is through the introduction of a mechanically delayed signal, reduced in amplitude, into the primary signal. An example would be the use of a tape recorder having separate recording-and-reproduction facilities through which the signal is passed with a portion of the delayed output being reintroduced into the input. Depending upon the speed of the machine and the spacing of the reproducing head from the recording head, the effect will range between rapid multiples and separate and distinct echos.

Several commercial devices using a closed loop of tape and multiple reproduce heads have been manufactured. Because the heads provide the required delays and multiplicity of signals, the problem of system feedback (due to the requirement of introducing the output signal into the input as in the first method described) is eliminated. Good results are possible, but the artificial source of the sound is generally discernable, and is not considered natural. It is, however, a valuable tool which should not be rejected simply as a gimmick.

Reverb is the artificial means of seemingly increasing the size of the recording space. It may be deemed necessary due to a small studio, or more often the use of close miking technique. Ideally, we would wish the effect to be that of the musicians being placed in an acoustical environment proper to the music being performed. To perhaps enable a fuller use of the reverb function (and I am speaking solely of the artificial reverb) we must look at the components and their relationships that make up the natural reverberation of an enclosed volume.

There are three main and inter-related components in acoustical reverberation—*time, amplitude, volume*. For an enclosed space of volume there is an optimum time of reverberation. That time is calculated as the period measured from the cessation of source sound to the point wherein the reflected sounds have been reduced to 1/1,000,000 the source intensity, or -60dB. There may be many time periods found for identical volumes, but different rooms. This is due to the physical prop-

erties of the rooms that give different degrees of absorption or reflection.

Many papers have been presented giving the *ideal* or optimum period of reverberation for given volumes. W. A. MacNair, in the *Journal of the Acoustical Society of America*,* published figures for reverberation times at 1 kHz *versus* enclosed volume. Subsequent publications contain minor variations of this plot (FIGURE 1) or suggested that a tolerance of this plot, producing a band of acceptable values, be the best representation. For ease of examination we shall use Mr. MacNair's graphic representation.

In the same article, Mr. MacNair also computed the desired rate of decay vs. frequency based upon the nonlinear aspect of our auditory senses (FIGURE 2). This plot was based upon the same data which later led to the Fletcher-Munson curves. It represents the necessary change in decay period from the optimum 1 kHz point to produce a smooth sounding decay. For example, if we have a reverb period of 1 second at 1 kHz, a period of 2 seconds is required at 80 Hz to sound the same. Correcting the room to produce decay *versus* frequency following the curve, will then give a smooth decay, not appreciably varying with frequency, as observed by the listener.

From these two graphs, we may now select an enclosure to our liking, or one which we would like to have had to make a recording. Actual rooms, of course, do differ from the optimum, and if their variations are known, it is not inconceivable that an actual room may be duplicated electro-mechanically. Before we construct the room, let us examine the various means of reverb available in the current market.

To my knowledge there are three methods of producing reverb currently in use. First, and usually most expensive, is the preparation of a special room with highly reflective surfaces, the *reverberation chamber*. (I refuse to call it an *Echo* chamber, as its characteristic is not that of separate and distinct repetitions.) Next are two electro-mechanical methods, each of which has its

*January, 1930

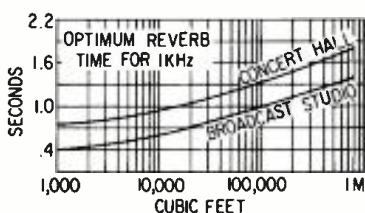

Figure 1. The optimum reverb time for 1 kHz based on the work of Morris and Nixon in the *Journal of the ASA*, October 1936.

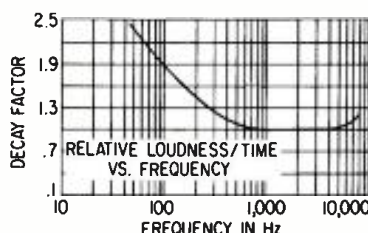

Figure 3. The response curve derived from a small spring.

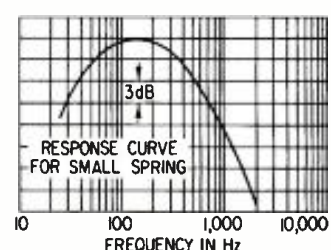

Figure 2. The relative loudness/time versus frequency.

adherants, the *spring* and the *plate*. All three methods, when properly constructed and operated will give excellent simulation. The plate, to be effective is massive, relative to spring devices, and moderately expensive. It is preferred by a great many recording engineers who can not obtain a good chamber. But the widest range in quality, from useless to superb, is covered by the spring device.

Insofar as the spring units are more readily available to us in their basic form, *sans* electronics, and are reasonably inexpensive in that form, we shall look particularly at their natural characteristics. Time decay, and separation between induced signal and first reflection are functions of the spring length. Amplitude decay, frequency response, and level capabilities are functions of the transducers, the material of the spring, and its length. By using a very slow sweep rate it is possible to approximate the characteristic of the unit selected, and thus determine what electronic corrections are necessary to produce a more pleasing, and more nearly optimum reverb.

FIGURE 3 graphs the frequency response of a typical spring unit of the seven-inch variety. Since amplifiers are required to both drive, and retrieve signals from the unit, necessary equalization to provide flat response is easily accomplished. Flat response is **not** what we must seek. A response curve simulating the corrected decay *versus* response curve of FIGURE 2 is the aim. Better units provide adjustable equalization to enable the user to construct his room. Driving the spring unit approximately twice as hard will produce the near simulation of doubling the reverb time. In this manner the correction for decay time may be approximated electronically. While not an absolute method of duplication of existing room conditions, this would allow selective equalization to approximate the varying sizes of rooms.

As far as the use of reverb in broadcasting, the EMI plate, and Fairchild and Fisher springs are the units I most often see. That is not to say these are the only units. In the FCC rules I cannot find a specific ruling governing the use of reverb or echo devices. When I ask engineers who do use these devices, it seems that the rule governing equalizers and limiters is their guide for proof-of-performance. In effect it requires the neutralization of the peculiar action component of the device; that is, no equalization, though the signal passes through. I would assume, and these engineers agree, that if the main signal passes through the device, the reverb function must be defeated and the amplifiers measured. If it only contains the reverb component, it should be eliminated from the circuit.

Is price
the only
reason
you never
bought a
Neumann
microphone?

You just
ran out of
reasons.
microphone?

Now you can own a Neumann microphone for as little as \$237. Because we've reduced our prices by as much as 30%.

Using advanced transistor electronics, our new FET-80 Series Microphones give you the same superb acoustical quality for which Neumann has always been world-famous.

And—incredible as it may seem—by paying less, you get more features than ever before:

Central compatible powering, for example, that provides you with greater flexibility. By installing one power supply for just \$82.50, you can power upwards of 30 microphones.

Long life batteries may be used where there's no AC power available. These batteries give you approximately 10 days of continuous operation for less than 1¢ an hour.

And you get a two-year guarantee.

Neumann FET-80 Series Microphones are available in many different models, priced from only \$237 to \$417.90. Send today for our free illustrated brochure

Up till now, only the major recording studios of the world could afford to own a Neumann microphone. And every one of them did. Now you can, too.



Gotham Audio Corporation db2
 2 W. 46th Street, N.Y., N.Y. 10036
 Please send me your free brochure and technical article describing Neumann's FET-80 Series Microphones.

Name _____
 Company _____
 Address _____
 City _____ State _____ Zip _____

Circle 15 on Reader Service Card

COMPACTABILITY

STEREO STUDIO IN AN ATTACHÉ CASE



A Six Channel Portable Mixer to Help You Get the Show on the Road

Now... a mixer for professional use that weighs only 25 pounds—in a case measuring 18" x 12¼" x 5¼"! Can be carried anywhere. Great for "remotes". An excellent standby system. Low price but no sacrifice in quality. Ideal for colleges.

THE MODEL 1800 AUDIO LIMITER

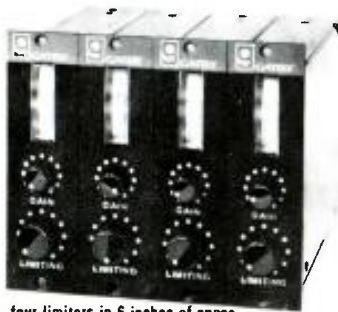

four limiters in 6 inches of space

Unsurpassed for Price . . . Quality . . . Compactness . . . and Performance

At last... build full control into the console itself with Model 1800 Audio Limiters, protecting every input against unexpected peaks and permitting the amount of limiting on each channel to be controlled. Only 1½" x 5½" x 7". Exceeds rack-mounted limiters in performance.

GATELY ELECTRONICS



57 WEST HILLCREST AVENUE
HAVERTOWN, PENNA. 19083
AREA CODE 215 • HI 6-1415
... have you checked Gately lately ?

Theory and Practice

NORMAN H. CROWHURST

● A big area where theory and practice apparently differ occurs in feedback application. The deviations can take all forms, depending on the circumstances. We will content ourselves here with a couple of fairly simple ones, where the effect of feedback in reducing distortion isn't what calculations would predict.

Just to make it fair to that devious devil feedback, we'll take one case where he gives us more than we expect and one where he sells us short.

Many who have put together their own amplifiers must have experienced the first, with both tube and transistor circuits. You start with a circuit without feedback, that has a curvature giving say 3 per cent harmonic distortion at full output.

You are faced with a compromise problem, it appears, in that you don't have too much gain to spare. You can't really spare more than 6 dB feedback, from which you'd expect to reduce dis-

tortion only to 1.5 per cent, which isn't low enough. And you don't want to go to the trouble of adding another stage to get more gain. You feel it isn't worth that, with all the extra stability problems it could cause.

So you try 6 dB, as that is all you can spare, hoping for a miracle. And behold, a miracle happens. The distortion drops to about 0.4 per cent. How did that happen? It violates feedback theory, it seems.

Of course, it can't in fact. Somehow or other, you're getting more than 6 dB feedback, although it only *looks* like 6 dB. How can that be? Well, here's one example. FIGURE 1 shows the essential part of the schematic. This isn't the part where the main distortion comes in, which is the higher level output stages.

Each transistor shown has a nominal current gain of 100. The first stage operates with a collector voltage about 1/6th of supply. The 33K resistor provides about 15.6 dB of d.c. feedback, to

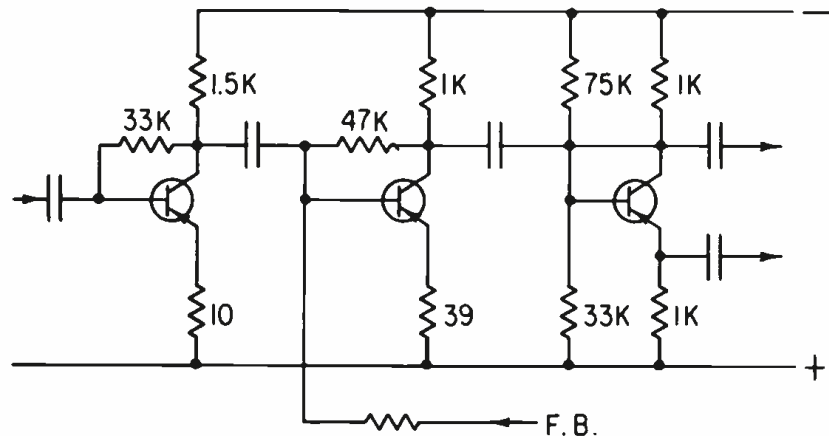

1. Overall Feedback AB	2. dB Distortion Reduction	3. Stage 2 Gain Reduction	4. Stage 2 Gain	5. Base Input Ohms	6. Collector Load Ohms	7. Stage 1 Gain Reduction	8. Stage 1 Gain	9. 2 Stage Gain	10. Effective fb. Gain change
0	0	3	33	1,330	700	3.1	32	1050	0
1	6 dB	4	25	975	590	2.8	36	900	1.4dB
2	9.5dB	5	20	780	515	2.56	39	780	2.6dB
3	12 dB	6	16.7	650	450	2.36	42.5	705	3.5dB
4	14 dB	7	14.3	560	410	2.24	45	640	4.3dB
5	15.6dB	8	12.5	490	370	2.12	47	590	5.0dB
6	16.9dB	9	11.1	433	336	2.02	49.5	550	5.6dB
7	18 dB	10	10	390	310	1.94	51.5	515	6.2dB

Figure 1. The circuit portion under discussion in the text. The column below illustrates the various degrees of over-all feedback in tabular form.

stabilize this operating point. The a.c. feedback over this stage depends on collector load, but is always less than 15.6 dB.

The middle stage operates with its collector at about $\frac{1}{3}$ rd of supply voltage, stabilized by the 47K feedback resistor, which provides about 9.5 dB of feedback, both a.c. and d.c., because the third stage doesn't materially load the collector of this stage.

The third stage is a phase splitter. With 1K collector and emitter loads, it has a base input resistance of 100K, paralleling the 33K from base to ground. This makes 25K for the bottom part. Using 75K for the top sets the base voltage at $\frac{1}{4}$ th of supply. So the third stage emitter voltage is $\frac{1}{4}$ th of supply, and the collector voltage $\frac{3}{4}$ th supply, giving maximum signal-handling capacity at this point.

Now let's figure what happens with various degrees of over-all feedback. If you add this by changing the value of the feedback resistor, you'll find it never gives quite as much gain reduction as you'd expect. We've tabulated the calculations for simplicity.

The first column is the AB factor for the over-all feedback, given as a multiple of the base input signal current at the middle stage, where it is injected. Column 2 gives the effect of this feedback in reducing distortion (from later

stages), obtained by taking 20 times log to base 10 of 1 plus the factor in column 1.

This is the effective feedback from the viewpoint of distortion. But how do you measure it? You can't. What you measure is the change in over-all gain. So we'll figure that, to see how the effect we found happened.

Column 3 shows the factor by which current gain of the middle stage is reduced. With no over-all feedback connected, this is 3, because of the 47K resistor, which feeds back a signal current equal to twice the base input signal current, so that 3 times the input signal current is needed from the first stage.

Column 4 is the second stage gain, found simply by dividing the normal gain, 100, by the factor in column 3. Column 5 gives the base input impedance of the middle stage, found by multiplying the 39-ohm emitter resistor by the working current gain, which is the

figure in column 4.

The collector load for the first stage is the parallel combination of the resistance calculated in column 5, with the collector resistance of 1.5K. This result is calculated in column 6.

The first stage feedback product (AB) is found by dividing 33K by the total collector load value (column 6) and then dividing this into the normal gain of 100. Adding 1 to this AB factor gives column 7, which is the factor by which first stage gain is reduced by the 33K feedback resistor.

Now divide 100 by the factor in column 7, and we have the working first stage gain, column 8. Finally, the over-all gain, from input to the phase splitter input, is found by multiplying columns 4 and 8, the individual working stage gains. This is entered in column 9.

Finally, the gain change, as measured externally, resulting from connecting the over-all feedback, is found by dividing the gain with feedback (column 9) into that without feedback (the top figure in column 9). Converting this to dB gives column 10.

From this, we see that 6 dB actual gain reduction corresponds with an effective over-all feedback somewhere between 16.9 and 18 dB. This is what reduces the distortion from 3 per cent to 0.4 per cent, although gain is only reduced 6 dB.

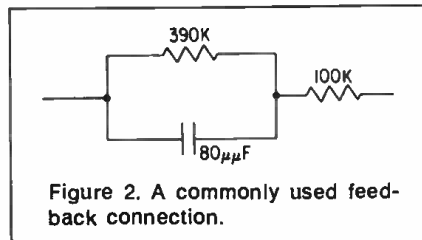

Figure 2. A commonly used feedback connection.

THE DOLBY A301 AUDIO NOISE REDUCTION SYSTEM

Making the Master Recordings of the Future

DOLBY LABORATORIES INC.

Already in use in eighteen countries, the Dolby system is making master recordings which will withstand the test of time.

The system provides a full 10 dB reduction of print-through and a 10-15 dB reduction of hiss. These improvements, of breakthrough magnitude, are valid at any time—even after years of tape storage. This is why record companies with an eye to the future are now adopting this new revolutionary recording technique.

A301 features: Easy, plug-in installation • solid state circuitry • modular, printed circuit construction • high reliability, hands-off operation. Performance parameters such as distortion, frequency response, transient response, and noise level meet highest quality professional standards.
Price \$1,950 f.o.b. New York.

NEW optional half-speed adaptor modules for premium quality tape to disc transfers.

NEW Remote Changeover option cuts costs, enables one A301 unit to do the work of two.

333 Avenue of the Americas • New York • N.Y. 10014
(212) 243-2525. • Cables: Dolbylabs New York

No Strings!

...With the
SONY
 Solid-State CR-6
 F.M. Wireless Microphone



Tessie Mahoney
 of the syndicated
 Winchell-Mahoney
 Television Show.

Sony brings new freedom to the profession — a totally cordless communication system that meets the most critical industry standards!

Take a compact, lightweight, solid-state FM transmitter and professional-caliber condenser microphone. House them in a tiny capsule less than three inches long. Attach a small battery pack and you'll move freely through crowds for on-the-spot interviews with a hand-held probe. Or, pocket the cigarette-size extra power pack, wear the capsule as a lavalier.

Anywhere indoors or outdoors, the Sony solid state AC/DC receiver is ready to capture every sound — flawlessly. Distortion and interference usually found in conventionally designed wireless microphones is completely eliminated by the CR-6's Sony-special frequency modulation system. And you'll never worry about a power source — the Sony CR-6 F.M. Battery operated receiver packs its own power. Available in three frequencies — 42.98 MCS, 35.02 MCS or 33.14 MCS (must be specified at time of order).



Sony offers you professional performance

... with no strings attached.

SONY'S PROOF OF QUALITY A FULL ONE YEAR WARRANTY



8150 VINELAND AVENUE • SUN VALLEY, CALIFORNIA • 91352

THEORY AND PRACTICE *continued*

Now for the other case. This could be either a transistor or tube-type amplifier, and we'll only consider the type of feedback connection. It's shown in FIGURE 2. The response of the feedback connection shows a boost of about 14 dB, over a 5:1 frequency range.

Suppose the over-all externally measured frequency response of the amplifier is essentially flat up to 25 kHz, beyond which the fall-off is fairly sudden (FIGURE 3). As the loop gain adds the feedback connection response to this, the real, closed loop gain actually has a 14 dB peak before it finally falls off.

It is morally certain that when it does take its dive, the feedback is no longer negative, but goes through the 90-degree point somewhere near where it turns over. The amount of feedback at this point will be virtually nil.

This means that any spurious components at 25 kHz generated internally by the amplifier won't get reduced by feedback. They may get changed a little, but very little.

Now suppose the amplifier without feedback has distortion consisting of 3 per cent 3rd harmonic and 0.8 per cent 5th harmonic. The fundamental, of 5 kHz, will get about 14 dB feedback. So, compared to the final level of fundamental, after feedback, it will be 5 times what it was compared to the fundamental with no feedback (assuming the levels are readjusted to be the same). So we will have about 4 per cent 5th, with feedback.

The 3rd is in better shape. Probably the phase shift will be about 30 degrees. So it will produce about 86 per cent cancellation of 3rd, multiplied by the feedback factor for 3rd, which will be

about 1.6 times its value for 5th. Feedback factor changes to about 1.4 on a 6 dB/octave slope, bringing the 3 per cent down to about 2.15 per cent.

Here is the net result, then. Without feedback, the distortion was 3 per cent 3rd and 0.8 per cent 5th. Feedback changes it to 2.15 per cent 3rd and 4 per cent 5th, which is scarcely an improvement. If the distortion reducing effect is measured at 1 kHz, there is probably in excess of 20 dB feedback to fundamental and at least 14 dB feedback of the 5th harmonic, which is now at 5 kHz.

So the results measured at 1 kHz would be changed to 0.4 per cent 3rd and 0.16 per cent 5th, which is more acceptable. As harmonic measurement is usually made at 1 kHz or not much higher, the amplifier may measure acceptably on harmonic distortion. But how about IM, the kind that the international method, using difference frequency should measure?

This measurement could also look satisfactory, if we take two frequencies 100 Hz apart, in the vicinity of 5 kHz. This is because the filter would only look for a 100 Hz component. But the 5th harmonics of the two waves would be in the vicinity of 25 kHz, where no feedback is operative. Any non-linearity would cause rectification, generating a spurious 500 Hz difference signal.

This could be found by exploring for frequencies other than 100 Hz. But, on music with difference tones and overtones in these regions, really nasty intermodulation might be audible, much worse than the measurements and specifications of the amplifier would lead you to believe.

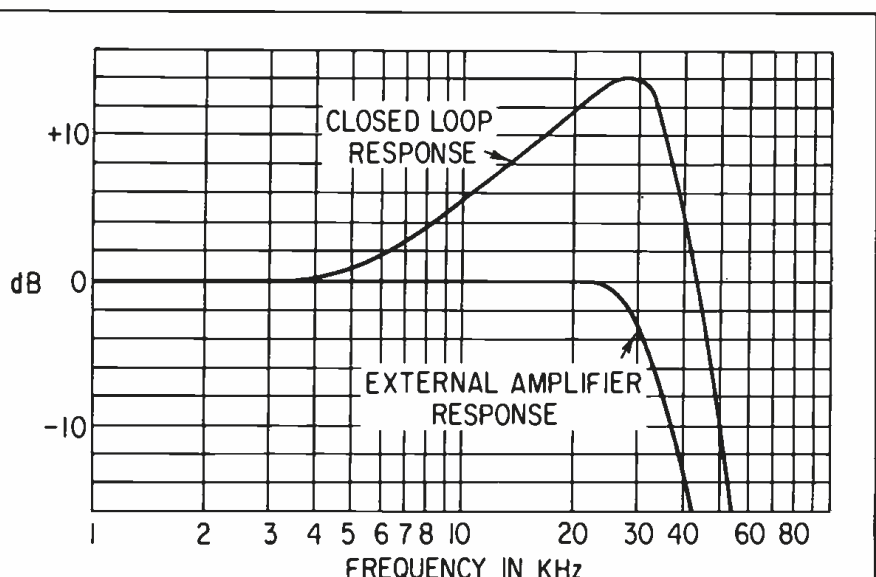
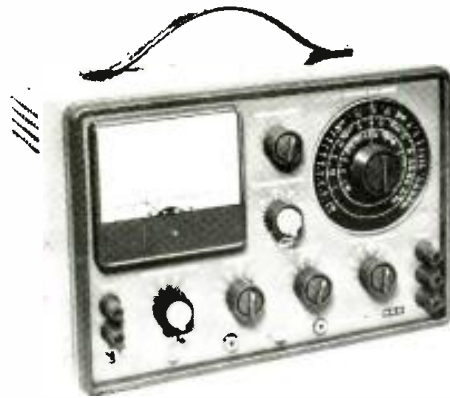

Figure 3. The loop gain necessary to provide a flat externally-measured response.

Professional Quality Instruments AT LOWEST COST



EICO 965 Faradohm Bridge/Analyser
Low bridge supply voltage permits testing of all types of capacitors. Measures diode reverse and transistor quiescent current. Measures insulation resistance and leakage currents. **\$175.00**



EICO 902 IM/Harmonic Distortion Meter and A.C. VTVM
High quality tuning capacitor provides easy frequency setting. Less than 0.7 volt input required for measurements. **\$250.00**



EICO 1078 Metered A.C. Supply
0 to 140 V a.c. adjustable output at 7.5 A max. Separate output ammeter and voltmeter. **\$95.00**

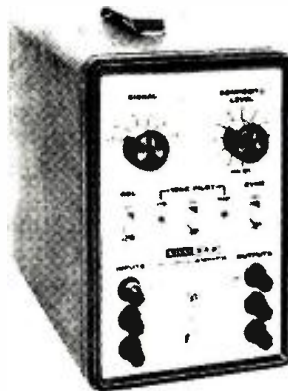

EICO 342 FM Multiplex Signal Generator
Crystal-controlled 19 kHz (± 2 Hz) pilot. Both composite audio and f.m. r.f. outputs. F.m. stereo broadcasting from tape. phono/oscillator source. Low distortion signals to permit alignment for lowest distortion. **\$175.00**



EICO 378 Audio Generator
Switch selectable frequency output of 1 Hz to 110 kHz. Attenuated output in eight steps. Metered output voltage. Excellent frequency resettability. 0.1% distortion 20-20,000 Hz. **\$79.95**



EICO 250 A.C. VTVM and Amplifier
Measures a.c. voltages from 100μ V to 300 V. Cathode follower input circuit for greatest stability. **\$89.95**

NOW THESE INSTRUMENTS MAY BE ORDERED ON A DIRECT MAIL-TO-YOU BASIS. SATISFACTION IS FULLY GUARANTEED.

BSC Sales Co., 78 Wellington Road, Garden City, N.Y. 11530

PLEASE SHIP ME THE FOLLOWING ITEMS:

MODEL _____ QUANTITY _____ | MODEL _____ QUANTITY _____
MODEL _____ QUANTITY _____ | MODEL _____ QUANTITY _____

I HAVE ENCLOSED \$ _____ AS PAYMENT FOR THESE UNITS. I UNDERSTAND THAT THEY WILL BE SHIPPED F.O.B. NEW YORK.

NAME _____ COMPANY _____

ADDRESS _____

CITY _____ STATE _____ ZIP _____

I understand that I must be fully satisfied or I can return the unit within ten days for refund.

ACTIVE COMBINING NETWORK



ACN-1P
\$95

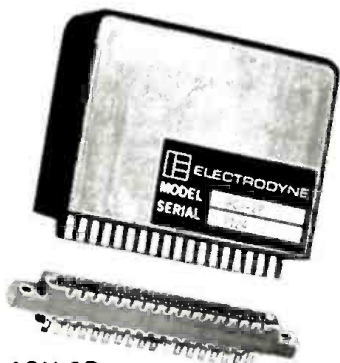

ACN-2P
\$110

ACN-1P TECHNICAL SPECIFICATIONS

INPUTS: Combines up to 21 inputs.
GAIN: Can be strapped for 0, +10, or +20db.
ISOLATION: Over 70db between inputs (sending from 600 ohms).
POWER REQUIREMENTS: 24 volts regulated 20 ma.
PHYSICAL DIMENSIONS: 3 1/4" long, 1" wide, 2 3/4" high.
ACN-2P same specifications except it combines up to 31 inputs and has unity gain only.

For complete literature write or phone:

ELECTRODYNE CORPORATION
 7315 Greenbush Avenue • North Hollywood • Calif. 91605
 Phone: (213) 875-1900 • Cable Address: "ELECTRODYNE"

The Audio Engineer's Handbook

GEORGE ALEXANDROVICH

Tape Recording

● A scant three decades ago all recording was done on transcription discs. The tape machine appeared on the U.S. scene after the second world war. Within a few years, tape almost forced transcription recording out. The most appealing features of the new system were its abilities to edit and re-record. Tape recorders, though bulky at first, were less susceptible to malfunction than fragile disc recording systems.

Today you would be hard-pressed indeed to find a sound studio without tape equipment. But even those whose final product may be a disc often don't do disc cutting, preferring instead to send their mastering work out.

It is also customary to find more than one machine in a studio; each may well be performing different functions. Some are used for playback only, others in editing rooms, etc.

Regardless of its specific function, a tape machine will only continue to give proper service if it maintained as the precise piece of mechanical/electronic machinery it is. The final quality of the recorded tape will be dependent on the mechanical and electronic capabilities of the machine, the manner in which it is used, and the tape itself.

Part of the value of any recording apparatus is its ability to store information without alteration. There should be no frequency discrimination, distortion, noise content, speed variation and signal modulation (flutter) by the equipment. Of course, an amount of signal alteration will inevitably remain in each machine, but its degree should be small. Limits for total signal deterioration have been established experimentally on the basis of what has been considered the minimum requirements for the preservation of the authenticity of the original information. These limits have served as a guide for equipment designers. As the years have passed, these limitations have been changed by better equipment. This better performance has continually forced review and tightening of specifications.

The competitive nature of the recording industry forces the studio to keep up with the state of the art. Often this calls for the acquisition of new equipment. New tape recorders do offer better performance, better quality, and improved operating convenience over

machines of just a few years ago. But as these new machines are used, they will age and begin to deteriorate unless a conscientious program of maintenance is undertaken. Just as in any other field, a stitch in time will keep the studio's reputation high while keeping operating costs down.

The most vital part of the recorder is its electronics. Today, all professional recorders are transistorized, resulting in minimal maintenance when it is required. However, the techniques are different from those used with vacuum tubes. Thus, the inexperienced maintenance man can find a transistorized unit a nightmare.

Most manufacturers are helping maintenance by providing explicit instructions, easy-to-replace plug-in circuit boards, or efficient factory service. Nevertheless, there are some basic ground rules which may help to determine the precise part of the circuit in which trouble has occurred.

With some variations, the electronic functions of a tape recorder can be divided into three basic categories:

- Playback
- Record (including bias)
- Erase

The majority of professional machines have each of these functions pretty well segregated so that each function may be singled out for the purpose of test and maintenance. Some machines have their bias oscillators driving the erase head as well, but most recorders have separate oscillators for erase and bias, each operating on its own frequency.

Playback Test

The correct sequence for checking the functions of a recorder starts with playback. To check playback it is necessary to feed the output of the machine into a vtvm, 'scope, proper load, and suitable monitoring device. The 'scope is important because it is not sufficient to have a meter indication and hear the tone; you must see it if you want to eliminate the possibility of r.f. modulation of the signal or hidden distortion normally not detected under standard test conditions.

Before turning on the tape machine for testing, connect the test instruments to the output (with suitable loads) and take a noise measurement. This should exceed the specified s/n for the machine by at least 10 dB. In this way ac-

tual measurements will not be affected by possible improper connection of the test gear to the machine output. Again, before the machine is turned on, demagnetize the heads. Be sure to keep the degausser away from any recorded tapes while it is on.

Now, with the recorder turned on, play back a standard alignment tape using the proper speed and equalization. Mark down the results for all frequencies and levels. (Follow the instructions with the tape for its proper use.) Indications should be recorded from the external vtvm as well as the machine's v.u. meter so that possible errors in the accuracy of the internal metering and output level can be determined.

What can go wrong with the playback function of a tape machine?

For one thing, the playback head itself. It doesn't take much to disturb the head azimuth alignment on some machines, seriously affecting high-frequency response. And uneven wear of the head gap can cause the tape to contact the gap at an incorrect angle, producing sufficient misalignment between the recording and gap plane to further reduce high frequencies.

If high frequencies cannot be restored by ordinary azimuth alignment (assuming for the moment that electronics and test tape are known to be in good order) the playback head will have to be repolished (by an expert) or replaced.

Before making a firm judgement about the head, double check the test tape. Play it on another machine and compare the results. Even a small amount of residual head magnetism can cause a partial erasure of the recorded signal, affecting mostly the high frequencies. Actual mechanical wear of the tape may also be a contributing factor to apparent high-frequency loss. It has been suggested by some authorities that the signs of a damaged tape are fluctuations of the reproduced signal as opposed to the steady signal of a new tape. But this can be misleading since less-than-perfect mechanical head-to-tape contact problems exist. If increasing the hold-back tension or applying finger pressure of the tape against the head (if you can) causes the high-frequency response to rise, the tape is good, but head contact must be improved.

There is a way to test the playback circuits without the use of a test tape. Make a small coil by winding a few dozen turns of thin insulated wire. The coil should be approximately one-quarter to one-half inch in diameter. This may be accomplished by winding the wire around a pencil (loosely) and then pulling it off and putting it between two layers of masking or cellophane tape. The two ends of the coil

should be connected to an audio oscillator with a 470- to 560-ohm resistor in series.

The coil should be placed directly in front of the playback head and fed a sufficiently strong signal so that it drives the playback electronics into saturation. Now adjust the generator level so that an undistorted waveform is achieved at the output of the playback electronics. By changing generator frequency and level, you can find out everything about the amplifier that is necessary to know, including the equalization characteristics of the particular machine in combination with the playback head.

Once the playback characteristics of the machine have been established, remove the alignment tape and substitute a virgin or carefully bulk-erased tape. Now, by feeding a signal into the input of the machine and recording it (at a suitably low record level to prevent tape saturation—perhaps -20 dB) and then monitoring the playback, you get a picture of the over-all record/playback response. By comparing this over-all response to the previously established playback curve, the error of the record characteristics may be determined. (It is assumed that the record head is in correct azimuth alignment—use a very high-frequency signal and adjust for maximum output through the previously aligned playback head.)

If there is a record error it should be corrected. It is not a good idea to compensate the playback electronics to make up for record deficiencies. If tapes from other machines are to be used, the equalization will be wrong.

While the recording function is being checked, you should establish that the correct bias is being used for the kind of tape you use. Setting bias should be done on the basis of the tape recorder manufacturer's instructions. A general rule is that bias is adjusted until the mid-range frequencies produce the highest attainable peak output with a constant input level. Then the output should be rechecked at the frequency extremes and the bias optimized for the most desirable response. (Some machines are adjusted so that the mid-range output reaches its maximum. Then the bias is pushed beyond maximum so that it falls back about 1-2 dB.) Once set, the bias can be checked easily on those machines that have a bias-check position switch for their v.u. meter.

In any case, keep a record of the performance data, particularly when it is new, so that future performance deterioration can be precisely determined.

Future columns will contain recorder maintenance hints, treatment of the erase function and selsync, as well as mechanical troubleshooting.

One of a series of brief discussions
by Electro-Voice engineers

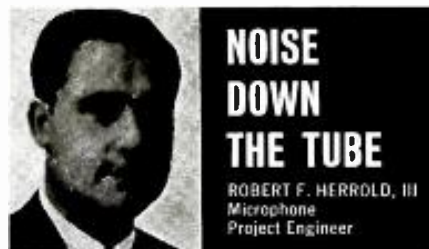

Most directional microphones are quite similar in their method of attenuating unwanted sound. A path to the back of the diaphragm is provided that controls phase so that sound arriving from an unwanted direction is attenuated, while sound from the desired direction is relatively unaffected.

This path is usually located quite close to the diaphragm for optimum effectiveness at high frequencies. However a single path cannot uniformly affect all frequencies. This results in decreasing attenuation of unwanted sound with decreasing frequency, plus the added problem of "proximity effect" that changes overall frequency response with varying distance.

To overcome these deficiencies, Electro-Voice created the Variable-D* microphone, utilizing several discrete openings at varying distances from the rear of the diaphragm. This combination of multiple openings provided more uniform polar patterns at every frequency and vastly reduced proximity effect.

Further study indicated a need for many more paths to the back of the diaphragm for greater polar uniformity and more uniform off-axis response. Out of this investigation came the Continuously Variable-D* microphones, best typified by the new RE-15 super cardioid model.

Two attenuation systems are included in the RE-15. Frequencies above 1000 Hz are cancelled by rear ports located quite close to the diaphragm (two are used to provide a symmetrical polar pattern and uniform pressure on the diaphragm). In addition a slotted tube leads from the center of the RE-15 diaphragm, through the magnet to the rear of the microphone. This tube is designed to vary in effective acoustic length for optimum attenuation of unwanted sound below 1000 Hz.

The slot is covered with a tapered acoustic resistance that attenuates low frequencies entering the tube close to the diaphragm, but does not affect lows entering at the rear of the tube. In addition, the tube acts as an acoustic inductance for highs entering the tube near the back. Thus as frequency rises, the effective tube length becomes progressively shorter.

This combination of tapered acoustic resistance and varying inductance provides a path length that is proportional to $1/f$, where f = frequency. This path length is calculated to provide optimum reduction of sound arriving from the rear while maintaining high sensitivity to sound arriving from the front.

The result is an unusually uniform polar pattern at all frequencies combined with excellent off-axis frequency response and virtually no proximity effect. Current efforts are devoted to further exploring variations on this basic new method to achieve directionality.

*Registered trade mark. Electro-Voice Variable-D and Continuously Variable-D microphones are covered under U.S. Patent Nos. 3,095,484 and 3,115,207.

For reprints of other discussions in this series,
or technical data on any E-V product, write:
ELECTRO-VOICE, INC., Dept 583BD
686 Cecil St., Buchanan, Michigan 49107



Circle 20 on Reader Service Card

Editorial

THE NAB CONVENTION continues to offer to broadcasters a comprehensive breakdown of new equipment and techniques. This year's exhibition, held in Chicago's giant Conrad Hilton Hotel, was the biggest yet, with some one hundred and thirty exhibitors present in fifty-four thousand square feet of space. And, as our photographs show in part, the exhibits combined to rank as one of the most attractively mounted trade expositions we have ever attended.

As might be expected, the giants of the industry dominated the space. One of the largest, Norelco, used only *part* of its area to install a complete operating color-tv studio. RCA and GE had similar displays.

A good portion of the exhibits were directed to video broadcasters or involved r.f. equipment, but there were many large companies, such as Gates and Collins, with vast space devoted to audio needs. The purely audio-frequency oriented user certainly found plenty at the show to keep him occupied.

By far, the greatest interest was generated by manufacturers of equipment for the full or partial automation of radio-station operation. There were perhaps a half-dozen different displays of automation systems. Several of these were highly sophisticated, computer-controlled packages with automatic logging and printing features. Automation, therefore, looms bigger than ever before. We believe that automated systems, in one degree of completeness or another, will soon be found in the vast majority of radio stations.

Toward that end, *db* will feature several editorial discussions of automation and its impact on the industry. All evidence points to one fact: regardless of the fears of many, automation will not cause the widespread unemployment of engineering and announcing talent. Rather, these people will be freed from the mundane necessities of station operation to the opportunity of more creative broadcasting. It might be said that automation will sound the final death knell of live broadcasting — but how much truly live broadcasting exists now?

We have heard reports of opposition from some technical personnel; some individual installations will thus be delayed. But if radio is to survive as a medium, it must be prepared to grow with the times. It will do well for engineering staffs to prepare themselves with the additional technology necessary to master these systems. L.Z.

Architectural Acoustics

Part Two: Sound System Design, Noise Control, and Sound Isolation

David L. Klepper

In this second and concluding part, the author covers sound system, design, noise control, and sound isolation. Part One covered Room Acoustics (see March, 1968).

DESIGN OF A SOUND AMPLIFICATION SYSTEM is an integral part of the over-all acoustical design of a theater, concert hall, auditorium, or a studio (if a reinforcement system is included in a studio).

The three basic considerations in designing systems are:

1. Providing a proper acoustical match to the room acoustics,
2. Insuring correct signal flow, or a proper match to the functional needs of the owner, and
3. Satisfactory appearance.¹¹

Basic Purposes

The primary goal of the amplification system in a typical theater, auditorium, or concert hall should be high speech intelligibility. Intelligibility depends upon the orientation and location of the loudspeakers with respect to the live sound sources, together with the shaping and acoustical characteristics of the interior room finishes, as discussed in Part I, and the directional characteristics of the loudspeakers, the operating sound levels, and the background noise within the space, as discussed in this article.

The second goal of any sound system should be naturalness for all reinforced or amplified program material. For music reproduction or reinforcement the system must clearly have a flat response, wide range, low noise and distortion, in other words, *high fidelity*. For speech, sound should appear to come from the person speaking, and the sound system's operation should go unnoticed; the amplified sound should be a clearer and more intelligible version of the speaker's natural voice.^{9,11}

Use of Central Systems

By positioning a central loudspeaker system so that the amplified sound arrived slightly after the live sound (10 to 20 milliseconds is best), and by insuring that the amount of amplification is not excessive, it is possible to "fool" even highly experienced listeners into believing the amplified sound is coming from the live sound source.^{4,9} The time of arrival

and loudness of *both* the amplified and live sound for any particular room design must be studied carefully to achieve this effect.

Our ears are at the sides of our heads; our ability to localize a sound source is more efficient in a horizontal plane than in a vertical plane. Therefore, a loudspeaker location directly above the live sound source can produce sound energy appearing to come from the live sound source, even when the sound level from the system is considerably higher than its natural source or arrives first.⁴

The ratio of live sound to amplified sound can vary somewhat throughout an auditorium, but it is important that live and amplified sound both arrive at the listener's ear at approximately the same time (within 30 milliseconds) if their contributions to speech intelligibility are to be additive rather than cancelling. The central over-the-proscenium loudspeaker location can maintain approximately the same path length between amplified and live sound throughout a typical auditorium or concert hall.

Directional Characteristics

Since loudspeaker and microphone must be close to one another in a central sound system design, their *directional* characteristics are important. Loudspeaker equipment should be chosen to provide the most even coverage possible over the entire audience seating area, while minimizing the sound energy directed at the microphone position and at any wall or ceiling surface that may reflect energy back to the stage. Directional microphones should be chosen to minimize pickup in the direction of the loudspeaker and, in many cases, minimize pick-up of room reverberation.

It is important that the coverage pattern of the loudspeakers (or loudspeaker cluster) be based on a realistic appraisal of the loudspeaker's characteristics. This coverage pattern should assure that all listeners receive the signal with smooth frequency response at a sufficient level to assure an increase in speech intelligibility.¹⁰

Even though one directional loudspeaker could be chosen to provide coverage for an entire seating area, it may be advisable to divide the seating area into two or three sections and assign two or three loudspeakers in a cluster, (rather than one) to provide a uniform level throughout. The input

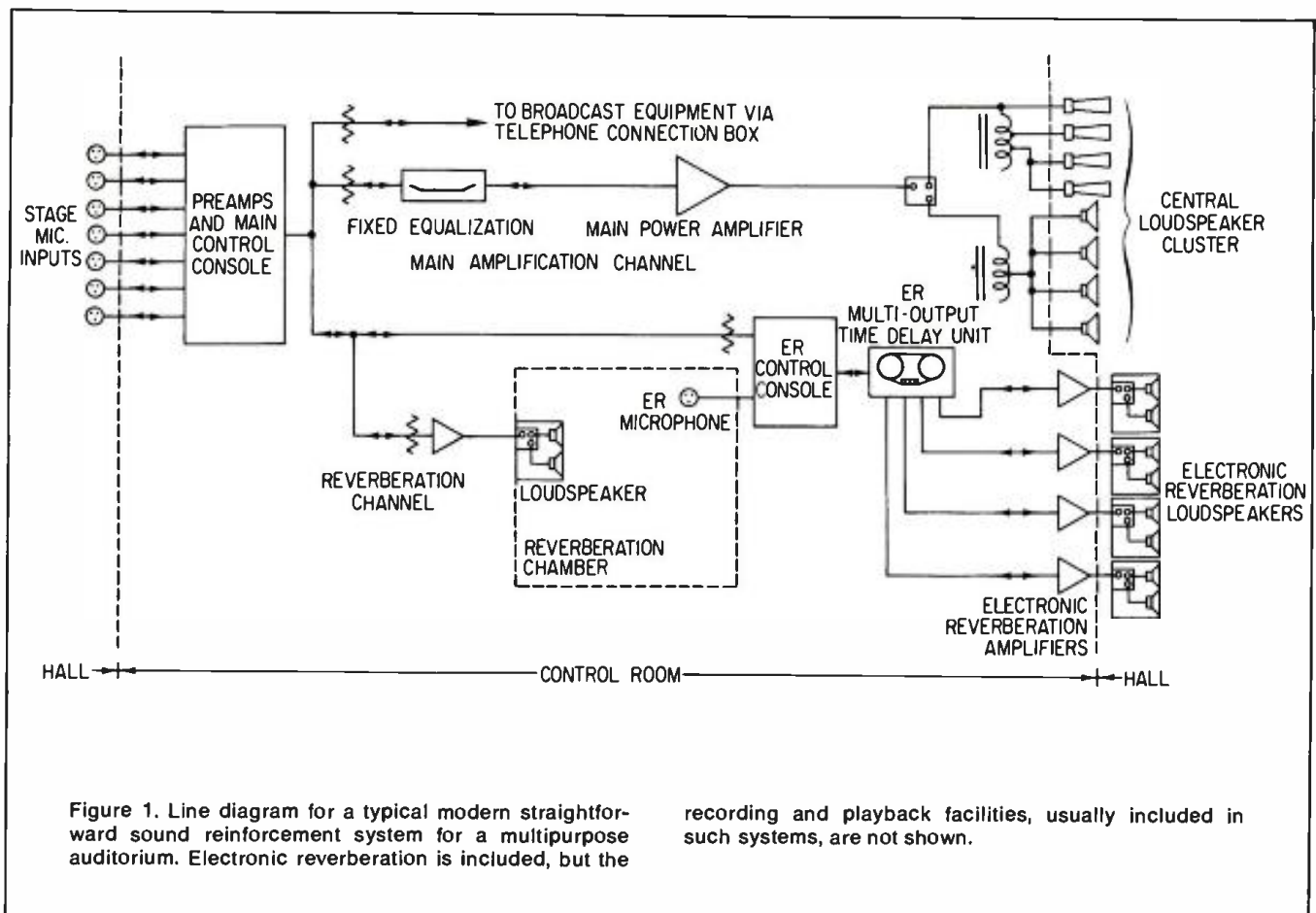

signal to the loudspeaker directed to cover the forward seating area may be reduced in level, thus maintaining a more uniform level than possible solely with one loudspeaker.^{9,10}

Reducing Reverberation

For spaces with a relatively high reverberation time, including concert halls and those churches where music is an important part of the service, central loudspeaker systems employing loudspeakers with the proper directional characteristics can actually minimize room reverberation by concentrating sound on the sound-absorbing audience. Therefore, such systems can produce high intelligibility by minimizing the masking effects of reverberation on the transient speech sounds and allow satisfactory intelligibility in reverberant environments ideal for music. Large radiating surfaces are required for directional control, and these are most often in the form of line-source or *column* loudspeakers or arrays of direction horns (usually multicellular or radial horns).¹⁰

Increasing Reverberation

Sound amplification systems designed to increase the reverberation time of an auditorium or concert hall are a separate category — electronic reverberation systems. Generally, such systems and their equipment are separate and in addition to the basic “house” sound systems discussed earlier. ER systems frequently employ many loudspeakers to provide maximum diffusion and minimum ability to localize the source of amplified reverberant sound. The most frequently encountered ER systems use conventional close microphoning and then use magnetic tape delay devices to insure that the sound from any ER loudspeaker reaches the listener after

live sound from the stage or after the direct (main system) amplified sound from the stage. Multiple successive delays are usually employed, with the loudspeakers farthest from the stage receiving the longest delayed systems.⁵ In some ER systems the time delay tape mechanism is also used as the reverberation generator, with delayed signals from the playback head(s) mixed into the record head via a scrambler circuit signal. One such system, designed and installed by the Aeolian-Skinner Organ Company, has had over ten years of experience in use for increasing the liveness of “dry” churches.

Other systems use supplementary reverberation devices or, better yet, a separate echo chamber or reverberation room where a loudspeaker plays back the sound picked up near the source. A microphone in the reverberant rooms picks up the multiple reflected sound. A mix of the direct sound and the reverberant signal then feeds the record channel of the time-delay system. One such system, together with a fully-developed stereophonic “central” stage reinforcement may be observed in the Purdue University Hall of Music, Lafayette, Indiana.⁷

There are other types of ER systems, such as that installed in London’s Royal Festival Hall; these pick-up reverberant or delayed sound at various points within the hall and distribute it via many separate simple amplification channels (perhaps with electrical or acoustical filtering); and it will be interesting to learn which type will find most frequent application in the future for improving the liveness of existing relatively dry halls and smaller than optimum new halls.^{3,11}

Noise Control and Sound Isolation

Intruding sounds that require control may be divided into

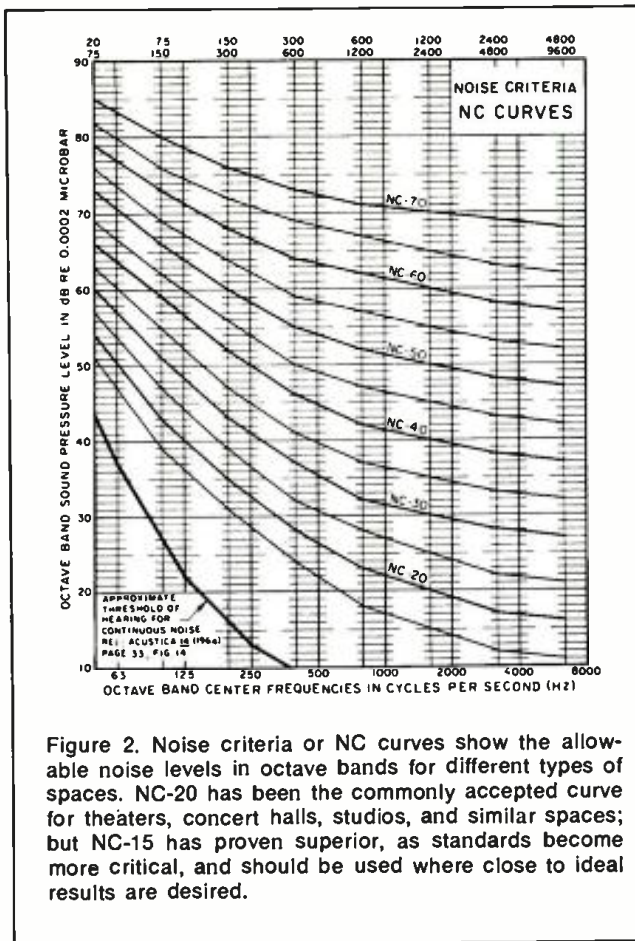

Figure 2. Noise criteria or NC curves show the allowable noise levels in octave bands for different types of spaces. NC-20 has been the commonly accepted curve for theaters, concert halls, studios, and similar spaces; but NC-15 has proven superior, as standards become more critical, and should be used where close to ideal results are desired.

two categories: (a) continuous and relatively innocuous sounds, usually produced by the ventilating system, and (b) intruding discontinuous sounds having programmatic content, such as sounds from adjacent auditoriums or studios. One of the most important concepts of modern noise control engineering is use of the first type of noise to mask the second type.⁶

Naturally, even the steady-state or innocuous ventilating system noises must be held below certain levels or they will be annoying in themselves. Criteria for the allowable background of *all* types of noise have been established for the spaces we are discussing. FIGURE 2 shows a family of noise criteria curves (NC curves) showing the allowable noise levels in octave bands as a function of the octave-band center frequency.^{2,3} For critical broadcast and recording studios NC-15 appears the appropriate criteria curve today; although both NC-15 or NC-20 have been considered applicable for the concert halls and theaters.

Mechanical Equipment

Having established the criteria for noise control of air-handling equipment, the responsibility for meeting it rests on the mechanical engineer (with the help of the acoustical consultant) and the contractor installing the equipment specified. All parts of the air-handling system and mechanical equipment design should be studied from the standpoint of noise control.

The noise of air supply and return fans must be estimated properly; then noise control must be incorporated into supply and return ducts by use of lining (lined bends are particularly effective) and/or by use of packaged sound attenuating mufflers.^{5,7} For spaces requiring a background

noise as low as NC-15, it is good practice to locate the supply and return fans very remotely from the hall or studio, and then lining or mufflers may not be required. The sound attenuation or unlined ductwork, lined ductwork, and mufflers or various configurations is predictable, allowing the engineer to design the required amount of sound attenuation into the air-supply and return system.¹

Similarly, air supply and return grilles or diffusers should be chosen to meet the requirements imposed by the criteria. Larger grilles, with lower "face velocities" (feet of air-movement per minute or fpm) mean less hiss for a given amount of air moved.⁸

Care must be taken that air velocities in ductwork within or near the hall or studio are not so high as to create turbulence noise* without appropriate sound-attenuating duct construction and lining or mufflers to control sound transmitted to the diffusers or grilles.⁸

Generally, the further all mechanical equipment is from the critical hall or studio, the easier will be the noise control job of the mechanical and acoustical engineers. It is wise to locate mechanical equipment in a basement area under the lobby of a hall, rather than under the hall itself. The practice of mounting fans in attic space directly over hall or studio ceilings should be avoided if at all possible. The equipment will produce a "problem" sound level in the area it is mounted; if this area is directly adjacent to — or above or below — the hall or studio, then special sound-isolating construction may be required.

Equipment mounted near critical spaces also requires careful attention to mounting arrangements; otherwise the equipment can easily introduce vibrations into the building structure, and these vibrations can be radiated as noise inside the studio or hall. Springs, sometimes in combination with concrete inertia blocks, are required for isolation of low-frequency vibrations; ribbed rubber, neoprene, or cork pads are often useful for high-frequency vibration isolation. On occasion, concrete vibration-isolation bases may be supported off the floor on springs — or the entire floor of a mechanical equipment room, located above a studio or hall, many consist of a triple-sandwich of concrete-springs-and-concrete.

Sound Isolation

There are many potential sources of intruding sounds that should be considered in the design of a studio or hall, in addition to those from mechanical equipment. Potential sources from inside a building include performances located in adjacent studios or halls, footfall noise, casual conversation in corridors, lobbies and other circulation areas, and even in control rooms and viewing rooms. Offices can contain problems including office machinery ranging from typewriters to computers. External noise sources include aircraft flyovers, street and highway traffic, railway lines, and subways.⁹

Any acoustical engineer will urge that as many of these problems as possible be solved in the basic planning of a new hall or studio facility; but inevitably studios and halls will be planned adjacent to each other within the same facility — or a hall or studio facility will be located in the main flight path of an airport. The acoustical engineer, working with the architect, can still accomplish much in planning the facility even after the basic decisions are made. Adjacent studios or halls can be separated by circulation

*Mixing boxes and dampers are potential producers of turbulence noise, which then requires control by lining or mufflers.

spaces, control rooms, storage rooms, etc; and a concert hall within the main flight path of an airport can be built into, rather than above the earth, with circulation spaces, lobbies, ticket offices, etc., located between the hall and the building roof. The basic technique is to surround and separate the most critical areas (from the standpoint of acoustics) with less critical ones.

Eventually, the basic wall, ceiling, and floor construction for the critical area must be chosen. The sound-pressure level on the *sending* or *source* side of the boundary must be estimated as a function of frequency; the criterion for noise levels in the critical space subtracted, and the difference is the required "noise reduction" for particular boundary surface.

The ability of the particular wall, floor, or ceiling construction (or any other partition) to isolate (stop) sound energy is expressed by the *transmission loss* of that construction. The transmission loss (TL) of a construction is a ratio, expressed in decibels ($10 \log_{10}$) of the acoustic energy incident on the wall to the acoustic energy transmitted through it, and it applies to a unit area. (In the U.S., this is usually one square foot.) Transmission loss curves (as a function of frequency) may be calculated for various types of construction (based on mass, stiffness, distance between elements in sandwich construction, etc.), measured in a laboratory, or calculated from field measurements of noise reduction (NR).

Unlike transmission loss, noise reduction includes the effects of the area of the boundary surface and the room acoustics of the receiving room, so the expression relating the two concepts is:

$$NR = TL - 10 \log_{10} \left(\frac{1}{4} + \frac{S_w}{R_2} \right) \text{ dB}$$

where

NR = noise reduction (reverberant levels on source side of partition minus receiving room levels measured near the partition)

TL = transmission loss of partition construction ($10 \log_{10}$ ratio of incident energy to transmitted energy.)

S_w = Area of partition

R_2 = Room Factor of receiving room

($R = S_2 \alpha_2 / C1 - \alpha_2$) where S_2 is the total interior surface area of the receiving room, α_2 is the average absorption coefficient, and $S_2 \alpha_2$ is the total absorption in the receiving room.

The quantities S_2 and α_2 will be known or calculated from the room-acoustics design of the receiving room (the hall or studio).

Generally, the more massive a partition construction is, the higher its transmission loss. Really high-TL partitions employ multi-layer construction. For example, a typical wall recommended to separate two music practice and teaching rooms — and matched to a ventilating system noise level of NC-35 — would consist of 8-in. solid masonry or concrete, with a separate 3/4-in. plaster wall on each side. Only resilient connections would be employed between the plaster walls and the masonry or concrete core, and glass-fiber may be installed in the two air-spaces of this triple-layer construction.

A somewhat heavier construction technique would be employed to isolate halls or studios requiring a lower background noise level (NC-15 or NC-20). Where one hall is located above another, a vertical slice through the common floor-ceiling construction might show a 3-in. concrete floor slab floated on 2-in. glass fiber, a 12-in. structural concrete slab below and then a resiliently suspended 1-in. plaster

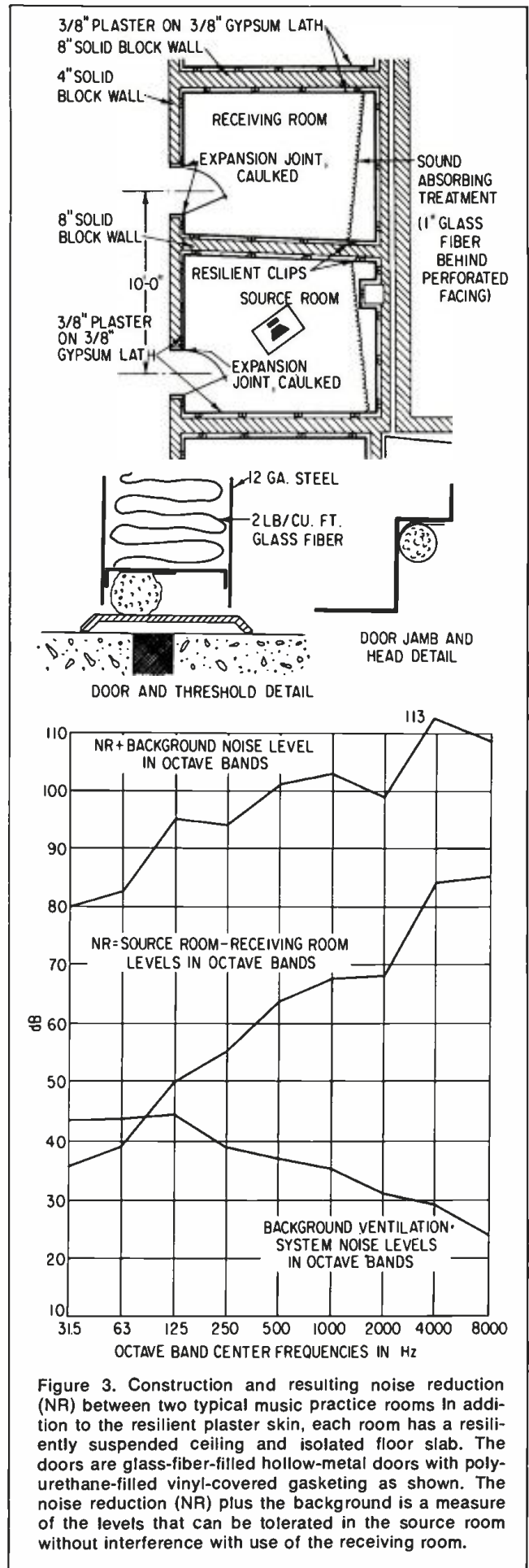

Figure 3. Construction and resulting noise reduction (NR) between two typical music practice rooms. In addition to the resilient plaster skin, each room has a resiliently suspended ceiling and isolated floor slab. The doors are glass-fiber-filled hollow-metal doors with polyurethane-filled vinyl-covered gasketing as shown. The noise reduction (NR) plus the background is a measure of the levels that can be tolerated in the source room without interference with use of the receiving room.

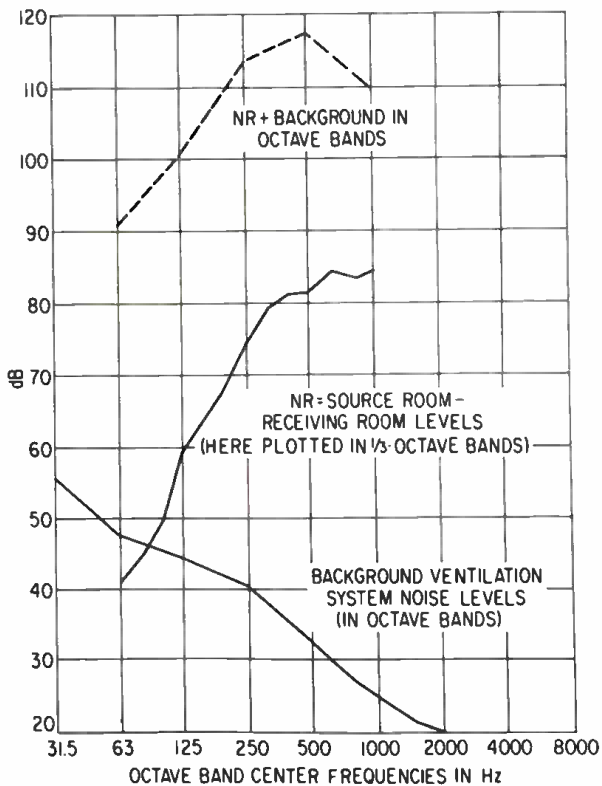
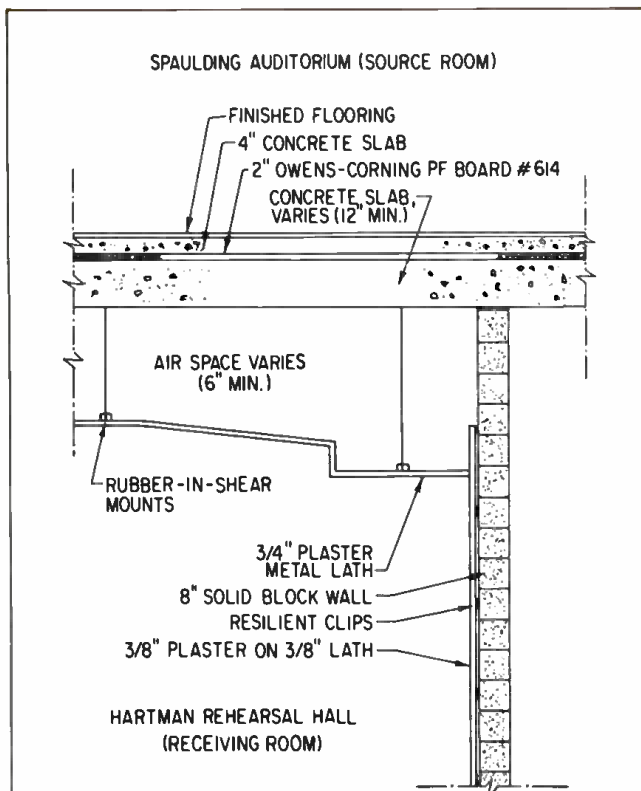

Figure 4. Construction and resulting noise reduction (NR) between a multipurpose auditorium (concert hall—lecture hall) and broadcast studio—rehearsal room below. Values of NR above 1000 Hz are not shown because the test signal source (horn loudspeaker) was not high enough in level to be measured above the ambient in the receiving room, but are known to be above 83 dB. Again, the NR plus background indicates the tolerable levels in the source room.

ceiling below the structural slab. FIGURES 3 and 4 show the noise reduction possible with the construction techniques mentioned.

Doors and windows in high TL-walls must be matched to the construction they interrupt. Details for windows separating control rooms from studios or halls have been refined for many years, and such windows now generally include the following characteristics:

1. Double construction, using two panes of different thicknesses, with one pane sometimes sloped.
2. Resilient airtight mounting for the glass.
3. Sound-absorbing material applied to the frame in the space between the two panes.

High TL doors may now be purchased complete with frames and gasketing (weatherstripping), and careful installation will allow matching the sound isolation of the surrounding constructions.

Details — and airtightness — are very important in all sound isolating construction; light fixtures, grilles, electric outlets, and conduit must all be handled specially to avoid compromise to the basic construction. In this respect, achieving high noise reduction is no different than other areas of acoustical design: details make the difference.

References

- 1 American Society of Heating and Refrigerating Engineers Guide 1964—1967 Editions, Chapter 25, "Sound Control."
- 2 L. L. Beranek: *Acoustics*, McGraw-Hill, New York, 1954. (Particularly Chapters 4 and 11.)
- 3 L. L. Beranek (edited): *Noise Reduction*, McGraw-Hill, New York, 1960. (Particularly Chapters 20 and 21.)
- 4 L. L. Beranek: "Sound Systems for Large Auditoriums," *Journal of the Acoustical Society of America*, Vol. 26, 1954, p. 661.
- 5 L. L. Beranek: "Sound Systems for Orchestra and Grand Opera," *Journal of the Audio Engineering Society*, April 1966, Vol. 14, p. 107.
- 6 W. J. Cavanaugh, W. R. Farrell, P. W. Hirtle, and B. G. Watters: "Speech Privacy in Buildings," *Journal of the Acoustical Society of America*, Vol. 34, 1962, p. 475.
- 7 C. M. Harris (edited): *Handbook of Noise Control*, McGraw-Hill, New York, 1957 (Particularly Chapters 25 and 27.)
- 8 R. M. Hoover: "How to Control Noise in Distribution Systems," *Heating and Air Conditioning Contractor*, March 1964, p. 50.
- 9 D. L. Klepper: "Designing Sound Amplification Systems for Buildings," *Architecture and Engineering News*, March 1964, p. 26.
- 10 D. L. Klepper: "Loudspeaker Directional Characteristics," *Audio*, September 1965, p. 23, and April 1967, p. 22.
- 11 D. L. Klepper: "A Rational Approach to Sound System Planning," *IEEE Transactions on Audio*, Vol. AU-13, No. 4, July-August 1965, p. 96.
- 12 H. E. Olson: *Acoustical Engineering*, D. Van Nostrand, Princeton, 1957. (Particularly Chapters 2, 11.)
- 13 H. E. Olson: "Passive and Active Acoustics in Architectural Enclosures," *Journal of the Audio Engineering Society*, October 1965, Vol. 13, p. 307.
- 14 P. Parkin: "A Special Report on the Experimental 'Assisted Resonance' System in the Royal Festival Hall," *Journal of Sound and Vibration*, 1964, Vol. 1, p. 335.
- 15 J. B. C. Purcell: "Keeping Out Street Noise," *Architectural and Engineering News*, March 1964, Vol. 12, p. 22.

Why Do We Hear What We Hear?

An appreciation of the psychoacoustical character of hearing can increase the understanding a sound engineer brings to his job. Following is a partial transcript of a panel discussion held before the New York Group of the AES this past winter.

The panelists were: Dr. H. Newby, City University of New York. Prof. James Lang, professor of speech and hearing science at Brooklyn College; Jurgen Tonndorf, M.D. Professor of Otolaryngology, College of Physicians and Surgeons, Columbia University; The moderator was Dr. Leo L. Beranek, president, Bolt, Beranek and Newman.

Because of space limitations we have not reproduced the talks of Dr. Newby and Dr. Tonndorf, who spoke on the medical-physiological aspects of hearing. Thus our transcript begins with Dr. Lang's talk and concludes with a condensation of the question and answer period.

DR. LANG: As I looked through my reasonably good library on the topic of hearing, it was only in a fragmentary way that I was able to find some material on a topic about hearing which has interested me for many years and which I have never before attempted to pull together in one very brief discussion. These are aspects of hearing about which we are all very familiar, but for which a great deal of research has not been done. These are the aspects of hearing which are somehow not suggested to us when we consider the ear from the anatomical viewpoint or from the physicist's or engineer's view-



Figure 1. Left to right—Dr. Newby, Dr. Tonndorf, Arthur Gruber, New York Section, AES chairman (standing), Dr. Leo Beranek, Professor James Lang.

point. These are the aspects of hearing which are, in part, a function of learning and experience—and so on. But even that is too restrictive a suggestion. So, may I bring your attention to some aspects of hearing with which you are all familiar, but for which I can not find any name.

For example, let us consider the fact that the ear really, unlike a microphone, is not a constant parameter device. It is a device which changes as a function of experience, which can be *deliberately* changed as a function of training.

May I give you some examples. I think all of you who are in the recording industry are aware, sometimes to your distress and chagrin, that the hearing mechanism of John Doe is one which has become accustomed to distorted sounds: I am referring to the chap who definitely prefers the kind of booming jukebox bass sound. If you expect to sell records to him you have to put bass boost into the recording; otherwise he won't buy it. On the other hand, if you put bass boost into your recordings, then all the hi-fi enthusiasts swear at you. This individual's hearing mechanism, the chap who likes the jukebox sound, does not have something the matter with his ear, it is simply that this is the kind of thing he has become accustomed to listening to. Experience has given his particular hearing mechanism a set of parameters different from those of the individual who is a hi-fi enthusiast.

Let us consider another example, which I think all of us somehow or another know but have not perhaps thought about in a structured way. This is the fact that you have been born and raised with a particular language, the English language, which has conditioned your hearing a particular way.

But consider the individual whose native language is Pakistani. It seems difficult for us to realize that someone whose native language is Pakistani would not be able to differentiate the two words *park* and *bark*. To him these two words sound the same. He would not be able to differentiate the words *gross* and *grows*, nor would he be able to differentiate between *sweet* and *Swede* nor *fine* and *vine*, nor *pluck* and *plug*. The Japanese would not be able to differentiate the words *rake* and *lake*. To them these words are identical. To us they are quite different words. Now, are we then to conclude that these folks have defective hearing? Not at all, it is simply a question of their experiential background.

And really, we could think of the thing the other way around, because when we take the two words *peel* and *pool*, the initial *P* sound of those two words, to us, are identical. But to the individual whose native language is Pakistani those two sounds are to him very different in his language. If we were to attempt to speak Pakistani we would have to learn to hear the difference between the *P* in *peel* and the *P* in *pool*.

By spectrographic analysis we can show that indeed those two sounds are acoustically different but we hear them as the same. We could expand further examples of this, but I think perhaps it is not necessary.

Let us ask ourselves for a moment what kinds of changes can be brought about to an individual's hearing as a function of training and practice. There are two things that can be done. The individual's *sensitivity* can be improved. (There is a little bit of controversy in the literature about this, but I think the preponderance of experimental evidence is that you *can* improve an individual's sensitivity at least a bit, as a function of training.) I use *sensitivity* in the same sense that you talk about the sensitivity of a microphone. There is one thing that you can clearly do as a function of training

and that is to improve the individual's discrimination ability.

A second thing that can be done (especially if you are interested in research as opposed to practical application) is to reduce the variability of responses which an individual gives to the stimuli you are presenting to him as a function of training.

One of the problems that we, in the field of speech and hearing encounter, is dealing with the individual who is assigned the duty of helping another person to correct certain speech defects or a foreign accent. We get someone who came to this country whose native language is not English, and who speaks with a very heavy foreign accent. So we assign this individual to a speech therapist to train him to speak English somewhat more intelligibly. After several weeks of work, the therapist swears up one side and down the other that the individual is improving. Actually, however, if a tape recording was made of his voice at the beginning and at the presumed end of therapy, it would show that the individual had not improved very much at all. What actually has happened is that the therapist has learned to discriminate the speech sounds that his student is producing. So the therapist is *convinced* that the client is improving when actually it is the therapist that is improving.

I remember also that some years ago I became interested in infinitely peak-clipped speech. Now back in the late 1940's and early 1950's, it was demonstrated quite conclusively that infinitely peak-clipped speech is remarkably intelligible. It doesn't sound very much like speech at all, it's more like static in an electric transmission. We were playing around in a laboratory with some infinite speech clippers and getting strangers to come in and listen to our infinitely peak-clipped speech. To us the infinitely peak-clipped speech sounded really remarkably intelligible, but strangers didn't even recognize it as speech, let alone understand what was being said. When we pointed out to them that it was in fact speech, though highly distorted, and that if they would just kind of listen and pay attention a bit that they would be able to understand it, lo and behold, with very little practice they were able to understand the speech quite well. Now in part, this was a function of practice and in part it was a function of expectation.

This brings me to my next topic. I've been discussing the effects of experience and training on hearing; now I would like to move to a little different topic, the topic of expectation.

Rather largely we really do hear what we expect to hear. To say it another way, the *a priori* probability of the acoustic events to which you are going to be listening has a rather remarkable effect on an individual's hearing. An associate of Dr. Beranek's has recently been working with a very interesting mathematical theory, a kind of mathematical model of the human hearing mechanism, referred to as the *theory of signal detectability*. One of the things that has been shown is this. If you present a stimulus to the subject in 50 per cent of the trials and fail to present stimulus in the remaining 50 per cent of the trials, you will get one measure of the individual's sensitivity. And if you change nothing, absolutely nothing about the experimental procedure except the percentage of time that the stimulus is presented, and now present the stimulus only 10 per cent of the time, or 90 per cent of the time, the individual's sensitivity will shift as the function of the probability of the stimulus. Now, somehow or other, this seems very strange to us; we wouldn't predict this. Certainly a microphone wouldn't behave this way. So I hope you're beginning to see the kind of topic I'm attempting to talk about—the kinds of aspects of hearing that usually are

not suggested to us when we think about hearing in a fairly mechanistic way.

Let us take the question of discrimination and its relationship to hearing what you expect to hear. I've only lived in this area a relatively short time and I ride the Flatbush car out to Brooklyn College. They announce as the train is moving—with a good bit of signal to noise—the stations over the p. a. system on the train and when I first started I could not understand one thing that was being said. But you know, the funny thing was that after I had been riding the Flatbush line for a while, I got so I could understand every announcement that was made. I got so I could predict what stop was coming and I knew ahead of time what the stop was, so that what was coming over the p. a. system sounded perfectly intelligible to me which is just another way of saying that the individual who least needs to know what the next stop is, is the only one who can understand what is coming over the p. a. system.

There is another problem, a very personal one. Just recently I visited my physician to get a shot in the arm (I take a series of these shots each year and this was the first one this year) and the nurse said to me (I discovered later) "Would you like us to bill you once a month." I didn't think that was what she had said and I responded. "Oh no, I have to come twice a week for these." I was *expecting* her to say something about the frequency with which I would make my visits to the doctor and instead she was saying something about the frequency of the billing. And so my response was related to my expectancy of what she said, not to the acoustic signal itself.

Well, so much for the topic of expectancy.

Let us consider the matter of auditory memory. We utilize an auditory memory, especially a long-term auditory memory, in a way which has the effect of reducing the information content of whatever acoustic ensemble is presented to us. Let us consider the vowel sound—aaaah—Obviously that is a complex sound. Now the ear really is not quite able to analyse, even if the ear were highly trained, that particular complex signal into its basic components.

However, it has been shown that an individual with training can learn to identify the center frequency of the three or four formants, the resonant peaks, of the various vowels. This can be done only after considerable training because when we listen to the sound—aaaah—we have learned to identify it as an acoustic pattern, as an ensemble. It is only through considerable un-learning that we could begin to utilize the analytic abilities that our auditory system has. Only with un-learning could we analyse that vowel sound into the several formants of which it is composed.

Our memory, however, has not found that to be a useful way of dealing with the particular acoustic phenomena which we call—aaaah—so by memorizing the vowel as an ensemble, we reduce the information content of the message by grouping it. On the matter of short-term acoustic memory as opposed to long term, if you attempt to learn a new language, and you have to produce a new speech sound which is not part of your native language, you must repeat this word immediately after you have heard it. Apparently it takes quite a while for an acoustic memory to become reasonably well established. If you don't repeat this sound immediately, somehow or other that memory trace is not sufficiently with you as yet.

Well, let me summarize what I have attempted to inform you about. The hearing mechanism, unlike a microphone, is not a constant parameter device, its variables are very

much a function of experience and it can be modified in ways important to you, by training. Then there is the matter of expectancy. We hear what we expect to hear. Finally I have mentioned ever so briefly some of the peculiarities of auditory memory. This is the fact that we seem to remember things by reducing the information content of the signal so that it can be perhaps more economically stored.

Dr. Beranek: Thank you Dr. Lang.

I would like to comment on one other kind of hearing experience. I attended some hearings recently conducted by Senator Ted Kennedy. This hearing was held in the Post Office Building in Boston and was attended by all the brass of aviation on one side of the room and on the other side all the irate citizens from around Logan Airport that could get into the room. Several things of interest come out in this kind of situation; where people are listening to signals that do not bear useful information, but rather are annoying.

These were people with presumably relatively normal hearing. If you take a thousand of them and question them about their reaction to noise, you will find about 25 per cent of the people in a city will say that noise doesn't bother them—they can sleep near the runways of an airport, or next to an elevator train that is going along, or next to a highway.

There is another roughly 15 per cent of the people (these are of course very rough numbers) who cannot stand noise that is generated by someone else, and it doesn't really matter very much how loud that noise is just as long as it doesn't convey any useful information to them.

This of course complicates the job of someone like Senator Kennedy who is trying to come up with useful legislation, because if 25 per cent of the people don't care what noise environment they are in and 15 per cent cannot be satisfied anyhow—then who are you quieting for.

This is one of the auditory problems which is facing us today because the word's noise pollution problems are becoming more and more common, and the legislators are trying to figure out what kind of laws might be useful and sensible and will protect people's comfort. Now if we were to look to Dr. Tonndorf's charts of what happens in the brain we would see that the signals are carried up to a rather high level so this whole sense of annoyance is somehow integrated in the higher levels in the brain. It's not something that happens peripherally in the ear. The facts are that sounds or noises that are rich in frequency content at the same points that hearing is most sensitive, are the areas in which you get the most annoyance. As a result, on the standard sound-level meter if you use what is called the A scale—which discriminates against the low frequencies and also discriminates against the high frequencies—readings correlated highly with peoples' annoyance with sounds that do not carry any useful information. This is another aspect of the whole hearing problem that we have before us. Now as moderator I would like to ask the panel members if they would like to comment.

Dr. Tonndorf: I would like to emphasize something both of you have said. Take the situation in which a man tells you that he can sleep with trains running by; you very frequently find that when there is a train failure and the trains stop running, he awakens. So this is a negative reinforcement. And the second point I would like to make is in the line of a little joke. I am of German origin and came to this country in 1947. When I first came, of course, I couldn't speak much English. I had a fairly strong accent. I was the only one in my department, so the people there were lucky, they had only one to face. In the eye department there were three

Germans and the Colonel who ran this department was asked by a friend how his German was coming along with these three Germans in his department. Said he, "I am not learning how to speak German, I am learning to speak English with a German accent."

Questions from the audience:

Q: It is reputed that persons of middle age can only hear to 10,000 cycles, yet two years ago I was working with an extended range tweeter up to 26,000 cycles. We all heard it, painfully, and we distinguished between that and 20,000 and 15,000.

Dr. Newby: We are learning more all the time about presbycusis. This is the term given to the effect of aging on the hearing. Curves on the average hearing levels and populations will show an increasing hearing loss to the higher frequencies as you increase each decade of life. This effect statistically can be shown to exist as early as the third decade of life, although I am sure a thirty-year old doesn't consider that he is aging any.

But recently, with some information that has been acquired from civilizations far removed from modern-day noise, certain tribes over in Africa, it has been shown that there is very little effect of aging *per se* on the hearing since men of sixty and seventy years of age have as acute hearing as people in their twenties in this country; so that now we are beginning to wonder if that which we have called the curves of presbycusis are not actually what might more properly be called socio-cusis. These are the effects on the hearing of all of the insults that we incur, as a result of illness, infection, climate, noise, etc.

Q: Could I have the panel address itself to the *young* sound or the *hard rock* sound which is with us today? I happen to work for a recording studio. We had a group of five musicians in the studio the other day that were so loud that I thought I'd bring out a sound survey meter. I cranked it up to the 110 scale and found that we were reading transient peaks of 118 dB or better. This is not the same loudness that's incurred in some of the discotheques and certainly not the levels incurred by the players themselves who are located some inches away from the instruments.

Dr. Lang: I must confess that I don't know too much about this topic except to say that I read a brief statement somewhere just the other day that sound levels in a discotheque had been recorded with some peaks somewhere around 124 dB. I think Dr. Beranek is the expert here on damaged-risk criteria and unless I am very much mistaken there is the distinct possibility of damage to the hearing mechanism at these levels.

Dr. Beranek: And that is what is happening. I know some young neighborhood boys whose hearing I tested and they are not doing so well. I think we will have a high incidence of deafness among these young 'boomphiles'.

Dr. Newby: We had an example in our clinic of a student who makes a living outside of class by playing in one of these bands who was afraid he was losing some hearing. So he came in for some tests and in truth he was down, he was down even in the speech range. We encouraged him to think of some other way of earning his way through college.

Q: In a recording studio I have measured sound-pressure levels of 110 dB. The explanation that is given is that sound engineers can hear the nuances and innuendos better when it is so loud. What is the response of the ear and its linearity to such greatly increased levels.

Dr. Tonndorf: The ear distorts. The funny thing is you

are not aware of it.

Q: Is there anything gained by it?

Dr. Tonndorf: Actually no. Any of you who have flown as navigators or people who have used ground-to-air intercom in aircraft will probably bear me out on this, when I say a novice will set his headset much too high and after about two or three weeks he will come down in level because he has learned the language. I remember, many years ago when I was working at Randolph Field, we were trying to do a salvage job for the Air Force. They began to realize that as the pilots got older they should not be thrown away, that these people had valuable experience. True they couldn't see so well anymore, some of them started wearing glasses and some of them couldn't hear so well. I remember one fighter pilot quite well. He was deaf as a doorpost. We took him up in the air and the only test we could do quickly was to go up and start ground-to-air communication and see how he made out. Well, I can tell you, he did a lot better than I did, because he knew what he was *expecting*.

Speech, and especially a limited vocabulary, is so highly redundant, as Dr. Lang pointed out, that the man who knows what he is expecting, (there are a limited number of choices in a given situation, say an approach to a landing-strip) gets them. I didn't get them, I didn't get a single word. I didn't know what the choices were.

Dr. Lang: May I comment on this also. When the audiologist draws a configuration of the sensitivity of human hearing, the frequency-response curve appears to be a straight line. But this is a distortion of the way the ear really works. It is a distortion which is deliberately done for clinical purposes by the instrument called an audiometer. What I would like to point out to you, however, is that the sensitivity curve, and the frequency-response curve of the human hearing is not a straight line but a kind of a U shaped curve. I think probably most everyone here is familiar with the Fletcher-Munson curve. The lowest line, the zero phon line, on this graph is the frequency-response curve and sensitivity of the ear. Now let us consider playing a message—be it music or speech at a relatively low sound-pressure level. Now some of the low-frequency and some of the high-frequency sounds as you come down in sound pressure level are going to fall below the threshold of the individual simply because his sensitivity curve is non-linear. As you increase the sound-pressure level of the signal he will begin hearing more and more and more of the low- and high-frequency sound since they are now rising above his threshold. So it seems reasonable to me that the man who is listening to a monitor in a studio, and is listening for what he calls the nuances, would want to turn it up fairly high. This would bring the low-frequency and high-frequency sounds sufficiently above his threshold so that he would be able to make meaningful discriminations with them. Now, those of you who work with high-fidelity equipment correct for this non-linearity of sensitivity by making loudness controls in hi-fi sets. Then, when you want to play concert music at a dinner-listening level, you add bass and treble boost to the system so that the frequencies you would normally hear in an auditorium where sound levels are up around 80 or 90 dB come back up into the region into which the individual can hear them.

Dr. Tonndorf: I doubt that you need 110 dB for this, 70 or 80 is enough. This level is used in testing; we call it the comfortable-listening level and most people are pretty consistent in selecting this, especially after they have had a little bit of training.

The NAB Convention —A Picture Gallery

WHEN THERE ARE NEARLY 130 manufacturers exhibiting in one hotel, even if that hotel is Chicago's Conrad Hilton, it's a busy time — especially if all there is in time is four days. The NAB Convention was held from March 31 to April 3, hardly long enough for us to see all we wanted to, let alone push our camera everywhere it should have gone.

What follows is a small sampling of the various booths. The pictures are arranged alphabetically and we only wish we had space for more.

It's always hard to spot trends in a show, since a trend often exists only in the eyes of the beholder. To ours, it seemed as if a strong movement was underway toward the automation of radio broadcasting stations. There were many more displays of automation systems and support equipment than our pictures show.

But don't count out the manually operated station. There were over a dozen manufacturers of broadcast control consoles, with many of these manufacturers offering a sizable model selection.

For the rest, the pictures speak for themselves . . .

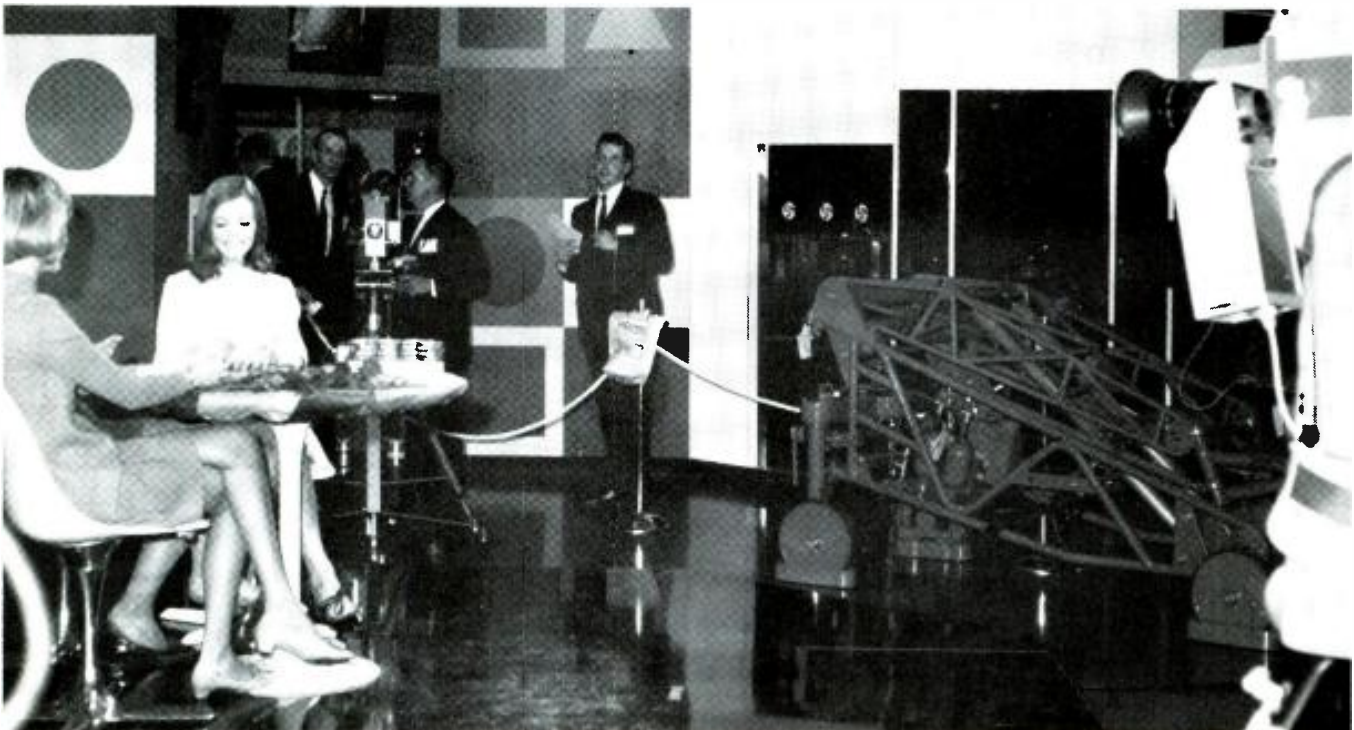

A partial view of Norelco's extensive studio set up at the NAB Convention. This studio served to feed color t.v. and audio to monitors set up around the display. In addition, several other booths took feeds from Norelco for their own displays.



Altec Lansing. We don't have an identification on the lady, but the gentleman with his back to us is **Arthur C. Davis**.



Ampex Corporation. Only a part of their huge separate ball-room was devoted to the audio products you see here.



Audio Devices. They concentrated on their **Audopak** cartridge. That's **Ron Grey**, furthest right, with **Bud Freifeld**, midwest sales mgr. in front of him.



CBS Labs. This was an effective display of their quality audio and video control and improvement systems.



Collins Radio Company. They offer audio control systems, tape cartridge systems, a.m. and f.m. transmitters and monitors, and antennas. In short, they can put you on the air.



Disan Engineering Corp. A wide range of broadcast equipment including both audio and r.f. systems are displayed. That's **Disan president Bill G. Brown** on the left.



Fairchild Recording Equipment Corp. In the center and almost facing us is genl. mgr./chief engineer **George Alexandrovich**. To his right is engineer **Slavko Milovancevik**.

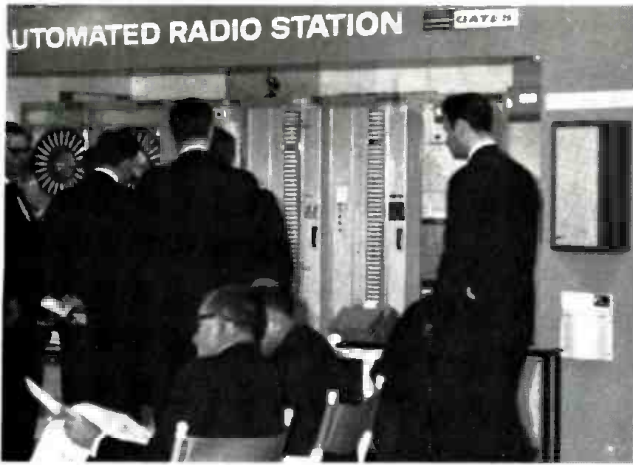

Gates Radio Company. They offer a.m., f.m. transmitting equipment, audio console systems, and automation equipment. This display of an operating Gates automated radio station drew crowds.



Gotham Audio Corp. At right, facing us, is Gotham President **Stephen F. Temmer**. Second from the left in the light suit with his back to the camera is **Hugh S. Allen, Jr.** the firms v.p. Gotham showed **Neumann, Studer, EMT, Lyrec, Beyer,** and others, of their lines.



Gray Research and Development Co. Tone arms, equalizers, preamps, and t.v. projection devices were shown.



Hewlett-Packard. This company mounted a handsome display to show their line of broadcast and audio test-and-monitor equipment.



Ma Car Ta. They make the Carousel tape cartridge system that is used in most automated broadcast systems. They also have reel-to-reel equipment.



McCurdy Radio Industries, Inc. This Canada and Massachusetts based company offers a wide line of audio consoles for broadcast applications as well as intercom and amplification systems.



McMartin Industries, Inc. Both r.f. and audio equipment is offered to the broadcast industry by this company.



Revere-Mincom, 3M Co. Video and audio recorders, film recorders — and with the **Magnetic Products Division,** video and audio recording tape and accessories.



Norelco-AKG and Philips Broadcast Equipment Corp. Microphones from AKG and audio and video broadcast equipment — consoles and cameras included — headsets, etc. from Philips.



RCA. Our view shows a d.j. setup that was manned during the show by radio personality **Dolly Holiday**.

SONY

SOLID-STATE C37-FET CONDENSER MICROPHONE



the World's Finest Professional Microphone NOW PACKS ITS OWN POWER

The new Sony Solid-State C37-FET Condenser Microphone is designed to give you the ultimate in professional capabilities wherever you may need them. A revolutionary Field Effect Transistor (FET) replaces the conventional vacuum tube, eliminating the external power supply and bulky connecting cables. Power is now supplied by a built-in replaceable 9-volt battery, delivering 300 hours of continuous power.

The C37-FET retains all the warm, natural quality, the unbelievable flat frequency response free of resonant peaks and dips—so characteristic of its illustrious predecessor the world-famous C-37. Musicians, conductors, soloists and sound engineers prefer the C37-FET for its wide dynamic range which captures the splendor of choral groups...for its faithful flat reproduction of high, middle and low registers to capture the magnificence and true timbre of strings, woodwinds and piano.

Add to this the outstanding signal-to-noise ratio specifications, unusually high front to back rejection of cardioid pattern, a built-in battery that delivers up to 300 hours of continuous power, and you have a microphone whose performance is unparalleled whether in the studio or on location.



8150 VINELAND AVENUE • SUN VALLEY, CALIFORNIA • 91352

Circle 24 on Reader Service Card

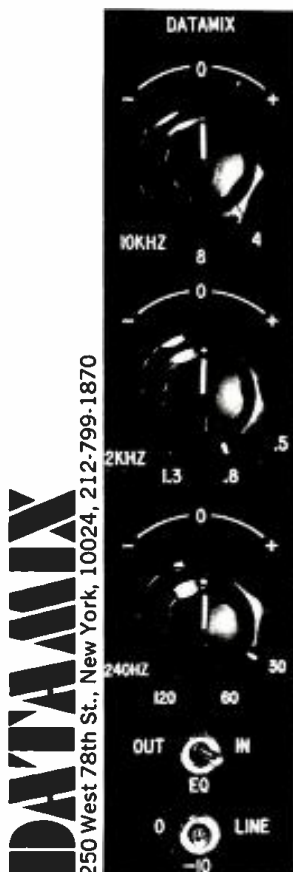

250 West 78th St., New York, 10024, 212-799-1870

It's
unequaled

Custom recording
consoles

Circle 21 on Reader Service Card

Sound with Images

MARTIN DICKSTEIN

Rear Projection

● In the past, the most common method of projecting images on a screen was front projection. It is the simplest process for a novice or non-technical person to set up. Any flat surface, white preferably, can be used as the screen. All that is required of the projectionist is to set up the projector at the proper distance from the surface (depending, in part, on the lens that is furnished with the projector) and start the show. The show can be either motion-picture film or slides and, as long as the room is dark, the picture fairly sharp, the image bright, and there are not many viewers (all of whom must position themselves properly to see the picture) the presentation will probably go over

quite well. (In general, this refers, of course, to home or small club showings.) The procedure becomes quite a problem, however, when the audience is fairly large, but in a small room.

Another technique for presenting both films and slides to medium-sized audiences has been developed more recently. This offers distinct advantages over the more common method. This is the *rear-projection* concept; it has been used successfully in training programs in hospitals, corporations, schools, executive board rooms, industrial shows, fairs, etc.

One of the most important advantages of rear-screen projection is that it is effective in a normally illuminated room. This eliminates the usual disadvantages of a dark-room presentation:

1. Loss of time and flow of conti-

nunity due to the necessity of having to pull shades or drapes and turning off lights.

2. Loss of visual contact between lecturer and audience with the resultant inability to maintain a question-answer type of contact when desired.
3. Loss of the audience's attention and the natural problem of drowsiness induced by extended periods of darkness.

In addition to this, the ability to present a projection demonstration in an illuminated room offers the demonstrator the specific advantage of being able to:

1. Maintain visual contact with the viewers and to interject comments when required by the reaction of the audience.
2. Refer to the screen and to indicate on the image the particular portion desired.
3. Stop the projector at any time during the presentation (by remote controls) to illustrate a point by the use of another visual device or by demonstration before continuing with the presentation.

At the same time, the audience enjoys being able to take notes during the showing — a particular advantage

Brigham Young University announces the Second Annual Recording Seminar Aug. 12-16 1968

MONDAY

AUGUST						
S	M	T	W	T	F	S
				1	2	3
4	5	6	7	8	9	10
11	12	13	14	15	16	17
18	19	20	21	22	23	24
25	26	27	28	29	30	31

AUG. 1968

Seminar
lectures - demos -
by leaders in
recording,
music, equipment
Vacation in Rockies, too!

for
info,
write
to

Mr. Kaye Jensen
Recording Seminar
Box 41, HFAC
Brigham Young University
Provo, Utah 84601

225 -

MONDAY, AUG. 12

- 141

during sales meetings, classes, training programs, technical lectures, etc.

Inherent in the rear-projection process are the extras of:

1. Being able to eliminate the distractions caused by having the projection equipment in the room with the audience (the reduction of projector noise and the extraneous light of the projector lamp).
2. Increased seating capacity due to the elimination of the necessary projection aisle down the middle of the room.
3. Elimination of shadows and interference with projection due to movement of the members of the audience rising, entering and leaving.
4. Avoiding *keystoning*, the distortion of the image caused by not having the screen perpendicular to the axis of projection.

Of necessity, a rear-projection installation requires that the screen be fixed in position. (This is assuming that the system will not be a temporary one made with a portable screen behind which the projector is placed for the one rear-screen presentation. Such a one-time presentation is usually not successful unless the projection geometry, optics, and screen material are given

proper consideration.) Since the rear-screen system will have been designed and installed for the explicit purpose of showing slides or films from behind the screen, the projection axis, lenses, distances and image size and brilliance will have been carefully thought out (hopefully) and the equipment will be positioned properly with all necessary remote features included. This will provide the advantage of having:

1. A system which has been properly set up for satisfactory operation at the command of the lecturer at the desired times.
2. A lecturer who is not involved with threading the film or setting up the slides in view of the audience.
3. Equipment, accessories and presentation material which are not within easy reach of the audience, thus preventing damage or pilferage.

There are also behind-the-scenes advantages to a rear-projection setup.

1. In the preparation of the films or slides, there is no need to introduce eye-opener effects to keep the attention of the audience. The material can consist of close-ups or more detailed information than on front-projection material provided

the equipment, screen and room seating layout have been thought out carefully.

2. Standard lamps and lenses can be used in most instances rather than having to provide special optics or bulbs.
3. Shorter behind-screen projection distances can be maintained with proper use of a mirror system.
4. More than one projection system can be provided in the same central area to service several rooms simultaneously.
5. Operation in a normally illuminated room offers the viewer the advantage of less eye strain and fatigue as the eye functions best in this environment.

There are times when illumination of the image must be increased, the lenses must be special, or the projection room must be outside the confines of the viewing room. Each of these situations must be carefully considered before a decision is made to have rear projection. Nevertheless, the advantages of rear projection are real and, with the aid of the audio-visual specialist, the customer and the designer of the presentation room can be guided into including a rear-projection facility in the project.

innovations in components . . .



including

INPUT MODULES
LINE MODULES
LINE/BOOSTER AMPLIFIERS
SLATING OSCILLATORS
POWER SUPPLIES



and consoles



UDIO DESIGNS
AND MANUFACTURING, INC.

SYSTEMS BY INNOVATION

Write or call
for technical information
on our complete line

17510 WYOMING AVENUE
DETROIT, MICHIGAN 48221
PHONE (313) UN 3-7777

Britannia waives the Rule

and produces this superb
condenser microphone at
a very modest price.



THE HAMMOND M-100 CONDENSER MICROPHONE FROM ENGLAND

Modern in performance with excellent sensitivity and frequency response.

Old fashioned when it comes to craftsmanship, trouble-free design, and a lengthy warranty.

The complete stereo unit with cables and a.c. power supply is only \$229.50.

May we send you a brochure?

THE MICROSOUND COMPANY
Box 4591M
Colorado Springs, Colo. 80909

Circle 22 on Reader Service Card

New Products and Services



Amplified Headsets

● A four-stage solid-state amplifier built into each earphone provides a complete monitoring package. Power is from a 9-volt battery in each earpiece. Thus, the phones can be used to directly monitor devices such as a magnetic cartridge or tape head. Equalization is built into the system. The amplifiers have an input impedance of 10,000Ω in their low input; a high-level unequalized input has an impedance of 680,000Ω. The amplifiers may be bypassed to use the phones conventionally. In this case, their impedance is 45Ω. An adjustable headband and foam-filled ear cushions combine to offer long-term wearing comfort.

Mfgr.: Telex Corp.

Price: \$79.50 (excluding batteries)

Circle 54 on Reader Service Card

Monitor Amplifier



● The model 610 is a 10-watt r.m.s. all-silicon-transistor monitor amplifier with total short-circuit and overload protection. The complete amplifier, less the line transformer, is on a printed-circuit card. Gain control accommodates input levels from -10 dBm (0.25V Bridging) and higher. This minimum level of 0.25V is required to produce 10 watts into an 8-Ω load, or 6.5 watts into 16Ω. Instantaneous overload protection is obtained through current-limiting transistors in the driving circuit of each half of the output stage. The output stage itself is class AB with a maximum current flowing through the transistor of 0.4 amps, and an idling current of 20 mA.

Mfgr.: Fairchild Recording Equipment Corp.

Price: \$138.00

Circle 52 on Reader Service Card

New Sound-Reinforcement Systems

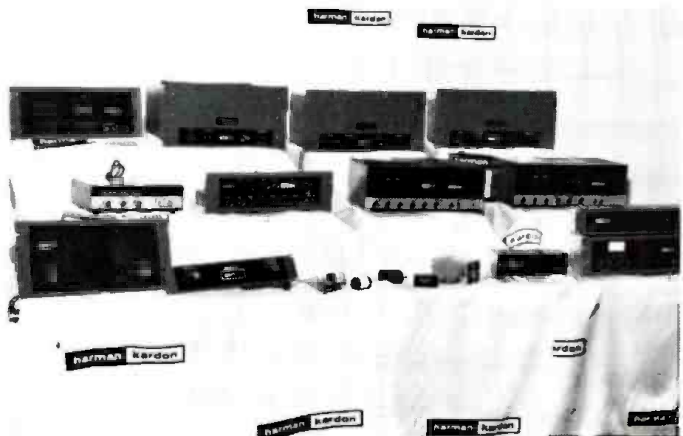

● The illustration above is of an entirely new line of sophisticated sound-reinforcement products from Harman-Kardon, Inc. Design parameters used include conservative design, extreme reliability even under conditions of abuse, and wide versatility of application through the use of plug-in accessories.

At the top are power amplifiers offering as much as 200 watts of power at 4 per cent distortion (150 watts at less than 1.5 per cent). In the center are various combination mixer units — the left center illustrates a six-channel, expandable to eight, mixer/preamplifier. On the lowest shelf are various accessory items, including a speaker monitor

panel, v.u. meter monitor panel, and precedent selecting equipment. Accessories for plug in include mic-line matching transformers, tape-head or magnetic-phono equalization, an electronic precedence circuit using f.e.t. units to accomplish switching without transients, and T pads.

The line, which is being introduced nationally at this writing, is named ProcasT. Future editions of New Products and Services will feature individual items as information is released.

Mfgr.: Harman-Kardon, Inc.

Price: dependent on item

Circle 50 on Reader Service Card

The db Bookcase

As a service to our readers we are pleased to offer these books from prominent technical publishers. All prices listed are the publishers' net. Shipping charges are included.

Use the coupon at the bottom of the page or give the complete title, author and coupon number. Be sure to indicate quantity on the special instructions line if more than one copy of a title is wanted. Full payment must accompany your order. We cannot ship c.o.d. Checks or money orders should be made payable to Sagamore Publishing Company, Inc. Because of the time required to process orders, allow several weeks for the receipt of books.

How To

CLOSED CIRCUIT TV SYSTEM PLANNING by M. A. Mayers and R. D. Chipp. 1957. This book discusses in detail the vitally important and rapidly expanding concept of closed circuit TV systems, its utility and functioning. This book is not an engineering or a technician's text—it is written for management. It explains and illustrates the kind of systems that are available and their applications. 264 pages; 8½ x 11; illus.; clothbound. **\$10.00 (\$11.95 in Canada)**
Circle 16 on Coupon Below

Test and Maintenance

INTERMODULATION AND HARMONIC DISTORTION HANDBOOK by Howard M. Tremaine. A complete reference guidebook on audio signal intermodulation and harmonic distortion. 172 pages; 5½ x 8½; softbound. **\$3.95 (\$4.95 in Canada)**
Circle 9 on Coupon Below

Electronics and Mathematics

HANDBOOK OF ELECTRONIC TABLES & FORMULAS, (2nd Edition)
A one-stop source for all charts, tables, formulas, laws, symbols, and standards used in electronics. Devotes complete sections to items of interest to service technicians and to circuit design data. Includes a 6-page, full-color fold-out chart showing latest FCC allocations for the entire frequency spectrum. 192 pages; 5½ x 8½; hardbound. **\$3.95 (\$4.95 in Canada)**
Circle 8 on Coupon Below

ELECTRONICS MATH SIMPLIFIED by Alan Andrews. For the engineer, student, or technician who requires a knowledge of mathematics as it pertains to electronics. Covers the subject in a logical, clear, and concise manner, using dozens of examples related specifically to electronics. Particularly suited for use as a textbook in any school or other training program involving the study of electronics, the book has been especially prepared to coincide with studies leading to 2nd- and 1st-class FCC Radiotelephone licenses. (2 vols. in slipcase) **\$7.95 (\$9.95 in Canada)**
Circle 11 on Coupon Below

Circuitry and Components

PASSIVE AUDIO NETWORK DESIGN by Howard M. Tremaine. A complete and comprehensive guide to the design, construction, and testing of all types of attenuators, equalizers, and wave filters for the practicing audio technician or engineer. This authoritative text is one of the few written on the subject, and requires only nominal mathematical background. Written in easy-to-understand language, the content presents the basic design, construction, and testing considerations without the confusion often associated with passive networks. 288 pages; 5½ x 8½; softbound. **\$4.95 (\$5.95 in Canada)**
Circle 5 on Coupon Below

TRANSISTORS FOR AUDIO FREQUENCY (AUDIO-FREQUENCY AMPLIFICATION) by Guy Fontaine. 1967. This systematic and detailed treatment of the application of transistors in audio-frequency amplifiers shows how the published transistor characteristics are related to the principles of design. To assure clarity, the figures are rendered in several colors and placed opposite the related text. Simple equations reinforce the lucid approach. An ideal textbook or reference on the subject for engineers and advanced technicians. 384 pages; 5½ x 8; illus.; clothbound. **\$7.95 (\$9.55 in Canada)**
Circle 12 on Coupon Below

DESIGN OF LOW-NOISE TRANSISTOR INPUT CIRCUITS by William A. Rheintelder. 1964. Written for students as well as circuit design engineers interested in low-noise circuit design. Throughout, the book gives a multitude of time-saving graphs and design curves for the practical circuit designer. Simple derivations of all important formulas are also presented to help the reader obtain a deeper insight into the fundamentals of practical low-noise design. 128 pages; 6 x 9; illus.; clothbound. **\$5.50 (\$6.50 in Canada)**
Circle 14 on Coupon Below

ACOUSTICAL TESTS AND MEASUREMENTS by Don Davis. Provides a solid understanding of the entire subject of acoustical measurements; based on actual field test work, using commercial equipment. Contains practical, time-saving solutions to actual problems encountered in the field; minimum math required for understanding. The author is an expert in this field, and an authority on auditorium acoustics. An invaluable book for phone company special service engineers, plant maintenance engineers, communications engineers, noise control specialists, architectural engineers, broadcast engineers and technicians, hi-fi fans and students. 192 pages; 5½ x 8½; hardbound. **\$6.95 (\$8.35 in Canada)**
Circle 7 on Coupon Below

Broadcasting

RADIO BROADCASTING edited by Robert L. Hilliard. Each of the five chapters has been written by a prominent educator with an extensive background of practical experience in commercial and educational broadcasting. The areas covered include: management and programming, operating and studio facilities, producing and directing, writing, performing. For those of you who want to, or must, operate on both sides of the control room, this is virtually required reading. 190 pages; 6¼ x 9½; indexed; clothbound. **\$6.95 (\$8.35 in Canada)**
Circle 2 on Coupon Below

PLANNING THE LOCAL UHF-TV STATION by Patrick Finnegan. 1965. An informative guide for the planning, building, and operation of a small-market, UHF-TV station. Based on the author's lengthy experience in the technical operation of such a station, it explains equipment, layout, and building costs that apply to the small studio (one-man control room operation) with a heavy film schedule. A valuable aid for the station owner, manager, engineer and layman interested in this medium. 328 pages; 6 x 9; illus.; clothbound. **\$10.00 (\$11.95 in Canada)**
Circle 17 on Coupon Below

General Audio

MICROPHONES by A. E. Robertson. 1963. This book, primarily written as a training manual for technicians, will also prove valuable to all users of quality microphones whether for broadcasting, public address systems, or recording of all types. There is now an almost bewildering array of microphones of differing characteristics, and new designs are constantly being produced. The author makes no attempt to catalogue these but concentrates mainly on the principles of operation. He only describes actual microphones if they illustrate an important feature or have some historic significance. The book is intended for the user rather than the designer; mathematics have been omitted from the main body of the text. 359 pages; 6 x 9; illus.; clothbound. **\$12.75 (\$15.40 in Canada)**
Circle 13 on Coupon Below

THE TECHNIQUE OF THE SOUND STUDIO by Alec Nisbett. This is a handbook on radio and recording techniques, but the principles described are equally applicable to film and television sound. It describes how the highest standards may be achieved not only in the elaborately equipped studio but also with simple equipment out on location. 264 pages; 60 diagrams; glossary; indexed; 5½ x 8½; clothbound. **\$10.00 (\$11.95 in Canada)**
Circle 1 on Coupon Below

.....

Sagamore Publishing Company, Inc.
980 Old Country Road, Plainview, N.Y. 11803

Please send me the books I have circled below. My full remittance in the amount of \$_____ is enclosed. N.Y. State residents add 2% sales tax.

1 2 3 4 5 6 7 8 9 10 11 12 13 14 15 16 17 18 19 20 21 22
23 24 25 26 27 28 29 30 31 32 33 34 35 36 37 38 39 40

Name _____

Street Address _____

City _____ State _____ Zip _____

Special Instructions _____

.....

Condenser Microphone System



● This new microphone system is built around a newly-developed model C-451E preamplifier. This unit, using audio-frequency circuitry with field-effect transistors, fully explores the primary advantages of using transistors rather than tubes in condenser mic circuitry — namely, low current consumption at low voltage. Thus, the unit can be used to direct feed almost any commonly used amplifier. Operating voltage is stabilized and limited to 9.1 volts, independent of

supply voltages, which may range from 7.5 to 52 volts. The microphone case itself offers interchangeable pickup capsules such as the CK-1 cardioid, the CK-2 omnidirectional, CK-6 switchable pattern — cardioid to omni to figure-eight, and the CK-9 interference tube (shot-gun attachment). Other power supplies and attachments are available.

Mjgr.: AKG-Norelco
Price: dependent on system
Circle 55 on Reader Service Card

Operational Power Amplifier



● The model 440 differential d.c. operational power amplifier consists of an OPAMP 4009 driving a dual class AB power amplifier. It may be used in audio applications with either a single polarity or bipolar power supply. It has an output capability of 50 watts r.m.s. The entire amplifier is constructed on the octal plug-in heat sink. The circuitry is isolated from the case. Distortion is rated at under 0.5 per cent harmonic or intermodulation. Power supply voltage needed is $\pm 15V$ at $\pm 12mA$. Full power output is from d.c. to 25 kHz, ± 3 dB. Weight is 20 oz.

Mjgr.: OPAMP Labs.
Price: \$30.00 (kit)
Circle 57 on Reader Service Card

Belt Degausser

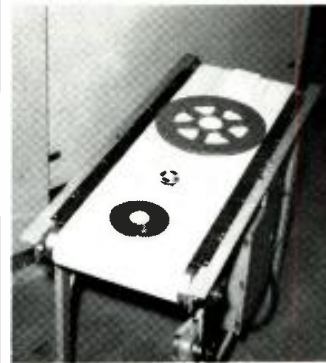

● This high-speed, continuous-duty degausser using a conveyor belt for transport will accommodate all types of tape and film products from cassettes to 14-inch size reels. The unit's speed, versatility, ease of operation, and performance provide the user with a low-cost per unit degaussing system. The duty cycle is continuous. Cooling is by convection, there is only a minimal heat rise, and it has a conveyor speed that is variable from 0 to 60 fpm. Signal removal is better than -65 dB below a saturated signal. Power requirements are 110V a.c. and requiring a 30 amp service.

Mjgr.: Northridge Magnetics
Price: \$1750.00
Circle 53 on Reader Service Card

Fishpole Boom



● This new lockable cuing boom offers quiet, accurate cuing; quick locking of the head for both cuing and fixed-head operation; a completely retractile internal cable that does not interfere with handling; and solid, reliable construction. The cuing head uses Delrin (DuPont) gears and bearings. The housing is cast aluminum for the best combination of weight and strengths. The shafts are $\frac{1}{4}$ -inch hardened steel. Two adapters are supplied

for mic mount attachment: a 5-27 male thread, the other a $\frac{1}{4}$ -in. shaft with wingnut. Adjustable Delrin damping eliminates mic flopping when cued or rapidly panned. This is setable by adjusting one screw. The pole extends to 12 feet from a minimum of 5 ft. 5 in. (with head).

Mjgr.: Recording Equipment Co.
Price: \$265.00
Circle 56 on Reader Service Card

For All Your Recording Tape Needs

We carry a full line of Scotch—BASF—Irish tapes. Write for our free tape list. Lowest prices. Fast delivery from stock

Audio Unlimited

715 Second Ave., New York, N.Y. 10016

Circle 25 on Reader Service Card

People, Places, Happenings

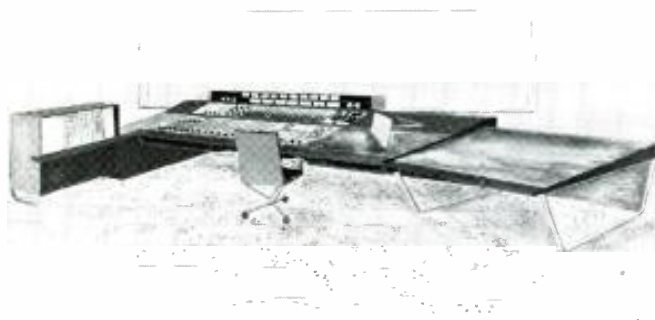

MGM SCORING CONSOLE

● From Electrodyne comes word that Metro-Goldwyn-Mayer Studios has taken delivery of what is billed as the world's first integrated-circuit motion-picture music-scoring console using new technical

and aesthetic concepts. The console features Electrodyne's modular series of i.c. components providing switching and combining facilities of a high order.

● **William R. Tyler**, operator of **Tyler Recording Studios** in Chicago, has recently expanded his facility with the addition of several two- and three-track tape units, as well as other equipment. Tyler Recording specializes in industrial and commercial sound tracks.



JOHNSON

● The appointment of **Thor Johnson** as vice president, sales and marketing for **International Electro Exchange Corp.** has been announced by **Jon Otterlei**, president. The firm supplies switches, miniature lamps, indicators and timers to the electronics and related industries. Mr. Johnson joins the Minneapolis-based firm from **Nortronics Company, Inc.** where he served as distributor sales manager.



RATIGAN

● **Frank D. Ratigan** has been named manager of the Washington D.C. office of **Philips Broadcast Equipment Corp.** The announcement was made by **Anthony R. Pignoni**, director of marketing for Philips Broadcast. As manager of the Washington office, he provides the company's interface with the Department of Transportation, Department of Defense, FCC, and other governmental branches in the area of electronics and communications. Mr. Ratigan was formerly Washington corporate representative for **Fairchild Camera and Instrument Corp.** as well as sales manager in that city for the **Space and Defense Division** of Fairchild.

Classified

EMPLOYMENT

WANTED—REPRESENTATIVES. Active, qualified representatives to cover advanced audio line. Submit organization resume, territory normally covered and other lines handled. **Fairchild Recording Equipment, 10-40 45th Avenue, Long Island City 1, New York**

Salesman to call on RECORDING STUDIOS to sell professional audio equipment in Metropolitan N.Y. area. Experience preferred. Send resume to Box E6, db Magazine, 980 Old Country Road, Plainview, N.Y. 11803.

SERVICES

MASTERING AND REFERENCE COPY— Mono, Stereo — Top notch equipment — top engineering. **Sön-Deane Records, Hartsdale, New York 10530.** Telephone: 914 OW 3-1590

FOR SALE

WESTREX 2B — Mono cutting system complete, A-1 condition, with RIAA equalizer, spare tubes, parts, and styli. \$1800.00 F.O.B., New York. Call 212 CH 2-1455

SCULLY TAPE RECORDERS — One to twelve track. Two, four, and eight track models in stock for immediate delivery.

SCULLY LATHES — Previously owned and rebuilt. Variable or automatic pitch. Complete cutting systems with Westrex heads.

MIXING CONSOLES — Custom designed using Electrodyne, Fairchild and Universal Audio modules. From \$4000.00.

Wiegand Audio Laboratories, 221 Carton Avenue, Neptune, N.J. 07751, Phone: 201 775 5403

FOR SALE

TEAC R-310 THREE TRACK RECORDER with cases. \$790. **R. Blinn, 7692 Woodrow Wilson, Los Angeles, California 90046**

SOLID-STATE 50 WATT RMS plug-in d.c. thru 25 kc operational power amplifier kit, model 440K. Price \$30.00. Send for free catalog and 50 operational amplifier applications to: **Opamp Labs, 172 So. Alta Vista Blvd., Los Angeles, California 90036.**

EQUIPMENT WANTED

NEUMANN AM32b or good Scully Lathe. **Jim Shelton, P.O. Box 9190 Austin, Texas 78757**

PROFESSIONAL DIRECTORY

PHILIP C. ERHORN
Systems Design and Specifications
Custom Consoles Technical Writing
P.O. Box 861, Stony Brook, New York 11790. Tel: 516 941-9159

● Roger Czerniak has been promoted to dealer and distributor sales manager of Nortronics Company, Inc. according to John A. Yngve, president. Mr. Czerniak has been assistant sales manager in the dealer and distributor divisions for the past two and a half years. In his new capacity he will be responsible for the administration of replacement head sales.

● Radio station KBIS of Bakersfield, Calif. believes that it established a broadcasting first when it solved a power failure that blocked out the entire area by using a battery-powered Sony tape recorder to stay on the air for more than an hour-and-a-half. Since the transmitter was outside of the blacked-out area, station personnel set up a Sony 800 in master control. The output of the unit was then tied directly to telephone lines hooking the studio to the transmitter. Voice transmission was made possible by placing the tape recorder in record position. Thus an all-talk program continued the station's broadcasting during the blackout.

● At Visual Electronics Corp. of New York, Sidney V. Stadig has been appointed to the new post of manager-headquarters sales. Most recently, Mr. Stadig was director of engineering for W.B.C. Productions and prior to that served in engineering management capacities for Group W stations in Cleveland, Philadelphia, San Francisco, and Boston.

● Leonard Leff has been named to the newly created post of manager of technical operations for Windsor Electronics Systems Corp. of Laurelton, N. Y. In the announcement by Bertram B. Goodman, president, Mr. Leff was named to head the responsibility for the design, maintenance, engineering, and installation of c.c.t.v. systems designed and installed by Windsor. For the past twenty years Mr. Leff has been associated with WPIX in a variety of progressively important engineering positions, most recently as technical director. It was Mr. Leff, as a cameraman, who took the famous pictures of Frank Costello's hands during the televising of the Senate hearings conducted by the late Sen. Kefauver. This won a Sylvania award for WPIX-TV. Windsor Electronics Systems Corp. is the engineering distributor for commercial t.v. products of Fairchild Camera and Instrument Corp.



ROSENBERG

● Perma-Power Company of Chicago has been acquired by Chamberlain Manufacturing Corp. of Elmhurst, Illinois. Perma-Power manufactures p.a. systems and amplifiers as well as other items. The company will now function as a division of Chamberlain. No changes in personnel are contemplated. Richard Goldstein, president of Perma-Power, will continue to direct its operations. He will also become a director of Chamberlain. The new parent company is a diversified manufacturer of home improvement and industrial products.

Prior to the corporate shift, Perma-Power had announced the appointment of Phillip I. Rosenberg as marketing manager. In his new capacity he will be responsible for all staff marketing functions, including market research, branch offices, new product planning, customer and sales services, and technical writing. Mr. Rosenberg has been with Perma-Power since August of 1965.

Emil P. Vincent, 48, product manager-audio systems for Visual Electronics Corp., died suddenly at Pasadena, California on April 25th, 1968.

Emil Vincent was well-known and even better liked by audio professionals. He was a former Governor and the 1967 convention chairman of the Audio Engineering Society. He had joined Visual Electronics earlier this year and had just relocated to Pasadena. Prior to his association with Visual Electronics he was with the CBS and ABC television networks.

His valuable presence will be sorely missed by a great many.

● There is always movement at a company the size of Ampex. Recent changes include the appointments of Oral Evans as national distribution manager for the industrial and educational divisions' closed-circuit vtrs. Harold Blakeslee becomes a field service manager for closed-circuit vtrs, t.v. cameras, and associated equipment. George Foster has been named national accounts manager of this same division. Mr. Evans and Mr. Foster come to Ampex from the Raytheon Learning Systems Co. Mr. Blakeslee has been with Ampex since 1963. These new appointees will be located at the division's marketing headquarters in Park Ridge, Illinois.

Earlier, Rein Narma, Ampex v.p. and general manager of the consumer and educational products division announced the appointment of Nathaniel M. Marshall. Mr. Marshall will have responsibility for marketing closed-circuit vtrs, t.v. cameras, etc. Mr. Marshall also comes to Ampex from Raytheon where he was a v.p.

Finally, there is the announcement by Leonard R. Sainsbury, v.p. at Ampex for their magnetic tape division, that Paul J. Weber has been appointed as that division's marketing manager. Mr. Weber has held various corporate positions with Ampex since 1955.

● Vincent T. Wasilewski, president of the National Association of Broadcasters, recently announced the appointment of seven radio executives to serve on the NAB's FM Radio Committee. Gary Gielgow, co-manager of station KPEN (f.m.) of San Francisco, was re-appointed to a two-year term and designated chairman of the group. Edward D. Allen, Jr., president and general manager of WDOR (a.m.-f.m.), Sturgeon Bay, Wis., and Harold R. Krelstein, president of WMPS (a.m.-f.m.), Memphis, Tenn., were named to the committee to represent f.m. stations. David H. Polinger, president and general manager of WTFM (f.m.) Fresh Meadows, N. Y., was re-appointed to a two-year term, and the following broadcasters were appointed to new three-year terms: Everett B. Cobb, general manager, KNEV (f.m.), Reno, Nev.; Harry Dennis, v.p. and general manager, WERE (a.m.-f.m.), Cleveland, Ohio; and George R. Kravis, president, KFMJ and KRAV-FM, Tulsa, Okla.



BENTLEY



JOHNSON

● The appointment of Jack R. Bentley as a new v.p. of LTV Ling Altec was announced today by Lee D. Webster, president and chief executive officer. Mr. Bentley has been with the company since 1962. His offices are in Anaheim where Ling Electronics and Altec Lansing share a large industrial facility. He has been secretary and controller of the corporation since 1965.

Within the Altec Lansing division, William H. Johnson has been advanced to director of marketing. Mr. Johnson is a veteran of the commercial sound field, having been with Altec in various sales capacities for more than eighteen years. In his new assignment he will plan and direct the activities of the Altec national field sales force, plan and conduct the annual sales clinics held in various cities throughout the U.S., as well as the general marketing activities of the division.

What does AR mean, "60 watts per channel"?

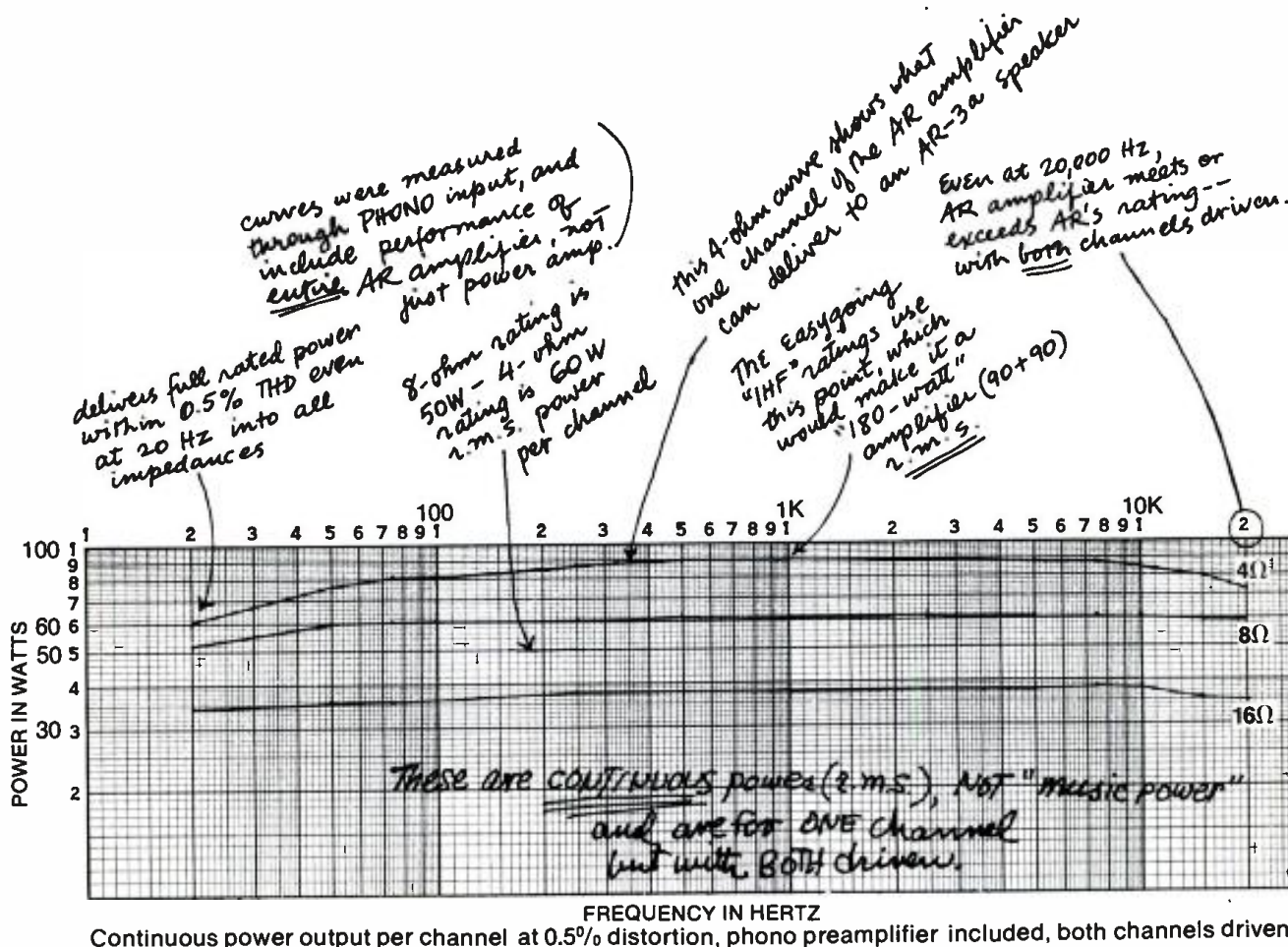

ment to be presented clearly and accurately in amplifier advertising. This has not been the case. In recent years, a variety of vague and irrelevant terms has been used by manufacturers to describe power output: music power, solid-state power, stereo power, audio power, transient power, transistor power, IHF power and others. The list includes terms invented by manufacturers and applied to their products alone, as well as standards of measurement known only to advertising copy writers. In a recent issue of High Fidelity, for example, 18 manufacturers advertised amplifiers, but in only two cases were power ratings referred to a known standard.

Acoustic Research accepts the definition of a watt given in physics texts: work done at the rate of 0.7375 ft.-lb./second. We know of no "music watt" or "IHF watt" which science recognizes. AR amplifiers are rated exactly as we measure them, with both channels continuously delivering at least

One of the most important characteristics of an amplifier is its power output. Consumers might therefore expect this measure-

the rated power without exceeding our harmonic distortion limit of 0.5%, or our I.M. distortion limit of 0.25%. The laws of physics and the nature of music require that power measurements, if they are to be meaningful, be made with a steady, uninterrupted tone, similar to the purest sound of a pipe organ; this is what continuous power means. AR amplifiers must deliver their rated continuous power at all frequencies to which the ear responds, not just at 1,000 Hz, where most amplifiers can deliver much more power than at the extremes of the range of hearing. Distortion measurements are made through the AR amplifier's phono input because this is the way music goes through the amplifier — even though performance might be better with the preamplifier out of the circuit.

For these reasons, the power output rating of the AR amplifier is true for any kind of musical tone, not only those easy for an amplifier to reproduce, whether the source is an FM broadcast, a tape recording or a phonograph record.

The AR amplifier is covered by a guarantee unmatched in the industry. If an AR amplifier fails to operate as advertised within 2 years of the date of purchase because of a factory defect, AR provides parts, labor, freight both to and from the factory or nearest authorized service station, and even a new carton if necessary — all with no charge.



Acoustic Research, Inc.
24 Thorndike St.
Cambridge, Mass. 02141

Circle 11 on Reader Service Card

If you like Audiopaks our lubricated Audiotape will really be your cup of tea.

Broadcast engineers all over the country like our Audiopak® cartridges so much, we've been using their comments in our advertising. And, we've been giving each one an inscribed cup as a token of our appreciation.

Now, with our Audiotape Formula 17 Lubricated tape designed especially for continuous loop cartridges, their cup will really runneth over.

Here's why:

It provides excellent high end response and signal-to-noise ratio. The long wear, high temperature binder won't soften or gum up heads.

The lubricated coating is permanently bonded to the base. Can't wear off and cause jamming; won't dirty heads and capstans.

Very low abrasion properties reduce head wear and premature failure, assures smooth tape motion with negligible wow and flutter.

Audio is the only cartridge manufacturer who also makes tape. (We are the largest supplier in the world.) So, you can be sure our cartridges and our tape match each other perfectly. But regardless of cartridge make, Formula 17 is the best tape you can use.

Why not find out about Audiotape Formula 17 for yourself.

Audio Devices, Inc.
A SUBSIDIARY OF CAPITOL INDUSTRIES, INC.
235 E. 42nd St., New York 10017

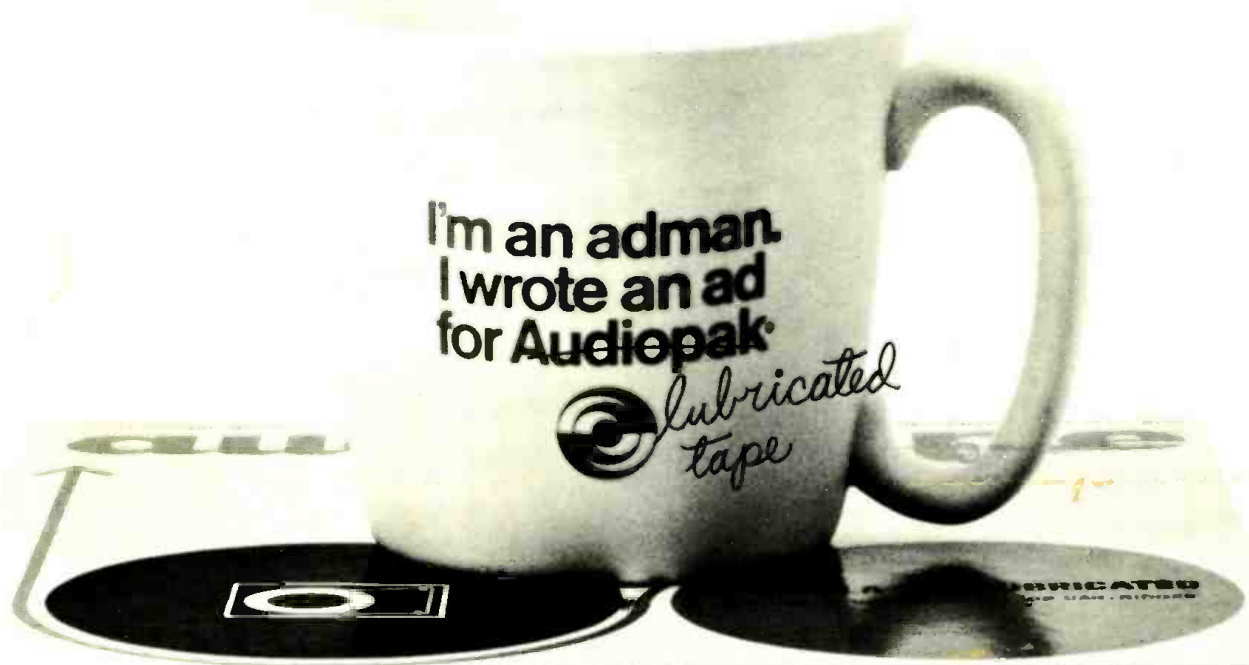

audiotape 1700 ft.—1 mil polyester base Type 1761—Lubricated

Circle 12 on Reader Service Card