

dB

THE SOUND ENGINEERING MAGAZINE

OCTOBER 1968 75c

Biasing Considerations
Complete Guide to the New York AES Convention

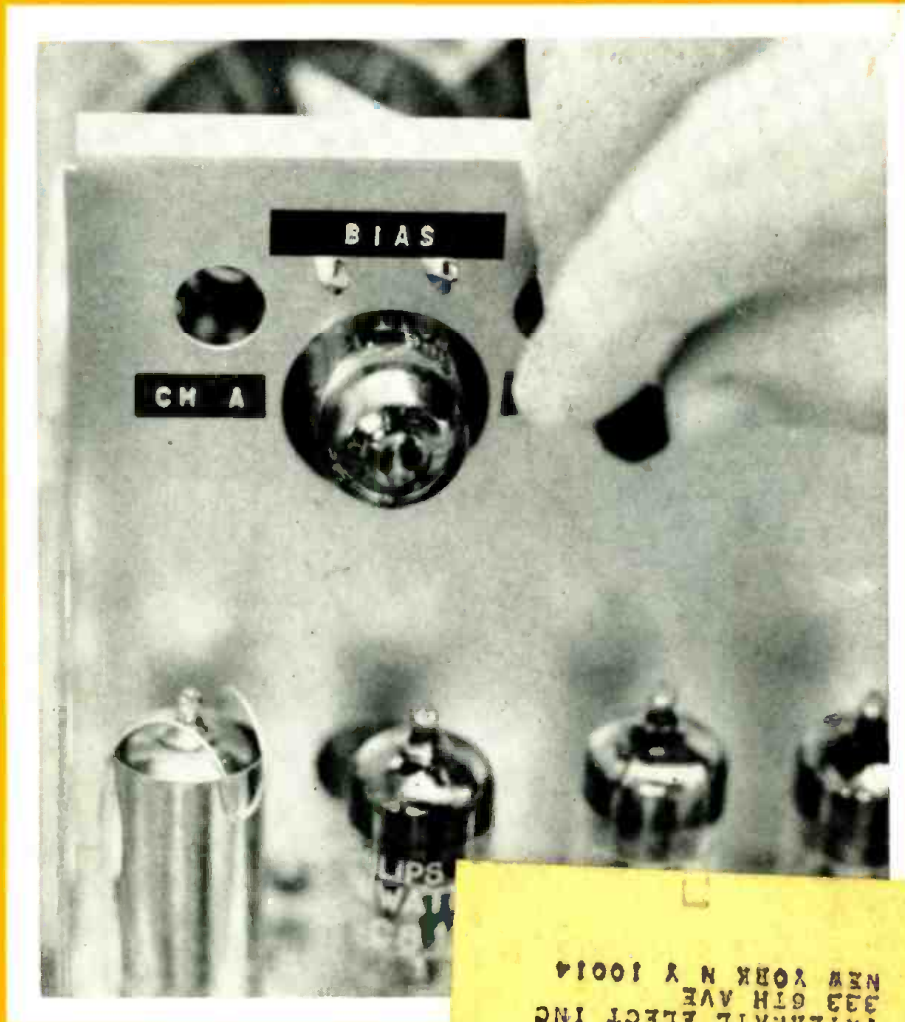

ALBERT B GRUNDY JR
INTERNATL ELECT INC
333 6TH AVE
NEW YORK N Y 10014

5

sound reasons why the MM-1000 is your best investment

1. It's expandable

Our 8-channel MM-1000 Master Recorder costs from 2 to 4 thousand dollars more than other 8-channel recorders. But with the MM-1000 you can readily expand to 16 or 24 channels. Add-on "kits" enable you to add channels as you need them. Or you can buy the MM-1000-16 or -24 completely checked out and ready-to-go.

2. It's designed to handle wide tape

The MM-1000 tape transport is designed to handle 1" and 2" tape. It's the same transport that's now in use on over 3000 Ampex video tape recorders. When you go from 1" to 2" tape, you just change the tape guides and the plug-in head assembly. Lets you quickly change from 1" for 8 channels to 2" for 16 or 24 channels.

3. It's versatile

The MM-1000 offers more standard and optional features than any other master recorder. Tape Motion Sensing for instance. Allows you to change modes without going into stop or without stretching

or breaking tape. Automatic Tape Lifters? Yes, and with manual override. Ping Ponging? Sure. Sel-Sync? Naturally, also remote Sel-Sync. How about Variable Speed Motor Drive Amplifier? Yes again, plus an Electronic Timer with up to 4 remote read-outs for pinpoint accuracy. Versatile? You bet!

4. It's promotable

"New generation" recording capability is built into the MM-1000. The new groups demand this capability and record at the studios that offer it. The MM-1000 is capturing the imagination of these groups, and challenging their creativity. With the MM-1000 you'll have a promotable edge over studios with past generation equipment.

5. You can pay for it out of current earnings

Our exclusive lease or extended pay plan lets you start using the MM-1000 now, and pay for it out of the extra earnings it will generate—costs as little as \$3.96 per studio hour. For a complete list of features, specifications and financing information, call us collect 415-367-4400 or write:



AMPEX

Ampex Corporation
401 Broadway, Redwood City,
California 94063

Coming

Next month and in coming months a number of exciting and interesting projects are under way. Robert C. Ehle has prepared a paper on the construction of an Electronic Music Synthesizer. We have an article to be given in two parts that explains the Altec *Acousta-Voicing* system as it is applied to the control and auditioning studio. Don Davis is our author and he will describe this technique which makes it possible for one room's sound to be equalized so that it is identical to other rooms. Howard Souther has submitted an article that describes a new electrostatic earphone of unusually wide range and low distortion.

In December we will have a picture gallery of the new products displayed at the New York AES Convention.

And there will be our regular columnists, George Alexandrovich, Norman H. Crowhurst, Martin Dickstein, and John A. McCulloch.

Coming in *db*, the *Sound Engineering Magazine*.

About the Cover

Tape recorder bias is critical in its relationship to both distortion and frequency response of the recording. Sidney L. Silver tells about this important trade-off on page 18.

← Ampex—Circle 25 on Reader Service Card

db

THE SOUND ENGINEERING MAGAZINE

October 1968 • Volume 2, Number 9

Table of Contents

FEATURE ARTICLES

- Biasing Considerations in Magnetic Tape Recording
Sidney L. Silver 18
- Unit Standards
John G. McKnight 22
- The 35th AES Convention — Complete Program 23

MONTHLY DEPARTMENTS

- Letters 2
- The Feedback Loop
John A. McCulloch 4
- The Audio Engineer's Handbook
George Alexandrovich 6
- Theory and Practice
Norman H. Crowhurst 10
- New Products and Services 28
- The *db* Bookcase 30
- Classified 31
- People, Places, Happenings 32

EDITORIAL BOARD OF REVIEW

George Alexandrovich
Sherman Fairchild
Norman Anderson
Prof. Latif Jiji
Daniel R. von Recklinghausen
William L. Robinson
Paul Weathers
John H. McConnell

db, the *Sound Engineering Magazine* is published monthly by Sagamore Publishing Company, Inc. Entire contents copyright © 1968 by Sagamore Publishing Co., Inc., 980 Old Country Road, Plainview, L.I., N.Y. 11803. Telephone (516) 433-6530. *db* is distributed to qualified individuals and firms in professional audio—recordings, broadcast, audio-visual, sound reinforcement, consultants, video recording, film sound, etc. Application must be made on an official subscription form or on a company letterhead. Subscriptions are \$6.00 per year (\$7.00 per year outside U. S. Possessions, Canada, and Mexico) in U. S. funds. Single copies are 75c each. Controlled Circulation postage paid at Easton, Pa. 18042. Editorial, Publishing, and Sales Offices: 980 Old Country Road, Plainview, New York 11803. Postmaster: Form 3579 should be sent to above address.

Robert Bach
PUBLISHER

Larry Zide
EDITOR

Bob Laurie
ART DIRECTOR

Marilyn Gold
COPY EDITOR

Charles N. Wilson
ASSISTANT EDITOR

Richard L. Lemer
ASSISTANT EDITOR

A. F. Gordon
CIRCULATION MANAGER

David Pollens
ASST. CIRCULATION MGR.

SALES OFFICES

New York
980 Old Country Road
Plainview, N.Y. 11803
516-433-6530

Denver
Roy McDonald Associates, Inc.
846 Lincoln Street
Denver, Colorado 80203
303-825-3325

Houston
Roy McDonald Associates, Inc.
3130 Southwest Freeway
Houston, Texas 77006
713-529-6711

Tulsa
Roy McDonald Associates, Inc.
2570 S. Harvard Ave.
Tulsa, Oklahoma 74114
918-742-9961

Dallas
Roy McDonald Associates, Inc.
Semmons Tower West
Suite 411
Dallas, Texas 75207
214-637-2444

San Francisco
Roy McDonald Associates, Inc.
625 Market Street
San Francisco, California 94105
415-397-5377

Los Angeles
Roy McDonald Associates, Inc.
1313 West 8th Street
Los Angeles, California 90017
213-483-1304

Portland
Roy McDonald Associates, Inc.
2035 S.W. 58th Avenue
Portland, Oregon 97221
503-292-8521

Letters



The Editor:

In reply to your April editorial, please retain the SI symbols for units; there are enough difficulties in communication between people with different specialties, without each field, such as audio, or each publication, deciding to take the popular course of maintaining its own jargon.

Udene E. Younger
Naval Undersea Warfare Center
Pasadena, California

The Editor:

Since I have to edit technical publications in many languages, I am greatly in favor of international symbols. In a multi-lingual publication it is not usually possible to print essential tables and the co-ordinates of graphs in all the languages—but if the symbols can be read by everyone then this is not necessary. Most engineers can grasp the meaning of a table, even when it is printed in a language they don't know, if only they can understand the symbols.

It is a hopeful sign that in our much divided world universal symbols are being adopted to replace the many like c/s which have significance in one language only. The fact that some of these symbols in their abbreviated form use capitals because they have been derived from a surname is perhaps a bit old-fashioned. But does it matter as long as everyone acts as has been agreed upon at an international level.

I admit that I am perhaps taking a narrow view and am looking at the problems as seen from my own desk, but to me universal understanding is better than individual clarities in as many languages as are used for writing about engineering subjects. (This, of course, is pending the adoption of Eng-

lish as the universal engineering language—for the present a rather utopian thought.)

G. Slot
Eindhoven, Netherlands

The Editor:

I read your editorial in the April issue of *db* with a great deal of interest because it points out one of the many problems that exist in the engineering profession.

As a mechanical engineer and a designer of tape recorders, I have to work with electrical standards. Sometimes I think the electrical standard could have been improved if there had been some mechanical input when the standard was written.

This problem is just the outcrop of a deeper and more serious problem that afflicts the engineering profession. The problem is that the traditional organizational structure of the engineering profession will not allow engineers to deal with their problems in an effective manner.

In our present age almost all projects and problems cut across the lines of traditional engineering. It is for this reason that a new engineering association has been founded. It is called the American Engineering Association; it is open to all engineers (civil, mechanical, chemical etc.).

Give us a few years and I believe that the AEA will be able to take care of this problem and others of a more serious nature also.

T. Edward Black
American Engineering Assoc.
Lakeside, Michigan 49116

Interested readers can write to Mr. Black directly for more information on the AEA. Ed.

On Oct. 21st, it's your turn...

...to see the world's most sophisticated tape-to-disk transfer mastering system.

NEUMANN DYNAMIC FEEDBACK STEREO CUTTERHEAD SX-68. Has two separated armatures linked in a way that eliminates all secondary resonances below 75,000 Hz! Frequency range: 40-16,000 Hz. Frequency response "overall": ±1 dB. Channel separation over the frequency range: ≥35 dB. Max. velocity (lateral) at 10 KHZ for 10 sec.: 40 cm/sec (w/cooling).



NEUMANN COMPUTER CONTROLLED STEREO DISK CUTTING LATHE VMS-66. The latest version of the Neumann lathe, fully transistor equipped, relayless, and featuring the most refined pitch/depth system using digital techniques to allow up to 35 minutes on a 12" LP side.

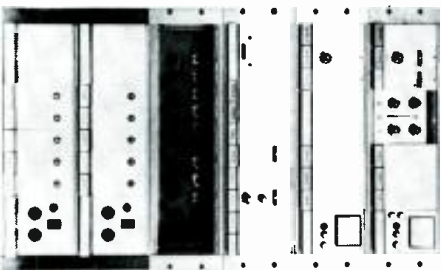

NEUMANN STEREO CUTTING SYSTEM VG-66. Contains all units necessary for proper operation of the SX-68 and all previous Neumann cutterheads. All silicon transistor; 100 Watts per channel; completely devoid of all relays or switching contacts. Printed circuit plug-in cards.

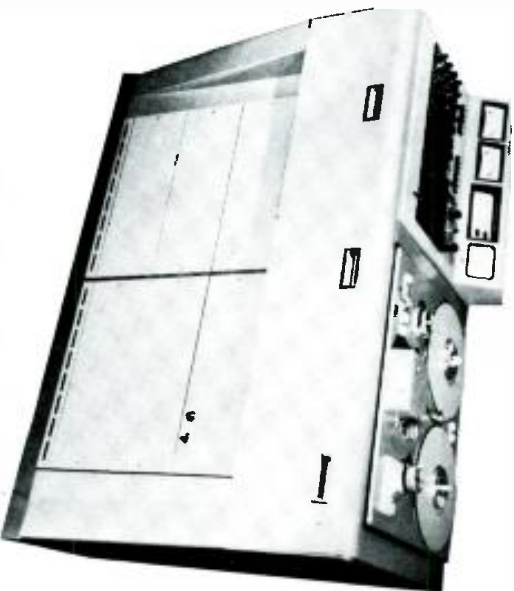

NEUMANN TAPE PLAYBACK AND CONTROL CONSOLE SP-655 (stereo/mono). Tape playback deck with preview head system and all control, equalizing, and metering functions to prepare the signal for stereo or mono cutting. Peak and VU meters, compatibility indication, patching facilities.

Stop by Gotham Audio's suite at the AES Convention anytime between October 21-24. You'll see this amazing system in action for the first time anywhere.

There are plenty of exciting innovations to see. Three of the four components—all made by Neumann—have never been shown before in the U.S. The Dynamic Feedback Stereo Cutterhead SX-68 has several hard-to-believe technological advances.

In Neumann's considered opinion, this integrated system establishes a new standard of quality for mastering. You can purchase the components individually, or as a complete channel. But first, let us give you a demonstration at the convention. Watch an actual tape-to-disk transfer in progress. Ask lots of questions. Hearing is believing.

GOTHAM
AUDIO CORPORATION
2 WEST 46 STREET, NEW YORK, N. Y. 10036-212-CO-5-4111

Here's how to get a closer look: Visit Suite 2440, Park-Sheraton Hotel, New York City, Oct. 21-24.

Mon., Tues. & Thurs., Noon to 9 PM / Wed., Noon to 6 PM

The Feedback Loop

JOHN A. McCULLOCH

The Feedback Loop invites your questions on any subject pertinent to professional audio. Address your queries to The Feedback Loop, db Magazine, 980 Old Country Road, Plainview, N. Y. 11803. Please enclose a stamped, self-addressed envelope. Mr. McCulloch will answer all letters in this column or by mail.

● Three letters and three different topics form the material of this month's column. First, there is a suggestion on control and switch cleaning, then some comments and concrete suggestions on the installation of spring reverb devices, and finally a suggestion to those of you that like to experiment and develop new products and ideas.

Marlen C. Andersen of KOOK, Billings, Montana, suggests the use of Freon TF for cleaning attenuators, switches, and other areas of low voltage low current signal paths.

He states, "Freon TF cleans the controls, relays, and switches down to the original metal; but does not leave an oil residue which will collect more dirt. I've found on extra dirty attenuators a spraying with Freon TF followed by a scrubbing with a toothbrush will return the attenuator to almost new state."

Of course if the contacts are too worn or pitted, replacement, not cleaning is the answer. As I remember Freon TF it was always around the video tape room for in-operation head cleaning because of its extreme volatility and the lack of a film or other residue after its use. Somewhat standard is the wiping on of a small amount of Lubriplate, immediately followed by a soft rubbing with a clean cloth. This left just enough of a lubricating film to be of assistance, yet not enough to really collect heavy amounts of dirt. Thoroughly cleaned and lubricated in this manner, the controls were good for about four months.

From KVOL's Mr. W. A. LeBlanc (Lafayette, La.) came a multi-page letter. My original discussion of reverberation in May was just general thinking along the line of *what*, and *why*. He

has been kind enough to send along several of the *hows*. His contribution is exactly what THE FEEDBACK LOOP is designed to utilize. With regards to actual installation of a reverberation device, Mr. LeBlanc makes these suggestions:

"Tie all grounds or commons together with no switching.

"Adequately suspend the unit (or the spring section if separate) to eliminate outside mechanical vibrations from being transmitted to and through the spring device.

"Remote an on/off switch for easy control of the device, such as effects during newscasts, sports, etc.

"Adjust the controls of the reverberation device to merely add *fullness* to the sound (unless its use is planned as a deliberate effect).

"The reverb unit will also increase coverage especially in the fringe area because the audio stays longer. The modulation monitor will peak at a higher average.

"Once the reverb is adjusted controls should be locked or replaced with fixed values to determine a definite non-changing sound of the station.

"The use of most so-called *stereo* reverb units should be avoided in stereo broadcast applications. Most are merely mono spring devices, and decrease the stereo separation."

A properly devised stereo reverberation system requires not only provision for the addition of the reverberation component to each channel separately, but also permits a small degree of mix of the reverberated signals. This will overcome the differences of the separate units, and yet maintain good stereo separation. Alike amplifiers, properly equalized and driving identical spring units, fed into a blend control, to give 3 to 6 dB of mix seems to be a practical solution.

In any reverberation system both the drive and receive amplifiers should be equalized. The degree of equalization is determined by the response of the mechanical device, and the ultimate

sound desired. (The May column contained curves detailing this response.)

Spring units are available from many sources, among them: Ron Wall, Gibbs-Special Prod., P.O. Box 471, Janesville, Wis.; Jim Long, Electro-Voice, Inc., Buchanan, Mich. 49107; Southwest Tech Prod., 219 W. Rhapsody, San Antonio, Texas 78216.

Several readers have asked for information of specific projects, for some of which I can not supply answers, since the area to which I have access for plans and such involves either commercial units, or the complexity and cost would be prohibitive to small stations or studios. Requested so far are:

Compact headphone amplifier to be driven from the normal buss output or the HI-Z monitor jack. The amplifier to drive 8-ohm sets.

A device to register the 3 and 10 bell signals and alert studio personnel to the teletype.

A compact, inexpensive microphone pre-amp with second input for recorder signal, coupled with a line amplifier to drive a telephone line for remote applications.

A compact 0-20v well-filtered 100MA power supply.

Let this column be a clearing house to share these or other ideas and designs you have with your fellow readers. Of course, to safeguard everyone, these designs must be of your own making, and not commercially offered.

MOVING?

Have you sent us a change-of-address notice? It takes time for us to change your plate so let us know well in advance of your move. Be sure to send us the complete new address *as well as your old address*. Include both zip numbers. Keep **db** coming without interruption!

BACK ISSUES AVAILABLE

A limited number of back issues of **db** are available to interested readers who may have missed or misplaced earlier issues. When ordering please indicate date of issue desired and enclose 75c for each copy.

CIRCULATION DEPT.

db — The Sound Engineering Magazine
980 Old Country Rd.
Plainview, N. Y. 11803



koss model esp-6 electrostatic stereophones deliver a sound never before possible in headphones!

3 Octaves of Sound beyond the limits of ordinary voice-coil and cone-type driver elements—this wide range is reachable only through electrostatics.

World's first Self-Energized Electrostatics—Easy to use—You just plug-in like other headphones. No special amplifiers or power supplies needed.

The sound of Koss ESP-6 headphones is as new and unique an experience as the very first time you heard the sound of Koss Stereophones. Remember the dramatic and expansive sound? Like nothing you ever heard before. And now Koss has done it again.

Through the development of the world's first electrostatic driver element for headphones, Koss engineers have created a sound lively in its own reality; smooth and relaxing in character. It is a sound beyond the limits of ordinary voice coil-and-cone-type

driver elements. It is a sound reachable only through electrostatics.

Through the development of practically weightless, self-energized diaphragms never before possible for headphone uses, Koss engineers have eliminated the moving cone driver element to achieve a frequency response obtainable in the past only through the use of complex electrostatic speakers like the Koss-Acoustech X system. And only now have Koss engineers been able to employ these techniques for headphone listening. And to prove

World's first wide-range electrostatic driver elements for headphones. Give smooth, peak-free, relaxing performance.

Dynamic Level Indicator in each cup light lights up, protects against very high sound pressure levels to give long, trouble-free listening pleasure.

it, an individual machine-run response curve comes packed with each headset. Dramatic Koss ESP-6 Electrostatic Stereophones feature a dynamic level indicator in each earcup to protect against overload when signal reaches very high sound pressure levels. Constructed with earpieces of sturdy, high impact plastic, coiled cord extending to 10 feet, comfortable foam rubber headband, and fluid-filled ear cushions for effective seal, the ESP-6 will withstand rugged use required by professional recording. Yet uniformly reliable and superb sound reproduction need not be sacrificed.

**COMPLETE WITH FITTED,
PORTABLE CARRYING CASE AND**

**INDIVIDUALLY MEASURED
RESPONSE CURVE \$95.00**

Write the factory today for free technical article "Adventure in Headphone Design."

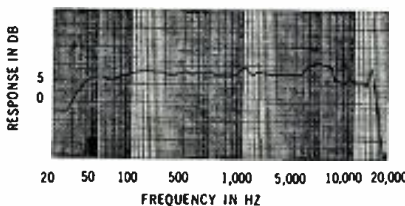

TYPICAL RESPONSE CURVE WHEN MEASURED ON 6 cc COUPLER

KOSS

Koss Electronics Inc.
2227 N. 31st Street, Milwaukee, Wis. 53208

Export: Koss Electronics S.r.l.
Via Bellini 7, 20054/Nova Milanese, Italia

Export Cable: Stereolone

Circle 29 on Reader Service Card

ONE STOP FOR ALL YOUR AUDIO/VIDEO NEEDS



- Professional Audio/Video Equipment
- Video Recorders
- Recording and Broadcast Components
- Recording Tape and Accessories
- Hi-Fi/Stereo Systems
- Ampex Audio and Video Recorders



Write today
for our new
1969 catalog.

SONOCRAFT
SALES • SERVICE • INSTALLATION • RENTAL

115 WEST 45TH STREET, Dept. DB
NEW YORK, N.Y. 10036 JU 2-1750

Circle 28 on Reader Service Card

The Audio Engineer's Handbook

GEORGE ALEXANDROVICH

SWITCHING CONTINUED

● When reasons of economy dictate the use of the same power amplifier for both monitoring in the control room and driving speakers in the studio, special circumstances must be taken into consideration. Under these circumstances switching of the speakers is done in the output of the amplifier. If tube-type amplifiers are used it should be remembered that the output of the amplifier must always be terminated. With a transistor amplifier, however, it is not necessary to have the output terminated at all times. The output impedance of a transistor amplifier is inherently low, therefore, even when output transformers are used, a step-up condition exists. This is just opposite from the situation with tube amplifiers. The reason it is necessary to have the output terminated at all times in a tube amplifier is because the unloaded inductance of the transformer's primary may produce voltage spikes across the plates of the output tubes and transformer that are high enough to cause voltage breakdown of the component.

From this it follows that all switching of tube-type amplifiers must be done with dummy loads as a substitute for the load when the speaker is disconnected. Switches should have shorting-type contacts—contrary to transistor amplifiers which require non-shorting switches. While tube-type amplifiers tolerate momentary shorts without harm, transistor amplifiers do not.

So if your studio is considering a modernization of monitoring facility with the substitution of transistor amplifiers for existing tube units, be sure that the existing system of switching is compatible.

In the end, because most monitoring is done at high levels, demanding unbelievable amounts of power, it is appropriate to suggest that most of the

switching be done in the input rather than the output.

SELECTION AND MIXING

In most audio consoles where there may be anywhere from two to sixteen channels, the delegation of monitoring circuits becomes as important as the recording process itself.

While it is necessary to record with a maximum of interchannel separation, it is often desirable to monitor in what will be the final form—one or two channels. We must not allow monitoring channels to spoil the 60-70 dB of separation commonly found by connecting the monitor mixing buss to recording channels.

It thus becomes obvious that conventional mixing busses cannot be used. There are several solutions to the problem. The most expensive of these is to isolate each channel's monitor circuit with a separate amplifier. Hybrid networks can be used in two-channel consoles allowing a separation of no more than 50-60 dB. But this method is ruled out by the need for transformers and the instability of adjustment.

The most attractive solution is the bridging mixing network followed by an amplifier boosting the signal back to line level. As much as 80 dB of separation is available from a network without the need for transformers or adjustment. (However, a requirement for this sort of network is that all the channels to be monitored be physically close together, preventing high-frequency losses due to capacity of shielded wires.)

If several channels are to be monitored in mono, the network should consist of one bridging resistor from each of the channels, interconnected at the input of the booster or power amplifier (if it has sufficient gain). The loss of level

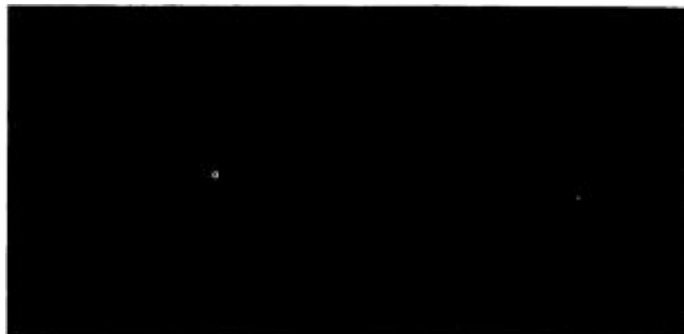
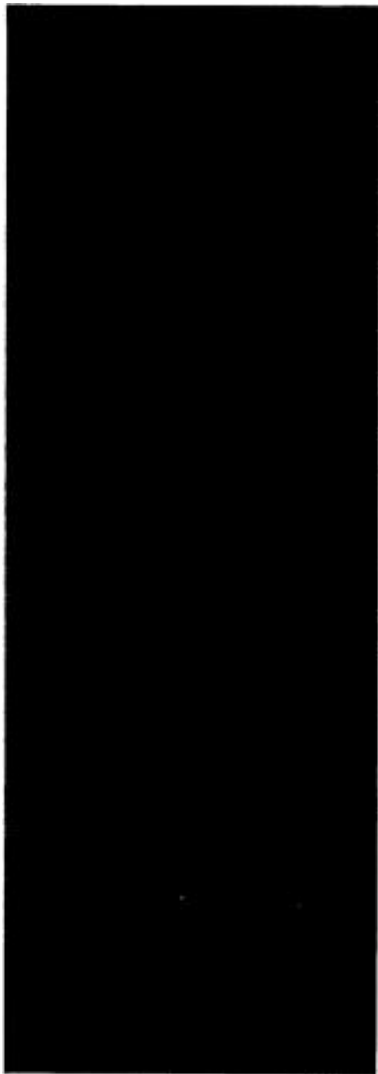

**It's time you
stopped squinting
and got a new
electronic stopwatch
by Electrodyne.**

That old clock, timer, or stopwatch of yours is certainly some sort of an anachronism in the midst of all your modern electronic gear. Besides that, it's getting just a little bit harder to read every year, now isn't it?

That's why we're bringing out our new electronic stopwatch. It times continuously up to an hour and forty minutes, reads out in minutes—in big, bright digits. And has just two controls—one for start/stop/reset, the other for power on/off. Completely self-contained in its own handsome Teak cabinet, this new electronic stopwatch by Electrodyne is readily rigged for remote control.

Our optional tape motion sensor lets you use it for direct timing of magnetic tapes—even at high speed.

We call this piece DC-900. You'll call it the best thing that's happened to timing since the sundial. Get one no later than Tuesday.

**ELECTRODYNE
CORPORATION**
7315 Greenbush Avenue ■ North Hollywood ■ Calif. 91605
Phone: (213) 875-1900 ■ Cable Address: "ELECTRODYNE"

You'll find exciting times at AES booths 11 & 12, Drop by!
Circle 31 on Reader Service Card

NEW PLUG-IN INPUT MODULE FROM UNIVERSAL AUDIO MODEL 2100



For complete processing
of a low-level audio
program signal

- 8 frequencies of equalization, 2dB steps of boost and/or cut
- three 20dB steps of input attenuation
- Reverberation-send (selectable before and after)
- Straight-line mixer attenuator
- Overload indicator light
- May be used alone as a +18dBm (max.) output amplifier
- Size: 2 1/8" W x 18" L x 7 1/2" Deep

Write for complete specifications.

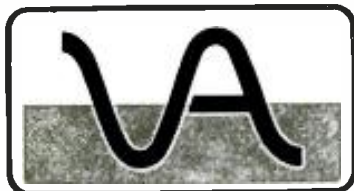

PRODUCTS OF **UREI**
11922 VALERIO STREET
NO. HOLLYWOOD, CALIF. 91605
TEL. (213) 764-1500

UREI UNITED RECORDING ELECTRONICS INDUSTRIES

Circle 36 on Reader Service Card

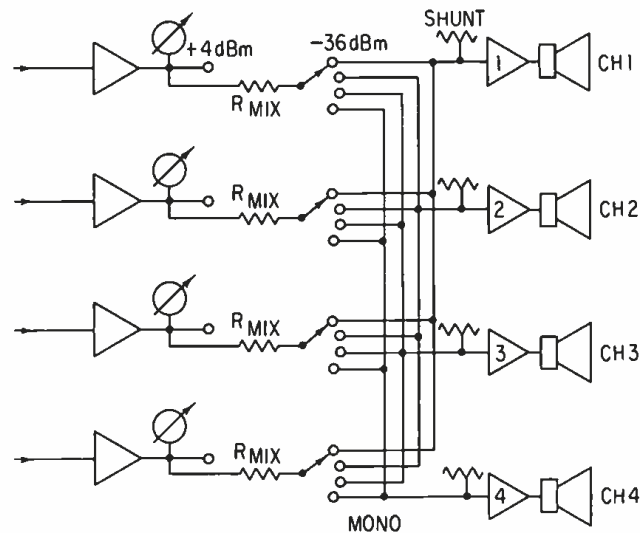

Figure 1. A block diagram of a four-channel console output circuit with monitoring.

through each mixing resistor should be adjusted by shunting the input to the amplifier so that this loss equals one half the desired amount of separation in dB.

(In this network, interchannel leakage is caused by the signal which travels from one channel through the mixing resistor to the input of the mixing booster amplifier, and from there to the other channels through the mixing resistors. Each time the signal travels through the mixing resistor, it loses 40 dB in level—consequently separation is double the loss of the mixing network.)

FIGURE 1 shows the output of a four-channel console with four monitor amplifiers. The switches provided can select individual feeds for each of the monitor amplifiers, or can combine the outputs of all four channels into one monitor channel. In addition, signals from the channels can be selected to feed only two or three selected monitors, offering total flexibility of the monitoring function. In many installations, three amplifiers are sufficient. All the existing channels in the console can be selectively combined in groups of three, two, or mono channels. Since the final product is usually two-channel stereo or one-channel mono, even *two* amplifiers may be adequate.

Look again at FIGURE 1. If all the monitor amplifiers have shunts low enough in resistance, they can accept one or all of the channels being switched without any significant change in level. Single-pole switches can be used for this switching. The actual value of the mixing resistors will be dependent on the number of channels and the amount of needed separation. The input impedance of the amplifier is also of consequence. If you use 100k ohm resistors and the input impedance of the amplifier shunted to the resistor is 1k ohm, then the loss of the signal will be approximately 40

dB with an interchannel leakage of 80 dB. Up to eight channels can be mixed this way without changing the mixing loss more than 1 dB.

When seven more channels are added to a single feed, the loading effects can be calculated this way: Seven 100k ohm resistors in parallel are 14.3k ohms. This impedance is parallel to the 1k ohm impedance of the amplifier input—producing a total impedance of 940 ohms. This is a reduction in level of the mixing network of approximately 6 per cent, a change of less than 0.5 dB.

The maximum separation of 80 dB is not an arbitrary figure. While more separation can be achieved, it should not be allowed since reduction of the signal below the mic signal level will inevitably lead to reduction in the signal-to-noise ratio.

A Post Office Directive

requires that all periodicals must be addressed including a zip code. This means—no zip code, no delivery. Please be sure that all correspondence regarding your subscription includes that zip number.

If you like Audiopaks our lubricated Audiotape will really be your cup of tea.

Broadcast engineers all over the country like our Audiopak® cartridges so much, we've been using their comments in our advertising. And, we've been giving each one an inscribed cup as a token of our appreciation.

Now, with our Audiotape Formula 17 Lubricated tape designed especially for continuous loop cartridges, their cup will really runneth over.

Here's why:

It provides excellent high end response and signal-to-noise ratio. The long wear, high temperature binder won't soften or gum up heads.

The lubricated coating is permanently bonded to the base. Can't wear off and cause jamming; won't dirty heads and capstans.

Very low abrasion properties reduce head wear and premature failure, assures smooth tape motion with negligible wow and flutter.

Audio is the only cartridge manufacturer who also makes tape. (We are the largest supplier in the world.) So, you can be sure our cartridges and our tape match each other perfectly. But regardless of cartridge make, Formula 17 is the best tape you can use.

Why not find out about Audiotape Formula 17 for yourself.

Audio Devices, Inc.
A SUBSIDIARY OF CAPITOL INDUSTRIES, INC.
235 E. 42nd St., New York 10017

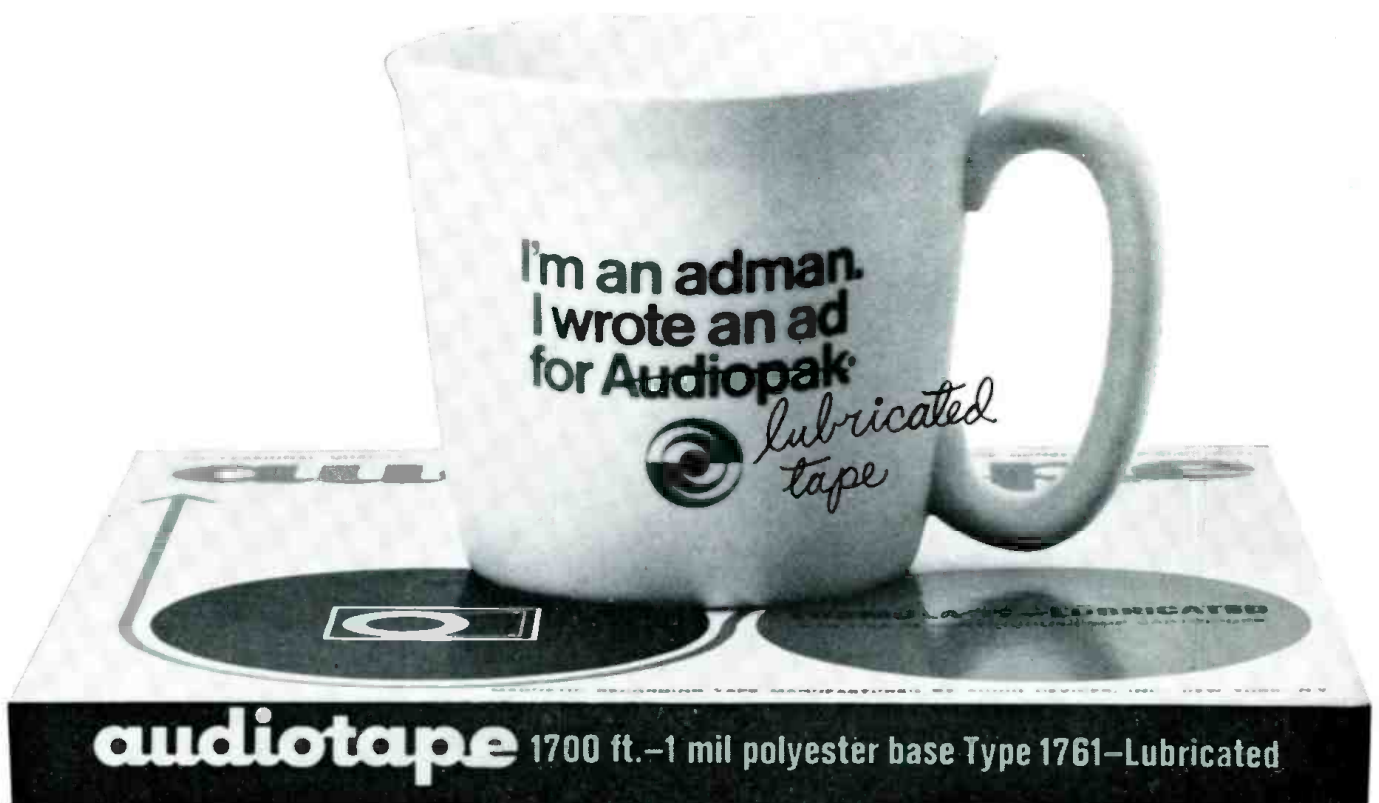

Circle 34 on Reader Service Card

Theory and Practice

NORMAN H. CROWHURST

●One of the things I am most frequently asked for, is a design for some form of electronic crossover. Years ago, of course, the only answer was a tube circuit. Now my correspondents want a transistor circuit, and for good reason: they take less space, don't need an additional power supply, cost less to put together, have less distortion, noise, etc. . . .

And the theory is, well, fairly simple. It depends on how sharp you want your roll-offs. If you want only 6 dB/octave, R-C networks will do the job, and the circuit doesn't really have to be electronic at all. Emitter followers to provide isolation of impedances provide a refinement that qualifies for the description *electronic* (FIGURE 1).

Here the components marked with asterisks determine crossover frequency. Other resistors are normal for emitter follower operation and capacitors with + signs attached are electrolytics, large enough not to cause any loss within the pass range.

But if you want your roll-offs at 12 or more dB/octave, the circuit must include some electronics, to provide feedback that will sharpen the turnover point. Some manufacturers have (in the past, at least) sold "electronic crossovers" that didn't do this and thus failed to do what they claimed. So we should first show why this doesn't work.

A single R-C combination provides a roll-off with 3 dB, 45 degrees at the turnover point, running into an ultimate 6 dB/octave slope. Using two

identical R-C combinations in cascade produces more than 6 dB loss at the turnover point, although the slope does eventually reach 12 dB/octave. At the 90-degree frequency, where each reactance is equal to its associated resistance, the attenuation is not 3 dB, or even 6 dB, but 9.54 dB.

Using three identical R-C combinations in cascade makes matters worse. Now the half-phase-shift point is at 1.077 times the frequency where reactance equals resistance (per stage) and the loss at this frequency is not 3, or 9 dB, but 17 dB.

Using four identical R-C combinations shifts the half-phase frequency by a factor of 1.194, and makes the attenuation at this point 23.8 dB. FIGURE 2 shows the responses obtained in this way.

I don't know what those manufacturers did about this, but I suspect they compromised. Possibly they found the frequency where loss *was* 3 dB in each network (hi- and lo-pass) and matched these points in the opposing networks.

Doing this, the phase shift at this point, for two stages, is 52.5 degrees, not much more than the single stage.

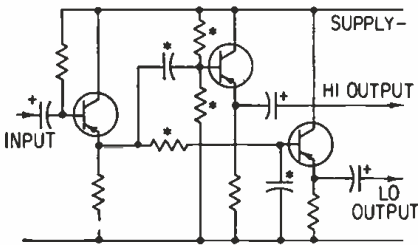

Figure 1. An emitter-follower output for a 6 dB/octave R-C filter. The circuit serves to isolate impedances.

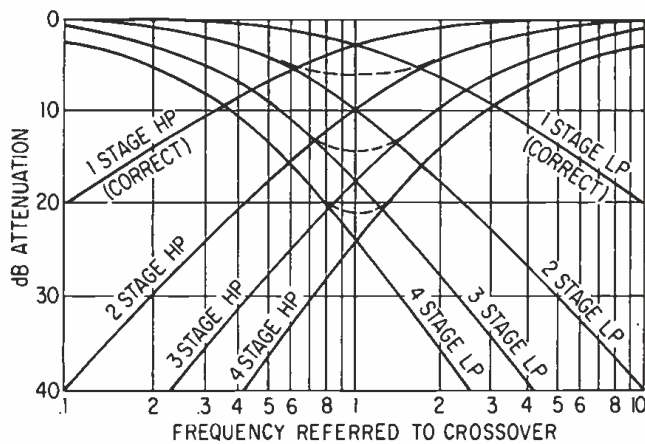

Figure 2. In this set of curves the effects of multiple R-C networks in cascade are shown. The dashed curves in the center are combined o.f. for 2-, 3-, or 4-stage (in descending order).

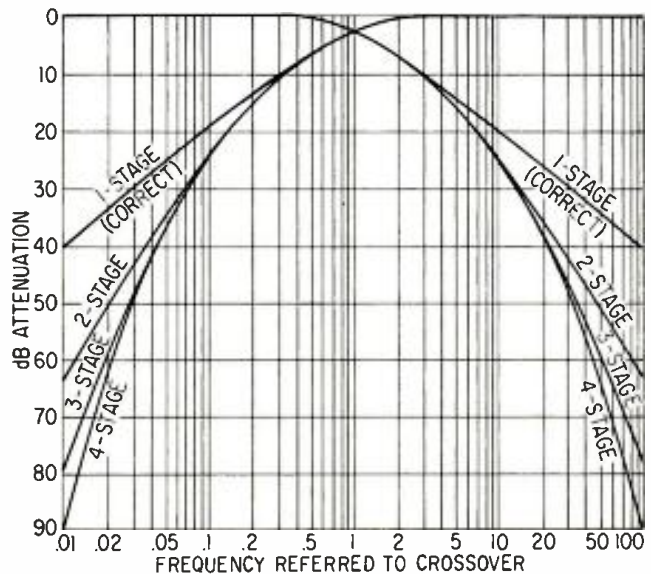
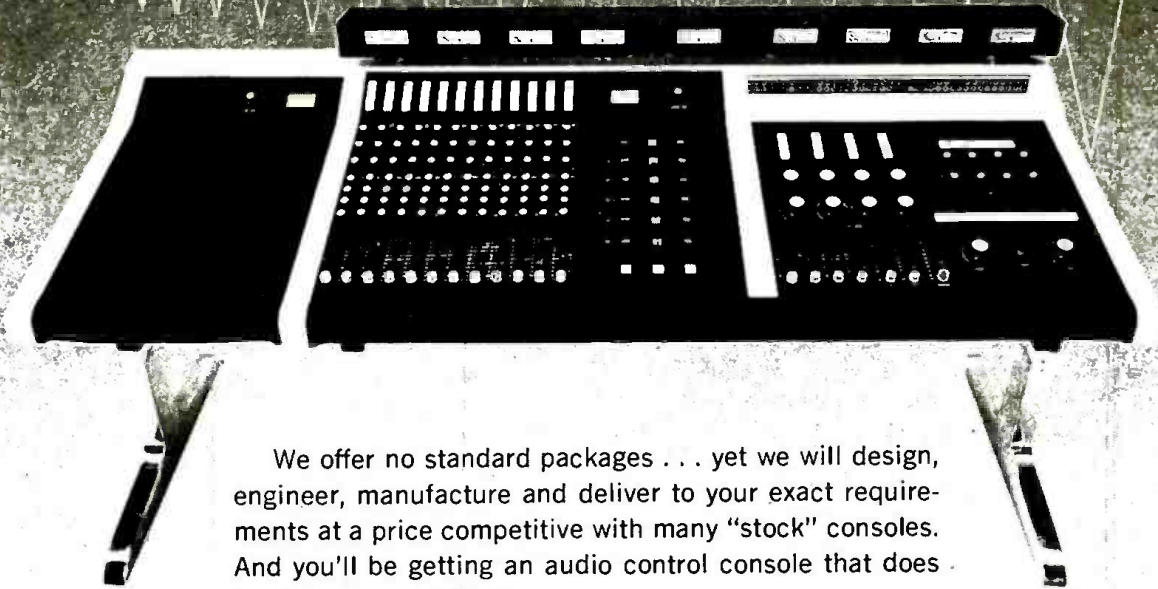

Figure 3. Frequency has been shifted so that the 3-dB points match, but results are not yet satisfactory.

ANOTHER
CUSTOM DESIGNED CONSOLE
BY
AUDIO DESIGNS



We offer no standard packages . . . yet we will design, engineer, manufacture and deliver to your exact requirements at a price competitive with many "stock" consoles. And you'll be getting an audio control console that does the job you want it to do.

Audio Designs' consoles feature integrated quality components; attractive furniture styling; modular construction; minimum space requirements; flexibility of total patching; complete monitoring facilities; and other unique innovations.

Write or call for details and estimates on your console requirements.

components & consoles

**AUDIO
DESIGNS**
and Manufacturing, Inc.

COMPACTABILITY

STEREO STUDIO IN AN ATTACHÉ CASE



A Six Channel Portable Mixer to Help You Get the Show on the Road

Now . . . a mixer for professional use that weighs only 25 pounds—in a case measuring 18" x 12 1/4" x 5 1/4"! Can be carried anywhere. Great for "remotes". An excellent standby system. Low price but no sacrifice in quality. Ideal for colleges.

THE MODEL 1800 AUDIO LIMITER

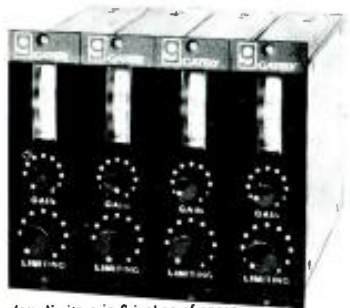

four limiters in 6 inches of space

Unsurpassed for Price . . . Quality . . . Compactness . . . and Performance

At last . . . build full control into the console itself with Model 1800 Audio Limiters, protecting every input against unexpected peaks and permitting the amount of limiting on each channel to be controlled. Only 1 1/2" x 5 1/4" x 7". Exceeds rack-mounted limiters in performance.

GATELY ELECTRONICS

57 WEST HILLCREST AVENUE
HAVERTOWN, PENNA. 19083
AREA CODE 215 • HI 6-1415
...have you checked Gately lately?

See us at the AES Show — Booth 55

Circle 35 on Reader Service Card

The slope is about the same too, because the frequency is 0.374 of the half-phase-shift point. Although the network is called 12 dB/octave, because that slope is eventually reached, at 4/10 or 2 1/2 times cut-off, respectively, for hi- and lo-pass, it has only reached 6 dB/octave. It's little better than the single stage, except that, a long way beyond cut-off frequency, the steeper slope is eventually reached.

The same can be said for the three and four stage networks. FIGURE 3 shows responses when this shift is made. The two-stage circuit shows no improvement over the single stage till well beyond an octave. The three-stage

shows no improvement over the two-stage till about a decade beyond crossover. And the four-stage shows no improvement over the three-stage until more than 1.3 decades (20:1 frequency ratio) beyond crossover.

But something else can be done, with slight improvement. This extra loss is caused because of interaction. The last capacitor in the lo-pass network is shunting, not just its own resistor, but the cumulative impedance effect of previous stages.

To overcome this, interaction can be reduced, either by inserting buffer stages, which can be merely emitter followers, or by value-shifting. If the

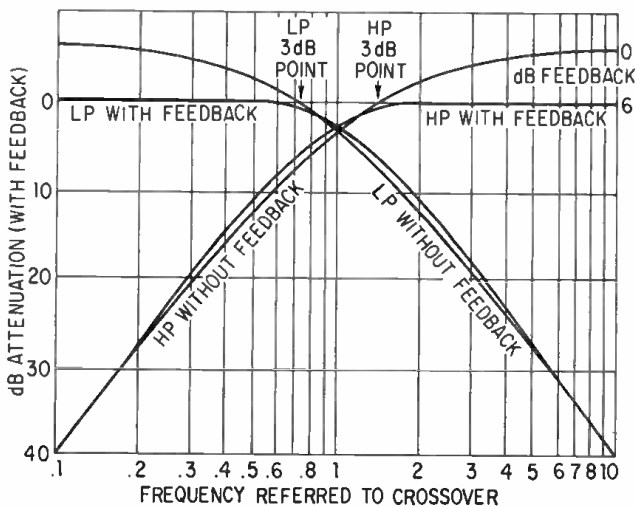

Figure 4. In a real electronic crossover, feedback sharpens the crossover point.

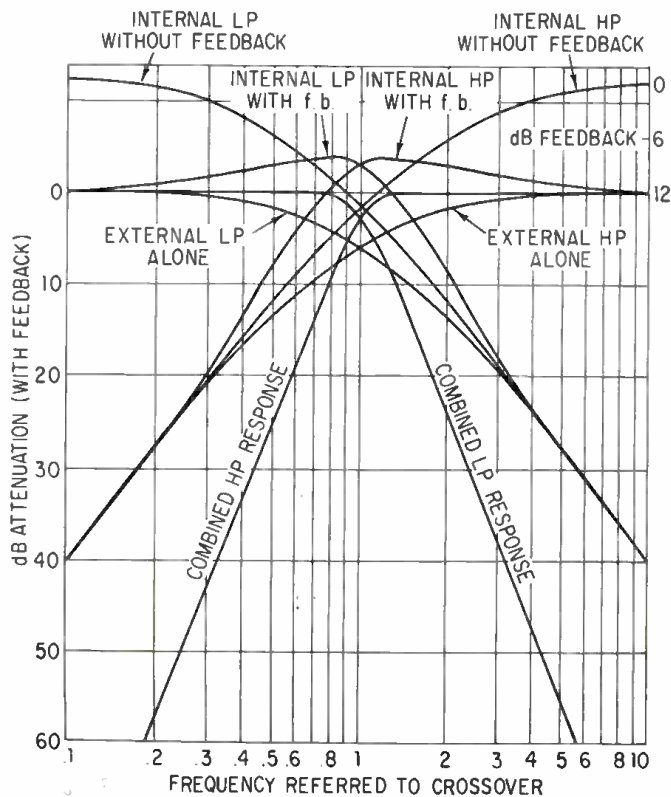

Figure 5. Sharper results are achieved with a four-stage two-roll-off inside the feedback loop and two roll-offs outside it.

get the turntable a studio needs
...and rek-o-kut durability, too!



There's hardly an engineer in the broadcast field that hasn't used a Rek-O-Kut turntable in his career. Rek-O-Kut has been building studio turntables for over a quarter century. So you are assured of buying top quality sound reproduction along with the ruggedness and durability that broadcast and commercial installations demand. The rim drive Rek-O-Kut B-12H by Koss Electronics permits slip cueing without sacrificing fidelity. And your Koss/Rek-O-Kut will last and last with a minimum of maintenance and repair. Write for complete details on the popular Model B-12H or the 16" studio B-16H today.

specifications:

SPEEDS: 33 $\frac{1}{3}$, 45, 78 rpm. NOISE LEVEL: — 59db below 5 cm/sec average recorded level. MOTOR: custom-built computer type heavy-duty hysteresis synchronous motor. 45 RPM HUB: instantaneously removable by hand. PILOT LIGHT: neon light acts as an "on/off" indicator. FINISH: grey and aluminum. DECK DIMENSIONS: 14 x 15 $\frac{1}{16}$ ". Minimum Dimensions: (for cabinet installation) 17 $\frac{3}{4}$ " w. x 16" d. x 3" above deck x 6 $\frac{1}{4}$ " below. PRICE: B-12H Turntable \$175. S-320 Tonearm \$44.95. Optional BH Base for audition room \$18.95.



Rek-O-Kut Turntables by

KOSS

Koss Electronics Inc., 2227 N. 31st St., Milwaukee, Wis 53208
Export Cable: STEREOFONE • Koss-Impetus/2 Via Berna/Lugano, Switzerland

Circle 40 on Reader Service Card

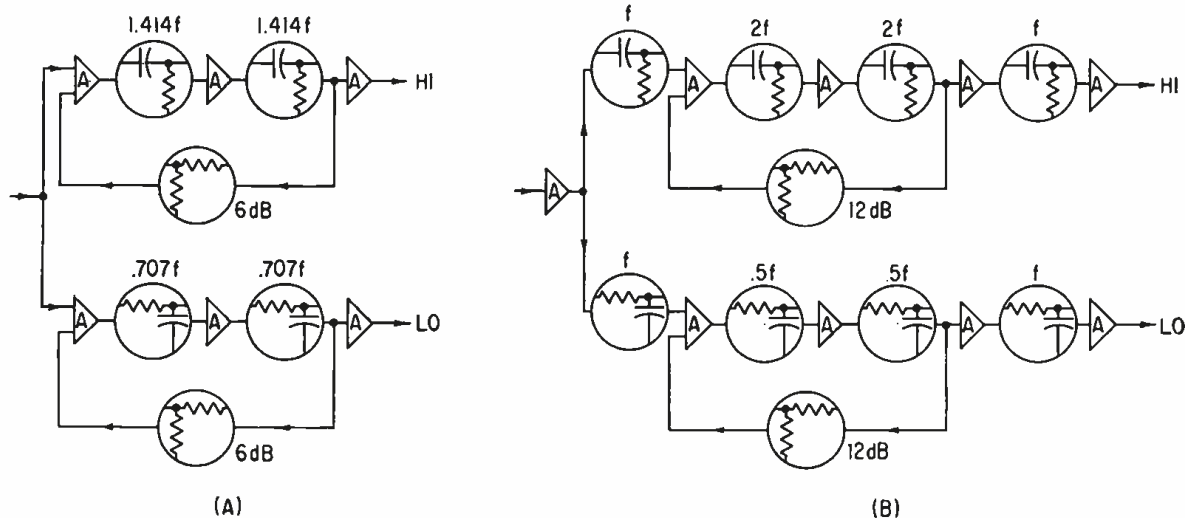

Figure 6. Block diagrams of two circuits. In (A) the method of Figure 4 is used, while (B) uses the method of Figure 5.

same turnover frequencies are used, but the R-C values changed by 10:1 ratio, so each stage does not materially load the one before it, almost independent action is obtained.

Doing this, the two-stage causes 6 dB loss at half-phase point, the three-stage 9 dB, and the four-stage 12 dB loss. This is still too much. Frequency can again be shifted, so the 3 dB points match but the result is little better than the results shown in FIGURE 3. We have tabulated the results for a lo-pass network of various combinations. For the hi-pass, frequencies are the reciprocals of those shown. The best compromise obtained this way is still a long way from theory.

The only real electronic crossover uses feedback to sharpen up the turnover point. If two identical roll-offs are used, without interaction, and then 6 dB of feedback is applied, then the frequency is changed by 1.414:1 and the half-phase point is 3 dB at 90 degrees (FIGURE 4).

If you want something sharper than this, the easiest way is to go to a basic four-stage, with two roll-offs inside the

feedback loop, and two outside it. The two inside roll-offs should act an octave before the desired final turnover: the lo-pass an octave below and the hi-pass an octave above the intended crossover frequency.

Then 12 dB feedback will push these roll-offs together and cause a 3 dB boost at crossover in each. Adding two roll-offs outside the loop, each acting at crossover frequency, brings the over-all response to 3 dB loss with half-phase-shift at crossover frequency (FIGURE 5).

Expressed in theory like this, design seems relatively simple. We have found a theoretical way of offsetting interaction. The two circuits are shown in block form at FIGURE 6. But when we apply the principle to practical circuits, we can still get into trouble. Two things can get overlooked, especially with transistorized versions.

The first is in the forward transmission path. With tube amplifiers, we have become accustomed to thinking of an amplifier stage as providing isolation, as a buffer. The plate circuit produces an amplified version of the grid signal voltage, and the impedances in

the grid and plate circuits do not interact, or it's relatively easy to offset any interaction effects there may be.

This is not true in transistor circuits. The current gain of a transistor depends on collector and base impedances. As the reactance of the capacitor used for producing roll-off is part of the impedance in the collector load, and in the base circuit, it causes the current gain to vary with frequency.

If it reflected linearly, this interaction could be compensated by providing a different amount of feedback. But the reflection is not linear. So the equivalent circuit is not like any simple network, interacting or non-interacting, containing just the two capacitor elements. As a result, it can readily prove impossible to get the correct response, whatever amount of feedback is applied.

The second effect is one that we may have encountered in tube circuit designs of a similar type. The feedback to get the right response sharpening at crossover uses a resistor. Within the pass, or active range of the filter, signal is fed back through this resistor, from output to input, and our theory is based on signal feed in that direction. But the resistor doesn't know which way signal is supposed to go.

As frequency takes the circuit further into its cut-off region, the signal at the end of this resistor connected to the input eventually gets to be bigger than that at the end connected to the output, with the result that signal feeds through the resistor forwards, instead of through the capacitors and the stage of amplification. This effect limits the bottom of the roll-off, so it ceases to go down at 12 dB/octave, and levels off.

We'll deal with these and other problems encountered in practice when we come to specific transistor circuits, which we will discuss in the next issue.

TABLE I

Characteristics of multistage R-C networks as crossover filters

Kind of Circuit.	Half-phase-shift point		Half power point		
	Rel. Freq.	Loss dB	Rel. Freq.	Phase shift	Slope dB/oct
2-stage, identical	1	9.5	0.374	52.5°	3.09
2-stage, non-interacting	1	6	0.643	65.5°	3.5
3-stage, identical	1.077	17	0.196	55.3°	3.09
3-stage, non-interacting	1	9	0.51	81.05°	3.7
4-stage, identical	1.194	23.8	0.1182	56°	3.09
4-stage, non-interacting	1	12	0.435	94°	3.88
Correctly designed feedback filters for comparison.					
2-stage	1	3	1	90°	6
3-stage	1	3	1	135°	9
4-stage	1	3	1	180°	12

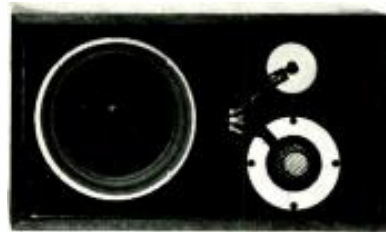
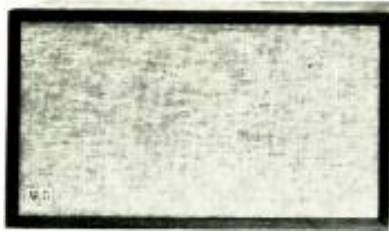

the AR-5

a new addition to the AR family of speaker systems

In October, 1967, after nine years of experimentation and development, Acoustic Research introduced the AR-3a speaker system. It is the best speaker system we know how to make, regardless of price. The most important innovations in the AR-3a are two new hemispherical speakers which provide very smooth mid- and high-frequency response, together with what one reviewer called "virtually perfect dispersion." These two hemispherical speakers have now been combined with an entirely new 10-inch woofer to make the AR-5, a speaker system almost as good as the AR-3a at a price about \$75 lower. The main difference between the two systems is that the AR-3a response extends approximately one-third octave lower.

The cone of the AR-5 woofer is molded by a new low-vacuum process developed especially for Acoustic Research. The unusual cone texture which results reduces greatly the tendency toward coloration heard in conventional molded cones of paper or polystyrene. At the cone's outer edge is a new suspension, molded of urethane polymer. The cone itself has a compound curvature which is new, it is in a new housing, and the voice coil attached to it is slightly larger and longer. These internal improvements are complemented by a low 650 Hz crossover frequency made possible by the wide range of the AR hemisphere used for mid-frequencies. The crossover network is of the same type as is used in the AR-3a, and uses 100 mfd of highly reliable paper-dielectric capacitors. The two level controls are fully compatible with transistor amplifiers at all settings, as are the controls of all AR speaker systems.

The AR-5 is priced from \$156 to \$175, depending on cabinet finish, and is exactly the same size as the AR-2x and AR-2ax: 13½" x 24" x 11½" deep. Impedance: 8 ohms.

Please write to us for technical data and descriptive literature.

ACOUSTIC RESEARCH, INC., 24 Thorndike Street, Cambridge, Mass. 02141

Circle 38 on Reader Service Card

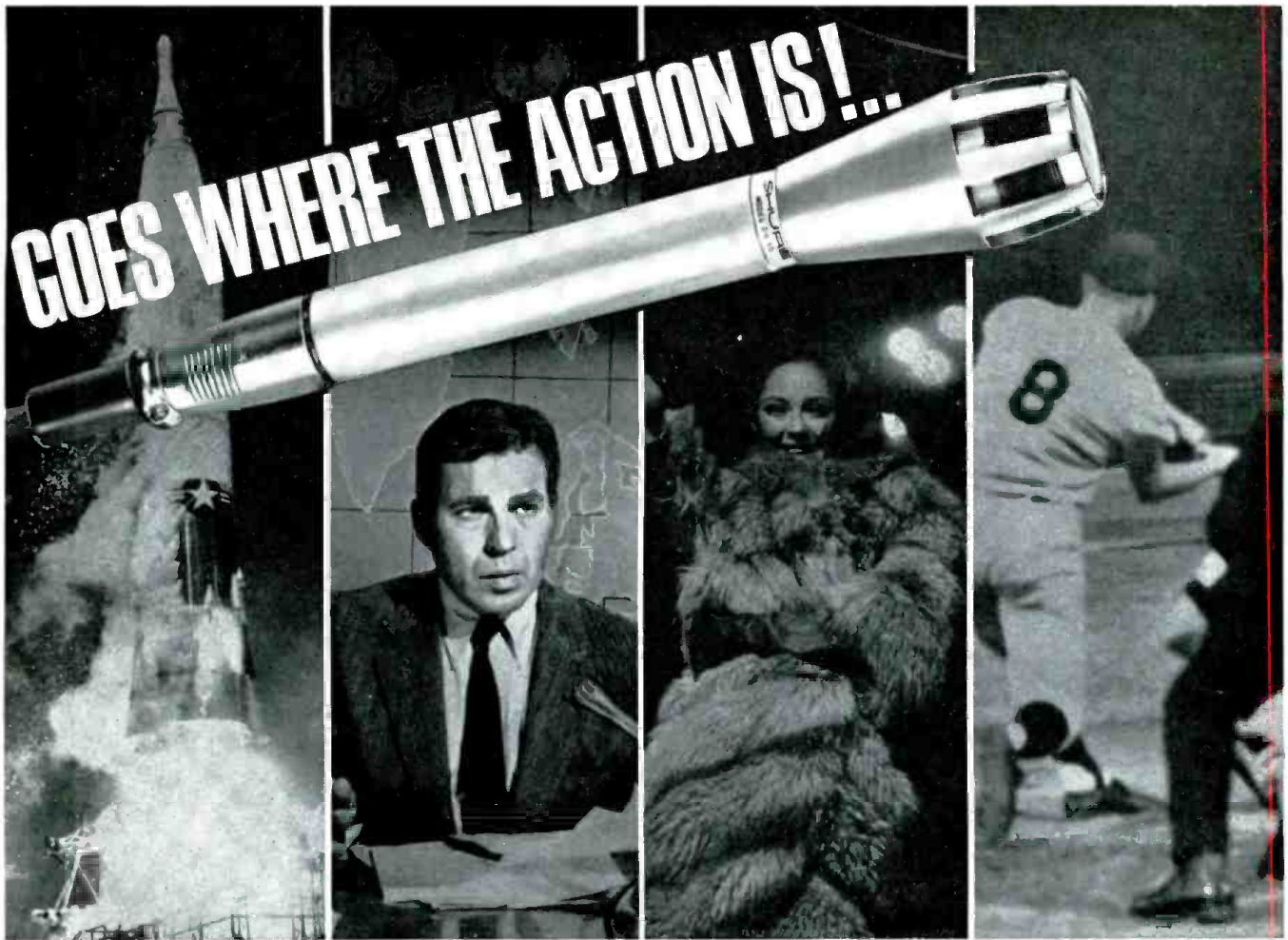

GOES WHERE THE ACTION IS!...

The SM60 cannot be stereotyped—is equally at home in the studio or in the field—stand-mounted or hand-held—in uses as diverse as outdoor sporting events and elaborate variety shows. Small wonder that audio engineers have called it one of the most versatile omnidirectional dynamics they've ever encountered, for the SM60 is a unique combination of good-looks, strength, performance and economy.

The smooth, wide-range response provides cleanest, natural reproduction of both speech and music. A very effective built-in wind and "pop" filter protects against undesirable effects of close-talking.

Lustrous, non-glare metallic finish and tailored-to-the-

hand dimensions provide striking on-camera appearance and superior handability. Specially reinforced machined-steel case front is designed to take abuse that would ruin other microphones—you can drop it on its nose without damage to the internal structure! Efficient windscreen and front end are *quickly* and *easily* removable for cleaning.

Best of all, it is priced competitively with conventional "workhorse" microphones. Why not check out an SM60 now? See your Shure Professional Products Distributor, or contact Mr. Robert Carr, Manager of Professional Products Division, Shure Brothers, Inc., 222 Hartrey Ave., Evanston, Ill. 60204—Phone 312 - 328-9000.

SHURE SM60

VERSATILE OMNIDIRECTIONAL DYNAMIC MICROPHONE

THE LAST WORD IN WEARABLE LAVALIER MICROPHONES... BY SHURE



Specifically designed for radio, TV, motion pictures... matches well in sound with stand or desk mounted units. Smoothly-contoured, machined-steel case and recessed grille for minimum clothing noise. Exclusive snap-in mounting of microphone for greater convenience, security. "Positive Lock" lavalier goes on in an instant—provides simple, noiseless position adjustment. Extra-flexible, kink-free rubber cable is easily replaceable.

MODEL SM51 DYNAMIC LAVALIER

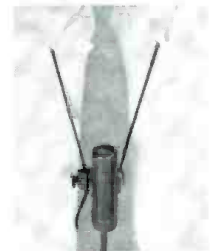

© 1967 Shure Brothers, Inc.

Circle 39 on Reader Service Card

Editorial



THERE HAS BEEN CONSIDERABLE MAIL since the publication of the April Editorial on the subject of symbol standardization. Many have opted for keeping those symbols in common usage. On the surface, the logic for continuation is persuasive. Some of the symbols are eminently logical in their clarity — why change to something that is not immediately definable?

Two points refute this argument. First, English is not the language of the world, while audio is a world-wide field. Arguments for retention of the old system cannot be accepted on the basis of chauvinism.

The other point is that audio is only *one* engineering field. It is time for us to realize that the new SI standards make it possible for the mechanical engineer to understand immediately what has been done by the electronic engineer. We no longer live in isolation from other engineering fields. A single unified system of symbols will end misunderstandings and wasted time when one engineer must look over the shoulder of a man from another field.

We hope the publication in this issue of several letters urging adoption of SI standards are studied carefully. And, on page 22, we have published a paper by John G. McKnight that discusses converting to SI standards.

We will use SI standard symbols in our editorial format. And we urge adoption without qualification of the SI standards by all in professional audio.



Once again, with special warmth, **db** welcomes the New York AES Convention. Last year's gathering marked our debut, and we hope each anniversary will bring continued growth to all our friends in this great industry.

Biassing Considerations in Magnetic Tape Recording

SIDNEY L. SILVER

The correct bias setting has a profound effect on the quality of the final recording. The author covers the determinations and settings that result in a recording that is correct according to its use.

IN MAGNETIC TAPE RECORDING, an a.c. bias signal and the program material to be recorded, are combined by a linear mixing arrangement and simultaneously impressed upon the recording head. This type of mixing is not amplitude modulation (in which new sum and difference frequencies are generated), but is rather a simple adding process. The actual signal recorded on the tape is in the form of a permanent remanent magnetization which occurs after the tape is pulled away from the magnetizing force. Since the recorded wavelength of the high frequency bias is too small to be resolved by the reproducing head, the bias frequency is not picked up in the playback mode; its primary function being to ensure that the recorded signal remains on the linear portion of the magnetization curve.

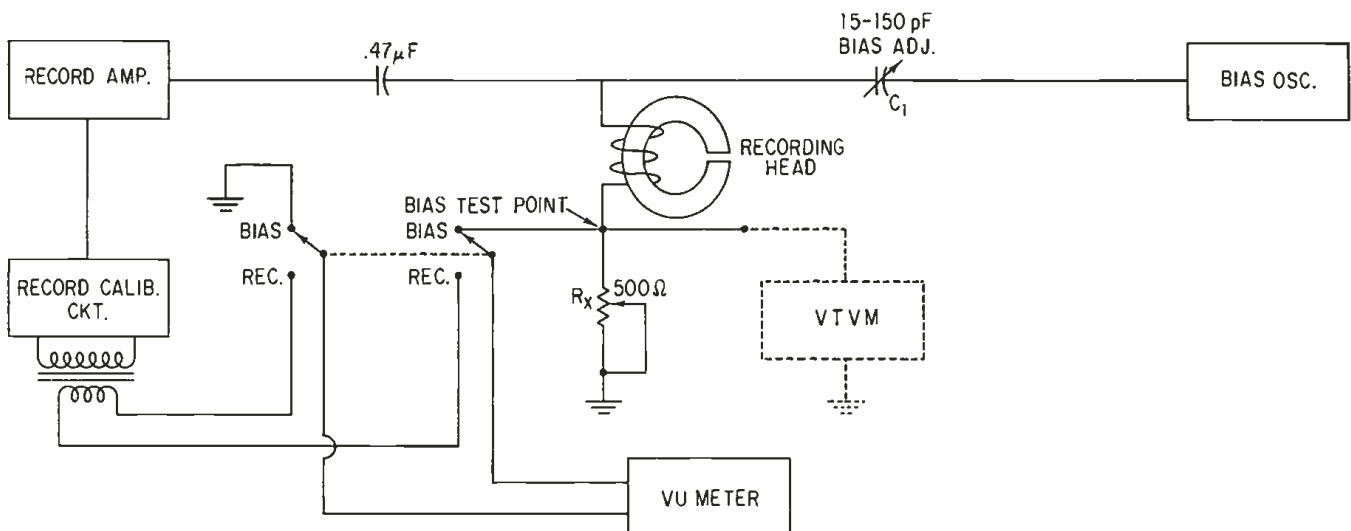

Figure 1. The typical arrangement for measuring bias current.

With this brief introduction to the biasing function, we now launch into one of the most important, as well as controversial aspects of magnetic tape recording, namely the subject of optimum bias current and its relation to ultimate quality in tape recorder performance. The determination of proper bias level is vitally linked to the achievement of the best practical compromise between high signal-to-noise-ratio, wide frequency response, and minimum distortion. These electrical parameters are, for the most part, mutually conflicting so that the optimization of any one requirement can be obtained only at the expense of the others.

If reducing the distortion level were the primary consideration, for example, the bias current could be increased, but this might involve high-frequency losses too great to compensate by treble boost without overloading. Alternatively, lower distortion could be obtained by reducing the maximum permissible recording level, but this would mean, in effect, a lower signal-to-noise ratio. If it were desirable to extend the high frequency response, the bias current could be reduced. This, however, would increase the distortion unless the recording level was reduced which, in turn, would again result in a lower signal-to-noise ratio. Finally, if increasing the signal-to-noise ratio were the only consideration, the maximum permissible recording level could be raised but this would involve more distortion. To avoid this condition, the bias current could be raised but this would attenuate the treble response.

Another important consideration is that the true peak energy recorded on tape is a complex quantity which varies with the nature of the program material. This makes it difficult to set the maximum tolerable level of a system before the audible effect of distortion due to (for example) overloading occurs. Effectively, the listener must determine whether it is preferable to accept occasional high-distortion peaks in exchange for a relatively high recording level, and hence a significant improvement in signal-to-noise-ratio. Stating the problem in another way, it must be decided whether it is expedient to set the recording level so that peak passages recorded at a particular distortion level for a brief period of time would have no adverse effect on the listener. Clearly, these interrelating factors involve a number of subjective judgements which are difficult to express in quantitative terms, and which can best be resolved on the basis of listening tests.

BIAS CURRENT MEASUREMENT

A primary consideration is that the bias oscillator generate a sine wave with negligible distortion, in order to keep noise at a minimum. If the bias waveform has even-order harmonic distortion, for example, an effective d.c. component is produced which corresponds to the difference in amplitude between the positive and negative portions of the waveform. This would leave an undesirable d.c. flux on the tape resulting in a noisy recording. In addition to the regular a.c. bias, some professional recording machines inject a d.c. bias into the record head to null the second harmonic distortion, thus

Sidney L. Silver is with the United Nations Telecommunications Section in New York City.

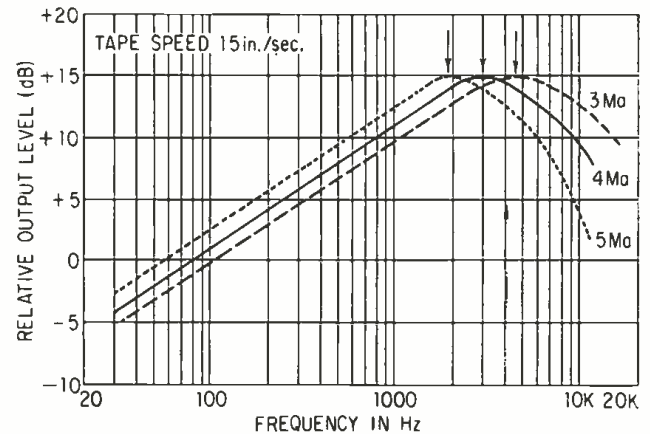

Figure 2. This is the effect of bias current on frequency response in an unequalized system. The arrows indicate frequency at maximum output level.

eliminating low-frequency noise. In this arrangement, provision is made for adjusting both the amplitude and polarity of the d.c. bias in order to compensate for any asymmetry of the bias waveform.

FIGURE 1 shows a typical method employed in measuring the bias current of a professional tape recorder. Here the bias adjustment, C_1 , is peaked for maximum playback output while recording a specified frequency at normal operating level, usually 1000 Hz at 15 in./sec. tape speed. Sometimes the procedure calls for increasing the bias current until the output falls about 1 or 2 dB below maximum. Since the recorded wavelength is equal to the *tape speed* divided by the *frequency*, a test frequency of 500 Hz can be used if it is desired to record at 7.5 ips.

In many tape recorders of professional quality, the bias level can be checked by switching the regular VU meter to a

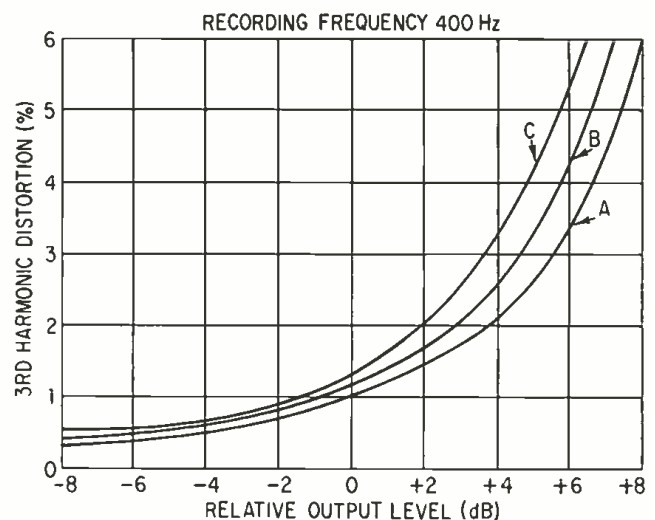

Figure 3. Distortion as a function of output level at various bias currents. Curve A is 5 mA (1 dB above peak bias); Curve B is 4 mA (peak bias); and Curve C is 3 mA (1 dB below peak bias).

variable calibration control (R_x in FIGURE 1), connected between the record head and ground. In this position, the calibration pot is preset so that 0 VU corresponds to the correct bias. The meter, of course, does not provide an absolute reading but merely indicates the bias level in relative terms. To measure the actual bias current, a convenient test point is provided at the junction between R_x and the record head. Initially, it is necessary to determine the effective resistance between the test point and ground. Using a sensitive vtm, the voltage across R_x is measured in the record mode with no audio signal present in the record head. Bias current can then be calculated by means of Ohm's Law, namely $I = E/R$. For example, if 400 mV maximum is measured across 100 ohms, the peak bias current is equal to 4 mA. The presence of R_x in the circuit does not appreciably affect the results of the measurement since it offers negligible resistance to the record head, compared to the relatively high impedance of the head to the bias-current frequency.

It must be pointed out that bias current can vary as much as 2 dB among tapes of different brands, and also among different types within the same brand. In critical applications, therefore, the bias level should be checked each time the tape is changed, particularly when a master tape is being recorded.

EFFECT OF BIAS LEVEL ON FREQUENCY RESPONSE

One of the major problems in magnetic tape recording is to maintain a smooth frequency response from the very low frequencies to the upper limit of the audio range. However, when maximizing frequency response to, say, 15 kHz, the bias current must be set at the correct value to achieve a satisfactory balance between extended treble response and low distortion. Unfortunately, if the bias level is of sufficient magnitude the record head acts in a manner similar to an erase head, particularly at high frequencies. As the bias current is increased, further treble losses occur due to partial erasure, and such losses grow more serious as the tape speed is reduced.

A simple alternative that can be taken to preserve high-frequency response is to decrease the bias level, thereby eliminating the need for excessive treble boost. In fact, to maintain full frequency response at lower tape speeds, somewhat smaller amounts of bias current are sometimes used than are necessary at higher speeds. A limit is imposed, however, since an undue reduction of bias results in a sharp increase in distortion.

FIGURE 2 shows the effect of bias current on frequency response. These curves, obtained with a constant audio recording current, are plotted with the peak output, in each case, adjusted to be substantially equal. It can be observed that as the frequency increases, the output level rises gradually to a peak and then rolls off at a more rapid rate. In general, the higher the bias current the poorer the high-frequency response in relation to the low frequency response.

EFFECT OF BIAS LEVEL ON DISTORTION

A principal requirement in determining the relationship between bias level and distortion is the selection of a suitable

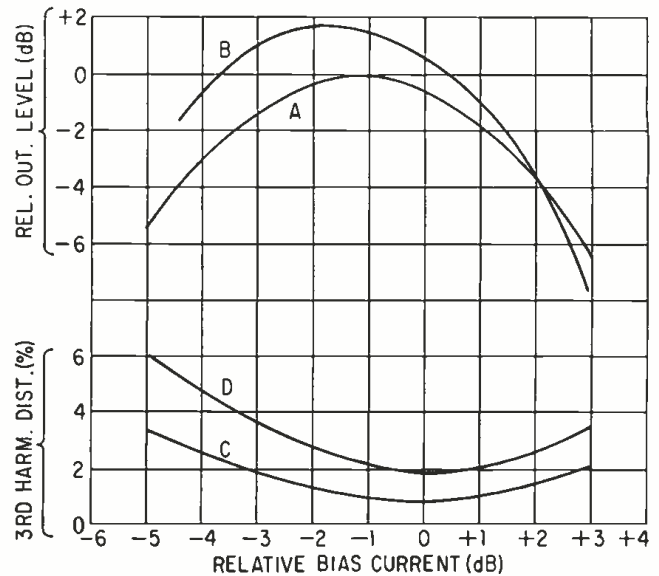

Figure 4. Variations of sensitivity and distortion with changes in bias current at 15 in./sec. Curve A — output vs bias level at 1000 Hz; Curve B — output vs bias level at 15 kHz; Curve C — distortion vs bias at normal operating level; Curve D — distortion vs bias 3 dB above normal operating level.

instrument for measuring bias current at different amplitudes. For this purpose, the harmonic analyzer is commonly used for the quantitative measurement of total harmonic distortion (thd). Here a tunable notch filter in the analyzer suppresses the fundamental frequency, so that the amplitude of the remaining distortion components can be measured simultaneously. The percentage distortion is defined as 100 times the ratio of the rms sum of the harmonics to the fundamental. Unfortunately, the thd analyzer is influenced by tape noise and modulation noise, which affect the actual distortion reading.

A more versatile instrument in tape recorder measurement is the wave analyzer which can provide information concerning each harmonic and intermodulation product of the input signal. This instrument incorporates a narrow-band filter tuned to select and measure the magnitude of individual distortion components, one at a time. To check distortion with the wave analyzer, a 400 Hz signal is recorded on blank tape at normal operating level. On playback, the odd and even harmonics are evaluated. Generally, the second harmonic distortion reading should not exceed 0.5 per cent, assuming that the bias waveform is symmetrical and the record head is not magnetized. The third harmonic distortion reading, which is dependent upon the proper bias setting for a particular type of tape and the accuracy with which the normal operating level is adjusted, should not exceed 1 per cent.

To evaluate the effect of bias current on distortion, the relationship between output level and the third harmonic content is shown in FIGURE 3. Using a recorded frequency of 400 Hz, the recorder input voltage is varied and curves are plotted for the bias current distribution around the peak bias

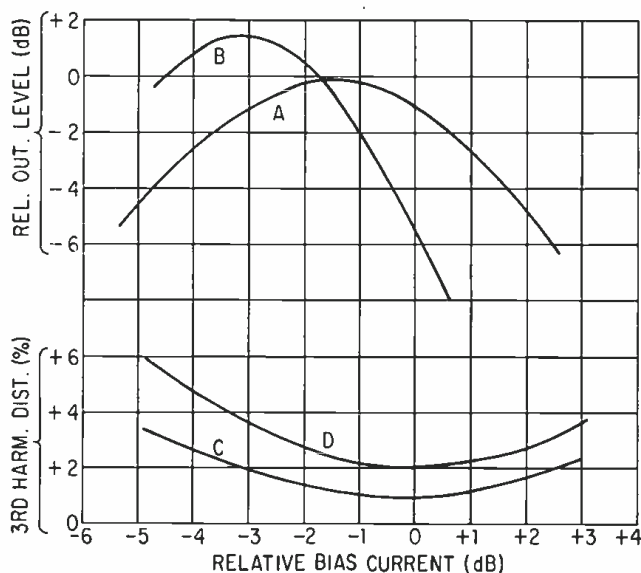

Figure 5. Variations of sensitivity and distortion with changes in bias current at $7\frac{1}{2}$ in./sec. Curve A — output vs bias level at 500 Hz; Curve B — output vs bias level at 15 kHz; Curve C — distortion vs bias at normal operating level; Curve D — distortion vs bias at 3 dB above normal operating level.

current. It can be seen that as the recorded signal is increased, distortion rises gradually until a reading of about 3 per cent is obtained. Beyond this point, tape saturation is reached and distortion accelerates rapidly with a further increase in signal level.

One of the primary reasons for making distortion measurements is to establish the correct recording level. In general practice, professional tape recorders are rated on the basis that the rms third harmonic distortion does not exceed 3 per cent at peak recording level. Peak recording level is defined as the maximum permissible recording amplitude, which is considered to be 6 dB higher than normal operating level. This 6 dB allowance provides a safety margin to compensate for the fact that dynamic program peaks tend to be quite higher than average signal levels. Thus, since program material is of a complex and transient nature, the VU meter indicates a level considerably below the instantaneous peak program level.

Signal-to-noise ratio is computed from the peak recording level so that if the measured noise level is, say, -50 dBm, we add 10 dB to that figure (assuming that the VU meter is so calibrated that 0 VU corresponds to $+4$ dBm normal output level) to obtain an actual signal-to-noise ratio of 60 dB. At the present state of the art, a tape recorder that can achieve a signal-to-noise ratio of 60 dB or more (based on a maximum recording level producing 3 per cent third harmonic distortion at 400 Hz) may be rated as excellent.

DETERMINATION OF OPTIMUM BIAS CURRENT

A useful method employed in finding the proper bias level for a particular system is to plot a number of curves com-

paring the effect of bias current variations on a low reference frequency with that of the highest frequency of interest. The significance of these changes are then evaluated in terms of distortion readings at different recording levels. Based on these evaluations, the correct bias current can be chosen which conforms to the individual's idea of a satisfactory combination of frequency response, distortion, and signal-to-noise ratio.

First, let us consider the case where the tape recorder operates at 15 in./sec. tape speed. In FIGURE 4, the reference frequency of 1000 Hz is represented by curve A and the high frequency, 15 kHz in this case, by curve B. The audio current to the record head is kept sufficiently low to avoid the possibility of saturation. Curve C indicates the effect of bias current on distortion using an input recording level (considered to be normal) which results in 1 per cent third harmonic distortion at 0 dB bias. Finally, curve D is based on an input level (3 dB higher than normal) which produces 2 per cent distortion at the same bias setting. Here 0 dB bias current is arbitrarily designated as the relative bias level which results in minimum distortion. Since the amplitude of the recorded signal varies with the bias current, the input level is constantly adjusted, when plotting curves C and D, to hold the tape output at a fixed level.

It can be observed that a flat frequency response out to 15 kHz can be obtained by setting the bias level to about 2.5 dB where curves A and B intersect. At this point, sensitivity drops 4 dB from maximum at the reference frequency, and, according to curve C, distortion rises to approximately 1.6 per cent. A better procedure to follow, therefore, is to set the bias for minimum distortion, which drops the sensitivity less than 1 dB from maximum; then lowering the treble boost about 1 dB at 15 kHz. The final determination of the amount of high frequency boost would depend on a frequency run, in order to detect any peaking at the lower treble frequencies. Should peaking occur, it would be necessary to drop the frequency response at 15 kHz so that the flattest possible response can be achieved over the entire treble range.

To obtain a satisfactory response at 7.5 in./sec., the bias current would have to be reduced below the quantity corresponding to minimum distortion bias. As shown in FIGURE 5, the 15 kHz response (curve B) is 6 dB below the 500 Hz reference, at the minimum distortion point. If we assume that curve B is based on the maximum amount of treble boost which can be safely used without overloading, then it is necessary to decrease the bias level in order to maintain the response out to 15 kHz. This can be accomplished by reducing the bias level to about -1.7 dB, which represents the point where curves A and B intersect. Unfortunately, at this bias setting, the distortion level rises to about 2.8 per cent for the signal level indicated by curve D. By reducing the signal level to the proportions shown by curve C, however, distortion can be kept down to 1.2 per cent, at the cost of 3 dB in signal-to-noise ratio. In view of the above considerations, a compromise should be made by adjusting the bias current to an intermediate setting between peak bias and minimum distortion bias. Generally, when distortion measuring equipment is not available, the usual practice is to settle for a peak bias current setting at both 7.5 and 15 in./sec. tape speeds.

Unit Standards

JOHN G. MCKNIGHT

This paper clearly indicates the reasons to end discussion about the acceptability of the new standards of unit identification.

IN THE EDITORIAL PUBLISHED IN APRIL 1968 a proposal was made for a popularity contest to determine the choice of unit abbreviations (symbols for units) for use in audio engineering. As was correctly implied, the choice of abbreviations is basically arbitrary — there is no absolute right or wrong, but only certain logical requirements such as those to consider present usage, to avoid ambiguity (same abbreviation meaning several things), to consider foreign and international usages, and so forth.

Similar questions have occurred concerning the choice of the *units* themselves — whether U.S. customary (inches, pounds, etc.), cgs metric (centimeters, grams, abvolts, statvolts, EMU of capacitance, etc.), mks unrationalized, mks rationalized (meter, kilogram, second, volt, ampere, farad, etc.) and so forth.

It is, I fear, about five to ten years too late to run a popularity contest for the engineering field in general; others have already done it, and declared the winner as the International System of Units¹ (abbreviated SI from the French name). This system of units and the corresponding unit symbols (abbreviations) has been accepted by the major engineering organizations of the U.S.A.: U.S.A. Standards Institute², National Bureau of Standards³, IEEE^{4,5}, ASTM⁶, and the Society of Technical Writers⁷. They have also been adopted internationally by the ISO⁸, IEC⁹, and CCIR¹⁰. The history and the reasons for adopting the International System of Units are discussed by Barrow¹¹.

This system was carefully worked out, and avoids ambiguous and redundant usage almost completely. The ISO documents⁸, for instance, show conversions from the following numbers of *non-SI* units, which can all be abandoned with the adoption of the SI: *Thirteen* for length, *sixteen* for volume, *fourteen* for mass, *fifteen* for pressure, *twelve* for work, *eight* for power, and on and on.

Engineering is of necessity difficult enough; to retain the usage of hundreds of redundant units (and to learn the required conversions) seems to be the sheerest stupidity. But every profession has its own special group of non-standard units that it wants retained. Clearly a little sacrifice by every group will help everyone.

There is no inconsistency in the capitalization of units: the rule is plainly that a *man's name* is capitalized (Volta); the *unit name* derived from his name is uncapitalized (volt); and the *unit symbol* derived from the unit name is capitalized (V). I suppose that one might stretch the rule, as mentioned in the editorial, for upper case omega for ohms (Ω) — it also

avoids ambiguity with lower-case omega (ω) for angular frequency.

Unit symbols not from proper names are always uncapitalized — m for meter, g for gram, etc.

The proper capitalization allows one to tell a (atto) from A (ampere); c (centi-) from C (celsius); f (femto) from F (farad); h (hecta) from H (henry); k (kilo) from K (kelvin); n (nano) from N (newton). There are still, alas, a few ambiguities: T (tera-) and T (tesla); m (milli-) and m (meter).

The International System of Units is more-or-less new to most engineers, technical writers, editors, etc.; therefore one frequently finds U.S. customary and cgs units and symbols in journals whose official policy is SI. The SI usage is rapidly increasing and will soon become truly universal.

Quite obviously I favor universal adoption of the International System of Units (and the unit symbols that go with it) just as rapidly as possible. Waiting just makes it that much more difficult.

REFERENCES

1. **International System of Units**, Resolution No. 12 of the Proceedings of the 11th General Conference on Weights and Measures (Paris, Oct. 1960). (Translation given in reference 4 below).
2. **Symbols for Units Used in Electrical Science and Electrical Engineering**, U.S.A. Standard Y 10.19-1967.
3. **NBS Adopts International System of Units**, *NBS Tech. News Bulletin* 48, 61-62 (April 1964).
4. **Recommended Practice for Units in Published Scientific and Technical Work**, IEEE Standard No. 268, April 1966, (published in *IEEE Spectrum* 3, 169-173, March 1966).
5. **Standard Symbols for Units**, IEEE Standard No. 260, Jan. 1965.
6. **ASTM Metric Practice Guide**, U. S. Dept. of Commerce, NBS Handbook 102 (2nd ed., Mar. 1967). U. S. Govt. Printing Office, 40c.
7. **Abbreviations for Terms Used in Electronics**, STWP Standard No. 1, Soc. of Tech. Writers and Publishers (May 1967).
8. International Organization for Standardization, Recommendation R 31: Part 1, Basic Quantities and Units of the SI; Part 2, Periodic and Related Phenomena; Part 3, Mechanics; Part 4, Heat; Part 5, Electricity and Magnetism; Part 6, Light and Related Electromagnetic Radiations; Part 7, Acoustics; Part 11, Mathematical Signs and Symbols. In USA, from U.S.A. Standards Institute.
9. **Letter Symbols to be Used in Electrical Technology**, International Electro-technical Commission Recommendation, Publication 27 (4th ed, 1966). In U.S.A., from U.S.A. Standards Institute.
10. **Unit Systems**, International Radio Consultative Committee, Recommendation 430, 1963.
11. B. B. Barrow, **IEEE Takes a Stand on Units**, *IEEE Spectrum* 3, 164-168 (March 1966).

John G. McKnight is a staff engineer with the consumer and educational products division of Ampex Corporation, based in Los Gatos, California.

35th AES Convention

QUICK SUMMARY

Registration

Lobby, 7th Avenue Entrance, Park Sheraton Hotel
 October 21 through October 24
 Monday, Tuesday, and Thursday; 9:00 A.M. to 8:00 P.M.
 Wednesday; 9:00 A.M. to 6:00 P.M.

BANQUET

Wednesday, October 23

Social Hour — 26th floor Oriental Room, 6:00 P.M.
Banquet — 26th floor Corinthian Room, 7:00 P.M.

Technical Sessions

26th floor

Corinthian Room

Monday, October 21

9:00 A.M. **Annual Business Meeting**
 9:30 A.M. **Solid-State Transducers**
 1:30 P.M. **Sound Reinforcement**
 7:30 P.M. **Symposium — Audio Engineering and the Environment**

Tuesday, October 22

Corinthian Room

9:30 A.M. **Disc Recording**
 1:30 P.M. **Magnetic Recording**
 7:15 P.M. **Audio in Medical Practice and Research

Oriental Room

7:30 P.M. **Seminar — From Studio to Microphone to Listener**

Wednesday, October 23

Oriental Room

9:30 A.M. **Audio Apparatus and Communications Systems**
 1:30 P.M. **The C. J. LeBel Memorial Symposium**
 6:00 P.M. **Social Hour and Banquet**

Thursday, October 24

Corinthian Room

9:00 A.M. **Audio Abroad — I
 1:30 P.M. **Audio Abroad — II**
 7:30 P.M. **Developments in Electronic-Music Systems**

**Note early starting times

Exhibits

Lower Level Ballroom and Forum Room
 Monday and Tuesday — Noon to 9:00 P.M.
 Wednesday and Thursday — Noon to 5:00 P.M.

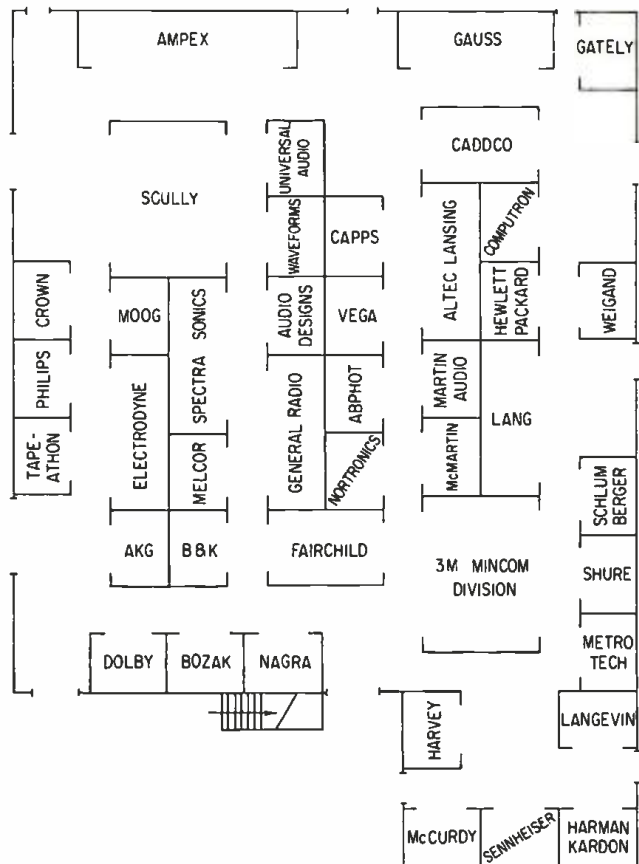

BALLROOM EXHIBITS

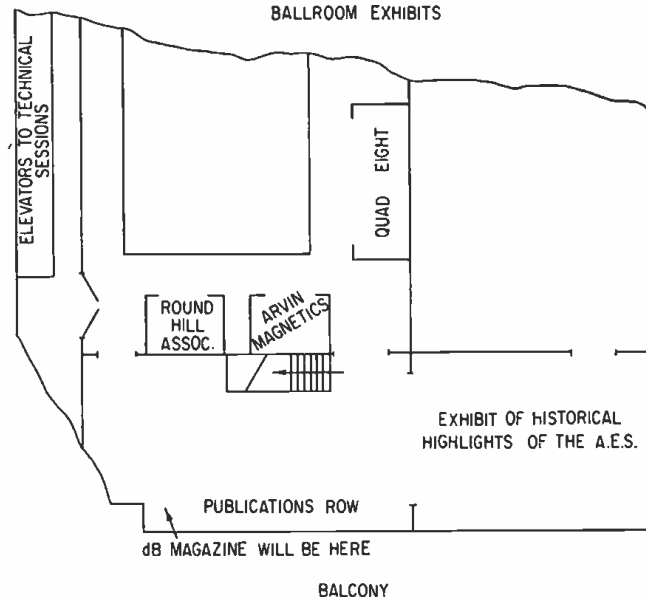

THE PAPERS

SOLID-STATE TRANSDUCERS

Monday, October 21, 9:30 A.M.

The Corinthian Room

Chairman: DONALD S. McCOY

RCA Laboratories, Princeton, New Jersey

Use of Solid State Transducers in Mechanics and Acoustics — Warren P. Mason, Columbia University, New York, New York

Interactions of Strain with P-N Junction Devices and Their Applications in Sensors — J. J. Wortman and L. K. Monteith, Research Triangle Institute, Research Triangle Park, North Carolina

An Evaporated Thin-Film Diode Strain Sensor — Robert M. Moore, Charles J. Busanovich and Frank Kozielc, Jr., RCA Laboratories, Princeton, New Jersey

IGFET Strain Transducers Utilizing Piezoelectric Materials — James Conragan, Department of Electrical Engineering & Computer Sciences, University of California, Berkeley, California

Electret Condenser Microphones — Performance in Normal and Severe Environments — Preston V. Murphy and Freeman W. Fraim, Thermo Electron Corporation, Waltham, Massachusetts

SOUND REINFORCEMENT

Monday, October 21, 1:30 P.M.

The Corinthian Room

Chairman: WILLIAM K. CONNOR

TRACOR, Inc., Austin, Texas

Ford Foundation Headquarters Auditorium Sound Reinforcement and Translation System — Irving S. Rosner, Robert J. Nissen, and A. Belmares Sarabia, Rosner Television Systems, Inc., New York, New York

Seven Channel Stereo Sound Reinforcement System for Opera and Stage Presentations in Philadelphia Civic Center Convention Hall — John E. Volkman, RCA Laboratories, Princeton, New Jersey

Effects of an Audience on Equalized Sound Systems — G. R. Thurmond, TRACOR, Inc., Austin, Texas

An Unusual Nightclub Sound Reinforcement System — Peter W. Tappan, Bolt, Beranek and Newman, Inc., Van Nuys, California

Broadband Equalization of Small Meeting Rooms — Is There a Common Denominator? — Daniel Queen, Ampli-Vox Department, Perma-Power Division of Chamberlain Manufacturing Company, Chicago, Illinois

Live Announcement Record/Reproduce Facilities for Air Terminals — A Review of Two New Systems — Robert C. Coffeen, R. C. Coffeen and Associates, Shawnee Mission, Kansas

Remote Control Audio/Visual Facility for an Advertising Agency — Herbert T. Chaudiere, Robin M. Towne & Associates, Seattle, Washington

AUDIO ENGINEERING AND THE ENVIRONMENT

SYMPOSIUM

Monday, October 21, 7:30 P.M.

The Corinthian Room

Moderator: LEO L. BERANEK

Bolt, Beranek and Newman, Cambridge, Massachusetts

Noise Pollution — Its Measurement, Characteristics and Effects on Humans — George W. Kamperman, Bolt, Beranek and Newman, Downers Grove, Illinois

Legal Aspects of Noise Control — Frederick P. Houston, Otterburg, Steindler, Houston and Rosen, New York, New York

Noise from Aircraft — Lewis S. Goodfriend, Goodfriend-Ostergaard Associates, Saddle Brook, New Jersey

Noise Control in Buildings — Cyril M. Harris, Department of Electrical Engineering, Columbia University, New York, New York

DISC RECORDING

Tuesday, October 22, 9:30 A.M.

The Corinthian Room

Chairman: JOHN J. BUBBERS

Pickering & Company, Plainview, New York

The Operation of the Recording Laboratory in the Library of Congress — Robert B. Carneal, Recording Laboratory, Library of Congress, Washington, D. C.

A Complete Solid-State Tape to Disc Transfer System — Stephen F. Temmer, Gotham Audio Corporation, New York, New York

High-Density Disc Recording Systems — Leo M. Levens, American Foundation for the Blind, New York, New York

Stereo Recordings — Monaural Playback — Their Compatibility — I. J. Sobel and Ronald Kneubel, The Astatic Corporation, Conneaut, Ohio

Stereo/Mono Disc Compatibility: A Survey of the Problems — John M. Eargle, RCA Record Division, New York, New York

MAGNETIC RECORDING

Tuesday, October 22, 1:30 P.M.

The Corinthian Room

Chairman: JOHN G. McKNIGHT

Ampex Corporation, Los Gatos, California

New Compact 16-Track, 2-Inch Recorder/Reproducer — C. Dale Manquen, Mincom Division, 3M Company, Camarillo, California

On the Design of Reliable Miniature Recorders — Edward J. Foster and Patrick Murphy, CBS Laboratories, Stamford, Connecticut

A User-Oriented High Speed Duplicating System
— James B. Wood, General Recorded Tape, Inc.,
Sunnyvale, California

Subjective Quality of the Nth Generation Tape Copy
— Keith O. Johnson, Gauss Electrophysics,
Santa Monica, California

The Development of Long-Wearing Magnetic Heads
— F. A. Oliver, Arvin Magnetics, Arvin Industries,
Columbus, Indiana

Magnetic Tape Testing and Interpretation
— Klaus E. Naumann, BASF-Computron, Inc., Bedford,
Massachusetts

Magnetic Recording Tape: The Influence of the Magnetic Coating Thickness Upon Signal Parameters
— William A. Manly, Jr., Ampex Corporation,
Redwood City, California

AUDIO IN MEDICAL PRACTICE AND RESEARCH

Tuesday, October 22, 7:15 P.M.
(Please note early starting time)

The Corinthian Room

Chairman: PHILIP KANTROWITZ
Sonotone Corporation, Elmsford, New York

"Symbiotic" R-Wave Monitor — Thomas W. Argy and William H. Greenbaum, Zenith Radio Corporation, Chicago, Illinois

Phases in the Development of an Intracranial Pressure Transducer — Lauchlan McKay, Long Island College Hospital, Brooklyn, New York

Some Promising New Techniques in Hearing Research — Edmund M. Glaser, Dept. of Physiology, University of Maryland School of Medicine, Baltimore, Maryland

Amplifying and Processing Myo-Electric Signals for Use in Man-Machine Systems — Dudley S. Childress, Northwestern University, Chicago, Illinois

Sonic Removal of Cataracts — Charles D. Keiman, M.D., Manhattan Eye, Ear and Throat, New York, New York

Cardiac Pacing for Rate and Rhythm Control — Seymour Furman, M.D., Montefiore Hospital and Medical Center, Bronx, New York

Feasibility of Automated Analysis of the Phonocardiogram — John E. Jacobs, M.D., Kazuo Horikoshi, M.D., and Mathew A. Petrovick, M.D., Northwestern University, Bio-Medical Engineering Center, Technological Institute, Evanston, Illinois

Heart Sound Analysis in the Diagnosis of Heart Disease — Abner Delman, M.D., Dept. of Phonocardiography, Montefiore Hospital, Bronx, New York

SEMINAR FROM STUDIO TO MICROPHONE TO LISTENER

Tuesday, October 22, 7:30 P.M.

The Oriental Room

Chairman: IRVING L. JOEL
Capitol Records, New York, New York

This seminar is offered as an educational service of the Audio Engineering Society to the audio industry. Any interested person professionally engaged in or training for work in sound pickup, recording or broadcasting is invited to attend. There will be no fee for registration for this session.

Practical Acoustics — Victor Brociner, Assistant to the President, H. H. Scott, Inc., Maynard, Massachusetts

Selection and Placement of Microphones Within the Environment — L. R. Burroughs, Vice President, Electro-Voice, Inc., Buchanan, Michigan

Electronic Signal Processing — John M. Eargle, Manager, Quality — Manufacturing and Recording, RCA Record Division, New York, New York

An informal question and answer period will follow the talks.

AUDIO APPARATUS AND COMMUNICATIONS SYSTEMS

Wednesday, October 23, 9:30 A.M.

The Oriental Room

Chairman: L. GLEN WHIPPLE
Federal Communications Commission, Washington, D. C.

A Specialized Audio Control Console — James Cunningham and Bruce Sweiden — 8 Track Recording Company, Chicago, Illinois

The Sophisticated Speaker? — David J. Barnett, Elite Electronics, Inc., Plainview, New York

On the Measurement and Evaluation of Loudspeakers — Amar G. Bose, Massachusetts Institute of Technology, Cambridge, Massachusetts

The Development of the Simulated Live-Vs-Recorded Test Into a Design Tool — John R. Kissinger, Jensen Manufacturing Division, The Muter Company, Chicago, Illinois

The Real World of Headphone Performance — Abraham B. Cohen, Telephonics, Division of Instrument Systems Corporation, Huntington, New York

Distortion Measurement Interpretation — R. W. Peters and M. D. Burkhard, Industrial Research Products, Inc., Elk Grove Village, Illinois

Trans-World Broadcast and Recording Center — Warren L. Braun, Warren L. Braun Consulting Engineers, Harrisonburg, Virginia

THE C. J. LeBEL MEMORIAL SYMPOSIUM

Wednesday, October 23, 1:30 P.M.

The Oriental Room

Commemorative Remarks — Mr. C. G. McProud, Publisher, Audio Magazine; Vice-President, North American Publishing Company, Philadelphia, Pa.; Charter Member and Fellow of the Audio Engineering Society.

AUDIO — 1988

Moderator: DR. FREDERICK V. HUNT, Rumford Professor of Physics and Gordon McKay,

Professor of Applied Physics
Harvard University, Cambridge, Massachusetts

Electronic Music — Dr. Daniel W. Martin, Research Director, D. H. Baldwin Company, Cincinnati, Ohio

Home Entertainment — Dr. Harry F. Olson, Staff Vice President and Consultant on Audio and Electroacoustics, RCA Laboratories, Princeton, New Jersey

Communications — Dr. J. R. Pierce, Executive Director, Research, Communications Sciences Div., Bell Telephone Laboratories, Murray Hill, New Jersey

Sound Reinforcement — Dr. C. P. Boner, Professor of Physics and of Architecture, University of Texas. C. P. Boner and Associates, Austin, Texas

AUDIO ABROAD — I

Thursday, October 24, 9:00 A.M.
(Please note early starting time)

The Corinthian Room

Chairman: J. L. OOMS
Philips' Phonographic Industries, Baarn, The Netherlands

Extraction of Pitch of Speech by Means of a Phase Locked Tracking Filter — Giuseppe Righini, Istituto Elettrotecnico Nazionale "Galileo Ferraris," Turin, Italy

Historical Development of Magnetic Tapes From the Point of View of the Preisach Diagram — Jiri Struska, Research Institute of Sound and Picture (Vuzort), Prague, Czechoslovakia

An Electronic Piano — P. R. Dijksterhuis and T. Verhey, N. V. Philips' Gloeilampenfabrieken, Eindhoven, The Netherlands

Sound Reinforcement for Banqueting Halls, Ballrooms and Conference Rooms — G. E. Horn, P. G. Tandy and Percy Wilson, Percy Wilson and Partners, Oxford, United Kingdom

Thin Bilaminar Piezodiaks Used as Microphone and Telephone Membranes — J. Roos and J. Koorneef, Philips' Research Laboratories, N. V. Philips' Gloeilampenfabrieken, Eindhoven, The Netherlands

Horn Loudspeaker With an Electrostatically Driven Diaphragm — Josef Merhaut, Technical University of Prague, Prague, Czechoslovakia

A High Fidelity Large Output Sound Reproducing System — T. Itow, Waseda University, Electrical Communication Department, Tokyo, Japan

Simulator — Model Computer for Electrochemical Analogies — Bernhard Weingartner, Akustische u. Kino-Geräte GmbH, Vienna, Austria

AUDIO ABROAD — II

Thursday, October 24, 1:30 P.M.

The Corinthian Room

Chairman: PERCY WILSON
Percy Wilson and Partners, Oxford, United Kingdom

A New Method for Subjective Rating of Loud-

speakers — Peter K. Burkowitz, Deutsche Grammophon Gesellschaft mbH, Hannover, Germany

Trackability Test By Complex Tones and Biasing Force Effects of Phonograph Pickups — A. Hayashi, M. Kobayashi and M. Kuriyagawa, Central Research Laboratory, Tokyo Shibaura Electric Co., Ltd., Kawasaki, Japan

Measuring Gramophone Pickup Performance — John Walton, Rainer-Walton Enterprises, London, United Kingdom

Synchronous TV Sound Recording — Michel Calmet, Office de Radiodiffusion-Television Francaise, Paris, France

A New Concept of a Capstan Drive System for Professional and Home Tape Recorders — Arturo E. Stosberg, Fa. Willi Studer, Regensdorf, Switzerland

An Estimation of Annoyance By Dropouts in Magnetically Recorded Music — B. L. Cardozo and G. Domburg, Institute for Perception Research, Eindhoven, The Netherlands

Audio Control Facilities in Modern Recording Studios — A. Balster, Philips' Phonographic Industries, Baarn, The Netherlands

Monitoring Standardization for Multi-Track Recording System — Sylvio M. Rabello, Discos CBS S.A. Industria o Comércio, Rio de Janeiro, Brazil

The Loudness Balance of Audio Broadcast Programs — Ernst Belger, Institut für Rundfunktechnik GmbH, Hamburg, Germany

A New Approach to Dynamic Range Compression for Audio Systems — Barry Blesser and K. O. Bäder, Elektromesstechnik Wilhelm Franz KG, Lahr, Germany

DEVELOPMENTS IN ELECTRONIC-MUSIC SYSTEMS

Thursday, October 24, 7:30 P.M.

The Corinthian Room

Chairman: EARLE L. KENT
C. G. Conn, Ltd., Elkhart, Indiana

The Application of Digital Integrated Circuits in an Electronic Rhythm Generator — William V. Machanian and Peter E. Maher, The Wurlitzer Company, North Tonawanda, New York

The Evolution of an Electronic Snare Drum — James S. Southard, C. G. Conn, Ltd., Elkhart, Indiana

Description of a Real-Time, Multipartial Waveform Analyzer-Synthesizer — David A. Luce, Melville Clark Associates, Cochituate, Massachusetts

Recent Trends in Electronic Music Studio Design — R. A. Moog, R. A. Moog, Inc., Trumansburg, New York

An Electronic Music Learning System — Victor J. Blong, C. G. Conn, Ltd., Elkhart, Indiana

Following the technical papers the Session Chairman, Dr. Kent, will play a tape demonstrating four different commercial devices for amplifying and modifying the tones of conventional musical instruments. If time permits, there will be an open discussion of the problems and progress of electronic musical instruments.

THE DOLBY A301 AUDIO NOISE REDUCTION SYSTEM

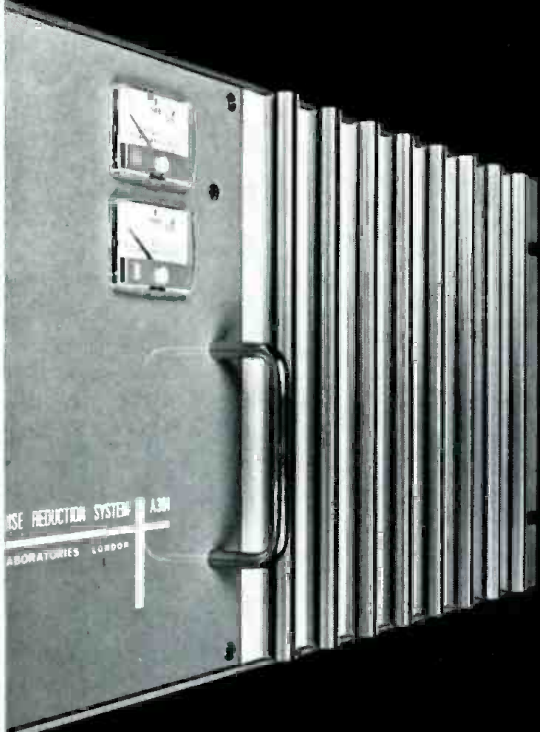

Making the
Master
Recordings
of the
Future

DOLBY LABORATORIES INC.

Already in use in eighteen countries, the Dolby system is making master recordings which will withstand the test of time.

The system provides a full 10 dB reduction of print-through and a 10–15 dB reduction of hiss. These improvements, of breakthrough magnitude, are valid at any time—even after years of tape storage. This is why record companies with an eye to the future are now adopting this new revolutionary recording technique.

A301 features: Easy, plug-in installation · solid state circuitry · modular, printed circuit construction · high reliability, hands-off operation. Performance parameters such as distortion, frequency response, transient response, and noise level meet highest quality professional standards.

Price \$1950 f.o.b. New York.

NEW Remote Changeover option cuts costs. enables one A301 unit to do the work of two.

NEW NAB and DIN level setting meters simplify recorder gain calibration.

333 Avenue of the Americas · New York · N.Y. 10014
(212) 243-2525 · Cables: Dolbylabs New York

Circle 41 on Reader Service Card

The precision instrument for SPEED CONTROL of tape...



TAPE STROBE

\$22.50
plus local taxes.



dubbings
ELECTRONICS INC.

A subsidiary of Consolidated Electronics Industries Corp. • 1305 S. STRONG AVE., COPIAGUE, N. Y. 11726 / 516 893-1000

The growing trend to multitrack recording has necessitated that tapes be "on cue" and "on speed," now more than ever.

The Tape Strobe — a small, precision ground, high quality, stroboscopic wheel with professional specifications — shows you, instantly, whether a tape is truly on speed. Detects slippage and uneven tape speed, eliminates errors of timing, cueing, measurement and calibration. Indicates mechanical damage and worn transports.

EASY TO USE — Press strobe wheel gently against tape, check direction of pattern for off-speed condition. Any 60-cycle light source furnishes the basic timing.

HIGH QUALITY FEATURES — All anodized finish, precision machined out of solid aluminum, strobe wheel mounted with instrument pivot bearing, metal etched stroboscopic pattern.

Calibrated for three tape speeds: 7½ ips, 15 ips, and 30 ips. Other speeds available. Calibrated chart included with each Tape Strobe. Packaged in beautiful deluxe jewelry case.

Circle 42 on Reader Service Card

CLASSIFIED

Classified advertising is an excellent and low-cost way to place your products and services before the audio professional. If you are a prospective employer seeking skilled help or an employee seeking a change you will find that the classified pages of **db** reach the people you want. Special low rates apply for this service.

Rates are 50c a word for commercial advertisements. Non-commercial and employment offered or wanted placements are accepted at 25c per word.

Frequency discounts apply only to commercial ads and are as follows.

3 times — 10%
 6 times — 20%
 12 times — 33 $\frac{1}{3}$ %

Agency discounts will not be allowed in any case.

Closing date for any issue is the **fifteenth** of the **second** month preceding the date of issue.

New Products

NEW MODULAR COMPONENTS

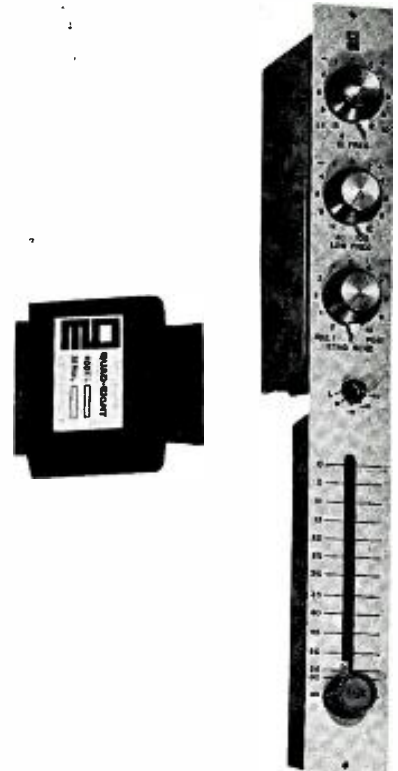

● A new line of modular components has been introduced along with a new manufacturer. Quad-Eight Electronics is located in North Hollywood, California, and they are offering engineering emphasis placed on specific product specifications directed to system performance as the criteria. Among the first products is the MM61 mixer module with four separate amplifiers, completely symmetrical equalization, three-position echo-send selector, slide-wire attenuator, line/mic, and input attenuation selector, +24 dBm output. The panel measures 1 $\frac{1}{2}$ -in. wide by 14-in. high. The plug-in combining network pictured left features 28 inputs, gain adjustment to unity, +10 dB or +20 dB, all inputs bridging with 80 dB isolation between inputs, and 24 dBm output.

*Mfgr: Quad-Eight Electronics
 Circle 63 on Reader Service Card*



**It's
 unequaled**
 Custom recording
 consoles

DATAMIX
 250 West 78th St., New York, 10024

Circle 32 on Reader Service Card

FLUTTER METER



● This instrument, the W.H.M. Wow and Flutter Meter, is calibrated to read per cent rms and conforms in all important respects with the generally accepted standards. A built-in oscillator supplies with 3 kHz signal for the unit. (Special order units are available with 3.15 kHz.) The input requires this signal be ± 5 per cent, at 0.5 to 3 volts, and at an impedance of 100 k Ω . The measuring ranges are 1 per cent and 0.2 per cent full scale. Indications are in per cent rms flutter. The response characteristics may be set to linear where the range of the instrument is 0.5 to 200 Hz -3 dB or wow where the response is -20 dB at 100 Hz. The meter time constant is 0.4 seconds. Size is 8 x 5 x 5½ inches, weight is 4 pounds. The unit is fully transistorized and there is a 'scope output.

Distributor: ReVox Corporation

Price: Under \$200.

Circle 61 on Reader Service Card



REMOTE OVERDUB CONTROL

● This small control, measuring 6 by 6 by 4 inches, fits easily into recording consoles. In addition to remotely and electronically controlling overdubbing, it also helps eliminate the possibility of accidental erasure. The control is available as a factory-installed accessory for 3M professional recorders.

Mfgr: 3M Company

Price: \$950

Circle 64 on Reader Service Card

When you
see and hear

PROCAST

at the 1968
AES Exhibition...
You'll know why

harman kardon

waited so long
to enter the
field of sound
reinforcement.

PROCAST—an entirely new concept in high quality sound for public space. From Harman-Kardon, leaders in the manufacture of solid-state audio devices.

PROCAST—a complete line of sound reinforcement equipment, from microphones to speakers. Preamps, mixers, compressors and other special amplification devices, with amplifier capability from 10 to 350 watts.

PROCAST—all-silicon transistorized, all solid-state, representing the most advanced state of the art.

PROCAST—with an entirely new type of protective circuitry: PRO-GUARD.

PROCAST—the only equipment of its kind guaranteed for two years.

PROCAST—a full equipment line that will meet the most professional audio specifications.

PROCAST—reliably designed and made to sell and stay sold.

PROCAST—backed up by Harman-Kardon's superb technical assistance and engineering staffs.

See Harman-Kardon's PROCAST line at Booth 45, AES Exhibition, Park Sheraton Hotel, New York, N.Y. October 21-24.

harman kardon

Commercial Sound Division

55 Ames Court, Plainview, N.Y. 11803 (516) OV 1-4000

Circle 33 on Reader Service Card

The db Bookcase

As a service to our readers we are pleased to offer these books from prominent technical publishers. All prices listed are the publishers' net. Shipping charges are included.

Use the coupon at the bottom of the page or give the complete title, author and coupon number. Be sure to indicate quantity on the special instructions line if more than one copy of a title is wanted. Full payment must accompany your order. We cannot ship c.o.d. Checks or money orders should be made payable to Sagamore Publishing Company, Inc. Because of the time required to process orders, allow several weeks for the receipt of books.

Broadcasting

RADIO BROADCASTING

edited by Robert L. Hilliard. Each of the five chapters has been written by a prominent educator with an extensive background of practical experience in commercial and educational broadcasting. The areas covered include: management and programming, operating and studio facilities, producing and directing, writing, performing. For those of you who want to, or must, operate on both sides of the control room, this is virtually required reading. 190 pages; 6 1/4 x 9 1/2; indexed; clothbound.

\$6.95 (\$8.35 in Canada)
Circle 2 on Coupon Below

PLANNING THE LOCAL UHF-TV STATION

by Patrick Finnegan. 1965. An informative guide for the planning, building, and operation of a small-market, UHF-TV station. Based on the author's lengthy experience in the technical operation of such a station, it explains equipment, layout, and building costs that apply to the small studio (one-man control room operation) with a heavy film schedule. A valuable aid for the station owner, manager, engineer and layman interested in this medium. 328 pages; 6 x 9; illus; clothbound

\$10.00 (\$11.95 in Canada)
Circle 17 on Coupon Below

How To

HOW TO BUILD SPEAKER ENCLOSURES

by Alexis Badmaieff and Don Davis. A thorough and comprehensive "do-it-yourself" book providing a wealth of practical and theoretical information on the "whys" as well as the "hows" of constructing high-quality, top-performance speaker enclosures. Contains detailed drawings and instructions for building the various basic enclosures. Includes infinite-baffle, bass-reflex, and horn projector types as well as several different combinations of these. The book covers both the advantages and the disadvantages of each enclosure type and includes a discussion of speaker drivers, crossover networks, and hints on the techniques of construction and testing. Written and compiled by two of the nation's leading authorities in the field of acoustical engineering. 144 pages; 5 1/2 x 8 1/2; softbound.

\$3.50 (\$4.25 in Canada)
Circle 3 on Coupon Below

PRACTICAL PA GUIDEBOOK: HOW TO INSTALL, OPERATE AND SERVICE PUBLIC ADDRESS SYSTEMS

by Norman H. Crowhurst. 1967. This book gives all the basics needed to become a successful PA operator, in any situation where the reinforcement, relay, or distribution of sound can provide a service. It shows how to properly install, operate and service public address systems. All aspects of the subject, from survey to the selection of appropriate equipment, to installation, to routine operation and the maintenance of a finished system, are covered. Attention is given to solving problems encountered in providing successful service. The book's systematic and practical approach makes it highly useful to radio-TV servicemen, hobbyists, and PA equipment manufacturers. 136 pages; 6 x 9; illus; softbound.

\$3.95 (\$4.60 in Canada)
Circle 15 on Coupon Below

CLOSED CIRCUIT TV SYSTEM PLANNING

by M. A. Mayers and R. D. Chipp. 1957. This book discusses in detail the vitally important and rapidly expanding concept of closed circuit TV systems, its utility and functioning. This book is not an engineering or a technician's text — it is written for management. It explains and illustrates the kind of systems that are available and their applications. 264 pages; 8 1/2 x 11; illus; clothbound.

\$10.00 (\$11.95 in Canada)
Circle 16 on Coupon Below

General Audio

THE TECHNIQUE OF THE SOUND STUDIO

by Alec Nisbett. This is a handbook on radio and recording techniques, but the principles described are equally applicable to film and television sound. It describes how the highest standards may be achieved not only in the elaborately equipped studio but also with simple equipment out on location. 264 pages; 60 diagrams; glossary; indexed; 5 1/2 x 8 1/2; clothbound.

\$10.50 (\$11.95 in Canada)
Circle 1 on Coupon Below

MICROPHONES

by A. E. Robertson. 1963. This book, primarily written as a training manual for technicians, will also prove valuable to all users of quality microphones whether for broadcasting, public address systems, or recording of all types. There is now an almost bewildering array of microphones of differing characteristics, and new designs are constantly being produced. The author makes no attempt to catalogue these but concentrates mainly on the principles of operation. He only describes actual microphones if they illustrate an important feature or have some historic significance. The book is intended for the user rather than the designer; mathematics have been omitted from the main body of the text. 359 pages; 6 x 9; illus.; clothbound.

\$12.75 (\$15.40 in Canada)
Circle 13 on Coupon Below

Electronics and Mathematics

ELECTRONICS MATH SIMPLIFIED

by Alan Andrews. For the engineer, student, or technician who requires a knowledge of mathematics as it pertains to electronics. Covers the subject in a logical, clear, and concise manner, using dozens of examples related specifically to electronics. Particularly suited for use as a textbook in any school or other training program involving the study of electronics, the book has been especially prepared to coincide with studies leading to 2nd- and 1st-class FCC Radiotelephone licenses. (2 vols. in slipcase)

\$7.95 (\$9.95 in Canada)
Circle 11 on Coupon Below

MATHEMATICS FOR ELECTRONICS ENGINEERS & TECHNICIANS

by Norman H. Crowhurst. This book is written to help the advanced technician and the engineer bridge the gap between "book learning" and practical experience. It is not about mathematics but about how to use mathematics in electronics. A unique programmed method shows not only how to apply textbook math towards the solution of any electronics problem but also teaches how to think in the best way for solving them. Much emphasis is placed on correcting misconceptions commonly held by technicians. The book begins with Ohm's and Kirchhoff's laws and goes on to selective networks, properties of coils and transformers, feedback circuits, etc. 256 pages; 5 1/2 x 8 1/2 (hardbound).

\$6.95 (\$8.35 in Canada)
Circle 4 on Coupon Below

Sagamore Publishing Company, Inc.
980 Old Country Road, Plainview, N.Y. 11803

Please send me the books I have circled below. My full remittance in the amount of \$..... is enclosed. N.Y. State residents add 2% sales tax.

1 2 3 4 5 6 7 8 9 10 11 12 13 14 15 16 17 18 19 20 21 22
23 24 25 26 27 28 29 30 31 32 33 34 35 36 37 38 39 40

Name.....

Street Address.....

City.....State.....Zip.....

Special Instructions.....

HANDBOOK OF ELECTRONIC TABLES & FORMULAS, (2nd Edition)

A one-stop source for all charts, tables, formulas, laws, symbols, and standards used in electronics. Devotes complete sections to items of interest to service technicians and to circuit design data. Includes a 6-page, full-color fold-out chart showing latest FCC allocations for the entire frequency spectrum. 192 pages; 5+ x 8+, hardbound.

\$3.95 (\$4.95 in Canada)
Circle 8 on Coupon Below

Test and Maintenance

INTERMODULATION AND HARMONIC DISTORTION HANDBOOK

by Howard M. Tremaine. A complete reference guidebook on audio signal intermodulation and harmonic distortion. 172 pages; 5½ x 8½; softbound.

\$4.25 (\$5.25 in Canada)
Circle 9 on Coupon Below

Circuitry and Components

PASSIVE AUDIO NETWORK DESIGN

by Howard M. Tremaine. A complete and comprehensive guide to the design, construction, and testing of all types of attenuators, equalizers, and wave filters for the practicing audio technician or engineer. This authoritative text is one of the few written on the subject, and requires only nominal mathematical background. Written in easy-to-understand language, the content presents the basic design, construction, and testing considerations without the confusion often associated with passive networks. 288 pages; 5½ x 8½; softbound.

\$5.50 (\$6.45 in Canada)
Circle 5 on Coupon Below

TRANSISTORS FOR AUDIO FREQUENCY (AUDIO-FREQUENCY AMPLIFICATION)

by Guy Fontaine. 1967. This systematic and detailed treatment of the application of transistors in audio-frequency amplifiers shows how the published transistor characteristics are related to the principles of design. To assure clarity, the figures are rendered in several colors and placed opposite the related text. Simple equations reinforce the lucid approach. An ideal textbook or reference on the subject for engineers and advanced technicians. 384 pages; 5½ x 8; illus.; clothbound.

\$7.95 (\$9.55 in Canada)
Circle 12 on Coupon Below

ACOUSTICAL TESTS AND MEASUREMENTS

by Don Davis. Provides a solid understanding of the entire subject of acoustical measurements; based on actual field test work, using commercial equipment. Contains practical, time-saving solutions to actual problems encountered in the field; minimum math is required for understanding. The author is an expert in this field, and an authority on auditorium acoustics. An invaluable book for phone company special service engineers, plant maintenance engineers, communications engineers, noise control specialists, architectural engineers, broadcast engineers and technicians, hi-fi fans and students. 192 pages; 5½ x 8½; hardbound.

\$6.95 (\$8.35 in Canada)
Circle 7 on Coupon Below

DESIGN OF LOW-NOISE TRANSISTOR INPUT CIRCUITS

by William A. Rheinfelder. 1964. Written for students as well as circuit design engineers interested in low-noise circuit design. Throughout, the book gives a multitude of time-saving graphs and design curves for the practical circuit designer. Simple derivations of all important formulas are also presented to help the reader obtain a deeper insight into the fundamentals of practical low-noise design. 128 pages; 6 x 9; illus.; clothbound.

\$5.50 (\$6.50 in Canada)
Circle 14 on Coupon Below

Reference

New 17th Edition of the famous RADIO HANDBOOK

Tells how to design, build and operate the latest types of amateur transmitters, receivers, transceivers, amplifiers and test equipment. Provides extensive, simplified theory on practically every phase of radio. Broad coverage; all original data, up to date, complete. 847 pages.

\$12.95 (\$15.50 in Canada)
Circle 10 on Coupon Below

Classified

Looking for a qualified professional to fill a job opening?

Trying to sell some audio equipment privately?

Want to get an audio engineering position in another city?

USE db CLASSIFIED . . .
A UNIQUE NEW EMPLOYMENT AND EQUIPMENT EXCHANGE FOR THE WHOLE AUDIO INDUSTRY

db

THE SOUND ENGINEERING MAGAZINE now offers a classified advertising section to firms and individuals in all areas of audio — recording, commercial sound, broadcasting, manufacturing, film and tv sound, etc.

Closing date is the fifteenth of the second month preceding the date of issue. Send copy to:

Classified Ad Dept.

db

THE SOUND ENGINEERING MAGAZINE
980 Old Country Road
Plainview, New York 11803

FOR SALE

SOLID-STATE 50 WATT RMS plug-in d.c. thru 25 kc operational power amplifier kit, model 440K. Price \$30.00. Send for free catalog and 50 operational amplifier applications to: Opamp Labs. 172 So. Alta Vista Blvd., Los Angeles, California 90036.

SCULLY TAPE RECORDERS — One to twelve track. Two, four, and eight track models in stock for immediate delivery.

SCULLY LATHES — Previously owned and rebuilt. Variable or automatic pitch. Complete cutting systems with Westrex heads.

MIXING CONSOLES — Custom designed using Electrodyne, Fairchild and Univera Audio modules. From \$4000.00.

Wiegand Audio Laboratories, 3402 Windsor Road, Wall, New Jersey 07719. Phone: 201 681-6443.

AUDIO EQUIPMENT for churches, schools, recording studios, radio and t.v. stations. New and used. Trade-ins accepted. AMPEX, BOGEN, ELECTRO-VOICE, SHURE, SCULLY, and many others. Free lists. Boynton Studio, 118 Brook St., Scarsdale, N. Y. 19583.

EMPLOYMENT

RECORDING STUDIO seeks experienced man at disc cutting and multi-channel tape recording and editing. Location is in New York City area. Salary open. Write in confidence to Box B-9, db Magazine, 980 Old Country Road, Plainview, New York 11803.

SERVICES

PROFESSIONAL AUDIO REP serving the greater New York area seeks additional compatible lines. Box S4, db Magazine, 980 Old Country Road, Plainview, N. Y. 11803

DON'T BE AN AUDIO DROPOUT! See BROADCAST EQUIPMENT REBUILDERS for your tape cartridge rewinding needs. Route 8, Box 718, Fayetteville, N.C. 28304. (919) 425-7332.

PROFESSIONAL DIRECTORY

Philip C. Erhorn
Systems Design and Specifications
Custom Consoles Technical Writing
P.O. Box 861
Stony Brook, New York 11790
Tel: 516 941-9159

People, Places, Happenings



● **Frank E. Bullard** has been named sales engineer in the midwest region for **Philips Broadcast Equipment Corp.** The appointment was announced by **Anthony R. Pignoni**, director of marketing for the firm. Mr. Bullard will be headquartered in the company's sales and service offices in Skokie, Illinois. Prior to joining Philips Mr. Bullard was in television systems sales capacities with **Diamond Power Specialty Corp.**, and with **Motorola** and **Philco**.

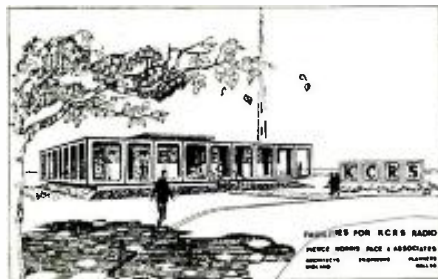

● From West Texas comes news of a modern radio broadcasting facility under construction. When completed the 5412 square-foot building will house the studios and offices of radio station **KCRS** and will be located in Midland. **Muzak** will also maintain offices and studio in the new building. The construction will be of brick, was designed by **Pierce, Norris, Pace & Associates Architects** of Midland. Completion is expected early in 1969.

● **Film Recording, Inc.**'s president **Grant H. Gravitt** has announced the new corporate name for the Miami, Florida based studios. The former name was **Film Sound, Inc.** The change was made because it was discovered that the name is similar to a New York firm. At the same time, Mr. Gravitt announced the appointment of **Edward Rehm** as chief engineer. He will also serve in a similar capacity for two affiliated companies, **Criteria Recording Studios, Inc.**, and **Tel-Air Interest, Inc.** Mr. Rehm was formerly with **WLBW-TV (Channel 10)** where he was responsible for the audio installations of that station's new building.



● Commuters of the near future may be blanketed in stereophonic sound if **Lockheed Aircraft Company's** mock-up of their 345 passenger trijet comes to pass. Not only the standard fare of wide-screen films and their mini-transducers for the ears will be supplied; there will be two banks of high-fidelity loudspeakers spanning the entire cabin. Lockheed has selected **James B. Lansing L75** speaker systems and **JBL** amplifiers for their prototype. **JBL** engineers also camouflaged **LE5-2** small-cone speakers between each **L75** pair to aid in dispersion. According to **JBL** International president **T. J. Jennings**, they have been supplying speakers for railroad signaling devices, foghorns, and for use in medical research. Another aircraft firm has been conducting hologram experiments with a **JBL** high-frequency transducer. "Hardly a week passes that some innovator doesn't find a use for loudspeakers," according to Mr. Jennings.

● Merger news from Cambridge, Mass. **The Eckel Corporation** has combined with the **Stic-Klip Mfg. Co., Inc.** to create a new corporation to be known as **Eckel Industries, Inc.** Eckel has long been known for portable and larger anechoic chamber systems and components. **Stic-Klip** manufactures patented flexible shock-absorbing doors and fasteners for installing insulation, furring, etc. According to the new company president **Oliver C. Eckel**, each of the various product lines will be operated as divisions. He further states that there were no basic changes in management or personnel expected as a result of this merger.

● A copy of the final constitution of the recently formed **American Engineering Association** has been sent to us. This fast-growing organization has been established for the advancement of the engineering profession through promoting engineering education, state registration, and professional ethics. Membership is open to all graduate engineers. There is a telecommunications group which, we presume, will include audio engineers. Readers interested in further information should write to the **AEA, Lakeside, Michigan 49116**.



● **Philips Broadcast Equipment Corp.** has recently established a sales and service facility to serve the midwest region. Philips manufactures professional television, audio and motion-picture systems under the trade name **Norelco**. So naturally, the new facility is being called **Norelco House**. It's in Skokie, Illinois.



The Desktop Console above is comprised of
FAIRCHILD INTEGRATED CONTROL MODULES

Each module is one compact control unit offering full capability of processing the microphone signal to the line level or mixing buss. It provides +18 dbm output to a recorder or other equipment.

The Module includes these functions: Input Level Selector Switches and Pads, Input Preamp, Input Fader with or without cue, Echo Feed Control, Echo Feed Selector, Compressor, Full Spectrum Program Equalizer, Output Amplifier, Metering, Channel Selector Switch.

Each Fairchild Desktop Console is assembled to meet individual requirements; the one above accepts up to ten modules. Other Fairchild modules include the Integrated Control Output Module, which processes the signal from the mixing buss to the console output, and the Monitor Module, which provides complete flexibility in the selection of recording channels.

Contact your Fairchild Recording Distributor or write Fairchild for more data.

FAIRCHILD RECORDING EQUIPMENT CORPORATION, Dept. DB10, 10-40 45th Avenue, Long Island City, New York 11101

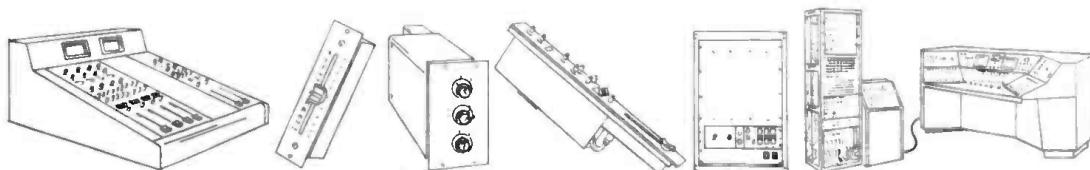

DESKTOP MODULE CONSOLE / LUMITEN / REVERBERTRON 658B / INTEGRATED CONTROL MODULE / REVERBERTRON 658A / REMOTE AUDIO CONSOLE
 Circle 26 on Reader Service Card



**At last someone
has made another
PA speaker like the unique,
distortion-free CDP®**

It had to be us.

ⓔ There's a good reason why only Electro-Voice has produced the compound horn. That reason is U.S. Patent No. 2,856,467. And though several have tried, there's just no equal to this ingenious design.

The difference made by a compound horn is easily heard. Distortion is lower, particularly at or near full power. Response is smoother, flatter, with extended highs for better intelligibility. And with no peaks in response, the chances of feedback are greatly reduced.

This improved performance is gained at no loss in efficiency. In fact, in many installations fewer compound horns are needed to do the same job as reentrant horns. So, costs are lower, installation time is shorter, and main-

tenance is easier.

Until recently, the advantages of compound design were available only in the wide-angle CDP (FC100)—the fiberglass horn that started the trend to high fidelity response in public address. Now you can have a choice.

Our newest compound horn is the round AC100 horn. It puts more useful energy on axis than much larger reentrants. And the AC100 concentrates its energy with the same high quality that has made the wide-angle CDP famous. Smooth response, low distortion, extended highs—all advantages that every audience will hear and appreciate, and all exclusive with E-V compound horn design.

Both the AC100 and the FC100

require E-V convertible drivers. And now there are four from which to choose. Rated at 30 and 60 watts, with and without 70.7-volt transformers. Every driver offers the efficiency of E-V ceramic magnet design, combined with utter reliability. Even so, diaphragm assemblies are field replaceable (after all, accidents will happen).

Find out for yourself how our compound horns can improve your next sound installation without compounding your problems. For complete catalog information, write today.

SHOWN ABOVE: Left, 848A 30 watt CDP speaker, \$89.00 list; or FC100 horn only, \$53.50 list for use with any E-V convertible driver. Right, AC100 horn only, \$92.00 list. Not illustrated, smaller 847 25 watt CDP speaker, \$59.00 list. Normal trade discounts apply.

high fidelity speakers and systems • tuners, amplifiers, receivers • public address loudspeakers • microphones • phonograph needles and cartridges • organs • space and defense electronics

ELECTRO-VOICE, INC., Dept. 10869D, 686 Cecil Street, Buchanan, Michigan 49107

Circle 27 on Reader Service Card

Electro-Voice®

A SUBSIDIARY OF GULTON INDUSTRIES, INC.