

dB

THE SOUND ENGINEERING MAGAZINE

OCTOBER 1969

75c

Complete Guide to the New York AES Convention

Implications of the Low Noise Background II

Replacing a Broadcast Console

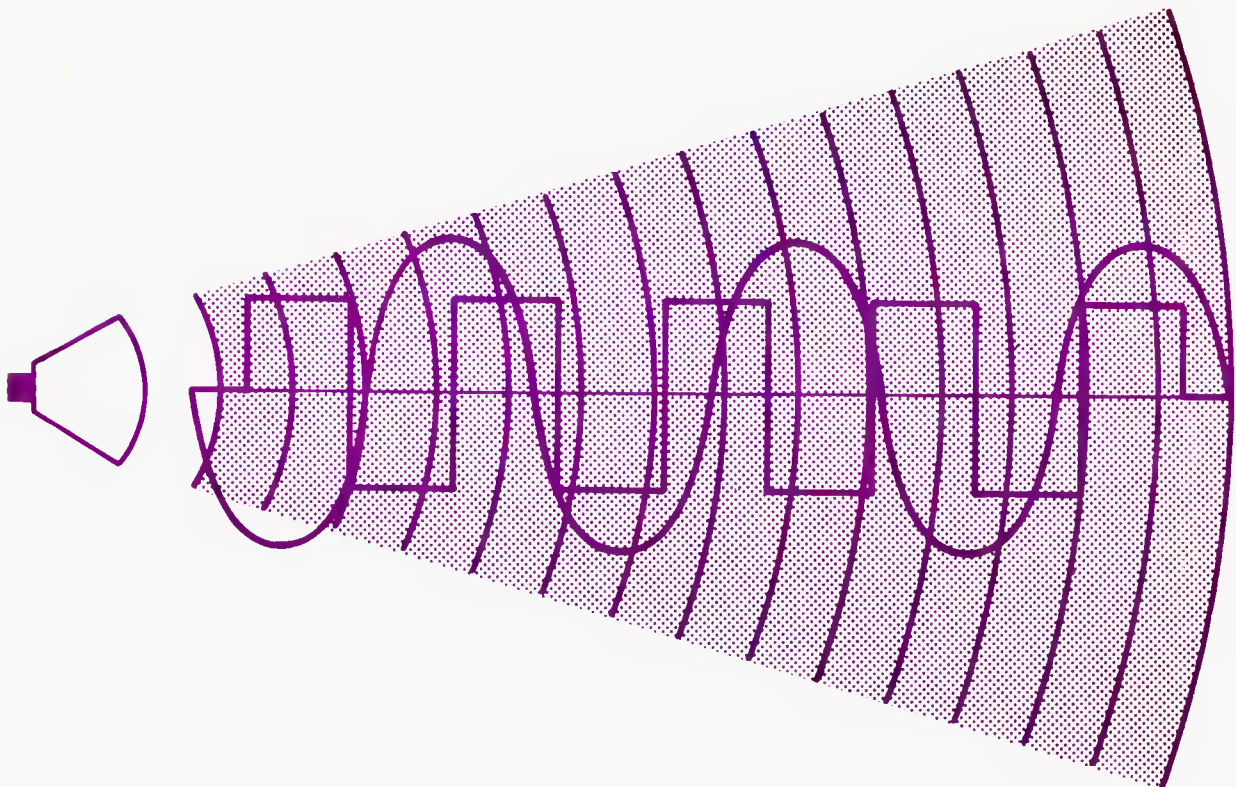

FM Broadcasters

There are several ways you can increase your effective radiated program power — compare the costs:

1. New transmitter
\$6,200

2. New high-gain antenna
\$1,895



3. Audimax and Volumax
\$1,360

Audimax and Volumax together can increase effective program power 8 to 1 over conventional limiters and automatic or manual gain controllers.

Call today for a 30 day free trial, (203) 327-2000.



PROFESSIONAL
PRODUCTS

CBS LABORATORIES

Stamford, Connecticut 06905
A Division of Columbia Broadcasting System, Inc.

Circle 10 on Reader Service Card

Coming Next Month

● **JUST STEP UP TO THE MIC** is the title Robert Hawkins has given to his nostalgic piece describing the lineage of the modern microphone. Old-timers in audio will particularly appreciate his careful research as well as his photographs of some early and memorable mics.

A new super-8 sound movie system with audio-visual implications is described in its technical details by Larry Zide. The operation of the Bell & Howell Filmosound system, its values and its shortcomings will be outlined.

Elliot Full is back with a short piece entitled **A DIFFERENT VIEW OF LOUD-SPEAKER COVERAGE**. He will discuss the psycho-acoustic aspects of speaker use in public address with particular emphasis on choosing speaker types that are compatible with the program content.

And there will be our regular columnists, George Alexandrovich, Norman H. Crowhurst, Martin Dickstein, and Arnold Schwartz. Coming in **db**, The Sound Engineering Magazine.

About the Cover

● A fanciful representation of sound propagation by Erwin T. Handel, who is responsible for the artwork to be seen in this and every issue of **db**.

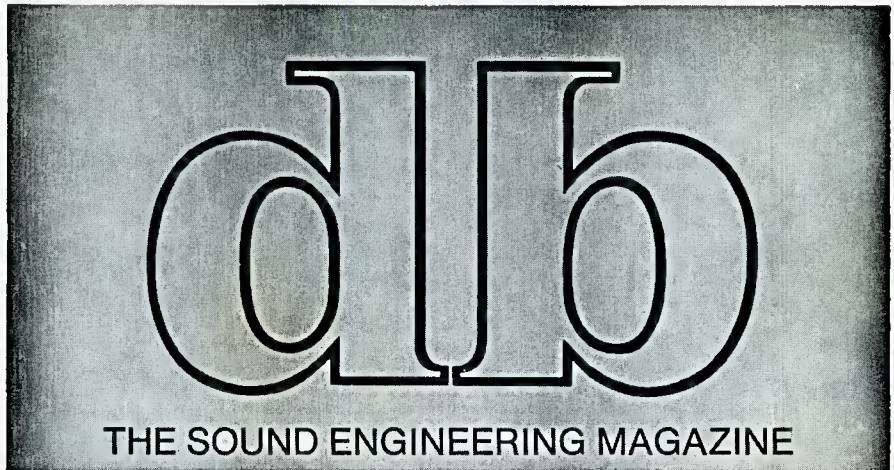

OCTOBER 1969 • Volume 3, Number 10

Table of Contents

FEATURE ARTICLES

- Replacing a Broadcast Console
Les Brown **26**
- Implications of the Low Noise Background II
Edward Tatnall Canby **30**
- 37th AES Program — Complete Guide **36**

MONTHLY DEPARTMENTS

- Letters **2**
- The Audio Engineer's Handbook
George Alexandrovich **4**
- Theory and Practice
Norman H. Crowhurst **10**
- The Feedback Loop **omitted**
Arnold Schwartz **this month**
- Sound with Images
Martin Dickstein **18**
- New Products and Services **44**
- The **db** Bookcase **48**
- Classified **49**
- People, Places, Happenings **50**

EDITORIAL BOARD OF REVIEW

George Alexandrovich
Sherman Fairchild
Norman Anderson
Prof. Latif Jiji
Daniel R. von Recklinghausen
William L. Robinson
Paul Weathers
John H. McConnell

db, the Sound Engineering Magazine is published monthly by Sagamore Publishing Company, Inc. Entire contents copyright © 1969 by Sagamore Publishing Co., Inc., 980 Old Country Road, Plainview, L.I., N.Y. 11803. Telephone (516) 433-6530. **db** is distributed to qualified individuals and firms in professional audio—recording, broadcast, audio-visual, sound reinforcement, consultants, video recording, film sound, etc. Application must be made on an official subscription form or on a company letterhead. Subscriptions are \$6.00 per year (\$7.00 per year outside U. S. Possessions, Canada, and Mexico) in U. S. funds. Single copies are 75c each. Controlled Circulation postage paid at Easton, Pa. 18042. Editorial, Publishing, and Sales Offices: 980 Old Country Road, Plainview New York 11803. Postmaster: Form 3579 should be sent to above address.

One of a series of brief discussions
by Electro-Voice engineers



STAND UP FOR PROGRESS

THOMAS LININGER
Microphone
Project Engineer

For years, microphone stands have received little attention from designers. Once basic functions were satisfied (i.e., floor or desk mounting, switching, etc.) only minor variations were seen, based more on aesthetic considerations than on functional superiority.

Recently Electro-Voice took a close look at the design of their desk stands for broadcast and professional sound applications. The need was underscored by the major change in microphone size and shape in the past decade. With lighter, smaller microphones came a need for matching microphone stands.

Our goal, however, was not to simply make a "pretty" stand, but to provide a design that eliminated several problems noted by studios using current stand designs. The stand had to be low and inconspicuous. It had to be simple, rugged, and easy to use. Assembly had to be quick, and ideally it should provide a degree of noise isolation in addition to simply supporting the microphone.

All of these goals were met in the new Model 421/422 desk stands. Designed to accommodate microphones held in either the Model 300 (1") or Model 310/311 (3/4") microphone clamps, the stands are less than 1" high and are available in two sizes: 3 1/2" x 3 3/4" or 4 1/4" x 4 1/2". The entire stand is composed of just three parts: a heavy metal casting, a rubber base, and a neoprene mounting insert.

The mounting insert is similar to a large grommet, and is easily pressed into the base casting. A microphone is attached by simply inserting the microphone clamp firmly into the neoprene insert where it is held by pressure of the neoprene. The design eliminates any threading or metal uprights.

By eliminating the upright, minimum height is achieved, varied by sliding the microphone in its clamp, or by tilting the microphone to the appropriate angle. In addition, the grommet provides part of the isolation from shock noise achieved by the stand.

Additional damping of noise is achieved by use of a relatively soft rubber pad that covers the entire bottom of the stand, rather than small, hard rubber feet. Use of a large pad also offers maximum resistance to sliding, even on very smooth surfaces. The low height and resistance to sliding creates a stable platform with minimum weight and complexity.

While a stand is perhaps incidental to the success of a microphone, attention to details such as this can contribute to the overall worth of a product. That's why Electro-Voice engineers continue to work closely with studio engineers to help solve their sound problems.

For reprints of other discussions in this series,
or technical data on any E-V product, write:
ELECTRO-VOICE, INC., Dept. 1093BD
686 Cecil St., Buchanan, Michigan 49107

Electro-Voice®

A SUBSIDIARY OF GULTON INDUSTRIES, INC.

Circle 16 on Reader Service Card

Letters

The Editor:

The July issue with its articles and information on television sound was one of the most informative published by db. It is good that we have the truths about the frustrations of good tv sound. Why this has never been said before, I'll never know, but now, at least, it has been.

It is interesting that so much reinforcement was added by the two articles from opposite coasts. Apparently, there is little doubt that the difficulties experienced in the east as explained by the transcript of the AES discussion on tv sound are little different from those so excellently expressed by Marshall King in his article on these facits as he sees them in Hollywood, California.

Now that these unhappy situations (and I am most distressed by the line-feed problems of sound deterioration) are illuminated, what is going to be done about them? How long, pray, is the television industry going to continue to have the attitude that the average listener/watcher doesn't appreciate quality—so why give it to him. It just isn't so. The movies have taught us that good sound enhances a good picture. The same can be true of television, but it is the industry leaders that must now establish the fact that this must be given to us. It would seem that if we can send picture and sound from the moon, we can surely send wide-band and low-distortion sound around the country.

Robert A. Ellis
Harrisburg, Pa.

The Editor:

In your August issue, Norman H. Crowhurst mentioned his book *TAKING THE MYSTICISM FROM MATHEMATICS*, in his column. I would like to obtain a copy of this book. Can you please tell me how I can arrange for this?

Edwin R. Esbensen
Monterey Park, California

The book is available directly from Mr. Crowhurst. Its cost is \$4.50. The author tells us that he will be pleased to send autographed copies if the correspondent wishes it. The manner of the autograph can be specified, if wished. Send orders with remittances to Norman H. Crowhurst, Box 651, Gold Beach, Oregon 97444. Be sure to include your complete return address. The book will be shipped prepaid for postage. —Ed.

Robert Bach
PUBLISHER

Larry Zide
EDITOR

Bob Laurie
ART DIRECTOR

Marilyn Gold
COPY EDITOR

Richard L. Lerner
ASSISTANT EDITOR

A. F. Gordon
CIRCULATION MANAGER

Eloise Beach
ASST. CIRCULATION MGR.

SALES OFFICES

New York
980 Old Country Road
Plainview, N.Y. 11803
516-433-6530

Denver
Roy McDonald Associates, Inc.
846 Lincoln Street
Denver, Colorado 80203
303-825-3325

Houston
Roy McDonald Associates, Inc.
3130 Southwest Freeway
Houston, Texas 77006
713-529-6711

Dallas
Roy McDonald Associates, Inc.
Semmons Tower West
Suite 411
Dallas, Texas 75207
214-637-2444

San Francisco
Roy McDonald Associates, Inc.
525 Market Street
San Francisco, California 94105
415-397-5377

Los Angeles
Roy McDonald Associates, Inc.
1313 West 8th Street
Los Angeles, California 90018
213-483-1304

Portland
Roy McDonald Associates, Inc.
2305 S. W. 58th Avenue
Portland, Oregon 97221
503-292-8521

Japan
TECHNOSERVICES, LTD.
31-16 Akazutsumi 1-Chome
Setagaya-Ku
Tokyo 156, Japan

The MM-1000 master recorder from Ampex.

Does some regional dialects too. Like Country and Western, Dixieland and even bits of Chicago Jazz. Depending on what you're in to.

The only professional audio recorder with a transport designed specifically to handle 2" wide tape. The same transport that sails through rugged everyday use on thousands of Ampex professional video tape recorders throughout the world.

Buy it in 8, 16, or 24 channels. If you decide to start with 8, you can expand later to 16 or 24. It's our heavy. Look into it. Could be just the thing for what you're in to.

Information from Ampex

401 Broadway, Redwood City, California 94063. Or call collect (415) 367-4400.



The machine that speaks two languages. Longhair and long hair.

While at the AES show visit the Ampex booths 39-42
Circle 17 on Reader Service Card

FOR EVERY PROFESSIONAL
APPLICATION

Nortronics
heads you right!

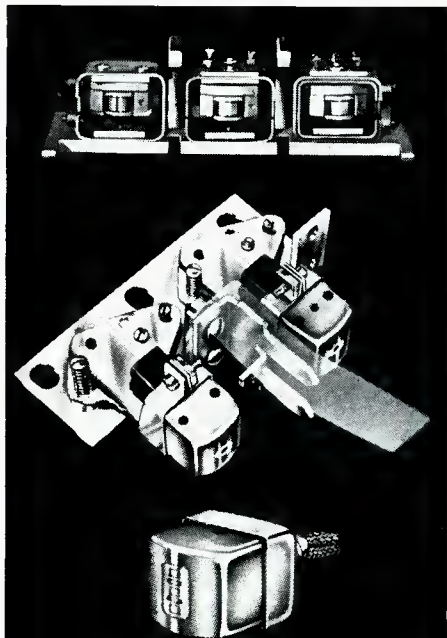

Nortronics heads offer excellent performance characteristics, long life, and quick, easy replacement with negligible downtime.

REEL TO REEL

AMPEX MAGNECORD SCULLY

CONCERTONE RCA CROWN

CARTRIDGE MOUNT

ATC COLLINS GATES

KRS MACARTA RCA

SPARTA TAPECASTER

Best of all,
you can get them locally from
your Nortronics distributor.

Nortronics
COMPANY, INC.

8101 Tenth Avenue North
Minneapolis, Minnesota 55427
Phone: (612) 545-0401

Circle 15 on Reader Service Card

The Audio Engineer's Handbook

GEORGE ALEXANDROVICH

GAIN CONTROLS

● Last month we started talking about the role of gain control in the chain of audio components and how it affects their selection for impedance matching. We have only briefly mentioned the types of gain controls available. Aside from text-book type variable pads there are a good number of unique devices each operating on principles other than just switching in passive pads. Theoretically, it is possible to achieve attenuation of a signal in at least a dozen different ways not mentioned in any text book. There is now a strong trend toward the use of FET's, light-sensitive devices, magneto-resistors, thermistors, and even strain-gauge type devices. New techniques involved in controlling gain evolve around the use of the mechanical and electrical control of light, magnetic fields or pressure. Electronic means of varying gain involve use of pulse-width modulation, varying the amounts of feedback, and others.

Before we tackle these new techniques and devices let us review the classical forms of variable-loss pads since most of the new control devices stem from them (or are closely related to them.)

As already mentioned the simplest

and the most widely used loss-pad configuration is the potentiometer. Although not very popular in professional circles, it can claim exclusivity in the commercial field. Normally it is a single or double section (for stereo) with the resistive element usually made out of carbon composition conductive plastic (military), or wirewound.

One of the most favored types of gain controls in the professional field is the so-called T pad (because it resembles letter T). It can be made to introduce either none or some insertion loss depending on the desired amount of isolation between the source and the load. A T pad offers constant impedance for both the input and output. Of course, in order to get the benefit of constant impedance, the load impedance has to be close to specified value. Improper termination will also result in shifting the amount of attenuation. If a high-impedance load is used, an additional terminating resistor has to be connected parallel to the load until the combined impedance is that of the required load. If a passive equalizer is connected after the fader (one which is impedance sensitive) then the impedance of the source looking into the T pad has to be trimmed so, that re-



THROUGH THIS DOOR

PASSES THE INDUSTRY'S MOST COMPACT 16 TRACK RECORDER WITH LOTS OF ROOM TO SPARE, AND LOTS MORE TO OFFER!

The 3M Brand 16 Track Recorder is unexcelled in the familiar studio game of squeezing the most out of floor space. Overall base dimensions are 27 inches wide by 22.5 inches deep. (In square feet that's only 4.2.)

But compactness is only a small part of the story.

Added to this space economy, studios continue to enjoy the top performance that has made 3M's professional audio recorder a new standard in the recording industry. In the last three years, playback pre-amp and overdub noise has been improved by

10 db. Mincom's exclusive Isoloop® tape drive utilizing a differential capstan maintains constant tape tension in just 3½" of unsupported tape. This results in the lowest wow, flutter and scrape in the industry. Erasure has been improved by 10 db.

Plus: DC transport and dynamic braking, advanced electronics, unequalled no-stretch no-snap tape handling, stable and rugged 1.5-inch cast top plate—and *Remote Sync Control, 7"x7"x4"*, included at no extra cost.

Write for details and specifications.

Mincom Division **3M**
COMPANY

3M Center • St. Paul, Minnesota 55101
300 South Lewis Road • Camarillo, California 93010

Circle 18 on Reader Service Card



**UNITED RESEARCH LABORATORY
AUTO-TEC**

The AUTO-TEC-L Tape Transport was designed first and foremost to utilize the massive 2" recording tape for up to twenty-four hour tracks. The AUTO-TEC-L Tape Transport incorporates a pair of synchronous direct drive capstan motors with their shaft sizes so arranged, to provide a differential closed loop for intimate tape to head contact and speed regulation. This arrangement yielded a flutter specification of DIN .05 percent peak to peak! The huge Transport utilizes the highest quality parts available including the miracle plastic "ML 6 COMPOUND" for its pinch rollers.

The motor function control circuits utilize the highest quality poly-phase switching relays. The AUTO-TEC-L Transport is very well suited for applications where reliability is a foremost factor. The illuminated controls are totally interlocked and incorporate an electronic motion control (pat. pending) with second command memory. The ultra precision head assembly is completely and INSTANTLY INTERCHANGEABLE without the removal of head covers or cable disconnects. The AUTO-TEC-S, a smaller identical version of AUTO-TEC-L, is available for 1/4" and 1/2" tape — also rendering outstanding specifications at a price competitive with Transports offering single Capstan Tape Drive.

**INCORPORATED FEATURES OF THE
AUTO-TEC-L TRANSPORT . . .**

Dual Closed Loop Capstan Drive

Pinch Rollers of ML 6—High Coefficient of Friction, Plastic-Like Material

Head Assemblies Instantaneously Changeable (plug-in)

Quick Change Guides

Electronic Motion Sensing (pat. pending)

14" Reel Capability

Super-Heavy Duty Relays

Illuminated Push Buttons

Optional . . .

Logic Input Control

Tape Position Sensing

Automatic Reeling to and/or between points (as reel to reel Duplicator Master)

AMPLIFIERS . . .

Programmable Automated Remote Overdub Control. Prevents out of sync playbacks and reoccurring overdub track assignment.

NAB Equalization

All Controls of Adjustment, including Record and Reproduce Level, are on one plug-in interchangeable Circuit Card, so arranged that all controls are screw-driver accessible from the front of Amplifier.

Operational Amplifier Design

Small Size

Mill-type A N Connectors

Cannon Connectors — Input and Output

AND, OF COURSE . . . COMPETITIVELY PRICED.

**UNITED RESEARCH
LABORATORY**

DEVELOPMENT DIVISION OF UNITED RECORDING
LABS, INC.

681 Fifth Avenue • N. Y., N. Y. 10022 • 751-4663

Circle 13 on Reader Service Card

lected impedance at the output of the gain control is constant and of correct value. With tube-type equipment (amplifiers) restrapping of the output transformer is required to select output impedance. In transistorized amplifiers, if the output impedance is lower than the required value, a fixed resistor in series with the output does the job. To eliminate needless voltage loss, a step-up transformer can be employed, again using resistor in series with the amplifier output (but smaller, approximately by the step-up ratio of the transformer).

Although the T pad maintains its impedances constant and does everything a gain control is supposed to, it is not recommended for low-level circuits because contact noise does not diminish with the increased attenuation or lowering of the signal. (As per one leading manufacturer's recommendations.) For that matter, I would not recommend the use of any gain controls in the low-level circuits. The lowest level we normally encounter is mic level, we know that if we allow the signal along the path to the output of the system to fall below this level we loose on s/n. Even padding condenser mics (although sometimes absolutely necessary) is theoretically wrong. However, it is cheaper and more convenient to lower the output of the hottest mic than add an amplifier stage to the low-output mics.

One of the solutions to the noise problem in the T pad was the invention of so called ladder networks. This circuit consists of many pi pads connected in series. A ladder attenuator is simpler to construct, it is more reliable and noise diminishes with attenuation. But it fails to maintain the impedance constant at the extremes of the range. Maximum attenuation attainable is about 120 dB.

These are the three basic types of variable pads used in our industry. They each come unbalanced and balanced. Performance of each of the types depends considerably on the construction, materials used, and user knowledge of how to employ them. As I have mentioned several times before, improper wiring of grounds may limit maximum attainable attenuation. Leakage in today's consoles between channels or in the fader (when it has to be at infinity setting) is expected to be very low, an improperly wired ground will defeat that. Don't use a single wire to connect the fader ground to both input and output grounds, but use fader lug(s) as a tie point.

Like other devices with moving contacts and mechanical parts, all of these faders are subject to malfunction due to contamination of contact area, oxidation, and normal wear. In the attempt to improve the reliability of gain control devices many new approaches to con-

trol gain are finding application. Most of them are presently in development stages or are used in the circuits of sophisticated space gear. Some are already here but have not found wide acceptance yet.

Take for instance, a simple rheostat to trim the gain of the amplifier in the feedback loop. Although limited in range, this is a very affective means of controlling mic preamp gain. Or consider use of FET's instead of potentiometers or rheostats. The use of magnetoresistors between the two mechanically movable magnetic poles offers fantastic reliability factors. These methods are currently being looked into. (Who can afford a device with the same kind of reliability factor but resembling a modified pi network, and consisting of a light-sensitive comb-like pattern illuminated by a mechanically moving solid-state light which acts as a moving contact).

Many of the attempts to get away from rusty old-fashioned ways of doing things involves the elimination of sturdy (but crude) hardware by replacing it with components which can be lost on the head of the pin. Our new world of expanding audio is crying for simplification of equipment with increased reliability and lower cost. Our good old reliables have become cumbersome heavy pieces of equipment—hard to use, service and install.

The availability of new elements and materials along with growing experience in manufacturing and circuit design is suggesting their use. Stepped attenuators are fine *if* there is no good way of performing attenuation smoothly. Maintaining impedance is nice if you *have* to, but if it means sacrificing reliability and compactness and if there is a simpler way to achieve the same result—your mind should not be locked. Nobody today in his sane mind would use tubes where one could put transistors. (Would they?)

Consider another fact: there are many requirements today that are simply not possible to be met with old equipment. With multi-track recording, how do you control 8 or 16 channels at once—using mechanical faders? It's highly impractical. Or how would you control the gain of a multi-channel p.a. system in a theater, keeping it inconspicuous from the audience. Using light-sensitive controls is one solution to the problem. There are other ways of solving them too, but they haven't been developed yet for audio. We can shovel moon dust or photograph Mars from close up, but we are still incapable of meeting the simplest needs for convenience in our studios and control areas.

I have prepared a comparison chart of the various attenuator types. It represents the average performance of

**You're in
good
companies
when you buy
a system
from us.**

Alderman Studio — N.C.
American Film Institute
Beach Boys
Capitol Records
GRT
Jack Music — Nashville
Landmark Tower — Las Vegas
MGM Studios
Momentum Studio
Music Recorders
Pacific Recording
Poppi Studios
Record Plant
TV Recorders
U.C.L.A. — Theatre Arts
United Sound Recorders

 **QUAD-EIGHT
ELECTRONICS**
11810 VOSE STREET, NORTH HOLLYWOOD
CALIFORNIA 91605 • PHONE (213) 764-1516

Booth Number 16 37th AES Convention.

Circle 14 on Reader Service Card

Illuminated Scale Linear Motion Fader MODEL 440



- Infinite resolution—truly stepless
- Resistance element material developed for MIL Spec and Aerospace applications—rated in “millions of cycles” of operation.
- Multiple finger, precious metal wipers
- Very low noise
- Long Life
- Adjustable damping
- Illuminated scale markings
- 100,000 hour scale illumination lamps
- Internal SPDT switch operates in Off or Infinity position. Can be used for “Cue” (Pre listen), or control of scale illumination, tally lites, etc.
- Element and slide mechanism are dust protected
- Special Rulon* and Nylon* bearings for smooth action
- Polarized, right angle connector, gold plated contacts
- Standard size for direct replacement
- Available without illumination for below panel installation and supplied with engraved formica overlays for replacement in milled panels or in strips.
- Color coded knobs—five colors

Making use of a newly developed, mirror finish, resistance material which is finding extraordinary success in the precision military and aerospace potentiometer field, Automated Processes has developed a Linear Motion Fader of ideal characteristics for the audio industry.

The Model 440 Fader's conductive plastic element and precious metal wipers provide very long life and noise free operation. The unit is stepless and provides smooth fading over its entire range.

Scale designations are illuminated and provide an attractive appearance as well as increased readability in low light level environments.

The slide mechanism is smooth in operation and is provided with a pressure adjustment to vary the damping to suit operator preferences.

*Trademark

 **Studio Systems Division**
AUTOMATED PROCESSES, INC.
35 CENTRAL DRIVE
FARMINGDALE, N.Y. 11735
516-694-9212







	carbon potentiometer	stepped potentiometer	wirewound potentiometer (ww)	variable "L" pad	variable "T" pad	ladder network	modified double "L" pad, LDR control
diagram							
input impedance	const. w hi Z load	const. w hi Z load	const. w hi Z load	const. w hi Z load	const.	const. exc. in "0"	const.
output impedance	var.	var.	var.	var.	const.	const. exc. in "0"	const.
insertion loss	none	none	none	none	0-6 db	8 db	3db
maximum attenuation	50-60 db	100 db or more	100 db or more	100 db	100db	120 db	125 db
noise	high	low-med	low-med	med	med	low	low
resolution	infinite	up to no. of steps 1-2 db step	several steps db	several steps db	if stepped see stepped pot. if ww see ww pot.	same as "T" pad	infinite
multichannel operation	up to 4	up to 2	up to 2	up to 2	up to 4	up to 4	unlimited
life	short to medium	long	long	long	long	long	long
precision	poor to adequate	good to excellent	good	good to excellent	excellent	good	adequate to good
remote control	no	no	no	no	no	no	yes
reliability	good	excellent	very good	very good	very good	very good	good
size	small	med.	small	med to large	med. to large	med. to large	med. to large
cost	low	med-hi	med	med-hi	high	med-hi	med-hi
maintenance required	hard to clean	cleaning & labr.	clean, if worn-repl.	cleaning & labr.	some brands sealed for life	some units sealed, some cleaning required	change lights & clean

Figure 1. A comparison of various attenuator types.

the types of controls, based on experience in the field, and the theoretical reliability factor derived from the number of component parts subject to wear, failure, or in need for maintenance. The ratings given to each type do not in any way take into account products of a specific manufacturer but it offers a generalization of related products. Reliability and cost vary with different manufacturers as well as over-all performance.

This chart doesn't take into account the latest improvements made in the field of carbo-deposition-composition controls, along with availability of conductive plastic devices just appearing on the horizon (extensively used by the military and NASA), with performance as good or better than metal-contact controls. Left out also are the devices such as circuits using light-dependent elements with a gallium arsenide diode as the light source.

Most of the newest devices mentioned above are still in the stage of development waiting for the wide market when mass-production techniques will lower the cost of the unit so that it becomes acceptable to the audio industry.

In last month's column I briefly described the vu indicator which is manufactured by the Electrodyne Corp. Because information on the Altec unit model 9713A, a device similar to Electrodyne's, was not available at that time, I am including a brief description now.

Altec-Lansing's *Colorflo Modulite* displays audio peak levels in seven ranges, the highest level being 4 dBm. The indicator scale is made of tinted display windows with the percentage modulation indicated on each. The total audio range covered is 28 dB, and the power required is 24V d.c. at 300 mA.

Small size of the unit permits packaging of up to 24 units in 2 feet of space (1-inch wide x 4 1/4-inches high x 3 3/4-inches deep). Additional information on sensitivity, loading effect, reaction time, and accuracy may be obtained from the manufacturer

Altec Lansing Corp.
1515 Manchester Ave.
Anaheim, Calif. 92803
or from their local representatives.

More than 1000 standards

Altec attenuators are the standard of the broadcast and recording industry. And not only do we make them better, but we make more of them—over a thousand different kinds of rotary and straight line attenuators for every broadcast and recording requirement.

Available are bridging pads, precision decade attenuators, projection and turntable faders, fixed loss pads, mixer networks, minimum loss matching pads, impedance matching networks, stereo pan pots, calibrated attenuators, rotary differential attenuators, mixer controls, grid control pots, VU meter extenders and many more.

Variety is only part of the story. Every Altec-built attenu-

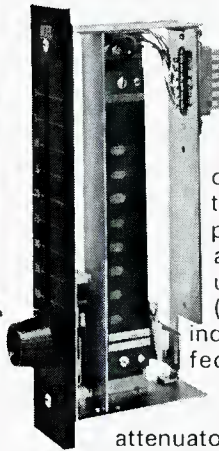
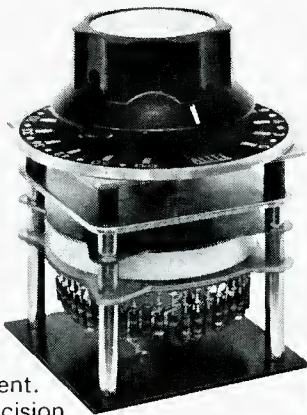

Units shown with cases removed.

ator will last hundreds of thousands of operations. Precisely constructed, they're also "overbuilt"—for rugged dependability. Electrical integrity is assured, too, because of our exclusive use of cold-forged contacts of fine (100%) silver; also pure silver brushes, individually suspended to maintain perfect contact. Noise-free operation is further assured by dust-tight cases.

The most commonly needed Altec attenuators are available off the shelf. Custom configurations will be made to your exact requirements. For a complete catalog of the Altec attenuator line, please write.

and a brand-new hit.

Our new illuminated audio peak reading indicators are bound to be a hit with recording engineers. Levels are indicated by a slim, vertical column of different colored lights. Each light represents a percent of modulation—blue: 6% (−24dBm); green: 16% (−16dBm), 25% (−12dBm), 40% (−8dBm), 63% (−4dBm); yellow: 100% (0dBm); and red: Overload (+4dBm). Overload represented by a red light is easily spotted, even out of the corner of your eye.

Are they responsive? More so than any regular meter movement, because the lights are triggered by solid-state circuitry.

(Actual size; 4¼" H x 1" W x 4" D—including terminals)

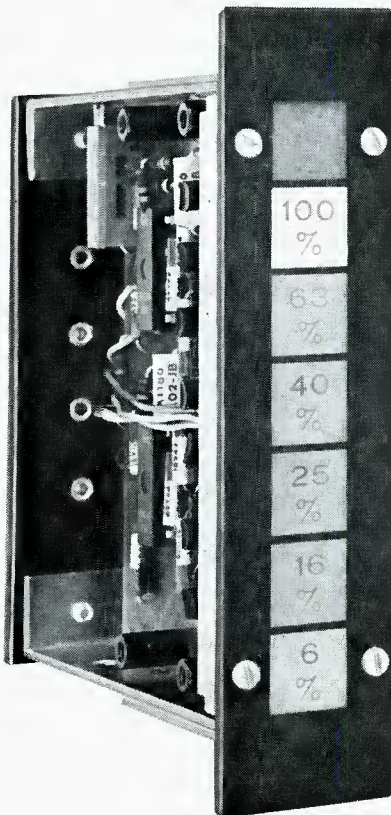

Other benefits, too. Like size: Each indicator can be mounted on a 1" center.

For more information about this revolutionary product, please write for literature on the peak limiting indicator, model #9713A.

Altec Lansing, Dept. DB-10
1515 So. Manchester Ave.,
Anaheim, Calif. 92803

- Please have authorized Altec representative call with complete information.
- Please send catalog "Altec Precision Attenuators and Networks"
- Please send information on Altec's new audio peak limiting indicator Model #9713A.

Name _____
Company _____
Street _____
City _____
State _____ Zip _____

Patent Pending

1515 So. Manchester Ave., Anaheim, Calif. 92803
A Division of LTV Ling Altec, Inc.



Stereo components and ensembles for the home/Microphones, speakers, horns, amplifiers for public address systems/Acousta-Voice (TM) equalization/Audio controls, consoles, monitors for professional recording, broadcast and motion picture studios/Telephone transmission and termination products/Communications equipment for offices, factories, commerce, schools, hospitals, nursing homes, doctors' registry/Specialty transformers, filters, inductors, inverters.

Circle 24 on Reader Service Card

Theory and Practice

NORMAN H. CROWHURST

●Applying the insertion-gain definition to amplifier specifications certainly removed much of the ambiguity. But there are still some loose ends. To illustrate, let us assume we are using a line amplifier before and after a fader.

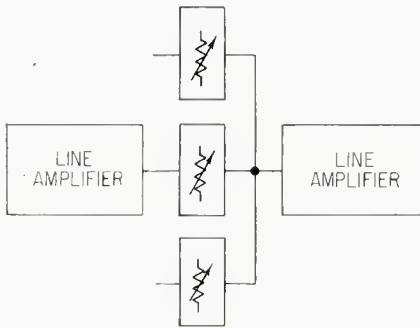

Figure 4. Using a 6-way mixer, fed from ideally-matched line amplifiers, and feeding into another, all of the impedances being 500 ohms.

This could be one of several mixers, or a single level control (FIGURE 1).

To allow for the possibility of several mixers or other outlets being fed from one source, it is not unusual for the internal output impedance to be much lower than the nominal load value (FIGURE 2). This allows more than one circuit to be fed, without serious level loss. Also reducing the same loss can be effect to using a higher input impedance than nominal.

Thus, if our nominal impedance is 500 ohms, at which impedance the mixers and faders are designed to operate, the output internal impedance may be 100 ohms or less, and the input

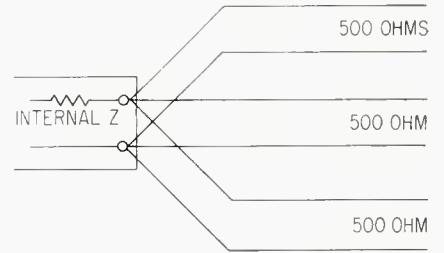
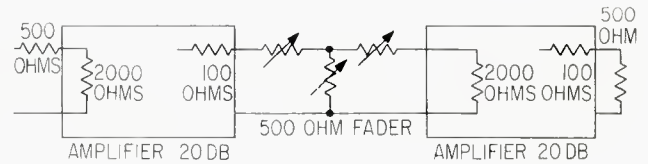

Figure 2. Sometimes the same line amplifier may be used as the source for several possible outlets, in which case using an internal impedance lower than individual output impedances is an advantage.

impedance may be 2000 ohms or higher. Let's assume that two such line amplifiers are used, one before and one after the fader (FIGURE 3).

With the fader all the way up (all attenuation removed) the input to the second amplifier is directly connected to the output of the first. Assuming each amplifier is rated at 20 dB gain, with an input level of 2 millivolts through 500 ohms to the first amplifier, the second

Figure 3. The case considered here: a fader between two line amplifiers of a hypothetical type discussed in the text.



amplifier should deliver an output of 1 volt into a 500 ohm load. But it won't!

If the first amplifier is loaded with 500 ohms, as it will be when considerable attenuation is inserted by the fader, it will deliver 100 mV of output. This means the internal voltage (open circuit) will be 120 mV, assuming the internal impedance is 100 ohms.

If the second amplifier is fed with 200 mV, through 500 ohms, it will deliver the expected 1 volt of output. But it is fed with 120 mV through 100 ohms, when the fader is all the way up. The 200 mV input would produce 160 mV across the 2000 input impedance. And the 120 mV will produce 20/21 of this, or about 114 mV across the same input impedance.

So the actual output will not be 1 volt, but 114/160 of this, 0.71 volt—about 3 dB short of rated output.

Now assume the fader is turned down 20 dB. Both the input and output to which it is connected will now see fairly close to the nominal 500 ohms. So the over-all gain will be $20 + 20 - 20 = 20$ dB. Now the ratings will hold closely.

This means that turning the fader all the way up will lose gain, particularly on the last little bit. If it is a stud-type fader, designed to change gain 1 dB per stud, the last few studs will add considerably less than 1 dB per stud, so that when it is all the way up, the total

manager, electronic development engineering

Want challenge and opportunity? We are seeking an exceptional person to manage the electronic development engineering activities of Capitol Industries Inc., a dynamic, growth oriented corporation. The person selected will coordinate the activities of the department in the design and development of advances in sound recording and reproduction techniques at and beyond the state of the art.

To assume this senior level challenge you should have at least a BSEE with seven to ten years of progressively responsible experience in electronics, with the majority of it in audio engineering, preferably in recording or a closely related industry, at a supervisory level.

The professional work environment, the pay, and the Southern California climate are but a few of the attractions.

Professional Employment



1750 N. Vine, Hollywood, Calif. 90028



CUSTOM 16 CHANNEL CONSOLE by Audio Designs

Fine Recording, New York*, feels they're onto something good in consoles. When they needed a 4 channel console in January, 1968, they ordered it made by Audio Designs & Manufacturing, whose reputation for design and quality was already well established. In the summer of 1968, Fine Recording called again on Audio Designs to construct an 8 channel console. Audio Designs' consoles apparently work well — Fine Recording Studios are now using this remarkable 16 channel console made by Audio Designs, including their unique Audex Switchers.

If you want to get onto something good in consoles . . . call Audio Designs. You can get a quality console designed, engineered, manufactured and delivered at a price competitive with most "stock" consoles. You'll be getting a console that does "exactly" what you want it to do . . . fits "exactly" where you want it to fit. For consultation and estimates on a console to meet your exact audio recording requirements, write or call . . .



*Fine Recording, Inc., Subsidiary of Vidcom Electronics, Inc., New York

AUDIO DESIGNS / 15645 Sturgeon / Roseville (Detroit), Michigan 48066 / (313) 778-8400
Circle 25 on Reader Service Card

GATELY "BUILD-YOUR-OWN" AUDIO SYSTEMS

the performance you need...at a price you can pay

GATELY AUDIO SYSTEM NO. 4
(Deluxe 4-track recording console)
Information on other systems available upon request

4 Mics
2 Lines From Recorder

4 Mics
2 Lines From Recorder

To 4 Track Recorder

To MP-2,
To Stereo &
Mono. Recorders

Why pay twice as much for a console with capabilities beyond your requirements? Gately's "build-your-own" audio systems allow you to choose components to meet your immediate needs. And you can add components if requirements increase. So why delay? Have your dealer or Gately Electronics recommend the right system to give you 2, 4, or 8 channel mixer-equalizer capability—at half the cost!



GATELY ELECTRONICS

57 West Hillcrest Avenue, Havertown, Pa. 19083 • (215) HI 6-1415
...have you checked Gately lately?

Circle 20 on Reader Service Card

STEP UP

...to the finest transcription turntable in the world!

THORENS

If you're settling for less than the entirely new THORENS TD-125, or it's the integrated 2-speed companion, the THORENS TD-150 AB, you're making do with less than the best! THORENS TD-125; \$185.00 less base — THORENS TD-150 AB; \$110.00 with arm & base.



Endorsed by Elpa because it successfully meets the stringent standards of performance Elpa demands. Write for full THORENS details. Elpa Marketing Industries, Inc., New Hyde Park, N. Y. 11040

Circle 21 on Reader Service Card

gain is 3 dB short of the expected value.

If this was the way all such amplifiers would be used, the discrepancy could be avoided by designing the amplifiers so their internal impedance precisely matches the nominal impedance with which they are to work. With transistorized circuitry, this isn't too hard to do. But now what happens when they are used with, say, a 6-way fader (FIGURE 4)?

In the first place, regardless of fader setting, the impedance seen at the output end of the faders will be $500/6 = 83$ ohms. So the follower amplifier will be working from 83 ohms, instead of 500 ohms. Also, each fader will be working into a load of 83 ohms, rather than its nominal 500 ohms. Each one will be loaded by 5 other faders, and the amplifier input, each of value 500 ohms.

So now the faders will be working into a serious mismatch. However, the mismatch will be constant. Whether the attenuation in the faders is zero dB or 20 dB, or any other figure, something that reflects forward as 500 ohms is terminated by 83 ohms, resulting in about 9 dB loss. So, provided we allow 9 dB more gain, to make up this loss, it's all right isn't it?

Well it may not be. You see, these amplifiers are probably designed to give their correct performance when terminated at both input and output with 500 ohms external impedance. The output amplifier is always terminated with 83 ohms instead of 500, so if this causes improper performance, it will do so all

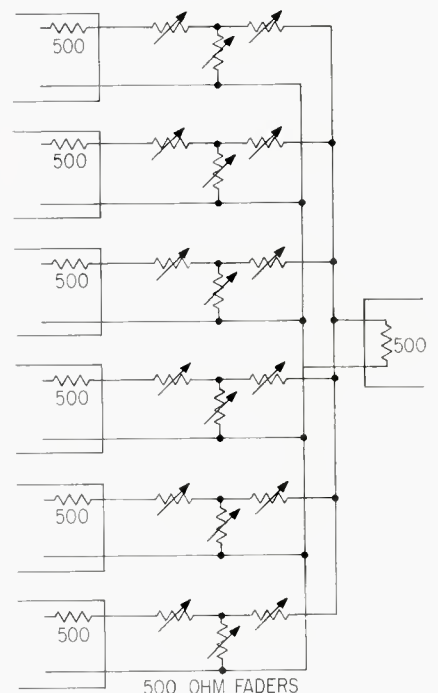

Figure 4. Using a 6-way mixer, fed from ideally-matched line amplifiers, and feeding into another, all of the impedances being 500 ohms.

Get a \$295 tape timer

Free

An impossible dream?

Not when you buy the Studer A-62 studio tape recorder.

It's got every feature you've ever looked for in a professional tape recorder—plus others you'll find only in ours. Like the tape timer. It's *not* the famous Lyrec TIM-4 you know so well. This one's built in to the deck.

To get a direct reading in minutes and seconds, just run the recorder, even at fast speed. (The Timer's accurate to within 3 seconds in a ½ hour tape.) In the time it takes to rewind, your program will be timed.

We've also developed an electronic forward regulating servo loop that keeps the tape tension constant—regardless of reel size. Even the smallest reel hub won't cause any problem. So there's no speed variation, no need for reel size switching, and no varying tape tension. Ever.

And the Studer A-62 practically takes care of itself. It's precision-made by the Swiss. So it will run like a dream. A not-so-impossible dream.



GOTHAM
AUDIO CORPORATION
2 West 46th Street, New York, N.Y. 10036 (212) CO 5-4111
1710 N. LaBrea Ave., Hollywood, Ca 90046 (213) 874 4444
In Canada: J. Mar Electronics Ltd.

We're very close to a lot of famous people.



This close. And even closer. To the Rock-ers and the Bach-ers. To the string sections and the swing sections.

Because Neumann's U-87 is made that way. It's the only condenser microphone designed to work up-close without distortion. And with absolute fidelity.

It has three-directional patterns. An overload protection switch. Base roll-off switch. And, of course, it has the distinguished Neumann insignia on the front—the world-famous standard of excellence.

The U-87 also has one dis-advantage: We've had reports of lipstick on the grille, because performers can get so close to it.

If you can put up with *that*, we promise you the greatest separation and presence ever.

Cost: \$336, including cable and mount, and then you're ready to compare the U-87 with any microphones you've ever used. You'll see, they don't even come close.

Write today for our free brochure.

GOTHAM
AUDIO CORPORATION
2 West 46th Street, New York, N.Y. 10036 (212) CO 5 4111
1710 N. LaBrea Ave., Hollywood, Ca 90046 (213) 874 4444
In Canada: J. Mar Electronics Ltd.

Batteries, Modulation and the Phantom™

The transistor has emancipated condenser microphones from bulky power supplies... almost! It is true that both voltage and current needed for today's transistor condenser microphones have shrunk considerably; and with it, the size, weight and price of the box on your studio floor.

There are now basically two powering categories: AC power supplies and batteries. I'd like to discard the idea of battery power in fixed professional studio locations. They are simply too unreliable, unpredictable and untrustworthy. That leaves us with AC powered supplies, and there we find three basic systems: A-B Powering in which the DC voltage (usually under 14 V) is applied directly to the two modulation leads; multiplex powering in which the DC voltage (under 12 V) is applied to the modulation center tap; and Phantom™ Powering, applying 48 Volts DC to the modulation center tap.

Now, the details:

1. A-B Powering renders the microphone output circuit poorly balanced, while outlets so equipped cannot be readily used for any other kind of microphone. Aside from that a DC/DC converter (oscillator) must be used to obtain the 50 V or so needed for polarization. High power drain.

2. Multiplex Powering solves the problem of circuit balance, but still requires a power consuming DC/DC converter, draws 5 mA of current through the cable shield (poor practice) and causes problems in isolation between microphone outlets.

3. ONLY NEUMANN offers PHANTOM™ Powering! Again perfect circuit balance; 48 V supply requiring NO DC/DC converter (only one transistor in each microphone); 0.4 mA power drain per unit; high circuit isolation; total compatibility with any other microphone; and central powering for up to 40 microphones from a miniature supply costing only \$84.

Why, then, aren't all manufacturers going to Phantom™ powering? Some entered the field before this system was developed and now have a group of customers who don't want to change. Others followed the politically-motivated, half-hearted decisions of standard setting administrative engineers. Only NEUMANN was free to choose because as always NEUMANN is *last*... but *best*.

Stephen F. Temmer
President
Gotham Audio Corporation

P.S. NEUMANN also makes an A-B powered microphone series at higher cost, if you "standardized" too early.

beyond the state of the art



SPECTRA SONICS announces a rack-mounting limiter/compressor so new—in both concept and performance—that it requires a new name: **COMPLIMITER™***. It performs the functions of peak-limiting and volume-compression, either independently or simultaneously, as a direct function of the type of program input and amount of compression desired with performance that is unequaled by most linear amplifiers! As the fastest of all peak-limiting devices (100 nanosec. to 2 microsec.), peak-limiting can be employed with no audible distortion of any kind, thus allowing undistorted recordings (typically less than 5/100ths of 1%, 30 Hz to 20 kHz) at significantly higher than conventional "0" VU (+4 dBM). Available only on the Model 610 **COMPLIMITER™**: visual lamp indication for essentially instantaneous peak-limiting and also for system overload; continuously variable compression ratio from 1.1:1 to over 100:1. For the smoothest inaudible protection available, order your Model 610 **COMPLIMITER™**.
Now!

Contact your distributor, write or telephone:

SPECTRA SONICS

LEADER IN ADVANCED TECHNOLOGY

770 Wall Ave.

Ogden, Utah 84404

801-392-7531



*U. S. Patent No. 3,376,515 and other Patents Pending

the time. And each input amplifier is terminated with 500 ohms when considerable attenuation is in use, which drops to 83 ohms when the fader is all the way up.

The amplifiers may use linearizing

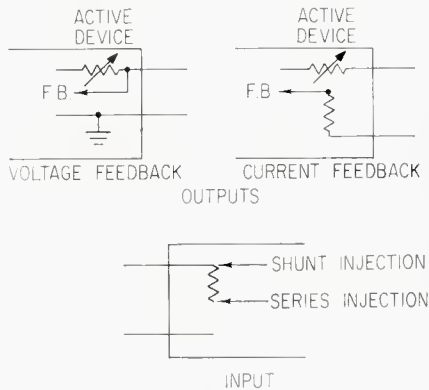
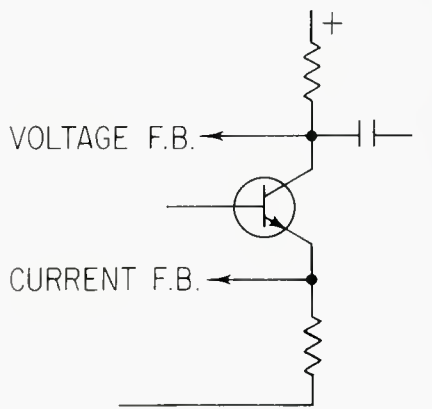
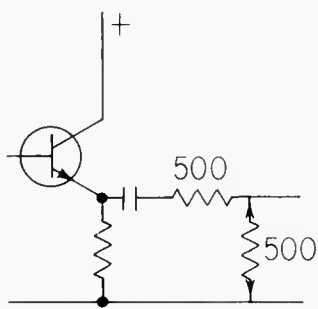

Figure 5. Different ways of using feedback for internal impedance control. To control output impedance, voltage or current feedback can be used to control input impedance, series or shunt injection can be used.



(A)



(B)

Figure 6. Different ways of achieving output internal impedance: (A) using voltage and/or current feedback, applied over the active device (shown here as a transistor); (B) using an actual internal series resistor from a stage (shown here as emitter follower) that is essentially constant voltage, or zero impedance.

← Circle 27 on Reader Service Card

CLASSIFIED

Classified advertising is an excellent and low-cost way to place your products and services before the audio professional. If you are a prospective employer seeking skilled help or an employee seeking a change you will find that the classified pages of **db** reach the people you want. Special low rates apply for this service.

Rates are 50c a word for commercial advertisements. Non-commercial and employment offered or wanted placements are accepted at 25c per word.

Frequency discounts apply only to commercial ads and are as follows.

3 times - 10%

6 times - 20%

12 times - 33 $\frac{1}{3}$ %

Agency discounts will not be allowed in any case.

Closing date for any issue is the **fifteenth** of the **second** month preceding the date of issue.

STEP UP

...to the finest tape splicing system in the world!

EDITall®

Order direct! Start with the Introductory Editall tape splicing kit—the KP-2. Includes splicing block, 30 splicing tabs, carbon marking pencil, cutting blade and a complete instructional guide for better tape splicing. Only \$3.50. Includes postage and handling.

If you're settling for less than the Editall System, you're settling for less than the best!

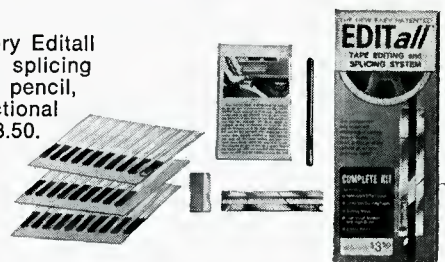

Endorsed by Elpa because it successfully meets the stringent standards for performance Elpa demands.

Elpa Marketing Industries, Inc., New Hyde Park, N. Y. 11040

Circle 19 on Reader Service Card

feedback, intended to both yield the correct terminal impedances and linearize gain, that operates correctly when the amplifier is correctly terminated at both ends. The feedback may use either voltage or current derivation from the output signal, or some of each, and be injected either in series or parallel at the input (FIGURE 5).

Of course, it may not be the same feedback, probably isn't, so that errors in termination do not reflect through the amplifier, to make the termination (internal) incorrect at the other end. But if the output uses voltage feedback, predicated on a 500-ohms load, using an 83-ohm load, as happens when the fader is all the way up, will reduce feedback by some 9 dB. If it is current feedback, the amount may be increased by almost 5 dB.

On the input end, the effect may not be so direct. Correct impedance is usually achieved by an actual resistive impedance, possibly modified by feedback. While the external impedance connected can affect the internal feedback in some circumstances, it depends to what extent the external feedback modifies the internal feedback loop.

At the input end, it is feasible to use passive impedance synthesis, which means it's made of actual resistors, whose value combines to the required result. At the output end, using passive resistors to pad out impedance to a

nominal value, inevitably means the level delivered by the active devices must be higher.

For example, if the rated output, delivered to a 500-ohm load, is 1 volt, and the internal impedance is synthesized by feedback applied over the active device (FIGURE 6), the maximum level the active device needs to deliver is 1 volt. But if the active system must deliver 2 volts, so that half of this can be dropped in a passive internal impedance, the level handled by the active device is doubled.

If distortion is predominantly second harmonic, and that order, doubling the voltage or current level will quadruple the harmonic level, or double its percentage, so that twice as much feedback is needed to achieve comparable linearity.

If distortion is of higher order, the amount of extra feedback needed will be increased according to the order of distortion produced. If the distortion is essentially clipping, no amount of feedback will reduce it materially. All that feedback can do in this circumstance is to make the rest of the waveform more "perfect", so the clipping tends to be more noticeable.

In some circumstances, feedback used over a circuit that produces clipping can make matters worse, by changing the circuit bias in a direction that makes clipping happen earlier.

BUILDING BLOCKS TO SOUND SYSTEMS

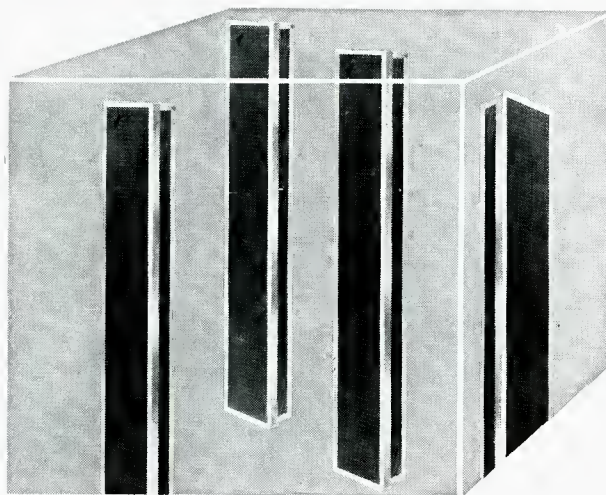

A complete line of Indoor and Outdoor Sound Columns—to beam sound exactly where you want it

□ Sound Column's bicone speakers create a flat, fan-shaped beam of sound that can be aimed as required with great accuracy—quality audio is easily distributed even in very noisy surroundings □ Reverberations and echoes are more easily controlled or eliminated □ High fidelity audio coverage over the full frequency range from 60 Hz. to 18 KHz. □ Fine, rich reproduction of

music □ Handsome birch or walnut veneer cabinets available □ Adjustable brackets for mounting to wood, masonry, concrete or steel □ Write for "Sound Column" applications bulletin to the innovators.

Norelco PHILIPS BROADCAST EQUIPMENT CORP.

One Philips Parkway, Montvale, N.J. 07645 • 201/391-1000
A NORTH AMERICAN PHILIPS COMPANY

Circle 35 on Reader Service Card

Driving without safety belts is really asking for it.



Advertising contributed for the public good



Many readers do not realize that they can also be writers for db. We are always seeking good, meaningful articles of any length. The subject matter can cover almost anything of interest and value to audio professionals.

Are you doing something original or unusual in your work? Your fellow audio pros might want to know about it. (It's easy to tell your story in db.)

You don't have to be an experienced writer to be published. But you do need the ability to express your idea fully, with adequate detail and information. Our editors will polish the story for you. We suggest you first submit an outline so that we can work with you in the development of the article.

You also don't have to be an artist, we'll re-do all drawings. This means we do need sufficient detail in your rough drawing or schematic so that our artists will understand what you want.

It can be prestigious to be published and it can be profitable too. All articles accepted for publication are purchased. You won't retire on our scale, but it can make a nice extra sum for that special occasion.



STUDER A 62

A solid state and professional tape recorder of the highest studio quality, easily transportable. Modern design concept: compact modular construction, electronic tape tension control, simple straight tape path. Clear layout and easy operation, electric push buttons, all tape transport functions can be remote controlled. Suitable for vertical mounting.

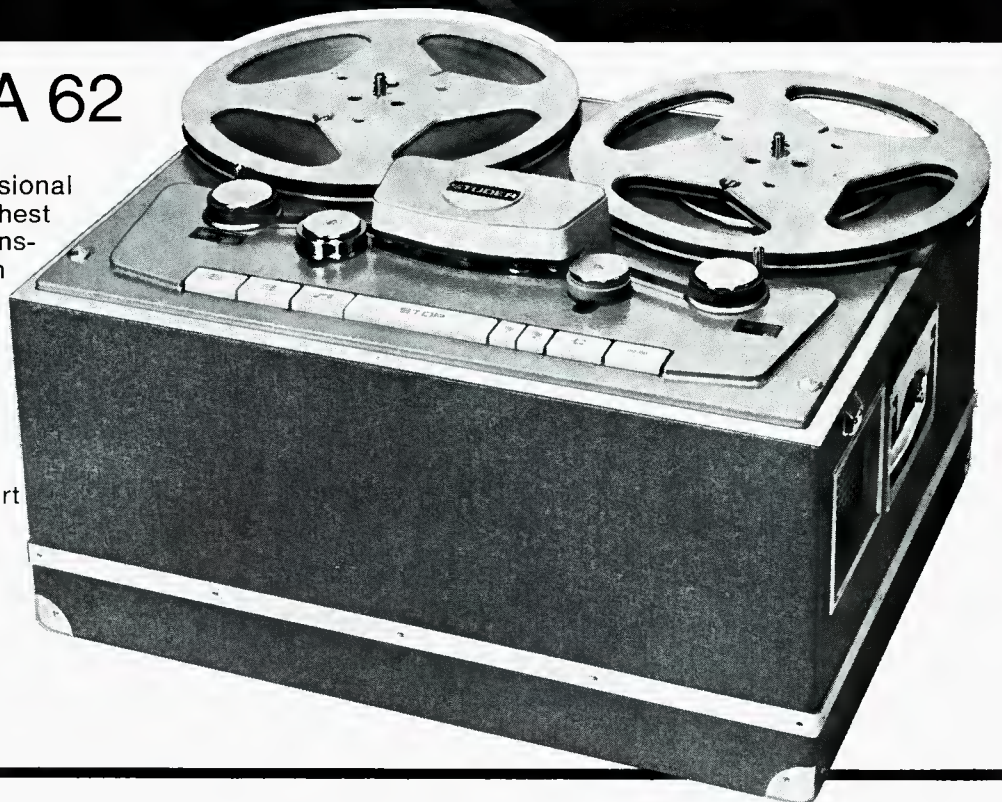

EMT WILHELM FRANZ GMBH
5430 Wettingen (AG), Switzerland

Circle 34 on Reader Service Card

Sound with Images

MARTIN DICKSTEIN

AUDIO VISUAL EQUIPMENT III (SOME MISCELLANEOUS DEVICES)

● Following the previous discussions on 16mm film and 35mm slide projectors, it would seem logical to conceive of a device which would be available to provide an image from a strip of film but showing one frame at a time. Such a unit is made by approximately twenty manufacturers and is called a filmstrip projector.

The method of operation is quite simple, combining the operation of a film projector (pulling a strip of film past an opening) with a slide projector (stopping at each picture and requiring an automatic or manual impulse to proceed to the next frame). The aperture width is 0.885 for this type of film (between 16mm film and 35 mm slides)

and lenses from 3 to 8-inches are available for most models, with some offering a range from 1 to 11-inches. To indicate the difference between aperture openings (1.34 for slides and 0.38 for 16mm film) and lenses with regard to image size, a 35mm slide (double frame 2 x 2) will almost fill an 8-foot wide screen with a 3-inch lens at about an 18-foot projection distance. For the same focal length lens, a 16mm film will about fill a similar size screen at approx. 63 feet and a filmstrip projector will fill an 8-foot screen with a 3-inch lens at 27'.

The simplest model is the silent unit with the teacher or lecturer providing the voice commentary and switching frames as desired. Units are available which incorporate an automatic timer. This type can be set for the specific delay and a taped music background used in conjunction with the presentation, but without direct synchronization.

Of the more complex units, there are models which provide sound from records or from built-in tape cartridge playback units. Advancing of the frames can be accomplished either manually or automatically (from tones on the sound tape or disc). Amplifiers range from 1 watt to 10 watts with the greatest number in the 1 to 3 watt area. Almost all projectors come with built-in speakers (with a few providing a jack for headphones).

Many of the units are completely portable and pack up to a carrying-case size with a built-in rear-projection screen for quick setup. Other feature variations include the capability to play the presentation continuously; controls to stop the film and sound and hold the frame for any length of time desired; and the ability to project standard 35mm slides.

BUILDING BLOCKS TO SOUND SYSTEMS

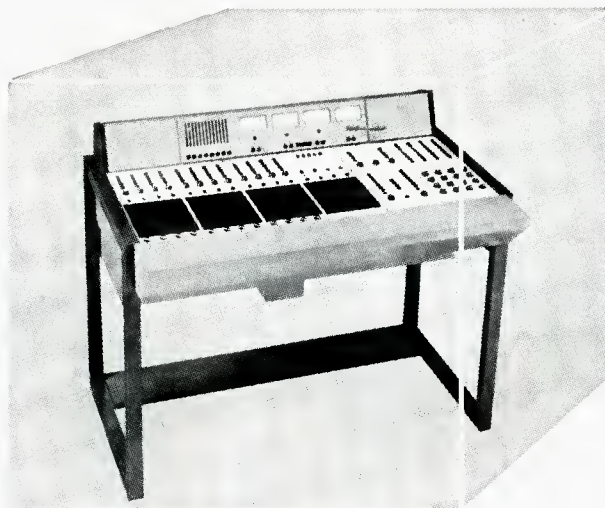

Third-Generation Mixing Desks... compact and flexible, realistic pricing.

Philips MD Series Mixing Desks are designed for recording, radio, TV, film and theatre use They have exceptional operational features with outstanding specifications and a price-to-performance ratio unmatched in the industry Solid state Flexible, easily-serviced design based on modular system Maximum of 24 inputs to 12 input channels Up to 4 independent output channels (for stereo and multi-

track recordings) Current-dependent mixing Monitoring and pre-listening provided Optional equalizer module, with 4 equalizers, switchable to 8 input channels **For full data, contact the innovators.**

Norelco® PHILIPS BROADCAST
EQUIPMENT CORP.
One Philips Parkway, Montvale, N.J. 07645 • 201/391-1000
A NORTH AMERICAN PHILIPS COMPANY

Circle 33 on Reader Service Card



“Thanks to the Dolby System our new recordings of The Vaughan Williams symphonies are free of tape noise,”

says Roger Hall, Manager, Red Seal Artists and Repertoire RCA Records.

“The Vaughan Williams symphonies have great dynamic range and many pianissimo sections,” says Mr. Hall, “Thus when we assigned Andre Previn and the London Symphony Orchestra to record all nine of these symphonies, we used the Dolby System to preserve this dynamic range and to ensure that the quiet sections of the works would be free of the degradation and distraction of tape hiss, print-through and cross-talk.”

Music lovers everywhere appreciate the new realism of noise-free Dolby recordings. Over 100 companies in 19 countries are recording with the dependable Dolby System. On your next recording session why don't you use the Dolby System? Call or write . . .

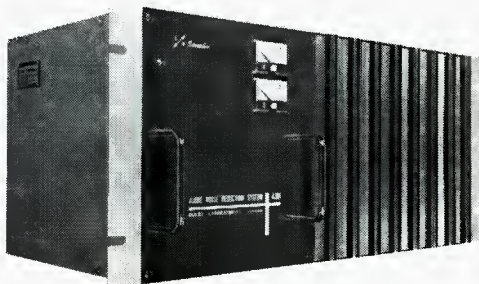

The Dolby A301

DOLBY LABORATORIES INC.

333 Avenue of the Americas, New York, N.Y. 10014 □ Telephone (212) 243-2525 □ Cable: Dolbylabs New York

So. CALIF.

Audio Industries Corp.
1419 N. LaBrea Ave.
Hollywood, Calif. 90028
Tel: 213-HO 5-4111

No. CALIF.

Audio-Video Systems Engineering
1525 Tennessee Street
San Francisco, Calif. 94107
Tel: 415-647-2420

MIDWEST

Expert Electronics Inc.
7201 S. Western Avenue
Chicago, Illinois 60636
Tel: 312-HE 6-2700

CANADA

J-Mar Electronics, Ltd.
6 Banigan Drive
Toronto 17, Ontario, Canada
Tel: 416-421-9080

Circle 32 on Reader Service Card

As can be imagined, the unit will function well most of the time, but there will be times when synchronization will be lost and the film will either not be triggered when it should or it will jump two frames. A new Soundstrip system has been developed recently which maintains continuous sync through a unique method. By alternating picture frames with optical sound frames, the film can not go out of sync. Thus, a unit is now made which reads the audio three frames ahead of the picture being shown at the rate of one line in 1/5 of a second or 18 seconds per 76 line frame. At the end of the frame a signal changes frames (in 1/25th of a second) and the next frame is shown. (Soundstrip System is a registered trademark.)

An extension of the type of projector which provides an image on the screen by shining light through a transparency (film or slide) is the overhead projector. This type is usually located near the lecturer, has a light source in a housing beneath a frosted glass and a small mirror and lens a short distance above the frosted glass surface. By placing a transparency on the glass surface, the image is projected to the mirror, through the lens and onto the screen located behind the lecturer.

Usually, the unit is located on a small table which raises the projector surface to a convenient height for the speaker to write on the transparency or to point

to any desired spot while talking. The finger or writing will show up on the screen, in this way; providing the lecturer with a means of making notes, drawing, or just indicating something to a large audience with a clear and bright image under normal room lighting. The speaker thus does not lose contact with the audience and is able to have the desired transparencies made quickly and easily.

The aperture opening (the size of the projection opening) is usually 10 x 10 inches although some models have other sizes. With a standard 14-inch lens (on most models) an image 8-feet wide is available from approximately 11 feet from the front of the screen. Focal lengths of lenses range from about 6 to 40 inches with apertures possible from 5 to 10 inches.

Among the variations in projectors available is a model which is small enough to carry in an attache case with the light source in the lens housing. This unit has only a flat, thin base, but with the light coming from above, a very highly reflective, diffracting material is used as the surface on which the transparency is placed. Thus, the light shines through the transparency twice, once down and once up, in getting the image to the mirror/lens housing and then to the screen. As the transparency is thin and smooth, and the reflective surface specially made, there is no dis-

tortion in the image being projected. It is interesting to note that the surface is a removable one and comes in a thin, but firm, mounting. A person not familiar with the unit will not realize that there is only one way that the reflective surface can be placed for the projector to operate properly. Although the plate will fit anyway it is placed (since the surface is square) the projection will not show up on the screen until the plate is properly oriented.

Then, there are console models capable of projecting slides, film, filmstrip, and overhead projection—all with a built-in rear-projection screen, remote controls and opaque projection and superimposing available; projectors to display (on rear-projection screens built onto the unit) microfilm, microfiche or aperture cards; projectors with speed controls from five to twenty-four frames with stop motion; projectors with speed ranges from 800 to 1500 frames per minute with manual single-frame operation; projectors mounted in lecturn units with built-in rear screen, remote controls, sound system, and missing only the lecturer/operator to speak and manipulate.

Other projectors available include models which run two reels simultaneously (interlocked) to synchronize separate visual and aural films to permit single-frame adjustment of synchronization in either direction; micro-projectors which project microscope slides or live material with a variety of polarizers, lenses, filters, etc.; techistoscopic and reading projectors which permit variable speeds from 1 second to 1/100th of a second for the slide or filmstrip image to appear on the screen; projectors with speeds from 30 to 2000 words per minute capability; and units which can project single lines or full pages with controlled speed-to-pace reading.

Still others come in stereo (yes, stereo) slide projection models, and, of course, there is the 16mm film projector which is specially modified with a different shutter and speed to synchronize with tv images to be used in tv projection or in a multiplexer operation.

Before leaving the variations of transparency projectors available, there is one more unique model which might be mentioned, as it is small enough to be used in presentations, shows, exhibits, and for eye-catching appeal—even though it uses 70mm film. The film is made up into twelve parallel tracks each one comprising a half-track of picture and a half-track of sound. The 300-foot cassette starts with track 1 and will continue automatically through to the end to show two hours of film on its built-in rear projection screen. The entire unit, weighing 38 lbs. and containing a 7-3 8 x 11 3/4-inch rear screen, allows for random selection of any track in either direction, with variable

BUILDING BLOCKS TO SOUND SYSTEMS



The PRO 12 Tape Recorder: industrial reliability, studio performance

The PRO 12 deserves your special consideration. It is the finest new portable professional tape recorder on the market Solid state Portable/Compact Twin-track mono; dual half track; stereo models Special version for four-track mono and stereo Semi-servo speed control Mixer/Preamp with three inputs for each channel Built-in facilities for mixing two inputs Test switch for lineup Multi-play and Sound on Sound recording Switchable monitoring of recording signal dur-

ing recording—Before and After tape Built-in monitor amplifier with loudspeaker Stereo headphone monitoring Cue and dubbing facilities Tape-lifters End-of-tape and tapebreak switch Pause button Remote control facilities For full data, contact the innovators.

Norelco® PHILIPS BROADCAST EQUIPMENT CORP.

One Philips Parkway, Montvale, N.J. 07645 • 201/391-1000
A NORTH AMERICAN PHILIPS COMPANY

Circle 31 on Reader Service Card

Recording: Agency Recording Studio, Chicago, Ill. • Audio Finishers, Chicago, Ill. • Brians Recording Studio, Tyler, Texas • Capitol Records, Hollywood, Calif. • CBS, Rio de Janeiro, Brazil • Century Recording Studios, New York, N. Y. • Cinema — Audio Inc., Manila, Philippines • Decca Records (4), Los Angeles, Calif. & New York, N. Y. • Devonshire Productions, Granada Hills, Calif. • Discos Fuentes, Medellin, Columbia • Eastman Kodak, Rochester, N. Y. • Eight Track Studios, Chicago, Ill. • Independent Recorders, Studio City, Calif. • Jones Sound, Houston, Texas • Joy Recording, Chicago, Ill. • Location Records, Burbank, Calif. • C. P. MacGregor Recording Studio, Hollywood, Calif. • Mirasound Studios (2), New York, N. Y. • Ochoa Recording Studios (2), San Juan, Puerto Rico • ORBI-VOX, Mexico City, Mexico • Pacific High Recording, San Francisco, Calif. • Palma Studios, Lima, Peru • PAMS, Dallas, Texas • Petrucci & Atwell, Boston, Mass. • Reeves, New York City • Reposo Studios, Rochester, N. Y. • Rex Recording, Portland, Oregon • Sears Recording Studio • Omaha, Nebr. • Sinatra, Frank, Jr., Los Angeles, Calif. • Soul Recording, Los Angeles, Calif. • Stereo Sonic Recording Studios, Chicago, Ill. • Stereo Sound Studios, Montreal, Canada • Sunwest Recording Studio, Hollywood, Calif. • Universal Recording Studios (2), Chicago, Ill. • Vox Soundlab Recording Studio (2), Van Nuys, Calif. • Whitney Recording Studios, Glendale, Calif. • Niles Christensen, Bangkok, Thailand. **Television and Radio:** Ambassador College, Pasadena, Calif. • Ampex Corporation, Redwood City, Calif. • Baptist Radio & Television Commission, Fort Worth, Texas • CBS (2), Studio City, Calif. • Hollywood Video Center (2), Hollywood, Calif. • King Broadcasting Corporation, Seattle, Washington • KTLA (Channel 5) Television, Hollywood, Calif. • KQED TV, San Francisco, Calif. • Lewron Productions (3), Hollywood, Calif. • Mormon Tabernacle (Church of LDS), Salt Lake City, Utah • NBC (2), Beautiful Downtown Burbank, Calif. • WSOC Radio & TV, Charlotte, N. C. **Motion Picture Recording:** Acme Film Lab, Hollywood, Calif. • Bill Stokes & Associates, Dallas, Texas • Columbia Pictures, Hollywood, Calif. • Crawley Films, Ottawa, Canada • Filmfair, North Hollywood, Calif. • Glen Glenn Sound, Hollywood, Calif. • Keitz & Herndon, Dallas, Texas • Metro Goldwyn Mayer, Los Angeles, Calif. • Paramount Pictures, Hollywood, Calif. • Technicolor, Hollywood, Calif. • UCLA (3), Los Angeles, Calif. • **Sound Reinforcement:** Bonanza Hotel Casino, Las Vegas, Nev. • First Nazarene Church, Pasadena, Calif. • Flamingo Hotel, Las Vegas, Nev. • International Hotel (3), Las Vegas, Nev. • Landmark Tower (2), Las Vegas, Nev. • Los Angeles County Art Museum, Los Angeles, Calif. • Sahara Hotel, Las Vegas, Nev. **Government Agencies:** Armed Forces Radio & Television Service (16), Hollywood, Calif. • United Nations, New York, N. Y. • USAF Band, Bolling Air Force Base Washington, D.C. • United States Information Agency, Washington, D.C.

Name-dropper

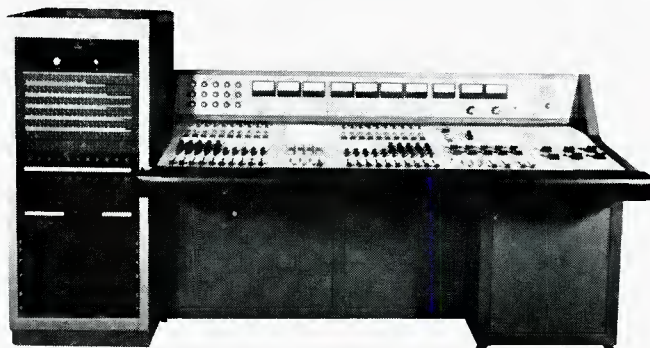

These industry leaders chose an Electrodyne Audio Control Console for high quality recording, broadcasting, sound reinforcement, or motion picture work. Electrodyne consoles come standard, built to your order, or we'll help you design your own. For information write Electrodyne Corporation, Dept. J-9, 7315 Greenbush, North Hollywood, California 91605, (213) 875-1900, Cable: "Electrodyne"

ELECTRODYNE

Come see all our new ideas at AES booths 76, 77, and 78
Circle 30 on Reader Service Card

speed or stop motion by remote control. Construction of the unit eliminates use of the pull-down claw common to all film projectors and uses a capstan drive. This provides for quieter operation. Also, the screen can be removed and the unit used for regular front-screen projection, or the unit can receive closed-circuit tv signals as it uses a system of prism optics without the standard shutter.

One other type of projector in common use is the opaque projector which departs from the transparency-type and shows images of the printed page, solid objects, or almost any opaque object. The light source is above the object and the light reflected from the item is projected onto the screen through a mirror-lens combination.

This type of projector is the least efficient and requires a fairly darkened room if the object is dark or the image is to be large. Aperture width for this unit is 10 inches. A 22-inch lens will show an image 8-feet wide at about 17½ feet from the front of the screen, while the standard 18-inch lens will project a similar picture from about 14½ feet.

Among some of the accessories available for some of the previously mentioned projectors are devices to put signals on the second track of the tape to be used in sync with a slide show, or to produce the effect of motion from a

slide specially prepared to be projected by this adapter, or to adapt slide projectors for filmstrip operation.

As for lenses, there are specially designed units to be used with standard projectors to cut down the projection distance for the same size of image, to provide the same size as desired from a greater projection distance as in a theater or auditorium, and to allow a short projection throw in rear-screen operation where the depth of the rear projection room is limited. In this latter unit the mirror is built into the lens attachment eliminating the need for the normal rear-projection mirror which must be used when 16mm film is shown by this method of projection.

Many remote-control devices are available. One of them, to indicate the operation available, consists of an eight-channel punched tape. The punched holes set up the primary relays which will be energized when an incoming pulse arrives. The relays will remain activated only for the length of the pulse and will start any device connected to its channel. At the same time, the primary relay will energize a secondary relay to supply a.c. to any device connected to it. The tape moves to the next row of holes and awaits another pulse. Thus, each of the eight tracks has a primary and secondary circuit and the front operating panel has indicating lights for each channel with defeat

switches to permit manual control of any channel.

Although we have not covered digital readout or large-screen tv projectors, we hope the audio/visual contractor now has a better idea of the extent of the field and will be better able to satisfy his clients.

BACK ISSUES AVAILABLE

A limited number of back issues of **db** are available to interested readers who may have missed or misplaced earlier issues. When ordering please indicate date of issue desired and enclose 75¢ for each copy.

CIRCULATION DEPT.
db — The Sound Engineering Magazine
980 Old Country Rd.
Plainview, N. Y. 11803

NOW THERE'S A CASSETTE TAPE WITH MUSCLES.

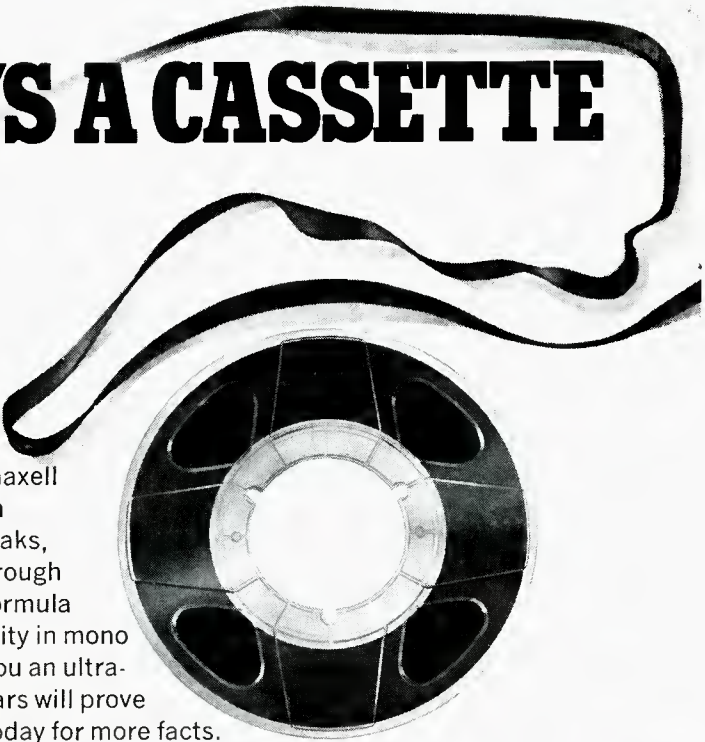

New Maxell F-20 Magnetic Tape helps you make better cassette recordings—with fewer problems. Reason? Real muscle. Maxell F-20 has 10% greater tensile strength than conventional recording tape. Prevents tape breaks, headaches, lost studio time. Lower print-through level, too. And our secret Hush-Hush Tape Formula virtually wipes out hiss, delivers pure fidelity in mono or stereo. It's specially developed to give you an ultra-precise recording of fine music. Your ears will prove it—and your budget will like it. Write us today for more facts.

HITACHI MAXELL, LTD.
501 Fifth Avenue, New York, N.Y. 10017

The Limiter/Compressor that thinks for itself! CA-700 and CA-702

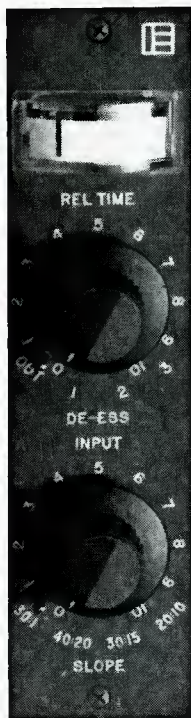

These Electrodyne Limiter/Compressors perform the combination of functions most needed in recording and broadcasting. 30 db limiting is provided for limiting only. The compression ratios are 40:20, 30:15, and 20:10, each with 10 db of limiting if desired. Three positions of de-essing permit equalizing for presence ahead of the Limiter/Compressor while eliminating sibilants with this unique circuit. The attack time is less than 20 microseconds for virtually unnoticeable operation. The release time is continuously variable with its own control from 30 milliseconds to 4 seconds. The CA-700 and CA-702 each incorporate an automatic low frequency time constant gate which reduces distortion to less than 1% at 50 Hz even when set on short release time.

TWO MODELS: CA-700 is a 3½" x 19" rack mount limiter/compressor with a compression and level meter. This self-contained unit is complete with its own power supply and has an output capability of +30 dbm. CA-702 is a 1½" x 6" modular version of the CA-700 and is designed for console or system use where 24 VDC is available.

If you want the Limiter/Compressor you can't hear —
The CA-700 or CA-702 is for you!

ELECTRODYNE

7315 Greenbush Avenue ■ North Hollywood ■ Calif. 91605 Phone: (213) 875-1900 ■ Cable Address: "ELECTRODYNE"

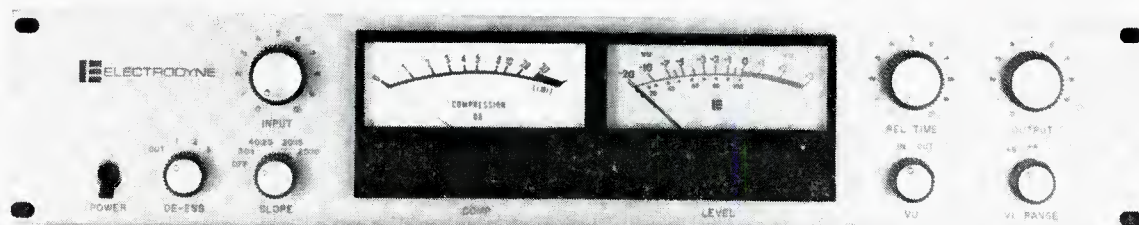

Come see all our new ideas at AES booths 76, 77, and 78
Circle 29 on Reader Service Card

The Sound Of Koss Surpasses Every Traditional Stereo Listening System!

**MODEL ESP-9
ELECTROSTATIC STEREPHONES
GIVE YOU ALL 10 OCTAVES**

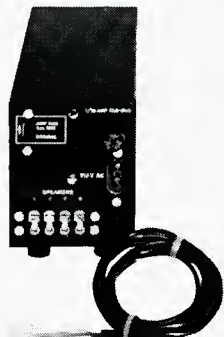

Rear view of the E-9 Energizer.



Functional Block Schematic showing switching functions and hook-up of the ESP-9.

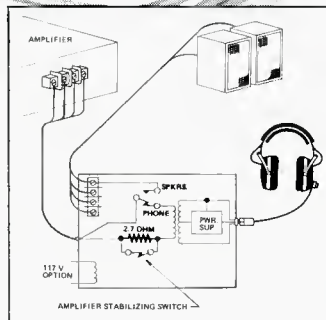

NEW!

SUPER, WIDE-RANGE RESPONSE for critical, controlled monitoring of finest recording sources. Delivers all 10 audible octaves, 15-15,000 Hz \pm 2 db, 4 octaves beyond ordinary headphones.

VIRTUALLY DISTORTION-FREE PERFORMANCE through precision electrical balancing of push-pull acoustical circuitry to give fatigue-free listening through long, intense recording sessions. Elements cancel all 2nd harmonic distortion, unlike conventional units.

LIGHTWEIGHT—HUMAN ENGINEERED FOR COMFORT— Uses fluid-filled cushions for distributed gentle pressure with good seal; coupling transformers and circuitry located in external housing; extendable stainless steel headband with wide cushion for perfect fit and restful listening.

CALIBRATED, PRECISELY CONTROLLED OUTPUT—IDEAL FOR AUDIOMETRIC USES— Switch on front panel of energizer selects ac operation for precision measurements of output; in self-energized switch position no connection to ac lines is required; this gives maximum convenience.

HIGH-POWER CAPABILITY IN VERY LOW BASS RANGE—Large, oversize coupling transformers mounted in E-9 energizer unit give good wave form at 30 Hz with up to 10 volts input.

NO SPECIAL AMPLIFIERS REQUIRED—CONNECTS TO LOW-IMPEDANCE SPEAKER TERMINALS—Easy, quick hook-up to any good amplifier delivers performance to specification.

The ESP-9 is a refinement of the famous ESP 6 Electrostatic Stereophones. The most important new feature is a response range of 10 octaves, **the widest ever attained in a headset**. A new cup design promotes virtually linear response to below 20 Hz.

The ESP-9 has a signal handling capacity of 10 volts at 30 Hz with good wave form versus 6 volts for the ESP-6. This is made possible by increasing the size of the coupling transformers by a factor of 4, and mounting them externally to the cup in the E-9 Energizer.

The E-9 Energizer offers the option of self-energizing for the bias supply, or energizing through the ac line; choice is made with a selector switch on the front panel. When energized through the ac line, very precise level measurements can be made. Thus the unit is ideal for audiometry, and for evaluating the spectral character of very low level noise in equipment like tape mastering machines and recording consoles. In contrast to the ESP-6 and ESP-7, both cups are independently energized; a left cup signal is not required to supply bias to the right cup.

TYPICAL SQUARE WAVE RESPONSE AT 400 Hz.

Trace at top is input, lower trace is ESP-9; note unusually close resemblance.

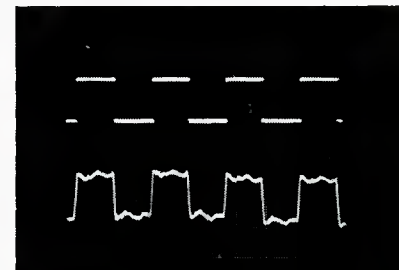

ELECTRICAL SPECIFICATIONS

Frequency Response Range, Typical: 15-15,000 Hz \pm 2 db (10 octaves) 10-19,000 Hz \pm 5 db. An individual, machine-run calibration curve accompanies each headset. This curve uses standard 3-1/2 log-cycle chart paper, and reads from 20 to 20,000 Hz only.

Sensitivity: 90 db SPL at 1kHz \pm 1 db referred to 0.0002 dynes/cm² with 1 volt at the input. Variations from calibration furnished are less than 1/2 db at 25°C.

Total Harmonic Distortion: Less than 1/5 of 1% at 110 db SPL.

Isolation From External Noise: 40 db average through fluid-filled cushions provided as an integral part of the headset.

Power Handling Capability: Maximum continuous program material should not exceed 10 volts (12 watts) as read by an ac VTVM (Ballantine meter 310B or equal) with average indicating circuitry and rms calibrated scale; provides for transient peaks 14 db beyond the continuous level of 10 volts.

Source Impedance: Designed to work from 4-16 ohm amplifier outputs. At higher impedances response at the extremes of the frequency range will progressively reduce; e.g., 50 ohms causes a loss of 5 db at 30 and 10,000 Hz.

External Power Requirements: None, except when used for precise low level signal measurement, when external ac line can be selected by a front panel switch on the E-9 Energizer (1/16 amp, 117 VAC, 50-60 Hz normally; 234 VAC with internal strap for foreign use).

PHYSICAL SPECIFICATIONS

Size of Cup: 4-1/4" h x 3-3/4" w x 1-1/4" d.

Cushions: Fluid filled for high ambient noise isolation.

Headband: Extendable, stainless steel bands with self-adjusting pivoting yokes; conforms to any head size.

Headband Cover: Formed of wide, soft molded-rubber with 1/2" polyethylene sponge cushion on underside.

Boom Mount for Microphone: Knurled, anodized, aluminum knob on left cup with threaded shaft and 2 compressible rubber washers; accepts all standard booms.

Headset Cable: Flexible, polyvinyl, 5 conductor, shielded, 6' long, black, with 5 prong plug keyed to E-9 Energizer receptacle.

Weight of Headset Only: 19 ounces

E-9 Energizer: Contains 2 coupling transformers, self-energizing circuitry, speaker/headphone transfer key-switch and ac pilot light on black anodized front panel. Also contains ac power transformer, ac on-off switch, ac line fuse, and speaker terminals. Size is 4-1/2" h x 3-3/4" w x 6-1/4" d; weight 3 pounds. Has 6' 4 conductor input cable terminated with 4 spade lugs to connect to amplifier output terminals.

Accessory Provided: 6' ac line-cord P/N 41-0235 for optional use, with plug on one end and plug-receptacle on the other.

Model ESP-9 Studio Monitor: Electrostatic Stereophones, complete with E-9 Energizer, ac line-cord, machine-run calibrated response curve and instructions; Shipping weight 6 pounds; Price

\$150.00

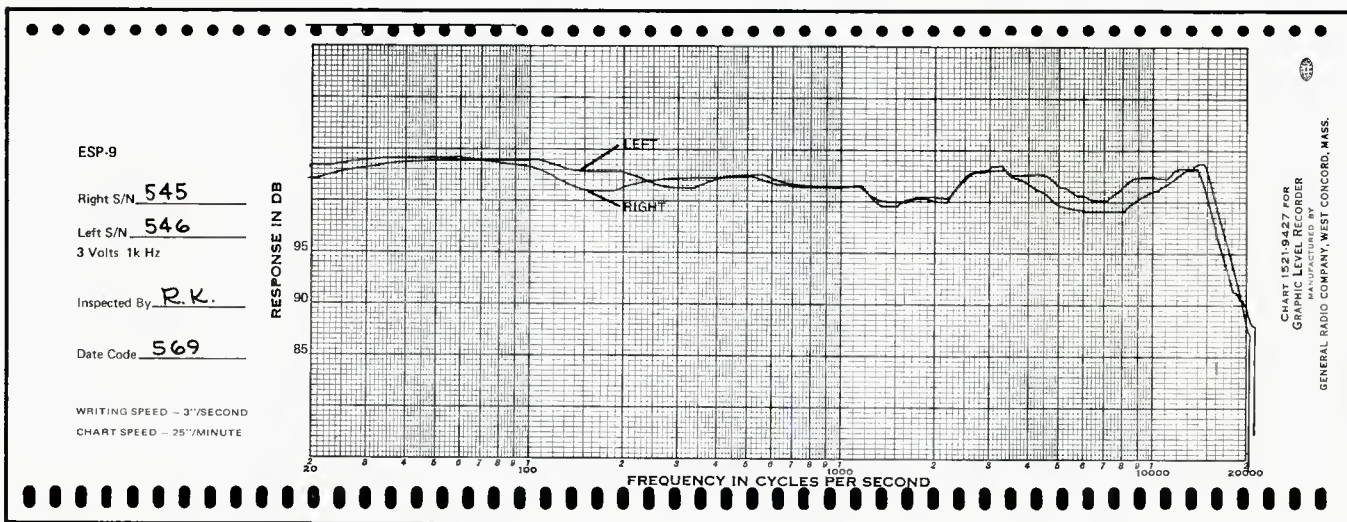

MACHINE RUN RESPONSE CURVE OF THE MODEL ESP-9



KOSS KOSS ELECTRONICS INC / MILWAUKEE, WISCONSIN
2227 NORTH THIRTY FIRST STREET / ZIP 53208

Replacing A Broadcast Console

LES BROWN

Sooner or later, any broadcasting station that has been in business for a while is faced with the growing obsolescence of their console. This is what one station did about it

RADIO STATION HAVE A WAY of outgrowing audio consoles that is not unlike a young child with shoes; they hardly begin to show wear when they're too small. WXTR, Providence-Pawtucket, Rhode Island, proved the statement to perfection within five years after installing an 8-mixer RCA consolette. Station personnel added a variety of switches and combined inputs with matching networks to cope with the situation for an additional four years but with less than desirable results. It was all too easy to have two

At the time of writing this article, the author was employed at WXTR an AM-only station located in Cumberland, Rhode Island. He has since moved to a new engineering position with WTEV-TV in New Bedford, Mass.

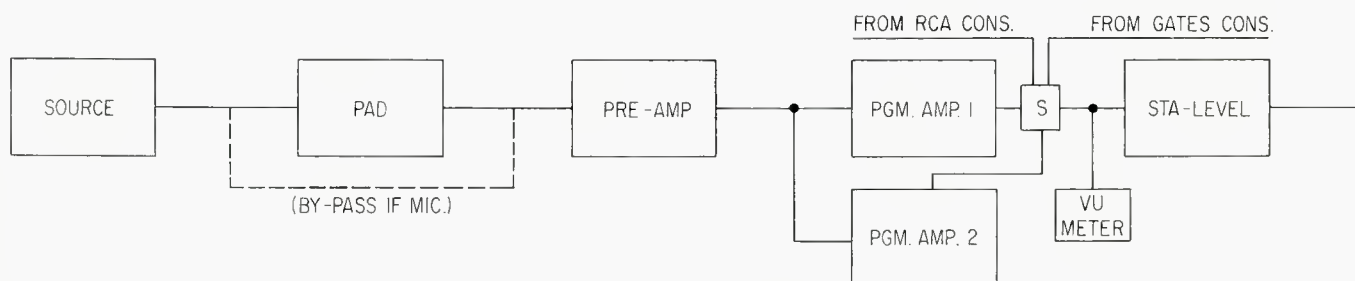

Figure 1. A block diagram of the Langevin console. The VU meter bridges (through a Langevin bridging card) the program line after the output selector switch (s) thereby tracking any source feeding the transmitter.

sources run on the air at the same time; it was all too difficult to audition a source when the mixing channel it shared was in use.

The end finally came when Station Manager Don Hysko decided to go ahead with plans to install a pair of Scully tape decks and turn to pre-taped music (IGM'S *Music Theater*). There just wasn't room for two more inputs. Further, the RCA console was coming a little too close to proof-of-performance limits for comfort.

The search for a suitable replacement for the RCA was launched with enthusiasm, engineers shopping for a new console have been aptly compared to children in a toy shop. The joy wasn't long lived; most off-the-shelf consoles available proved to be too small in input capability or too large in physical size. We wanted a console, not a panel suitable for launching lunar probes, yet we wanted at least twenty inputs and ten mixers, monophonic. We had no idea monophonic had become such a dirty word! Any number of manufacturers had positive jewels in stereo consoles. But mono in 1968? We had seen advertising in *db* for consoles by Langevin but gave them no serious thought since they incorporated a number of equalization features, reverb send and return functions and an assortment of blinking lights that seemed quite nice for pinball machines but impractical for a radio station. Our friendly neighborhood Langevin dealer, Warren Hartwell (WRH Productions of Cumberland, R.I.) came to call and convinced us that all the gadgetry was not nailed on. Still not converted we looked over a somewhat larger console than we had in mind at Concert Recordings' studio in Cranston, R.I.

The workmanship seemed quite good and we were impressed by the modular concept allowing individual mixing channels to be removed from the front of the console and interchanged if necessary in event of failure.

Before placing our order we wrote a simple but exact set of specifications:

10-mixing channels with 4-inputs pre-selectable each.
2-identical program amplifiers.

1-control module with output selection (Program Amp. 1 and 2, newsroom console, or production room console) for transmitter feed; monitor input selection and gain control; earphone output select and gain with phone jack front-mounted. vu meter to track program line so no matter which amplifier or console is feeding the transmitter it may be monitored directly in the master control room. 600-ohm, +4 dB output (no more output level was required in our particular situation because of compression amplifiers, etc. between console and transmitter).

All inputs (individual inputs, not channels) to be switchable for 150-ohm, 250-ohm, or 600-ohm input. Frequency response ± 1 dB, 30-20 kHz.

Distortion less than 2%, 30-20 kHz.

Noise at least -122 dB (72 dB down from a -50 dB input).

The price quoted was quite reasonable in view of the prices asked for "off-the-shelf" units that overshot our goal with stereo amplifiers throughout. The construction time was a bit more than we really wanted; 90-days. We did manage to

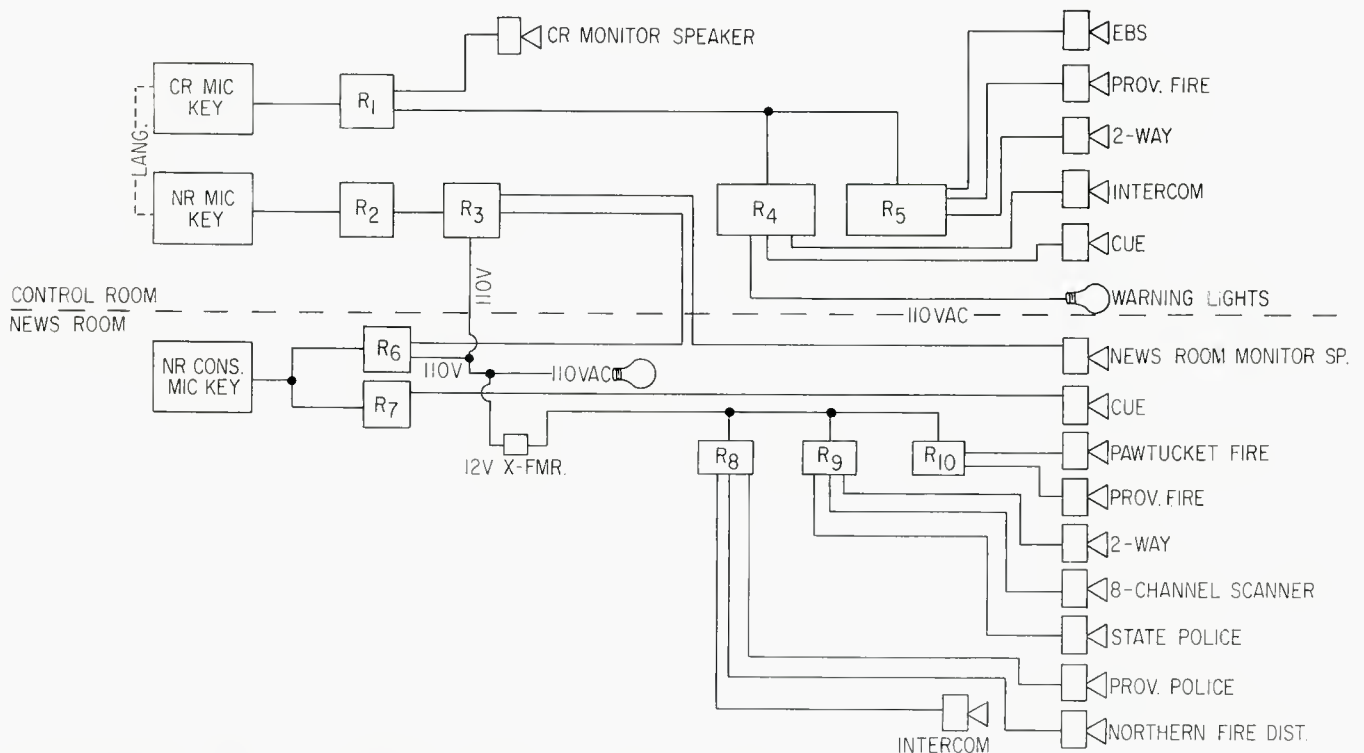

Figure 2. The relay operation block diagram of the console. R1 and R2 are 45V d.c. dpdt; R3, R4, R5 are 12V a.c. 3pdt; R6 and R7 are 24V d.c. supplied with the RCA console, R8, R9, R10 are 12V a.c. 3pdt. Load resistors are substituted for all speakers when microphone keys are opened. R1 and R2 are used to switch 12V a.c. located physically outside the console. Note that the CR and NR mic keys are ganged on the Langevin console.



Figure 3. The Scully 270 (top) and 280 units used for the music format.



Figure 4. An over-all view of the finished control room. Turntables are installed for the convenience of handling Sunday morning religious programs and specialty items, not normally for music.

turn this to advantage. Our tape decks arrived within 30-days and we started our installation with the decks placed in a vertical rack in the newsroom they were accompanied by a smaller rack housing sensing amplifiers for the 25 Hz "stop" tone on the music tapes, and a patch panel which allows the decks to be used not only in conjunction with the master console but also as independent units or through the consoles in the news and production rooms if necessary. We measured, marked, cut, and cabled the lines to link the decks to the three consoles and inter-connect the three on the control module of the new master-board. The station has a 4-inch thick poured concrete floor which drills slowly but nicely so within a few days it was possible to snake the cables through the floor and along I-beams in the basement to their proper destinations. Having this wiring in place ahead of time allowed much quicker final installation when the console arrived.

The console finally did arrive just two weeks before the scheduled air-date of our updated *Music Theater* format. We had drawn a one-week time table and used every bit of it! For the duration of the installation period we moved our announcing staff into our production room which compares quite favorably with the master-control room at most regional stations. The only thing lacking was air-conditioning and it proved that grown men still know how to cry. There is nothing more miserable than an over-heated announcer.

Initial plans called for careful removal and labeling of wiring to the old console. It was a beautiful thought but quite impossible. The RCA board must have been installed and the walls built around it! There being no midgets on the staff to manipulate wires in tight places, we soon settled on a 36-inch pair of bolt cutters as most practical. This, of course, left a bundle of 100-pairs to be sorted and marked; so went one working day with a signal generator and 'phones.

Since we planned to install the new console facing into the newsroom rather than into the lobby it was necessary to get those cables some 10-feet around a corner and along the wall. Needless to say we had only 18 inches to work with. Rather than resort to a messy bundle of splices we attached a series of barrier-type terminal strips to the wall just above floor level and used these as a "jumping off" place. Since we were working within a dozen feet of a one-kilowatt transmitter we had our anxious moments about RF pickup. There are a number of theories on grounding. . . I subscribe almost religiously to the brute-force method. If it can be grounded, ground it! And we did, with our ears cocked for pickup from ground-loops—but there was none.

I might add at this point that "we" indicates Warren Hartwell who wanted to be sure the console he had sold us was getting a good home and me. It is also interesting to note that these preliminaries were done to the accompaniment of hammers and saws as a cabinet-maker built the new studio furniture in place.

With all the audio wiring in place we decided to stop before wiring in the switching for a battery of relays concerned with silencing the 8-odd police and fire monitor speakers our news-director wanted in his on-the-air newsroom, as well as an additional four miscellaneous speakers in the control room.

It seemed we'd have less trouble tracing audio problems (if there were any) before the additional bits and pieces were in place. We were so right.

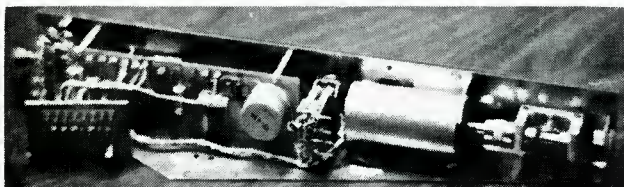

Figure 5. One of the input modules of the Langevin console installed at WXTR. Note the gear drive (at the right) to the attenuator.

For testing, we used a Barker and Williamson audio signal generator, a Gates Gain Set, a B & W distortion analyzer and an RCA High-Sensitivity a.c. VTVM. The signal generator was connected through the gain set (-50 dB) to a microphone input with the console output terminated in a 600-ohm resistor across the input to the distortion analyzer or VTVM depending on the test in progress. Our initial run showed a noise level of -35 dB, distortion of some eight per cent, and lovely audio response from 30 to 12 kHz. Not very encouraging. The output from the distortion analyzer seemed broad-spectrum. Not RF, not leakage from one channel to another—just plain noise. A quick run through all the connections leading to and from the test-gear quickly eliminated the excessive noise. We found it necessary to solder where possible and tighten binding post connections with a pair of lock-jaw pliers. We suspected the poor response and distortion were related but were pleased to note the distortion dropped off somewhat with the elimination of the noise problem. This still left us with a bad drop in response above 12-kHz. After two full days of substituting entire modules, individual capacitors and transistors we still had the problem. At this point we began to have serious questions about the test gear and tried eliminating the console from the circuit entirely. . . in effect measuring the frequency response of the gain set. We plotted almost exactly the same curve as we had through the console, complete with cut-off at 12 kHz. Working up our own 50-dB pad we plotted a new curve (through the pad only) then reconnected the console and plotted again. The curves matched within one half of one dB! And this from 30 to 24 kHz! As a bonus our distortion problem was gone.

The delays took us a half-day beyond our original target but the result was a control room that could be mastered by a new operator in under an hour. In fact, our news director had only a day to become used to the new set-up before anchoring our coverage of the 1968 national/state election and was able to do so from the new control room without a flaw. This, of course, credits him as well as the equipment.

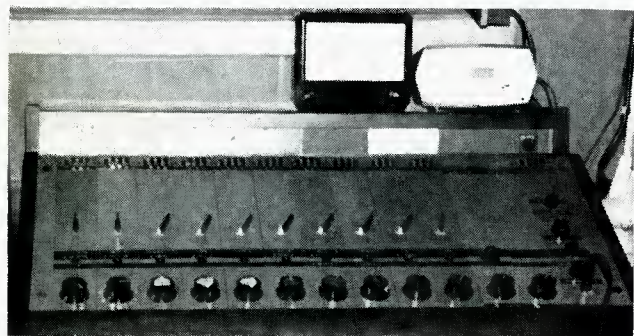

Figure 6. The Langevin console from the operator's seat.

The good Mr. Hartwell and the Langevin engineering staff took a novel approach to our input specifications; each mixer module has four pre-select buttons interlocked to prevent more than one input airing at any one time. It is possible to defeat this interlock by pressing two buttons simultaneously and we have made use of this feature on several occasions. Rather than attempt impedance switching on the pre-selects, they incorporated a solid-state preamplifier into each mixer module, equipping each with a Beyer input transformer which they assured us would in effect bridge any impedance from 50- to 100-thousand ohms with minimal adverse result. Whether the people at Beyer were aware of this use for their transformer I don't know, but they should be and might advertise it for this purpose. It performs admirably (nominal input 24K).

Various levels are reduced to the required -50 dB with pads of the proper input impedance. A series of measurements showed no serious effect on response or distortion when varying input impedances were employed. In this connection I would call your attention to Stephen Temmer's article *EUROPEAN EQUIPMENT AND U.S. AUDIO* in *db*, November 1968. There are many interesting parallels.

I know there are any number of hard-nosed engineers who will disagree with this principle, and in response I extend to them an invitation to come and see it at work. This design has given us 40 available inputs, any of which may be used for microphones, yet we are not limited in what we can use. At the moment we are using only 20 inputs and figure we have at least 20-years of growth potential.

The modular concept enables substitution of any module for any other in the event of failure (we have had none in six months of 20-hour a day operation) and the use of two program amplifiers allows us to change an output select setting and work from the left (audition) side of the key on each module should our regular program amplifier fail.

The only vulnerable element is the power supply; the Langevin unit supplied provides 45 V d.c. at 3-amps maximum but the console requires only 1-amp so we expect no trouble. Were we designing today I would write in a second power supply, switchable from the front panel but since that is impractical at this point I plan to build a somewhat less elaborate auxiliary supply and keep it handy for substitution should it ever be required. The normal power supply is a plug-in unit allowing quick replacement by even a semi-skilled operator. Our console uses specially-built 10-K step-type potentiometers (yes, that is the correct description) for gain control. We have had to clean them more frequently than I really like so I might be tempted at some time to convert one or more to the new composition-type pots which manufacturers are claiming to be exceptionally reliable. That's the only genuine problem we have encountered; a much better record than we had any right to expect.

Based on the ease of operation and ease of working modules I would recommend that any station in need of a console give careful attention to modular designs offered by several manufacturers. The smaller operator might well take a good look; it is often possible to buy just the modules you need and place them in a larger-than-necessary frame. . . adding more input modules when required. The cost should be in line with smaller stock consoles and provides a much more sensible means of expansion than junking an otherwise good console.

Further Implications of the Low-Noise Background

EDWARD TATNALL CANBY

The author presents some thought-provoking concepts regarding the vastly superior signal-to-noise ratios now being achieved on modern commercial recordings. It is also valuable for the recording engineer to refresh himself with this perceptive view of some aspects of his product by an experienced listener

WITHIN THE FIRST SEGMENT of this discussion, published in the June issue, I outlined three postwar phases of emphasis in consumer audio—not to point them out to engineers who them-

Edward Tatnall Canby is well known as a professional musician, music critic, and writer on both musical and audio subjects.

selves have participated, but rather to bring some recent known history into perspective. The third of these phases, in which we now still find ourselves, is that intense preoccupation with noise reduction, throughout audio, which began (more or less) with the first low noise tapes and came into prominence (roughly speaking) with Dolby. Neither Dolby nor improved tape constitutes the whole story—a widespread phase of audio thinking like this one involves many different aspects of a general problem, many developments; some are basic, some, like the Dolby, are in the nature of highly sophisticated aids; crutches if you will. In practice, both approaches are bound to prove valid and work together towards common goals.

Reduction of noise, to be sure, often means merely the achieving of a sort of noise *status quo*. That is no *increase* in the noise background as other audio parameters are sharpened up, for an improvement and/or economy in the signal transmission. The cassette, for example: how can we manage merely to match noise standards in the cassette that are currently acceptable in other audio areas? Problem enough, with narrow, thin tape, narrow, close-together tracks, and slow speeds—all combined in the cassette configuration.

I am here mainly concerned with one special and subjective aspect of lowered noise in the consumer area, that near-total disappearance of background sound which, at last, is actually beginning to be “heard” in some of the current mass product. I am not at this point speaking of the technique itself, but of the impact of that technique on the audio message.

I must say once more that, as I see it, the audio message is very much the engineer’s concern, if indirectly. Not the wave shape but the effect of the wave. To toss in another analogy, I suggest that the audio transmission must accommodate audio messages as highways are designed to accommodate autos. No highway engineer can design a thruway without reference to the vehicles that will use it—to their numbers and varying densities (volume level and dynamic range) and above all, the characteristics of the machines and the habits of their human drivers. Highways put down without that sort of understanding are, as we know, death traps. Fortunately, nobody is going to die from miscalculated audio design, though some of us may be deafened. But the principle does hold. We cannot take full advantage of a basic range of improvement such as lowered background noise until we know its effect on the sense of the audio signal.

Only a relatively few audio transmissions now actually reach the public with that marvelous extreme of non-noise in which the tiny vestigial residues are our main concern—and the engineer’s despair. But the impact of these few discs and tapes, and a great many more that show lesser but significant noise improvement, is already surprisingly great, as I suggested in June, pointing to a listening revolution of important proportions in the making. Considering the long attenuation of the commercializing process, from original master tapes to the home listener’s ear, the results are no less than astonishing and it would be a grave mistake to underestimate this new commercial product in the light of even higher standards for virgin-pure professional tales.

We must, even so, eliminate a good many areas from consideration. Broadcast audio, as of now, is one. The impact of total noise reduction, for instance, is not vitality important in

TV audio. Reception of AM is hardly yet residual in respect to the noise background, even on a static-free day. Stereo FM, our fanciest audio broadcast, has to an extent degraded with its own built-in noise that ideal FM transmission which reproduces the signal as nearly exact replica, without significant additions of noise or other distortions. Even the most perfect mono FM reception is likely to be treated to some degree of compression, thereby eliminating one of the major impact factors that follow from the systematic exploiting of the low-noise potential.

As for audio in automobiles, restaurants, banks, boats and supermarkets, their noise content is of less importance to us. It is mostly drowned in the macroscopic noise environment, not to mention the inattention of the listener.

WHAT IS LEFT?

Principally, we are dealing with recordings of music as played in the home from disc or tape. Not all discs. Decidedly not all tapes (and not cartridges or cassettes!). But some discs and some tapes. There are enough of these, already, to provoke these thoughts on the future of audio in the (relative) peace and quiet of the home.

I do not mean (I must say hastily) that all these eliminated transmissions, from FM broadcast to the supermarket, are doing less than their potential allows. Not at all. They represent that present state, not of the audio art but of the audio practicality, and their impact on life in general is impressive. No regrets are here expressed! In fact, I must digress to point out again that state-of-the-art improvements in noise, down in those residual levels, often pose more problems than they solve, as every working engineer has found to his disgust. Near-silence merely stimulates our exasperatingly sensitive ears into noticing those last tiny disturbances that otherwise would be ignored. Short of the ideal of absolutely *total* background silence, the proper remedy for residual noise is clear enough: like those synthetic vitamins that we put back into food after we have removed the natural product, we should put back into all audio a suitably controlled complement of smooth, even white noise, neatly burying the residuals! A most unpleasant idea, though, from the viewpoint of any conscientious engineer. Got to do better than *that*.

What about the still-small, but influential group of new recordings that does in fact embody the real low-noise resultant minus additives? My personal reaction to them is very strong—I think they are terrific.

These few outstanding recordings, heralds of more to come, are not only state-of-the-art in terms of the chain of consumer production but would seem to have been deliberately designed to take maximum *musical* advantage of the new techniques. They are of an astonishing impact, if not always in the plus sense. There are many others of lesser virtue which nevertheless are remarked upon by large numbers of listeners right now, for both pleasure and pain—not to mention the usual confusion. The listener hears a lot more than merely. Low noise, He hears, instead, the effects on his favorite music of techniques based on that silence—most notably, the increase in dynamic range that is so clearly a technical improvement, is not always the same in listening terms. Not yet, anyhow.

As most of us know to our sorrow, there is a tendency today to blame all sonic ills on that *bete noire*, stereo. Take the following excerpt from a recent letter to me. This lover of the



240 IPS + GAUSS
Quality makes the difference

Speed by itself is of little meaning unless you add the accuracy and quality found only in the Gauss Series 1200 Ultra High Speed Tape Duplication System. In the Series 1200, 240 IPS means multiplied production with fewer machines to maintain and less space required. Focused Gap® Recording with 10 MHz bias, and the unique tape drive system, which includes such innovations as the closed loop dual capstan drive, and constant tension servo-controlled reeling motors, makes 32 to 1 ratio copies as faithful as those produced at a ratio of 1 to 1 under studio precision. Tape duplication is virtually automated through use of the revolutionary Model 1260 Horizontal Endless Tape Loop Bin, eliminating master rewind. Straight-forward design and plug-in modular construction makes a versatile system capable of expansion or rapid conversion to another format. The Gauss 1200 system produces the finest possible quality tapes in the least amount of time.



gauss electrophysics

1649-53 12th street santa monica, california 90404 u.s.a.
® telephone: 213/451-9876 cable: gauss santa monica

a division of mca technology inc., an mca inc. company
PRINTED IN U.S.A.

What happens, then, when the listener comes on one of our gorgeous new ultra-silent records with the new dynamics, down into the faint areas that once were mud? The experience can be unnerving.

First, you find that no matter where you set your volume control you miscalculate, grievously, unbelievably. Everything goes wrong—is something the matter with the playback equipment? (That was my first incredulous thought.) The music may begin much too faintly; you turn it up ‘way beyond your normal setting, wondering about preamp failure, until a blast of sound almost knocks you off your feet. Or, the music begins loud, and you set a normal level, only to find moment later that the sound is slipping away to nothing, like the fade when an old-fashioned tube with an intermittent filament opened up. The very pride and joy of our advanced recording professionals, this effect is a most unsettling (and unmusical) experience for the lover of music, at least as of right now. It is so—*strange*. Incidentally, it lets in again all those little old devils, the extraneous noises including the refrigerator; but that is not the real impact, which is the destruction of familiar and long-satisfactory listening habits, evolved out of past recordings by the hundreds and thousands.

Here enters that curious factor I mentioned in June, our unconscious dependence on surface noise (even the residual noise on the average lp) as a guide to our level setting. With virtually none to hear in the newest discs—not a tick in the plastic for minutes on end and only the faintest rustle from the entire tape-to-disc transfer sequence—your listener now is likely to set his volume much too high right at the beginning. Rude shock when the music blasts. Believe me, such things are highly emotional matters, among those who take their listening seriously. And there we are, in the engineering field, systematically working to deprive our listeners of even more of this useful indicator!

My account is humorous, of course. I do not doubt that the totally silent background will prove a temporary problem. We will learn to equate our levels with other elements than surface noise, hopefully within the music itself. Music does offer positive clues as to “absolute” volume in the tone color of instruments playing loud or soft. These colorations, well microphoned, are easily apparent in recordings.

But dynamic range, you see, is a more difficult matter, with more profound implications. And that is why I am emboldened to predict a major listening revolution as the end-result of our present situation. We have learned to live profitably with our current living-room transliterations of non-living-room music. The musical benefits have been enormous. But perhaps we now must unlearn. And learn again.

Having at last really heard a full concert dynamic range in our homes, undistorted, undisturbed by audio noise, for the first time taking full advantage of the *low end* of the dynamic scale, where formerly all was mud, we will marvel—and ask for more.

We will force ourselves, then, to pay closer attention, not only to the ever-expanding stereo subtleties of the recorded surround (*vide* Vanguard’s four-channel, front-rear *Surround Stereo*), but to both loud and soft extremes in their true proportion. We will have to hear those *pianissimi*, and follow their sense, in spite of the refrigerator. We will have to persuade the neighbors that loud music is good music, too. Or they will persuade us. (It could be a mutual *detente*.)

And in the long run we will simply have to change our life, to get rid of all the ambient interferences that are now normal at home, even if it means a rebuilding and redecorating much more radical than any that stereo demanded, and eventually got.

The point is, that the more literal we get in our recording, the more demanding is the music for our entire attention. We will simply have to learn to listen consciously, all-out, rather than letting our music seep into us, in the time honored background manner, along with the coffee and the tall drinks or what have you. A big revolution, if and when.

Not likely in a rush! America’s listening habits don’t change that easily. But the seeds are definitely planted. Stereo, even before four-channel, has already brought a more direct sort of listening in response to its more immediate sense of spatial perspective and separation. Stereo isn’t much use in the background. We are already well en route to a more literal involvement in music, across the board, even—just maybe—in such unlikely areas as automobile cartridge music. (Why else the gains by the controllable auto cassette in competition with the play-it-straight-through cartridge?) And so *Phase Three*, the low-noise revolution, is more involved in musical aesthetics than most engineers know, and will be ever more so.

Two new records, out of many that might be mentioned, illustrate radically different kinds of music benefiting from low-noise techniques.

1. *Sibelius: Symphony No. 5. New Philharmonia Orch., Georges Pretre. RCA LSC 2996.* Of all late-Romantic composers, Sibelius relies the most on the concert-hall effect of a vast dynamic range. In this extraordinary recording (see others in the series) these dynamics are brought out astonishingly, against a dead-silent background that is almost spooky. Try the famed series of loud, isolated chords (not a trace of groove echo!), with total silence in between, that ends the music. Marvelous demonstration of what can now be done with concert dynamics.

2. *Spider John Koerner et al. Running Jumping Standing Still. Elektra EKS 74041.* This somewhat personalized and intimate disc of Minnesota-based pop features superbly clean recording and a great variety of instrumental tone color spread out in intriguingly “dry” stereo. But, again, it is the silent background which gives it a new realism, as though the performers were in the room, not on records.

Note a remarkable use of silence, a loud “explosion” (the low keys of a piano pressed down with the dampers removed), clearly symbolizing the Bomb which fades and fades and fades, down into an incredible stillness, thereby suggesting as no record has before the total cessation of life that might follow such a debacle as the real Bomb. An impressive use of recorded silence, and technically well ahead of the prototype effect in the Beatles’ long slow fade (the end of Sgt. Pepper if I remember rightly).

Don’t hunt for this passage; just play the record through and let it hit you. *But listen in silence!* Or you’ll miss it altogether. That’s the revolution.

37th AES Convention

QUICK SUMMARY

Sunday, October 12th—Welcoming Cocktail Party,
Nassau Suite, 2nd Floor, New York Hilton Hotel, 1355
Avenue of the Americas, New York, N. Y.

REGISTRATION

Promenade, N.W. 2nd Floor (Outside Rhineland
Gallery North) N. Y. Hilton

Monday, October 13 — 8:30 A.M. to 8:00 P.M.

Tuesday, October 14 — 9:00 A.M. to 8:00 P.M.

Wednesday, October 15 — 9:00 A.M. to 5:00 P.M.

Thursday, October 16 — 9:00 A.M. to 8:00 P.M.

BANQUET

Social Hour: 6:00 P.M.—Mercury Rotunda, 3rd Floor

Banquet: 7:00 P.M.—Mercury Ballroom, 3rd Floor

TECHNICAL SESSIONS

Gramercy Suite, 2nd Floor, New York Hilton

Monday October 13

9:00 A.M.—**Annual Business Meeting**

9:30 A.M.—**Broadcasting**

1:30 P.M.—**Transducers**

6:30 P.M.—**Audio Apparatus and Applications**

Tuesday, October 14

9:00 A.M.—**Developments in Electronic Music
Systems**

1:30 P.M.—**Audio Aids to Medicine**

7:00 P.M.—**Special Evening—Sound Reinforce-
ment for the Performing Arts**

Wednesday, October 15

9:00 A.M.—**Disc Recording**

1:30 P.M.—**Audio Abroad I**

Thursday, October 16

9:00 A.M.—**Audio Abroad II**

1:30 P.M.—**Magnetic Recording**

7:00 P.M.—**Audio Abroad III—Special Program
by U.S.S.R. Scientists.**

EXHIBITS

Rhineland Gallery, New York Hilton

Monday and Tuesday—Noon to 9:00 P.M.

Wednesday—Noon to 5:00 P.M.

Thursday—10:00 A.M. to 3:00 P.M. (tentative)

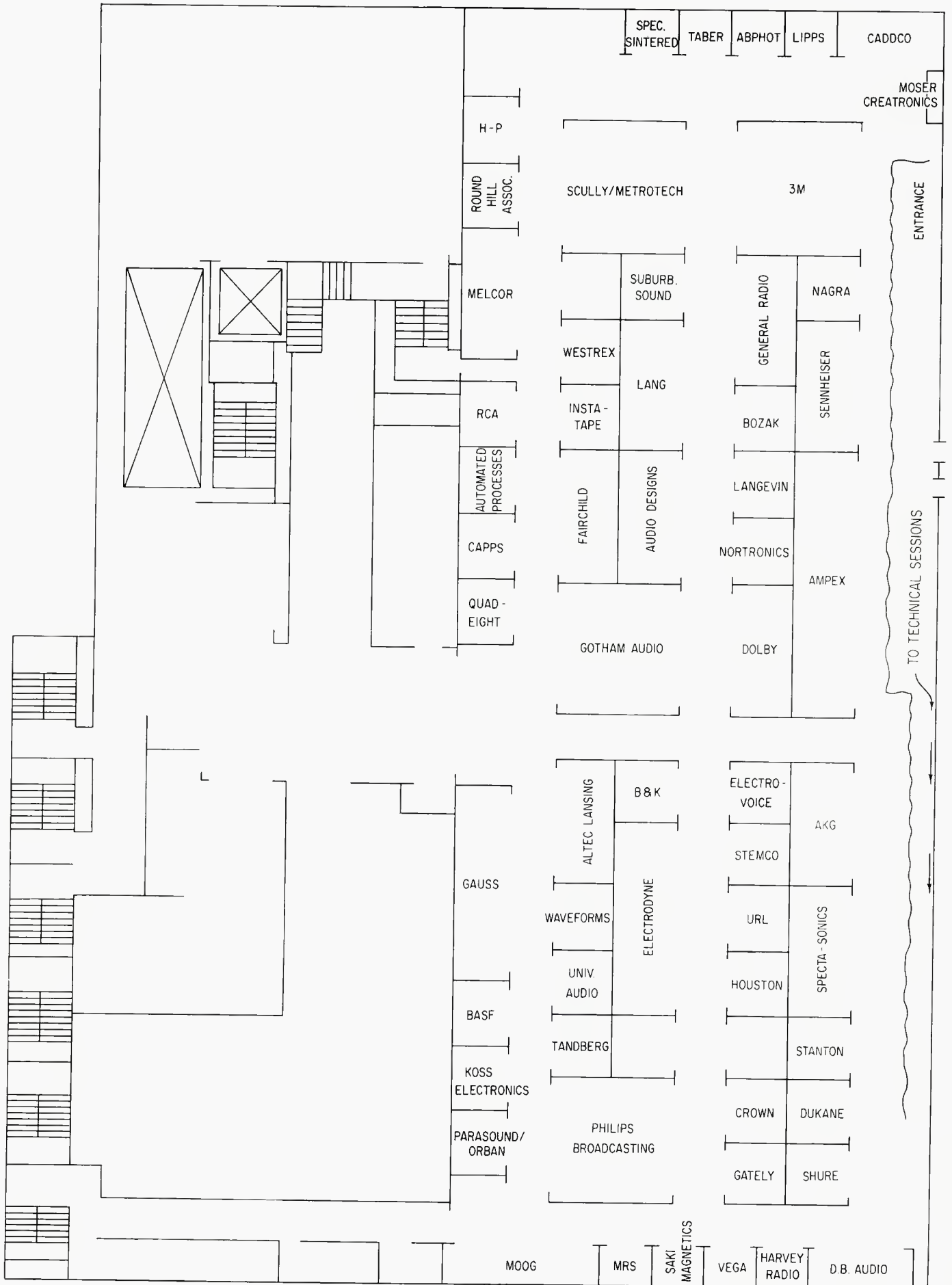

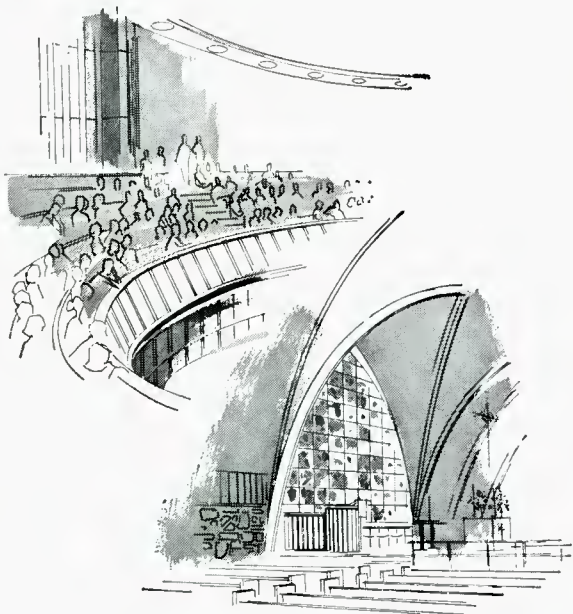

let's shed a little light on **VARACOUSTICS**

When the lights are turned down, VARACOUSTICS takes the limelight. Sound becomes all important for the participation and satisfaction of the audience.

For only a portion of the cost of the electrical system, you can afford VARACOUSTICS, DuKane's new Sound Control Process designed for use in auditoriums, churches and meeting rooms. Combine it with our Medallion electro-acoustic equipment for guaranteed results.

With this technique, the individual acoustic characteristics of the room are analyzed, charted, and then equalized, becoming an integral part of the sound system design and circuitry.

The result is as much gain (volume) as you can use, plus greatly improved intelligibility—no ringing, no feedback, no dead spots—just natural, pleasing audio and an equal partnership with good lighting.

Your DuKane Distributor, a specialist in the application of this new process, has the training, test equipment, and interest to make Varacoustics work and succeed for you.

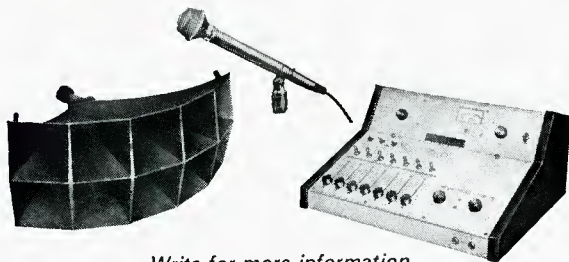

Write for more information.

DUKANE CORPORATION
COMMUNICATIONS SYSTEMS DIVISION
DEPT. DB-109 ST. CHARLES ILLINOIS 60174

CS-178

THE PAPERS

Monday, October 13, 9:30 A.M.

BROADCASTING

Chairman: LEWIS D. WETZEL

Triangle Stations, Philadelphia, Pennsylvania

A Dynamic Presence Equalizer—Richard G. Allen, Emil L. Torick and Benjamin B. Bauer, CBS Laboratories, Stamford, Connecticut

A New Approach to Modular Console Design—Edward J. Gately, Jr., Gately Electronics, Havertown, Pennsylvania

The Belar "Mod Minder"—A New Method of Automatically Controlling Audio Levels—Arno M. Meyer, Belar Electronics Laboratory, Inc., Upper Darby, Pennsylvania

Bi-Radial and Spherical Stylus Performance in a Broadcast Disc Reproducer—J. R. Sank, RCA, Camden, New Jersey

LOUDNESS MEASUREMENT AND CONTROL IN SOUND BROADCASTING—R. A. Hackley, H. F. Olson and J. A. Wissner, RCA, Broadcast Audio Engineering, Meadow Lands, Pennsylvania

Monday, October 13, 1:30 P.M.

TRANSDUCERS

Chairman: WILLIAM S. BACHMAN

Columbia Records, Milford, Connecticut

An Inertial, Head-Contacting Audio Communications Headset System—G. J. Sebesta, A. J. Mellen and R. W. Carlisle, Dyna Magnetic Devices, Inc., Hicksville, New York

Recent Developments in the Field of Condenser Microphones—Hans-Joachim Griese, Sennheiser Electronic Corp., Bissendorf, West Germany

An Electrostatic Condenser Type Phonograph Pickup Cartridge—Hirotake Kawakami, Sony Corporation, Tokyo, Japan

Experimental Determination of Low Frequency Loudspeaker Parameters—J. Robert Ashley and Mark D. Swan, University of Colorado, Colorado Springs, Colorado

Loudspeaker System Using Operation Action Nonlinear Amplifier Configurations—Keith O. Johnson, Gauss Electrophysics, Inc., Santa Monica, California

Electronic Crossover Networks and Their Contribution to Improved Loudspeaker Transient Response—Allan P. Smith, U. S. Naval Training Device Center, Orlando, Florida



WFLA AM/FM STEREO, TAMPA

WFLA had an opening in their recording studio. They filled it with a Magnecord 1021.

Magnecord tape recorders occupy a large number of highly responsible positions in the communication's world. Somewhere in the hills of Turkey, Magnecords are listening to foreign language broadcasts. And closer to home, voice-controlled Magnecords wait patiently to hear from our men in outer space. These are the kind of recommendations that got Magnecord its position at WFLA.

The tape recorders at WFLA run day after day, all day, under the most exacting broad-

cast conditions. And that's Magnecord's kind of work. The tougher the better. (Because Magnecords are built to take it, day after day, every day of the year.) The die-cast mainplate assures you of permanent mechanical alignment. Timing accuracy is held constant by the hysteresis synchronous capstan tape drive. And the payout and take up reels have their own heavy duty split-capacitor motors.

The quality of a Magnecord does not vary from model to model. But features do. If you would like the complete story on our full line of Magnecords, write. We'll see that you get an answer. Promptly.

PRODUCTS OF SOUND RESEARCH
TELEX[®]
 COMMUNICATIONS DIVISION
 9600 Aldrich Avenue South
 Minneapolis, Minnesota 55420

Circle 40 on Reader Service Card

Harvey's has a studio fader that combines the best qualities of spaghetti, satin and mice.

The more channels you add to your consoles, the larger they become, unless you find a way to make the equipment smaller. Which is where Harvey's can help you.

We've got a straight-line studio fader that, while it's not quite as thin as spaghetti, comes closer than anything else we've seen. It was made by Penny and Giles, who adapted a conductive plastics technique they used so successfully in the design of precision potentiometers for the aerospace and computer industries in England.

The new Penny and Giles fader offers lots of advantages over conventional slide-wire faders. For one thing, it's as quiet as a mouse (there's minimal extraneous electrical noise). And its feel is smooth as satin.

Each fader comes with a cue switch and an auxiliary equipment switch which may be used to start or stop tape machines, telecine equipment, turntables, signal lights, etc.

The new device, available in America exclusively at Harvey's, has gained wide acceptance in Europe, where it's recognized as being not only narrow, smooth and quiet, but reliable as Big Ben, besides.

Harvey Radio Co.

Professional A/V Division, 2 West 45th St.,

New York, N. Y. 10036. (212) JU 2-1500.

Circle 39 on Reader Service Card

Monday, October 13, 6:30 P.M.

AUDIO APPARATUS AND APPLICATIONS

Chairman: HAROLD O. KAITCHUCK,
Boulevard Recording Studios, Inc., Chicago, Illinois

The Harmonic Compressor, A System For Doubling, Information Rates of Speech—John W. Breuel and Leo M. Levens, American Foundation for the Blind, Inc., New York, New York

Toward Complete Laboratory-Design of Sound Reinforcement Systems—Daniel Queen, Ampli-Vox Dept., Perma-Power Division, Chicago, Illinois

New Real Time 1/3 Octave Analyzer—Jan Soberg, B & K Instruments Inc., Cleveland, Ohio

Design Considerations for a Speakerphone Development—W. H. Heaven, Northern Electric Company Limited, London, Ontario, Canada

Portable Teaching Machine—George Wechster, Viewlex, Inc., Holbrook, New York

"Invisible" Sound Reinforcement with 350 Microphones—Peter W. Tappan, Bolt Beranek and Newman Inc., Downers Grove, Illinois, and Robert F. Ancha, Ancha Electronics, Inc., Chicago, Illinois

A Differential Type Telephone Repeater Circuit—Joseph H. Dessen, Audio Research Products Co., Blackwood Terrace, New Jersey

A Re-Evaluation of Some Methods of Measuring Distortion—Norman H. Crowhurst, Gold Beach, Oregon

Tuesday, October 14, 9:00 A.M.

Chairman: EARLE L. KENT
C. G. Conn Ltd., Elkhart, Indiana

DEVELOPMENTS IN ELECTRONIC MUSIC SYSTEMS

Hearing By Ears Instead of Apparatus—Paul C. Boomsliter, State University of New York at Albany, and Warren Creel, Albany Medical College, Albany, New York

SEQUENCERS IN ELECTRONIC MUSIC—Gustav Ciamaga, Electronic Music Studio, University of Toronto, Toronto, Ontario, Canada

The Sonde; A New Approach to Multiple Sine Wave Generation—Hugh Le Caine, National Research Council, Ottawa, Ontario, Canada, and Gustav Ciamaga, Electronic Music Studio, University of Toronto, Toronto, Ontario, Canada

Digital-Controlled Electronic Music Modules—Robert A. Moog, R. A. Moog, Incorporated, Trumansburg, New York

Derivative Synthesis of Musical Tones—Eric Gschwandtner, Radatron, Inc., North Tonawanda, New York

Tuesday, October 14, 1:30 P.M.

AUDIO AIDS TO MEDICINE

Chairman: PHILIP KANTROWITZ

Sonotone Corporation, Elmsford, New York

Stethoscope Acoustics and the Physician—Paul Y. Ertel, M.D., Assistant Professor, Department of Pediatrics, Children's Hospital, Columbus, Ohio

Ultrasound in Retinal Detachment Surgery—David B. Karlin, M.D., Department of Ophthalmology, Mt. Sinai School of Medicine, New York, New York

Brain Waves Made Audible, Encephalophone An Electronic Stethoscope for the Brain—Horace T. Castillo, Eastern Research Support Center, V. A. Hospital, Yale University School of Medicine, New Haven, Connecticut

Signature Analysis of Heart Sounds and Murmurs—Benedict Kingsley, Hahnemann Medical College and Hospital, Philadelphia, Pennsylvania

Auto Correlation and Crosscorrelation Applied to Phonocardiograms—Samuel Litman, University of South Carolina, School of Engineering Columbia, South Carolina

The Effect of Sound on Plant Growth—Paul E. Newton, Institute of Environmental Research, Kansas State University, Manhattan, Kansas

The Electronics of Nervous Transmission—Marvin D. Weiss, New Haven College, Woodbridge, Connecticut

Tuesday, October 14, 7:00 P.M.

A SPECIAL EVENING

SOUND REINFORCEMENT FOR THE PERFORMING ARTS

Chairman: WILLIAM E. WINDSOR

D. B. Audio Corp., New York, New York

Operational Aspects of Sound Reinforcement at the Saratoga Performing Arts Center—Stanley Hanna, Saratoga Performing Arts Center, Saratoga Springs, New York

Sound Reinforcement in the Theatre—T. Richard Fitzgerald, Sound Associates, Inc.

Wednesday, October 15, 9:00 A.M.

DISC RECORDING

Chairman: JOHN M. EARGLE

Mercury Records, New York, New York

Straight Line Phonograph Arms and Devices—Jacob Rabinow, RABCO, Silver Spring, Maryland

Frequency Response Analysis of Phono Pickups on Calibrated Test Records—Bernhard W. Jakobs, Shure Brothers, Inc., Evanston, Illinois

The Second Generation Dynamic Recording Correlator—E. C. Fox, RCA Laboratories, Princeton, New Jersey and Michel Pradervand, RCA Records, Indianapolis, Indiana

When you think Meters... Think Best Value! Choose Heath!

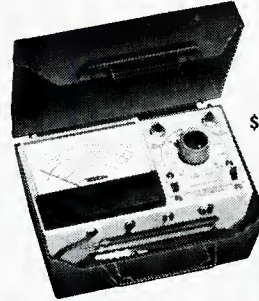

Kit
\$21.95

Heathkit IM-17 Solid-State Volt-Ohm-Meter

- 4 AC & DC volts ranges from one volt full scale to 1000 volts • 4 Resistance ranges measure from 0.1 ohm to 1000 megohms • 11 megohm DC input impedance, 1 megohm AC • Response 10 Hz to 1 MHz • Battery powered • Includes all probes and portable case

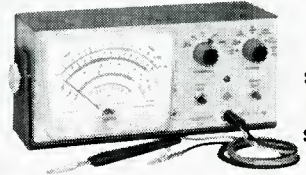

NEW
Heathkit IM-28
Bench Type VTVM

Kit
\$39.95
Wired
\$59.95

- New Heathkit styling • 7 DC & AC volts ranges — 1.5 volts full scale to 1500 volts • 7 Resistance ranges measure from one ohm to 1000 megohms • Response 25 Hz to 1 MHz • 11 megohm DC input impedance, 1 megohm on AC • AC powered • 6" meter

NEW Heathkit IM-18 Standard VTVM

- A restyled version of the IM-11
- 7 DC & AC volts ranges from 1.5 volts full scale to 1500 volts • 7 Resistance ranges measure from one ohm to 1000 megohms • Response 25 Hz to 1 MHz • 11 megohm DC input impedance, 1 megohm on AC • AC powered

Kit
\$29.95
Wired
\$49.95



NEW Heathkit IM-38 Lab AC VTVM

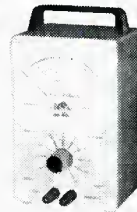

Kit
\$41.95
Wired
\$57.95

- Features the Heath "New-Look"
- 10 AC volt ranges measure from 0.01 to 300 volts RMS full scale • Decibel range —52 to +52 total in ten ranges • Response 10 Hz to 1 MHz • 10 megohm input impedance • AC powered

Heathkit IM-25 Solid-State Volt-Ohm-Milliammeter

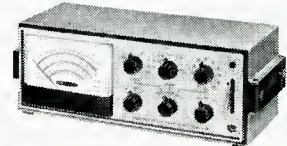

Kit
\$85.00
Wired
\$120.00

- 9 DC & AC volts ranges — 150 millivolts full scale to 1500 volts • 7 Resistance ranges measure from one ohm to 1000 megohms • 11 Current ranges — 15 uA full scale to 1.5 A • Response to 100 kHz • 11 megohm DC input impedance, 10 megohm on AC • Battery or AC power

Heathkit IM-16 Solid-State Volt-Ohm-Meter



Kit
\$46.95
Wired
\$69.95

- 8 DC & AC volts ranges — 500 millivolts full scale to 1500 volts • 7 Resistance ranges measure from one ohm to 1000 megohms • 11 megohm DC input impedance, 1 megohm on AC • Battery or AC power

HEATH COMPANY, Dept. 74-67
Benton Harbor, Michigan 49022



- Please send my FREE 1970 Heathkit Catalog
- Enclosed is \$ _____, plus postage

Please send model (s) _____

Name _____

Address _____

City _____ State _____ Zip _____

Prices & specifications subject to change without notice. TE-206

Circle 41 on Reader Service Card

Development and Application of a New 'Tracing Simulator—Stephen F. Temmer, Gotham Audio Corporation, New York, New York and Dieter Brashchoss, Georg Neumann, GmbH, Germany

Improvements in Performance of the Westrex 3D Stereodisc Recorder—Frank E. Pontius, Westrex, Hollywood, California

Octave-Band Power Distribution of Recorded Music—Benjamin B. Bauer, CBS Laboratories, Stamford, Connecticut

An Experimental Study of Groove Deformation in Phonograph Records—James V. White, Acoustics Research Laboratory, Harvard University, Cambridge, Massachusetts

Wednesday, October 15, 1:30 P.M.

AUDIO ABROAD I

Chairman: J. L. OOMS

Philips' Phonographic Industries, Bearn, The Netherlands

Psychological Evaluation of Non-linear Distortion—H. Yahiro, A. Kameoka and M. Kuriyagawa, Toshiba Research and Development Center, Kawasaki, Japan

Phenomenological Interpretation of the Print-Through Effect by Means of the Preisach Diagram—Jiri Struska, Research Institute of Sound and Picture (Vuzort), Prague, Czechoslovakia

Correct Spatial Sound Perception Rendered by a Special 2-Channel Recording Method—R. Kurer, G. Plenge, H. Wilkens, Technical University, Berlin, Germany

Loudspeakers For Model Investigations—Ales Boleslav, Research Institute of Radiocommunications, Prague, Czechoslovakia

Where is Recording Going?—Peter K. Burkowitz, Deutsche Grammophon Gesellschaft mbH, Hannover, Germany

Music and Recording in the Soviet Union—John M. Woram, RCA Record Division, New York, New York

Means for Visual Indication of the Overload Limit for Audio Power Amplifiers—Luciano Foa, Voxson, Rome, Italy

Wednesday Evening, October 15, 1969

6:00 P.M. **Social Hour** — The Mercury Rotunda

New York Hilton Hotel

7:00 P.M. **Awards Banquet** — Mercury Ballroom

New York Hilton Hotel

Guest Speaker — DR. FRANK STANTON, President The Columbia Broadcasting System

Thursday, October 16, 9:00 A.M.

Chairman: *Deutsche Grammophon GmbH, Hannover, Germany*

AUDIO ABROAD II

The Electro-Acoustic Transducer for the Measurement of Acoustical Impedances—Tomas Salava, Research Institute of Radio communications, Prague, Czechoslovakia

Amplification of Sound Fields Without Instability—N. V. Franssen, Philips Research Laboratories, Eindhoven, The Netherlands

Modern Electro-Acoustics in the Theater—A. A. Freund, and W. Sziemer, Wiener Schwachstromwerke GmbH, Vienna, Austria

A System Approach to Stereophonic Recording—V. Zugio, Radio-Televizija Beograd, Belgrade, Yugoslavia

Low Distortion Loudspeaker System—T. Sugimoto, S. Kawamura, and A. Ema, Hitachi Ltd., Yokohama, Japan

H-Fi and Studio Engineering: Notes on Quality of Sound Transmission—Ernst-Joachim Volker, Hessischer Rundfunk, Frankfurt/M, Germany

An Electronic Forward Drive in Transcription Turntables—Frank Hirsch, Thorens-Franz AG, Wettingen, Switzerland

Thursday, October 16, 1:30 P.M.

MAGNETIC RECORDING

Chairman: R. C. MOYER

RCA/Record Division, Indianapolis, Indiana

The Design of a High-Performance Tape Duplicating System—Peter F. Hille, Ampex Corporation, Special Products Division, Redwood City, California

Musicassette Interchangeability; The Facts Behind the Facts—E. R. Hanson, North American Philips Corporation, New York, New York

Performance Characteristics of Commercial Recorded Tapes—John Eargle and James Ward, RCA Records, New York, New York

A Beamed Bias Synchronous Record/Reproduce Head Using Multiple Aperture, Multiple Winding Construction—Keith O. Johnson, Gauss Electrophysics, Inc., Santa Monica, California

A DC Servo Controlled Magnetic Tape Transport—Gerald S. Macdonald, Magnetic Recording Systems, Inc., Westbury, New York

Signal Conditioning For Slow Speed Tape Recordings—James B. Wood, GRT Corporation, Sunnyvale, California

Optimizing The Subjective Signal And Noise Levels In Commercial Tape Records—J. G. McKnight, Ampex Stereo Tape Division, Redwood City, California

Thursday, October 16, 7:00 p.m.

AUDIO ABROAD III

A special program by scientists from the U.S.S.R. At the time of publication, negotiations were not completed as to the exact nature of the papers to be given. An addendum sheet to the program will be offered at the Convention



If the down time on your console is up and there are knobs labeled "Don't Touch". If you have sounds coming out that are not supposed to be in — or you simply need a console — then it is time you heard of CADDCO. . . . We can offer you a console that will put you back in business/competition and surprise you with its ease of operation and sound quality. Giving you the choice of either modular or custom design, CADDCO consoles are built with uncompromising attention to detail and performance. Bring your desires to our attention. We would appreciate the opportunity of assisting you. CADDCO Audio Industries Corporation, Drawer K, Norwood, N. J. 07648 Phone 914-359-4434 AES Convention Booths 31 & 32.

Circle 42 on Reader Service Card

TAPE TIMERS • TAPE TIMERS • TAPE TIMERS

TIMEKEEPER has the new Michael Scott TAPE-TIMERS in stock for immediate delivery. These low-cost, high quality tape timers offer these advantages:

- Easily mounted on any 1/4 inch tape machine.
- Accuracy within 2/1000 independent of tape speed.
- Precision ball bearings—no need for lubrication ever.

Save time and money by winding tape at high speed with the same timing accuracy associated with normal speeds.

Why use a TAPE-TIMER in place of a stop watch? Simply because the stop watch is independent of the tape which itself is subject to elongation or contraction—plus other factors associated with the recorder itself. Most important, the stop watch cannot be rewound with the tape! Only a TAPE-TIMER moves with the tape so that you always know where you are for any editing, processing, or revisions. It is an indispensable tool for the serious tape user. At this low price you can no longer afford to be without one.

Two models are available:

Professional High-Speed TAPE-TIMER \$79.95
(7.5 and 15 in./sec.)

Standard TAPE-TIMER \$39.95
(7.5 and 3.75—can also be used at 15 in./sec.)

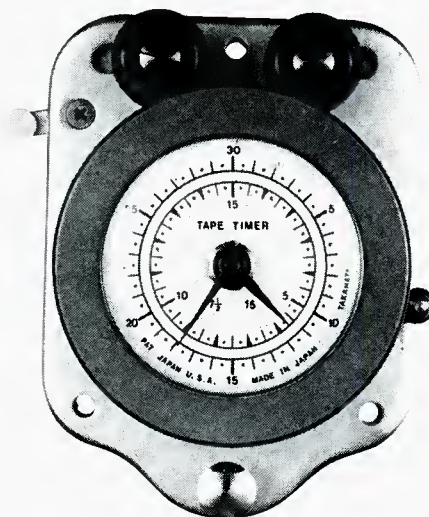

PRO MODEL

Each TAPE-TIMER is fully guaranteed to meet with your complete satisfaction or your money will be promptly refunded. Use the handy coupon.

TO: TIMEKEEPER
P.O. Box 762
Mineola, New York 11501

Enclosed is a check for \$ Please send Pro Model TAPE-TIMERS at \$79.95 each.

. Standard Model TAPE-TIMERS at \$39.95 each.

Shipping costs: add \$1.00 to order regardless of quantity.

Name Company

Address

City State Zip

(New York State residents must add 5% sales tax)

Circle 43 on Reader Service Card

New Products and Services

PHONO CARTRIDGE



●The improved version of the V-15 Type II may be identified by the fact that the manufacturer's name appears in red letters instead of black on the stylus grip. Advances are claimed in trackability across the entire audio spectrum. Stylus forces of 3/4 gram are claimed for most records including those with heavy modulation. This included bass passages which formerly required higher forces to overcome i.m. distortion and bass flutter. For studios with existing V-15 Type II units, replaceable elliptical stylus-only, model VN15E Improved, may be had.

Mfr.: Shure Brothers, Inc.

Price: \$67.50 (stylus only is \$27.00)

Circle 63 on Reader Service Card

POWER AMPLIFIER

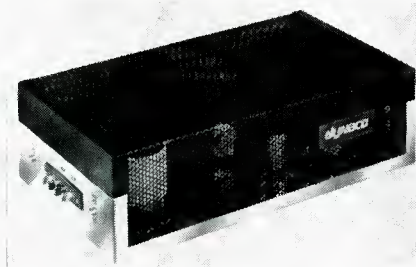

●Low cost reliability is claimed for this solid-state stereo amplifier rated at 40 watts continuous per channel. T.h.d. is rated at under 0.5 per cent at rated output, and i.m. is under 0.1 at rated output. Built-in current limiting circuitry eliminates the need for protective fusing, and permits placement of the amplifier in relatively inaccessible locations. Kit and factory-assembled versions are available.

Mfr.: Dynaco Div.

Price: \$119.95 kit, \$159.95 assembled

Circle 66 on Reader Service Card

CASSETTE DUPLICATOR

●A new reel-to-cassette duplicator has been designed for educational and other dubbing markets. Model 235-CS consists of an open-reel master transport and cassette slave modules. Each slave module contains three cassette transports. Both master and slaves are two speed units with hysteresis-synchronous drive. The master operates at 15 and 7 1/2 in./sec. and the cassette slaves operate at 7 1/2 and 3 3/4 in./sec. Wide-band, solid-state electronics are of a modular plug in type. Half-track, single and dual channel, quarter-track dual channel, and quarter-track four channel (simultaneous) configurations are available.

Mfr.: Telex

Price- under \$2000 for a half track, two channel system with three slaves.

Circle 65 on Reader Service Card



CARTRIDGE PLAYER

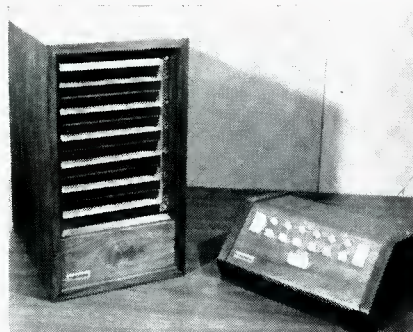

●The MINI-MATE is an automated multi-cartridge tape player providing programmed automatic sequencing, yet permitting full manual operator control. It provides high-quality audio mono or stereo. Cartridges may be loaded and started in a random manner providing instantaneous sound at the touch of a button. Or the unit may be set to sequence automatically, obtaining live breaks in the sequence at the touch of a pause button. An accessory auxiliary cue permits it to operate a slide projector. A time accessory permits the unit to be used automatically for station i.d.'s.

Mfr.: Ampro Corp.

Circle 67 on Reader Service Card

BOOSTER AMPLIFIER

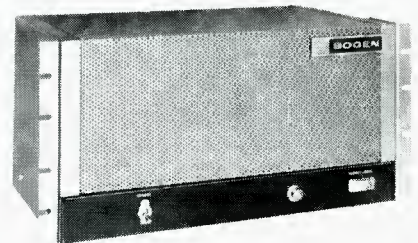

●Model NTB250 is an all-silicon transistor booster amplifier designed to provide both high power and high reliability in p.a. systems requiring continuous coverage of large areas. Up to 350 watts are available for continuous duty at less than 5 per cent harmonic distortion between 50 and 12,000 Hz. Ambient temperatures for this capability are within a range up to 158-degrees F. Several boosters may be paralleled for increased power. A special feature is a 120 V a.c. power output which, when coupled with a variable frequency signal generator, provides a source of variable frequency power for motors and shake tables. Short and overload protection devices automatically turn off power if necessary. The amplifier may be operated off 24 V d.c. as well as 120 V a.c. Outputs include 8 ohms, 25 and 70 volts, balanced or unbalanced.

Mfr.: Bogen Division.

Circle 53 on Reader Service Card

PORTABLE CONSOLE



•Take this portable public-address console, model 1210A with you and you have a new power amplifier rated at 100-watts continuous, seven input channels, and four two-position feedback filters. Other features include hi/lo gain inputs to protect against overloading distortion; built-in reberlg and reverb switching on each of six mic input channels; reverb timbre control; and an input for external reverb or tape-echo devices. The carrying case is tough and finished in vinyl for durability. There is a locking lid.

Mfr.: Altec Lansing Div.
Circle 55 on Reader Service Card

SOUND LEVEL METER

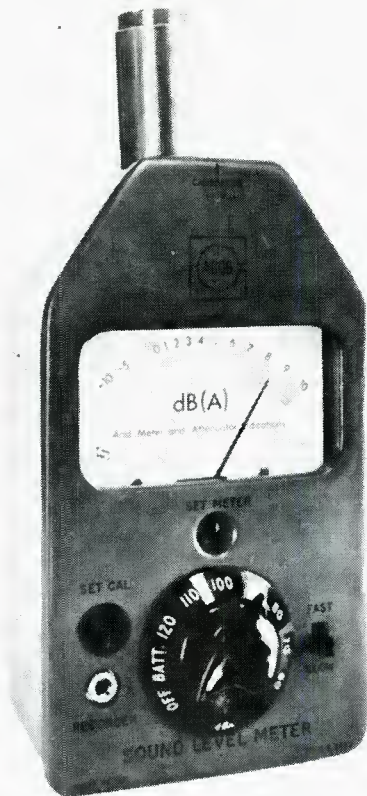

ACOUSTIC FEEDBACK SUPPRESSORS
For all P.A. work — churches, theatres, stadiums, conference rooms, auditoriums, transportation terminals, etc. — available from stock or built to specifications. Demonstrations — Rentals — Sales. Write
AUDIO INSTRUMENT CO. INC.
311 Mountain Rd.
Union City, N. J. 07087

•SLM-3 is the designation for this compact, self-contained instrument. It has been designed for the purpose of checking conformity with the provisions of the Walsh-Healy Act, limiting industrial noise. The range is 50 to 130 dB and its scale is based on the A weighted curve. Each instrument is individually calibrated and comes with its own matched microphone. The resulting accuracy meets the requirements of International Standard IEC-123. Accessories increase the versatility of the unit. One such is an amplifier that permits measurements at a low threshold of 30 dB.

Mfr.: Acos (Trans Atlantic Electronics)
Price: \$165
Circle 64 on Reader Service Card

WILL I HEAR THE DIFFERENCE?

If your turntable rumbles and wows . . . If your amplifiers put out only five watts at 10% distortion . . . If your speakers have a frequency range just good enough for speech . . . If your phono arm has the incorrect overhang required by the older record changers . . . If your cartridge requires a vertical force of a dozen grams to keep its stylus in the groove . . . And if your records have been torn and mutilated by that stylus — **YOU ARE NOT LIKELY TO HEAR THE DIFFERENCE.**

BUT If you own one of the many superb modern amplifiers . . . If your turntable produces no audible rumble or wow . . . If you have selected your speakers from the many excellent models available today . . . If your cartridge has a response that evenly covers the audible range of frequencies with little distortion . . . And if the recommended tracking force is of the order of one gram . . .

THEN You owe it to the engineers who designed your equipment, to the artists and technicians who produced your records and, above all, to yourself to . . .

LISTEN TO THE SL-8 and

**hear
the difference!**

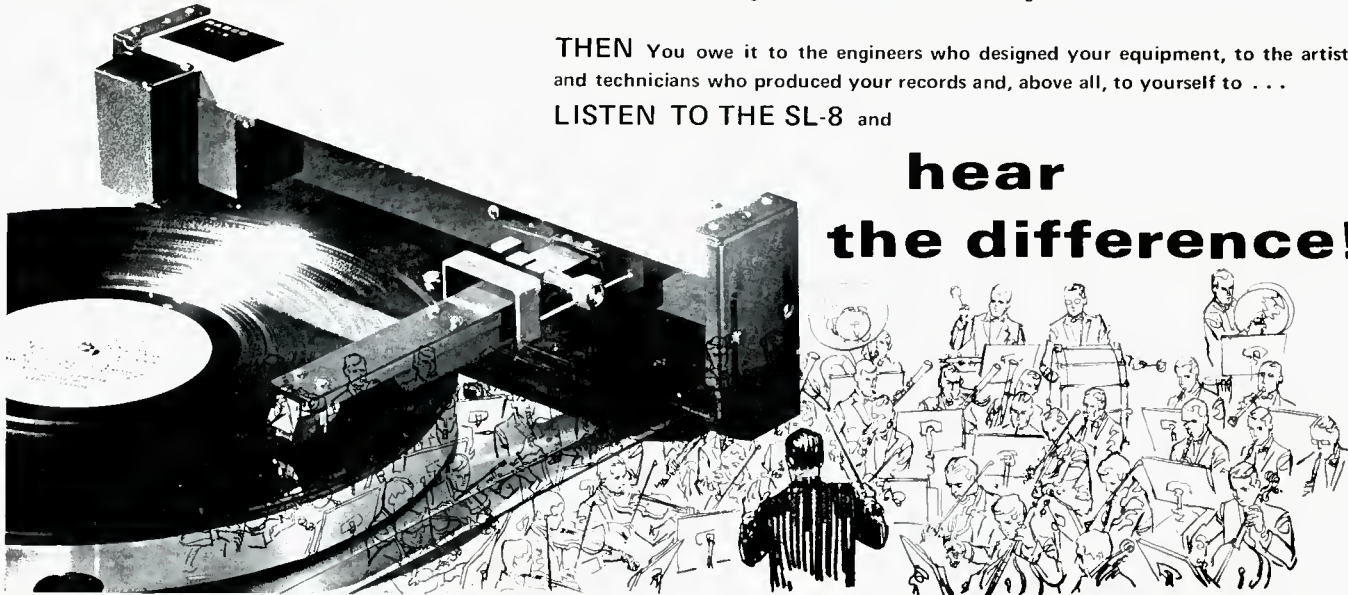

RABCO

MANUFACTURERS OF THE ONLY STRAIGHT LINE, SERVO DRIVEN PHONOGRAPH ARM.
11937 TECH ROAD, SILVER SPRING, MARYLAND 20904

Circle 44 on Reader Service Card

SOUND SYSTEMS

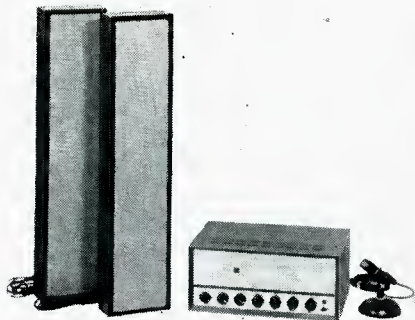

● A number of packaged sound systems have been introduced that range from 20 watts to 100 watts. All four systems use a cardioid microphone and six-speaker sound column with 120° coverage horizontally and 30° vertical coverage. Each of the systems contain pre-wired components including connecting cables. Custom modifications to the amplifiers is possible.

Mfr.: Bell P/A Products

Price: \$285 to \$920

Circle 62 on Reader Service Card

db Binders

only \$4.95
postpaid

Heavy-weight binders are now available to hold the thirteen issues of Volumes 1 and 2. Rich brown leather-grained virgin vinyl, with our name printed in black on the spine and front cover, is electronically sealed over rigid board to give your volumes of db lasting protection. Keep your copies preserved in perfect condition, protected from dust and damage.

Please send me _____ copies of the db Magazine binder. My check for \$_____ is enclosed (sorry, no c.o.d.).

Name _____

Address _____
number and street

city _____ state _____ zip _____

(New York State residents please add 5% sales tax).

Mail to: db, the Sound Engineering Magazine, 980 Old Country Road, Plainview, N.Y. 11803.

RANDOM-ACCESS SWITCH

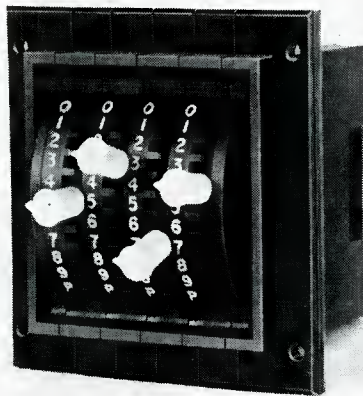

● A total of 250,000 operations are promised from this random-access unit which will switch from any one position to any of ten others without making contact with intermediate switch points. It has modular, expandable construction which allows any practical number of units to be stacked side-by-side. Contacts will carry 3 amps static, 250 mA during switching and have a resistance of 75 milliohms maximum. The switch is designed for p.c. board mounting.

Mfr.: Sealectro Corp.

Circle 61 on Reader Service Card

PORTABLE DUPLICATOR



● Reel-to-cassette duplicates are made at four-times normal speed with the master travelling at 15 in./sec. and the cassette dubs at 3¾ in./sec. Two-track mono and four-track stereo versions are available; each duplicates both track widths simultaneously. Copy frequency response is 80 to 10,000 Hz, ±3 dB. The system is automatically shut down at the conclusion of the dubbing run. Noise increase from the master to the slave is within 2 dB in mono and 3 dB in stereo and flutter is below 0.2 per cent. Accessory slave banks permit eight more cassette duplicates per run, and an available adapter permits a cassette to function as the master.

Mfr.: CEE, Inc.

Price: \$2575 mono, \$3175 stereo

Circle 68 on Reader Service Card

MOVING?

Have you sent us a change-of-address notice? It takes time for us to change your plate so let us know well in advance of your move. Be sure to send us the complete new address *as well as your old address*. Include both zip numbers. Keep **db** coming without interruption!

BACK ISSUES AVAILABLE

A limited number of back issues of db are available to interested readers who may have missed or misplaced earlier issues. When ordering please indicate date of issue desired and enclose 75c for each copy.

CIRCULATION DEPARTMENT

db—The Sound Engineering Magazine
980 Old Country Road
Plainview, N.Y. 11803

**Today, a
college
education
is 1/3 paid,
2/3 aid.**

Student tuitions cover only one-third of college operating costs. If it weren't for the other two-thirds derived from tax funds and individual gifts, our colleges would be out of business. You can help a college help America stay in the lead. **Give to the college of your choice.**

**COLLEGE IS AMERICA'S
BEST FRIEND.**



advertising contributed for the public good

SET ASIDE THE DATES
OCTOBER 13 - 16
FOR THE
AUDIO ENGINEERING SOCIETY'S
37th TECHNICAL MEETING
A N D
EXHIBITION OF PROFESSIONAL EQUIPMENT
AT THE
NEW YORK HILTON



The db Bookcase

As a service to our readers we are pleased to offer these books from prominent technical publishers. All prices listed are the publishers' net. Shipping charges are included.

Use the coupon at the bottom of the page or give the complete title, author and coupon number. Be sure to indicate quantity on the special instructions line if more than one copy of a title is wanted. Full payment must accompany your order. We cannot ship c.o.d. Checks or money orders should be made payable to Sagamore Publishing Company, Inc. Because of the time required to process orders, allow several weeks for the receipt of books.

Broadcasting

RADIO BROADCASTING

edited by Robert L. Hilliard. Each of the five chapters has been written by a prominent educator with an extensive background of practical experience in commercial and educational broadcasting. The areas covered include: management and programming, operating and studio facilities, producing and directing, writing, performing. For those of you who want to, or must, operate on both sides of the control room, this is virtually required reading. 190 pages; 6¼ x 9½; indexed; clothbound.

\$6.95 (\$8.35 in Canada)
Circle 2 on Coupon Below

Reference

New 17th Edition of the famous RADIO HANDBOOK

Tells how to design, build and operate the latest types of amateur transmitters, receivers, transceivers, amplifiers and test equipment. Provides extensive, simplified theory on practically every phase of radio. Broad coverage; all original data, up to date, complete. 847 pages.

\$12.95 (\$15.50 in Canada)
Circle 10 on Coupon Below

How To

PRACTICAL PA GUIDEBOOK: HOW TO INSTALL, OPERATE AND SERVICE PUBLIC ADDRESS SYSTEMS

by Norman H. Crowhurst. 1967. This book gives all the basics needed to become a successful PA operator, in any situation where the reinforcement, relay, or distribution of sound can provide a service. It shows how to properly install, operate and service public address systems. All aspects of the subject, from survey to the selection of appropriate equipment, to installation, to routine operation and the maintenance of a finished system, are covered. Attention is given to solving problems encountered in providing successful service. The book's systematic and practical approach makes it highly useful to radio-TV servicemen, hobbyists, and PA equipment manufacturers. 136 pages; 6 x 9; illus; softbound.

\$3.95 (\$4.60 in Canada)
Circle 15 on Coupon Below

CLOSED-CIRCUIT TELEVISION HANDBOOK

by Leon Wortman. Gives comprehensive detailed information about the field in an easy-to-understand presentation. It's particularly suited to those who plan to use, install, and service cctv. Covers the subject from the simple single-camera system to the most exotic systems. 288 pages; 5½ x 8½; clothbound.

\$7.95 (\$9.50 in Canada)
Circle 18 on Coupon Below

Electronic Music

ELECTRONIC MUSICAL INSTRUMENTS

by Richard H. Dorf. Now in its third edition and sixth printing since its first appearance in 1954, this is considered the authority on electronic organs. This edition is completely rewritten to explain everything technical about today's organs. The book is of special value to organ designers and service technicians as well as electronics-minded hobbyists and prospective organ purchasers. Of special value are the author's many practical comments and expressions of opinion based on his years of musical, engineering, and management experience with electronic musical instruments. 393 pages; 239 diagrams and photographs.

\$10.00 (\$11.95 in Canada)
Circle 19 on Coupon Below

General Audio

THE TECHNIQUE OF THE SOUND STUDIO

by Alec Nisbett. This is a handbook on radio and recording techniques, but the principles described are equally applicable to film and television sound. It describes how the highest standards may be achieved not only in the elaborately equipped studio but also with simple equipment out on location. 264 pages; 60 diagrams; glossary; indexed; 5½ x 8½; clothbound.

\$10.50 (\$11.95 in Canada)
Circle 1 on Coupon Below

DESIGN OF LOW-NOISE TRANSISTOR INPUT CIRCUITS

by William A. Rheinfelder. 1964. Written for students as well as circuit design engineers interested in low-noise circuit design. Throughout, the book gives a multitude of time-saving graphs and design curves for the practical circuit designer. Simple derivations of all important formulas are also presented to help the reader obtain a deeper insight into the fundamentals of practical low-noise design. 128 pages; 6 x 9; illus.; clothbound.

\$5.50 (\$6.50 in Canada)
Circle 14 on Coupon Below

NEW!

THE AUDIO CYCLOPEDIA (2nd EDITION)

by Dr. Howard M. Tremaine. New and updated, here is the complete audio reference library in a single volume. It provides the most comprehensive information on every aspect of the audio art. This new edition includes the latest audio developments including the most recent solid-state systems and integrated circuits. It covers all subjects in the fields of acoustics, recording, and reproduction with more than 3400 related topics. Each topic can be instantly located by a unique index and reference system. More than 1600 illustrations and schematics help make complicated topics masterpieces of clarity. 1760 pages; 6½ x 9-3/8; hardbound.

\$29.95 (\$35.95 in Canada)
Circle 20 on Coupon Below

ACOUSTICS—ROOM DESIGN AND NOISE CONTROL

by Michael Rettinger. 1968. The enormous problems and hazards presented by noise are dealt within an orderly and practical manner. With many charts, graphs, and practical examples, the text covers the physics of sound, room acoustics, and design, noise and noise reduction. The author's many years of experience in the field and extensive knowledge (set down in two earlier books on acoustics) make this work a boon to architects, builders, designers, planners, and engineers. 392 pages; hardbound.

\$17.50 (\$20.90 in Canada)
Circle 21 on Coupon Below

Sagamore Publishing Company, Inc.
980 Old Country Road, Plainview, N.Y. 11803

Please send me the books I have circled below. My full remittance in the amount of \$..... is enclosed. N.Y. State residents add 5% sales tax.

1 2 3 4 5 6 7 8 9 10 11 12 13 14 15 16 17 18 19 20 21 22
23 24 25 26 27 28 29 30 31 32 33 34 35 36 37 38 39 40

Name.....

Street Address.....

City.....State.....Zip.....

Special Instructions.....

HANDBOOK OF ELECTRONIC TABLES & FORMULAS, (3rd Edition)

A one-stop source for all charts, tables, formulas, laws, symbols, and standards used in electronics. Devotes complete sections to items of interest to service technicians and to circuit design data. Includes a 8-page, full-color fold-out chart showing latest FCC allocations for the entire frequency spectrum. 232 pages; 5½ x 8½; hardbound
\$5.50 (\$6.60 in Canada)
Circle 8 on Coupon Below

Test and Maintenance

INTERMODULATION AND HARMONIC DISTORTION HANDBOOK

by *Howard M. Tremaine*. A complete reference guidebook on audio signal intermodulation and harmonic distortion. 172 pages; 5½ x 8½; softbound.
\$4.25 (\$5.25 in Canada)
Circle 9 on Coupon Below

Circuitry and Components

PASSIVE AUDIO NETWORK DESIGN

by *Howard M. Tremaine*. A complete and comprehensive guide to the design, construction, and testing of all types of attenuators, equalizers, and wave filters for the practicing audio technician or engineer. This authoritative text is one of the few written on the subject, and requires only nominal mathematical background. Written in easy-to-understand language, the content presents the basic design, construction, and testing considerations without the confusion often associated with passive networks. 288 pages; 5½ x 8½; softbound.
\$5.50 (\$6.45 in Canada)
Circle 5 on Coupon Below

TRANSISTORS FOR AUDIO FREQUENCY (AUDIO-FREQUENCY AMPLIFICATION)

by *Guy Fontaine*. 1967. This systematic and detailed treatment of the application of transistors in audio-frequency amplifiers shows how the published transistor characteristics are related to the principles of design. To assure clarity, the figures are rendered in several colors and placed opposite the related text. Simple equations reinforce the lucid approach. An ideal textbook or reference on the subject for engineers and advanced technicians. 384 pages; 5½ x 8; illus.; clothbound.
\$7.95 (\$9.55 in Canada)
Circle 12 on Coupon Below

ACOUSTICAL TESTS AND MEASUREMENTS

by *Don Davis*. Provides a solid understanding of the entire subject of acoustical measurements; based on actual field test work, using commercial equipment. Contains practical, time-saving solutions to actual problems encountered in the field; minimum math is required for understanding. The author is an expert in this field, and an authority on auditorium acoustics. An invaluable book for phone company special service engineers, plant maintenance engineers, communications engineers, noise control specialists, architectural engineers, broadcast engineers and technicians, hi-fi fans and students. 192 pages; 5½ x 8½; hardbound.
\$6.95 (\$8.35 in Canada)
Circle 7 on Coupon Below

Classified

Closing date is the fifteenth of the second month preceding the date of issue. Send copy to:

Classified Ad Dept.

db

THE SOUND ENGINEERING MAGAZINE
980 Old Country Road
Plainview, New York 11803

Rates are 50c a word for commercial advertisements. Non-commercial and employment offered or wanted placements are accepted at 25c per word.

EMPLOYMENT

PROFESSIONAL RECORDING PERSONNEL SPECIALISTS. A selective service for employers and job seekers: engineers, tape editors, production and studio mgrs, traffic assts, etc. Call us today! **Smith's Personnel Service, 1457 Broadway, N.Y.C. 10036. Alayne Spertell 212 WI 7-3806.**

AUDIO SPECIALIST MFERS: REPRESENTATIVE seeks new lines for Arizona territory. California representatives wanting Arizona affiliate sales office invited. **Box 9B, db Magazine, 980 Old Country Road, Plainview, N. Y. 11803**

FOR SALE

DIAL PLATES FOR AUDIO equipment. All types. **Catalogue. Radio Dials, 1397 Washington Circle, Forestville, Ohio 45230**

MARANTZ PREAMP MODEL 7C, ACOUSTECH 1A power amplifier. Perfect condition. \$280.00. Write **Box 9A, db Magazine, 980 Old Country Road, Plainview, N. Y. 11803.**

SOLID-STATE AUDIO PLUG-IN OCTAL (1" Dia x 2" H) modules. Mic preamps, disc & tape preamp-equalizers, tape bias osc. & record ampl., power amps & power supplies. Send for free catalog and audio applications. **Opamp Labs., 172 So. Alta Vista Blvd., Los Angeles, California 90036.**

AUDIO AND VIDEO JACK PANELS and patch cords. 500-500 ohm repeat coils. New and used. Send for list. **Gulf Electro Sales, 6325 Beverly Hill, Houston, Texas 77027**

RECORDING STUDIO CLOSEOUT — Gotham Grampian cutter system with new cutter head \$950. Grampian McIntosh cutter system \$590. Many other bargains in new and used professional equipment. Write for list. **Universal Audio Sales, 2451 Nicollet, Minneapolis, Minn. 55404.**

THIRD CLASS LICENSE instruction booklet, reviews all phases necessary for license, also contains sample test. \$1.00 each. Order from **Baker Publishing, 443 So. 13th Street, Lincoln, Nebraska 68508.**

EDUCATION

FCC LICENSE TRAINING by correspondence. G.I. Bill approved. Free brochure. Write: **Dept. E-4, Pathfinder School of Electronics, 1505 N. Western Avenue, Hollywood, California 90027.**

SERVICES

WHATEVER YOUR EQUIPMENT NEEDS — new or used — check us first. Trade your used equipment for new. Write for our complete listings. **Broadcast Equipment & Supply Co., Box 3141, Bristol, Tenn. 37620.**

CUSTOM STYLUS — cartridge re-tipping, re-building, replacements. **International Audio Stylus Corp., 111-D Lake Ave., Tuckahoe, New York, 10707 (Telephone: (914) SP9-1297.**

People, Places, Happenings



● **John C. Koss**, center, president of **Koss Electronics, Inc.** describes the features of Koss stereophones to two newly elected directors of the company. On the left, is **Sheldon Lubar**, who is also chairman of **Mortgage Associates, Inc.**, and on the right is **Gerald Parshalle**, who is also chairman of the **John Oster Manufacturing Company**. Both of these firms, as well as Koss Electronics, are located in Milwaukee, Wisconsin.



Hertenstein

● **Rolf Hertenstein** has joined the communications systems division of the **DuKane Corporation** as district manager. He will supervise the marketing activities in a territory consisting of lower Michigan, northeastern Indiana, and northwestern Ohio. Mr. Hertenstein was formerly the marketing director for **UREI** and before that was a district manager for DuKane on the west coast.

● Canadians note that the 19th annual **Convention of the Central Canada Broadcasters' Association — Engineering** will be held at the Skyline Hotel in Ottawa, Canada on the 26th, 27th, and 28th of October. As in past years, it will include a two-day technical seminar on broadcast technical subjects, and engineering luncheon, and two floors of broadcast equipment displays. For further information write to **George Roach, Past Chairman—CCBA Engineering c/o Radio Station CFRA Limited, 150 Isabella Street, Ottawa 1. Ontario, Canada.**

● Two appointments have been announced by **Philips Broadcast Equipment Corp.** **Robert N. Blair** is the new product manager of broadcast television systems and will be responsible for all phases of product management in the television broadcast line. Prior to joining Philips Broadcast in November 1968, Mr. Blair was with the **General Electric Company** as a systems engineer for broadcast television.

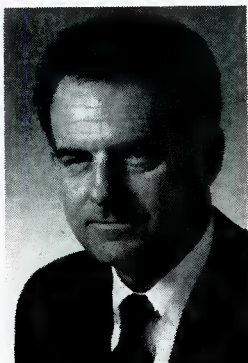

Scholten

● **Thomas E. Scholten** has been named marketing manager for the **Ampex** professional audio products division according to an announcement by **A. A. Sroka**, division v-p and general manager. Mr. Scholten will be responsible for the marketing of all Ampex professional audio recorders and accessories used in broadcasting, industry, education, and government. He joins Ampex from **Caelus Memories** of San Jose, California, prior to which he had held marketing positions with Ampex.



Schoor

● **Dubbings Electronics, Inc.** has appointed **Phillip M. Shoor** as operations manager. His responsibility includes the production operations of all of Dubbings facilities. This will include engineering, purchasing, manufacturing, and support functions including production planning and quality control. It is expected that a number of in-plant systems will be incorporated by him that will permit a steady rise in manufacturing capability while retaining and advancing quality standards. Dubbings is a **North American Philips Corp.** affiliate.



Rogers

R. Clifford Rogers is the new product manager of audio systems, a division of the audio-video systems group of the corporation. His product responsibilities include broadcast audio, and professional and commercial audio systems. Before joining Philips Broadcast, he was audio products analyst in the commercial electronic systems division of **RCA** in Camden.

Both men will be headquartered at the company's main plant in Montvale, New Jersey.

Fairchild (Cover IV) Circle 12 on Reader Service Card

REVOX GUARANTEES THESE 4 PARTS FOR ONE YEAR.

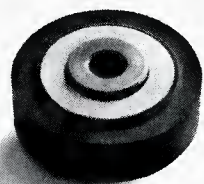

PRESSURE
ROLLER

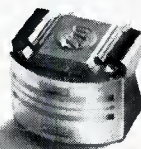

RECORD
HEAD



PLAYBACK
HEAD



CAPSTAN

THE REMAINING 842 PARTS ARE GUARANTEED FOR LIFE.

Until now, equipment guarantees were problematic. Some companies guaranteed their products for 90 days, some for a year or two. And one rather exceptional company went so far as to offer a five year guarantee on its speakers.

Now, the Revox Corporation becomes the first

to offer a lifetime guarantee, on what is regarded by many as the most complex link in the high fidelity chain, the tape recorder.

There are 846 basic parts, exclusive of wiring and connectors in the Revox A77 tape recorder and every one of them, with the exception of the four pictured above is

guaranteed for life.

This unprecedented offer becomes effective immediately and has been made retroactive to include the very first model A77 distributed by the Revox Corporation in the U.S.A.

Wouldn't it be nice if everyone could make the same offer?

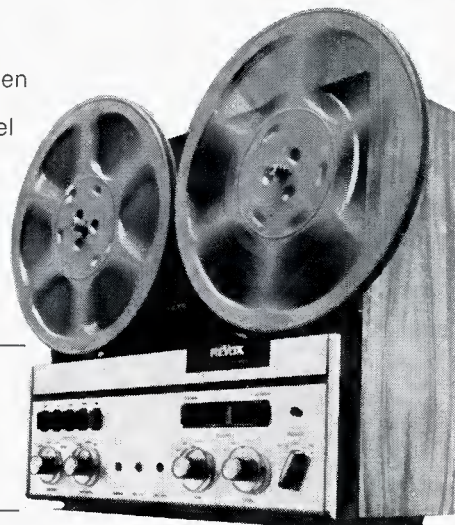

Revox Corporation guarantees to the original purchaser of a Revox A77 tape recorder purchased from it in the U.S.A., except as to fuses and bulbs: 1) to replace without charge any part failing within twelve months after purchase; and 2) to provide a free replacement in exchange for any part thereafter failing except the record and playback heads, capstan and pressure roller. This guarantee shall be void if the purchase has not been registered

with the Revox Corporation within the time specified in the card supplied the purchaser with the recorder, or if the recorder has been modified or altered by anyone other than the Revox Corporation or its authorized representatives, or if the recorder has been damaged by misuse or accident. Transportation charges are not included in this guarantee. There are no warranties or guarantees except those expressed herein.

REVOX delivers what all the rest only promise.

Revox Corporation, 212 Mineola Avenue, New York, N.Y. 11577 In Canada: Tri-Tel Associates, Ltd., Toronto, Canada

Circle 11 on Reader Service Card

CHIEF ENGINEER
 WDMS-FM
 LYNCHBURG VA 24505

FAIRCHILD

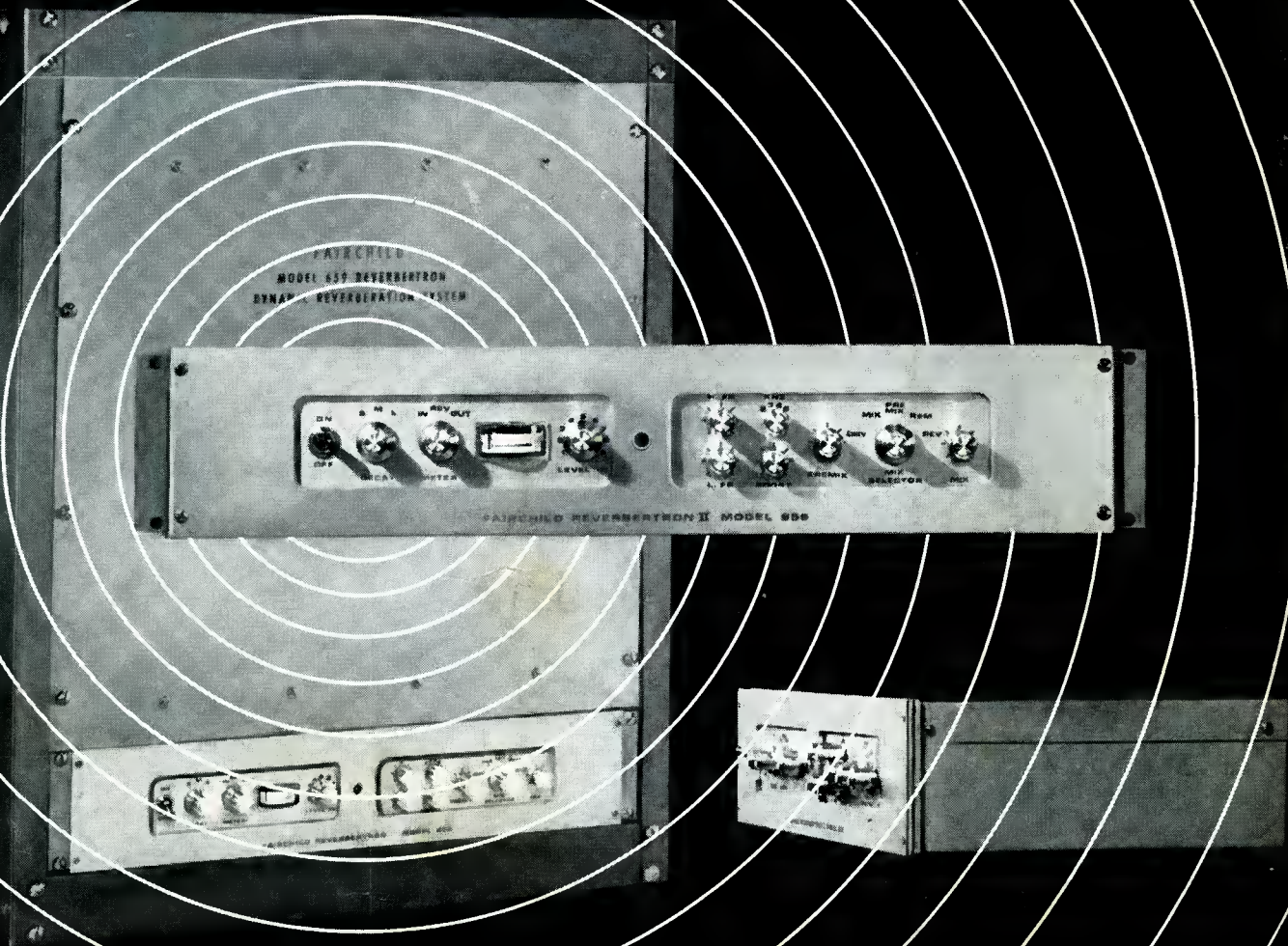

NEW FAIRCHILD REVERBERTRON

Fairchild introduces the Reverbertron 659. There are many reasons why this new artificial reverberator may be considered outstanding: **1.** The sound has the same natural, real-life quality as the world's finest acoustic chambers. The sound capability, with full range equalization, supersedes all other artificial reverberators within its price range. **2.** A switch selects local or remote operation for 3 degrees of reverberation control: (dry, premix 1, premix 2). The 659 also has an exclusive* selector for short, medium or long decay times. **3.** Frequency response range from 20 hz to 20 Khz on the dry channel (± 1 db) compares with 50 hz to 6 Khz on the reverberation channel with a range of adjustment to ± 15

db. S/N is 10 db improved over previous models.

4. Operation of the Reverbertron 659 is effective for input levels as low as -30 dbm; output levels up to $+18$ dbm. Transformer isolated input and output impedance is 600 ohms or 150 ohms balanced or unbalanced. **5.** All electronics are on easy plug-in P.C. boards; all signals are metered; controls have continuous mix facilities. **6.** The Reverbertron 659 is compact; the total space requirements are only $22\frac{3}{4}$ " high x 19" wide x 10" deep. **7.** The price is low. It is a good value because Fairchild is both a custom designer and a component manufacturer.

A number of other advanced features make the new Fairchild Reverbertron 659 highly suitable for broadcast or recording purposes. Contact your Fairchild Distributor or write Fairchild for more data. **FAIRCHILD RECORDING EQUIPMENT CORPORATION**, Dept. DB-10 10-40 45th Avenue, Long Island City, N.Y. 11101.

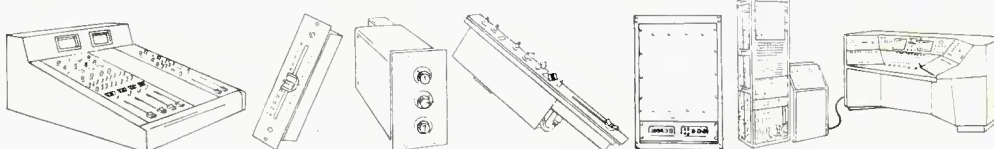

*U.S. Patent #3436674