

Broadcast Audio

db

THE SOUND ENGINEERING MAGAZINE

AUGUST 1971 \$1.00

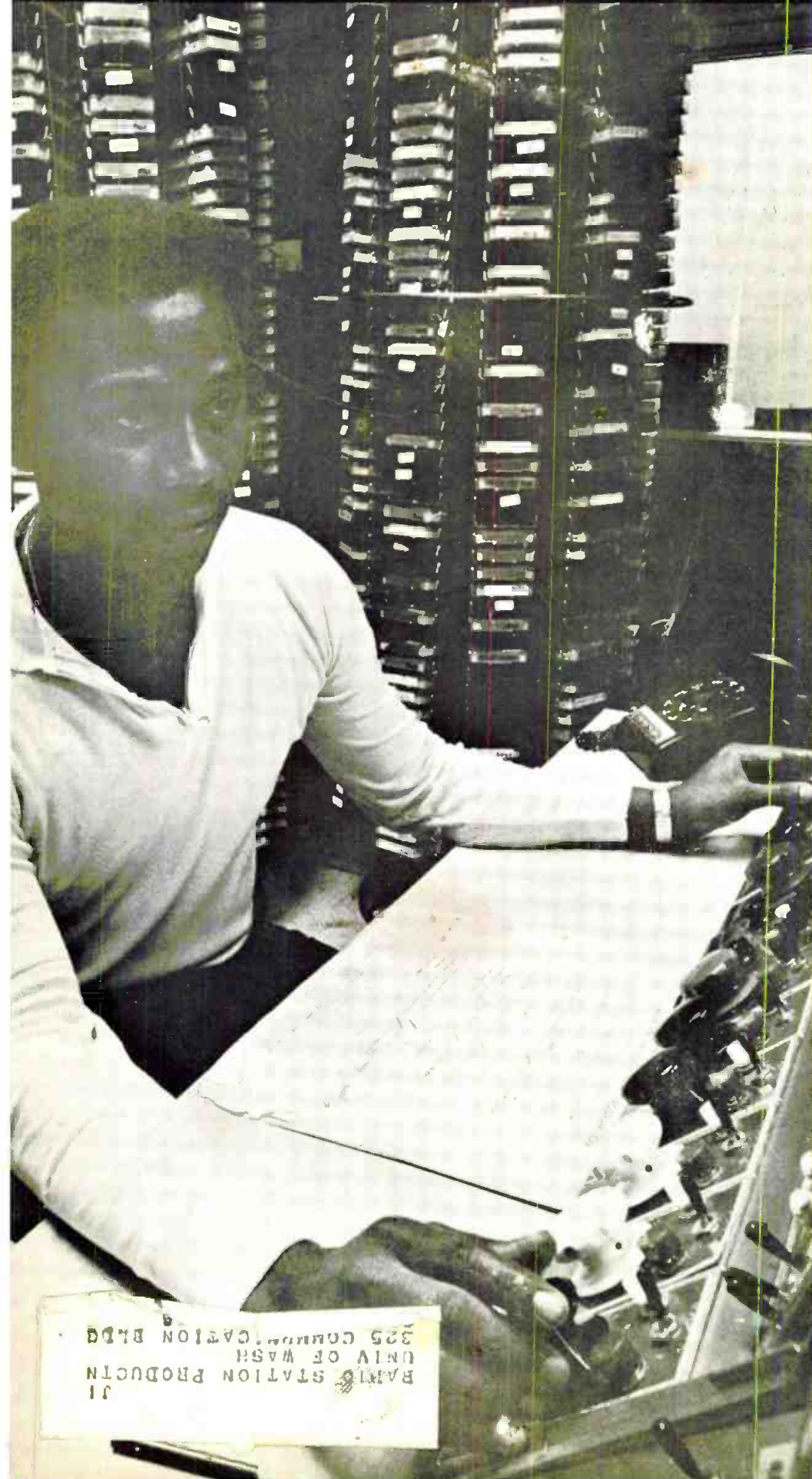

31
BAYLOR STATION PRODUCTION
UNIV OF WASH
325 COMMUNICATION BLDG

THE NEW SCULLY 100 MOVES 2" TAPE BETTER THAN ANY OTHER RECORDER ON THE MARKET...

Regardless of Price

That's a big statement. But the facts are in. After months of rugged use, studios rate the 100 transport ahead of all others... a spill proof transport that silently moves 2" tape with unmatched precision.

It's all there. The first truly modular recording system that allows you to buy all the accessories you need... or none at all. Add them later when (or if) you need them. And the basic price is only \$13,750.

No more sync problems or switching noise either. Scully's new combined record/playback head lets you punch in and out, go from play to record, sync. Never worry about performance loss or transient noise.

And the 100 is from Scully... the name that's been the industry standard for years.

Service? To augment the nation-wide distributor organization, company-operated Service Centers are being opened coast to coast. Our first four (with more to come) are strategically located in the major music areas. For a demo... or merely some specs... call Dave Nicholls, Nashville (615 327-1747); Mike Faulkner or Doug Oliver, L.A. (213 387-8354); Ham Brosious or Bob Berliner, N.Y. (212 688-0030); Gareth Nelson, Chicago (312 583-7878); or write Scully, 480 Bunnell St., Bridgeport, Conn. 06607 (203 335-5146)

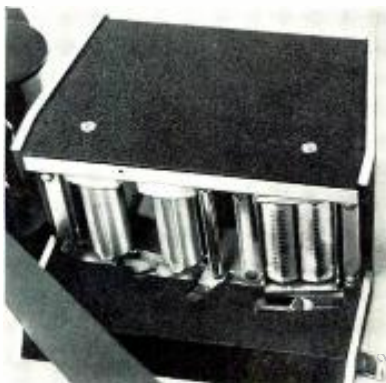

two heads are better than three



we stand behind our product

Circle 10 on Reader Service Card

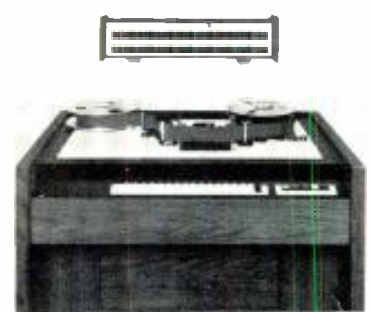

the 100... for today's sound

Dictaphone
Scully Division

COMING NEXT MONTH

● Marshall King's series on v.t.r. synchronizing to audio machines continues as he explores the various sync methods that don't necessarily rely on the frequency control generated by the v.t.r. (as explained in this issue).

Directional Response of Some Common Acoustic Multi-Transducers is the topic of Michial Rettinger's article. Just what happens when you use a multi-speaker arrangement to propagate sound? With ample illustration and some mathematics, this work explores this subject in depth.

G. R. Thurmond looks at the topic of bass response in loudspeakers, enclosures, and rooms. He explores, among other subjects, the contention that flat components, properly used, will result in flat response.

And there will be our regular columnists: George Alexandrovich, Norman H. Crowhurst, Martin Dickstein, Arnold Schwartz, and John Woram. Coming in *db*, The Sound Engineering Magazine.

ABOUT THE COVER

● Broadcasting is the theme of this issue. The photo on the cover was taken by Bill Wiltchko at WOR-FM in New York City and shows engineer Cliff Lovett at work.

db

THE SOUND ENGINEERING MAGAZINE

AUGUST 1971 VOLUME 5, NUMBER 8

19	THE SYNC PULSE IN T.V. AUDIO Marshall King
23	FOUR CHANNEL STEREO BROADCASTING Larry Zide
26	PROBLEMS OF MONO-STEREO BROADCASTING COMPATIBILITY Eric Small
2	THE AUDIO ENGINEER'S HANBOOK George Alexandrovich
6	THE SYNC TRACK John Woram
8	SOUND WITH IMAGES Martin Dickstein
12	THEORY AND PRACTICE Norman H. Crowhurst
14	THE FEEDBACK LOOP Arnold Schwartz
15	NEW PRODUCTS AND SERVICES
30	BOOKCASE
31	CLASSIFIED
32	PEOPLE, PLACES, HAPPENINGS

db is listed in Current Contents: Engineering and Technology,

Robert Bach PUBLISHER	Larry Zide EDITOR
Bob Laurie ART DIRECTOR	John Woram ASSOCIATE EDITOR
A. F. Gordon CIRCULATION MANAGER	Marilyn Gold COPY EDITOR
Eloise Beach ASST. CIRCULATION MGR.	Richard L. Lerner ASSISTANT EDITOR

db, the Sound Engineering Magazine is published monthly by Sagamore Publishing Company, Inc. Entire contents copyright © 1971 by Sagamore Publishing Co., Inc., 980 Old Country Road, Plainview, L.I., N.Y. 11803. Telephone (516) 433 6530. *db* is published for those individuals and firms in professional audio-recording, broadcast, audio-visual, sound reinforcement, consultants, video recording, film sound, etc. Application should be made on the subscription form in the rear of each issue. Subscriptions are \$6.00 per year (\$7.00 per year outside U. S. Possessions, Canada, and Mexico) in U. S. funds. Single copies are \$1.00 each. Controlled Circulation postage paid at Harrisburg, Pa. 17105. Editorial, Publishing, and Sales Offices: 980 Old Country Road, Plainview, New York 11803. Postmaster: Form 3579 should be sent to above address.

THE AUDIO ENGINEER'S HANDBOOK

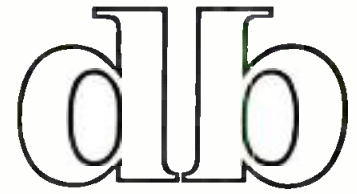

THE SOUND ENGINEERING MAGAZINE

Integrated Circuit Line Amplifiers

● Anyone who has experimented with i.c.s probably discovered the fact that if you look for that extra low noise chip it will not work into line impedance circuits or will have sizeable amount of distortion, and those i.c.s which will drive line impedance will often lack quality performance in other parameters. There are indeed few i.c.s which meet all the performance criteria accepted by the professional audio field. Lately, i.c. packages have appeared for entertainment field use with a capability of delivering up to 10-15 watts, but microminiature circuit construction when subjected to severe temperature variations obviously can deliver only mediocre performance. The same circuits built with discrete components will likely perform well.

I have recently received requests to elaborate on use of i.c.s with output transformers, in line amplification, and generally as current amplifiers. My approach to this problem is based on these factors: *performance, cost, simplicity*. I select an i.c. which does everything I want it to do, except for the capability of driving heavy loads. Then by adding two external transistors and a few resistors power handling capability of the circuit is boosted. Simplicity of the complete

amplifier is retained, and cost is kept low.

If you consider using this i.c. throughout a system (which is a sensible way of doing things) you might get by using it without the current booster transistor pair if load impedances are kept in the range of few thousand ohms. This refers to fader impedances, mixing buses, pads, cue, echo, and monitor circuits.

A driving transformer with a single i.c. should be separately looked into. First of all, a transformer is a limiting factor in performance at low and high frequencies. Aside from being able to deliver clean signal at desired levels, a transformer should present optimum load impedance to the amplifier output for maximum power transfer. Most likely you will deal with i.c. opamps where source impedance of the output is almost 0 ohms. However, the best power transfer may be optimal with the load of a couple of hundred ohms.

If you would like to measure this yourself do this: apply several values of resistive loads to the opamp output, and for each load measure and log the maximum output voltage just before wave form clipping occurs. Then for each indication, figure power delivered to the load. Highest power readings will pinpoint the best power transfer point and load impedance. While an average i.c. opamp may deliver 100-150 mW of maximum power, circuits with current booster stages may be several watts.

For those interested in obtaining a larger voltage swing at the output by using a output transformer for voltage step up, I would first strongly recommend using hybrid current boosting circuits, and secondly not use high

Figure 1. An integrated circuit as a line amp without a current booster.

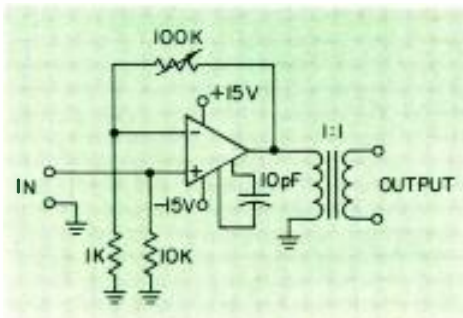

advertisers index

AKG	4
Allison Research	9
B & O	11
Beyer	13
Burwen	8
Dolby Labs	3
Duncan Electronics	29
Fairchild Sound	10
Gately	17
Infonics	6
MCA Technology	Cover IV
Miller-Stephenson	9
Olive	7
Pacific Recorders	10
ReVox	Cover III
Scully	Cover II
Timekeeper	5
UREI	12

SALES OFFICES

New York

Specifax Media Sales, Inc.
Manfred W. Meisels
603 East 82nd Street
New York, N. Y. 10028
212-249-7768

Boston

Specifax Media Sales, Inc.
William H. Fields III
49 Gray Street
Boston, Mass. 02116
617-426-5315

Denver

Roy McDonald Associates, Inc.
846 Lincoln Street
Denver, Colorado 80203
303-825-3325

Houston

Roy McDonald Associates, Inc.
3130 Southwest Freeway
Houston, Texas 77006
713-529-6711

Dallas

Roy McDonald Associates, Inc.
Semmons Tower West
Suite 714
Dallas, Texas 75207
214-637-2444

San Francisco

Roy McDonald Associates, Inc.
625 Market Street
San Francisco, California 94105
415-397-5377

Los Angeles

Roy McDonald Associates, Inc.
1313 West 8th Street
Los Angeles, California 90018
213-483-1304

Portland

Roy McDonald Associates, Inc.
2305 S. W. 58th Avenue
Portland, Oregon 97221
503-292-8521

Pennsylvania

Specifax Media Sales, Inc.
Andrew N. McCreight
Box 199
Chester Springs, Pa. 19425
215-363-7355

The Dolby System: A Progress Report

Soon, more than thirty manufacturers will offer advanced new products incorporating the Dolby System.

The Dolby A-System is the professional noise reduction system. Every major recording company now uses it, and its use is rapidly increasing in motion picture studios, broadcasting stations, and communication networks throughout the world. The A-System has achieved virtually universal acceptance among professionals because it is precise and consistent in operation, simple to use, and has no effect upon the music or other signals being recorded or transmitted.

The Dolby B-System is the compatible high-fidelity noise reduction system for consumer applications. It uses the same basic principles as the A-System, but is much simpler and lower in cost than its professional counterpart. Dolby Laboratories makes only professional products, but licenses the B-System to manufacturers of home tape recorders, receivers and Dolby adapters. More than 30 companies soon will be making products incorporating the B-System, and others are joining the list each week.

ADVENT	KENWOOD (TRIO)
A.G.S.	LAFAYETTE
ALLIED RADIO SHACK	LENCO
AMPEX	MITSUBISHI
BELL & HOWELL	NAKAMICHI
BENJAMIN	PLANET
BIGSTON	RANK WHARFEDALE
CONCORD	REVOX
CROWN RADIO	SANSUI
FERROGRAPH	SILVER
FISHER	SINGER/K.L.H.
HARMAN-KARDON	TEAC
HIGHGATE (ALPHA)	TELETON
HITACHI	TELEX/VIKING
JANSZEN	3M/WOLLENSAK
KELLAR	

The Dolby B-System has been acclaimed by music and technical writers with a unanimity which is rare. The judgment of the reviewer of the New York Times is typical: "Dolby cassettes can produce almost disk-quality sound even when played on a first-quality machine that predates the Dolby technique. If you have one of the new players with built-in Dolby, the results can be quite spectacular."

Hundreds of different commercially recorded Dolby cassettes will be available by the end of the year. Many are already being released regularly by Columbia, Ampex, London/Decca, Vox, Musical Heritage Society, RCA (U.K.), and Pye/Precision (U.K.) Twenty other companies have obtained the professional B-type encoders needed for duplicating such cassettes. There is no royalty payment to Dolby for these recordings. Listeners and dealers everywhere agree that Dolby cassettes are perfectly playable on any cassette recorder, and usually sound better even on non-Dolby equipment.

The Dolby B-System and new tape formulations (such as chromium dioxide) work very well together. Although their noise reduction effect is much less than that of the Dolby System, some of the new tapes provide a useful extension of high-frequency response. Used with the Dolby System, they provide striking evidence of the cassette's real capability. Although chromium dioxide tape is not compatible with the vast majority of cassette recorders in the field and on dealers' shelves, more and more manufacturers are providing new machines with the necessary circuitry, along with the Dolby System.

The Dolby B-System has been used in FM broadcasting with excellent results. FCC rules permit broadcasting of Dolby-encoded signals in the U.S.; experiments of this kind are taking place in other countries as well. The reduction in noise given by the system can more than double the area in which high-fidelity listening is possible, with no increase needed in transmitter power. Later this year Fisher and Harman-Kardon will be the first to offer receivers with the Dolby System built in.

Integrated-circuit versions of the Dolby B-System will be available next year. An IC is being developed jointly by Signetics and Dolby Laboratories; the technology will be made available to IC manufacturers everywhere, to insure industry standardization and lowest cost to consumers, as well as reliable supply to manufacturers. Ultimately, the increased retail cost incurred by adding the Dolby System to a tape recorder should be \$10 to \$20.

The cost of licensing the Dolby System has been reduced considerably because of rapid industry acceptance of the system. Manufacturers now pay on a simple per-unit basis, with royalties as low as ten cents per channel. The licensing agreement also entitles a manufacturer to sustained technical support from Dolby Laboratories in noise reduction applications. Dolby employs a staff of more than 100 at its London facility, and maintains offices in New York and Tokyo, all devoted exclusively to noise reduction system development, manufacture, sale and licensing. To date, 80 patent applications have been filed in 17 countries to cover the Dolby System; 19 patents have already been issued in 10 countries, including the United States.



Dolby Laboratories Inc.

333 Avenue of the Americas
New York NY10014

346 Clapham Road
London SW9

Tiger Building
30-7 4-chome Kuramae
Taito-ku Tokyo

Circle 19 on Reader Service Card

AKG

Where superior microphones originate.

We research and design . . . and build microphones exclusively.

Surely you will want to keep abreast of the technical developments which make AKG the leaders in microphone developments. Research and modern technology in both microphones and headphones have resulted in recent breakthroughs. Current data on products will be sent you regularly without obligation.

Register via the coupon below and receive our latest 50 pages treatise on the concept and technology of the modern cardioid dynamic microphone . . . complete with technical data. Do it today!



Yes, add my name to AKG's Professional Engineers' Mailing List. Also send me a complimentary copy of—AKG's history of the cardioid dynamic microphone.

NAME _____

TITLE _____

FIRM _____

ADDRESS _____

CITY _____

STATE _____ ZIP _____



MICROPHONES • HEADPHONES

A DIVISION OF
NORTH AMERICAN PHILIPS CORPORATION
100 EAST 42ND STREET, NEW YORK, NEW YORK 10017

AKG CANADA • DIVISION OF DOUBLE DIAMOND ELECTRONICS • SCARBOROUGH, ONTARIO

4 db August 1971

Circle 14 on Reader Service Card

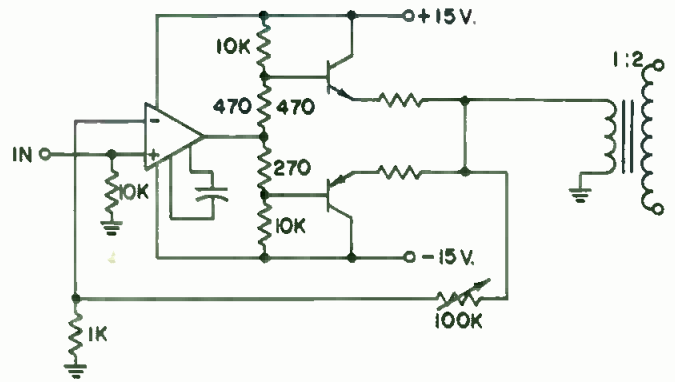

Figure 2. A current booster circuit for the i.c. driver.

step-up ratios. Very few transformers can maintain their impedances constant with high transfer ratios. If you really need high voltage swing, there are other methods to obtain it.

Unfortunately, all present i.c.s cannot take more than 20-22 volts (or a total for a bipolar supply of 40-44 volts) to deliver 10 volts r.m.s. across the load. Just to get 6 dB more output (twice the voltage), we would need supply voltages of 80-88 volts. There are no i.c.s which can stand such voltages. We have to get by with what we have. A fairly simple circuit with the same supply voltage will produce 6 dB more voltage. It requires two i.c.s connected in push-pull. Input requires a lighter transformer to provide out-of-phase feed to two inputs of a single stage transistor phase inverter, or using inverting input on one of the opamps.

Outputs of i.c.s are at ground potential in a quiescent state, and should be treated as a balanced output. Transformer can be added externally to provide d.c. isolation. As the signal is applied to the inputs, one i.c. produces a positive voltage swing, while the other produces negative. Gains of both amplifiers should be equal for true balanced condition. However, even if one amplifier fails 6 dB lower output is still available.

In order to derive power from such a circuit, two separate current booster stages (complimentary symmetry) should be added to each i.c. output. The feedback loop should derive its signal from the output of the booster stage, and connect to the inverting input of the opamp i.c. When only moderate amounts of gain are needed and feedback is large, source impedance of the output circuit is almost zero. As a matter of fact it can be made zero or even negative depending on the circuit board layout.

Negative impedance manifests itself when heavy load is applied to the output, and the voltage across the output instead of sagging, goes up! Zero impedance would be present when output is loaded with loads in the range of a couple of ohms or lower—with no change in the output voltage. One very important condition for

these tests—that is when low impedance loads are applied—signal should be adjusted so that wave form is not clipped or distorted. Once any of the output stages or driving stages saturate, output impedance skyrockets.

Usefulness of these circuits is manifold. Quality of the derived output signal cannot be surpassed. Extremely low distortion, low noise, flat frequency response, and good power-handling capability add up to a description of an amplifier almost ideal for any form of audio work. Low idling currents, high efficiency, high input impedances, and low output impedances, large voltage swing at the output, and simplicity and low cost, are additional bonuses. These circuits are ideal for uses such as line amplifiers, distribution amps, low power cue amps, or headphone drivers. ■

Figure 3. Two methods of doubling output voltage swing. (A) using a transformer, and (B) without transformer.

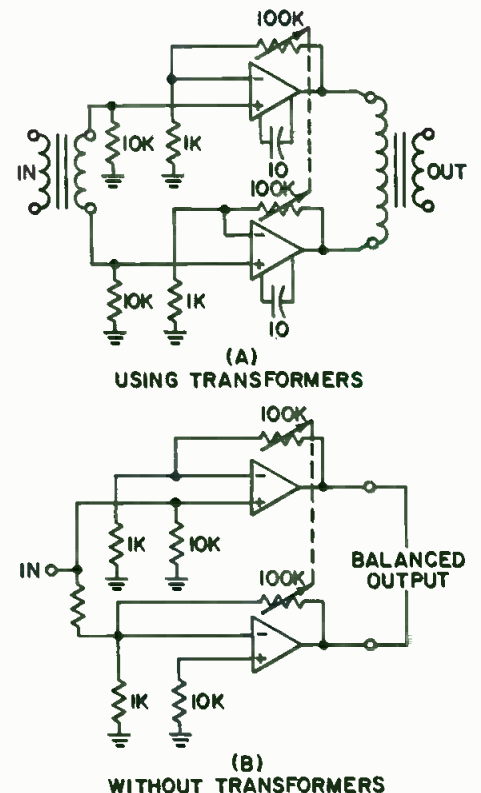

Circle 14 on Reader Service Card

Use this coupon to order your
Miida MC/800 Personal Electronic

Calculator

...the engineers' electronic slide rule

TIMEKEEPER

P.O. Box 835, Great Neck, N.Y. 11021
Please send check or money order.
N.Y. residents add 6% sales tax.

Name _____

Address _____

City _____ State _____ Zip _____

Beautifully styled, the MC/800 is ideal for office, shop, school, laboratory or home use. It adds, subtracts, multiplies and divides at a calculating speed of 0.3m sec. Compact and silent in operation, the MC/800 is a reliable, high-quality instrument that sells for considerably less than calculators of inferior quality. We have checked this product carefully and can recommend it without hesitation.

8-digit entries and answers for all operations / floating decimal point / chain and mixed calculations / overflow indicator / 110 VAC, 50-60 HZ (conversion to 220 V can be made) / 2½" h x 6¾" w x 9" d / weight 3.3 lbs / One year warranty—factory service available in New York and Los Angeles.

only
\$199.50
(includes shipping)



Circle 17 on Reader Service Card

profit from cassette & cartridge duplication



Produce 1,400 to 30,000 C-30 cassettes per 3-shift workday on the new Infonics Super Cassette Duplicator. It offers professional-quality 12,000 Hz frequency response...only **\$3895**
Produce 3 eight-track 150-foot cartridge tapes per minute at 30 ips on the professional Infonics D-8 Duplicator. The single-pass D-8 gives 12,000 Hz response and puts you in the high-profit 8-track business for only **\$6995**
Send for free color brochure today.



infonics

1724 Cloverfield Boulevard
Santa Monica, California 90404
(213) 828-6471 • Cable: Infonics

John M. Woram

THE SYNC TRACK

● Now that I am more or less settled into my new job at Vanguard Records, I must apologize for the omission of the June SYNC-TRACK, which managed to fall by the wayside while I was making the change. I've also managed to fall behind in answering letters. I still have a large collection on my desk, which I shall attempt to wade through as quickly as possible.

Some are difficult, if not impossible, to answer briefly. For example, "How do I become a recording engineer?" or, "What do I have to know about music, electronics, consoles, microphones, and tape recorders to get a studio job?"

In the summer 1970 issue of *Stereo Magazine*, Columbia Records producer Tom Frost wrote an article entitled, *So You Want To Become a Recording Engineer?*, which remains the definitive answer to this complex question. Perhaps you begin in a small studio, if you can talk your way in, emptying waste baskets and tidying up after the session. Within a little time, the engineers will let you at the console, but only long enough to scrape off the pizza. If you're good at it, they may let you go out for coffee and more pizza. If you come back, you might get the chance to bring up some tapes from the vault (if they have one). Eventually, one of the regular engineers will call in sick. (This doesn't happen very often, since you have to be a little sick in the first place to be a good engineer). Someone will turn to you and say, "you want to be an engineer? Now!" And you're on. If you survive, you're on your way.

Or, you might try getting a job with one of the very large recording companies. Many of them will start you at the bottom, unloading tapes from trucks, and keeping the supply room well stocked. Eventually, there will be an opening for an engineer, and someone about six rungs above you will get it. Then someone gets his old job, and eventually there's an opening just above you, which you may get. By the time you get to be a recording engineer, you will have a very good background in just about every phase of the recording business, *however*, it will probably take a lot longer than getting your foot in the door of a small studio.

Any education you have will certainly do you no harm, providing you don't start waving your diplomas in front of everyone. Some engineers

have a solid musical and/or electronic background. Some have none of either, and yet are as competent when it comes to recording or mixing an involved session. Successful studio engineering is a mixture of diplomacy, communication, imagination, and black coffee. If you can fix the console or write your own symphony, that's wonderful, but only as a complement to the other intangibles.

Which probably doesn't give the letter writers the information they'd hoped for. Since the question of how and where to begin is so frequently asked, I'll try to come up with something a little more substantial in the future. In the meantime, read Mr. Frost's article.

Also sitting on my desk, along with the unanswered mail, is a formidable collection of product information, most of which I collected at the last Audio Engineering Society convention in California. Several items are worth mentioning here.

The DBX Extended Range dBm Meter is a —70 to +10 dBm single scale rms meter. Especially for the smaller studio that does not have a completely equipped test rack, this little meter will allow the engineer to make routine noise measurements without bringing in a lot of involved test gear. It might also be handy for finding out how much separation you really have between adjacent tracks on your multi-track machine. Or, for a quick azimuth check.

Speaking of azimuth check, what sort of audio oscillator do you have? Some of the new consoles contain a built-in oscillator which is very handy for level adjustments and continuity checks. However, often only a few output frequencies are provided making azimuth checking a fancy affair. A continuously variable oscillator is really worth having around, since it allows you to be sure of your azimuth and complete frequency response.

For the more complete test bench, the Ferrograph RTS-1 recorder test set may be of interest. This all-in-one unit contains a variable frequency oscillator, a millivoltmeter and attenuator, a wow and flutter unit and a distortion measuring network. It will measure frequency response, signal-to-noise ratio, distortion, crosstalk, wow and flutter, erasure, input sensitivity and output power.

If you've ever gone to the trouble of rigging up a couple of tape machines

to produce the special effect known as *flanging* or *phasing*, you'll be glad to hear of the Countryman Type 967 phase shifter. A front panel knob provides a continuously variable phase shift. Simply rotating the knob produces that unique phasing sound. With a little modification, the controls might be brought out to a foot pedal for convenience during a mixing session.

Penny And Giles, Ltd. have an interesting series of low cost (\$29.50) linear motion faders that are ideally suited to the studio experimenter. They are available from 500 to 20,000 ohms in linear or logarithmic tapers. The faders are intended as an inexpensive complement to the P&G conductive-plastic studio series.

Ampex recently demonstrated their new CD-200 Automatic Cassette Copier. Depending on cassette type, the unit will duplicate from 24 to 75 cassettes per hour. The machine may be loaded with up to 100 blank cassettes at a time. If you're involved in educational work, or any other project that requires small scale production runs, this duplicator may fill your needs.

My comment—a few issues ago—about not knowing of many modern ribbon microphones certainly produced quite a reaction. Needless to

say, I have suddenly heard from a large number of ribbon mic manufacturers, so it looks like I shall have to do another column on the subject as soon as I can. Which brings up an interesting idea. If any readers have a favorite microphone technique, or an interesting application, why not drop me a note about it? That way, I shall learn something about microphones. In fact, I'll even reprint your comments, and in the cases where I can't steal the credit, will give that too.

The next Audio Engineering Society convention will be held in New York from October 5 thru 8, 1971, at the Hotel New Yorker. One of the highlights of this year's convention will be an all day workshop on studio tape recorders. Registrants for the workshop will receive a portfolio of reference literature, and will hear specialists discuss all aspects of tape recorders. In addition, representatives of the major manufacturers will be present to demonstrate the calibration and field testing of their machines. The workshop registration fee is \$5.00 (or \$12.00, with lunch included) and readers may apply now by sending a check to the Audio Engineering Society, Room 929, 60 East 42nd St., N.Y.C., N.Y. ■

db binders

only \$4.95 postpaid

Heavy-weight binders are now available to hold the thirteen issues of Volumes 1 and 2. Rich brown leather-grained virgin vinyl, with our name printed in black on the spine and front cover, is electronically sealed over rigid board to give your volumes of **db** lasting protection. Keep your copies preserved in perfect condition, protected from dust and damage.

Please send me _____ copies of the **db** Magazine binder. My check for \$_____ is enclosed (sorry, no c.o.d.).

Name _____

Address _____

number and street

city _____ state _____ zip _____

(New York State residents please add 6% sales tax).

Mail to: **db** the Sound Engineering Magazine, 980 Old Country Road, Plainview, N.Y. 11803.

What's In a name?

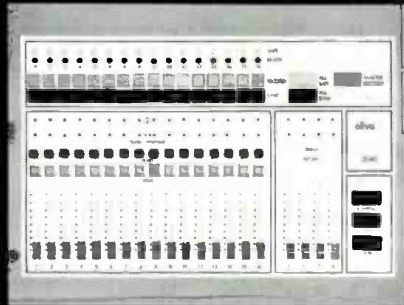

An engineer can sense sophistication just from a picture of the Olive 2040 Monitor Mix and Sync module. But there's more than appearance in a module that can fully remote control a multitrack tape machine and reduce conventional monitor patching and switching time by as much as 50%. In the 2040 you'll recognize a new state-of-the-art when you see it decide on the monitor status from system conditions, then establish the correct audio routing—automatically.

Just out of sight, the application of computer memory and logic circuitry is how both console and multitrack tape recorder are combined into one single integrated system. Engineers appreciate the constant visual feedback provided on all the functionally located ready/safe, sync and record controls. All monitor feeds are re-evaluated the instant of punch-in. Fast, convenient and flexible, especially with silent single button punch-in and punch-out and single button transfer from record to playback to overdub. Even simulated record punch-in without actually erasing the tape. Equivalent to a mix-down, all the feeds you should hear are presented in synchronism. The mixer output assignment can be to a 4 speaker monitor system with quad/stereo position switches. Echo provision on the monitor system facilitates wet monitoring of dry tapes. It even

has solo/preview buttons. The name Olive only has true meaning once you've experienced the product. Specifications on the unique Series 2000 Console we're building here are available now. Write to us for full details today.

olive 

WHENEVER THERE IS A NEED

2670 Paulus, Montréal 386, Canada

(514) 332-0331

Cable Olive!, Montréal

HEAR
BURWEN LABORATORIES
STOP NOISE
POLLUTION
IN PROGRAM MATERIAL

2000 NOISE ELIMINATOR



110 DB Dynamic Range
For Tape Mastering

1000 DYNAMIC NOISE FILTER

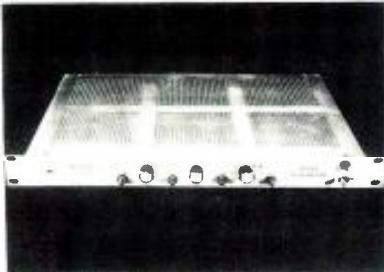

For Existing Records, Tapes or
FM. 10 DB Noise Reduction in
Multitrack Mix.

1030 AMPLIFIER - NOISE FILTER
6 CHANNEL LABORATORY or
STUDIO AMPLIFIER & HUM FILTER

MODULES

AT200 ACTIVE TRANSFORMER
GC101 WIDEBAND GAIN
CONTROLLER

DEMONSTRATIONS AT THE
AUDIO ENGINEERING SOCIETY
CONVENTION, OCTOBER 5-8, 1971
HOTEL NEW YORKER, N.Y.C.

**BURWEN
LABORATORIES™**

12 Holmes Road
Lexington, Mass. 02173

(617) 861-0242

Circle 26 on Reader Service Card

Martin Dickstein

SOUND WITH IMAGES

The ASTD Conference and Exposition

● Another important meeting associated with the a/v field that took place recently was this year's national conference of the American Society for Training and Development at the New York Hilton.

The Society, for those not familiar with it, was founded in 1945 and its first national conference that year was attended by fifty-six people in the training and development field. By 1951, the organization had twenty-two chapters and well over a thousand members. The purpose of the organization is to provide educational programs and services, disseminate information and knowledge, and encourage research and the free exchange of ideas related to optimum utilization and development of human resources. Through its 12 institutes, workshops, and conferences every year, this non-profit society helps keep its members up-to-date on the development of techniques and equipment available for the use of training and educational directors and personnel.

Today, the ASTD has 8,500 members with seventy-four chapters in the United States and two chapters overseas. These people are professionals at designing and maintaining training programs for executives and personnel at more than 3,500 different industrial, government, educational and business organizations. At this, the 27th annual conference, about 1,500 people attended the thirty-two general and concurrent sessions, sixteen special interest groups, fourteen cracker barrel, and twenty-eight showcase sessions, and the Equipment and Services Exposition featuring ninety exhibitors in one-hundred thirty booths.

The list of meetings (in several meeting rooms) is much too long to go through completely but among the subjects discussed were *New Concepts in Adult Learning*, *Film-Based Simulation for Training and Evaluation*, *Organizational Development at Play-boy*, *Mixed Programming and Media for A Sales Training Design*, *Organizational Sexism*, *The Use of Video Tapes for Training in Small Industries*, and *The Use of ETV Stations in Training and Development Programs*.

Simultaneously, in another meeting room, various exhibitors were giving talks and demonstrations of either new or the latest equipment and theory

available in the application of a/v equipment to the personnel training field. Among these were American Tape Duplicators, Viewlex, 3M (several divisions), McGraw-Hill Book Division, Sony, Howard Johnson's Motor Lodge Division, International Correspondence School, Concord Communications, CBS, American Management Association, Gulf Publishing, Charles Besseler, Bell & Howell, Panasonic, and Xerox Learning Corp. The Besseler Corp. promised to demonstrate a new movie process which would provide 3d images without the use by viewers of glasses or any other devices. However, it seems that the unit, developed by the inventor of 3d cards, was "borrowed" by person or persons unknown and the demonstrator apologized many times and had to fill his allotted time by demonstrating and explaining the equipment available in the company's line.

Obviously, a recap of all the material shown at the exposition would be impractical, but we can review some of the displays for those who might not be completely familiar with all the devices made by the various manufacturers. Any equipment listed here has not been chosen for recommendation over any other equipment but as an indication of some of the hardware available for greater service to a/v customers. Order of discussion is alphabetically only, by projection and audio, then by c.c.t.v.

The Charles Besseler Co., manufacturer of overhead and opaque projectors, offered a model 505 which is a self-contained rear projection unit operating with a combined visual and audio cartridge. With a 35-mm film contained in one section of the cartridge and the ¼-inch audio tape in another, each portion of the presentation can be changed separately. The two sections of the cartridge snap together to form one unit. The 300 feet of tape contain an audio track and an inaudible signal to advance the 150 frames of film. The unit contains a 9 x 12 inch screen (13½ x 20 inch available optionally), 5-watt amplifier and 4 x 6 inch speaker, *stop/start and volume controls* and a *tape interrupt* to stop the audio without changing the image in case live discussion is desired.

Another device available from Bes-



Don't lose your head

Loose oxide dust can do in a tape head all too soon. It's rough on tape, too.

MS-200 Magnetic Tape Head Cleaner* is an efficient antidote for oxide dust. Even the valve on the can is designed to deliver a wet spray to flush away oxide build-up on heads and stray particles embedded in tape. Can be applied while tape is running.

Write for data and prices.



**miller-stephenson
chemical co., inc.**

ROUTE 7, DANBURY, CONNECTICUT 06810

Also Chicago and Los Angeles
Distributors: London, Paris, Hamburg and Milan

*Patented

Circle 20 on Reader Service Card

KEPEX™
MEETS
GAIN·BRAIN™

A TRUE-LIFE ADVENTURE
IN THE AUDIO GAME

By
ALLISON RESEARCH, INC.

ONE DAY IN AUGUST...

WHEW! ANOTHER DAY CLEANING UP NOISY TAPES! THEIR AIR CONDITIONER DELIVERS MORE RUMBLE THAN COOL AIR! CAN'T COMPLAIN THO, IT'S MY JOB AND I DO IT WELL!

LET'S SEE TOMORROW ITS SUPER-SONIX STUDIOS AND SOME STEREO EFFECT SYNTHESIZING AND...

OOF!

HEY YOU! YA GOT YOUR HEAD UP YOUR... SAY, YOU LOOK FAMILIAR! HAVEN'T I SEEN YOU BEFORE?

SURE MAN, I'M YOUR NEW GAIN·BRAIN! I'M A LIMITER LIKE YOU WOULDN'T BELIEVE! PEAK AND RMS THRESHOLDS!

I'M GREAT!

SAY, WITH YOU KEEPING DOWN THE NOISE AND ME BRINGING UP THE LEVELS, WE COULD MAKE SWEET MUSIC TOGETHER! WHADAYA SAY, KEY?

RIGHT ON, G.B!

BOOM-CHICKA-BOOM... (SILENCE)
RAT-A-TAT TAT... (SILENCE)
BOOM-CHICKA-BOOM... (SILENCE)
RAT-A-TAT-TATTA-TAT
TATTA-TATTA TAT
BOOM... (SILENCE)

THE IMPACT OF THIS MEETING IS JUST NOW BEING FELT BY THOSE LUCKY PEOPLE IN THE AUDIO GAME! WRITE OR CALL FOR FURTHER DETAILS TO:



ALLISON RESEARCH, INC.
7120 SUNSET BOULEVARD
HOLLYWOOD, CALIF. 90046

(213) 874-6615

Exclusive export agent:
GOTHAM AUDIO DEVELOPMENT CORP., NEW YORK, N.Y.

Circle 25 on Reader Service Card

To have the Sound
that "makes it"— You need the Equipment
that "makes it"

For the
RECORDING INDUSTRY
we have
EMT, Neumann, Dolby, Ampex
Electrodyne, Universal Audio,
Automated Processes,
Allison Research and
Countryman Associates
For the
BROADCASTING INDUSTRY
we have
Teletronix, Spotmaster, QRK, Gray
Shure, Stanton and Ortofon
For the
MOTION PICTURE INDUSTRY
we have
Stellavox, Sennheiser, Vega, Beyer
and A.K.G.



**PACIFIC RECORDERS
& ENGINEERING CORP.**

11760 Sorrento Valley Rd.
San Diego, Ca. 92121

sales & service: (714) 453-3255

Circle 21 on Reader Service Card



MODEL 659A

Another exciting edition of the world-famous FAIRCHILD Reverbertron systems is the new Model 659A FAIRCHILD COMPACT REVERBERTRON.

Identical in performance characteristics to the preceding studio model—the Model 659—the new compact Model 659A also supersedes all other artificial reverberators within its price range by providing the same natural, real-life reverberation effects as the world's finest acoustic chambers.

Including lock mechanism for portability the rack mount Fairchild Compact Reverbertron is 19" wide x 9" deep x 7" high—truly the finest compact reverberation system available today.

*U. S. Patent #34336674

For complete details contact your Fairchild Distributor or write:

FAIRCHILD
Sound Equipment Corporation
10-40 45th Ave., L.I.C., N. Y. 11101

Circle 18 on Reader Service Card



Figure 1. One of the video tape models on display was this Panasonic 1/2-inch player-only unit.

seler is an overhead projector that automatically adjusts lamp intensity to correspond with the size of the projected image. As the dimensions of the picture are adjusted and focused, the light is dimmed or brightened so that the light intensity is uniform through the entire image. The upper lens of the two-lens head operates on a bellows arrangement providing uniform illumination up to a tilt of 30 degrees. This Vu-Graph unit comes with various attachments and accessories, and also an assortment of diverse focal length lenses.

A single complete unit for synchronized sound-slide presentations with a cassette tape unit and slide projector is offered by CinemaSound. One model incorporates a slide projector with a round tray in an upright position, the other with a regular Kodak projector all in one unit. Audio is recorded along with inaudible slide-change tone cues in one process. Operation is by piano-key pushbuttons.

Another synchronized sound-image device is available from DuKane. The cassette tape triggers a 35-mm film strip which either projects onto a self-contained rear projection screen or onto a separate external screen. With an adapter, units can also project 2 x 2 slides. Other devices also available include a recorder/pulsar and duplicator for production of extra tape cassettes as required.

In the super-8 projector line, MPO Videotronic Projector Corp. provided information on their endless-loop film

magazine units which come with a built-in screen or could be used for front screen projection to an external surface. Audio comes from magnetic track on the film (optical is optional) through a 5-watt solid-state amplifier. An accessory reel-to-reel device for 50 minutes, rather than the regular 15 minute play, is also available.

Optisonics has a line of Sound-O-Matic units which play 1/4-inch tape cassettes with audio on one track and sync pulses on the other—for triggering a slide projector to work with the sound. A programmer-recorder unit is available for making the cassette for presentations. In addition, this manufacturer has a sound/filmstrip unit with two separate endless-loop cartridges which snap together for synchronized image-audio showings on either a self-contained rear screen or on a conventional front-projection screen.

In the 16-mm projector field, Viewlex showed a projector which may seem very familiar to many equipment dealers. It was originally the RCA 1600 which is now being made by Viewlex and has been renamed the Super 1600. They also make a Model 1600 auto-threader, and a cassette/filmstrip unit.

Wollensak, known for its regular line of reel-to-reel tape recorders now also has a unit for synchronizing cassette sound with a slide projector. On tape, the audio on one track can be recorded at the same time as the cue signals on the other for changing slides.



Figure 2. High interest was aroused by this Akai v.t.r. system that uses 1/4-inch tape and provides 20-minutes time on a 5-inch reel.

A full line of accessories including extension speakers and remote controls are also available.

In the video field, CBS provided demonstrations and information on their EVR system and Scott Engineering Sciences showed how its educational and instructional centers were made to be EVR-compatible.

One of the most recent introductions to the video field is a 1/4-inch video tape machine line by AKAI America, Ltd. Of the three units in the new VT series, all are black-and-white, two are portable with zoom lens and weigh less than 20 lbs. (with camera and 3-inch monitor) and the other is an upright model. The smaller units use 5-inch reels while the largest one can use up to 10 1/2-inch reels. Features include off-the-air recording, sound dubbing after the video information has been put on the tape, and stop action. It is also possible to create a tape on the large machine which will be a simultaneous-edit version of the tapes played from the two smaller machines. According to information presently available, these are the only 1/4-inch video machines on the market.

Concord Communications showed its line of video recorders including 1-inch models, consoles, and 1/2-inch units made in accordance with the latest EIAJ standards for 1/2-inch machines.

Also in accordance with the EIAJ standards, the 1/2-inch units in both black-and-white and color by Panasonic were on exhibit. Panasonic had the first EIAJ units on the market at the beginning of 1970. Their latest monitors were also shown.

Sony also provided demonstrations and information of its complete line of 1/2-inch video recorders (with EIAJ specs.) and also its portable video systems and accessories.

Many soft-ware manufacturers were also in attendance and showing their wares. One, which tied in their equipment to the EVR system, was Videorecord, a company which produces material for that medium. They record training and instructional program material for industrial application.

Once again, let it be stressed that the information given here is very brief and is intended only to whet the appetite of those interested either in the a/v or educational fields. We hope that the interested a/v man will get what further information he needs to offer better service to his clients, and that the educational specialist will search out this interested, and therefore better informed, a/v expert. ■

classified

Classified advertising is an excellent and low-cost way to place your products and services before the audio professional. If you are a prospective employer seeking skilled help or an employee seeking a change you will find that the classified pages of **db** reach the people you want. Special low rates apply for this service.

Rates are 50¢ a word for commercial advertisements. Non-commercial and employment offered or wanted placements are accepted at 25¢ per word.

Frequency discounts apply only to commercial ads and are as follows:

- 3 times—10%
- 6 times—20%
- 12 times—33 1/3%

Agency discounts will not be allowed in any case.

Closing date for any issue is the fifteenth of the second month preceding the date of issue.

BANG & OLUFSEN

microphones

BEOMIC BM-5

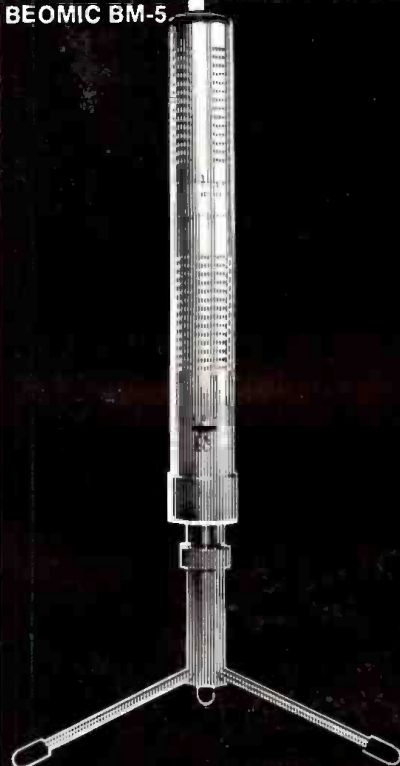

The BM-5 is a ribbon microphone (pressure gradient) for both stereo and mono recordings. It has wide dynamic range, smooth frequency response and low distortion. It is ideally suited for stereo recordings of music from both large and small orchestras.

The BM-5 is actually two identical microphones mounted one above the other. The upper unit is detachable. When the upper microphone is removed the lower unit operates as a conventional monaural microphone. The two individual microphones may be rotated up to 90°, permitting alteration of the acoustic perspective. A Music/Talk switch is included for close-up work. Also included is a phase switch for 0° or 180°.

SPECIFICATIONS:

Frequency Response: 30-13,000 Hz ±2 dB. Sensitivity: 85 dB below 1 µbar in M-position (music); 4 dB lower in T-position (speech). Pickup Pattern: Figure-eight. Hum Pickup: —46 dB. Cord: 20'. Adapter Cable: DIN jack w/two shielded, 2 conductor cords, stripped leads.

\$99.95



BANG & OLUFSEN
OF AMERICA, INC.
525 East Montrose
Wood Dale, Illinois 60191

BUSINESS OPPORTUNITY

Nationwide organization with highest credit rating seeks partnerships with established corporations.

Object: Provide help to minority businessmen in form of capital and management assistance. Minimum investment by you: \$150,000.

Affiliate of our organization will match each dollar you put into jointly-funded investment company with two dollars, then leverage this up to \$2,250,000 with bank credit.

You charter company, manage it, exercise full powers of decision over its investments. We share the satisfaction of seeing more hard-working, talented Americans brought into the heart of the free enterprise system as owners and employers.

More than \$50 million of our funds committed to such joint ventures with more than 100 corporations of all sizes. Excellent track record.

Full details first letter. Reply in confidence to: A. S. Venable, Director, Office of Minority Business Enterprise, United States Department of Commerce, Washington, D.C. 20230.

Space contributed in cooperation with The Advertising Council.

Norman H. Crowhurst

THEORY AND PRACTICE

● After discussing the use of microphones in a reinforcement situation, for public address, where the big problem much of the time is acoustic feedback, coupled with trying to ensure that everyone can hear, turning to the consideration of microphones for studio use seems as if it should be much easier.

That fact is, we seem to have different criteria, which makes both problems pretty much even as regards difficulty, they are *different*. In the reinforcement situation, the main thing is to enable the whole audience to hear and understand. While quality is desirable, it is secondary, provided the program can be heard and understood—and it does not sound too bad.

Listening to reproduced sound, on the other hand, enables the listener to be more critical, because he is isolated from the original event, so to speak. Have you ever tried recording a conversation in a crowded room, and then comparing it with your experience while you were making the recording?

When you were there, a number of conversations were going on at once, and thus several people were talking at the same time. But you could, without too much difficulty, concentrate your attention on whichever one interested you, blocking out the rest. How could you do that?

Possibly lip-reading helped. Not that you are a regular lip-reader, as deaf people are sometimes trained to be, but by following a person's lips, you are able to identify the particular part of the sound that meets your ears, that is coming from those lips. If you cannot see the person's lips, distinguishing what that person says from all the rest becomes a little more difficult—but not always impossible.

But now listen to the recording. The only voice or voices you can really hear, to make sense of, is the one, or the ones, nearest to the microphone used for recording. All the others are just background. Speaking of background, the room sounds much more *echoey*, or reverberant than it seemed when you were listening to the scene live. Why is this?

The only explanation I have been

able to find is that the recording is monophonic, while our original listening was stereo—actually binaural. That faculty enables us to listen selectively. We can direct our attention in a certain direction and, by that means, to some extent, screen out the sounds coming from other directions. Once the sound has all been lumped together on one sound track, there is no way to do this, any more.

The effect is quite curious, until you realize why it happens: the voice of a person nearer to the microphone seems so much louder (unless you have automatic volume control on your recorder, which may correct that) than that of a person, say as far away; and yet the reverberation seems so much louder than it did in real life, especially on the voice of the person further away from the microphone.

If, as an experiment, you try recording the conversation in stereo, without specifically getting one person on one mic and the other person on the other, you will find that listening improves somewhat. Reverberation does not seem so over-emphasized, and you can discriminate between different voices a little more readily.

Here you have a principal reason why stereophonic recording and reproduction, whether two-channel or some kind of four-channel, adds to the realism. It is not so much that it enables the listener to *place* the various sources of sound, musical instruments, etc.; it is that it enables the first-hand impression (of being there) to be better realized.

The so-called *hole-in-the-middle* was not so much due to loss of sound sources that should be located in the center, as it was due to loss of realism about the reproduction of those sources. They could be heard, but there was a "hollow-ness" about their sound, due to increased reverberation, as compared with that due to sources nearer to specific channel pick-up points (microphones).

Thus an essential feature of good studio microphone techniques is that original sound sources—musical instruments, vocalists, etc.—be ade-

for that heavy studio sound!

LA-3A leveling amplifier

The great one with the
Electro-Optical attenuator

- Half rack size
- High output (+25 dBm)
- Low price (under \$400.00)

See your dealer or write for complete specifications.



11922 Valerio Street, No. Hollywood, California 91601
(213) 764-1500

Exclusive export agent:
GOTHAM AUDIO DEVELOPMENT CORP., NEW YORK, N.Y.
Telex #238353 GADC UR

quately distinguished from reverberation and other secondary effects. We have all heard the live transmission where the operator did not get the correct microphone on at some point, and the person speaking or performing was picked up by other microphones in the same studio or room: the difference that gives it away is the much higher reverberation noticeable. You can hear, but the high reverberation tells you the mic (meaning the one intended to pick up that person's performance) is not on.

Selecting a suitable microphone to pick up any particular program item must take into consideration the nature of sound from that item. For example, microphones to pick up strings in an orchestra should either be close in, or achieve the same effect by use of a high degree of directivity. On the other hand, brass instruments, horns, except when played with mutes, use considerable projection of sound from their bells.

So far the latter type of sound source, it may be better to rely on the instrument rather than the microphone, to achieve the sense of directness or presence. If the player points his horn in the general direction of the microphone, as most players tend to do, the microphone can be at a suitable distance away, to achieve an attenuation that puts the horn sound in perspective with the rest of the orchestra.

It may even be advantageous to use a directional microphone, arranging that the horn player is considerably off axis, so as to further attenuate the direct sound, more than mere distance can conveniently achieve.

From some viewpoints, providing a separate, high-quality microphone for every player in an orchestra has something to recommend it. Then each microphone can be independently controlled to achieve balance. But there is a limitation to this. If the microphone in front of a given player is turned all the way off, the other microphones will pick up something from this player, which may not be desirable, because of the increased reverberation that will be associated with this instrument.

But a more undesirable effect may occur when that microphone is not quite all the way off, so that the two microphones pick up the same instrument at the same intensity, but at quite different distance. This can play havoc with the overtone structure and thus with the apparent timbre of the instrument. Harmonics of the notes played will go in and out of phase like crazy.

This calls for careful arrangement of microphones and orchestra so that

instruments that produce a higher sound level do not feed into more distant microphones. This calls for cooperation with the orchestra director or conductor. Most musicians have formulated an arrangement that enables them to perform well as an ensemble without microphones. And this they should be able to do, because they depend on hearing the sounds the whole orchestra makes directly, rather than as picked up by the microphones, to achieve their total musical effect, *as they hear it.*

This calls for some ingenuity in arrangement, that is acceptable to both the conductor and the audio man. The conductor must be able to hear everyone in his orchestra, in a balance that is acceptable to him for directing the orchestra. At the same time, the microphones must pick up the various instruments so that his electronic controls can achieve satisfactory balance in the reproduced program.

Some conductors will settle for—or even prefer—the use of good headphones, so they can hear exactly the same sound that the listeners get in the reproduction. On the other hand, others will not accept this, because long conditioning has had them listening to the total sound from a position much closer to the orchestra than an average audience listener position, which is what the reproduction tries to simulate.

Simulating the sound as perceived in an average listener position requires a directness or presence of individual instruments, plus a realistic amount of reverberation, to give the character of the auditorium in which the program is being heard.

For this purpose, most modern audio people prefer to have the reverberation controllable, by one method or another. In other words, if only the microphones used for direct pickup of the orchestra are used, the result is more dead than it would appear listening to the performance live in that auditorium, so some additional reverberation is needed to make it sound "real."

This can be achieved either by using one or more microphones to pick elements of actual reverberation from the auditorium in which the performance is presented, or by using artificial reverberation, which is another question. Artificial reverberation can use an actual echo chamber, in which the sound is reproduced by a loudspeaker and picked up by another microphone, which adds a controlled amount of echo characteristic of that chamber, or by using tape or other delay lines to simulate the same kind of effect. As I say, this introduces a whole new question. ■

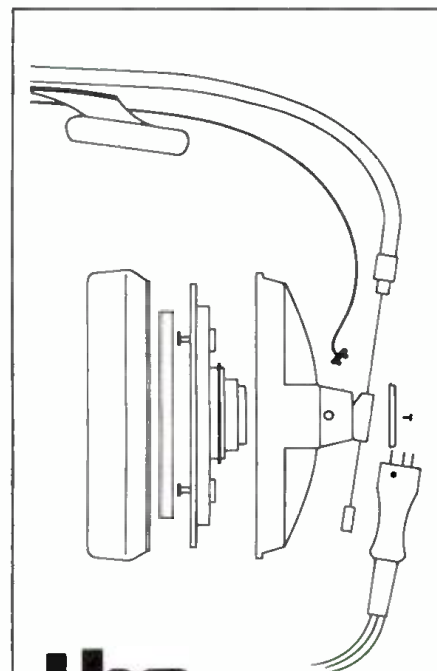

the all modular head- phone

While it's pretty easy to take apart, it's not likely you'll ever have to.

That's because when you've made microphones and headphones for over 40 years, you learn a little about reliability, ease of servicing, and the kind of overall quality that professionals expect.

The virtually blow-out proof DT-100 is available in 5, 100, 400, 1000, and 2000 ohms impedance.

BEYER DYNAMIC. *Pioneer in dynamic transducers.*

Revox Corporation
155 Michael Drive, Syosset, N.Y. 11791

Circle 22 on Reader Service Card

THE FEEDBACK LOOP

● For a number of months I have been intensively involved in the consumer end of the audio business. As an engineer, viewing this aspect of the audio field is a novel experience. The audio industry generates a vast quantity of consumer hardware, and employs a large number of professional audio people to design, produce, and service these products. Yet, I feel, there is hardly any communication between the two groups.

My first contact as a technical person with the non-technical public was as a t.v. repairman. During the early fifties, while I was in engineering school, I ran a one man t.v. repair service. Initially, I was concerned that my customers be aware of why their set had failed, how it was repaired, and how the cost of repair was arrived at. If a capacitor shorted causing a resistor to burn out in the vertical output stage, I would take a few minutes to make a simple explanation and show the defective parts I had replaced. To my consternation this straightforward approach had, with rare exceptions, either of two unpleasant results. The usual response was an immediate loss of confidence in my ability as a repairman. The customer took my explanation as a symptom of self doubt and hesitancy—or possibly as a means of self justification for a job not too well done (even though the set would be working very well). A second response, though much less frequent, was to suspect my honesty and integrity. On these occasions I would hear something to this effect, "How could I charge \$20.00 just to replace those two little parts that probably cost no more than ten cents." Any effort to explain that the parts cost \$1.34, that it had taken the better part of two hours to (either) set up the receiver on the bench and locate the trouble with something more sophisticated than a pair of bare hands

as test equipment, (or) make the necessary repair, and in addition spend additional time going to and from the customer's house, would only result in reinforcing the original erroneous impression.

It did not take me long to learn my lesson in public relations. I got the message. What I learned was to keep the facts to myself and to recite a few bland phrases to sooth the jangled nerves of my customer—\$20.00 poorer and in no mood to hear anything they didn't like. However, it did puzzle me why the average t.v. repair customer preferred vague and inconsequential generalities to a straightforward reason for his bill.

In an analogous way, I find the same situation in the consumer purchase of audio equipment. I recall a number of years ago when I worked for University Loudspeakers and helped man the booth at consumer high-fidelity shows. In order to communicate effectively with the people visiting the University booth I had to adopt the approach of the salesman I worked along with. Understandably, lapsing into technical jargon would quickly put a person off. But even when the subject allowed, any kind of discussion that strayed too far from the established advertising and promotional idiom would always make my listener lose interest rapidly.

My present experience in the consumer end of the audio industry confirms this previous experience. I think some of the answer lies in the fact that the interface between the engineering side and the consumer is the sales-advertising-promotional aspects of the business. The strongest reality to the audio consumer is the advertising and promotional material that reaches him in great volume. True, there are consumer oriented publications that print many excellent articles with sound scientific and factual bases, but

this kind of information seems to have no more weight than an equal volume of advertising copy. Salesmen for the most part are basically non technical, and, by choice or necessity, relate to the consumer in terms of the advertising idiom.

The audio industry is not unique in this respect. The effect of all this, while it tends to isolate the engineer from the consumer who ultimately purchases and uses the products generated by the engineer, is that audio products tend to be evaluated on the basis of what the promotional material dictates rather than on the objective merits of the product. An example comes to mind in the field of high fidelity phono cartridges. One of the leading companies in the field has, by means of an effective advertising campaign, established an atmosphere wherein the major and almost sole criterion of excellence is tracking force. The lighter the tracking, the better the cartridge. So pervasive is this belief that a prestigious and generally fair-minded consumer organization used this very criterion to rate the relative merits of high quality cartridges.

In fact, the ability of a cartridge to track the grooves of a record is important, and mistracking does cause objectionable distortion. But the point here is that while a cartridge's ability to track is, without question, important, exalting this one aspect of cartridge performance to the exclusion of other important features presents a distorted reality to the consumer.

The consumer, unlike the professional, cannot use instrumentation to measure and check audio equipment. The sales effort in the professional equipment field is marked by a good deal more candor than it is in the consumer field. I feel that the influence of the engineer could contribute something important to the enlightenment of the consumer. Unfortunately, for the most part, he is unable to make that vital communication as effectively as he might. ■

ERRATA

On page 17 of the June issue, we showed a photo taken at the L.A. AES Convention in which Steve Temmer, president of Gotham Audio Corporation, was seen with his new Delta-T system. The caption of the picture calls the Delta-T a *reverb system*, when in fact it is nothing of the kind. It is a *delay* system offering variable choices of delay. And *delay* is not *reverb*. But you all know that—L.Z.

NEW PRODUCTS AND SERVICES

FOUR-CHANNEL 'PHONES

● The first *Quadrafone*, model K2+2 has four separate driver elements to deliver proper surround sound from four channel amplifiers. It is also compatible with conventional stereo amplifiers. Four matched driver elements in a headset no larger than conventional stereophones provide 10-20,000 Hz response at negligible distortion (levels up to 95 dB spl. A switch on the headphone permits use on conventional stereo amplifiers. In the stereo position, the two drivers feeding each ear are paralleled. Impedance requirements are 4-10 ohms; two plugs are provided at the end of a flexible eight-conductor cord that will extend to 10 feet.



Mfr: Koss Electronics, Inc.

Price: \$85.00

Circle 73 on Reader Service Card

ISOLATION MOUNT

● This microphone isolation mount combines small size and high effectiveness. Called the model A55M, it is small and will operate with this company's 545, 548, 565, SM50, SM57, and SM58 mics. With such mics, noise isolation is increased by 20 dB when the mount is used. It can be used on desk and floor stands, lecture podiums, and is ideal for boom operation.



Mfr: Shure Bros., Inc.

Price: \$25.00

Circle 66 on Reader Service Card

ACTIVE TRANSFORMER

● The model AT200 is a differential input d.c. amplifier used to reject common mode noise that occurs in transferring d.c. or audio signals from one chassis to another. It provides 100 k input impedance and voltage gain set by an external resistor from 0 to 30 dB. It delivers ± 11 V d.c. to 20 kHz open circuit, has less than 0.01 per cent distortion and is capable of feeding loads down to 150 ohms. Frequency response is -3 dB at 370 kHz, input offset is ± 1 mV maximum, and noise is 5μ V maximum from 10 Hz to 20 kHz. It is free of magnetic hum pickup.

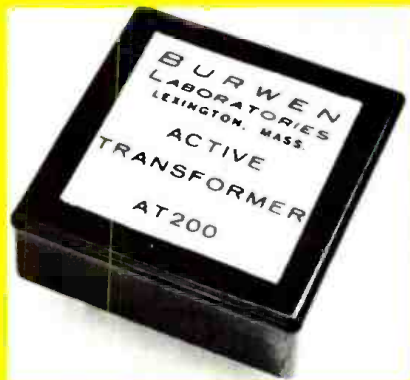

Mfr: Burwen Laboratories

Circle 75 on Reader Service Card

TEST SYSTEM



● All the major parameters of a magnetic recording system can be measured by the RTS-1 recorder test set. Only two leads from the set under consideration permit measurement of flutter, harmonic distortion, noise, frequency response, etc. A built in variable frequency audio generator and a millivolt meter permit use from 15 Hz to 150 kHz at levels as low as 1 mV full scale. Flutter, peak or average, as well as drift can be measured on two scales—either 1 per cent or 0.3 per cent full scale. Total harmonic distortion can be measured down to 0.1 per cent full scale. Calibrating controls are accessible; and a 'scope output jack is furnished.

Mfr: Ferrograph (Elpa Marketing)

Price: \$1050.00.

Circle 63 on Reader Service Card.

LOW FREQUENCY SPEAKER



● A power handling rating of 160 watts for this low-frequency speaker system is available. This rating is derived by the use of random noise shaped to produce equal energy in the frequency range of 100 to 500 Hz. The enclosure is only 34-inches high is constructed of $\frac{3}{4}$ -inch plywood, and has two 15-inch drivers. Frequency response is from 40-2500 Hz. A complete curve of ISO one-third octave white noise readings is available. Model designation is 6A405.

Mfr: DuKane Corp.

Circle 61 on Reader Service Card

SHOTGUN CONDENSER

● The MKH 815 is 22 inches long by $\frac{3}{4}$ inches in diameter. It is the successor to the MKH 805 and retains all that model's important acoustical, electrical, and mechanical characteristics. To these are added additional wind noise resistance, due to redesign of the slotting. The narrow beam response is stated to be 50-20,000 Hz, low noise is characteristic, and compatibility with high and low impedance inputs is featured. High output and overload resistance is also part of the design.

Mfr: Sennheiser Electronic Corp.

Price: \$493.00

Circle 67 on Reader Service Card



CONSOLE KIT

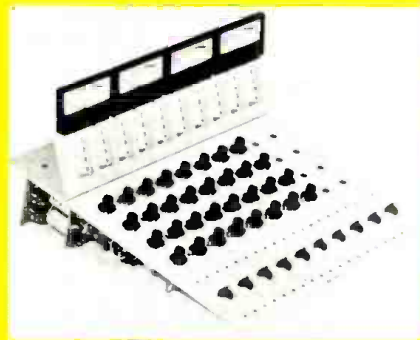

● This ten-station portable mic-mix-down console kit consists of numbers of modular subassemblies which may be ordered as required to construct a small console of specialized need and capability. As much or as little as you need can be included. Modules available include meter panels; push on, push off button sets; high frequency equalization, low frequency equalization; echo send; input select/pan pot; and mix pots. A main panel is separate as are power supply modules.

Mfr: Opamp Labs, Inc.

Circle 72 on Reader Service Card

COLUMN SPEAKER

● An effective sound throw of one hundred feet is one of the features of this newly introduced SB-150/H horn column. It is designed specifically to serve the modern musical group's vocal and instrumental needs. Rich bass response and natural full-range voice reproduction, as well as high power capabilities are claimed. The column contains four eight-inch 15-watt speakers (60 watts total) and one high-frequency horn. A total of 150 watts of music power handling capability is claimed. The back plate has a $\frac{1}{4}$ -in. jack, a terminal strip, a fuse and fuse holder for overload protection, and a horn cutout switch (special musical effects). Input impedance is eight ohms.

Mfr: Temple Sound Equipment Co.

Price: \$209.00

Circle 60 on Reader Service Card



DIGITAL DBM TEST SET



● Model TTI 1100A is a new kind of transmission test instrument for voice, program, or wide-band data circuits. It makes the same familiar level measurements as conventional instruments but virtually eliminates human error. It will measure from input impedances of 135, 600, and 900 ohms ± 0.2 per cent, balanced or unbalanced. As a bridging device it should see 200 k minimum. The frequency range is 100 Hz to 50 kHz; measurement range is -50 dBm to $+10$ dBm; dynamic range is 60 dB; readout is a Nixie display—three digits and plus or minus sign.

Mfr: Telecommunications Technology, Inc.

Price: \$845.00

Circle 76 on Reader Service Card

PRO TAPE DECK

● The MX7000 is the first in a family of professional recorder decks now available. A three-speed hysteresis synchronous motor, automatic equalization for $3\frac{3}{4}$, $7\frac{1}{2}$, and 15 inch per second speed, and a built in test oscillator (700 Hz and 10 kHz) are featured. Heads are plug in assemblies for quick change to one- to four-channel capability. Six-pole reel motors take standard NAB $10\frac{1}{2}$ -inch reels. Circuits are all solid state, the transport base is a heavy aluminum die-casting, and the control system is push button.

Mfr: Otari of America

Price: \$1980.00

Circle 64 on Reader Service Card

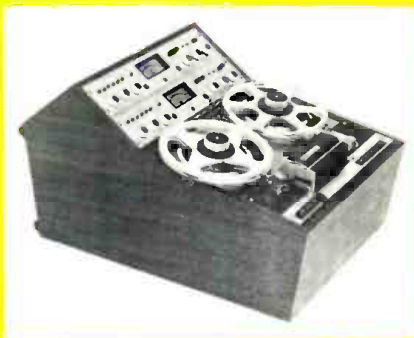

MODULAR SWITCH

● Up to any one of eleven circuits per module can be reached without touching any of the others in between with this new direct-access modular switch. An independent bus is contacted within the selector during switching which serves as a make-ready circuit to signal a forthcoming change. The switches may be ganged for network program routing controls.
Mfr: Seulectro Corp.
Circle 70 on Reader Service Card

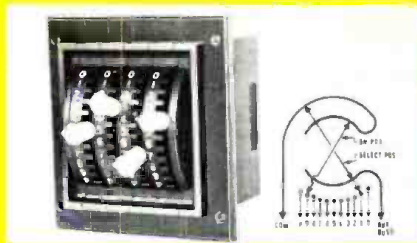

PORTABLE SYNTHESIZER

● Electronic music moves out of the studio onto the stage with the ARP 2600. This synthesizer comes in a suitcase and can be used as an additional keyboard, sitting atop any existing organ or piano—or as a solo instrument. The aim of this unit is primarily performing musicians and the home market, but its low cost will permit its use where higher-cost units could not previously go. A wide range of expression is possible with this instrument. A four-octave keyboard is included. For performance, separate amplification and speaker systems are required.
Mfr: Tonus, Inc.
Price: \$2490.00
Circle 74 on Reader Service Card



ATTENUATOR

● Easy access to these audio attenuators permits ready maintenance and periodic cleaning. A number of versions are available including unbalanced ladders, with or without cuing, and in various standard impedances. Stereo and mono units are available, with isolation between channels exceeding -75 dB at 15 kHz. Electrical switching is accomplished with coin silver contacts and silver alloy wipers.
Mfr: Shallco, Inc.
Circle 62 on Reader Service Card



NEW!

PANNING AND SLIDERS ON A BUDGET

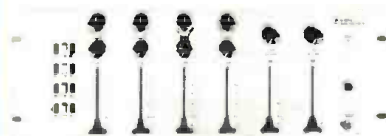

EM-7S Four Input Stereo Echo Mixer

All features of our regular EM-7 Mixer plus slide pots, panning active mixing and IC circuitry. Duplicates all big board effects when used with ES-7 echo unit and PEQ-7 equalizer.

FOUR CHANNEL ACTIVE PEAKING TYPE EQUALIZER



PEQ-7 Four Channel Equalizer

Update your EM-7 system or use with new EM-7S Mixer. Five Hi freq. peaking type curves, 1.5, 3, 5, 10, and 20 kHz. Boost or cut in steps of 2, 4, 6, 9, or 12 dB. EQ in-out switch. Zero insertion loss.

GATELY ELECTRONICS

57 WEST HILLCREST AVENUE
HAVERTOWN, PENNA. 19083
AREA CODE 215 • HI 6-1415
...have you checked Gately lately?

Circle 27 on Reader Service Card

SPEAKER SWITCH

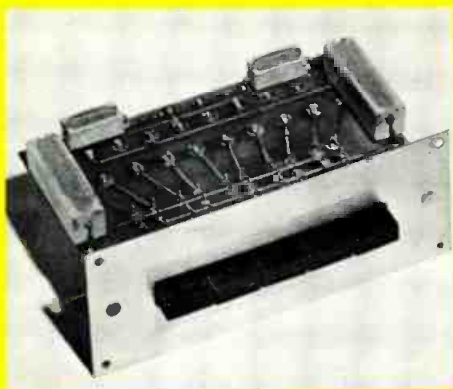

● This five-pushbutton speaker switch includes power resistors to prevent damage to transistor or tube amplifiers. Both no-load prevention and proper line load balancing are effected by the resistors as speakers are selected. All connections are by screw terminals. Up to five pairs of speakers may be thus selected. The power handling capability of the switch and resistors is dependent on the load of speakers. With one pair only it is 55 watts continuous power per channel. With a maximum of five pair, it is 23 watts per channel at 8 ohms.

Mfr: Audiotex

Price: \$29.95

Circle 71 on Reader Service Card

DOLBY B CASSETTE RECORDER

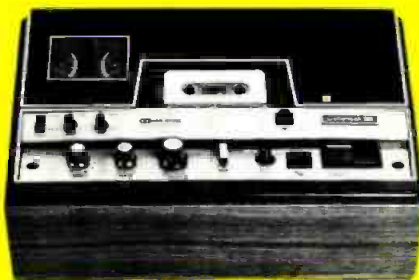

● Model 4760 combines a heavy duty drive system with Dolby B noise reduction, bias switching for standard or high-bias tapes, and end of tape solenoid capstan roller disengagement, into a cassette deck. Basic electronics only are included. A mic preamp is an optional low-cost attachment. Illuminated vu type meters are employed. Specs include a 35 Hz-15 kHz frequency response ± 2 dB, flutter at less than 0.15 per cent, and s/n at better than 54 dB using premium cassette tapes.

Mfr: 3M-Wollensak

Price: \$279.95

Circle 65 on Reader Service Card

CASSETTE ALIGNMENT TAPE

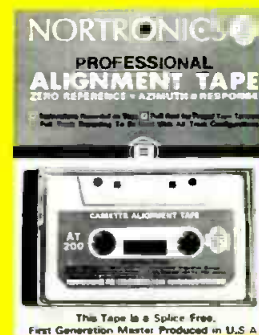

● This tape has been designed for the profession. Each tape is splice-free, and first generation, and provides zero reference, azimuth alignment, and frequency response tests. The zero reference is a 30-second tone at 333 Hz, ± 5 per cent. Azimuth alignment tone is 60 seconds at 6.3 kHz, 20 dB below zero reference. A series of 10-second tones range from 31.5 Hz to 10 kHz. Speed accuracy of ± 0.01 per cent at 1 7/8 in/sec, frequency accuracy of ± 0.05 per cent, and tone level accuracy of ± 1.2 dB, as well as distortion of under 0.6 per cent, are offered. All tones are full track for use with all head configurations.

Mfr: Nortronics Co. Inc.

Circle 69 on Reader Service Card

RECENT LITERATURE

● Acoustical panels of prefab design are described in a bulletin published by the Industrial Acoustics Company, Inc. The engineering and construction success of modular, pre-engineered acoustical panels and components is detailed. *Circle 54 on Reader Service Card.*

● Attenuator information is available in a twenty-four page catalog from Tech Labs. Pots, pads, ladders, mixers, faders, gain controls, and other types of signal level control circuits that can be supplied are listed in detail. *Circle 53 on Reader Service Card.*

● A new catalog containing all the new entries in GC Electronics' Audiotex product line has been issued. A total of 52 pages of two-color material include items for all phases of electronic home and professional use. More than 350 items are listed. *Circle 51 on Reader Service Card.*

● Professional tape equipment for the broadcast and industrial fields are listed in a comprehensive catalog from Telex Communications Division. Twenty large-format pages in two-color list technical details of Magne-cord and Telex tape products including reel-to-reel and cartridge equipment. *Circle 52 on Reader Service Card.*

● Canadian readers only, take note: Ilford Photo (Canada) Ltd., has new tape products that are now available. One is a 4 dB Plus tape available in 1/4, 1/2, 1, and 2 inch formats. Low noise and low print versions are available. Another booklet describes magnetic films. Ilford is only available in Canada. *Circle 57 on Reader Service Card.*

● Ferroxcube Corporation, manufacturer of recording heads for industry, professional, and home use, has a bulletin number 1021. Its title is Audio Magnetic Recording Heads for Cassette and Cartridge Duplication. Eight, two-color pages describe the company's line. *Circle 50 on Reader Service Card.*

● The how and why of switch selection is in a thirty-two page booklet from Tech Labs, Inc. Topics covered included types of switches available, carrying and rated current capacity, switch life, and pricing. *Circle 55 on Reader Service Card.*

● A bulletin from Switchcraft, Inc. details their quick-ground audio connectors for the professional. These are connectors with microphone on/off controls permitting the performer to control his on/off even though the mic does not have this facility. *Circle 56 on Reader Service Card.*

The Sync Pulse in t.v. Audio

Sophisticated television audio is moving more and more to double system methods of recording sound. The author has prepared a multi-part series on this subject that begins this month with the reasons and methods for the use of the sync pulse.

EVERYONE KNOWS that a motion picture, whether it be television or film, will have little credibility if the sound and the picture are not in sync. To be more specific, it is imperative that the sound be squarely in step with the image on the screen which is supposed to be producing that sound. It is merely careless language which declares that the sound must follow the picture exactly. For, we do not want the sound to *follow* the picture, exactly or any other way; nor do we want it to lead the picture. What we want is precisely what was stated in the second sentence: the sound must be synchronous with the image that is supposed to be producing that sound.

Since I am speaking principally from the standpoint of the audio technician working in *television*, you may wonder what the problem is. For, isn't it true that the sound is recorded simultaneously with the picture on the same piece of tape? If so, how can they possibly be out of sync? The answer is: they can't, under those conditions. But even though the sound is invariably recorded onto the video tape along with the picture, more and more today it is being recorded *also* on a separate audio tape machine, for reasons described further on. And also more and more,

Marshall King is a frequent contributor to these pages. He is audio mixer at the Wolper Video Center in Hollywood, California (formerly the Hollywood Video Center).

Fortunately, great paths have been cut through the jungle by our friends in the film industry.

it is *this* sound which is being called upon to provide the final audio to be joined with the picture. This being the case, the problem suggested above becomes very real: how do we keep the sound on the *audio* tape machine in sync with the picture on the *video* tape machine? Fortunately, great paths have been cut through the jungle by our friends in the film industry, and we can now borrow from their experiences as we add innovations of our own.

First, why are we recording the audio separately in many cases? What are the advantages in doing this? Probably it all began with some audio technician not willing to accept the quality of sound that comes from video tape machines when the product is finally released. While it is true that the audio as recorded and played back on video tape has proven to be quite acceptable for most uses, it cannot compare to the sound which results from the kid-glove handling given it by an audio man, *if* it stays under his control from beginning to end.

In other words, video tape operators have their own problems, most of them to do with pictures, and perhaps they are not to be blamed if they and the directors who work with them during the tedious hours of editing consider sound as a slightly necessary nuisance. They have been told time and again by high executives that, without

I've seen a longitudinal view of a piece of video tape that looked like a dip chip from the El Torito restaurant.

audio, cards and letters come rolling in from viewers everywhere. and sometimes clients want their money back. So. television tape does provide for sound. like it or not.

Of course, this grudging view of audio is not often taken by editors nor anyone else, but sometimes the audio man finds he must work very hard (and often shout very loud) to keep good audio from disappearing down a hole somewhere. For one thing, the video tape itself can be the culprit. During television recording, audio is assigned to a very thin edge of the two-inch wide tape, the rest being reserved for video and its concomitant control tracks. And, if any tape is going to develop a curl or warp due to stresses and strains, where will that curl take place? Along the edge, of course. I've seen a longitudinal view of a piece of video tape that looked like a dip chip from the El Torito restaurant. While the situation in tape strength and emulsion consistency has improved somewhat since television's early days, it is still true that the space allotted to audio on a piece of video tape is definitely not the center cut; it might be better considered as left-overs.

In addition to this, any flaws in the audio which might otherwise be corrected through the use of the equalizer, the Kepex, the limiter, or what have you, can seldom be heard by the video tape man in his work area, for there is so much extraneous noise in that room that one could easily run a brace of howling dogs through the premises without attracting too much attention. So, many fixable flaws are passed along from one editing step to another until it is far too late to do anything about it. Once the editor makes certain dubs, certain overlays, certain intercuts, and certain other repair techniques he relies upon. the audio is locked in to the point where further handling of the product is unthinkable. Had the audio man been able to keep the sound free on a full quarter-inch tape and laid it over to v.t.r. at the last moment. excellent quality might have been preserved all along.

Another source of "badness" which attacks the audio on a piece of video tape during editing can be due to new video being laid over audio. Audio can be laid over picture, but *not* the reverse. If this is done, it is not uncommon to find that a fuzzy tone has been put into the audio, which is the result of a video sync pulse getting out of its own backyard and into the tiny area reserved for sound. Beyond this annoyance. certain hums (probably the 59.95 Hz used for color control and motor drive) can sometimes be heard on some edits after the whole thing is put together. The video tape editor may be quite sincere and well-intentioned when he insists that these fuzzy tones and hums were not put in during editing. Yet. too often. when we listen to the video tape on speakers in the audio control room, we hear those unwanted sounds, either coming in or going out. at the exact points where certain edits were made on the picture.

This is not to point a finger at the v.t.r. editor. for the truly is not the one to critically judge the audio quality, but it is to clearly state the reasons why double-system recording (sound separate from picture) should be used more often, if not as standard procedure. Many a con-

scientious audio man is doing this anyway, although it can be a sticky problem between himself, his employer, and the client. Such a practice is usually considered a luxury by the employer who insists that, if used, such extra time and equipment should be chargeable to the client. And, to date, few clients (the producer) have been found willing to pay for this special concern on the part of the audio technician. It's not merely a matter of taking along a spare audio tape machine. It means. too, that we must record a sync pulse on our audio tape as well as the program sound. And this takes some planning ahead, which is what we're investigating herein.

Before we look at further reasons for recording sound separately from picture to see if this practice is truly justified in television, let's say a word here about two terms frequently used in double-system recording: *sync* and *resolving*. To over-simplify for a moment, *sync* refers to the coded instruction that is laid down on film or tape during recording which can be used during playback to control the speed of the film or tape. *Resolving*, on the other hand, refers to the method whereby that coded instruction is extracted and put to use in controlling the playback speed. "A *resolver* is a device which is used to compare two frequencies by electronic sampling and to bring one in step with the other by applying feedback information from one through a servo circuit to the other.

With regard to *sync*, in the motion-picture industry it is merely those sprocket holes which have been perforated into the edge of the film. In television, the sync is recorded onto tape in the form of a wave pulse which can be taken from almost any kind of signal generator. However, since a pulse of 59.95 Hz is used (for reasons pertaining to color control) to drive the video tape machine motors, it can be most convenient to use this pulse as the sync which is laid down on both video and audio tape. Although other means of getting a sync pulse are possible, it is this method that is referred to in this month's article because of its utter availability.

With regard to *resolving*, it is accomplished in the motion-picture industry (once the sound is put on a separate magnetic film) merely by locking up the sprocket holes of both picture film and sound film to sprocketed gears on a common drive shaft. In television. resolving is accomplished by making those sync pulses recorded on tape refer to a metronome during playback. In the examples used here. the metronome will be the sync generator which supplied those 59.95 Hz pulses in the first place. This generator is made to act as a traffic cop during playback. It wants to see a pulse from video or audio tape go by every time it generates a pulse of its own. and through a servo circuit it manages to bring this about. That is. if the tape tends to speed up so that its pulses start going by this traffic cop at a rate faster than 59.95 Hz, the circuit orders it to slow down by the correct amount. And if it tends to fall below this speed. it is made to come up to the mark.

Again, over-simplification does not take into account other ways to resolve one signal against another, and in

A thing called generation gap has plagued audio men in television far longer than it has today's . . . confused parents.

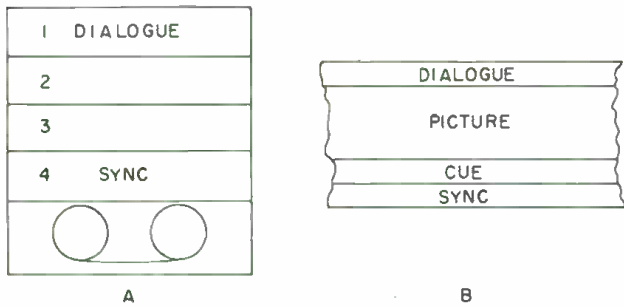

Figure 1. (A) This is what is recorded on audio tape; and (B) is the same program recorded on video tape.

a future issue we may look further into the tested methods used to resolve audio by having the sync pulse of tapes made on such machines as the Nagra recorder drive such devices as a projector, for example.

Let's look at yet another reason for recording television sound separately from picture. The film industry has known for years that in location shooting there is always the lurking nightmare of jet planes, nearby motorcycles, and other gremlins ready to destroy the audio without a moment's notice. Do they call the whole thing off? Certainly not. The practice is merely to shoot the program anyway, and then resort to *looping* the sound back in the studio where things are more quiet. The bad audio recorded on the set is used merely as a reference between sound and picture. True, the audio that is recorded on video tape could be used for that reference in a looping session, but to tie up those expensive and seldom-available video tape machines just for the purpose of transferring sound for looping is a very costly operation indeed. Far better to record the sound (and a sync signal) on an audio tape machine during the time of shooting the pictures on location. Then, back in the studio the audio man can get to work with his own tapes, while the v.t.r. operator proceeds with editing and assembly of the picture.

Let's consider a final reason for using double-system recording before we follow through in detail one practical method for doing so. A thing called *generation gap* has plagued audio men in television far longer than it has today's hippies and their confused parents. The gap between first generation and the one which goes on the air, in a television show, is horrendous from an audio standpoint. *Logarithmically* is the way sound deteriorates during v.t.r. edit procedures, whereas the picture seems to suffer only somewhat. So, it would be a great advantage if the audio could be recorded on high-quality audio tape and handled by audio technicians in every stage of post-production until it is required to be laid back onto video tape alongside the picture. True, the video tape that we're laying back *onto* may have that El Torito dip chip curl already mentioned, but at least we can select another

On Monday, only the actors are available . . . The orchestra isn't available until Tuesday . . . and we cannot put sound effects in until Wednesday.

video tape, or even a third, until we come across good stock. The main concern here is that our *master* audio is on audio tape, not on warped video.

Now let's look at a practical example of how we can use a sync pulse to record double system television in a studio where, let's say, there is no provision for resolving *per se*. That is, the equipment of our studio in this example does not include a Kudelski resolver, a Jensen resolver, a Martin resolver, or any other kind of resolver made specifically for audio tape machines. We are going to be very sneaky, and put to use the 59.95 Hz sync pulse easily available from our video tape machines. And as for resolving this signal during playback—we're going to let video tape (v.t.r.) do it for us, at the very last moment, after the picture has been edited. And in this example we are going to find yet one more reason for recording audio separately from picture: it gives us the ability to use multi-track techniques which most producers and directors expect to find in any modern facility having post-production services. At Wolper Video Center we have been making use of at least one four-track Ampex for the process about to be described, although we may soon extend this to eight-track to accommodate a looping system. Let's look at a typical requirement, in which we are using a single four-track tape machine for audio during moments of recording. Later, during post-production, we'll add a two-track machine to this.

We're televising a three-act play requiring actors, an orchestra, some off-camera sound effects, and four one-minute commercials. We are not going to have all these elements at our disposal at the same time. On Monday only the actors are available, so that's when we'll shoot the body of the show. The orchestra isn't available until Tuesday, and since all sound effects and audience reaction effects which we'll need have not yet been identified nor obtained, we cannot put these in until Wednesday. Nevertheless, the cast of twelve actors is here now, on Monday, so here we go.

As video tape records both picture and sound, we in audio are recording, simultaneously, the sound (dialogue, in this case) on track one of our four-track audio tape machine. Whenever video tape rolls their machines, we roll ours, and we record the same slates that they do. At the same time, we are recording, on Track four of our audio tape machine, a sync pulse of 59.95 Hz received from the video tape area. A form of this sync pulse is being recorded at the same time on the *control track* of the video tape, for later use in maintaining similar constant speed during playback.

Figure 2. This is what must be recorded so the orchestra leaders has something to work with.

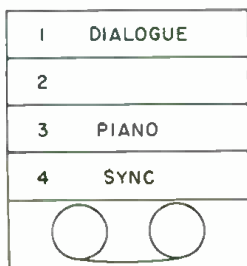
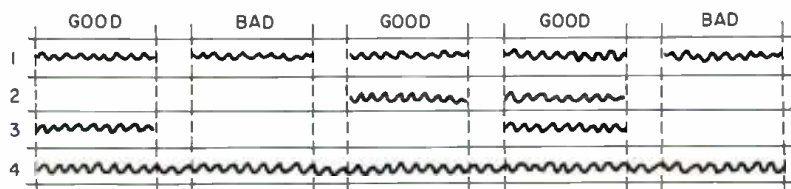

Figure 3. A random segment of the four-track tape.



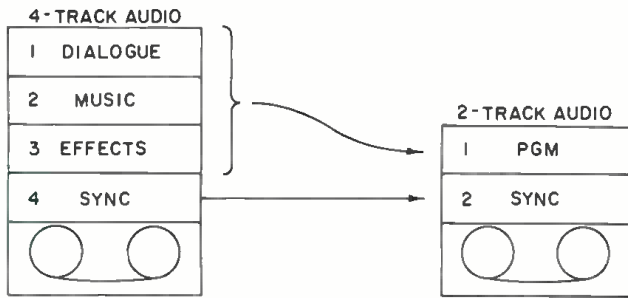

Figure 4. Only the good takes are dubbed from the four-track tape to two-track as shown.

What we have recorded on audio tape on Monday is shown in FIGURE 1(A) and on video tape in FIGURE 1(B). On audio tape we have dialogue on track one and sync on track four. This leaves track two and track three available for music and sound effects, respectively. Video tape, on the other hand, has recorded dialogue on the top (audio) portion of its tape, picture in the center section, a cue* track below the picture, and sync track on the bottom edge.

On Tuesday the orchestra comes in and we record the music on Track two of our audio tape. Video tape is not involved in this; they are now busy editing the picture. They are removing the bad takes, saving the good ones, inserting the commercials where they belong, and quite possibly, attaching the opening titles and closing credits which may have been shot at another time and place and delivered to them on a separate piece of video tape. When they are finished with this work, the program will be in proper order from beginning to end and it will be of the correct length. It will merely lack the final audio, which we are about to continue with now.

*The cue track portion of the video tape can be used at the editor's discretion, for any kind of audio guide track to help him in editing. The audible signal placed here can also be placed on track four of our audio tape, super-imposed over the sync, if it is intended that the audio technician will physically edit (cut) his four-track tape to match the edits made on the video tape. In the instance under discussion, however, we are NOT cutting our four-track tape, for the procedure outlined herein is far more expedient than our trying to physically make the same edits that are made electronically on the picture, in video tape.

Figure 5. The two tracks of the audio recorder are fed to the video tape room where they will be directed as shown.

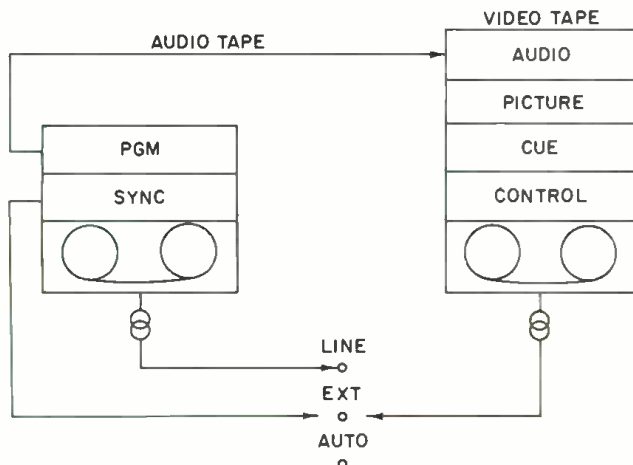

Right now, we can make the orchestra leader very happy if we have done our homework with regard to click tracks.

In many cases the music can be recorded against a stopwatch, either before or after the drama is televised, without regard to specific actions of the performers. This means that we can record the music wild with no reference to the picture, using only a stopwatch to guide the conductor. Such music tracks probably can best be recorded on a single-track audio tape machine since no sync is required, and, after the good takes are assembled together, laid over to track two of the four-track tape (at the proper cue mark for music) at any convenient time.

But let us say that the whims of the orchestra leader dictate that he conduct the music to picture, as has been the standard practice in the film industry for many years. Or, if a better reason for conducting to picture is required for our example, let's say that the program is a musical drama, such as *Camelot*, and that the performers must sing many of their lines. Since the orchestra was not there on Monday, the performers were obliged to sing against an off-camera piano which was enough to give them cues and to keep them in both pitch and tempo. True, the sound of this distant piano can be heard slightly on the dialogue track (our track one), but it will never be heard in the final program, for the orchestra will cover it eventually. Under these circumstances which we have just concocted, we feed one more sound to our four-track tape on Monday as we record the dialogue. That sound is a tight pick-up on the piano, which we put onto track three (later to be used for sound effects). Under these more stringent conditions pertaining to music, FIGURE 2 shows what we must record on Monday. Now the orchestra leader has something to work with on Tuesday. On earphones we feed to him (and to the other musicians if required) the output of tracks one and three played in a sel sync mode, as we record the orchestra on track two. Let's look at some details involved in the process.

First of all, as we play this four-track machine back to the orchestra earphones, we need not worry about resolving the sync which we laid down on track four on Monday; we'll let the operators in video tape do this later on their video tape machines. Right now we can make the orchestra leader very happy if we have done our homework with regard to *click tracks*. This means that, if the orchestra is supposed to start sneaking the music in at some point *ahead* of where the singers sing or where the piano plays, we have found some way to lay down on the piano track (track three) either metronome clicks or someone's voice counting in the tempo of the upcoming music cue an exact number of bars (say, eight) prior to the downbeat of that vocal or piano music on track one or three. In other words, the orchestra conductor is given pre-information on his earphones pertaining to upcoming music cues. Again, inserting these click tracks must be done before the orchestra arrives on the scene, and they are inserted onto the piano track . . . or any other track that will not be heard on the final program.

So we are now playing in a sel sync mode, track one and track three to the orchestra headphones as we record their music on track two. In case of an error and they want to do a certain cue again, we merely rewind our four-track tape and do it again, and again, until someone declares that we have a good take. We do this one cue at

Now our four tracks are loaded with stuff which we'll eventually send back to v.t.r.

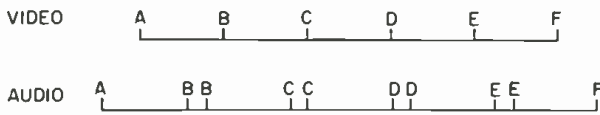

Figure 6. The v.t.r. operator is left with two reels of two-inch video tape. One is complete and continuous; the other is merely complete.

a time, until the entire program is scored.

This having been done, we pay attention to a handy hint: transfer (by dubbing) the piano of track three and the sync of track four to a quarter-inch two-track tape and file it away until the program has been labeled *ready for air*. This is just in case someone decides to re-do the music after we have wiped the piano off track three. This move wouldn't be necessary if either we had more free tracks or we didn't need track three to record the necessary sound effects.

On Wednesday we put these effects on track three as we set sync track one for cuing them in. Now our four tracks are loaded with stuff which we'll eventually send back to v.t.r.

Notice that on track one we have many takes of dialogue, only some of which have been designated as good takes, and under these we have laid down our music and effects. FIGURE 3 represents a random segment of our four-track tape, and it can be seen that under some of the good dialogue we have music, under some we have effects, and at other times we have both. The sync pulse goes on continuously throughout the entire tape, for it exists at the input of our record amplifier on track four at all times. Those periods where our tape (and the video tape as well) was getting back up to speed for a new take after having been stopped following a preceding take, is represented by the shorter empty segments between the dotted lines.

We have one more operation to complete before we transfer our work over to video tape. This consists of a dub-down of tracks one, two, and three to a composite mono. (Yes, television is still broadcast in mono!) We dub the good takes only, going from our four-track tape to a clean two-track quarter-inch tape, as shown in FIGURE 4.

Now we are ready to send this composite audio to video tape, and again, we need not worry about our audio tape machine (now a two-track) running slightly faster or slower from one playback to the next. It is only important to note that the sync pulse, as transferred over to the bottom track of this two-track tape, will always stay in the same relationship to the composite program on the top track, simply because it is locked onto the same piece of tape. Naturally, if one slows down, so does the other, at the same rate. Don't lose sight of the fact that we originally received the sync signal on Monday from the same generator that drove the video tape machine as the actors were being recorded, so we are, at the same time, constantly referring to picture.

Under other methods we might, at this point of transferring audio over to picture, resolve the sync on our audio tape against the source from which it was taken. In that way we would be assured that our playback speed would match the record speed. But, as stated, we are going to let v.t.r. do our resolving for us. We are going to play our audio tape machine right off the line frequency avail-

able from the nearest wall outlet, and let the video tape recorder be a slave to it. Any random variation in our playback will produce a similar variation in the video tape recorder, as follows: We feed our two tracks to the video tape room where the technician there will direct them as shown in FIGURE 5. While there are several techniques available to him, he will probably lay our audio onto a separate piece of video tape containing, not the desired picture of Monday's program but, pre-recorded color bars (or just plain black) so that this video tape will have the normal v.t.r. sync pulse on its control track. Then, by setting his motor drive selector to *ext* as shown, the control track of his machine will make that machine follow precisely the external reference, which in this case is the pre-recorded sync pulse from our bottom audio track. The "invisible resolver" being put to use here is a servo circuit associated with the control track and drive motor, which is an integral part of v.t.r. operation whether separate audio is involved or not.

When the transfer is completed, the video tape operator takes his machine motor drive off the *ext* setting and restores it to *auto* (which gives the motor a drive frequency of 59.95 Hz). He now has two v.t.r. machines in front of him which are set to *auto* and will resolve to the same frequency control: one containing his edited picture and another containing his newly received un-edited sound. Because his machines are once again referring to a frequency that is common to each, they will run together. All the operator has to do is to find a common start mark and push a common start button. To use an analogy to the same work in the film industry, the v.t.r. editor is making use of electronic sprocket holes in order to lock picture and sound together.

There is one thing left unfinished here. The picture is edited in one continuous piece from beginning to end, while the sound is not. All we have done with the sound in our transfer from four-track to two-track is to eliminate all the bad takes by transferring only the good takes in the proper order, leaving a random amount of space between each transferred good take. Therefore, after we finish transferring our composite audio, which has been done in segments, from our two-track to video tape, the v.t.r. operator is left with two reels of two-inch video tape. The one containing the picture is complete and continuous from the beginning of the program at point A to the end at point F, as indicated in FIGURE 6, while the sound on his other reel is merely complete, not continuous. To finish the job, he now has to transfer one segment at a time from the video tape containing sound to the video tape containing picture. This is a simple though time-consuming matter which, when completed, gives him a continuous program, picture with synchronous sound on one tape.

There are more sophisticated methods for recording television sound separate from picture and getting them together again. Some computerized installations available are most comprehensive in the operations they can perform, such as search, retrieve, preview, partial edit, A/B rolls, simultaneous audio-video dissolves, pre-instructed special effects, and numerous other closure functions. These systems are expensive, and management in general is trying to decide if such high-priced sophistication can pay its own cost and steal business from competitors at the same time. Meanwhile, what we have looked at here is a simple way of putting sync to work in television audio, using equipment that is standard in most studios. We have taken advantage of the fact that video tape machines are ready-made to do the resolving normally delegated to specialized audio equipment. Next month we'll look at other sync methods whereby we don't lean so heavily on the frequency control generated for video tape machines. ■

Any random variation in our playback will produce a similar variation in the video tape recorder . . .

Four-Channel Stereo Broadcasting

Experiments on four-channel broadcasting are now going on. Does this mean an imminent start to standardized broadcasting? Where are we now?

Each of the mentioned systems claims a degree of compatibility relative to stereo (and mono) playback of encoded discs.

Right now you can buy . . . encoders to put you on the air in four-channel stereo . . .

OVER THE LAST several months, a number of radio and t.v. stations have experimented with four-channel stereo broadcasts. Among these have been the use of two separate f.m. stereo stations to carry front and back information (with a t.v. station carrying picture and mono-mix sound).

With the proliferation of matrix quadrasonic systems—some of which are already offering decoders to the public—some broadcast experimentation has begun in this vein. That is, several stereo f.m. stations, using discrete quadrasonic program material, are broadcasting through an encoder. The home listener is thus receiving a quadrasonic broadcast provided he has the requisite decoding equipment and four-channel listening setup at home. The stereo listener is hearing a more-or-less compatible mix signal of the quadrasonic signal, and the mono listener is getting what he already gets—a sometimes good and sometimes not so good mix.

THE SYSTEMS

At present, several matrix systems are proposed; most are, in fact, on the consumer marketplace. Of these, I will single out only a few—since they are in viable use. The Dynaco system uses a simple passive decoder to recover four-channel information from encoded discs. Gately Electronics is manufacturing an encoder for use by recording companies and radio stations.

The Dynaco decoder is in wide use by consumers as it also has the ability to synthesize certain ambiance and

signal effects from stereo sources to produce a quadrasonic listening effect that many find pleasing. Both Dyna and Lafayette Electronics are selling the passive decoder box. Additional speakers (but not amplifiers) are required. To my knowledge, no one is presently broadcasting this system, nor is there much in the way of quadrasonic encoded disc material available.

Electro-Voice is promoting a different matrix system designed by Feldman-Fixler. E-V is producing both encoders and decoders. The encoders are in a number of recording studios, and the active-circuit decoders are available through high-fidelity dealers and (under their own label) through the Allied/Radio Shack chain. Several record companies do in fact have encoded discs. The most prominent label is Project 3, but all told, there are probably less than a dozen or so records available from all the labels.

Of course, you do not need an encoder to broadcast quadrasonic sound from these sources. You just need to play the records in conventional stereo and any of your listeners with appropriate decoders will get the effect they want.

Sansui is also making and selling a matrix-type decoder and they have a system of their own. A number of stations have experimented with the encoder to produce broadcasts, using discrete four-channel material as their source. There are no encoded discs, but the manufacturer is promising them.

Both the Electro-Voice and Sansui decoders also have

. . . CBS encoded material will not be decoded at all by E-V and Dynaco type decoders.

It rather leaves you in a quandry as to which system to use for experimentation. . . .

the ability to function as quadrasonic synthesizers from stereo sources, so they are selling respectably well.

CBS

Over the past few months, CBS Laboratories and Columbia Records have been quietly showing their version of a matrixed disc. It is now officially unveiled. In many ways it is similar in concept to the Electro-Voice system, though the chosen parameters of performance are different. For example, where E-V chooses to sacrifice some L to R front separation for improvements in front to back etc., CBS chooses to maximize front L to R at the sacrifice of some quadrasonic performance characteristics. These are made up for in a deluxe decoder by using gain-riding logic circuits to squelch unwanted channel information—thus providing the effect of maximum separation all around.

Electro-Voice decoders are not presently available with gain-riding logic additions, but this is expected shortly.

The net result of this is that both CBS and Electro-Voice, at least, have the potential of achieving the same quadrasonic capabilities. The presently constituted Dynaco system can not, nor can the Sansui. This is not to say that these systems could not be made with gain-riding logic circuits and thus equal the separation potential in playback of the E-V and CBS systems.

STEREO COMPATIBILITY

Each of the mentioned systems claims a degree of compatibility relative to stereo (and mono) playback of encoded discs. And this is important to broadcasters as there will be few quadrasonic listeners at first, and many stereo, and still more mono listeners for some time to come.

As to encoded software, I have already mentioned the limited supply of E-V discs on several labels. Dynaco, as I said, has no labels as of this writing. Nor has Sansui. Then comes CBS with the might of Columbia Records.

At this writing (in mid-July) there are no Columbia (or other) labels producing CBS-encoded discs. CBS does have a sample encoded disc, but there is no hardware (to be produced this fall by Sony Corp.) with which to decode it. CBS has stated that it expects to have at least 50 titles on the market (encoded disc albums) by the end of the year. They also expect to interest other labels into adopting their system.

QUADRAPHONIC COMPATIBILITY

Here is the rub. Suppose you want to get on the air with quadrasonic broadcasting in your area and you decide to opt for the available Dynaco (through Gately Electronics) or Electro-Voice encoders and play programming from live pickup (have you got a quadrasonic console?) or discrete four-channel reel tapes and tape cartridges—of which there are some on the market. If you use either of

The Dorren system . . . has a potential of providing an excellent quadrasonic signal.

these two encoders, listeners with *either* Dynaco or E-V decoders will get a quadrasonic program. (It should be stated that the compatibility of these two systems is only approximate and that only the decoder owners with the proper brand of decoder will get the correct decoding on a consistent basis.)

The CBS system will also have decoders for the broadcast and recording industries. The catch is that CBS encoded material will not be decoded at all by E-V and Dynaco type decoders. I don't know, but I can guess, that CBS is also not compatible with the Sansui system.

It rather leaves you in a quandary as to which system to use for experimentation, and I certainly will not go out on a limb to suggest that only one of these systems is viable over a long period. Perhaps none of them are.

OTHER SYSTEMS

A report on broadcast four-channel potentials cannot avoid mention of the JVC disc, which has been demonstrated, and the Dorren broadcast system which also have been tried—with some success. But I have avoided direct discussion of these two systems, because they are outside the run of everyday recording and playback situations as well as outside present broadcast standards. Put briefly, the JVC disc is capable of extremely good quadrasonics. It requires a phono cartridge with some response up to 45 kHz, since that frequency is used as a carrier of the quadrasonic information. Playing a disc with a 45 kHz signal on it might present some real problems to f.m. stations with stereo or s.c.a. signals on the air.

The Dorren system is a system for f.m. quadcasting that can provide an excellent quadrasonic signal. But, at the risk of oversimplifying its problem to the broadcast industry, it requires F.C.C. approval and changes in f.m. transmission. It would require a shift of the s.c.a. frequencies. In short, merit notwithstanding, it (like the JVC disc) is not likely to see rapid acceptance on the broadcast scene. No one seems to be making JVC encoded discs in this country anyway (JVC is producing them in Japan. A report may have reached you that RCA in this country would be making JVC encoded discs. This story was widely circulated. RCA's official and strong denial did not get such wide coverage.)

So, in sum, both the JVC disc and the Dorren broadcast systems can be counted out as significant factors in the four-channel race—at least for the time being. Don't lose sight of them altogether, though.

WHERE IT'S AT

Right now you can buy, at prices that are not outrageous, encoders to put you on the air in four-channel stereo—if

If you use either of these two encoders, listeners . . . will get a quadrasonic program.

you want to originate from discrete four-channel program sources. Such encoders are available from Gately (Dynaco system), Electro-Voice, and Sansui.

Or you can avoid buying an encoder and only play encoded material. If you chose to play a program of Dyna or E-V encoded discs, you will make owners of either system's decoders happy. In the next few months you will be receiving CBS encoded discs. These will not make E-V and Dynaco decoder owners happy at all.

The important point of all this is that an encoded disc, be it E-V, Dyna, or CBS will not make your *stereo* or *mono* listeners unhappy because each of them, when not decoded provides a satisfactory mix of back channels to the front stereo (and thence to mono) channels. That one system may do this somewhat better than others is not too important. They will all do it.

So by playing these discs you will not violate F.C.C. requirements; you will not upset present listeners; and you will not have to spend a penny on new equipment, unless you want an encoder to send out programs from original discrete programs.

In coming months we will provide information on the working of these systems. And we will also be looking at the whole question of four-channel recording.

It's not just a question of mixing down from the master to four channels instead of two. ■

Problems of Mono Stereo Broadcasting Compatibility

A mono signal of broadcast quality is not always produced by the simple combination of stereo information channels. In this article designed to inform the broadcast engineer of the present-day problems this problem is explored.

THE PROBLEM of deriving a good mono signal from a stereophonic source has existed almost as long as there has been stereo. Compatibility problems crop up anytime a mono signal is derived from a stereo source. Today, the proponents of four-channel sound are recognizing that compatibility will play a major role in deciding which four-channel system will capture the market.

Most of the literature dealing with compatibility has discussed the problem from the point of view of the record manufacturer who has control over his product rather than the broadcaster who must work with that product. This article will discuss the nature of the compatibility problem, its causes, and possible remedies.

The most common areas of difficulty in tracking or in electrical summations include:

- 1) tracking a stereophonic disc with a mono pickup;
- 2) filter effect of microphones poorly placed or out of phase;
- 3) shift in musical balance or intent between solo vocal and instrumental (sometimes called center channel buildup);
- 4) partial or total loss of special effects;
- 5) azimuth and tape handling problems unnoticeable in stereo.

TRACKING

Tracking a stereophonic disc with a monophonic pickup is of concern to record companies. For several years the problem was avoided by releasing records in both mono and stereo, but recent efforts to eliminate this expensive double production have brought it into sharp focus. When a stereo disc is reproduced with a mono pickup, *i.e.*, a pickup designed to reproduce only lateral modulation, distortion and/or damage to the disc's groove is the result.^{1,2} Mono pickups are designed to reproduce lateral modulation.

Eric Small is chief engineer of WOR-FM in New York City. At the time of this writing, he was in a similar capacity at radio station WNCN a N.Y.C. f.m. outlet. In slightly modified form this article is one that originally appeared in Broadcasting Transactions of the IEEE Volume BC-17, Number 2, June 1971 and is republished with permission.

Any difference in phase or amplitude between left and right channels will produce some degree of vertical component. It should be noted that the vertical component in disc recording is analogous to the 38-kHz l-r subcarrier in stereophonic broadcasting.

One technical solution to ease the tracking problem has been the use of low-frequency crossover. This technique makes use of the psychoacoustics principle that sound localization tends to take place at higher frequencies.⁴ Since many tracking problems are from low-frequency signals with large excursions, systems have been devised which reduce separation between channels at these low frequencies. The signal then becomes effectively mono, or lateral, and is easily tracked.^{3,5} However, there is a drawback to this system—when crossover begins at a high enough frequency to be really useful, it effects stereo directivity or localization.

Working in the record companies' favor has been the gradual shift from mono playback systems to almost entirely stereo. Mono systems still being sold tend to come with stereophonic pickups strapped for mono.

For broadcasters the message should be clear—all pickups should be good quality stereo. Although strapping for mono at the pickup is perfectly acceptable, it is recommended, especially for contemporary music stations, that a stereo pre-amp be used and summation take place after amplification. The reason for this will become clear later.

MICROPHONE PLACEMENT

In a "legitimate" (two channel) stereo recording situation, microphones are set for good stereo sound, which is often better than anything that is naturally heard. No one bothers to listen to a left-plus-right mono. The effect of poor microphone placement on some musical instruments such as the piano and organ far from point sources can be awful. The piano will sound thin and reedy, and random notes will disappear from the organ. FIGURE 1 illustrates this.⁵ Microphone distances are shown a half wavelength, or odd multiples thereof, apart, different for either the fundamental or a key overtone.

The result when the two microphones are summed is partial or complete cancellation. In commercial multi-channel recording (4 to 16 tracks) the problem is avoided by acoustic isolation between each group of instruments and its associated microphone. Positioning of sound on the

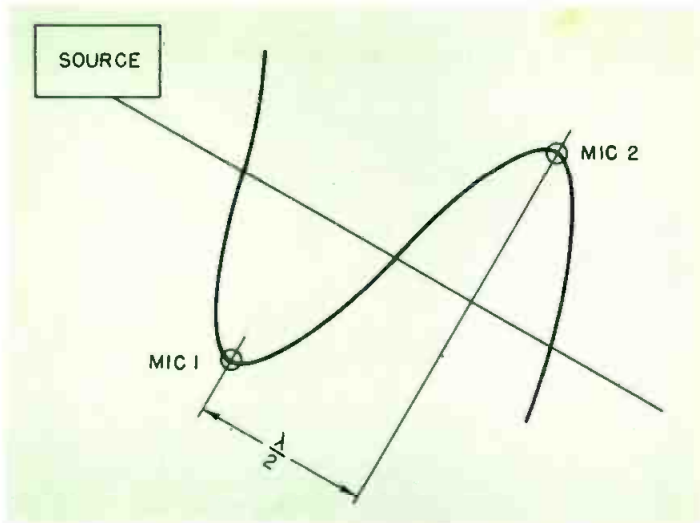

Figure 1. Mic distances are shown a half wavelength apart.

acoustical stage is done electrically with pan pots in mixdown sessions.

In a typical tape presented by amateurs to a station for broadcast, two microphones were spaced widely apart and both positioned for maximum pickup of everything. The mono sum was ghastly. The remedy for such tapes is brutal—select the individual channel which sounds best and use it as a mono source. The phasing remedies, to be discussed later, will change the frequencies of cancellation, but not eliminate the problem.

CENTER CHANNEL BUILDUP

The compatibility problem which is probably causing the most current consternation to the recording industry is esthetic balance shift between mono and stereo.⁵ To appreciate this problem, a knowledge of how contemporary record productions—the industries' "bread and butter"—is needed.

A typical arrangement for a recording session, involving a lead vocalist with assorted instrumentalists behind him, is shown in FIGURE 2. Note that no single source of sound appears on more than one channel. In practical studio situations the instrument-to-instrument isolation is on the order of 20 dB.

Depending on the studio, the producer, and astrological sign of the second sitar player, some arrangement of microphones feeding individual channels on a multitrack tape machine should be used. When selections are recorded on multitrack, the live session is complete and the engineer and producer move on to the mixdown.

In a mix console each fader position is fed by a separate channel of the live session tape. The fader positions include equalization, compressors, and often positioning

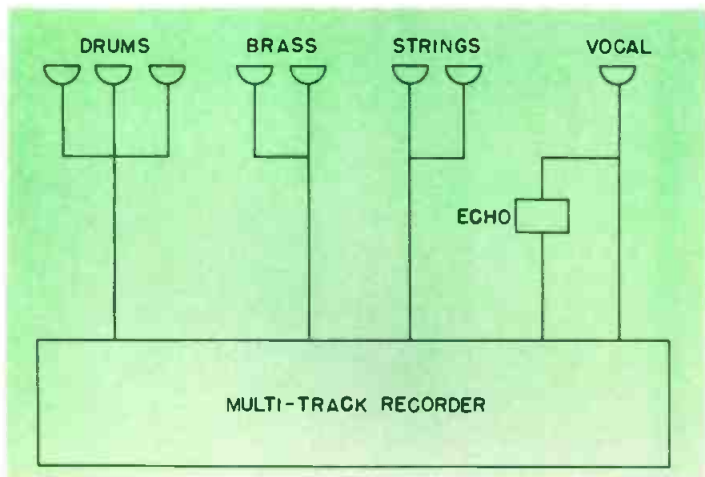

Figure 2. A typical recording setup for modern multitrack.

pots. The mix console winds up with a two-channel output which is recorded on a conventional two-track 1/4-in. tape for disc mastering.

To allow maximum artistic freedom and to avoid a host of technical problems, no single sound source appears on more than one track. In other words, the live session tape is a collection of mono signals. All positioning on the auditory stage is done by adjusting levels between left and right channels. A vocalist can be placed dead center by splitting the vocal track 50-50 right to left. The sound source may be positioned anywhere between the speakers by adjusting the ratio of the split using a pan pot. (FIGURE 3 illustrates pan pot action.)

The compatibility problem comes about because identical information—the equal vocal on both channels—adds differently in a real acoustic situation than in electrical summation. In a typical room the signals will be added at random to produce a sensation approximately 3 dB louder than either individual speaker. In electrical sum-

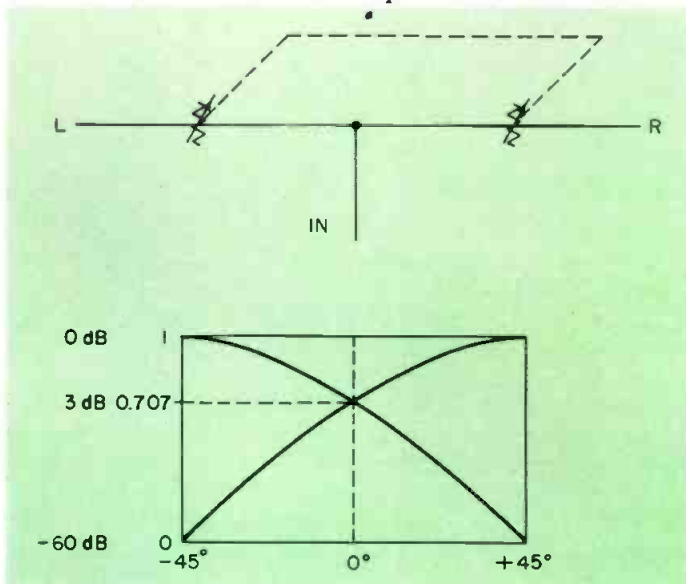

Figure 3. The action of a pan pot.

mation the two signals, being equal in phase and amplitude, will add in a coherent manner to produce a 6-dB increase. Since balancing between vocal and accompaniment is done in the stereo mix session, the extra 3 dB gained in electrical summation will cause the vocal to drown out its accompaniment in a mono summation.

A 90-degree phase-shift network, with limitations, is one way to overcome this problem and produce a good mono.

SPECIAL EFFECTS

Special effects are an expected part of rock music, and many of the techniques are innocuous from a compatibility standpoint. Some, like rapid panning from channel to channel and special reverberation effects, would simply be lost in mono, but with no degradation of the musical material. Others, such as placing an instrument or a vocalist out of phase to some degree, would result in partial or complete cancellation of that item.

AZIMUTH AND TAPE HANDLING

One problem over which broadcasters have a good deal of control is tape handling and machine azimuthing.

An azimuth error, unnoticeable when listening in stereo, would result in a drastic loss of high frequency when the channels are summed.^{6,7,9} Flutter is similarly magnified. Professional stereo cartridge machines are chronic offenders in this area, and it has only been with the rising popularity of f.m. stereo that machine and cartridge manufacturers have begun work on tape handling problems.

High-speed duplicated stereo four-track tapes, cassettes,

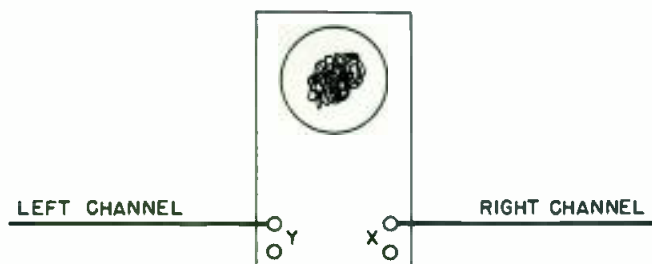

Figure 4. Connection of a scope to show phase relationships of channels.

and eight-track cartridges on the whole all have such record azimuth problems as to make them unreliable program sources. Even two-track 1/4-in. high-speed duplicates, of the type common in broadcast syndication, often show severe cancellation, pointing up the need for constant quality control.

Azimuth and tape handling problems can be dealt with at the station level. All incoming stereo tapes should be spot checked by listening to the mono sum of a broad spectrum material. Applause is useful because any cancellation shows up as a pronounced barrel effect.

When azimuthing reel-to-reel and cartridge machines, the peak should be set while watching the summed signal rather than individual channels. This procedure will also give a good indication of how well the machine is handling tape.

THE RECORD COMPANY

Until recently, disc mastering limited the potential for discs with compatibility problems resulting from out of phase material. Since out of phase information is cut as vertical modulation, its tendency to lift the stylus off the acetate blank made phasing incompatibility very unpopular with mastering engineers. A new generation of computer-controlled disc mastering lathes has appeared, which by the use of tape preview heads can anticipate difficult cutting situations and make the necessary trade offs between groove spacing, modulation, and depth of cut to permit the mastering of almost anything that can be taped.⁵

With the likelihood of a recording being uncuttable lessened, with fewer mono phonographs around, and with greater pressure for a new sound, segments of the record industry are moving away from the requirement that all records be unconditionally compatible. The day is rapidly approaching when the a.m. and f.m. broadcasters will be the only users of mono material. Mono 45 rpm singles are still popular, but stereo singles are starting to appear.

The increasing availability of various tape formats will pose a serious problem if they must be broadcast. Wide azimuth tolerances and the problems inherent in duplicat-

ing tapes at speeds up to 240 in/sec often produce tapes that are not acceptable in mono, but sound fine in stereo, which is all the manufacturers ever wanted.

The broadcaster is caught in a squeeze between diminishing numbers of mono releases and increasing numbers of incompatible records. The problem is especially serious with name groups who are less concerned with radio exposure than with having the most current sound.

Contemporary recordings are unique. They represent art forms in themselves. Stereophonic recording has changed from capturing a live performance to a tool in the creation of a performance, which can exist only in an electronic medium.

In many ways it is difficult to fault the record producers. Why should they consider the radio user unless radio is a necessary part of promoting the release?

STEREO BROADCASTING

The stereo broadcaster is caught in the dilemma of simultaneously transmitting stereo and mono. Most of the methods used to make a good mono pollute the stereo.

It has been suggested that a 90-degree phase shift be inserted for all stereo material broadcast to eliminate many mono-sum problems. However, it would create two serious problems. Any material intentionally placed in the acoustic center by being recorded equal in phase and amplitude on both channels would appear to spread across the auditory stage. Certain musical instruments would be pulled from their intended positions.⁶

A large portion of the information in a stereo recording is nearly equal in phase and amplitude, and therefore uses a minimum of 38-kHz l-r subcarrier. A 90-degree phase-shifter scrambles the coherence between left and right channel information. The result is nearly equal l-r as $l + r$ signal. The 38-kHz subcarrier will average 50 per cent modulation, detracting from the main channel. In addition, the added 38-kHz energy might cause sca crosstalk.

REMEDIES

A growing amount of incompatible material will have to be broadcast. Steps can be taken to maintain an acceptable sound.

Identification of problem material is necessary. Listening is the simplest and most accurate test. If it sounds good in mono on a wide range playback system, then material will sound good on the air. A stereo station should be able to check material in either mono or stereo to facilitate a — b comparison.

An oscilloscope can aid in correlating what is heard with what is taking place electrically. Connected so that left and right drive the X and Y channel amplifiers (FIGURES 4 and 5), Lissajous figures will indicate the instantaneous phase relationship between audio channels. By rotating the crt so that X and Y make a 45-degree angle with the horizontal, the beam will trace the motion of a stylus in a

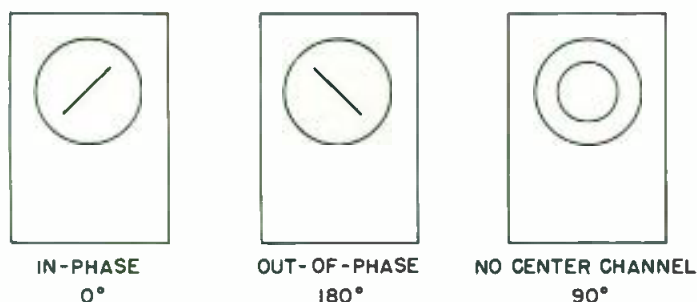

Figure 5. Typical displays of the setup of Figure 4.

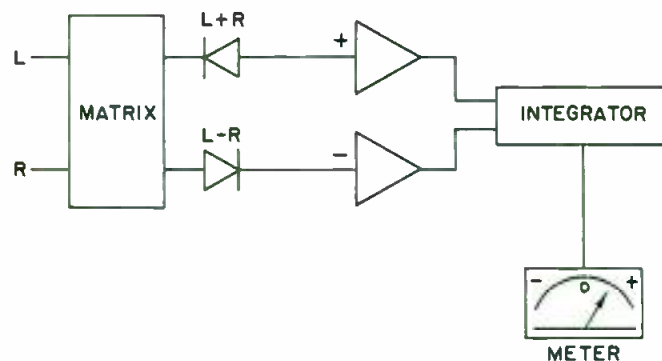

Figure 6. A proposed phase meter.

groove.¹⁰ The scope is informative, but it requires experience to interpret the display and relate it to a specific problem.

An easy to interpret phase meter can be constructed using a four-port hybrid, some d.c. amplifiers, an integrator, and a zero center meter. The stereo is split into $l + r$ and $l - r$ components, each of which is rectified on opposing polarity. The d.c. signals are amplified and summed across the integrator. The meter will indicate the ratios of in-phase and out-of-phase components. (See FIGURE 6.)

There are corrective techniques for incompatibility arising from phase difficulties. A 180-degree phase switch located in one channel before the summation point is useful. I use two patch positions wired with tip and ring interposed. Using a 180-degree shift sometimes creates more problems than it solves, but it is worth trying.

Mixing stereo to mono is often an effective technique. Each channel of the stereo is fed to a separate fader (here is where having stereo pre-amps helps) before summations. One channel may be removed or reduced quickly, thus preventing a segment from cancelling.

A much discussed device is the 90-degree frequency-independent phase-shift network. Actually two networks that maintain a constant difference of 90-degrees, they can be very useful in eliminating center channel buildup and in preserving special effects. In these applications stereo is fed into the network and the outputs are summed. In azimuthing or mic placement problems, the network would only shift the cancellation frequencies around, not eliminate them. Anyone interested in building such a network is referred to the Orban circuit.¹¹

CONCLUSIONS

Incompatibility between stereo and mono will be an increasing problem with contemporary music. Once the problem is identified, there are several techniques that will enable deriving acceptable mono from stereo.

The stereo broadcaster is limited in possible corrective action by the need to maintain a good stereo sound. Additional work in this area is needed.

ACKNOWLEDGMENT

The author is indebted to William Wiltschko of Yale University for his valuable technical criticism and his delivery of this paper at the 20th Annual IEEE Broadcast Symposium in place of the author. The encouragement of Tom Bird, WNCN's Station Manager, is gratefully acknowledged, as is the flawless typing and editorial assistance of Miss Pat Giles. ■

BIBLIOGRAPHY

- 1 J. J. Bubbers, *Compatible disc playback*, db Sound Eng. Mag., vol. 2, July/Aug., 1968, pp. 16-17.
- 2 I. J. Sobel and R. Knuebel, *Compatibility of stereo recordings and monaural playback*, J. Audio Eng. Soc., vol. 17, Apr. 1969, pp. 143-146.
- 3 S. Feldman, *Phono disc compatibility*, db, Sound Eng. Mag., vol. 4, May 1970, pp. 24-27.
- 4 F. K. Harvey and M. R. Schroeder, *Subjective evaluation of factors affecting two-channel stereophony*, J. Audio Eng. Soc., vol. 9, Jan. 1961, pp. 19-28.
- 5 J. M. Eargle, *Stereo/mono disc compatibility: A survey of the problems*, J. Audio Eng. Soc., vol. 17, June 1969, p. 276.
- 6 F. K. Harvey and E. H. Uecke, *Compatibility problems in two-channel stereophonic recordings*, J. Audio Eng. Soc., vol. 10, Jan. 1962, pp. 8-12.
- 7 D. Green, *Compatible disc recording*, db, Sound Eng. Mag., vol. 4, May 1970, pp. 27-29.
- 8 L. Hulko, *How disc masters are made today*, Audio, vol. 53, Nov. 1969, pp. 26-29.
- 9 *Monophonic compatibility of programming from stereophonic sources*, CCIR Study Groups, Period 1966-1969, Doc X/157-E, May 9, 1969.
- 10 B. B. Bauer and G. W. Aioles, *Stereophonic patterns*, J. Audio Eng. Soc., vol. 8, Apr. 1960, pp. 126-129.
- 11 R. Orban, *Broadband network circuits*, J. Audio Eng. Soc. (Let.), vol. 18, Aug. 1970, pp. 442-443.

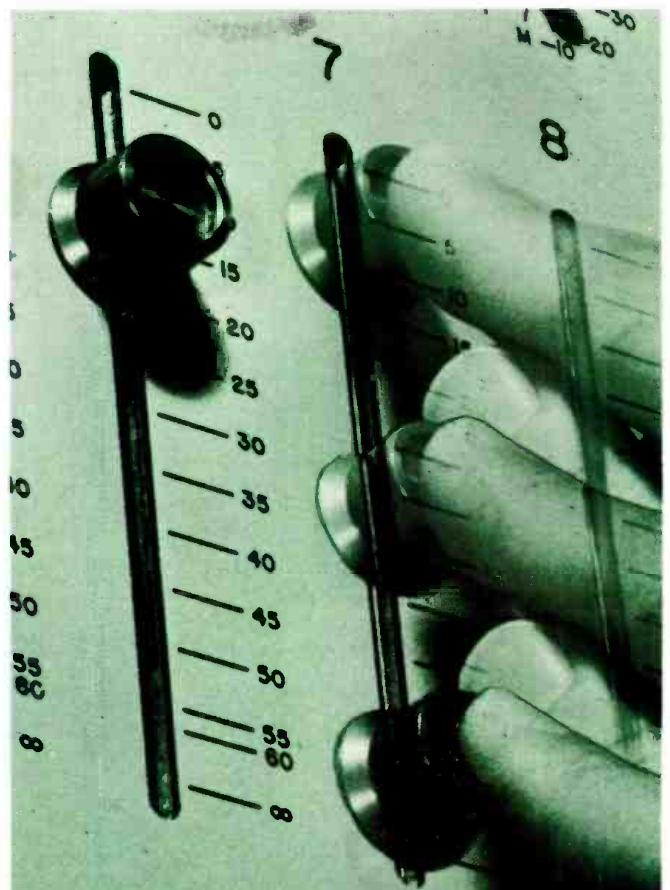

Slide Actuated Pots

Duncan Electronics 230 linear travel slide actuated potentiometer combines infinite resolution with long life — and at low cost. The series 200 design features "touch-sensitivity," enabling the operator to feel the action without disturbing the smoothness of motion. They are used widely in audio control consoles for the recording and broadcast industries, commercial sound systems and (with SCRs) as "dimmers" in lighting controls. Key features include: single or dual resistance elements, linear or audio tapers, standard tap positions, all-metal housing. Write for new free catalog!



DUNCAN ELECTRONICS
SUBSIDIARY

SYSTRON  **DONNER**

2865 FAIRVIEW ROAD □ COSTA MESA, CALIFORNIA 92626
PHONE: (714) 545-8261 □ TWX 910-595-1128

Circle 23 on Reader Service Card

BOOKCASE

As a service to our readers we are pleased to offer these books from prominent technical publishers. All prices listed are the publishers' net. Shipping charges are included. Use the coupon at the bottom of the page or give the complete title, author and coupon number. Be sure to indicate quantity on the special instructions line if more than one copy of a title is wanted. Full payment must accompany your order. We cannot ship c.o.d. Checks or money orders should be made payable to Sagamore Publishing Company, Inc. Because of the time required to process orders, allow several weeks for the receipt of books.

Radio Engineering Handbook, 5th Ed.
Henney. Prepared by a staff of specialists, this working manual of radio science provides information on each of the branches of radio engineering, with emphasis on working practice, final working formulas, dimensions, and actual useable circuits.
1959. 1,800 pp. \$31.50
Circle 36 on Coupon Below

Radio Transmitters
Gray and Graham. Provides, in a logical, easy-to-understand manner, a working knowledge of radio transmitters for quick solution of problems in operation and maintenance.
1961. 462 pp. \$16.00
Circle 40 on Coupon Below

Electronic and Radio Engineering, 4th Ed.
Terman. A thorough coverage, in easy-to-understand terms, of those principles and techniques which are the basic tools of the electronic and radio engineer. 1955. 1,078 pp.
\$19.50
Circle 39 on Coupon Below

The Technique of the Sound Studio
by Alec Nisbett. This is a handbook on radio and recording techniques, but the principles described are equally applicable to film and television sound. 264 pages; 60 diagrams; glossary; indexed; 5 1/2 x 8 1/2; clothbound.
\$13.50
Circle 1 on Coupon Below

Radio Broadcasting
edited by Robert L. Hilliard. Each of the five chapters has been written by a prominent educator with an extensive background of practical experience in commercial and educational broadcasting. 190 pages; 6 1/4 x 9 1/2; indexed; clothbound.
\$6.95
Circle 2 on Coupon Below

Transistors for Audio Frequency (Audio-Frequency Amplification)
by Guy Fontaine. 1967. This systematic and detailed treatment of the application of transistors in audio-frequency amplifiers shows how the published transistor characteristics are related to the principles of design. An ideal textbook or reference on the subject for engineers and advanced technicians. 384 pages; 5 1/2 x 8; illus.; clothbound.
\$7.95
Circle 12 on Coupon Below

Closed-Circuit Television Handbook
by Leon Wortman. Gives comprehensive detailed information about the field in an easy-to-understand presentation, suited to those who plan to use, install, and service cctv. 288 pages; 5 1/2 x 8 1/2; clothbound.
\$5.95
Circle 18 on Coupon Below

An Alphabetical Guide to Motion Picture, Television, and Videotape Production
Levitan. This all-inclusive, authoritative, and profusely illustrated encyclopedia is a practical source of information about techniques of all kinds used for making and processing film and TV presentations. Gives full technical information on materials and equipment, processes and techniques, lighting, color balance, special effects, animation procedures, lenses and filters, high-speed photography, and much more. 1970. 480 pp. \$24.50
Circle 35 on Coupon Below

Integrated Circuits
Motorola. This complete, authoritative volume of design and construction techniques for modern integrated circuits covers theory, thin-film techniques, diodes, transistors, thermal design, and other vital aspects.
1965. 373 pp. \$13.75
Circle 30 on Coupon Below

Basic Bibliography of Science and Technology
McGraw-Hill. Important to the researcher, librarian, or student, this reference book lists and describes over 8,000 outstanding books in every scientific and technical field. A topical index organizes all subject headings into about 100 general categories enabling the reader to locate quickly the listings which pertain to his field of interest.
1966. 738 pp. \$19.50
Circle 34 on Coupon Below

Noise Reduction
Beranek. Designed for the engineer with no special training in acoustics, this practical text on noise control treats the nature of sound and its measurement, fundamentals of noise control, criteria, and case histories. Covers advanced topics in the field.
1960. 752 pp. \$19.50
Circle 33 on Coupon Below

The Audio Cyclopedia (2nd ed.)
by Dr. Howard M. Tremaine. New and updated, here is the complete audio reference library in a single volume. It provides the most comprehensive information on every aspect of the audio art. This new edition includes the latest audio developments including the most recent solid-state systems and integrated circuits. It covers all subjects in the fields of acoustics, recording, and reproduction with more than 3400 related topics. Each topic can be instantly located by a unique index and reference system. More than 1600 illustrations and schematics help make complicated topics masterpieces of clarity. 1760 pages; 6 1/2 x 9-3/8; hardbound.
\$29.95
Circle 20 on Coupon Below

Circuit Design for Audio, AM/FM, and TV
Texas Instruments. Texas Instruments Electronics Series. Discusses the latest advances in electronic design and application which represent the results of several years research and development by TI communications applications engineers. Emphasizes time- and cost-saving procedures throughout. 1967. 352 pp. \$14.50
Circle 32 on Coupon Below

Acoustics—Room Design and Noise Control
by Michael Rettinger. 1968. The enormous problems and hazards presented by noise are dealt within an orderly and practical manner. With many charts, graphs, and practical examples, the text covers the physics of sound, room acoustics, and design, noise and noise reduction. 392 pages; hardbound.
\$17.50
Circle 21 on Coupon Below

Sagamore Publishing Company, Inc.
980 Old Country Road, Plainview, N. Y. 11803
Please send me the books I have circled below. My full remittance in the amount of \$..... is enclosed. N.Y. State residents add 6% sales tax.
1 2 3 4 5 6 7 8 9 10 11 12 13 14 15 16 17
18 19 20 21 22 23 24 25 26 27 28 29 30 31 32
33 34 35 36 37 38 39 40

Name

Street Address

City State Zip

Special Instructions

Canada and foreign: Add \$1.00 per book

Acoustical Tests and Measurements
by *Don Davis*. Provide a solid understanding of the entire subject of acoustical measurements; based on actual field test work, using commercial equipment. 192 pages; 5 1/2 x 8 1/2; hardbound. **\$6.95**
Circle 7 on Coupon Below

Television Broadcasting
Chinn. A practical, compact technical guide to the equipment, systems, facilities, good engineering practices, and operating techniques of television broadcasting. 1953. 695 pp. **\$17.00**
Circle 37 on Coupon Below

Handbook of Electronic Tables & Formulas, (3rd edition)
A one-stop source for all charts, tables, formulas, laws, symbols, and standards used in electronics. Includes an 8-page, full-color fold-out chart showing latest FCC allocations for the entire frequency spectrum. 232 pages; 5 1/2 x 8 1/2; hardbound. **\$5.50**
Circle 8 on Coupon Below

Handbook of Broadcasting, 4th Ed.
Abbott and Rider. This non-technical handbook sets forth clearly and thoroughly the fundamentals of radio and television broadcasting. Over 100 illustrations amplify the text. 1957. 531 pp. **\$9.50**
Circle 38 on Coupon Below

Electronic Musical Instruments
by *Richard H. Dorf*. Now in its third edition and sixth printing since its first appearance in 1954, this is considered the authority on electronic organs. 393 pages; 239 diagrams and photographs. **\$10.00**
Circle 19 on Coupon Below

Intermodulation and Harmonic Distortion Handbook
by *Howard M. Tremaine*. A complete reference guidebook on audio signal intermodulation and harmonic distortion. 172 pages; 5 1/2 x 8 1/2; softbound. **\$4.25**
Circle 9 on Coupon Below

Solid-State Electronics
Hibberd. A Basic Course for Engineers and Technicians. An extremely practical reference book for anyone who wants to acquire a good but general understanding of semi-conductor principles. Features questions to answer, problems to solve. 1968. 169 pp. **\$9.95**
Circle 31 on Coupon Below

Practical PA Guidebook: How to Install, Operate and Service Public Address Systems
by *Norman H. Crowhurst*. 1967. This book gives all the basics needed to become a successful PA operator, in any situation where the reinforcement, relay, or distribution of sound can provide a service. 136 pages; 6 x 9; illus.; softbound. **\$4.50**
Circle 15 on Coupon Below

CLASSIFIED

Closing date is the fifteenth of the second month preceding the date of issue. Send copy to: Classified Ad Dept.
db THE SOUND ENGINEERING MAGAZINE
980 Old Country Road, Plainview, New York 11803

Rates are 50¢ a word for commercial advertisements. Non-commercial and employment offered or wanted placements are accepted at 25¢ per word.

FOR SALE

RECORDING CONSOLE, Altec 9200 series, 100% solid state, one year old, in service six months. Ten input modules, four master modules, one PanPot module, one monitor control module, one talk back slate module with mike, twenty-six 9740 A amplifiers, three 9550 A power supplies: \$10,500. Also available in factory-sealed cartons, ten additional input modules and eight 9740 A amplifiers. Contact **Claude Hill**, chief engineer, **Glaser Sound Studios, 916 19th Avenue, South, Nashville, Tennessee. Telephone (615) 327-0005.**

AMERICA'S LARGEST SELECTION of new and used broadcast and recording equipment! Latest bulletins available. **The Maze Corporation, P.O. Box 6636, Birmingham, Ala. 35210.**

WHATEVER YOUR EQUIPMENT NEEDS—new or used—check us first. Trade your used equipment for new. Write for our complete listings. **Broadcast Equipment & Supply Co., Box 3141, Bristol, Tenn. 37620.**

SCULLY TAPE RECORDERS—one to twenty-four track and model 270 auto players, many models in stock for immediate delivery. SCULLY LATHES—Previously owned and rebuilt. Variable or automatic pitch. Complete cutting systems with Westrex heads. MIXING CONSOLES—Custom designed using Wiegand Audio Lab modules. From \$7,000.00. **Wiegand Audio Laboratories, 3402 Windsor Road, Wall, New Jersey 07719. Phone: 201 681-6443.**

FERROGRAPH TAPE RECORDER, latest model 7 1/2, 3 3/4, two-track stereo tape deck in sealed carton: \$390.00. (212) 463-1222.

ONE STOP FOR ALL your professional audio requirements. Bottom line oriented. **F.T.C. Brewer Company, P.O. Box 8057, Pensacola, Florida 32505.**

SOLID-STATE AUDIO PLUG-IN OCTAL (1" Dia. x 2" H) modules. Mic preamps, disc & tape preamp-equalizers, tape bias osc & record ampl power amps & power supplies. Send for free catalog and audio applications. **Opamp Labs., 172 So. Alta Vista Blvd., Los Angeles, California 90036.**

NEW YORK'S LEADING supplier of professional recording equipment and hi-fi stereo components. All major brands in stock. Call for quote—sales—service—leasing—trade-ins. **Martin Audio, 320 West 46th Street, New York, N.Y. 10036. Telephone: (212) 265-6470.**

EMPLOYMENT

PROFESSIONAL RECORDING PERSONNEL SPECIALISTS. A service for employers and job seekers. Call today! **Smith's Personnel Service, 1457 Broadway, N.Y.C. 10036. Alayne Spertell 212 Wi 7-3806.**

WANTED — ELECTRO-ACOUSTICAL DESIGN ENGINEER for microphone and headphone development. Must be experienced engineer. Good growth potential in growing, profitable company. Locate in Minneapolis. Salary commensurate with experience and ability. Send resume to: **D. W. Flygstad, v.p. engineering, Telex Communications Division, 9600 Aldrich Avenue South, Minneapolis, Minnesota 55420.**

WANTED

JERRY BIELSKY of **Jerry Bielsky Sales Co., 12514 Califa Street, North Hollywood, California 91607** is seeking lines in the consumer hi-fi, distributor, and p.a. fields. We offer over 20 years in sales experience covering the southern California, Arizona, and Nevada markets. Our phone is (213) 985-1900.

PEOPLE, PLACES, HAPPENINGS



Eargle

● **John M. Eargle** has been appointed to the newly-created position of director—commercial sound products, for the **Altec Division of LTV Ling Altec, Inc.** In the announcement by **Don Davis**, vice president of marketing, Mr. Eargle was lauded as having an impressive list of credentials in the sound and communications field. He has just left his position as chief engineer of **Mercury Record Productions**. With a Bachelor of Music and Master of Music degree from the Eastman School of Music, and the University of Michigan, respectively; a Bachelor of Science degree in electrical engineering from the University of Texas, and a Masters Degree from Cooper Union, he brings a broad educational background to Altec. In addition, he has had past associations with Universal Recording in Chicago, the **RCA Record Division**, and several manufacturers of sound equipment.

● **Broadcast Electronics, Inc.** has announced the appointment of **Leo L. Darrigo** as marketing manager. He will head the company activities on the system level as well as development of market and product areas both domestically and overseas. Mr. Darrigo had been with **Visual Electronics Corp.** for over ten years most recently as international sales manager. Prior to Visual he served in several capacities with the broadcast service group of **RCA Camden**.

● The resignation of **Paul B. Ostergaard** from the firm of **Goodfriend-Ostergaard Associates** was announced by **Lewis S. Goodfriend**, the company president. The firm will continue without any interruption with its architectural and engineering staff providing professional consultation to its international clientele in architectural acoustics, products acoustics, and environmental noise control and evaluation.

● **CCA Electronic Corp.** has established a regional office for the Washington, D.C. area. **Walter Adams** has been appointed to head this office as regional sales manager with his former associations with **WJMD** and **WPGC** in the Washington area, he brings experience in the broadcast and government activities fields. The address of the new CCA office is **9131 Bradford Road, Silver Spring, Maryland 20901**.

● **Robert M. Kanner** has been named a vice president of **WMCA (New York City) Radio**. In the announcement by **R. Peter Straus**, president of the station, Mr. Kanner is made v.-p. engineering, a step up from his position as chief engineer. He has been with the station for ten years, beginning as a staff engineer, moving upward as an engineering supervisor, to his last position before the present one.

● **Infonics, Inc.** announces the election of **Paul Lloyd** as vice president—manufacturing. He comes to Infonics from a position as manager of quality control for **Leach Corporation of L.A.** where he headed a seventy-man department concerned with q.c. of the Apollo space program tape recorders and other precision instruments. Mr. Lloyd has been with Infonics since September 1970 and has been in charge of factory operations since then.

● At the recent annual meeting of the **National Council of Acoustical Consultants**, the following officers and directors were elected: president—**Robert Lindahl** (Trénton, Michigan); vice president—**Kenward S. Oliphant**, (San Francisco, Calif.); secretary-treasurer—**O. L. Angevine, Jr.** (East Aurora, N.Y.); directors—**Michael J. Kodaras**, **David McCandless**, and **George P. Wilson**.

● Recording industry sales representatives have been appointed for the **3M Company** line of professional audio equipment. This equipment includes the 1-, 2-, 4-, 8-, and 16-track recorders and accessory items heretofore sold directly. The newly-appointed representatives are: **Flickinger and Associates**, Hudson, Ohio; **Sound 80, Inc.**, Minneapolis, Minn.; **Harvey Radio Company**, N.Y.C.; and **Auditronics, Inc.**, Memphis, Tenn.

● An announcement from **Audio Designs and Manufacturing, Inc.** tells of the appointment of **Jon R. Kelly** as national sales manager, a newly-created post. In this position he will be responsible for all marketing activities of the company, including field sales, advertising, and sales promotion. Mr. Kelly was previously with **Electro-Voice, Inc.** where he was active in the development and promotion of the firm's four-channel matrixing equipment.

● **Emerson Cartrivision** is a new color video tape recorder-player to be introduced by Emerson Television next fall. The Emerson system will be compatible with the Cartrivision system produced by **Cartridge Television, Inc.**, a subsidiary of **Avco Corporation**. In addition to receiving both color and black and white telecasts, the new Emerson unit can video record directly from on-air television programs, video record live from a black and white or color camera and play pre-recorded and homemade cartridge tapes. The unit will feature, as optional equipment, a black and white or color camera for home movie making. The camera, equipped with a 5 to 1 zoom lens, will be accompanied by a portable microphone for sound video taping.

● Two new directors of engineering have been appointed in the **Altec Division of LTV Ling Altec, Inc.**, it was announced by **J. J. Noble**, senior vice president, engineering of the Anaheim facility.

Bob R. Beavers, formerly chief engineer for acoustics, and **Paul B. Spranger**, formerly chief engineer for electronics, were promoted effective February 1, 1971.

Beavers received his Bachelors degree in geophysics in 1953 from the University of California at Berkeley. He spent six years with the **Standard Oil Company of California** before joining **LTV, Inc.**, at the **Western Research Center in Anaheim** where he was manager of transducer systems. He is a member of the Acoustical Society of America and the Audio Engineering Society. Spranger received his Bachelor of Science degree in Electronics Engineering from Pacific State University. Prior to joining Altec in 1967, he had 16 years experience in supervision and management of military and commercial electronics. He holds numerous patents in electronics and musical sound products.

For technical sound recording everything points to Revox

Separate spooling motors of original high torque, low weight construction.

Sealed mains input section and cabinet safety link socket.

Fully electronically stabilised power supply circuit.

Capstan motor servo control panel maintaining speed accuracy to better than 0.2% and incorporating electronic speed change from $7\frac{1}{2}$ to $3\frac{3}{4}$ ips.

Capstan motor of patented construction, cool running, low current consumption and wow and flutter better than international broadcast requirements.

Professional practice glass-fibre panel with integral gold-plated switch contacts.

Unique multi-bank micro-switch unit, providing on-off, speed and spool size/tension variations on one control.

Plug-in record relay.

Plug-in 120 Kc/s bias oscillator obviates multiplex interference.

Plug-in audio input/output amplifiers.

Read head of capstan motor.

Tape transport logic control circuit panel.

Plug-in relays controlling all functions and eliminating damage from inadvertent mis-handling.

New from the Willi Studer Factory comes the revolutionary Model 77 incorporating design developments based on experience gained in the broadcast field with the 37 and 62 Series Studer machines. The 77 is a studio quality machine compactly presented and offering features unique in this price class including total

Write or telephone for further information to:—

REVOX delivers what all the rest only promise.

Revox Corporation, 155 Michael Dr., Syosset, N. Y. 11791
1721 N. Highland Ave., Hollywood, Calif. 90028
In Canada: Tri-Tel Associates, Ltd., Toronto, Canada

indifference to fluctuations in mains supply periodicity. With a wow and flutter level below broadcast standard requirements plus a linear response from 20-20,000 Hz at $7\frac{1}{2}$ ips. (± 2 db) and an ultra low noise level, this new Revox will fulfill virtually every scientific and industrial requirement in the sonic band.



Circle 11 on Reader Service Card

mca tech

the versatile group

Well-known performers — each a technical and creative specialist in electronics. Result — the range and quality that makes for success. We can help you get it all together, from the smallest switch or component to complete custom recording studio systems.

AUDIO CONSOLES — Electrodyne is expertly staffed to design, engineer and fabricate broadcast and production systems to meet your exact requirements — with the finest quality and highest reliability available anywhere built into every product.

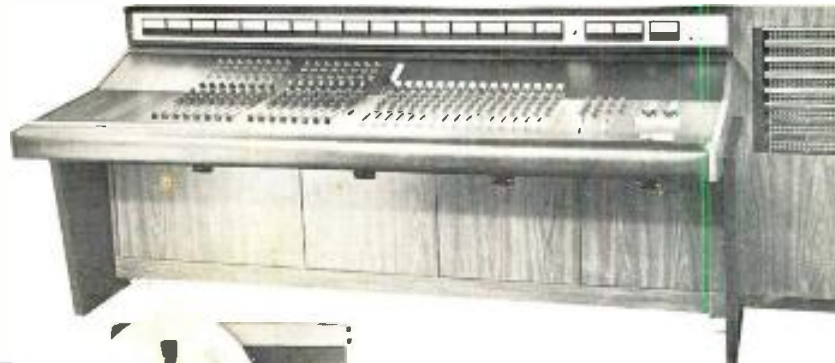

ELECTRODYNE'S DIGITAL STOPWATCH DC1000 — Here in one package are all the features wanted for precision timing of minutes and seconds at a moderate cost. It will count forward or backward and stop at 00:00. Can be preset to a selected number and count up or down from there. All integrated circuit logic; no moving parts. Remote control and dress cabinet are optional features. Engineered and tested to guarantee unflinching reliability.



GRAPHIC EQUALIZER INPUT MODULE by ELECTRODYNE — This most recent addition to the product group is an input module with control of 9 frequencies simultaneously — with microphone preamplifier, isolated echo send and ultra low noise straightline attenuator. The 712L provides you with the most sophisticated audio channel ever attained in one plug-in unit.



THE LANGEVIN TR-100 SERIES TAPE TRANSPORT is designed and built to provide the professional broadcaster with a highly reliable, long play, bi-directional, tape playback unit. The transport uses a dual-speed, hysterisis-synchronous capstan motor, resulting in low wow and flutter characteristics. Automatic reversing is accomplished through foil contacts on either end of the tape. Cut-off arms are provided adjacent to both tape reels, and a connector on the rear panel is also provided for remote control of the unit.



THE LIMITER/COMPRESSOR AM-7A by LANGEVIN is a high quality gain reduction and peak limiting device for use with speech or music inputs. It may limit only, or limit in combination with compression. It features fast attack time and release time with low distortion. It has a three-position de-essing circuit. A stereo system may be provided by connecting 2 units in parallel using the stereo sync terminals provided. It is designed to accept low level inputs and is self-powered.

LANGEVIN'S BC-8A BROADCASTER CONSOLE features 24 inputs (8 Full Stereo and 8 NEMO), stepless faders, separate program and audition outputs, solid-state modular plug-ins, 2 power supplies with switching for fail-safe operation, stereo/mono input selector keys, separate cue amplifier and lobby feed amplifiers, 5-position monitor select switch and amplifiers, equalizers for Program, Audition and Monaural outputs. There is a choice of microphone input preamplifiers and separate monaural outputs switchable between Simulcast and Independent inputs.



mca tech
an mca inc. company

Corporate Offices:
Langevin, Electrodyne, Gauss
13035 Satcoy Street, No. Hollywood, Calif. 91605 U.S.A.
Telephone (213) 875-1900

ELECTRODYNE — GAUSS — LANGEVIN — OPTIMATION — SAKI — UDAC

Circle 12 on Reader Service Card