

KUGW RADIO
325 COMMUNICATIONS BLDG
D S 50 -BLDG
UNIV OF WASH
SEATTLE WA 98105

May 7-10
Los Angeles
California

AES
SHOW
ISSUE

THE SOUND ENGINEERING MAGAZINE
APRIL 1974 \$1.00

Q110



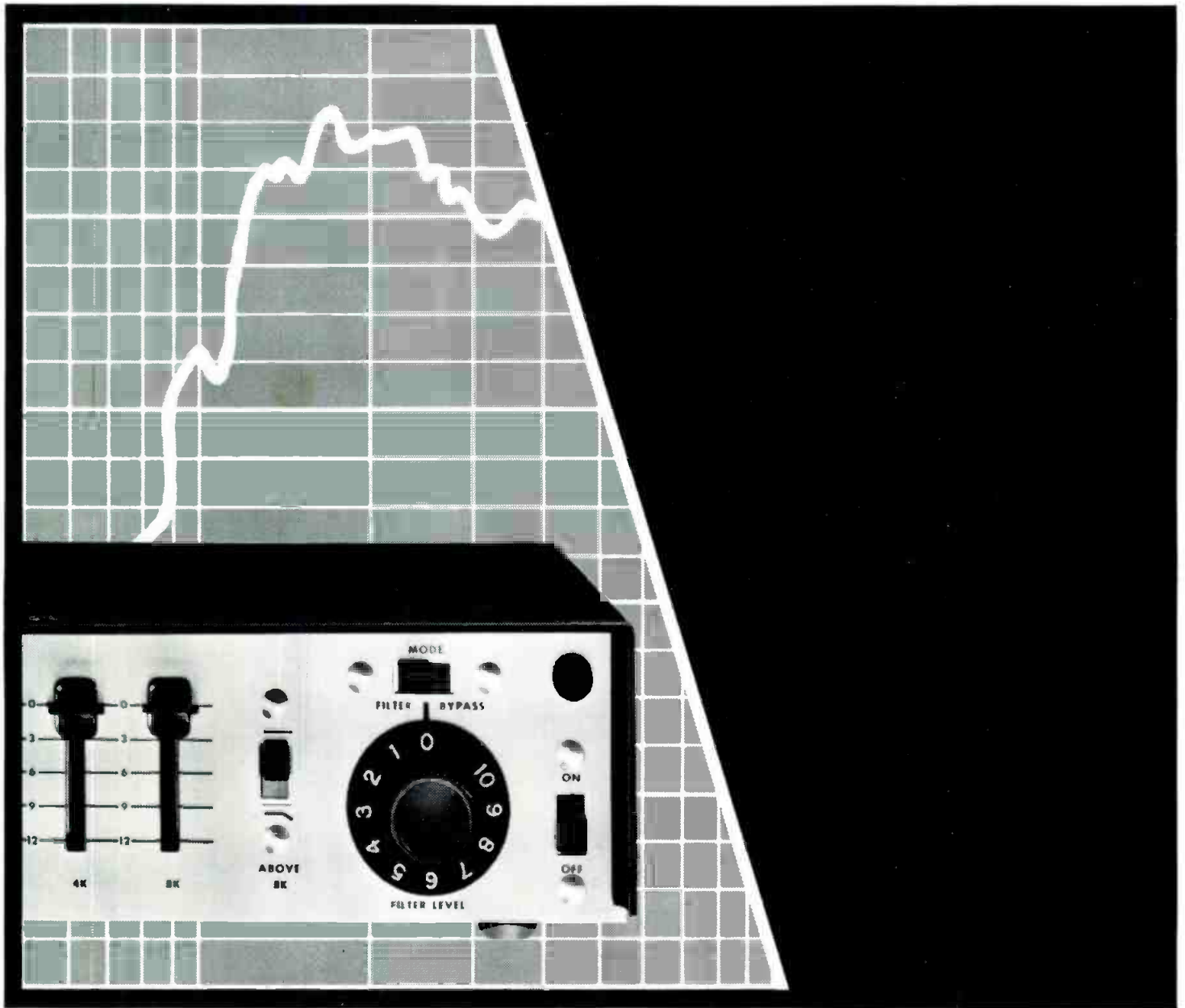

The feedback buck stops here.

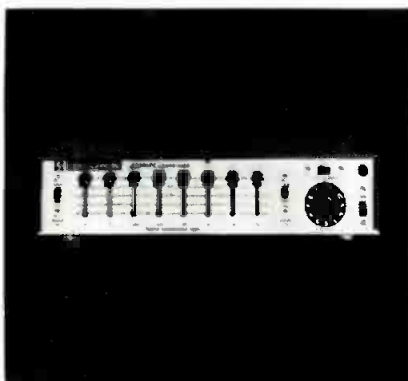

They said it couldn't be done, but our engineers developed a simple, low-cost component to give sound reinforcement systems *increased gain with reduced feedback danger!* The Shure M610 Feedback Controller utilizes eight resonant dip filters and high- and low-end roll-off switches which enable the user to "tune" system response to room acoustics, maximizing output and minimizing feedback. Convenient filter level control allows increase of system gain as filters are adjusted. Use the M610 to control feedback in any acoustic environment; use it to filter problem frequencies that cause ringing, boominess or other troublesome resonances. Yours for \$117.00, user net. Write:

Shure Brothers Inc.
222 Hartrey Ave., Evanston, Ill. 60204
In Canada: A. C. Simmonds & Sons, Ltd.



Circle 10 on Reader Service Card

COMING NEXT MONTH

● Don Davis will conclude his two-partner on Impedance begun in this issue. Start it on page 38 and finish it in the May issue. It is a definitive statement on the perplexing problems of impedance and impedance matching.

We came back from the Audio Engineering Society's 47th Convention and Exhibition held in Copenhagen, Denmark with pictures and an interesting story on what's happening in European audio. A sidelight trip from the Convention took us to the Orto-phon laboratories where disc recording equipment is manufactured as well as the plant in which this company makes its phono cartridges. This will be the subject of a *db* VISITS in addition to the AES report being prepared.

And there will be our regular columnists: Norman H. Crowhurst, Martin Dickstein, and John Woram. Coming in *db*, *The Sound Engineering Magazine*.

ABOUT THE COVER

● The woodcut depicted is part of a series of 137 old German woodcuts entitled the Triumph of Maximilian. The series celebrates the dreams and aspirations of Emperor Maximilian 1459-1519. Mindful of the energy shortage this caravan is getting an early start for Los Angeles.



THE SOUND ENGINEERING MAGAZINE

APRIL 1974 VOLUME 8, NUMBER 4

28	A NOTE FROM THE PUBLISHER
30	THE DECIBEL: BASICS, part 2 A. Oscar Burke
36	AES-LA CONVENTION PROGRAM AND MAP
38	IMPEDANCE MATCHING FOR THE SOUND ENGINEER, part 1 Don Davis
4	LETTERS
8	THE SYNC TRACK John Woram
14	THEORY AND PRACTICE Norman H. Crowhurst
omitted this month	SOUND WITH IMAGES Martin Dickstein
20	NEW PRODUCTS AND SERVICES
48	CLASSIFIED
50	PEOPLE, PLACES, HAPPENINGS

db is listed in Current Contents: Engineering and Technology,

Robert Bach PUBLISHER	Larry Zide EDITOR
Bob Laurie ART DIRECTOR	John Woram ASSOCIATE EDITOR
A. F. Gordon CIRCULATION MANAGER	Hazel Krantz COPY EDITOR
Eloise Beach ASST. CIRCULATION MGR.	Richard L. Lerner ASSISTANT EDITOR
GRAPHICS Crescent Art Service	

db, the Sound Engineering Magazine is published monthly by Sagamore Publishing Company, Inc. Entire contents copyright © 1974 by Sagamore Publishing Co., Inc., 980 Old Country Road, Plainview, L.I., N.Y. 11803. Telephone (516) 433 6530. *db* is published for those individuals and firms in professional audio-recording, broadcast, audio-visual, sound reinforcement, consultants, video recording, film sound, etc. Application should be made on the subscription form in the rear of each issue. Subscriptions are \$6.00 per year (\$12.00 per year outside U. S. Possessions, Canada, and Mexico) in U. S. funds. Single copies are \$1.00 each. Controlled Circulation postage paid at Harrisburg, Pa. 17105. Editorial, Publishing, and Sales Offices: 980 Old Country Road, Plainview, New York 11803. Postmaster: Form 3579 should be sent to above address.



**the first
reel to reel
with the rugged
reliability of
itc**

The makers of premium quality tape cartridge equipment in the reel-to-reel market? It had to happen! The result is what you, Mr. Broadcaster, have been looking for. All the features you demand plus a few innovative optionals of our own. And all with the rugged reliability inherent in the International Tapetronics name. Check out these plusses in your own studios. We offer a 30 day guarantee of satisfaction plus a one year warranty. Just call collect and say you want to try the "850" series. We'll do the rest.

Phone 309-828-1381



**INTERNATIONAL
TAPETRONICS CORPORATION**

advertisers index

Altec	26, 27
Audio Devices	41
Audiomatic	43
Audio-Technica	8
Bose	21
Chromacord	46
Electro-Sound	11
Electro-Voice	Cover 4
Frap	14
Garner	12
Gotham Audio	9
Heil Sound	32
Inovonics	25
International Tapetronics	2
James B. Lansing	34, 35
Lexicon	15
Orband-Parasound	33
Polyline	19
Ramko Research	4
ReVox	20, 22, 24
Russco	19
Scott Instrument	10
Shure	Cover 2
Soundcraftsmen	6
Spectra-Sonics	14
Standard Tape	6
Stanton Magnetics	7
Tascam	3, 13
Telex	5
Timekeeper	Facing Page 1
UREI	45
Westlake Audio	17, 18
Woram Audio	21

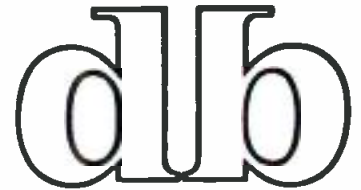

THE SOUND ENGINEERING MAGAZINE

SALES OFFICES

New York
980 Old Country Road
Plainview, N.Y. 11803
516-433-6530

Dallas
Roy McDonald Associates, Inc.
Stemmons Tower West
Suite 714
Dallas, Texas 75207
214-637-2444

Denver
Roy McDonald Associates, Inc.
3540 South Poplar Street
Denver, Colorado 80237
303-758-3325

Houston
Roy McDonald Associates, Inc.
3130 Southwest Freeway
Houston, Texas 77006
713-529-6711

Los Angeles
Roy McDonald Associates, Inc.
500 S. Virgil
Suite 360
Los Angeles, California 90020
213-381-6106

Portland
Roy McDonald Associates, Inc.
2035 S. W. 58th Avenue
Portland, Oregon 97221
503-292-8521

San Francisco
Roy McDonald Associates, Inc.
Baybridge Office Plaza, Suite 265
5801 Christie Avenue
Emeryville, California 94608
415-653-2122



Series 70 Recorder/Reproducers

When you've got more talent than money

TASCAM Series 70 recorder/reproducers were designed for people who've outgrown high-end consumer audio products but can't afford full professional studio gear.

Whether you need single, two or four channels, you define the Series 70...it doesn't define you. Your choices are expanded instead of restricted without paying a performance penalty.

The versatile Series 70 electronics come in two versions, one for direct recording and one for use with a mixing console like our Model 10. Either way you'll find uncommon quality and reliability.

Series 70 recorder/reproducers. When you've got more talent than money.



Circle 14 on Reader Service Card

Buy the best at any cost— even if it costs you less!

Broadcast and audio engineers around the nation have chosen Ramko products on performance specs alone. Then were pleasantly surprised at our low, low prices.

Compare Ramko performance yourself. Free 10-day evaluation period and 2-year warranty guarantee you get the best.

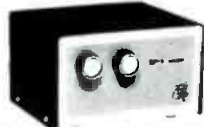

TURNTABLE PREAMPS
MP-8 \$72 (Mono) SP-8 \$114 (Stereo)

Outstanding sensitivity and incomparable reproduction. RIAA/NAB equalized ± 1 db. 0.5mv sensitivity (internally adjustable) at 1kHz for -4 dbm out. $+20$ dbm out max. Balanced 125/600 ohm outputs. -73 db S/N referenced to 10mv @ 1kHz. 0.075% or less distortion. External terminals for brilliance, rolloff or RIAA equalization. 140mv @ 1kHz headcom. Internal power supply. MP-8 Mono. SP-8 Stereo. Tabletop or bracket mount. Shipping weight 4 1/2 lbs.



DISTRIBUTION AMPLIFIERS DA-6 \$109
(Rack Mount Available)

Individual output amps provide maximum isolation. ± 0.5 db response. 10Hz to 20kHz. 26db gain. Balanced bridging or matching input. Six balanced 600 ohm outputs. $+20$ dbm out max. Output level control. 0.1% or less distortion. Internal power supply. Tabletop or bracket mount. Shipping weight 4 lbs. Other models feature output metering and up to 32 outputs, \$138 to \$425.



AUTOMATIC CART & CASSETTE LOADERS
ACL-25 \$159
(Speed & Tone Sense Options Available)

At last automatic Precision winding at a price you can afford! Eliminates guesswork because dials set tape length to the second! The exact amount of tape is fed onto the cart or cassette, then it is shut off automatically. Exclusive torsion control for proper tape pack and winding of various hub sizes. TTL digital control circuitry. With speed or tone sense options. \$266 to \$350. Shipping weight 30 lbs.



STUDIO MONITOR AMPLIFIERS
SMA-50 \$105
(Rack Mount, Mono & Stereo Options)

Exceptional reproduction! Internal muting. ± 1 db response. 20Hz to 40kHz. 25w music power, 50w instantaneous peak power, 15w rms. Hum and noise. -65 db below rated output. Distortion less than 1% at 15w rms; typically below 0.25% at less than full power. Load impedance, 4, 8, 16 ohms; input balanced bridging, 100kohms. Variable base contour. Internal overload protection. Internal power supply. Tabletop or bracket mount. Rack units, \$128 to \$169. Shipping wt. 6 lbs.



MIC/LINE AMPLIFIERS
MLA-1 \$84 (Mono)
MLA-2 \$112 (Stereo or Dual Mono)

Dual function utility amps. Inputs for mic and/or line. ± 0.5 db response. 10Hz to 20kHz. Mic input -65 db for $+4$ dbm out. Balanced inputs on high-level and mic channels. Balanced 600 ohm out. $+20$ dbm out max. 0.1% or less distortion. Internal power supply. Tabletop or bracket mount. Shipping weight 4 lbs.



COLLIMETERS
(Precision Tape Head & Guide Alignment)
Standard, C-II \$15 Multi-Cart, C-IV \$19

A Ramko exclusive! Designed by Ramko to speed up tape head and guide alignment on all cart machines. Now used by more than 5,000 engineers. Unique combination of optical and electro-sensing elements allows you to precisely adjust Height, Zenith, and Azimuth on all cartridge machines.

ORDER TODAY FOR 10-DAY TRIAL PERIOD.
Compare Ramko performance yourself.



Ramko Research Professional Audio Products

3516-B LaGrande Blvd., P.O. Box 6031
Sacramento, California 95860 (916) 392-2100

letters

The Editor:

Gilfoy Sound is extremely fortunate in having two Studer tape recorders, a B-62 in portable case and an A-80 in console. Both of these machines were purchased last year from Gotham Audio Corporation, who has been the sole importer of Studer for many years. Over these years, Willi Studer has grown tremendously and as of January 1, 1974, Studer opened its own sales and service offices in the United States, Willi Studer of America, located in Depew, N.Y., a suburb of Buffalo.

Now Studer is well known for its standard of quality, but as luck would have it, our A-80 developed a cold solder short in the head nest about three weeks ago. We called Steve Temmer at Gotham and he advised us to send the heads directly to Studer of America for service. By the way, this set of heads were of the wider gap European standard type which affords better s/n ratio but is not standardized with American machines. We didn't hear anything for the first few days after sending the head stack off airmail-special-handling. Indeed, we found out that the post office was somewhat slower than they should have been. In the meantime, our main mastering machine sat gathering dust here in Bloomington, Indiana, which is a long way from any kind of professional help!

Last Saturday, my chief engineer, Mark Hood, got a call from Bryan Tucker, the Studer representative in Chicago. Mr. Tucker announced that he and Bill Woods, president of Studer of America and Bruno Hochstraser, Studer engineer, were ready to climb into the Studer private plane



Telex tape duplicating equipment...you start with what you need, but you're never likely to outgrow it.

Every possible thought has been given in the design of the Telex tape duplicating system to make it a modular, step-by-step expandable system with the highest degree of flexibility we know of.

You can have cassette-to-cassette, reel to cassette, reel-to-reel or even cassette to reel duplicating. All this with true professional studio quality and all the commonly required head configurations available.

Simple, push button operation assures consistent top quality reproduction even with non-technical operating personnel.

Plug-in componentry makes the Telex system easily expandable in true "building-block" fashion.

Your Telex dealer can show you exactly what equipment you need and how economically he can satisfy that need.

Write Telex Communications, Inc., 9600 Aldrich Avenue South, Minneapolis, Minnesota 55420.

PRODUCTS OF SOUND RESEARCH

TELEX
COMMUNICATIONS, INC.

Circle 21 on Reader Service Card

Simply

STL Test Tapes Are The Most Dependable And Accurate You Can Buy

These precision tapes are produced on precision equipment using exclusive production techniques to provide the most accurate reference possible. They are widely accepted by major manufacturers, governments and all who need a precision reference tool. Available in 1" and 2" sizes as well as flutter tapes and all other formats. Order STL test tapes and find out where your system really is. Write for a free brochure and the dealer in your area. Distributed exclusively by Taber Manufacturing & Engineering Co.

STL STANDARD TAPE LABORATORY, Inc.

2081 Edison Avenue
San Leandro, CA 94577
(415) 635-3805

Circle 25 on Reader Service Card

and fly to Bloomington, Indiana to get our machine back in operation immediately. Bryan also asked if it would be all right to install a new head stack, made to American specifications.

Two hours later, the three men from Studer landed at the Bloomington airport and were driven to my studio without any sightseeing delays. And only two hours later, the Studer gang was on its way home and Gilfoy Sound was back in operation. Indeed, this kind of service, stemming from well-founded pride and reputation, deserves full credit in the recording industry. One funny sideline—engineer Hochstraser did a great deal of muttering of technical stuff, in Swiss-German, of course. None of us could understand that German, but I am convinced that the Studer A-80 knew every word.

Jack W. Gilfoy
Gilfoy Sound Studios, Inc.
Bloomington, Indiana

Soundcraftsmen presents the new **RP10-12**
PROFESSIONAL EQUALIZER for RECORDING and PLAYBACK

PERFECT tailoring of octave-wide bands... Infinitely variable adjustment flexibility
... Special Effects programming ... Instant re-setting
via Computone-Charts

\$349.50 includes walnut grain cabinet, or rack-mount

Recording Studios • Audiophiles • Night Clubs • Performers • Theatres
Churches • Gyms • Auditoriums • Hi-Speed Duplicating • Musical Groups

SPECIFICATIONS

FREQUENCY RESPONSE: -1/4 dB from 20 to 20,480 Hz, 1dB down @ 10KHz, -8 dB down @ 100 KHz.
HARMONIC DISTORTION: Less than 0.8% @ 2V, 0.5% @ 1V. Typ: 0.1% @ 1V
ISI DISTORTION: Less than 0.8% @ 2V, 0.5% @ 1V. Typ: 0.1% @ 1V
SIGNAL-TO-NOISE RATIO: Better than 90 dB below 2V output. Typ. 95 dB
INPUT IMPEDANCE: 100K ohms - Operable from any source up to 100K ohms: any Mixer, Hi-Fi, Preamp, Receiver or Tape Recorder.
OUTPUT IMPEDANCE: 600 ohms - Operable into any Mixer, Hi-Fi Amp, Receiver or Tape Recorder.
INSERTION LOSS: Zero (slide controls centered, and "OUTPUT ADJUST" control set so that "input" equals "Output")
MAXIMUM OUTPUT: 7 V. in to hi impedance, 3.5 V. into 600 ohms - (-13 dBm)

SPECIAL FEATURES

VU METER: Precision ±.5% meter movement provides an accurate visual display, to enable exact unity gain input/output matching.
INDUCTORS: Toroidal and Shielded ferrite core.
CIRCUIT BOARDS: Military Grade G-10 glass epoxy.
RESISTORS: Low noise selected carbon film throughout.
SWITCH CONTACTS: Gold plated to assure low noise and reliability.
EQUALIZER SWITCH: Electrically removes the Equalizer from the circuit.
OUTPUT ADJUST: Controls a continuously variable 18 dB range from 12 dB to -6 dB, to match output to input.
RANGE: 12 dB boost and 12 dB cut, each octave centered at 30, 60, 120, 240, 480, 960, 1920, 3840, 7680 and 15,360 Hz.
SIZE: Walnut grained wood case 5 1/4" x 18" x 11". Rack-panel 5 1/4" x 19"

STEREO 20-12 \$299.50

MASTER OUTPUT LEVEL: "Frequency spectrum-level" controls for left and right channels, continuously variable 18 dB range, for unity gain.
HARMONIC DISTORTION: Less than 1%, THD @ 2 V, Typ. 0.5% @ 1 V.
ISI DISTORTION: Less than 1% @ 2 V, Typ. 0.5% @ 1 V.
SIGNAL-TO-NOISE RATIO: Better than 90 dB below 2V output.
INPUT IMPEDANCE: Operable from any source 100K ohms or less (any Hi-Fi Pre amp, Receiver or Tape Recorder).
OUTPUT IMPEDANCE: Operable into 3K ohms or greater (any Hi-Fi Amp, Receiver or Tape Recorder).
SIZE: Walnut grained wood case 5 1/4" x 18" x 11" or rack mount.

ALSO AVAILABLE the **20-12-600 . \$349.50**
SAME AS 20 12 ABOVE, EXCEPT HAS 600 OHM OUTPUT



Soundcraftsmen 1310 E. Wabash Ave. Santa Ana, Cal. 92705 Ph. 714 836-8375

Circle 27 on Reader Service Card

Copies of db on Microfilm

Copies of all issues of db—The Sound Engineering Magazine starting with the November 1967 issue are now available on 35 mm. microfilm. For further information or to place your order please write directly to:

University Microfilm, Inc.
300 North Zeeb Road
Ann Arbor, Michigan 48106
A subsidiary of Xerox Corporation

In addition to Microfilm Copies available through University Microfilm, we have a limited number of regular back issues available. You may order these copies at \$1.00 each from:

Circulation Department
db—The Sound Engineering Magazine
980 Old Country Road
Plainview, New York 11803



In response to the needs of the recording and broadcast industries, Stanton creates the new calibration standard ...the 681 TRIPLE E....

A definite need arose.

The recording industry has been cutting discs with higher accuracy to achieve greater definition and sound quality.

Naturally, the engineers turned to Stanton for a cartridge of excellence to serve as a primary calibration standard in recording system check-outs.

The result is a *new* calibration standard, the Stanton 681 TRIPLE E. Perhaps, with this cartridge, the outer limits of excellence in stereo sound reproduction has been reached.

The Stanton 681 TRIPLE E offers improved tracking at *all* frequencies. It achieves perfectly flat

frequency response to beyond 20 Kc. It features a dramatically reduced tip mass. Actually, its new nude diamond is an ultra miniaturized stone with only $\frac{2}{3}$ the mass of its predecessor. And the stylus assembly possesses even greater durability than had been previously thought possible to achieve.

The Stanton 681 TRIPLE E features a new design of both cartridge body and stylus; it has been created for those for whom the best is none too good.

Each 681 TRIPLE E is guaranteed to meet its specifications within exacting limits, and each one boasts the most meaningful warranty possible: an individual calibration test result is packed with each unit.

For further information write Stanton Magnetics, Inc., Terminal Drive, Plainview, N.Y. 11803.



STANTON

John M. Woram

THE SYNC TRACK

● Each year at this time, *db* seeks to expand its horizons somewhat, to cover some aspect of the audio scene beyond the confines of its usual format. It would be hard to pick a more appropriate topic than that curious psycho-electronic phenomenon known popularly as the Watergate Syndrome.

For years, musicians and producers argued that advancing technology encroached on the creative process. For just as many years, technologists have claimed this was not so; that technology was merely a tool, placed at the disposal of the recording art.

In the light of current events, there seems to be little point in continuing this fiction. Obviously, technology *is* taking over the creative process, and, in the highest circles, may have already taken over completely. Fortu-

nately, there is a remedy for the problem, which will be described later.

Consider the tape recorder for example. Years ago, an untrained operator could put some tape on a machine, press the record button, and not have to worry about what would happen next. Then came stereo, and later three-, then four-track recorders. Some skill was now required, but the operator remained master of the machine.

But as multi-track technology evolved, perceptive observers began to sense that something was not quite right. At times, the machines actually seemed to be taking over. Unexplained clicks and pops would appear on the tape as the record button was pressed, or when the machine stopped. Sometimes, tape speed would decrease

toward the end of a reel, indicating that the machine was conducting its version of a slowdown strike.

Still later, sophisticated logic circuits began appearing in many machines, but, as any honest technician can tell you, these circuits are rarely influenced by the wishes of the operator. Instead, the machine functions according to the whims of some overheated i.c.

At least one manufacturer claims he actually doesn't want to build these elaborate circuits into his product, but that his automated circuit assembly device is self-programming and beyond his control. Moreover, of the few design engineers left on his staff, none recall how to wire a switch so that it will start and stop a machine in the old fashioned manner.

According to a recent report, one multi-track studio is doing quite well by operating its latest tape recorder as a game of chance. For a dollar, clients are invited to press a button and guess what the machine will do. The studio is making a fortune.

One would think that the White House would step in with some sort of appropriate legislation to prevent things from getting out of hand. After all, since the President seems to be such a devoted amateur tape recordist, we might reasonably look to him for guidance.

Here, we come to crux of the Watergate Syndrome, for it appears as though the President himself is an innocent victim of the dreaded "Woods' Hole Effect," a devastating side effect of Watergate. Tape experts are well acquainted with this apparently uncontrollable phenomenon, in which recorded messages are mysteriously erased without human intervention. Even more baffling, the authorities are at a loss to explain why these erasures only occur during the more significant portions of the recorded program.

Worse yet, to the layman the erasures may appear to have been deliberate, thereby casting unfair suspicion on anyone known to have been near the suspect tape recorder. However, the truly objective enquirer will soon realize that Woods' Hole is completely beyond the control of man, since the erasures invariably occur well into the program. An erasure at the beginning or end of the tape might be ascribed to operator error, but when the lost segment is somewhere towards the middle of the program, it must be either a manifestation of Woods' Hole, or an intentional wipe-out by an unscrupulous person. Since the President himself has assured us, "I'm no crook!," the Woods' Hole Effect is

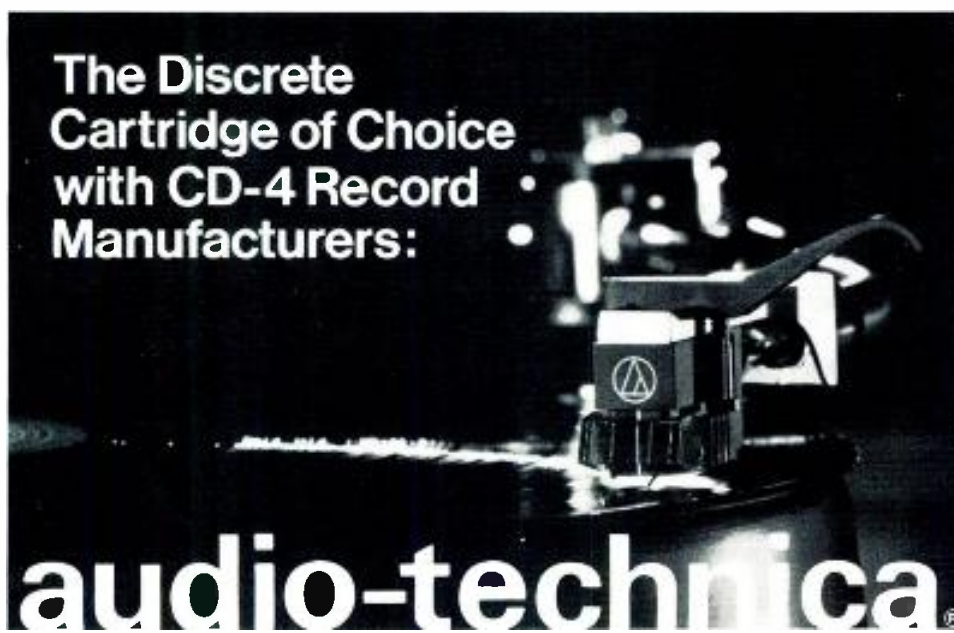

The Discrete
Cartridge of Choice
with CD-4 Record
Manufacturers:

audio-technica[®]

Whether listening to reference lacquers or checking metal "mothers" for quality, you'll find more Audio-Technica built cartridges in use than any other make.



Illustrated: Model AT14S with Shibata stylus, \$75.00,
mounted in AT-1009 Tone Arm, \$139.95.

AUDIO-TECHNICA U.S., INC., Dept. 44BD, 1655 W. Market St., Fairlawn, Ohio 44313

The reason is simple: Our consistent performance is essential to their quality control standards. Whether your CD-4 cartridge is for home or studio...if you've built up a tolerance for nothing but the finest, come to us.

Last summer we sent you our apologies. Now we can send you our EMT 240.

Sorry,
but you'll have
to wait for
the biggest
advance in
reverberation.

We've really been flooded with orders for the new EMT 240. So, we can't promise you delivery until Fall.

But we can promise you this, right now: The EMT 240 — even though it's approximately one-eighth the size of its EMT 140 predecessor, — provides a significant, audible reduction in sound coloration.

It will end, once and for all, any thought you've had that it's still necessary to compromise with quality in order to get reduced size.

And you don't have to whisper or tip-toe past the EMT 240. It's impervious to virtually every roar and rumble. So you can use it in your studio, control room, or on location.

Reverb time? It goes down to under one second.

Set-up time? Next to zero. It arrives pre-aligned, pre-tensioned — and, after unpacking, it's prepared to go to work.

Any other questions? Mail the coupon, we'll refer your inquiry to one of our selected franchised dealers. And we'll also send you a 6-page technical treatise on the theory behind this remarkable unit. So write today, won't you?



Send this coupon to your company warehouse and mail to us for the free treatise.

GOTHAM
AUDIO CORPORATION

Headquarters: 741 Washington St.
New York, NY 10014 Tel: (212) 741-7411

West Coast Sales Office: 1710 N. La Brea Ave.
Hollywood, CA 90046 Tel: (213) 874-4444

Please send me your complimentary technical treatise describing the theory behind the EMT 240.

NAME: _____

TITLE: _____

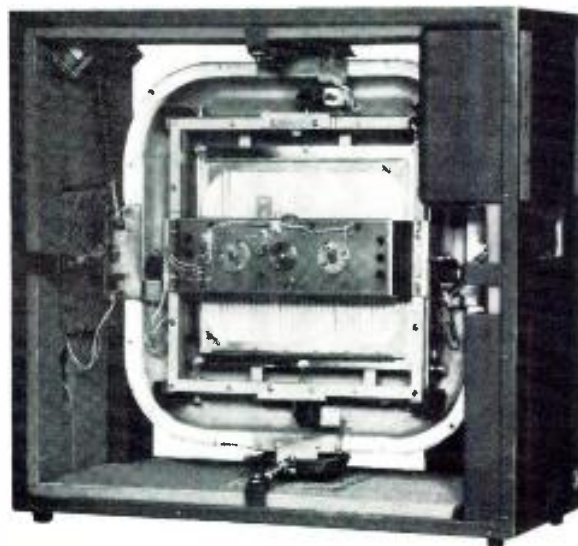

You *don't* have to wait any longer.

The last production wrinkles have been smoothed away. Gotham is currently shipping the equipment to long-time back-ordered clients. And, if *you* order the remarkable EMT 240 now, we can give you a definite delivery date.

Then you'll have the most advanced reverb unit available — compact, convenient, yet uncompromised in quality.

You'll see that it's only *one-eighth* the size of our EMT 140. But you'll hear a significant *reduction* in sound coloration.

And you'll find that the EMT 240 is imperturbable, too. Voices, footsteps, and even knocks on the unit itself don't bother the EMT 240. It does its job — and lets you do yours — in the studio or on location.

Reverb time goes down to under one second, and set-up time is almost as fast. We pre-align and pre-tension the EMT 240. You unpack it and put it to work.

The EMT 240.

You'll say it was worth waiting for.



GOTHAM
AUDIO CORPORATION

Headquarters:
741 Washington St., New York, NY 10014
(212) 741-7411

West Coast Sales Office:
1710 N. LaBrea Ave., Hollywood, CA 90046
(213) 874-4444

Circle 20 on Reader Service Card

professional sound measuring set for under \$400

The Scott 4521 sound measuring set lets you make the full range of professional sound measurements in the office, studio, field, auditorium, street, or factory. The sound level meter is our Model 452, which meets ANSI type 2 and OSHA requirements. Its low scale reading of 35 dB lets you monitor background noises other meters miss, and it goes up to 140 dB with A, B, and C weighting.

Its flat response ceramic microphone is removable so you can take remote readings up to 200 feet away from the sound source without sacrificing accuracy. Its output connector drives recorders, analyzers, headphones, or other accessory equipment. Its drawn metal case, glass epoxy circuitry, and rugged taut band meter movement let you safely ignore the rigors of continuous rough handling which breaks other instruments.

You also get our Model 456 precision acoustic calibrator which lets you calibrate to within $\pm 1/4$ dB accuracy on a day-to-day basis in the field. The whole works comes in a deluxe carrying case with calibration screwdriver and extra batteries and costs you a lot less than what you would pay elsewhere for equivalent functions.

The 4521 sound measuring set is available at \$398.00 from authorized Scott distributors. For full product information and list of stocking distributors circle reader service number or write to Scott Instrument Laboratories, 30 Cross Street, Cambridge, Massachusetts 02139.



**Scott
Instrument
Laboratories**
Division of Eastern Air Devices
30 Cross Street
Cambridge, MA 02139



therefore the only other possible alternative.

Fortunately, as mentioned earlier, there is a remedy—if not a cure—for the problem. Simply record all important programs, such as presidential wire taps, on several machines simultaneously. Since it is a well known fact that this curious phenomenon will not manifest itself on two machines at the same time, the continuity of programs—especially those essential to the nation's interest—will be guaranteed.

It is, of course, beyond the scope of this report to describe why it is so important to record private conversations, since this a scientific journal and, as is well known, morality has little relevance to science or politics. (For further study on this point, the reader is referred to his morning newspaper.)

In any case, once we agree that the tape recorder is our friend, we may come to appreciate in time that two tape recorders are even better friends, and so on. And, when tape recorded conversations eventually become an important part of the American way of life, we may find that we actually enjoy a greater degree of privacy than at present. This should be obvious to anyone who thinks about it.

To explain, secretly-recorded conversations are like any other novelty record. Everyone wants to hear one, possibly two, but as Mr. Nixon might say, "When you've heard one, you've heard them all." And he should know.

So, by publicly recording everything in duplicate, the novelty aspect will soon wear off, and instead of having thrill-seeking committees demanding even more tapes, it will become increasingly difficult to get anyone's attention with a hot tape. By and by, no one will listen to anything, and our privacy will once again be assured.

By saturation recording, the Woods' Hole Effect will become an insignificant problem. And, the increased demand for tape and tape recorders will create more jobs within our industry.

As an aside, the vendor who wins the White House account will have an unprecedented advertising advantage. Think of the market potential of a noise reduction system, "as used in the oval office". Of course, the dignity of the office of President would not permit higher endorsements, but perhaps Mr. Nixon could be prevailed upon to discuss his favorite editing techniques at an informal luncheon for studio owners interested in contributing to a fund to rewire the White House for quad.

As an interesting sidelight to the Watergate Syndrome, the President points the way to a sweeping re-assess-

Swiss Performance

Our new Electro Sound ES-505 Professional Recorder/Reproducer has what it took the Swiss centuries to develop. A heritage of classic design and precision performance. The ES-505's essential mechanical and electronic specifications compare favorably to Studer's A-80. And at ½ the price! □ European or American—no other professional machine has more significant "Operator Engineered" features. A disappearing headgate for easy editing or cleaning. A built-in reference audio oscillator that supplies test frequencies 50 through 15K for instant alignment. An optical motion sensing system prevents tape damage during control sequencing. And differential disc brakes for ultra smooth tape stops. □ Operator simplification. Our ES-505's "Record" indicator light also continuously monitors bias. There are two calibrate positions: one for record and one for reproduce. Our optional third reel is the ultimate in convenience for those heavier editing jobs. Operating modes are instantly recognized with fully illuminated transport controls or optional remote controls. □ Operator satisfaction. Electro Sound's unique viscous damped idler fly wheel lowers flutter up to 25%. The ES-505's non-slip capstan improves playback timing accuracy to ±1.8 seconds in 30 minutes recording. □ The ES-505 is available in ¼" or ½" versions, with 1, 2 or 4 channels of electronics console, portable, and unmounted configurations in 1½ year extended parts warranty. The American machine to match Swiss excellence.



Performance	Electro Sound ES-505	Studer A-80
Mechanical		
Timing Accuracy	±0.1%	±0.1%
Wow and Flutter 7½ ips	~0.08 rms	~0.07 rms
Electronic		
Frequency Response 15 ips	30-18K Hz ± 2dB	30-18K Hz ± 2dB
Signal-to-Noise 15 ips— Two Track	63 dB Unweighted	62 dB
Distortion	0.4% 2 HD @ 500 Hz Peak Record	~1.0% @ 1K Hz. Operating Level
Price	\$3,395	\$6,670

ELECTRO SOUND, INC.
725 Kiler Road.
Sunnyvale, CA 94086
(408) 245-6600 Telex: 34-6324
LECTROSNO SUVL

International Distribution By:
AUDIOMATIC CORPORATION
1290 Avenue of the Americas, New York, NY 10019
(212) 582-4870 Cable: AUDIOMATIC. Telex: 12-6419
European Office and Showroom
4, rue Ficatier, 92400 Courbevoie, France (Paris).
333.30.90. Cable: AUDIOMATIC. Telex: 62282

Latin American Export By:
TELEMERICA, INC.
25 West 43rd Street
New York, NY 10036

American Prices

Circle 19 on Reader Service Card

ment of the art of criticism, specifically, the record review.

We have all read reviews in which the critic finds fault with the artist's interpretation. The critic, being a respected authority, will inform us that the artistic rendition suffers from one shortcoming or another, and we are all very much wiser for having read the review.

Now, Mr. Nixon has shown us that it may indeed be that the critic's own interpretation may be at fault. In describing his very own recorded work, the President revealed that although he certainly knew what he meant

when he said what he said, other people might think that he meant something else when they in turn hear what he says that he said.

Could anything be more clearly put? As the nation's number one critic, Mr. Nixon's word is certainly unimpeachable. (?—*Editor's Note*). So, the implications are clear. As a recording artist, Mr. Nixon *knew* what he meant, even if there is not another man in the Nation's Capitol who would interpret his words in the same manner.

Now then, if there is no one within the entire U.S. Government who can

make the proper sense out of a simple recorded conversation, how shall we expect a mere record reviewer to comprehend what an artist intended in performing a piece of music?

Clearly, the very concept of the record review must be re-examined in the light of Mr. Nixon's recent enlightening thoughts.

We shall look forward to more instructive thoughts from the President, and perhaps in time he could be prevailed upon to publish a little blue book of Presidential Perspectives that would serve as an inspiration to us all.

As a study guide for those seeking additional background information for a better understanding of the Watergate Syndrome, the reader is referred to an early paper by the researchers Gilbert and Sullivan, entitled, "Things are Seldom what they Seem." And in the meantime, dedicated researchers continue to probe the mysteries of the Watergate Syndrome, and it is hoped that, in time, our tape machines will all be returned to normal. Happy April! ■

Midwest Acoustics Conference

At the eighth annual Midwest Acoustics Conference to be held May 18 at Northwestern University, in Evanston, Illinois, experts in tape and disc reproduction will discuss the future roles of tape and disc reproduction. Impartial judgement criteria will be developed by speakers whose affiliations permit obvious objectivity: Ernest Schonthal, of Bruel & Kjaer, will speak on *Amplitude and Spectral Characteristics of Music from the Standpoint of the Concert Listener*. Well known scientist-musician Marvin Camras, of IIT Research Institute, will expose the *Critical Parameters of a Music Program Record Playback Medium and One's Sensitivity to Deviations from the Ideal*.

Current disc and tape performance and quality levels will be explained by John Bitner of Wakefield and Douglas Thornton, Maniton Systems. Panel discussions, which will be open to audience participation, will also include technical representatives from the principal manufacturers and patent holders of noise reduction systems, tape and disc record and playback systems, as well as independent consulting engineers. An unusual feature of the conference is the expected disclosure of a state-of-the-art advance in disc recording. A variety of disc and tape equipment will be displayed and demonstrated at the sessions. Advance registration is \$4.00. Write Midwest Acoustics Conference, c/o H. Messerschmidt, Western Electric Co., 4513 Western Avenue, Lisle, Illinois 60532. ■

SPEED AND QUALITY

The new GARNER table-top Model 1056, a heavy-duty, precision reel-to-reel copier, makes five quality copies from the master reel. Ideal for mass production of professional quality tapes by commercial or institutional organizations.

A single capstan drives master and all copies. New two-speed drive allows slower speed for higher fidelity. Solid state electronics, special heads and mechanical excellence, provide good frequency response. Extra-fast rewinds of master tape speeds production.



Model 1056 High Speed Professional Tape Copier



Rep. territories available.
Call 402/466-1816

GARNER ELECTRONICS

A SUBSIDIARY OF GARNER TOOL & DIE

4200 N. 48th Street

Lincoln, Nebraska 68504



The Model 10 Mixing Console

When you've got more talent than money

Any mixing console is simply a creative tool. Getting the most out of it calls for imaginative insight into music and skill in the practical application of sound.

If you've got the talent but you don't have the money,

you're exactly who we built this board for.



The basic 8-in, 4-out board starts at just \$1890. From there you can go to 24-in, with options and accessories enough to fill a studio.

The TASCAM Model 10. It gets your inside outside.



TASCAM CORPORATION

5440 McConnell Avenue
Los Angeles, Calif. 90066

Circle 28 on Reader Service Card

Norman H. Crowhurst

THEORY AND PRACTICE

● In my letter responding to John Pritchett's in the January issue, I complained about one particular facet of the problems in American education: that educators always believe they are

in possession of all possible alternatives. If you work at handling audio for educators, converting instruction to the mediated form, you undoubtedly know what I mean, only too well!

A while ago I made a report, investigating an "excellent" project that spent three million dollars of tax money producing a single multi-media course to replace conventional material taught by instructors. I can only presume that the measure by which it was rated excellent was its power to absorb three million dollars. Anything costing that much must be good!

The course contained sixty lesson-sized segments. As a development project, the aim was to put the contents of the course into a variety of media, including audio tape, video tape, and single-concept films, in addition to more conventional self-study texts. As part of the experiment, the students also listened to a lecturer. The project was committed to supplying, as one of its purposes, research data to determine what relationship exists between the choice of medium used, student preferences, and the resulting rate of learning.

To educators, the fact that material is being used for research constrains them to not change anything because they fear any variation in content influenced by the nature of the medium might invalidate data about the relative effectiveness of the media involved. For example, at one stage a professional t.v. newscaster hired to do the videotape mediation was instructed to read the subject matter in a monotone. This direction was based on the hypothesis that a student limited to reading self-study text has no indication where emphasis should be placed, so he should not have any when he watches someone read the same material on t.v.!

If the reading of text is to be the only mode employed, when such a flexible medium as t.v. is available, I'd rather have Orson Wells read it to me, any day, than someone who leaves out all the emphasis and pauses. How about you?

Watching people at this project, arduously insuring that nothing changed but the medium, a contrast in my memory came to mind: a film shown at a professional society meeting, right after World War II. This was an animated film put together by Disney Studios for training men in the forces in the use and maintenance of radar and electronic guidance systems.

In no more than twenty minutes,



Circle 24 on Reader Service Card

COMPLIMITER™

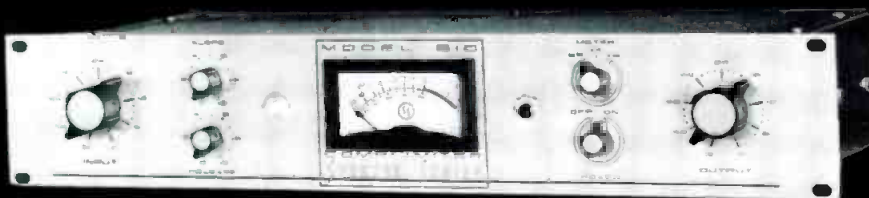

MODEL 610

Used in recording studios; disc mastering studios; sound reinforcement systems; TV, AM, FM broadcast stations to maintain a *sustained average signal* at a level *significantly higher* than that possible in conventional limiters, and with performance that is seldom attained by most *linear amplifiers*. Rack mounted, solid state, functional styling, the Model 610 is in stock for immediate shipment.

Specifications are available from:

SPECTRA SONICS

770 WALL AVENUE, OGDEN, UTAH 84404
(801) 392-7531



Circle 22 on Reader Service Card

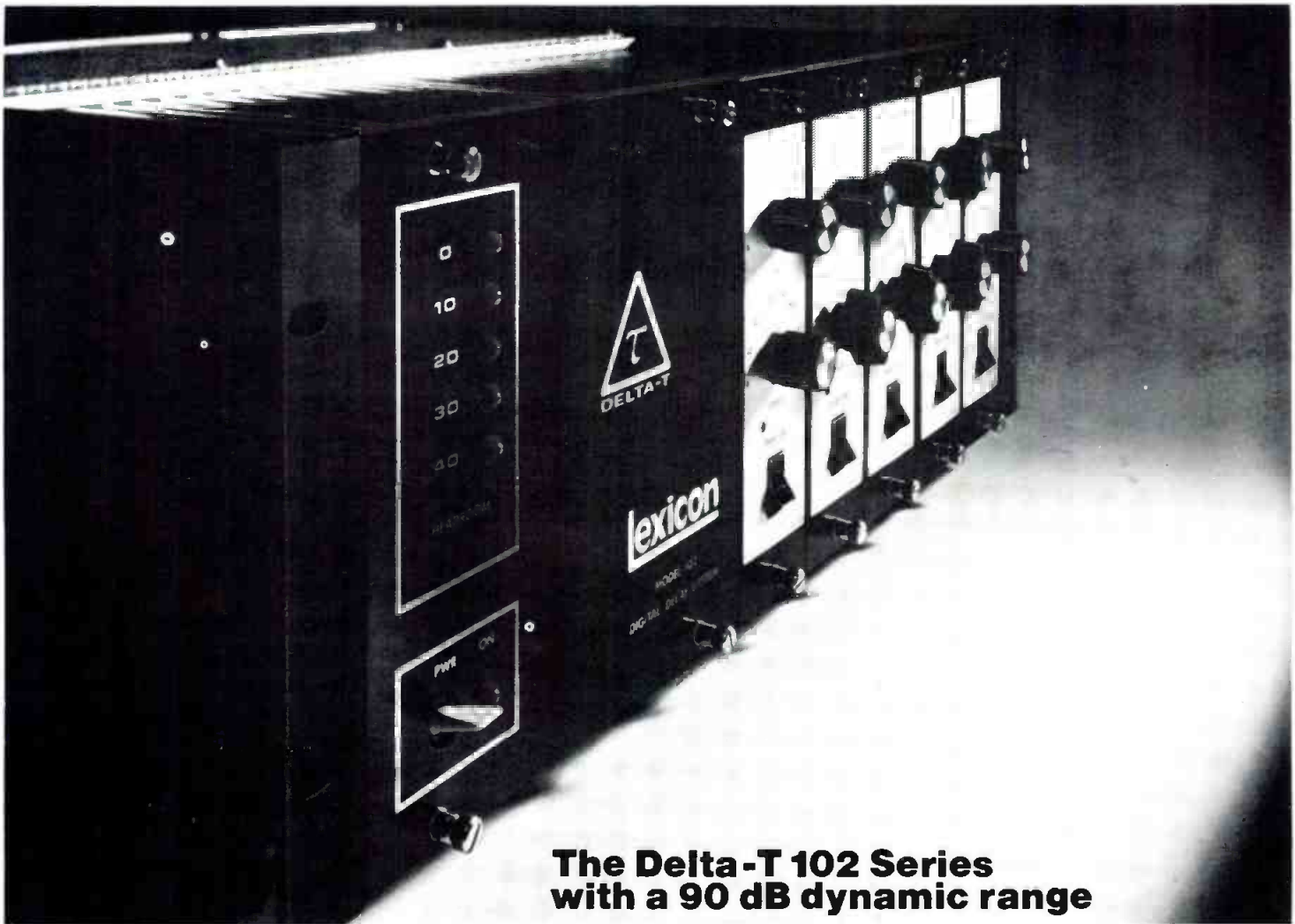

**The Delta-T 102 Series
with a 90 dB dynamic range**

**Announcing
the second
generation in
digital delay
systems...**

Four years ago Lexicon in cooperation with Gotham Audio introduced the industry's first all electronic audio delay system — the Delta-T Model 101. Practical experience and helpful suggestions from users accumulated since that time have enabled Lexicon to create the Delta-T 102 Series. The 102's offer a new level of performance and flexibility previously unavailable to the industry.

Using proprietary digital techniques the Delta-T 102 Series provides, along with other advances, a 90 dB dynamic range and significantly lower noise and distortion.

The 102 Series has been carefully engineered to meet a wide range of requirements:

For example, the system may contain 1 to 50 outputs, 2 ms to 3.2 seconds of delay, and remote console mounted controls and headroom indicator. Fully modular construction permits simple field expansion and maintenance by module plug-in. Three basic models in the 102 Series allow economic selection of frequency response and delay interval for sound reinforcement, studio and laboratory applications. All models feature a 5 position 40 dB headroom indicator which assures correct level setting.

And the cost of the 102 Series is revolutionary. Although providing the dynamic range of a 15 bit system, the 102's are priced competitively with present 10 and 12 bit units. Complete systems start at \$2400. Delivery is 45 days.

For complete information write Lexicon, Inc., 60 Turner Street, Waltham, Mass. 02154. Or telephone (617) + 891-6790. Dealer inquiries invited.

lexicon

Visit us at Booth 105
at the AES Show.

Circle 26 on Reader Service Card

Be sure
to attend . . .

THE AUDIO ENGINEERING SOCIETY'S

48th Technical
Meeting and
Exhibition of
Professional
Equipment
at the
Los Angeles
Hilton
May 7-10

For details, write or phone:

AUDIO ENGINEERING SOCIETY

• 60 E. 42nd St., N.Y., N.Y.
10017 (212) 661-8528

• 11916 Salem Dr.,
Granada Hills, Calif.
(213) 363-5111

PUBLICATIONS OFFICE

• 124 E. 40th St., N.Y., N.Y.
10016 (212) 661-2355

this remarkable piece of animation started from knowing nothing about what voltage and current are, to a conclusion which had developed a pretty good basic concept about the different ways in which electromagnetic systems can be applied to navigational guidance. How long do you think that would take in conventional classes?

About a year ago, I met a man who had trained with that film during World War II. He still remembered it as vividly as the day he saw it. Could you say as much for classroom instruction?

While viewing the project of which I am speaking, I thought about how the same kind of thing could be done today. In those days, Disney's artists must have spent thousands of man-hours putting it together. Nowadays, modern video techniques could create the same kind of thing, almost as fast as a good, creative instructor could dream it up.

So why isn't that kind of thing being done? Many media installations at our institutions of higher learning possess highly sophisticated equipment, the use of which is usually limited to providing "artistic" fades and pans of the instructor while he merely presents the same old stuff that has been used for "centuries!"

With all that expensive equipment available, why could not its sophistication be used to *create* something that contributed usefully and particularly to the learning process, rather than merely making the presentation look more like something you might see on commercial t.v. at its dullest?

These "media specialists" usually take some existing text on the subject to be converted, then work on how each bit can be handled to put precisely the same piece into media form. They have been indoctrinated into a very specific notion of *reinforcement*, in which the student is subjected to hearing and seeing the same set of words simultaneously. You've seen it done on *Sesame Street* and similar programs.

A common technique the mediator uses is to give the student visuals on paper, in the form of beginnings of sentences he will hear on the audio. He is then expected to stop the audio and copy down the rest of the sentences. This is merely a translation of the inferior process that most teachers use all the time, whereby the student learns to respond correctly without understanding a word of it!

Some time ago, we reviewed a piece of instruction about complex numbers. While the audio read from a textbook, the visual presentation ex-

posed successive parts of the same page. Imagine how boring it was to listen to the product of $a + jb$ into $c + jd$ multiplied out, a step at a time. The student could do that much better from a book, if it must be presented that way at all. These mediators showed no imagination whatever!

I would have to presume, without evidence to the contrary, that these mediators knew nothing about complex numbers. Worse, they did not want to know. They merely had a chore to do: get that damned stuff mediated!

So what could you do, if you were involved in something like that? What if you didn't know the subject either? It is very helpful, whether or not you know the subject, to try to put yourself in the position of a student. If you are going to help others understand something, first you must understand it yourself. So the first thing to do, in preparing any instructional material, is to instruct yourself.

Why don't educators do that? I could theorize about that, but it would not help. But it is no use saying, as most educators do, "That is the way it's always been taught. Those who 'get it' do, those who don't, don't."

What stops many who work on such projects, is that not knowing what it's about, they are afraid to show their ignorance. So they allow the same process to go on, to cast the poor students' ignorance in concrete! Realize this: if you don't know it, you are in an ideal position to imagine yourself a student, who doesn't know it either—that is why he needs the instruction!

So you find out what it's all about. What is it you do to achieve that? That is what the student will probably need to do. Your job is to find a way to facilitate that happening, with the media.

Never think of yourself as "just the audio man." Think of yourself as part of a creative team, whose job is to turn out the best possible instructional material. Then you can inject your concerns by suggesting to others on the team, "If I were a student being expected to learn this . . ."

If you show interest and start making such suggestions, any group worth their salt will see, almost immediately, that it would be better to put out material that will do a superior educating job, than merely to "translate" existing material into mediated form, usually losing something in the process.

To turn out superior material requires that all involved know the objectives of the unit being put together. Each should find that out for himself.

Circle 35 on Reader Service Card →

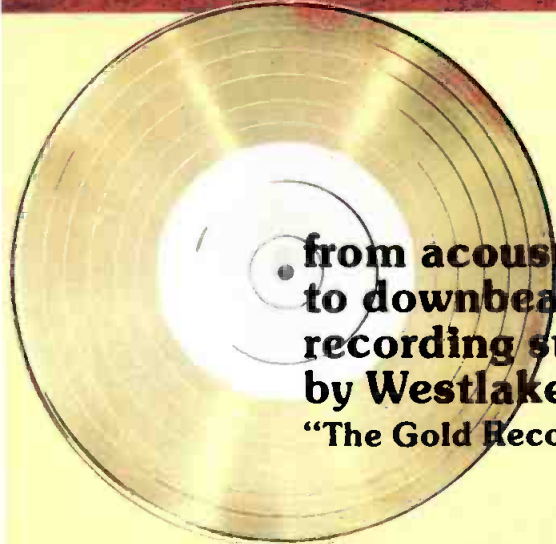
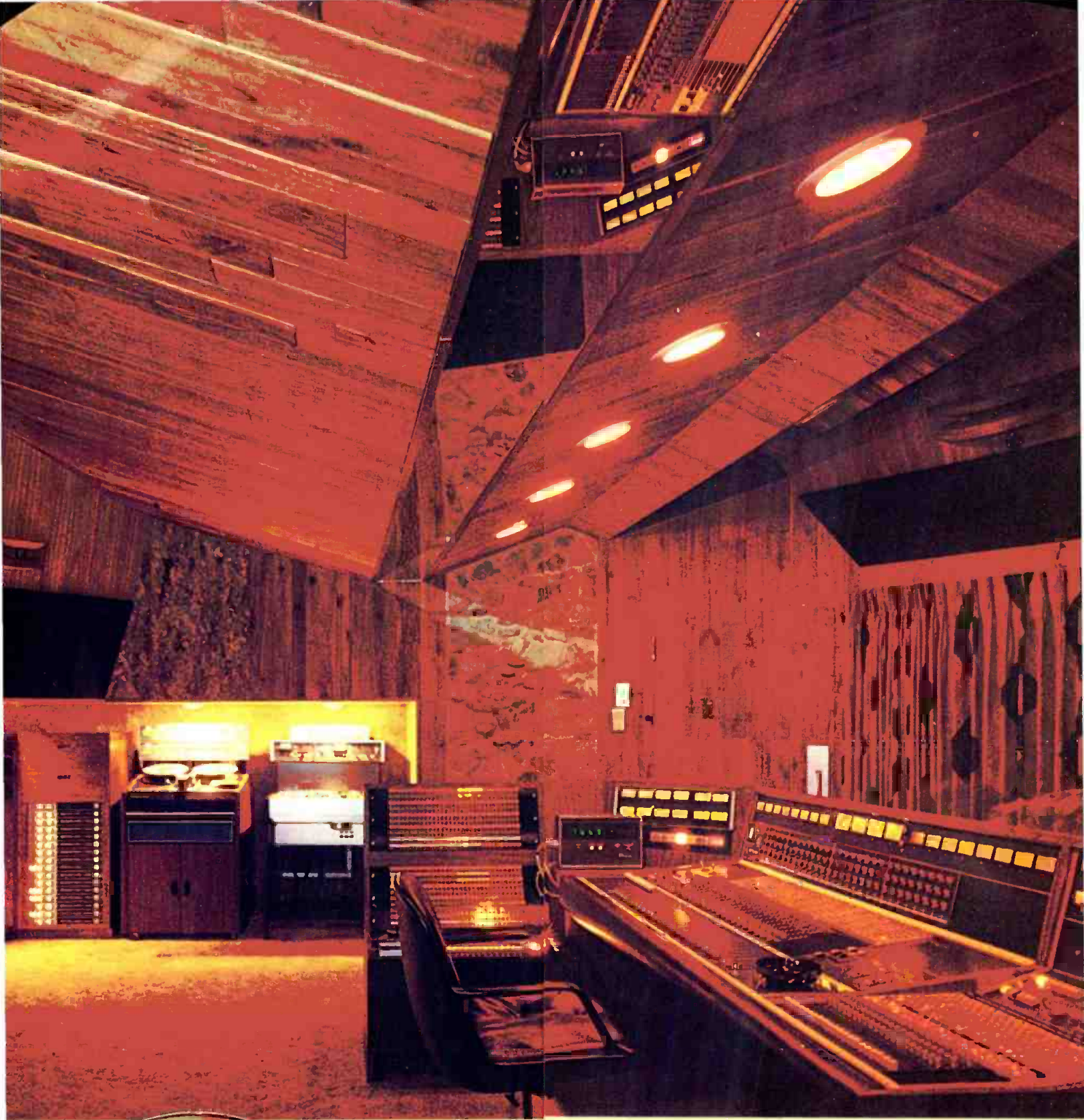

**from acoustic design
to downbeat...
recording studios
by Westlake Audio
"The Gold Record People"**



from acoustic design
to down beat...

**Westlake
Audio**



Kendun Recorders, Burbank, California

services available to our package and turn-key clients

Pre-Planning: Which markets are you going after? One studio or two? What is the sound character desired? How much multi-track separation? Your budget? Future expansion? These are just a few of the questions discussed at this stage. From the answers, we'll provide you with a comprehensive proposal covering our recommendations and the cost for the entire project.

Site Evaluation: If you're planning to build from the ground up or within an existing shell, we'll help you to select the best building or location in terms of size, demolition and construction costs, zoning, noise transmission problems and those "hidden" costs. Remodeling an existing studio? We can show you how to get the best results from your space.

Design: Acoustical design is the key to the success of a studio. Westlake Audio's geometric and acoustic designs will provide you with a winning "sound." **Prior to construction**, we will guarantee the performance of your studio and control room with respect to isolation, response, decay time in various frequency bands and dispersion.

Equipment Selection: We have carefully evaluated the many products on the professional audio market to provide our clients with a broad selection of the finest recording equipment available. From consoles, automation and tape machines to monitors, microphones and support equipment, we have the lines to satisfy your requirements and budget.

Financing: We work closely with several companies whose specialty is providing clients with a lease or conditional sales plan tailored to your needs.

Construction: As the proper implementation and execution of the geometric and acoustic designs requires unique construction techniques, Westlake Audio will provide a construction foreman to oversee and work with your local construction crew and electrical and air-conditioning subcontractors.

Wiring: Our technical crew will install all the audio wiring throughout the studio complex and tie down the wiring to the microphone, headphone and tape machine panels, echo chambers, console, amplifier room and monitors.

System Interface: Our engineers will install all the recording equipment and interface the entire system to the console. A total system checkout is performed from microphone phasing to monitor equalization and balancing.

Training: Technical and mixing engineers will train your personnel in the operation and maintenance of the studio and equipment.

Studio Management: Upon request, Westlake Audio will offer guidelines and suggestions for all facets of studio management including rates, booking procedures and controls, personnel requirements, wages, work orders, tape legends, library systems and credit.

No other professional audio dealer can offer these unique services and the experience gained from building over 50 major facilities.

From a splicing block to an automated console, a home studio to an extravaganza.

Write or call and we'll show you how to earn a 50% return on your investment.

From acoustic design
to down beat...

**Westlake
Audio**

6311 Wilshire Boulevard
Los Angeles, California 90048
(213) 655-0303

Then a production conference would be in order, an idea generating session, the more informal the better, at this stage.

This will release everyone engaged on the project (although it may take some quite a while, because they have lived in their cocoons for so long) from the inhibition that confines each to merely doing his job. This confines him to merely following rules about the kind of visual appropriate, the speed of the audio, and all that jazz, while giving no attention whatever to the process that may be going on in the student's head!

It helps if you have someone who knows the subject the unit is intended to teach. But do not assume, if no one does, that therefore you can do nothing but "translate!" You, too, can learn, and you'd better, if you want to produce something by which others can also learn.

If you stumble over statements in the text from which you derive this instruction, of which you cannot make sense, *never* assume that the student will know what it means! That it is in print signifies that the author *may* have known what he meant. Maybe no student who ever studied that book ever understood that piece. So why be so stupid as to religiously translate that piece of incomprehensible matter into mediated form?

As a technical writer, one piece of philosophy has contributed to my success: if an editor, first, or any reader, second, does not know what I mean, then I have not said it plainly enough! That seems obvious, doesn't it? Yet you'd be surprised how many authors will want to argue such matters. Some authors will argue that they said it perfectly plainly for any normal person to understand. So the editor or reader who doesn't must be stupid.

If someone has difficulty with it, most likely it needs changing.

You may not always have time to wait for editor or reader reactions before you rewrite. An excellent discipline that may save the need for that, is to write your material, then set it aside for a day, a week, or a month—the longer you can spare, the better. Then take it out and read it again, carefully.

You will discover that the art of putting of words on paper possesses no intrinsic magic. You may find that something you wrote, not so long ago, requires you to stop and think about what you meant. Whether you have to stop only a moment, or perhaps for longer, the fact that you need to think at all, should provide you with a clue: that piece probably needs rewriting.

Of course, at times you may say

something designed to make your reader think. Okay—we hope so! But be sure that you say it plainly enough, so his thinking will be devoted to pursuing the thought you intended him to, not to trying to find out what you meant!

The same disciplines that guide a writer can help in putting together instructional materials. I have found them tremendously helpful in the work I have been doing with Educational Research Associations. In that case, I happen to be the writer. But I welcome comments, questions or criticisms from the audio man, or from anyone else. And if I'm working with a team that doesn't want that kind of help, there are others that welcome it! ■

you write it

Many readers do not realize that they can also be writers for *db*. We are always seeking good, meaningful articles of any length. The subject matter can cover almost anything of interest and value to audio professionals.

Are you doing something original or unusual in your work? Your fellow audio pros might want to know about it. (It's easy to tell your story in *db*.)

You don't have to be an experienced writer to be published. But you do need the ability to express your idea fully, with adequate detail and information. Our editors will polish the story for you. We suggest you first submit an outline so that we can work with you in the development of the article.

You also don't have to be an artist, we'll re-do all drawings. This means we do need sufficient detail in your rough drawing or schematic so that our artists will understand what you want.

It can be prestigious to be published and it can be profitable too. All articles accepted for publication are purchased. You won't retire on our scale, but it can make a nice extra sum for that special occasion.

Plastic Reels Shipped from Inventory
Mfrs. of Amerline reels
Polyline Corp. 312/298-5300
FOR MAG TAPE 1241-Rand Rd. Des Plaines, Ill. 60016

GET THE MOST HEADROOM FOR THE MONEY!



Russco's two new lines of top-quality phono pre-amps give you the power where you need it! (+18 DBM) All models are self-powered, available in mono or stereo versions, and feature a unique aluminum case that allows quick and easy service access. Years ahead in engineering, the best news is the Low Prices starting at \$92.00!

RUSSCO
ELECTRONICS INCORPORATED
1070 BROOKHAVEN, CLOVIS, CALIF.
PHONE (209) 299-2167

NEW PRODUCTS AND SERVICES

REMOTE CONTROL CASSETTE PROGRAM LOCATOR

● With this device, designated GYYR CPL-1000 and designed to be used with Sony U-Matic video cassettes, it is possible to plan a presentation, moving smoothly from one desired segment to the other at random or repeating a given segment. The advancement to new segments, achieved with numerical pushbuttons, is done before threading, a plus which incidentally adds to tape life. Interconnection of the locator with the player and receiver is made with a single cable, which does not interfere with the operation of the player or the receiver.

Mfr: Odetics, Inc.

Price: \$1,095.

Circle 47 on Reader Service Card



VERSATILE AUDIO CONSOLES



● The Spotmaster line consists of nine models—a four-channel monophonic console, two five-channel monophonic consoles, two five-channel stereo consoles, two eight-channel headphone drive amplifiers, and cue amplifiers with internal cue speaker. All five and eight-channel models feature electronic switching to mixing channels with f.e.t.s. Construction is fully solid-state with integral power supplies and plug-in modular electronics. Flexibility is enhanced by high and low level inputs for all mixing channels, identical program and audition outputs. There are separate mono matrix outputs in stereo consoles.

Mfr: Broadcast Electronics

Circle 48 on Reader Service Card



The new Revox A700 - \$1695
the performance is shattering

Circle 29 on Reader Service Card

ON-AIR LIGHT



● Drawing only fourteen watts, this on-air light shows vivid red in the ambient light of the studio, with total blackout when off. Made of 20-gage steel with 1/8 inch thick unbreakable Plexiglas front panel, it measures 5 inches in height, 10 inches in length and 2 1/2 inches in depth. Usable with 220V or 240V a.c. or d.c., as well as 120V a.c. Supplied with two 7C7 lamps.

Mfr: Fidelipac

Price: \$28.95.

Circle 49 on Reader Service Card

LOUDSPEAKER MONITOR SYSTEM

● A new and unusual loudspeaker monitor system has been introduced. Unique in several ways, it utilizes a new (patent 3478289) heavy woofer which focuses very uniform flux density in the gap and results in magnetic damping and extremely low, non-linear distortions. It can handle up to 200 watts rms. Each unit is tested and subjected to 100 watts rms for 45 seconds under sine wave and music conditions. The new mid-range driver has a 1½ inch diameter voice coil with 13,000 gauss in the gap for accurate transient and flat frequency response. The tweeter section is a radically new device called "the wave transmission line tweeter." Response is claimed to be beyond 38 kHz with perfect transient response. Since it is a perfectly coherent radiating source, it acts as a theoretical pulsating cylinder. Horizontal dispersion is 360 degrees kHz and vertical dispersion is 60 degrees. The tweeter was developed in conjunction with Ohm Acoustics and is a newly developed extension of the original Walsh patent 3424873. The unit is housed in an attractive floor-standing cabinet with mid-range and tweeter controls easily accessible at the rear of the unit.

Mfr: Infinity Systems, Inc.

Price: \$429

Circle 50 on Reader Service Card



REED AND BRASS SYNTHESIZER

● Like an electronic version of Aladdin's lamp, the RMS synthesizer sound modulator can conjure up a whole orchestra out of a single reed instrument. Used with a clarinet, trumpet, trombone, cornet, flute, tenor or alto sax, the synthesizer can convert the sounds of these instruments to the sounds of a tuba, bass clarinet, bassoon, English horn, or cello. This is accomplished with 16 tabs and 8 slide controls. For those who need to go beyond the usual sounds of musical instruments, there is a "wah-wah" effect and an "attack" tab, which produces a shattering burst of sound (the attack is no doubt done by the neighbors). For placating the neighbors, there's a sub-octave tab which lowers the pitch two octaves below the natural sound. You can also choose a raspy sting 'fuzz' sound, or wipe the whole thing out with the "cancel bar."

Mfr: Instrument Systems Corp.

Circle 51 on Reader Service Card



WORAM AUDIO ASSOCIATES

Consultants in Studio Systems
Engineering, Design and Installation

—offering—

A COMPLETE CONSULTATION
SERVICE FOR STUDIO
PLANNING AND
CONSTRUCTION

FREE-LANCE RECORDING
SERVICE IN THE
NEW YORK AREA

212 673-9110
64 University Place
New York, N.Y. 10003

**BOSE
800™**
professional
loudspeaker

no
sound
of its
own

With the BOSE 800, the sound the audience hears is the music the performers play...pure and simple.

□ CLEAR, NATURAL SOUND
□ RUGGED, PORTABLE PACKAGE

BOSE 800... The
Professional Performer
For Professional Performers

Please send complete information on the BOSE 800 to:

Name _____

Address _____

City _____ State _____ Zip _____

Return to BOSE Corp. The Mountain,
Framingham, Mass. 01701 Dept. BD

MODULAR PEAK VU DETECTOR

● Hi fi sound distortion, caused by the clipping off of signal peaks, are rectified by the use of vu detector VU306, which the manufacturer claims will monitor true sound levels rather than average or rms values. A precision full wave peak rectifier within the module measures individual signal peaks within 5 microseconds and develops a proportional d.c. output that remains steady for two seconds. The d.c. output activates any standard d'Arsonval vu meter. After each two-second hold period, the module automatically takes a fresh sample and displays that for the ensuing two seconds. Should a higher peak value occur during any two-second reading period, the detector's d.c. output advances to the new peak level and holds at that higher peak. Frequency response, it is reported, is either flat or has preemphasized high frequencies to simulate f.m., RIAA, or slow speed tape recorder preemphasis. The modules are 1.5 inches square by 0.65 inch high and operate from ± 15 volt d.c. supplies.

Mfr: Burwen Laboratories

Price: \$85.

Circle 57 on Reader Service Card



INDIVIDUAL MICROPHONE CHANNEL EQUALIZER



● The degree of equalization of the bell shaped response of Model 3000 is individually selectable in twelve discrete steps from -12 dB of dip to $+15$ dB of boost on Model 3000. The unit has three independent overlapping frequency ranges, 50 Hz to 500 Hz; 300 Hz to 3 kHz; and 1.5 kHz to 15 kHz—each with its own continuously variable center frequency and bandwidth controls. The equalizer also has voltage controlled equalization in-out switch and a led indicator for use with automated programmers. *Mfr: Modular Devices, Inc.*
Price: \$325.

Circle 58 on Reader Service Card

TELEVISION AUDIO CONTROL



● Additional functions and controls designed for television use have been added to this manufacturer's recording studio console, with the special designation of Model 1204-TV. Features include eight monitor muting switches to help prevent feedback from studio microphones; direct feed switching which bypasses the bus assignment and output sections of the console, permitting it to be utilized for production work while the station is on the air; two special input channels, each accepting eleven line-level pushbutton switchable sources. Inputs may be instantly switched from vtrs, film chains, cassettes, turntables, or remote lines. There are four mixing buses, which can be used for simultaneous development of different mixes. Other features include stepless conductive plastic faders, redundant power supply re-set and indicator system, and echo chamber send available on each input channel.

Mfr: Cetec, Inc.

Circle 59 on Reader Service Card



The new Revox A700 — \$1695
we couldn't make it cheaper
we couldn't make it better

Circle 29 on Reader Service Card

ELECTRONIC TUNING FORK



● Integrated circuits have made possible the compact size of EMT-117TS tuning fork. The self-powered hand held device with a self-contained loud-speaker emits an oboe-like tone tunable precisely in one Hz steps from 435 Hz to 445 Hz. The unit has a connector which allows external 9V powering and which feeds the audio signal to larger speaker systems when required.

Mfr: *Gotham Audio Corp.*

Price: \$370.

Circle 55 on Reader Service Card

HIGH RESOLUTION 180 mHz FREQUENCY COUNTER KIT



● A phase-locked frequency multiplier makes it possible for IB-1103 frequency counter to read to 180 mHz with a high resolution. Pushbutton selection permits multiplication by 1 (direct), 10, 100, or 1,000. An input frequency of up to 10 kHz can be measured down to 0.001 Hz. A temperature compensated crystal oscillator generates the base, and three pushbuttons provide 1 millisecond, 100 millisecond and 1 second gate times. Input sensitivity is 50 mV to 120 mHz and 100 mV to 180 mHz. A rear panel switch permits bypassing the internal oscillator to allow use of any external time base up to three volts. Cold-cathode display tubes provide 8½ digit readout with range lamps for mHz, kHz, and Hz. Indicators are provided for gate, over-range, and unlocked operating conditions. The manufacturer estimates time needed for assembling as about seven evenings.

Mfr: *Heath Company*

Price: \$379.95.

Circle 56 on Reader Service Card



We've been hiding our light under a bushel —

● C1616/C2424 CONSOLE

A year ago we studied the other two low cost recording consoles and we built a unit without their shortcomings. We also put in a few extra goodies, like semi-parametric equalizers on each input. We have installations in Atlanta, Washington, Wilkes-Barre, Denver, Lancaster, and more coming. Compare before you buy your new console. Circle 15 on Reader Service Card.

● MOM'S WHOLESOME AUDIO MICROMIXER

If you're into PA or stereo recording requiring lots of inputs with EQ and reverb, you might want to look into our MicroMixer. Circle 16 on Reader Service Card.

● ORTOFON DISC CUTTING EQUIPMENT

With installations in Nashville and Chicago, Ortofon has really got their thing together. Write or call for more information.

● SCHOEPS MICROPHONES

We've got some new hand held condenser microphones — both cardioid and omni patterns — that are absolutely pop free. Circle 17 on Reader Service Card.



GATELY ELECTRONICS, Inc.

57 West Hillcrest Ave.
Havertown, Penna. 19083
215-449-6400

1907 Division St.
Nashville, Tenn. 37203
615-327-1746

Circle 17 on Reader Service Card

DIGITAL AUDIO DELAY LINE

● With a single audio input, up to 499 milliseconds of 12 bit quantized audio delay may be routed into a maximum of five outlets with TM 499 digital audio delay line. The time machine offers integral low-level muting circuitry, pre- and de-emphasis equalization, and input compression. It is capable of providing from 0 to 499 milliseconds of selectable one millisecond delay increments. 60 millisecond delay circuit cards with a front panel indicator can be built up along with the requisite output channels. The delay and output modularity allows a specific "building block" approach. The components are packaged in a totally modular mainframe, occupying 5¼ inches of rack space.
Mfr: Quad/Eight Electronics
Price: \$695-\$3,495.

Circle 38 on Reader Service Card



LARGE-MOULDED STRAIGHT HORN



● A 240 Hz flare rate gives EC 250 horn pattern control down to 400 Hz. The horn, for 1¾ inch x 18 inch threaded drivers, can also be used as an HF unit with folded bass horns. Dispersion at 1 kHz is 45 degrees H x 30 degrees W.

Mfr: Community Light & Sound
Circle 40 on Reader Service Card

RADIO PAGING RECEIVERS



● This tiny receiver, weighing only six ounces, can be carried in a pocket. CR, designed to be used with Page-master components, emits a beep when an assigned code is transmitted. Up to 1,100 units can be serviced within the transmitting area. The unit features silicon transistor circuitry and a contactless mechanical filter which insures triggering only at the coded signal. Circuitry is crystal-controlled superheterodyne a.m. It is powered with a long life mercury battery.

Mfr: Lear Siegler, Inc.

Circle 45 on Reader Service Card

TITANIUM-BONDED STYLUS



● A new economy version of the Shibata stylus, for use in the playback of discrete four-channel records utilizes a titanium bonding technique. The new tip requires less square rod diamond material than the present stylus, yet is reported by the manufacturer to exhibit the super lapping and fine polishing of the more expensive full nude diamonds. It is hoped that this new process will be reflected in quality economy cartridges.

Mfr: JVC America, Inc.

Circle 46 on Reader Service Card



The New Revox A700 — \$1695
turn your dreams into reality
at your nearest Revox dealer

Circle 29 on Reader Service Card

HIGH FIDELITY TRANSDUCER



● Using a crossover network and spectral balance switch which permits three repeatable spectral energy profiles, Model LST-2 permits the user to select the energy output best suited for room acoustics and program material. According to the manufacturer, the geometric design of the cabinet, along with the characteristics of the drivers in the three planes results in uniform dispersion at all frequencies. Included in the unit is a ten inch suspension woofer, three 1½ inch mid-range hemispherical dome radiators, and three ¾ inch hemispherical dome tweeters.

Mfr: Acoustic Research, Inc.

Price: \$400.

Circle 52 on Reader Service Card

PROGRAMMABLE POCKET-SIZED CALCULATOR

● One program containing up to 100 steps or many programs totaling 100 steps, can be recorded on a single tiny card used in HP-65 calculator. Users may write and edit their own programs or use prerecorded programs developed for the calculator, which solve many frequently encountered engineering problems. There are 51 keyboard functions preprogrammed into the machine. Prerecorded programs include: finding L or C to resonate with a known L or C at some frequency; computing the impedance of an arbitrarily long ladder network containing series or shunt R, L, and C, a transmission line impedance transformer, and S to Y parameter conversion and vice-versa; calculating six Fourier coefficients for any number of data points. The user may perform branching, logic comparisons and conditional skips in his programs. Mathematical functions encompass logarithms, square and square root, exponential, factorial, reciprocal, and trigonometric functions. The calculator can add and subtract in degrees, minutes, and seconds format, as well as in units of time. It will work in



degrees, grads and radians and will convert octal-based integer numbers to decimal-based integer numbers and back. Programs devised may be stored for later recall. A led display can be set up to show results in either fixed or scientific notation. The program can be changed or edited at any time; it is not necessary to rewrite the entire program when an error is made.

Mfr: Hewlett Packard

Price: \$795.

Circle 53 on Reader Service Card

TONE GENERATOR



● Designed for compatibility with audio automation systems, CD25G 25Hz tone generator is intended for insertion of the standard 25Hz audio automation actuating tone, operating with all audio sources at output levels up to +8 dBm. A start button places the tape transport in motion and the tone button applies the 25 Hz tone and stops the transport after a pre-determined adjustable period of tone application. An internal gating circuit mutes the audio to eliminate bias pops and other start/stop noises on the finished tape. The unit contains a 25 Hz tone filter and bridging input. It fits standard 19 inch racks, allowing for 1¾ inch EIA mounting.

Mfr: Control Design Corporation
Circle 54 on Reader Service Card

NEW!

AUDIO LEVEL OPTIMIZER FOR AM, FM, TV

gives you

PROTECTION FROM PEAKS
HIGHER AVERAGE PROGRAM LEVEL
GATED TO ELIMINATE AUDIBLE EFFECTS



ONE UNIT - ONE LOW PRICE - \$680

■ Selectable peak limiting and average compression functions ■ Fast peak limiting—no clipping ■ Gated operation with Gain Hold, Hold and Release, Hold and Fade functions ■ Adjustable limiting symmetry for full carrier modulation ■ Built-in Frequency Selective Limiter for FM and TV optional for \$25.



INOVONICS
INCORPORATED

1630 Dell Ave., Campbell, CA 95008 Phone: (408) 374-8300

Circle 33 on Reader Service Card

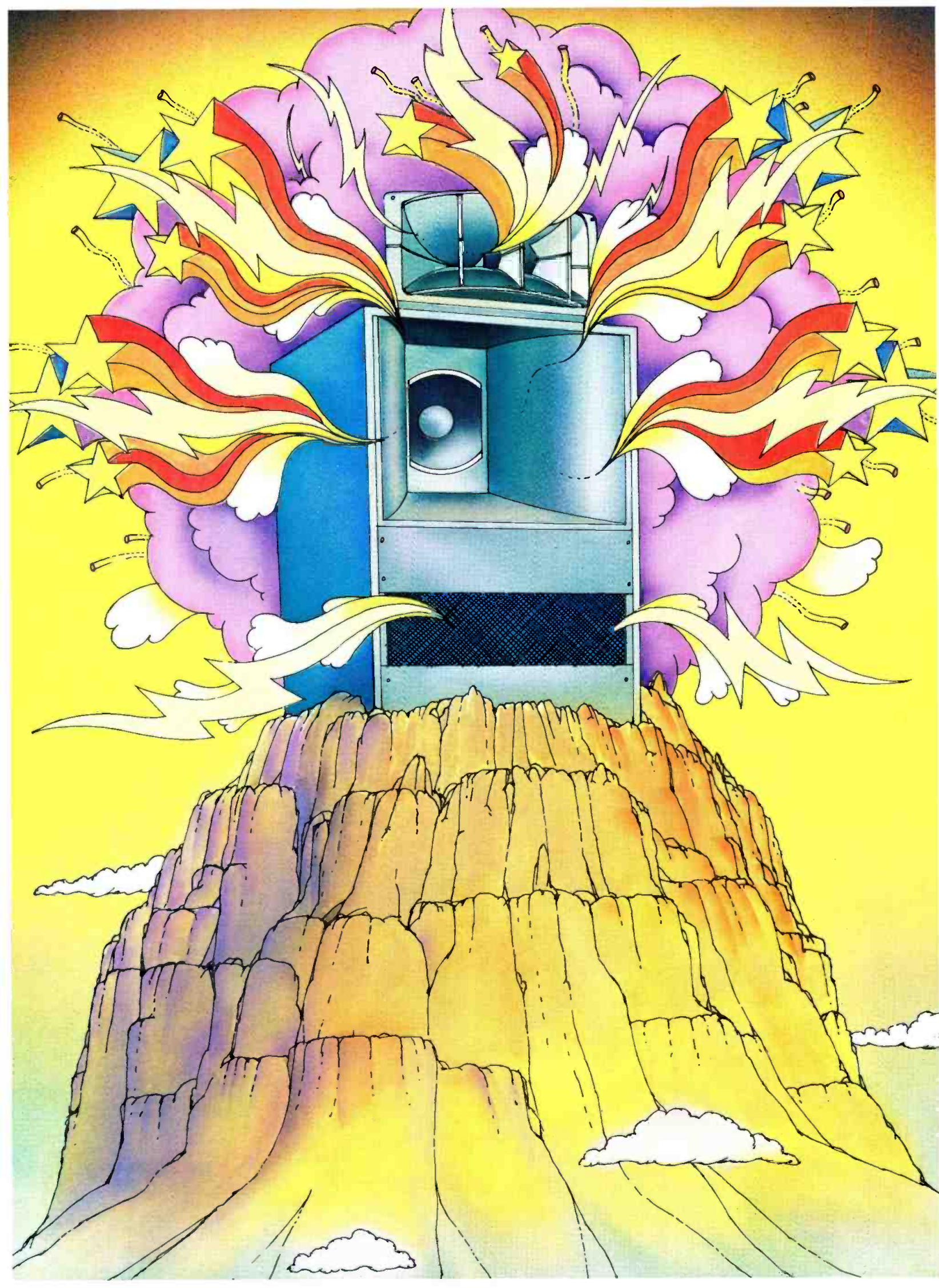

Altec, we challenge you.

Any company that achieves a position of leadership must be prepared to meet the challenge of innovation. In the recording industry, this is a particularly crucial factor – because constantly evolving musical material demands ever newer and better recording techniques.

For nearly 30 years, one name has dominated the studio monitor market. Altec. In 1973, Altec had more than twice as many speakers in recording studio use in the U.S. than its nearest competitor. And nearly as many as all other brands combined. (Source: Billboard's 1973 International Directory of Recording Studios.) That's leadership without question.

Now someone is about to challenge that leadership. Us.

Our first step: introduce three all-new monitor loudspeakers. They're a whole new breed, designed for tomorrow's recordings. And they exceed the performance characteristics of every monitor ever made. Including Altec's.

They're packed with improvements and specs guaranteed to satisfy the goldenest of ears. Improved accuracy and definition. Better transient response. Flatter frequency response. Greater bandwidth. Greater power handling. And much more.

Add to all that our 37-plus years in the field of sound reproduction, and we think we're ready to challenge the leader.

Even if we have to do it ourselves.

ALTEC

the sound of experience.

1515 S. Manchester
Anaheim, Calif. 92803

The challengers.

From front to back, it's the 9849A, the 9846-8A and the 9848A. If you listen for a living, you should know more about them.

Write or call. We'll send you all the facts and figures.



Circle 34 on Reader Service Card

A Note From The Publisher

The July, 1973 issue of **db** contained a number of microphone ads which observant readers probably noted were quite different from the ads usually run by manufacturers of microphones. For those of you who did not see that issue, or don't remember it, we are reproducing the ads here in reduced form. You may ask why staid microphone manufacturers last July suddenly became frivolous, thought provoking, or just plain funny. There is an explanation—and it isn't due to anything they ate, drank, or smoked.

It all started when someone (possibly a reader) commented on the cut and dried format of microphone ads. It's true that microphones have an interesting shape; they sometimes create an eye-pleasing layout. But it seemed there must be more to a microphone than just being splashed across a page with a dull description appended to it—some secret inner meaning to the very idea of a microphone. So we conducted a contest, encouraging the ad agencies who prepare microphone ads to do something creative with no holds barred, as long as they were held within the bounds of good taste. The one-third page ads were run in the July special microphone issue.

As you can see, when freed from constraints most agencies produced very unusual ads. We hope they resulted in reader interest, as well as intriguing the advertising people. Winners were judged by the number of reader inquiries resulting from the ads, with an additional professional appraisal made by an advertising agency unconnected with any of the manufacturers involved.

The results were extremely close, so close in fact that there was almost a dead heat among all entries. Nevertheless, on the basis of reader inquiries and third-party judgment of artistic qualities, the following results were announced:

First Prize: Gotham Audio

Second Prize: Turner Microphones

Third Prize: Electro Voice

We hope this contest brought some levity to our readers, some brightness to our pages, and some sales to our advertisers. After all, life isn't made up of frequency response, polar patterns, and input overload. Or is it?

THE WINNING ADS AS THEY APPEARED

FIRST PRIZE



SECOND PRIZE

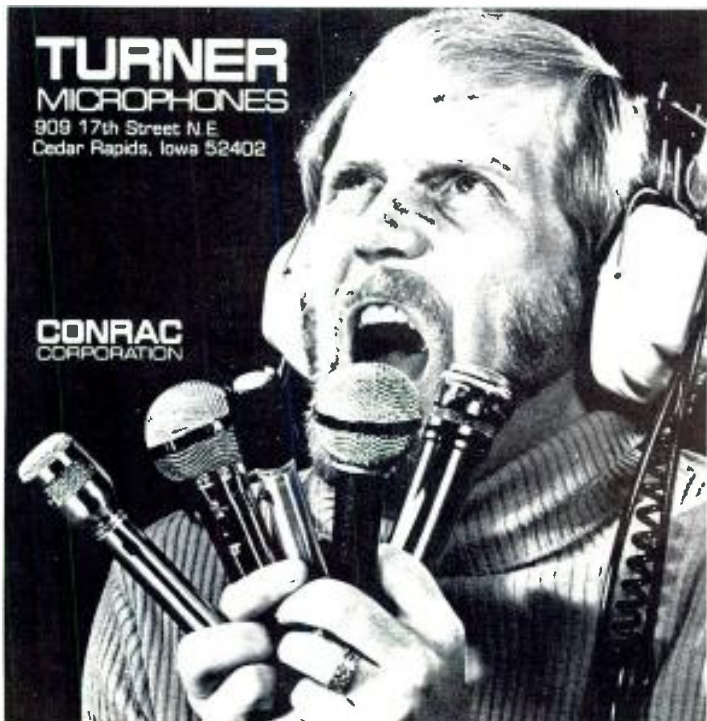

THIRD PRIZE

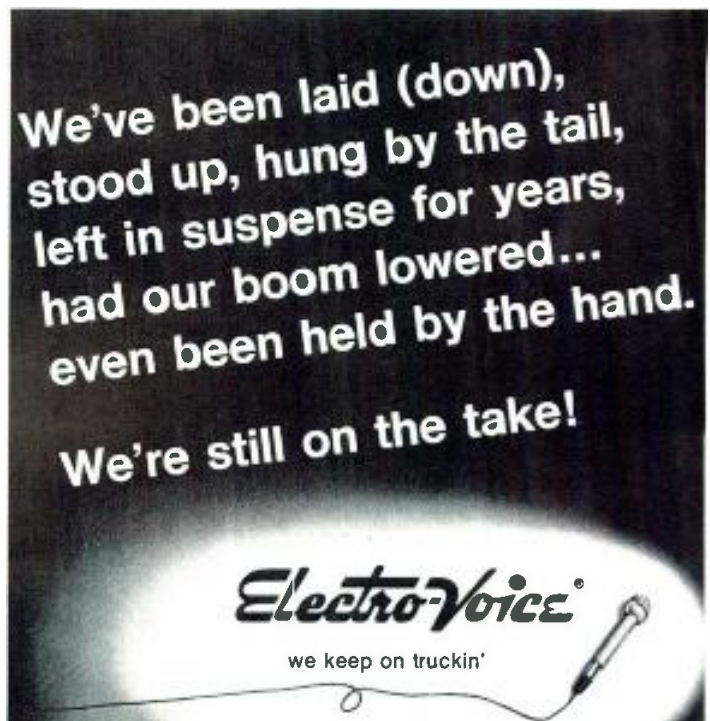

The Decibel: Basics, part II

This is the concluding part to the definitive study of the decibel in audio that was started last month.

WE HAVE DEFINED the decibel as the logarithm of the ratio of two powers. Consequently, the manufacturer in such cases must be comparing the output power of his product with some other power value. This other value is understood to be the common reference or zero level value. Unfortunately, this common reference can also be a source of confusion, due to the fact that through the years different values have been used. Therefore, zero-level could refer to 1 milliwatt, 6 mW, 12.5 mW or even 50 mW; and when considering high impedance microphones, the reference could be 1 volt. An attempt has been made to clear up some of the confusion by using the notation dBm when the reference level is 1 milliwatt across 600 ohms and dB6m for a reference level of 6 milliwatts across 500 ohms. The notation dBV for microphones signifies decibels referred to 1 volt.

Example 12: A directional television antenna is listed as having 9 dB gain.

$$\text{db} = 10 \log P_1/P_2$$

where P_1 = pick-up power of directional antenna
 P_2 = pick-up power of standard point source antenna with equal response in all directions.

$$9 = 10 \log P_1/P_2$$
$$0.9 = \log P_1/P_2$$
$$8 = P_1 \qquad P_2 = \text{unit power}$$

This means that the directional antenna, when properly oriented, has 8 times more gain in a specific direction than a standard point source reference antenna.

Example 13: A high impedance microphone has a rating of -57 dBV. Find its open circuit voltage.

- Solution: 1. The understood reference level is 1 volt for a sound pressure level of 1 dyne per square centimeter.
2. The rating is a minus value, therefore the output level is less than the reference level and thus becomes the denominator of the ratio in the dB equation.

$$\begin{aligned} \text{dBV} &= 20 \log E/E_0 \\ 57 &= 20 \log E/E_0 \\ 2.85 &= \log E/E_0 \\ E/E_0 &= \text{antilog } 2.85 \\ E_0 &= E/\text{antilog } 2.85 \\ &= 1/7.1 \times 10 \\ &= 0.0014\text{V} \end{aligned}$$

In both the above examples of decibel notation and usage we have been expressing gain or loss in terms of power. Each notation expressed power directly as P_1 and P_2 or as E_1/E_2 when the corresponding resistances were equal, thereby maintaining the power equation. However, you will often find that manufacturers and engineers add to the decibel confusion by expressing *voltage gain in dB*. In other words, they sometimes use the dB equation: $20 \log E_1/E_2$ without regard to *resistance* values. Since in many cases the input and output resistances of a network or component are not equal, the expression no longer represents a power relationship. Under these conditions the solution merely indicates voltage gain in dB!

Of course, if the distinction were clearly noted in specifications, the confusion would be alleviated. Nevertheless, let's make sure we understand the nomenclature. To begin with *dB gain (or loss)* or *dB power gain* are expressions that should be used in reference to actual power comparisons, using power ratios or the voltage ratio when the resistances (input and output) are equal. On the other hand, *voltage gain in dB* should be expressed when $20 \log$ (voltage ratio) is used as the equation, when the associated resistances are not equal, and no corrective measures are used to compensate for the unequal resistance values.

An example may clarify understanding.

Example 14: A 50 watt amplifier requires 0.5V input for rated output. If the input resistance is 40,000 ohms and the output resistance is 8 ohms, find the power gain in dB and the voltage gain in dB.

$$\begin{aligned} \text{Power gain: } P_{in} &= E_{in}^2/R_{in} = 0.5 \times 0.5/40,000 \\ &= 0.25/40,000 = 6.25 \times 10^{-6} \end{aligned}$$

$$\begin{aligned} \text{dB gain} &= 10 \log P_o/P_{in} = 50/6.25 \times 10^{-6} \\ &= 10 \log 8.0 \times 10^6 \\ &= 10 (6.9031) \end{aligned}$$

$$\text{Power gain} = 69 \text{ dB}$$

Voltage gain in dB:

$$\begin{aligned} E_o &= \sqrt{P_o R_o} = \sqrt{50 \times 8} = \sqrt{400} = 20\text{V} \\ \text{dB gain} &= 20 \log E_o/E_{in} \\ &= 20 \log 20/0.5 \\ &= 20 \log 40 \\ &= 20 (1.6021) \end{aligned}$$

$$\text{Voltage gain} = 32 \text{ dB}$$

By now, it should be clear that most of the haze surrounding the decibel is due to poor definition of associ-

ated terms, such as v_u , phon, dBV, dBm, etc., as well as misleading terminology and non-uniformity in rating and referencing. Consequently, if we understand the association of terms and comprehend reference values and their usage, the misleading terminology will drift away from the haze.

Microphone manufacturers use a special type of decibel notation in their rating of microphone output. Their method is not strictly uniform, as can be noted by the microphone specifications at the very beginning of this article.

1. 58 dB below 1 mW per 10 microbar signal at 200 ohms
2. 50 dB below 1 volt/dyne/cm²

To thoroughly understand these statements, we must consider some basic facts.

Although transmission lines may be thousands of feet long in sound distribution, they are nevertheless considered "short lines" because the shortest audio wavelength is long compared to its transmission line. Therefore, we need not consider characteristic impedance, retardation time, etc., such as would be necessary for miles and miles of telephone line. This means that the defining characteristic of our "short line" is the *impedance* to which it is connected. In other words, a low impedance line is so called, not because of any inherent quality of the line itself, but because it is connected to a low impedance load from a low impedance source. A high impedance line is a pair of wires connected to a high impedance load.

How does all this effect microphone ratings? Like this—the fluctuating pressure of air molecules upon the diaphragm varies the output of the microphone. In order to have a meaningful yardstick by which to rate the outputs of various microphones, a standard unit of pressure was needed. The pressure reference most often used is the *bar*, but a 10-bar reference is also quite common. Many manufacturers consider the bar as the cgs unit of pressure, equivalent to one dyne per square centimeter. Thus, microphones are usually rated as so many decibels below a zero reference power or voltage level for a zero reference pressure level.

As you probably know, microphones are classified, in general, according to their impedance, as low or high. Low impedance microphones are used for long runs (75 feet-2000 feet-), while high impedance microphones are used for short runs (to 75 feet). In a low impedance load, the voltage is low and the current high. Since power is proportional to current squared, line loss could be a substantial percentage of the total power output. Therefore, output power is an important factor in the consideration of low impedance microphones. Consequently, these microphones are usually rated in decibels below a reference power level (1 mW, 6 mW) at a reference pressure level (microbar, bar).

To determine the output of a microphone from its decibel rating two things must be kept in mind.

1. The decibel rating must be expressed in terms of the reference pressure. If a change in pressure occurs, the new rating can be found by:

$$\text{dB}_R = 20 \log B/B_R$$
 where dB_R = decibel output rating at new pressure
 B = new pressure
 B_R = reference pressure

2. Determine microphone output power by using our standard decibel equation 1.1:

$$\text{dB} = 10 \log P_R/P$$

$$\begin{aligned} \text{where } P_R &= \text{reference power} \\ P &= \text{output power} \end{aligned}$$

Example 15: Opening spec #1) 60 dB below 1 mW per 10 bar signal.

$$\begin{aligned} \text{dB} &= 10 \log P_R/P = 10 \log .001/P \\ 60 &= 10 \log .001/P \\ 6 &= \log .001/P \\ 10^6 &= .001/P \\ P &= .001/10^6 \\ &= .001 \text{ microwatts} \end{aligned}$$

For a 300 bar signal:

$$\begin{aligned} \text{Output rating} &= 20 \log B/B_R = 20 \log 300/10 \\ &= 20 \times 1.477 \end{aligned}$$

$$\text{Output rating} = 29.54 \text{ dB}$$

$$\text{Output} = -60 + 29.54 = -30.46$$

$$\begin{aligned} P &= P_R/(\text{antilog dB}/10) \\ &= .001/(\text{antilog } 30.45/10) \\ &= .001/1.12 \times 10^3 = (1/1.12) \times 10^{-6} \end{aligned}$$

$$\text{Power output} = .893 \text{ microwatts}$$

High impedance circuits are characterized by high voltage and low current. Consequently, high impedance microphones are rated as to their voltage output. The rating is based upon decibels below one volt per microbar pressure, and our standard decibel equation (power expressed in terms of voltage, impedance being equal) is utilized to find the open circuit voltage output.

Example 16: Opening spec. #2) 54 dB below 1 volt/dyne/cm²

$$\begin{aligned} \text{dB} &= 20 \log E_R/E_0 \\ 54 &= 20 \log 1/E_0 \\ 2.7 &= \log 1/E_0 \\ 1/E_0 &= 5.07 \times 10^2 \\ E_0 &= 1/5.07 \times 10^{-2} \\ &= .00197 \text{ volt} \end{aligned}$$

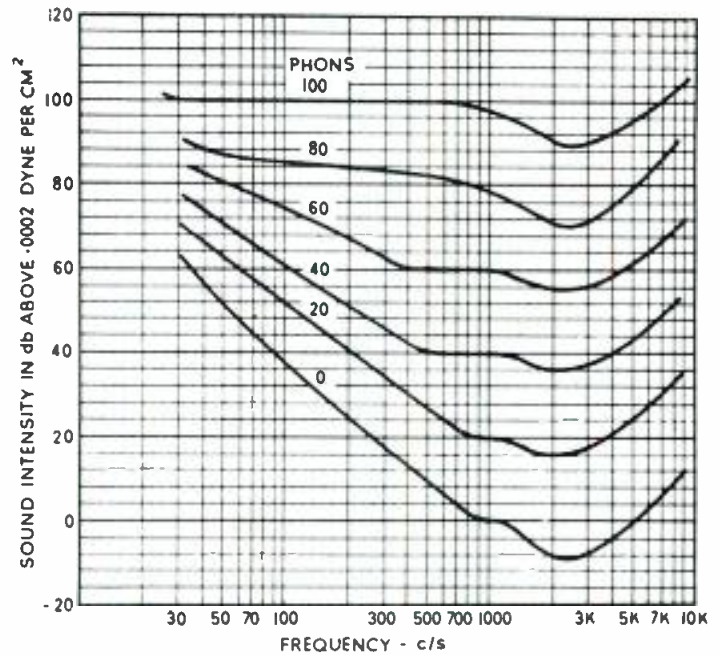

Figure 3. The Fletcher-Munson curve.

Now that we understand microphone specifications and ratings, we need only investigate the other few audio units of measurement to penetrate any remaining haze that may exist as to their relationship to the decibel.

As you now know, the decibel is a unit of measure that indicates a change in sound intensity. When this intensity is referenced to a power of 1 milliwatt dissipated across 600 ohms, the decibel expression is then equated to dBm:

$$\begin{aligned} \text{dBm} &= 10 \log P/.001, \text{ where } P \text{ is the sound intensity.} \\ \text{dBm} &= \text{decibels referenced to 1 milliwatt} \end{aligned}$$

Example 17: Opening spec. #3) 8 dBm

$$\begin{aligned} \text{dBm} &= 10 \log P/.001 \\ 8 &= 10 \log P/.001 \\ 0.8 &= \log P/.001 \\ 6.35 &= P/.001 \end{aligned}$$

$$P = .001 \times 6.35 = .00635 \text{ watts}$$

Therefore 8 dBm = a power ratio of 6.35 milliwatts above the reference level of 1 milliwatt.

Decibel then, or plain dB, is expressed when our reference level is 6 mW across 500 ohms and dBm refers to 1 mW across 600 ohms.

One of the unique features of decibel notation is that it correlates an electrical characteristic and a physical response. Keeping in mind that such notation usually refers to sine wave signals, the electrical and physical correlation is nevertheless useful for monitoring signal levels in transmission lines and throughout the broadcasting process.

But audio signals of speech and music are not simple sine waves; they are complex waves, of which the instantaneous value is the algebraic sum of all fundamental, harmonic, and sum and difference frequencies. In order to measure and compare the relative amplitudes of these complex signals, telephone and broadcasting engineers, in 1939, designed a special meter. Since the function of this meter was actually to indicate the rms level or volume of complex waves, it was calibrated in volume units and called a *vu meter*.

The volume unit (vu) is also logarithmic and its standard reference value is 1 milliwatt in a resistance of 600



Circle 41 on Reader Service Card

ohms. It is, therefore, numerically equal to dBm, that is, a 1 vu change is equal to a change of 1 dBm. Keep in mind, though, that the difference between vu and dBm is in their application. Vu can be a measure of complex signal levels, or *sinusoidal*, wave forms, whereas dBm specifies steady tone (*sinusoidal*) audio output.

The equation for finding the value of vu is as follows:

$$vu = 10 \log P / .001$$

Example 18: Opening spec. #4 -4 vu

$$4 = 10 \log .001 / P \quad (\text{Minus value is}$$

$$0.4 = 10 \log .001 / P \quad (\text{less than refer-}$$

$$2.56 = .001 / P \quad (\text{ence value)})$$

$$P = .001 / 2.56 = .00039$$

$$= 390 \text{ microwatts}$$

Minus 4 vu represents a power level 390 microwatts below the 1 milliwatt reference.

From a practical standpoint, since voltage can readily be measured in an operating circuit, the following modified equation may be useful.

$$vu = 20 \log E / 0.775 + 10 \log 600 / R$$

where E = rms value of signal voltage

R = resistance across which signal is measured

.775 and 600 = voltage and resistance parameters of reference power

Due to the design and ballistics of the vu meter with the high rise and slow fall of the pointer movement, this special meter will indicate 10 dBm higher on sinusoidal signals than on program material. Since audio tests and measurements are normally performed with steady signals and expressed in dBm, in order to arrive at safe operating

values for vu meter monitoring, 10 dBm should be subtracted from manufacturers' specifications. For example, if a line amplifier is rated for +20 dBm output, its operating level in volume units should be +10 vu.

The *phon* is a cousin to the decibel. It is a measure of the *loudness* of sound as perceived by the human ear; as the decibel is a measure of the *intensity* of sound as perceived by that same organ. The ear responds logarithmically to sound intensities. A sound of 10 units seems just as much louder compared to a 1 unit sound as a 100 unit sound seems to 10 units, even though the absolute intensity difference is 90 units in one case and only 9 units in the other. This means that for the ear to sense twice as much sound from an audio amplifier delivering a 10 watt pure tone, the power output or intensity would have to increase logarithmically (10^2) to become 100 watts.

The loudness of sound is a function of frequency as well as amplitude. The ear responds differently to different audio frequencies. The Fletcher-Munson Graph, FIGURE 3, which relates decibels and phons to frequency, shows the comparison in ear response of various loudness levels at different frequencies. Each curve shows the increase or decrease in dB sound intensity necessary to create the same loudness at a given frequency. As you can see, at 1000 Hz the sound intensity increases linearly from the threshold of hearing to the sensation of feeling. Therefore, at this reference frequency we have a loudness scale according to which an increase in the intensity of sound at the source produces a corresponding (linear) increase in sound intensity to the ear. This scale represents loudness levels expressed in phons, where zero phons at 1000 Hz represents 10^{-16} watts per square centimeter or .0002 dynes/cm². ■

Orban/Parasound Reverb:

THE LIVE ONE

It's one of the more pleasant aspects of being on the road. It gives reliable studio-quality reverb without hauling ten-ton concrete echo chambers or two-ton steel plates. Our 9 lb., 1-3/4" rack mount unit has been redesigned to interface more easily with semi-pro equipment (like many PAs) and its spring delay line locks instantly from the outside to protect against the inevitable jolts and jounces.

Of course, it's also quite content to sit motionless in your studio, quietly solving your space and/or budget problems. And giving you the kind of quality you didn't think a spring could deliver.

The Orban/Parasound Model 106C is a modest, but well-engineered device offering a built-in FET limiter and a four-frequency mid-

range peaking equalizer. Not to mention a +20 dBm balanced output and 115/230 volt international power capabilities.

The Orban/Parasound Reverb: it's live enough for anyone. Even the Grateful Dead. (Or for that matter, any one of a hundred other recording studios, broadcasters, and travelling professional shows.)



ORBAN/PARASOUND

680 Beach St., San Francisco, Ca. 94109. (415) 776-2808 or contact your local Orban/Parasound distributor.

Nobody ever made a monitor that could match this sound.



Type of System	4-way
Components	(2) 15" low frequency loudspeakers (1) 12" midrange loudspeaker (1) High frequency compression driver with horn lens (1) Ultra high frequency compression driver
Frequency Response	30 to 20,000 Hz \pm 3dB
Sensitivity (SPL at 30' 1mW)	46.5 dB
Power Output (SPL at 10 ft. in a room volume of 2000 cu. ft. with 1/2 rated power input - 150 watts)	110dB
Crossover Frequency	250, 1100 and 9000 Hz
Size	35"x48"x20"
Net Weight	243 lbs (110 kg)
Configuration	Bi-amplification only
Price	Utility finish shown \$1314 Walnut finish \$1464

The 4350. Three years ago JBL's technical staff was asked to produce the best studio monitor that technology and artistry could create. That was their total assignment. Considerations of cost and monitor size and studio application were secondary. The search was for a sound. The name was 4350. Its birthday was April 13, 1973. And, from the day it was born, it was the best sounding studio monitor money could buy:

A virtually flat frequency response from 30 to 20,000 Hz. Minimum phase shift throughout the entire band pass. Extraordinary response to onset and transient signals. Carefully controlled, semi-diffuse dispersion pattern throughout the frequency range. Uniform sound characteristics from *ppp* to *fff* dynamic markings. Extremely low transducer distortion within the recommended dynamic range values of more than 90dB. High sensitivity for maximum conversion efficiency.

But, wait. A spec is not a sound. Come hear the 4350 and see how far sound can go.

Until now.

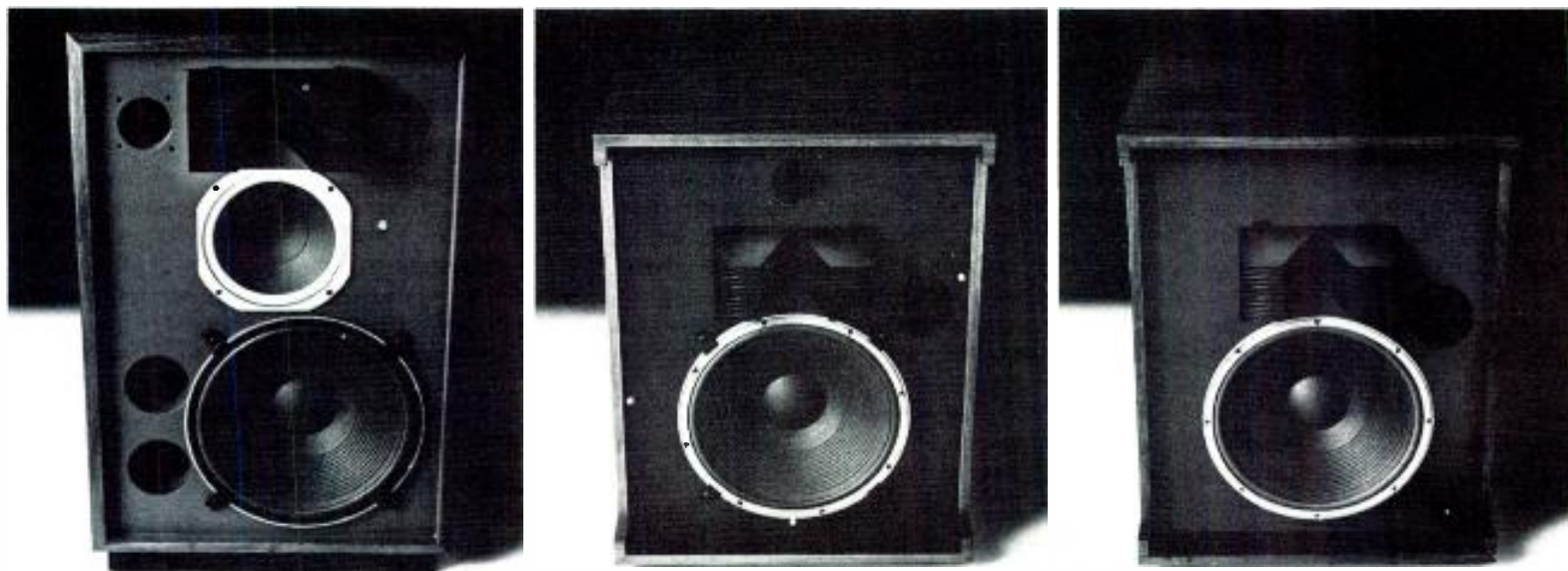

	The 4340/41	The 4332/33	The 4330/31
Type of System	4-way	3-way	2-way
Components	(1) 15" low frequency loudspeaker (1) 10" midrange loudspeaker (1) High frequency compression driver with horn lens (1) ultra high frequency compression driver	(1) 15" low frequency loudspeaker (1) High frequency compression driver with horn lens (1) Ultra high frequency compression driver	(1) 15" low frequency loudspeaker (1) High frequency compression driver with horn lens
Frequency Response	35 to 20,000 Hz \pm 3dB	35 to 20,000 Hz \pm 3dB	35 to 15,000 Hz \pm 3dB
Sensitivity (SPL at 30' 1mW)	44dB	44dB	44dB
Power Output (SPL at 10 ft in a room volume of 2000 cu ft with 1/2 rated power input - 37.5 watts)	101dB	101dB	100.5dB
Crossover Frequency	250, 1250 & 9500 Hz	800 and 8500 Hz	800 Hz
Size	38"x24"x20"	30"x24"x20"	30"x24"x20"
Net Weight	179 lbs (81 kg)	121 lbs (55 kg)	96 lbs (44 kg)
Configuration	for bi-amplification or with high level network	for bi-amplification or with high level network	for bi-amplification or with high level network
Price	to be announced	to be announced	to be announced
Availability	June 1974	June 1974	June 1974

Four monitors. Virtually one sound. A matched set: you could record on one, play back on another, mix on a third and master on a fourth.

Four monitors. Their only differences are acoustic output, cost and size.

Hearing is believing. Come hear what you can do.



48th AES Convention and Exhibition

ON THESE PAGES, we present the essential program and an exhibition map of the Audio Engineering Society's 48th Convention and Exhibition to be held at the Los Angeles Hilton Hotel. The dates are May 6 through May 10, 1974.

Schedule of Events

Mezzanine, Los Angeles Hilton

REGISTRATION

Monday May 6 —1:00 to 5:00 P.M.
(Set-up and Exhibitors)
Tuesday May 7 —8:00 A.M. to 8:00 P.M.
Wednesday May 8 —8:30 A.M. to 8:30 P.M.
Thursday May 9 —9:00 A.M. to 5:00 P.M.
Friday May 10—9:00 A.M. to 5:00 P.M.

EXHIBIT HOURS

Tuesday and Wednesday, May 7 and 8
1:00 P.M. to 9:00 P.M.
Thursday and Friday, May 9 and 10
11:00 A.M. to 5:00 P.M.

DEMONSTRATION ROOMS

Foy, St. Louis, Dallas, Hartford, New York, Buffalo, Boston, Detroit, Washington, Cleveland, Mission, Studio A, Panel Room (All on Mezzanine Level)

TECHNICAL SESSIONS

Golden State Room, Sessions A, C, E, G, J, L, O
Los Angeles Room, Sessions B, D, F, H, K, M, N

TUESDAY, May 7

9:30 A.M.—A—Digital Techniques in Audio
9:30 A.M.—B—Audio in AM/FM/TV Broadcasting
2:00 P.M.—C—Disc Recording and Reproduction
2:00 P.M.—D—Transducers
7:30 P.M.—E—Electronic Music
7:30 P.M.—F—Education in Audio

WEDNESDAY, May 8

9:30 A.M.—G—Quadraphonics
9:30 A.M.—H—Motion Picture Sound
2:00 P.M.—J—Sound Reinforcement and Architectural Acoustics
2:00 P.M.—K—Magnetic Recording and Reproduction

THURSDAY, May 9

9:30 A.M.—L—Signal Processing
9:30 A.M.—M—Acoustical Noise Control and Studio Design
No afternoon sessions—an opportunity to visit the exhibits
7:00 P.M. Social Hour—Los Angeles Room
8:00 P.M. Awards Banquet—Golden State Room

FRIDAY, May 10

9:30 A.M.—N—Audio Instrumentation and measurement
No afternoon sessions—visit the exhibits until 5:00 P.M.
7:30 P.M.—O—Recording Studio Workshop

SOCIAL AND CULTURAL ACTIVITIES

A program of activities is planned for those not directly involved in Convention activities. There will be a meeting at 9:00 A.M. each day, where coffee will be served, before commencing the day's outing. Suite number will be posted. Chairwoman: Mrs. Ethelyn Glancy

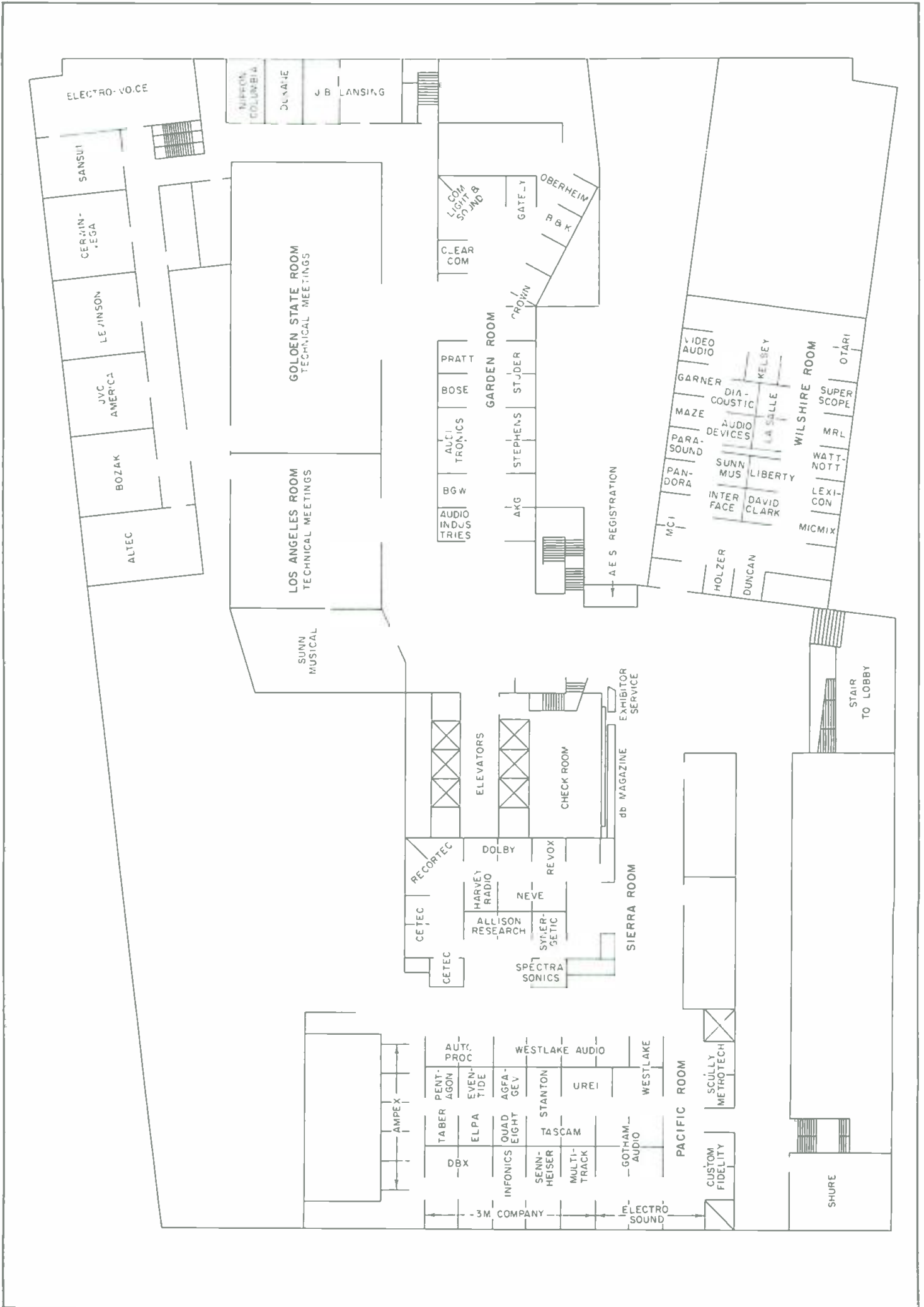

Impedance Matching for the Sound Engineer, part I

Impedance matching is vital to the correct flow of audio information. And though it seems that things are cut and dry, often they are not. The author, an authority on the subject, uses basic math to lead you along to a thorough understanding of the relationship of impedance in to impedance out.

IMPEdance, next to the decibel, is probably one of the most often used terms in the audio engineer's vocabulary. Again, in common with the decibel, the word *impedance* rarely can be even defined properly by its user. Even less often is it handled correctly in sound systems.

This is an industry where many of the best practitioners are largely self taught. Yet, a sampling of questions based on a practical system problem immediately stumps a majority of the recent electrical engineering graduates from state universities. Therefore, more discussion of common practices and mispractices can be profitably carried on.

IMPEDANCE DEFINED

What is impedance? Is it resistance? Sort of, reply some. Many a technician has put an ohm meter across the voice coil of a 16 ohm loudspeaker impedance and been surprised to read 4.5 ohms or less. What has he read with

the ohm meter? The d.c. resistance of the voice coil. Fine—is it the impedance? No.

Now, let's get a "bridge circuit" to read the a.c. resistance (R) of the loudspeaker. Is this the impedance? No. but it's part of the impedance.

Then, what is impedance? According to the *Modern Dictionary of Electronics* published by Howard W. Sams, impedance is defined as: "The total opposition (i.e., resistance and reactance) a circuit offers to the flow of alternating current. It is measured in ohms and its reciprocal is called admittance."

What are these words, *opposition* and *reactance*? We all know what resistance is. Opposition means resistance, restraint, hindrance, etc. From this we can conclude that in alternating current circuits there exists some other resistance-like component and this additional restraint which adds to that of the a.c. resistance is called *reactance*.

The word reactance has in the dictionary, as a synonym, the word, opposition.

Reactance comes in two flavors: capacitive reactance (X_C) and inductive reactance (X_L). X stands for reactance and the sub C means capacitance and the sub L signifies inductance. These two familiar companions should alert

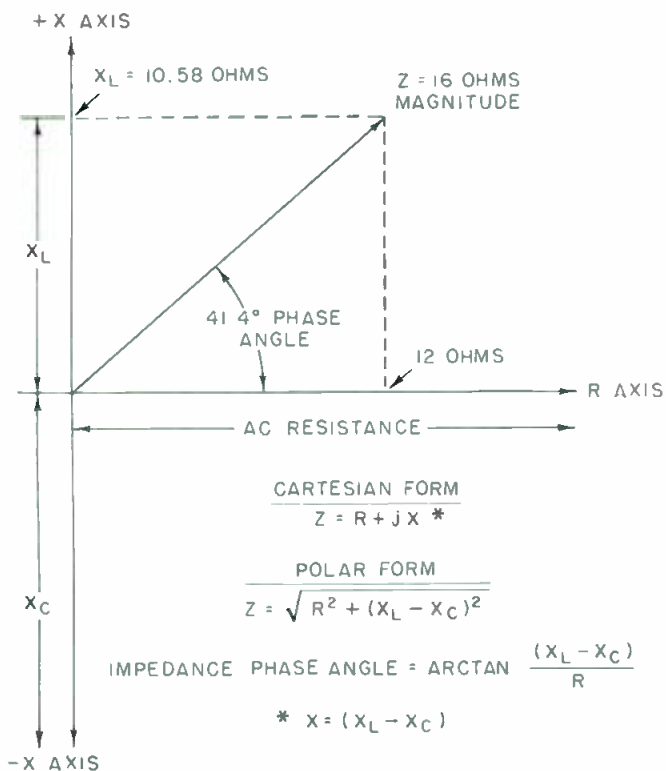

Figure 1. Calculating impedance.

the engineer to the awareness that reactance varies with frequency, whereas a.c. resistance tends to stay the same with frequency (certainly over the audio range).

Now, let's add one more term to our collection and proceed to measure an impedance. Let's call impedance (Z). With this addition, we can now list the terms we have developed:

- R = a.c. resistance
- X = Reactance ($X_L - X_C$) = X
- X_C = Capacitive reactance
- X_L = Inductive reactance
- Z = Impedance

If we now measure voltage and current in a real circuit,

Figure 2. An open circuit voltage compared to a matched circuit. A rule is: A source is working into its rated impedance when that impedance causes a 6 dB drop in level when placed across an open circuit voltage.

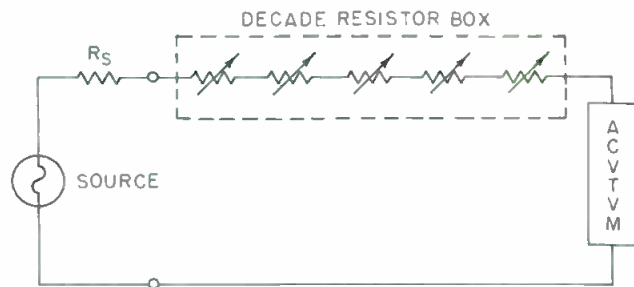
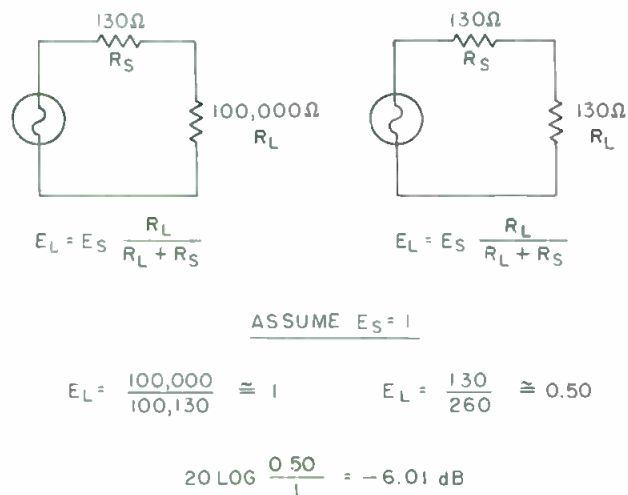

Figure 3. Finding impedance with a decade resistor box and an a.c. v.t.v.m. To do this turn the decade resistor box to its highest resistance (i.e. 100,000 ohms). Then read the open circuit voltage on the a.c. v.t.v.m. Next adjust the decade resistor box downward in resistance until the a.c. v.t.v.m. is 6 dB below the reading for open circuit. Finally, the total resistance reading of the decade resistor box now equals the magnitude of the source impedance.

we will find that when inductor-like devices are in the circuit, the current lags (in phase) behind the voltage and that when a capacitor-like device is in the circuit, the current leads (in phase) the voltage.

MAKING REACTANCE VISIBLE

By setting up a standard way of plotting reactances we can visually see plots of their action and interaction. Our old friend from high school days comes to the rescue with rectangular coordinates. Translated into electronics, it means the components that are 90 degrees apart in phase are represented by vectors that on a plain sheet of paper are 90 degrees apart. (See FIGURE 1.) From FIGURE 1 we can write the following formulas for impedance:

Cartesian Form

$$Z = R + jX \quad X = (X_L - X_C)$$

This describes how to plot the action on the chart shown. The j tells us that X is 90 degrees away from R.

Polar Form

$$Z = \sqrt{R^2 + (X_L - X_C)^2}$$

$$\text{Impedance phase angle} = \arctan \left(\frac{X_L - X_C}{R} \right)$$

These equations describe how to obtain the magnitude of the impedance vector and the phase angle between it and 0 degrees on the a.c. resistance axis.

It can be seen by inspection of FIGURE 1 that when phase angles are small, the impedance value approaches the a.c. resistance value, and conversely, when phase angles are large the reactive component must be carefully measured. The performance of transformers, loudspeaker voice coils, etc., are examples of conditions that exhibit large phase angles. Link circuits, passive attenuators, etc., normally exhibit small phase angles. In most normal audio work it is the magnitude of the impedance (the length of the vector Z) that is of importance in terms of building out, terminating, or matching impedances. Only rarely will the typical audio engineer have good reason actually to measure the phase angle, but he should know what it is.

Let's first look at an open circuit and a matched circuit. (See FIGURE 2.) As the circuit and the equations clearly show, a quite normal source in a sound system (many mixers have 130 ohm outputs) which is devel-



Figure 4. A standard type of impedance bridge.

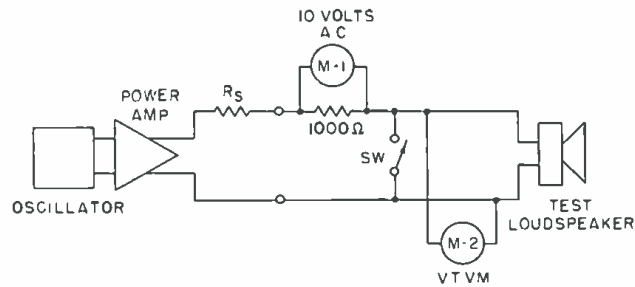

Figure 5. The constant current method of measuring loudspeaker impedance. First, close S_w and adjust power amplifier gain for a 10 volt indication at $M-1$. Then open S_w and read $M-2$ voltage. Finally, multiply $M-2$ voltage $\times 100$ to obtain impedance (values to 100 ohms. Impedance of a loudspeaker ≤ 100 ohms, Power amplifier nominal output impedance = 8 ohms).

oping 1 volt across an open circuit (very high load impedance compared to the source impedance) will drop 6 dB in level when a load impedance equal to the source impedance is provided. This is one of the reasons dynamic microphones rated at 150 ohm input impedance are connected to mixers that present essentially an open circuit termination (usually 3,000+ ohms) in order to improve the signal-to-noise by approximately 6 dB. This also means, however, that in the construction of microphone pads (used when the performer's acoustic input to the

microphone results in an electrical output that would overload the input of the mixer at the very first stage) it is necessary to make them bridging-type pads. That is, the microphone looks into 3,000+ ohms but the first stage of the mixer looks back at 150 ohms.

Our first way of measuring the magnitude of the impedance Z is shown in FIGURE 3. When it is desired to know the magnitude, ζ , the inductive reactance X_L , the capacitive reactance X_C , and the phase angle of each, then the standard CRL type impedance bridge is the ob-

Figure 6. A typical graphic level recorder.

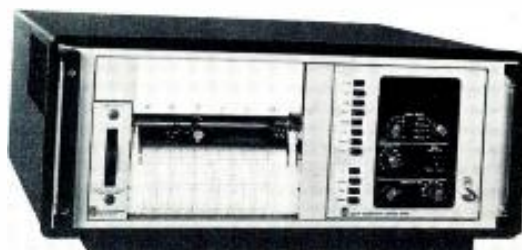

At last, a studio mastering tape that's better than the one everybody's been using.

A while ago, someone came along with a new tape that, admittedly, was a better mousetrap. But it was not the ultimate mousetrap.

There were problems with that tape, good as it was. Problems which we at Audio Devices have been able to solve.

First problem:

How do you get even more energy out of each particle?

Solution:

By improving the dispersion.

Poorly dispersed particles clump together causing magnetic losses due to interaction and energy cancellations.

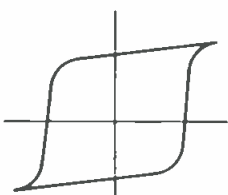

Hysteresis loop of Audiotape HOLN.

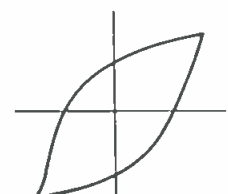

Hysteresis loop of poorly dispersed tape.

The new Audiotape HOLN has higher output and lower noise than the tape you switched to years ago. The new Audio tape iron-oxide particles deliver more energy.

Second problem:

How do you reduce print-through?

Solution:

Uniform particle size and dispersion are part of the solution.



Output vs. bias.

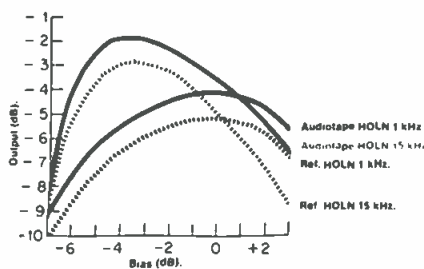

Scully 1 recorder at 15 ips. Input level 0 dB.

Frequency response.

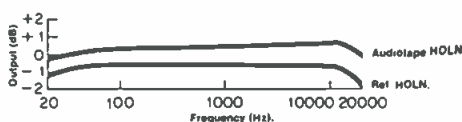

Scully 1 recorder at 15 ips. Bias 0 dB. Input level 0 dB.

Audio's secret processes are the other part. The results aren't secret, though: Audiotape HOLN has reduced print through by at least 2 dB, and typically 3 dB over the tape you switched to a few years ago.

Third problem:

How do you reduce headwear?

Solution:

Use a smooth coating surface with a built-in permanent lubricant. That'll reduce your headwear.

Fourth problem:

How do you improve handling and storage reliability?

Solution:

Use a backcoating that's super-durable. Cushion-Aire™ backcoating, with its controlled surface texture, improves high-speed handling and winding, and eliminates the causes of cinching, spoking, and other pack deformities.



Non-backcoated polyester after 1000 passes.



Cushion-Aire backcoating after 1000 passes.

Another problem is maintaining consistency of product. We've solved that too. By having a superior degree of quality control.

For a complete discussion of the improvements Audiotape features over the leading backcoated tape, send for our detailed literature.

audiotape™

Audio Devices, Inc., A Capitol Industries Company, 100 Research Drive, Glenbrook, Conn. 06906

Circle 37 on Reader Service Card

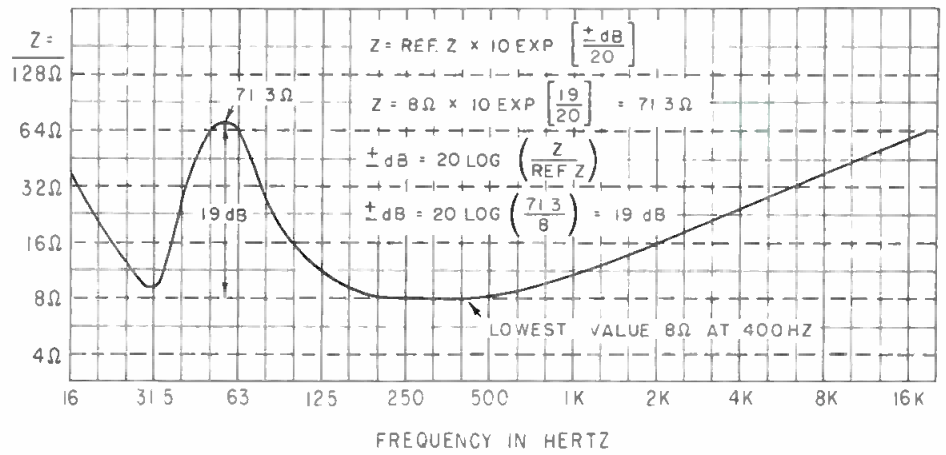

Figure 7. A typical automatic impedance plot.

vious choice. FIGURE 4 shows a standard rugged reliable unit used by literally hundreds of sound engineers today. It has provisions for external oscillator connections as well as a 1,000 Hz internal oscillator. Since it can measure R directly as a.c. resistance and can measure L and C, it is easy to convert to X_L and X_C via

$$X_L = 2\pi fL$$

and

$$X_C = \frac{1}{2\pi fC}$$

Where

- f = the frequency in Hz
- L = the inductance in henries
- C = the capacitance in farads
- X_C = the reactance in ohms
- X_L = the reactance in ohms

From the knowledge of R, X_L , and X_C , the phase angle can be calculated from the formulae given at the beginning of the article.

THE CONSTANT CURRENT METHOD OF MEASURING ZETA

FIGURE 5 illustrates the circuit for measuring Z by what is called the "constant current" method. The amplifier used as a test source is made into an essentially constant current output generator. The 8 ohm tap of a conventional power amplifier usually has an actual output impedance well less than one ohm. Through the use of the 1,000 ohm resistor in series with the test load, such a generator is created.

Many manufacturers use a graphic level recorder (See FIGURE 6) in place of an M-2 meter and obtain automatic impedance plots, such as that shown in FIGURE 7.

Calibrating to any reference Z, the dB difference between the reference Z and any other Z can be calculated by:

$$Z = \text{Reference } Z \times 10 \exp \frac{\pm \text{dB}}{20}$$

and, if the impedance is known, to find the dB difference between it and the reference Z, then:

$$\pm \text{ dB difference} = 20 \log \frac{Z}{\text{Ref. } Z}$$

FIGURE 8 describes an exceptionally efficient and easy-to-build impedance tester designed by Ed Lethert of

Northwest Sound Service, Minneapolis, for use in installing and maintaining motion picture theater sound systems. There are direct reading impedance meters such as the one made by Sennheiser Electronic Corporation, in West Germany. This unit includes three oscillator frequencies and a set of charts for finding X_L and X_C , if desired. Magnitude, Z, is read directly on the meter.

Loudspeaker designers are particularly fond of the GRZY impedance bridge, now available only on the used equipment market. In any case, there are today rapid, accurate, and reliable measuring tools available to the professional audio engineer.

USING IMPEDANCE MEASUREMENTS IN IMPEDANCE MATCHING

Having obtained the measurement, what do you do with it? The most frequent use of an impedance measurement

Figure 8. A direct reading impedance measuring device.

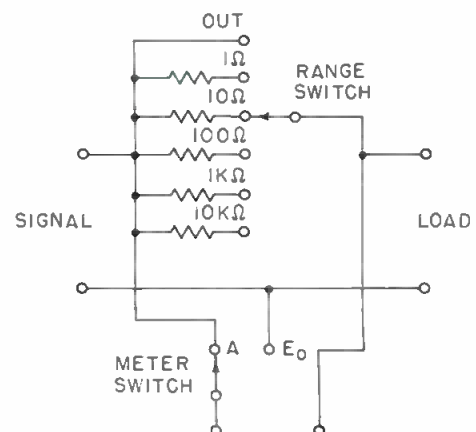
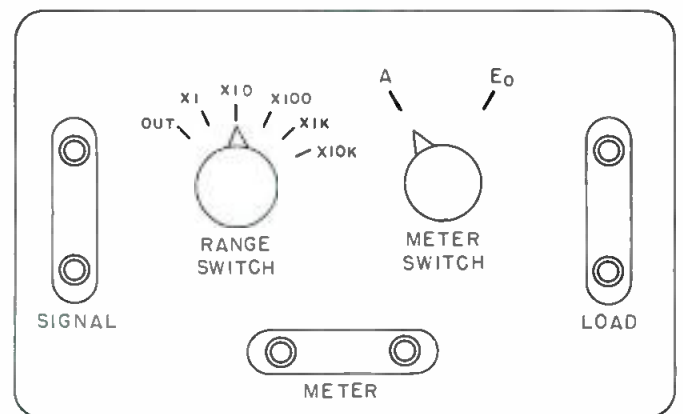

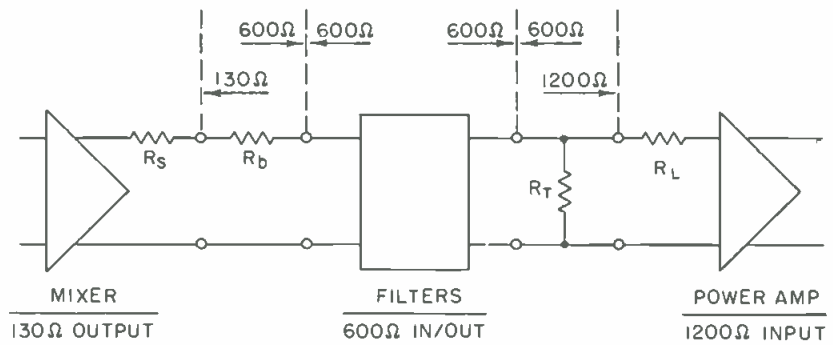

R_S = THE INTERNAL SOURCE Z (AS MEASURED)
 R_b = THE BUILD-OUT RESISTOR VALUE
 R_T = THE TERMINATING RESISTOR VALUE
 R_L = THE POWER AMP INPUT Z (AS MEASURED)
 R_D = THE DESIRED INPUT Z

$$R_b = R_D - R_S \quad \text{EXAMPLE: } 600 - 130 = 470 \Omega$$

$$R_T = \frac{R_L - R_D}{R_L - R_D} \quad \text{EXAMPLE: } \frac{1200 - 600}{1200 - 600} = 1200 \Omega$$

$$R_b \text{ INSERTION LOSS} = 20 \text{ LOG} \left(\frac{R_D}{R_S + R_b + R_D} \right) = 20 \text{ LOG} \left(\frac{600}{130 + 470 + 600} \right) = -4.32 \text{ dB}$$

$$R_T \text{ INSERTION LOSS} = 20 \text{ LOG} \left(\frac{R_D}{R_S + R_D} \right) = 20 \text{ LOG} \left(\frac{600}{130 + 600} \right) = -2.50 \text{ dB}$$

Figure 9. Calculation of build out and termination resistor values and their insertion losses.

audio
 INVITES YOU
 TO THE GRAND
 OPENING OF
 OUR EUROPEAN
 SALES AND
 SERVICE
 SHOWROOM

Audiomatic Corporation, the leader in worldwide distribution of tape duplicating and related equipment, proudly announces the formal opening of their European Office-Showroom in Paris, the week of May 13. In addition to providing our European customers with an immediately accessible inventory of equipment and spare parts, this facility will serve as a demonstration center for these outstanding manufacturers:

- ELECTRO SOUND** tape duplicating equipment and professional recorders
- SHAPE SYMMETRY & SUN** modular equipment for the automated assembly of cassettes
- GRAHAM FRASER** automated packaging equipment
- APEX MACHINE** systems for printing label copy directly on cassettes
- HAMILTON MANUFACTURING** automatic phonograph record presses and accessories
- AUDIO MATRIX** patented phonograph record plating systems

AUDIOMATIC CORPORATION

1290 AVENUE OF THE AMERICAS, PHONE: (212) 582-4870, CABLE: AUDIOMATIC, TELEX: 12-6419
 EUROPEAN OFFICE: 4, RUE FICATIER-92400-COURBEVOIE, PHONE: 333-30-90, TELEX: 62282

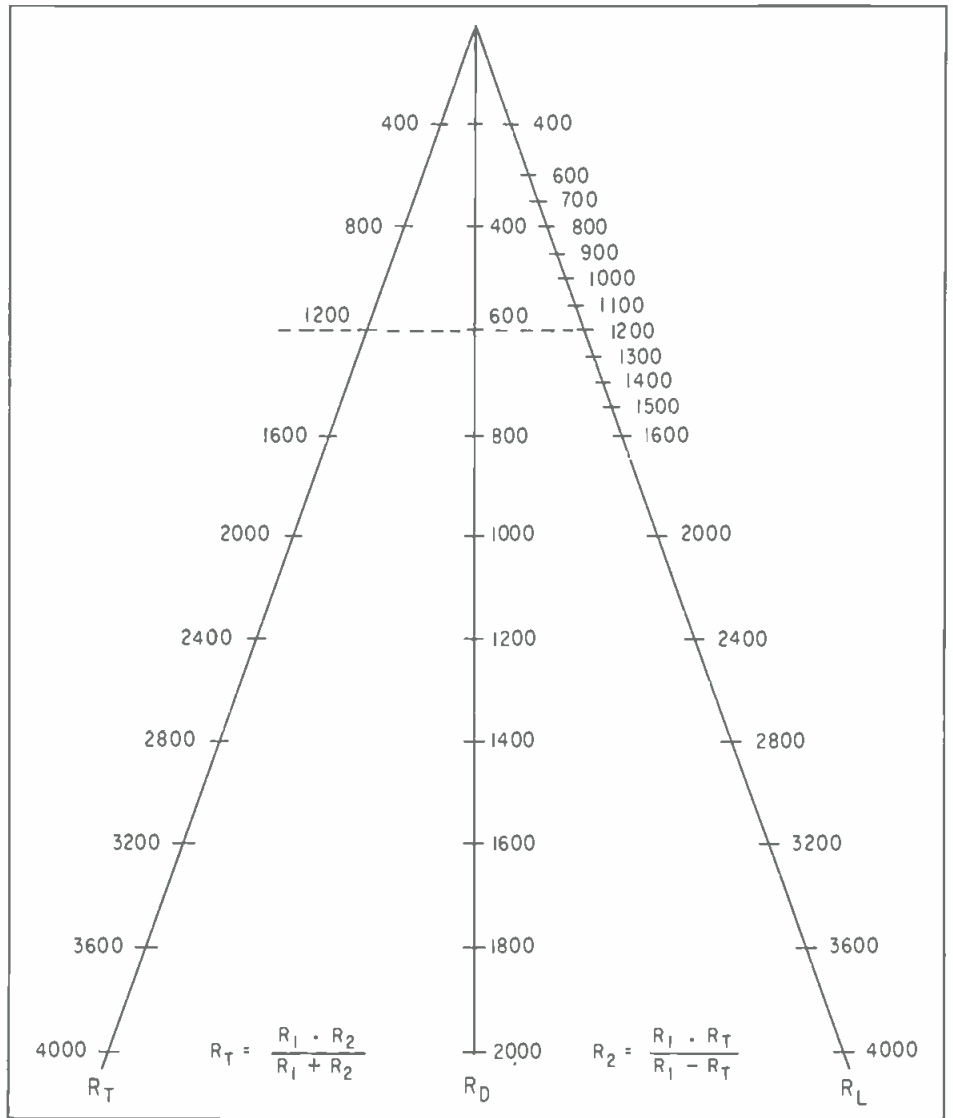
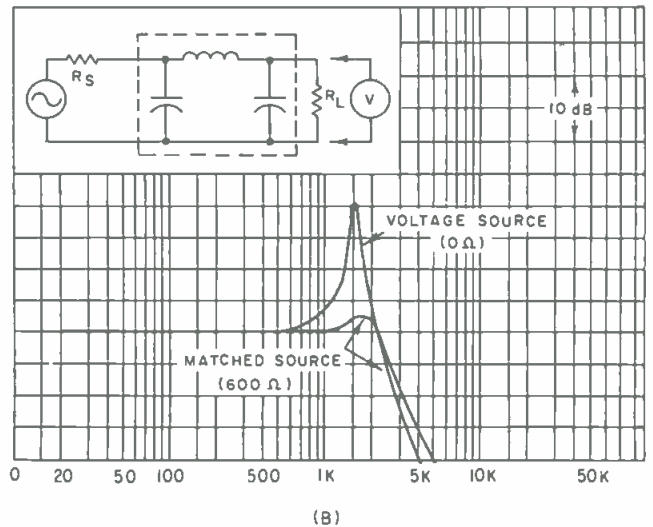
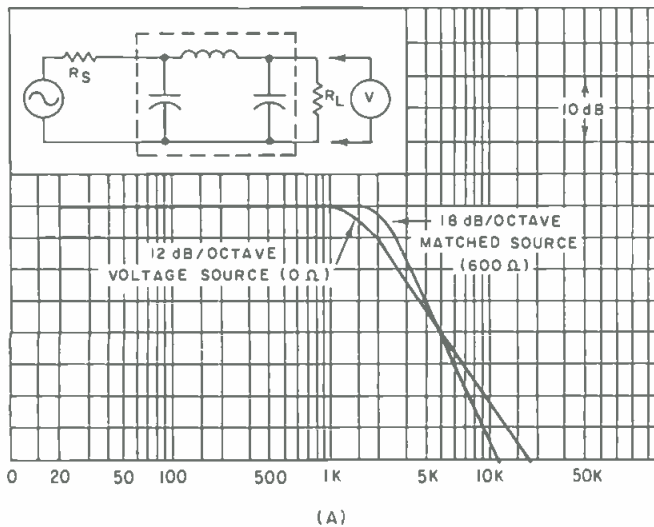

Figure 10. A nomograph for calculating terminal resistance.

is in matching the measured value to some desired value. FIGURE 9 illustrates a quite typical daily situation for the sound system installer. A set of passive equalizers is placed in a link circuit between a mixer and a power amplifier. The output of the mixer is labeled 600 ohms. Don't you believe it, however. A quick Z measurement

reveals it is really 130 ohms. The passive filter set needs to be fed from a true 600 ohms. 470 ohms in series with 130 ohms adds up to 600 ohms. (Balanced circuits would have half this value divided in each leg.) This is fine, but we have added extra loss in the circuit. How much is it when we go to adjust gains and losses for the system

Figure 11. At (A) is seen a PI network matched load, while at (B) is shown a PI network infinite load ($R_L = \infty$).





**Johnny King.
Back from Vietnam.
Just one problem.
He came back
disabled.
What kind of future
could he have?**

We're the National Alliance of Businessmen. The JOBS people. We think people who've given so much to their country should get the chance to work if they want to. We work with companies that understand a disabled person is able to do a good day's work. Like the sound equipment company that hired Johnny as a telephone salesman.

The National Alliance of Businessmen. Work with us. Give someone a chance to give. Not take.

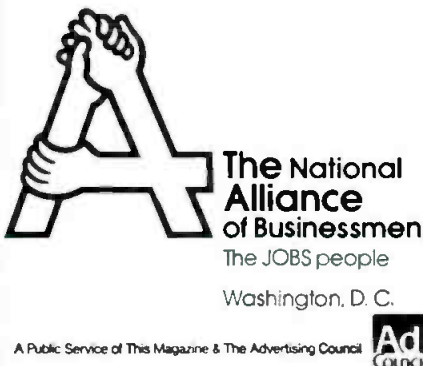

The Most

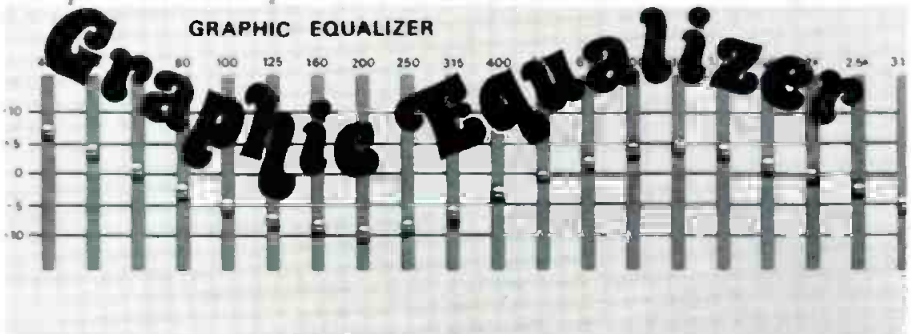

Universal Audio has put 27 precise equalizers to work in one 3½ x 19 inch package called the Model 527-A Active Graphic Equalizer, to provide room equalization of sound reinforcement or playback systems. Each equalizer is centered on a standard 1/3 octave frequency, making the 527-A compatible with all current measuring equipment for room equalization. As a creative tool, it offers the studio engineer command of the entire audio spectrum for contouring or correction. The 527-A is an active device, — no insertion loss. Each equalizer is continuously variable from -10dB to +10dB. The actuating arms, when adjusted, create a graphic display of the resultant response curve from 40 Hz to 16 kHz.

Send for complete technical information today.

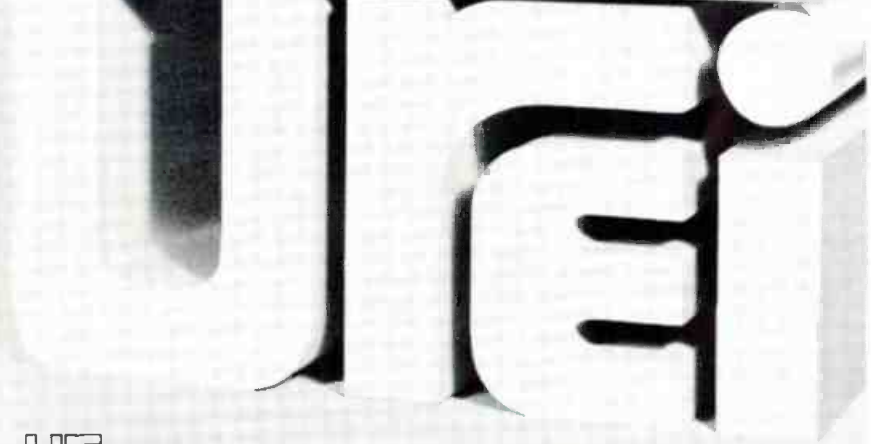
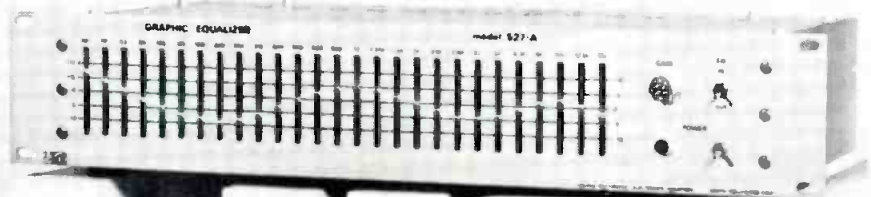

UIC company

11922 Valerio Street, No. Hollywood, California 91605 (213) 764-1500
Exclusive export agent: Gotham Export Corporation, New York

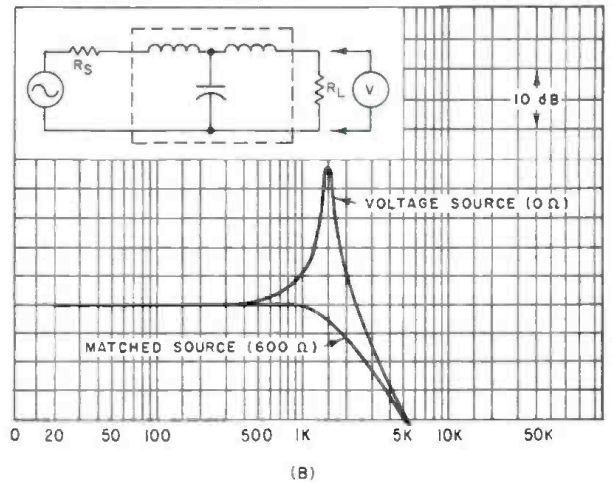
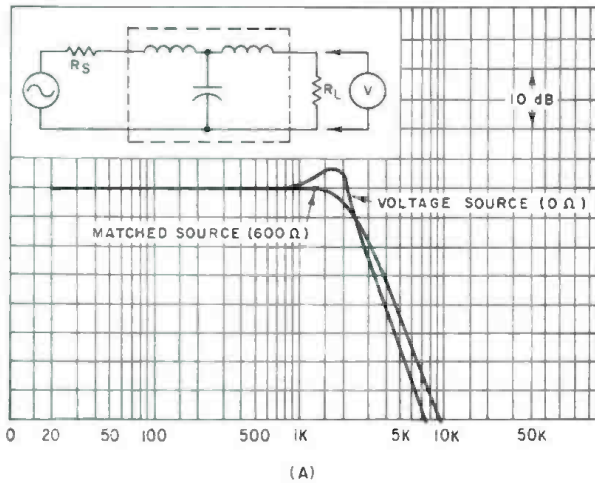

Figure 12. At (A) a T network matched load; at (B) a T network infinite load ($R_L = \infty$).

as a whole? Going back to FIGURE 8, the solution is worked out at the bottom of the illustration.

Now, we have an additional problem. The output of the passive filter set should also see 600 ohms. The input to the power amplifier is also labeled 600 ohms and it should be that value. Most often it is not, due to the way the gain potentiometer is wired. A quite typical case is the 1200 ohms shown in FIGURE 9. Because this input Z is higher than the desired Z , it should be shunted with a terminating resistor. FIGURE 9 shows the calculation and FIGURE 10 is a nomograph showing the solution of the same problem by placing a straight edge from R_L across R_0 to read R_T . Again, FIGURE 8 shows the calculation of the loss caused by the insertion into the circuit of this terminating resistor.

CONSEQUENCES OF FAILING TO PROVIDE MATCHING

In the case of passive filters, equalizers, and attenuators, failure to provide detailed buildouts and terminations is shown in FIGURES 11, 12 and 13.

FIGURE 11(A) shows a low-pass "pi" filter. This is not a constant impedance network, since at some high frequency the capacitors across the input and output legs will become the equivalent of a short circuit. High-pass filters exchange the positions of the inductors and capacitors, and in that case would present a very low impedance at some low frequency.

In the case of the three element circuit shown in FIGURE 11(A), each element should provide 6 dB per octave of attenuation for a total combined attenuation of 18 dB

CHROMACORD COMES ACROSS



Call us for a complete studio package or call us for a new alignment tape. And for everything in between.

We're specialists in broadcast and recording studio products and we've got the best stock in the country. MCI, Ampex, Tascam, JBL, Neumann, ElectroVoice, Eventide and other great names. We have a fully stocked warehouse so you won't have to wait months for delivery.

And, if you're starting a new studio or modifying an old one call us—we can also supply complete acoustic design. And when you're in operation we have the products to keep you up to date.



**CHROMACORD
CORPORATION**

2343 43RD AVENUE LACHINE QUEBEC H8T 2K1
60 MARGARET STREET PLATTSBURGH NEW YORK 12901
TELEPHONE (514) 636 8183

Circle 44 on Reader Service Card

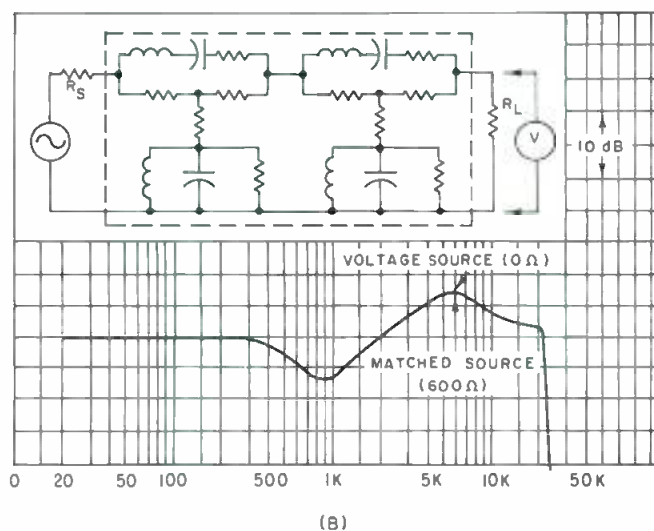
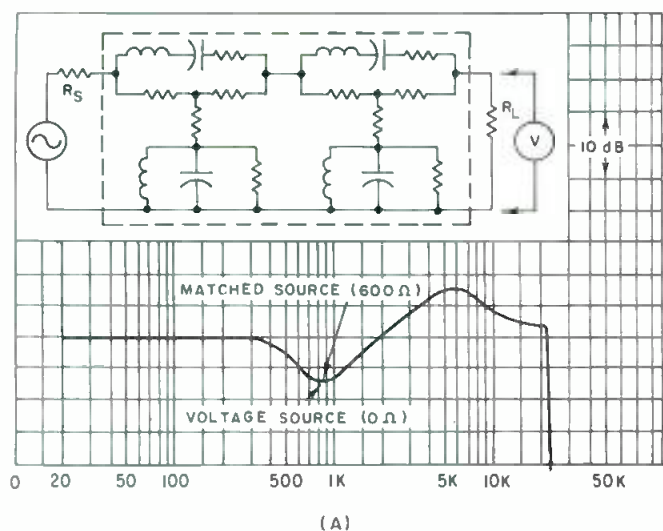

Figure 13.

per octave. This would be true whenever the filter was connected to a matched source (assume it sees a matched load).

If this filter were to be connected to a zero impedance source, then the input capacitor of the filter would have no effect since, by definition, the output voltage of a zero impedance source is not affected by load. In this case, our filter would be reduced to a two element filter of the "L" type providing only 12 dB per octave of attenuation.

A side effect of connecting some amplifiers to such a load without using build-out resistors would be the increase in intermodulation distortion from signals appearing on the slope of the cutoff region where the filter represents a downward mismatch to the amplifier.

Now, let's look at the effect of changing the termination of the filter since, in the cases above, we assumed it was properly terminated. FIGURE 11(B) illustrates first the condition of being attached to a matched source, but an infinite load impedance. A +3dB "bump" is the penalty paid for this failure to shunt this high impedance with a proper value terminating resistor.

If we were, however, to ignore both the build-out resistor and the terminating resistor and arrive at the condition where the filter was driven from a zero impedance source and loaded with an infinite impedance load, then the upper curve in FIGURE 11(B) is the type of "out of control" situation we can encounter. If we examine the diagram for this filter, we can see that this is a logical outcome of the failure to match impedances correctly. The series inductance and the output capacitor of the filter form a series resonant circuit across the output of the generator. The current and resonance are limited only by the coil "Q." Since the output voltage appears across one leg of the series resonant circuit, output voltage, like current, is limited only by coil Q. When a load is placed across the output, this tends to reduce Q and limit voltage rise. If the source resistance is raised from zero, it will limit current in resonance, hence limit voltage rise across the output.

What can we learn from this basic example? That a simple "pi" filter needs to have both its input and its output impedances matched carefully if its design parameters are to be properly employed.

FIGURES 12(A) and 12(B) go through the same exercise again, only this case the circuit examined is a "T" network.

FIGURE 12(A) shows the results of connecting the filter to a matched load and first measuring it with a matched source attached and then with a zero impedance source attached. In this case, the zero impedance source causes a rise of approximately +3 dB prior to cutoff. This is

caused by the resonance of the first two elements of the filter.

FIGURE 12(B) shows the drastic effects of operating this filter without proper termination. If the source is matched, but the output is not, the attenuation rate is reduced from 18 dB per octave to 12 dB per octave. If this filter is left with an infinite load impedance and also connected to a zero impedance source, then the unhappy effects of the upper half of FIGURE 12(A) are the result.

Once again, we can learn from these examples that "pi" and "T" networks should be carefully matched to their source and output for smoothest response and accurate ultimate attenuation.

Our third example is the "bridged-T," constant impedance network with limiting action. This circuit family has a very widespread usage today in room-sound system equalizers. Because the resistors in these networks sufficiently control coil Q, the response of such a circuit is virtually unchanged by mismatch of source or load impedance.

FIGURE 13(A) and 13(B) show how the response of these circuits are unaffected by zero impedance sources or infinite impedance loads. It is still wise to build-out and terminate such circuits because the usual practice is to employ either "pi" or "T" networks in the same link circuit for cutoff filters, etc.

Having examined these sample cases, we can now list three main reasons for making impedance measurements in audio link circuits:

1. To aid in gain calculations.
2. To calculate the proper build-out resistor value.
3. To calculate the proper terminating resistor value.

CALCULATING TRUE LEVELS VS APPARENT LEVELS

If a volume indicator, "v" meter, were placed across the output of the mixer with an output zeta of 130 ohms and +8 vu were read, what power would we really have?

$$vu = 20 \log \frac{E}{0.775} + 10 \log \frac{600}{Z}$$

Since the apparent value is +8 vu ($20 \log \frac{E}{0.775} = +8 \text{ vu}$), then all that is needed is to add the impedance correction $10 \log \frac{600}{130} = +6.64 \text{ dB}$, or an output from our mixer of $8 \text{ vu} + 6.64 \text{ dB} = 14.64 \text{ dBm}$. If this were a typical mixer with a maximum output of +18 dBm we would then lower the apparent level by 6.64 dB in order to preserve the 10 dB headroom (*concluded next month*).

CLASSIFIED

Closing date is the fifteenth of the second month preceding the date of issue. Send copy to: Classified Ad Dept.
db THE SOUND ENGINEERING MAGAZINE
980 Old Country Road, Plainview, New York 11803

EIGHTY API MODEL 550A EQUALIZERS. \$225. Contact Aengus Engineering (617) 481-7600.

SPLICE FASTER, BETTER, BY SHEARING; replaces razor; attached splicing tape dispenser; quality workmanship; reasonably priced; endorsed by professionals. \$24.95 prepaid. Guaranteed. Distributors wanted. NRP, Box 289, McLean, Virginia 22101.

NEW 14-INCH NAB Ampex aluminum flanges; have never been removed from original box. Package of 10, \$8.15. Sound Investment, P.O. Box 338, Dunwoody, Georgia 30338.

BROADCAST AND RECORDING EQUIPMENT: Scully; Metrotech; Langevine; Electrodyne; Q.R.K.; Micro-Trak; M.R.L.; Nortronics; McMartin; U.R.E.I.; used Neumann; E.V.; A.K.G.; Sennheiser; Atlas; Ferrograph; HAECO; Stevenson; Gately; D.B.X.; Advent; Altec; Falchlid; Audio Designs; 3 M; Magnacord; Telex; Inovonics; disc recording systems; package deals; installations; service. Wiegand Audio, Middleburg, Pennsylvania 17042. (717) 837-1444.

AMPEX SPARE PARTS; technical support; updating kits, for discontinued professional audio models; available from VIF International, Box 1555, Mountain View, Ca. 94042. (408) 739-9740.

SCULLY TAPE RECORDER model 284, remote sync-master; includes 12-track, 8-track, 4-track heads. 16-track console, 20-in, including 16 equalizers, 2 compressors, pan pots, and four power supplies. Perfect condition. Associated Recording Studios, 723 Seventh Ave., New York City 10019. (212) 245-7640.

CUSTOM RECORD PRODUCTION (100 & up) from your tapes; also Scully-Westrex precision cut masters and acetate demos (stereo or mono). Request literature, Trutone Records, Dept. D, 6411 Bergenwood Ave., North Bergen, N.J. 07047. (201) 868-9332.

MULTI-TRACK

8 and 16

TRACK RECORDING CONSOLES
THE SOUNDEST DOLLAR SPENT
IN PRO AUDIO TODAY
1965 CHEREMOYA AVE.,
HOLLYWOOD, CALIF. 90028
P.O. Box 3187, Hollywood, CA. 90028
(213) 467-7890

FOR SALE

B.B.C. REFERENCE MONITORS; pre-equalized J.B.L./Altec/I.M.F. monitors; Eventide phasors/omniprocessors/digital delays; McIntosh 16 Ω power amps; dbx compactors; Little Dipper hum/buzz notch filters; Cooper Time Cube echo delay; Ortofon and B. & O. ultra-track cartridges; Schöeps & A.K.G. condensers; Beyer ribbons; U.R.E.I. comp/limiters; Gately Pro-Kits; Infinity electrostatics; Crown amplifiers/recorders; Tascam, Community Light & Sound fiberglass horns; Q.R.K.; 100's more, plus class "A" warranty service station. Music & Sound, Ltd., 11½ Old York Rd., Willow Grove, Pa., 19090. (215) 659-9251.

All Shipped Prepaid/Insured

REEL SPECIALISTS; 10.5 inch reels, NAB \$2.00 each; Precision, \$5.00 each; other sizes available; NAB flanges, \$.75 each. Add 5 per cent postage. P.O. Box 338, Dunwoody, Ga. 30338.

FREE ROOM EQUALIZATION with purchase of ⅓-octave filter sets. This is not a misprint. Music & Sound, Ltd., 11½ Old York Rd., Willow Grove, Pa. 19090. (215) 659-9251.

STOP KIDDING YOURSELF . . . about Head Degaussing! Use a full power degausser and then measure the results with a magnetometer. The Annis Hand-Mag measures over 400 Oerstads . . . more than 5½ times as powerful as the head degausser you're probably using now. Then check the results with the Annis Magnetometer, included in the Hand-Mag kit for \$29.75. Prepaid in place in the U.S. from Audiotechniques, Inc. Send your check or money order to: Audiotechniques, Inc. 142 Hamilton Ave., Stamford, Ct. 06902. Tel: (203) 359-2312.

WHATEVER YOUR EQUIPMENT NEEDS—new or used—check us first. We specialize in broadcast equipment. Write for our complete listings. Broadcast Equipment & Supply Co., Box 3141, Bristol, Tenn. 37620.

AMPEX, SCULLY, TASCAM; all major professional audio lines. Service, experience, integrity. 15 minutes George Washington Bridge. Professional Audio Video Corporation, 342 Main St., Paterson, N.J. 07505. (201) 523-3333.

FOR SALE: MCI JH 416 consoles: 24 x 24, \$19,000; 20 x 20, \$14,500; JH 16 16-track w/auto locator, \$10,900. Sound 80, 2709 E. 25th St., Minneapolis, Minn. 55406. (612) 721-6341.

FOR SALE: CUSTOM LANGEVINE CONSOLE; 10-in/8-out; 10 pan pots; 8 TK; monitoring; stereo Q; 4 EKO busses. Available immediately. Plynth Studio, 117 Rockland Rd., Libertyville, Ill. 60048. (312) 362-4060/4061.

SOLID-STATE AUDIO MODULES. Console kits, power amplifier kits, power supplies. Octal plug-ins—mic, eq, line, disc, tape play, tape record, amplifiers. Audio and tape bias oscillators. Over 50 audio products, send for free catalog and applications. Opamp Labs. Inc., 172 So. Alta Vista Blvd., Los Angeles, Ca. 90036. (213) 934-3566.

AUDIO BY ZIMET announces the opening of their new professional audio department, featuring a full line of top professional equipment. No need to travel—now on Long Island you'll find the equipment, the friendly, knowledgeable help, and the right prices. Our 16th year on Long Island. Audio by Zimet, 1038 Northern Blvd., Roslyn, N.Y. 11576.

FOR SALE: 16-TRACK CONSOLE, 16-in/16-out; new, never used; Auditronics guarantee card; spares; connectors; etc. For details, ask for Grace. (813) 988-3491.

NOW, OWN A COMPLETE NEW FOUR-TRACK PROFESSIONAL RECORDING STUDIO for under \$9,000! Includes Tascam console, machines, limiters, stereo echo, mikes and accessories. For more information contact Emil or Sparky at Studio Supply Company, 1918 Division St., P.O. Box 280, Nashville, Tennessee 37202. (615) 327-3075.

TWO CHANNEL MONITOR EQUALIZERS for your Altecs and J.B.L.s are a steal at \$150. Music & Sound, Ltd., 11½ Old York Rd., Willow Grove, Pa. 19090. (215) 659-9251.

→ S.M.E. Damping Mods—\$30.00 ←

NORTHWEST AREA, professional audio equipment and systems design. R. E. Munger Co., Seattle, Washington, (206) 365-1999. An Altec Acousta-Voice contractor.

HAECO announces complete repair service and overhaul for all Westrex cutterheads. Conversions of 3D-II and older models to higher performance standards and reliability. Helium cooling systems and hi-temp coils can protect your investment. Repair insurance program available. Rapid service. Lower cost. HAECO, 14110 Aetna, Van Nuys, California 91401.

AUDIO EQUIPMENT, new and used; custom consoles built to your specifications using the components of your choice. Whether you're building a new studio or remodeling your present one, check us first for a package price. **Amboy Audio Associates, 236 Walnut St., South Amboy, N.J. 08879. (201) 721-5121.**

LOWEST PRICES, fastest delivery on Scotch recording tapes, all widths. We will not be undersold. **Amboy Audio Associates, 236 Walnut Street, South Amboy, N.J. 08879. (201) 721-5121.**

SOLID STATE REPLACEMENTS FOR TUBES; direct plug-in replacement of low noise tubes with solid state fet components. Without circuit modifications, replace audio tubes to eliminate microphonics, give increased gain and signal-to-noise ratio. For mixers, duplicators and pro. series tube type record electronics. Write for data information and application notes for your equipment. **Audio Applications, Box 3691, Hayward, Ca. 94545.**

NEW YORK'S LEADING PRO AUDIO/VIDEO DISTRIBUTOR for audio, video, broadcast, public address, and hi-fi systems; representing over 130 audio/video manufacturers, featuring such names as Ampex, Scully, Tascam, Sony, J. B. Lansing, Neumann, Altec, McIntosh, AKG, Dynair, T.V. Microtime, UREI, 3M, and other major brands; the largest "in stock" inventory of equipment, accessories, and parts; competitive discount prices; factory authorized sales, service, parts, systems design, installation. Write for free catalog! **Martin Audio/Video Corporation, 320 W. 46th St., New York, N.Y. 10036. (212) 541-5900.**

STELLAVOX RECORDER; complete system with all accessories; adapted for film sync; dealer display unit, brand new, never used. Save \$500. Available immediately. \$2,300. **Broadcast Equipment & Supply Co., Box 3141, Bristol, Tenn. 37620.**

REVOX A700 — CROWN — TASCAM — AMPEX — SCULLY — UREI. New and used pro recorders and mixers. Write for latest listings. **RPB SOUND CO., 339 Park Avenue So., Winter Park, Florida. (305) 647-4762.**

**ONE STOP
FOR ALL YOUR PROFESSIONAL
AUDIO REQUIREMENTS
BOTTOM LINE ORIENTED
F. T. C. BREWER CO.
P.O. Box 8057, Pensacola, Fla. 32505**

ONE WAY NOISE REDUCTION for cutting rooms/tape copies; retains highs, rids hiss/surface noise by a full 10 dB and costs \$300 per channel! **Music & Sound, Ltd., 11½ Old York Rd., Willow Grove, Pa. 19090. (215) 659-9251.**

**ORTOFON
DYNAMIC MOTIONAL FEEDBACK** mono disc cutting system. Complete amplifier system: drive, feedback, and feedback-playback monitor preamp; rebuilt, original factory parts. Guaranteed. **Albert B. Grundy, 64 University Place, New York, N.Y. 10003. (212) 929-8364.**

ONE 8-TRACK RECORDER, Ampex 300 deck, almost new heads; custom designed and built electronics with self-sync; machine currently in use; asking price \$6,000 or make offer. Reply **Continental Recordings, Inc., 12 Irving St., Framingham, Mass. 01701. (617) 879-2430.**

HP205AG—\$200; HP330B—\$275; HP650A—\$195; several Textronix 530 series oscilloscopes; other instruments. **Design Consultants, Box 67, Richardson, Texas 75080.**

WE INSTALL STUDIOS from two-track up into sixteen- or even forty-track, from control consoles to tape recorders. Let us know what you want and we'll be happy to lay out plans for your individual needs. Contact **Monex Corporation of Iowa, P.O. Box 3225, Des Moines, Iowa 50316.**

DISK MASTERS—Classical music specialty—LP's, \$63 side, (20 sides @ \$43); \$50/reference. We will cut mono/stereo ¼-inch tapes at 7½/15 ips; also, Dolby and Phase Matrix (Quad SQ and QS) encoded tapes. Contact: **International Recording, 49 Desmond Avenue, Bronxville, N. Y. 10708. (914) DE 7-5726.**

TUNED ROCK P.A.s customized touring sound systems, including narrow band (5 Hz!) feedback suppression, detailed Acousa-Voicing/ environmental equalization (± 1 dB at your ears), room design/measurement/treatment; 100's of customized professional products (J.B.L. & Altec Pro, Tascam, dbx, U.R.E.I., Eventide, Gately, Schöeps, Beyer, Crown, Community Light & Sound, Mom's Audio, McIntosh, etc. etc.) All shipped prepaid/insured from **Music & Sound, Ltd., 11½ Old York Rd., Willow Grove, Pa. 19090. (215) 659-9251.**
Inventors—Engineers

TASCAM REVERBS; Tascam Mixing Consoles—\$1,890; Tascam ½ inch recorders—\$1,950; Tascam 8-track recorders—\$3,970. All shipped prepaid/insured, including free alignment/equalization/bias/calibration. **Music & Sound, Ltd., 11½ Old York Rd., Willow Grove, Pa. 19090. (215) 659-9251.**

3-SIXTY SOUND REINFORCEMENT SYSTEMS, including touring systems. Division of Brandy Brook Sound. Contact **Concertour, P.O. Box 284, Wilton, Conn. 06897. (203) 966-3113.**

NEW YORK'S ORIGINAL ELECTRONIC WORKSHOP now has New York City's finest audio showroom, featuring Infinity, ESS, Phase Linear, Bose, Crown, Bang & Olufsen, etc.; knowledgeable and helpful sales assistance that is hard to find. We invite you to pay us an early visit. **Electronic Workshop, 10 E 8th St., New York, N.Y. 10003. (212) GR 3-0140.**

EMPLOYMENT

MAINTENANCE ENGINEER

Major West Coast studio needs highly qualified maintenance engineer; digital experience preferred; salary and profit sharing open; all correspondence mutually confidential. Contact **Thomas Jackson, 6381 Hollywood Blvd., Suite 503-507, Hollywood, California 90028.**

RADIO-TV ENGINEER 1: High school diploma and two years of experience in the operation and maintenance of a variety of radio and television equipment; first class FCC license preferred, but not required; salary range \$7,600-\$10,315. Interested persons should contact the **University of South Florida, Personnel Services, Tampa, Florida 33620.** The University of South Florida is an affirmative action equal opportunity employer.

AUDIO-DISK MASTERING ENGINEER/SALESMAN, WITH SOLID AUDIO BACKGROUND seeks permanent career, studio-sales position, N.Y./N.J. area. Salary negotiable. **Box 41, db Magazine, 980 Old Country Rd., Plainview, N.Y. 11803.**

DISC MASTERING ENGINEER. We are looking for an independent talent who can enrich music, but keep it true, a person who has expertise in getting good cuts from a Neumann lathe (variable pitch), savoir-faire with clients, studio maintenance skills—even clientele following. State knowledgeability of Neumann or Ortofon cutting systems; also full time-part time or commission interest. Pay open. Replies confidential. Write: **International Recording, 49 Desmond Avenue, Bronxville, N.Y. 10708.**



CATV—MATV PRODUCTS

- CONNECTORS
- WALLPLATES
- SPLITTERS
- AMPLIFIERS



AVA ELECTRONICS CORP.
242 Pembroke Avenue, Lansdowne, Pa. 19050
(215) 284-2500

PEOPLE, PLACES, HAPPENINGS

● An international sales agreement has been signed, designating **Westlake Audio**, of Los Angeles, as distributor of tape recording systems manufactured by the Swiss **Studer Franz Ag.** The most advanced Studer unit, 24-track model A80/VU-24-2, will be available through Westlake. Demos can be arranged by contacting Westlake.

● A major sale of interest has been made by the **Ampex Corporation** who have sold its 150th MM-1100 second generation multichannel audio recorder/reproducer to **Compact Video Systems**, of Burbank, California. The milestone sale was part of a system amounting to more than \$500,000. The MM-1100 is the only commercially available audio recorder/reproducer which will accommodate 16-inch tape reels using two-inch audio recording tape. Ampex was the pioneer in this field, producing the first such instrument, MM-1000, in 1968.

● **The Society of Broadcast Engineers** celebrated their tenth anniversary at the NAB convention in March. Inspiration for the formation of the organization came from an editorial written by **John H. Battison**, who served the first two terms as its president. The first official meeting was held in Chicago in April, 1964. The thirty two chapters of the society across the country serve their members in various ways. New developments in broadcast technology are disseminated through the organization's journal and other educational efforts are furthered. The society is interested in enhancing the position of broadcast engineers in general and in aiding the advancement of both the experienced technician and the novice. Hospitalization, major medical policies, and term insurance at group rates are offered to members. The SBE mailing address is P.O. Box 88123, Indianapolis, Indiana 46208.

● **Audio-Video Concepts, Inc.**, of Washington, D.C. has announced the appointment of **Bill E. Smith** as production supervisor, managing all phases of the firm's studio operations. Mr. Smith has had a career as a performer, music teacher, and electrical engineer. Before joining Audio-Video, he was associated with the **Jordan Kitt Music** company.

● **Rex C. Bradford** has been named manager of digital head engineering by **Nortronics Company, Inc.**, Golden Valley, Minn. Mr. Bradford will be in charge of a group which has responsibility for the development and design of magnetic heads for computer peripheral equipment. Before joining Nortronics, Mr. Bradford worked as a consulting engineer with **Magnetic Head Corporation** and then in a private capacity. He was previously with **International Business Machines Corporation**.

● **Broadcast Electronics, Inc.**, of Silver Spring, Maryland, and **Audio Interface Systems, Inc.**, Birmingham, Alabama, have jointly announced a long term agreement whereby all Audio Interface production facilities will be converted fully to the production of Spotmaster electronic products. The full manufacturing output of Broadcast Electronics facilities and those of Audio Interface will be marketed and serviced by the Broadcast Electronics organization.

● **TEAC Corporation of America**, of Montebello, California, has signed an exclusive U.S. distributor contract with **Kensonic Laboratory, Inc.**, Japanese manufacturer of Accuphase electronic audio equipment. Scheduled to be on the market this spring are three models, P-300, a high powered 300-watt rms main stereo amplifier, C-200, a pre-amplifier that will accept any kind of input, and T-100, an a.m.-f.m. tuner.

● The tape duplicating division of **Superscope, Inc.** of Sun Valley, California, has been awarded a one-year contract with the American Forces Radio Network to reproduce on tape 84 hours of programming weekly for airing on U.S. Navy ships. American Forces Radio programming is put together from original shows recorded by disc jockeys at the network's headquarters and studios in Hollywood. The new program will be distributed to a total of 580 ships.

● An enlarged program of scholarship aid for graduate and undergraduate study in the academic year 1974-75 has been announced by the **Society of Motion Picture and Television Engineers**. Amounts up to \$5,000 will be awarded to qualified graduate students for study and research in the sciences and technologies related to the production of motion pictures. Two grants for undergraduate students will also be available. To be eligible, a student must have completed two years of college and be presently enrolled in or admitted to a recognized college or university with the objective of a degree in one of the related fields, such as the sciences of optics, acoustics, electronics, and chemistry. Business, management, and standardization, relating to these fields, will also be considered. Application forms may be obtained from SMPTE Headquarters, 862 Scarsdale Ave., Scarsdale, N.Y. 10583.

● Announcement has been made by **Superscope**, of Sun Valley, California of the appointment of **Gene Block** as national sales manager for special tape products. Mr. Block's particular area of interest is the educational "Story Teller" tape series, which he hopes to expand to reach 25,000 retail outlets. Prior to coming to Superscope, Mr. Block was associated with **Columbia Records**, **Gulf-Western**, and his own firm, **Creative Marketing Consultants**.

Now available! The most important microphone book ever published.

Covers every significant aspect of theory and use from A to Z!

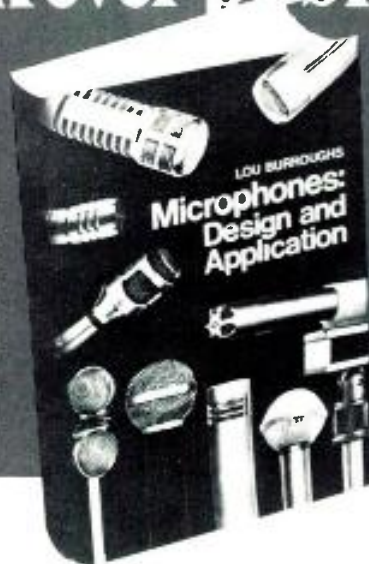

259 pages
233 illustrations

LC #73-87056
ISBN #0-914130-00-5

The whole field of microphone design and application has been prepared and explained in one concise, fact-filled volume by one of audio's outstanding experts. This book is complete, up-to-the-minute and so full of useful information, we think you'll use it every time you face a new or unusual microphone problem.

Perfect for Reference or Trouble-Shooting

The twenty-six fact-packed chapters in this indispensable volume cover the whole field of microphones from theory, physical limitations, electro-acoustic limitations, maintenance and evaluation to applications, accessories and associated equipment. Each section is crammed with experience-tested, detailed information. And everything is arranged for easy reference because this is one handbook you'll turn to again and again. Whatever your audio specialty—you need this book!

Along with down-to-earth advice on trouble-free microphone applications, author Lou Burroughs passes on dozens of invaluable secrets learned through his many years of experience. He solves the practical problems you meet in day-to-day situations. For example:

- How does dirt in the microphone rob you of response?
- Which mic would you pick for a large auditorium?
- How are omni-directional mics used for orchestral pickup?
- When would you choose a cardioid, omni-directional or bi-directional mic?
- How do you space your microphones to bring out the best in each performer?

Author

Lou Burroughs is widely known for his pioneering work with Electro-Voice and is one of the universally recognized experts in the field. He helped design and develop many of the microphones which made modern broadcasting possible. In fact, he holds 23 patents on electro-acoustical products! Lou Burroughs knows microphones inside out. This book is based on his many years of research, field studies and lectures given throughout the world.

This book is highly recommended as a teaching text and reference for all those in the audio industry.

ORDER FORM

Sagamore Publishing Co. Inc. 980 Old Country Rd. Plainview, N.Y. 11803

Please send () copies of MICROPHONES: DESIGN AND APPLICATION at \$20.00 each postpaid.

Name _____

Total amount \$ _____

Address _____

New York State Residents add 7% tax \$ _____

City _____ State _____ Zip _____

Enclosed is check for \$ _____
Foreign orders add \$1 pstg. & hndlg.

If you want to lay down
a 113 dB signal*
flat from 28 to 18,000 Hz,
radiating through an angle of 120°
the SENTRY™ III is it.



On the other hand,
if you need 4 dB more level
on axis, and are willing to
give up just 22 Hz of bass, consider
the SENTRY™ IVA.

*4' on axis with just 50 watts, with
optional SEQ Active Equalizer. Response
without equalizer, 40-18,000 Hz.

Both monitor systems share the same mid-range and high frequency speaker components. Both have tweeter protector circuits built in to save the systems from inadvertent damage. The Sentry IVA uses a dual-speaker, horn-loaded bass end for efficiency. The Sentry III uses a single speaker in

a vented enclosure for extended range.

Sentry III. Sentry IVA. The two best ways to recreate the actual sound pressure sensations and response range of live music... in the studio or in demanding sound reinforcement installations. From the innovators at E-V.

a **Gulton**
COMPANY

Electro-Voice®

ELECTRO-VOICE, INC., Dept. 441BD, 686 Cecil St., Buchanan, Mich. 49107

Circle 11 on Reader Service Card