

dB

THE SOUND ENGINEERING MAGAZINE
APRIL 1975 \$1.00



IN THIS ISSUE:

- How Speech Can Be Compressed Or Expanded
- Ways to Evaluate Monitoring Loudspeakers
- Recording Studio Acoustics, Part 5

Introducing

EVERYTHING AUDIO

a second generation
turn-key studio
company

This new company, headed by Brian Cornfield, offers you the results that until now have only been obtainable through expensive experimentation. Building on confirmed design principles learned from the first generation, we have moved into the second generation of turn-key studio construction. With a seasoned staff and an impressive array of consulting specialists, Everything Audio is redefining studio design parameters, and thereby setting truer performance standards.

In offering the professional studio market a new turn-key company we are stressing integrity, quality and competence. We represent only the highest quality and most reliable product lines. Our expertise can furnish unique solutions to the most difficult acoustical design problems, including quad mixdown rooms, disc mastering studios and remote trucks. All of our designs provide tailored frequency responses to suit your specific requirements.

Accept our invitation to contact us and discuss your studio needs. 14045 Sherman Way, Van Nuys, California 91405 / (213) 873-4447

Circle 10 on Reader Service Card

coming
next
month

● The need to synchronize sight and sound has generated ingenious applications of mechanics and electronics, as discussed by Douglas R. Kaye in **MOTION PICTURE SYNC SYSTEMS**.

● In his article, a **SYSTEMATIC APPROACH TO WIRING CONNECTORS**, Doug Rygalo explains how the Cascaded Potential System can ease your wiring problems.

● A useful article describing a **SIMPLE HIGH-QUALITY HIGH SPEED TAPE DUPLICATOR**, achieved through a simple modification which can be performed on several models of Ampex equipment is offered by Bob S. White.

about
the
cover

● A contrast in studios. The colorful control room with an MCI console is at Lee Furr Studios, Tucson, Arizona, designed by Pacific Recorders. The smaller studio, representative of so many of its kind, is that of Ter-song, Inc., Mt. Kisco, N.Y. (photo by Hank Wimbrow).

db

THE SOUND ENGINEERING MAGAZINE

APRIL 1975, VOLUME 9, NUMBER 4

18	A REMOTE POWERED DIRECT BOX Lothar Krause
32	COMPRESSION AND EXPANSION OF SPEECH IN TIME Sidney Silver
36	WAYS TO EVALUATE MONITORING LOUDSPEAKERS C. R. Heft
40	RECORDING STUDIO ACOUSTICS, Part 5 Michael Rettinger
2	LETTERS
4	INDEX OF ADVERTISERS
6	CALENDAR
8	THE SYNC TRACK John Woram
11	THEORY AND PRACTICE Norman H. Crowhurst
13	SOUND WITH IMAGES Martin Dickstein
20	NEW PRODUCTS AND SERVICES
43	CLASSIFIED
46	PEOPLE, PLACES, HAPPENINGS

db is listed in **Current Contents: Engineering and Technology**

Robert Bach PUBLISHER
Alex Porianda MANAGING EDITOR

Larry Zide EDITOR
John Woram ASSOCIATE EDITOR

Bob Laurie ART DIRECTOR
Hazel Krantz COPY EDITOR

Eloise Beach CIRCULATION MANAGER
Ann Russell ADVERTISING MANAGER

GRAPHICS **Crescent Art Service**

db, the Sound Engineering Magazine is published monthly by Sagamore Publishing Company, Inc. Entire contents copyright © 1975 by Sagamore Publishing Co., Inc., 1120 Old Country Road, Plainview, L.I., N.Y. 11803. Telephone (516) 433 6530. db is published for those individuals and firms in professional audio, recording, broadcast, audio-visual, sound reinforcement, consultants, video recording, film sound, etc. Application should be made on the subscription form in the rear of each issue. Subscriptions are \$6.00 per year (\$12.00 per year outside U. S. Possessions, Canada, and Mexico) in U. S. funds. Single copies are \$1.00 each. Controlled Circulation postage paid at Harrisburg, Pa. 17105. Editorial, Publishing, and Sales Offices: 1120 Old Country Road, Plainview, New York 11803. Postmaster: Form 3579 should be sent to above address.



Silence—the ultimate studio sound

Today's recording and performances call for a wide range of special effects, every one of them adding noise to your final musical product.

The primary function of the MXR Noise Gate/Line Driver is to remove this signal from your musical performance by "gating off" any signal below a variable threshold level. The wide range of threshold control (-70dBv to -20dBv) and the high input impedance (500 Kohms) enables the Noise Gate/Line Driver to be used in a variety of applications, from removing the hum and noise inherent in musical instrument pick-ups to signal processing in the studio.

Additional features include battery operation (extremely long life), reliable construction, and two outputs capable of driving 600 ohms: a standard phone jack, and a three pin XLR connector for convenient use with any mic line.

MXR Innovations
Musical Products Group
 P.O. Box 722
 Rochester, N.Y. 14603

THE EDITOR:

Just a pat on the back for what was, to me, one of the best issues so far—January, 1975. Crowhurst's *Theory and Practice* should be required reading for students and teachers and P.T.A.s and bureaucrats responsible for handing out the funds while drawing guidelines and . . . on and on.

Meanwhile, when one starts reading page 28, he is not going to stop until he gets to the bottom of page 32. A great article and a fine example of instruction that holds your interest. Congratulations, Mr. King.

Just one thing: Mr. King, I followed you through the article on squaring and then applied some of it to this expression (3 millicalves)³, and I ended up with enough cube steak to invite the neighbors over. Now I've decided to talk to the minister about how one could feed a multitude with just five fishes. Thanks again.

VIC RUGH, III
 CHIEF ENGINEER, KWEY
 WEATHERFORD, OKLAHOMA

Temporary Employment Wanted

Temporary employment for 6 or 12 months is required by a number of undergraduate students. They are reading for the degree of B.Mus. (Tonmeister) and the 4-year course is of the "sandwich" type including a period of employment in the recording or broadcasting industry. Apart from studies in music, acoustics and electronics, the students have experience in microphone balance, tape operation, mobile recording etc., using fully professional equipment.

Introduction of 12-month attachments means that the University can now offer continuity of staffing to an employer. This is felt to be an improvement on the previous 6-month scheme.

Interested employers are asked to contact: John Borwick, Senior Lecturer (Recording Techniques), Department of Music, University of Surrey, Guildford, Surrey, England.



For everyman ...

Most musicians have dreamed about having at least a four-track studio at home, so they could have the time to experiment. After many demo sessions in the studio, some friends of ours — The Hello People — sacrificed the next demo date to buy our 3340S, and made the dream real.

A few months later, they signed a contract with ABC-Dunhill — with the demo tapes they made at home on their 3340S. Now, the Hello People have helped us produce an album *on the 3340S, about the 3340S.*

Which shows, for \$2.00, both how good it is and what it can do for your music. Call (800) 447-4700 toll-free to locate the nearest TEAC retailer who has it. In Illinois, call (800) 322-4400. Find out yourself: you have nothing to lose but your lack of time. The 3340S.

... From Teac

TEAC

The leader. Always has been.

TEAC Corporation of America. 7733 Telegraph Road, Montebello, California 90640.

A REAL TIME ANALYZER SOLID STATE DISPLAY

FEATURES:

- Simultaneous 28 channel display
- 1/3 Octave coverage 40 Hz to 16kHz
- Calibrated SPL readout
- Built-in pink noise generator
- Double-tuned high resolution filters
- High-gain mic preamp
- Portable or rack mount
- Optional 3 mic multiplexer for averaging



SIZE:
19 3/4" x 10" x 4 1/4"

Measure your
total acoustical
response . . . in real time:
Equalization - Noise Masking
Program Analysis

With unique LED DISPLAY
The Model 140 REAL TIME ANALYZER
Less than \$2500

Ask for bulletin 140 and free booklet on equalization.

White

Call or Write — White Instruments, Inc.
P.O. Box 698, Austin, Texas 78767, Phone 512/892-0752

Circle 17 on Reader Service Card

index of advertisers

Amber Electro Design	31
Audio Design	7
Audio Eng. Society	45
Audionics	10
Bose	41
Broadcast Electronics	28
CBS Labs	20
Crown	27
Diacoustic Lab	14
Electro Sound	29
Electro-Voice	9
ESE Digitals	39
Everything Audio	cover 2
Garner Industries	11
Jensen Tools	30
Kustom Electronics	15
London Company	30
Lumiere Productions	28
Micro-Trak Corp.	37
MXR Innovations	2
Otari	38
Polyline	30
Precision Electronics	6
Ramko Research	cover 3
Rauland-Borg	12
Revox	6
Robins/Fairchild	14
Sescom	30
Shure Brothers	16, 21, cover 4
Standard Tape Lab	4
Stanton Magnetics	19
Willi Studer	5
TEAC Corp. of America	3
Timekeeper	45
Westlake Audio	41
White Instruments	4

Our selling premise is

Simple...

STL magnetic Test Tapes are the Most Comprehensive

We offer precision magnetic test tapes made on precision equipment for specific jobs in 1" and 2" sizes as well as flutter tapes and all other formats.

When you use STL test tapes you combine interchangeability with compatibility. You *know* you are using what other leaders in the professional recording, equipment manufacturing, government and educational agencies throughout the world are using.

Make sure your system is in step with the rest of the industry.

Write for a free brochure and the dealer in your area.
Distributed exclusively by Taber Manufacturing & Engineering Co.



STANDARD TAPE LABORATORY, Inc.

2081 Edison Avenue
San Leandro, CA 94577
(415) 635-3805



sales offices

THE SOUND ENGINEERING MAGAZINE

New York

1120 Old Country Rd.
Plainview, N.Y. 11803 516-433-6530

Roy McDonald Associates, Inc.
Dallas

Stemmons Tower West, Suite 714
Dallas, Texas 75207 214-637-2444

Denver

3540 South Poplar St.
Denver, Colo. 80237 303-758-3325

Houston

3130 Southwest Freeway
Houston, Tex. 77006 713-529-6711

Los Angeles

500 S. Virgil, Suite 360
Los Angeles, Cal. 90020 213-381-6106

Portland

2035 S. W. 58th Ave.
Portland, Ore. 97221 503-292-8521

San Francisco

Suite 265, 5801 Christie Ave.
Emeryville, Cal. 94608 415-653-2122

What 'GENUINE'

Swiss
Performance

really is...

The current STUDER A80.

WOW and FLUTTER—0.06% peak wtd, measured per DIN 45507, ANSI S4.3-1972 (approx. 0.04% RMS) @ 15"/sec.

DISTORTION—< 1% total harmonic @ 200 nWb/m tape fluxivity, NAB-15"/sec (note: this is mainly 3rd harmonic and is a function of the tape itself; 2nd harmonic distortion typically 0.1% at 10 dB ABOVE operating level)

STARTING TIME—< 0.5 sec to 0.1% FLUTTER for all tape widths (note: start time considerably less if start is made from EDIT mode.)

ERASURE—approx. 85 dB @ 1 kHz

HEAD LIFE—extremely long due to use of "VACODUR," an alloy so hard it must be cast and ground but is magnetically soft and without the disadvantages normally associated with ferrite heads.



Want to know more? Contact...

WILLI STUDER AMERICA, INC., 3916 Broadway,
Buffalo, New York 14227—phone 716 681-5450
(In Canada: WILLI STUDER CANADA LIMITED,
Toronto—416 423-2831) for the name of our representative nearest you.

WILLI
STUDER
AMERICA

Circle 19 on Reader Service Card

The best by far...
because Revox delivers what
all the rest only promise.



For complete details write:
Revox Corp., 155 Michael Drive, Syosset, N.Y. 11791

Circle 20 on Reader Service Card



THE NAME AND THE PRODUCT THAT
**SETS THE STANDARD
FOR P.A. EQUIPMENT**

Whatever your PA needs, from a small office to large auditorium, with amplifiers in every power range, including mobile, Precision Electronics delivers the product and value . . . including an entire line of accessories. Get all the facts, without obligation, on the "right sound" for your needs. Complete and mail this coupon today.

NAME _____
COMPANY _____
ADDRESS _____
CITY _____ STATE _____ ZIP _____

Mail to: PRECISION ELECTRONICS, INC.
9101 King St., Franklin Park,
Illinois 60131



Circle 21 on Reader Service Card

CALENDAR

APRIL

- 8-11 **Meeting of the Acoustical Society of America**, Conference Center, Austin, Texas.
- 21-23 **ASTM Committee E-33 on Environmental Acoustics**, St. Charles, Ill. Contact: Mr. Charles W. Rodman, secretary, Batelle Memorial Institute, 505 King Ave., Columbus, Ohio 432101. (614) 299-3151.
- 23-27 **SONEX Europe '75**. London

MAY

- May 2 **NOISEXPO '75 National Noise and Vibration Control and Exhibition**. Marriott Motor Hotel, Atlanta, Georgia. Contact: NOISEXPO, 27101 E. Oviatt Rd., Bay Village, Ohio 44140.
- 6-8 **NEWCOM Electronic Industry Show Corporation '75**. Las Vegas Convention Center, Las Vegas, Nevada
- 13-16 **London International Electronic Component Show**. London.
- 13-16 **Audio Engineering Society, 51st Convention**, Los Angeles Hilton, Los Angeles, Ca.

JUNE

- 9-27 **Brigham Young University Audio Recording Technology Course**. Contact: Russel Peterson, Brigham Young University, Audio Recording Technology Course, 242 Herald R. Clark Building, Provo, Utah 84602. Phone: (801) 374-1211, ext. 3784.
- 15-18 **AMTEC '75, Canadian Educational Communications Conference of the Association for Media and Technology in Education**, Calgary, Alberta, Canada. Contact: Garry Smith, ACCESS Television South, Calgary Health Sciences Centre, 1611 29th St. N.W., Calgary, Alberta T2N 4J8.

JULY

- 8-11 **INTER NAVEX '75 (Audio Visual Aids in Education)** London.

OPERATION UPDATE!

Add sophisticated, highest-quality **ADM**[®] components to your console



560S VUE-SCAN

Replaces up to 28 VU meters—eliminating annoying "head swiveling". Displays each analog channel as an easy-to-read illuminated bar graph on a TV-type screen for convenient monitoring. Overmodulated condition of any channel is quickly identified.

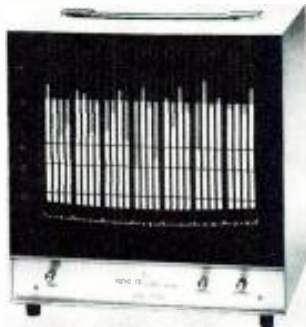

TV TYPE MONITOR

Visually displays either the audio spectrum or 28 recording channels on the monitor screen by a simple switching network.



660 SPECTRUM ANALYZER

This Real Time Audio Spectrum Analyzer divides the frequency range of 40 Hz—20 KHz into 28 third octave filters, which are displayed as 28 illuminated bars on a TV monitor screen. Two time constants—averaging or peak and hold. Monitor-compatible with 560S VUE-SCAN.

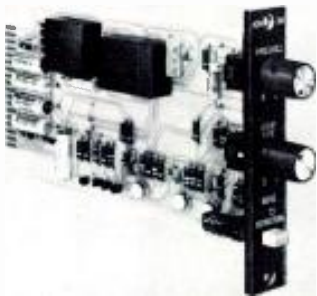

301 NOISE SUPPRESSOR

Fast gain expander that puts silence where previously there was noise. Continuous varying gain, no threshold clicks. Extremely fast attack time, smooth operational characteristics.



SLIDEX

Unique, noise-free linear attenuator with elements sealed against dirt. No contacts to clean.



1500/1501 EQUALIZER

Unity gain equalizer, designed to provide EQ anywhere in an audio system. Four bands and reciprocal functions provide absolute control over the entire frequency spectrum.



NRC SERIES CONSOLES

ADM's NRC Consoles are built to the most exacting quality standards. Unique plug-in modules provide exceptional flexibility for expansion.

ADM offers a selection of professionally engineered components which provide complete flexibility. With them you can update your console to meet the most exacting demands of today's recording operations and provide for future expansion. Write for Technical Bulletins detailing the features of ADM components.

AUDIO DESIGNS AND
MANUFACTURING, INC.
16005 Sturgeon
Roseville, Michigan 48066
Phone: (313) 778-8400, Cable: AUDEX

In Canada: TELAK
Scarborough, Ont.
(416) 438-3804



Circle 22 on Reader Service Card

• Mr. Doe—the fellow with the hum problems—turned up last week (on the phone), and we talked for a bit about the general subject of grounding, shielding and such. It turns out that some of my guesses weren't too far off base.

He's using a good semi-pro tape recorder—one with unbalanced phono jack inputs. At the machine, he tied the microphone cable's shield and one conductor to the phono plug's ground side, with the other conductor going to the "hot" terminal. For single microphone pickups, that usually works out all right, but at the time of our phone conversation, he was having some trouble with r.f. interference.

As we talked, it turned out that in place of a console, he had some variable L pads in the microphone lines (!!!), and there were some professional 3-pin plugs on the L pad network, but elsewhere, it was back to the hi-fi type phone plugs.

Mr. Doe was calling on the morning after the night before, when a session got cancelled on account of the r.f.i. It seems they were picking up a Spanish language broadcast in the studio, and since it wasn't supposed to be a Latin session, the unexpected music couldn't be worked into the recording.

While we were talking, Mr. Doe unplugged the L-pad network, and simply plugged a microphone into the tape recorder with a length of cable. Away went the r.f. problem, along with some assorted hums and buzzes. Needless to say, the pads were a trouble spot and although I still don't know all the specifics, there are a couple of general comments that might be made here.

Keep away from microphone lines! They should have a microphone on one end, and a console on the other, with nothing in between. Once you cut into the middle somewhere, you're asking for trouble.

Mic lines carry very low-level signals, right? So, the microphone pre-amp in the console (or tape recorder) must supply a lot of gain to bring the mic level up to line level. That's a big jump in level. Any little noise in the mic line will also be amplified most impressively. In fact, the microphone-to-console path is a great place

to check out any suspicious cables you may have lying about. If a cable will work here, it'll work anywhere. However, you must treat it with some respect. If you plug into (or out of) a mic line while your control room input is live, you'll hear a great explosion, as every amplifier in your signal path goes berserk. It's a great way to test fuses and speakers. Poor connections will also play havoc with your signal every time someone moves a cable.

USE BALANCED LINES

Ideally, balanced lines should be used, so that induced noises in the line will cancel out. If you have a balanced line, and insert an L pad in it, you don't really have a balanced line anymore. There's a resistor in one of the conductors now, and induced voltages and r.f. have a better chance of being heard. The pads that many manufacturers sell are H pads, with resistors in both lines, to keep noises at a minimum. If you run unbalanced lines, with L pads, and hear radio programs, it's because you have built yourself a nice antenna. With luck, you may be able to tune in the station of your choice by cutting or lengthening the cable, or re-arranging its position in the studio. If you run an unbalanced line up the wall, you may even be able to pull in overseas.

But perhaps that's not quite what you had in mind when you built your studio. In that case, try to use balanced lines, and buy good cable. In the walls, that means Belden 8451 or equivalent for single lines, or a multi-pair cable if you're running a bunch of lines. Some folks prefer to run as many lines of single pair cable as required, since the multi-pair stuff can be a bit of a problem when it comes to dressing it at both ends.

When you go to the cable store, you'll find out that the good stuff is not cheap. If you buy the cheap stuff, you'll find out *why* the good stuff is not cheap. So, if you run into a bargain priced "equivalent," take a good long look before buying a few thousand feet.

MICROPHONE CABLE

Once in the studio, you'll need a

flexible microphone cable to throw around on the floor so that musicians will have something to trip on. Beyer MK 72 is quite good, although Switchcraft plugs should be used with it. These plugs have set screws which will grip the outer covering firmly, and act as a strain relief. If the covering is not firmly gripped, it eventually pulls away from the plug, exposing the shield and conductors.

If you're using any of the popular phantom-power supplies for your condenser microphones, a good shield all the way from microphone to console is an absolute must, even if you're not having r.f. problems. The shield is attached to the negative side of the power supply, and if there's a break somewhere—say, at a connector in the cable run—your phantom-powered microphone won't work.

As an aside on the subject of phantom powering, I previously mentioned the AKG 452 microphone as being the equivalent of the 451, but designed to work on 48 volts, thereby implying that the 451 would *not* function at this voltage. Reader Bob Katz points out that the AKG literature states that the 451 has a built-in zener diode that lets it run at any old voltage from 7 to 48. That's quite true, *but* the zener draws a lot of current, and some of the standard 48V phantom supplies may not be able to handle the load. Or, the supply voltage may drop too low for the other microphones being used. If the supply is big enough or if you're running only one or two 451s and no other condensers, you may not get into trouble. But chances are you will, in many multi-mic setups. The 452 is designed to avoid this sort of problem.

GROUNDING & GROUND LOOPS

Getting back to shielding, if you want to go really first class—or even if you don't, but happen to work in a particularly nasty r.f. area—you can get microphone cable containing three conductors plus shield. Here, the third conductor acts as the negative power supply return. Which once again brings us—more or less—to the subject of grounding and ground loops.

After a few hours of work in any studio, most of us start using the

For sheer reliability, few things can beat our RE15 microphone:



And we're conceding only the slightest of edges to the sun.

Because the RE15 is one mike you can always count on to give you the same reliable response at any distance, any angle. It's a continuously Variable-D® cardioid microphone—an exclusive E-V design.* Once you've set your equalization, all that varies is the level.

Unwanted noise is no problem, either. Not with a super cardioid pattern that provides maximum rejection at 150° off axis. So when the mike is tilted in its most natural position—30° from horizontal—you'll be sure of getting maximum rejection in the horizontal plane. And there's a 100-Hz cutoff "bass tilt" switch for boom use and

other long reach situations.

Other features abound. Like a "hum buck" coil to supply an extra 25 dB of hum rejection. And a rugged design that stands up to shock and mechanical abuse.

The Electro-Voice RE15. So you can work with confidence in the most demanding professional applications.

RE15...\$180.00 RE16...(with blast filter) \$190.20. And for slightly less demanding situations. RE10...\$110.10. RE11 (with blast filter)...\$120.00. Suggested Resale Net Prices. Slightly higher in Western States.

*U.S. Patent Number 3,115,207 Trade mark registered.

Electro-Voice INC.
a **gulton** company

Electro-Voice, Inc., Dept. 451BD
686 Cecil Street, Buchanan, Michigan 49107



Circle 23 on Reader Service Card

RADFORD

Audio Measuring Instruments

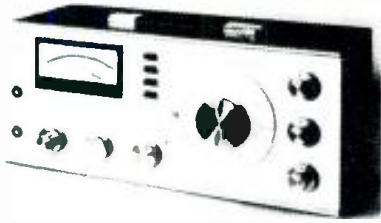

Low Distortion Oscillator Series 3

A continuously variable frequency laboratory oscillator with a range of 10Hz-100kHz, having virtually zero distortion over the audio frequency band with a fast settling time.

SPECIFICATIONS:

Frequency range: 10Hz-100kHz (4 bands)
Output voltage: 10 volts r.m.s. max.
Output source resistance: 150 ohms unbalanced (plus 150/600 balanced/floating)
Output attenuation: 0-100dB (eight, 10dB steps plus 0-20dB variable)
Output attenuation accuracy: 1%
Sine wave distortion; Less than 0.002% 10Hz-10kHz (typically below noise of measuring instrument)
Square wave rise and fall time: 40/60 n.secs.
Monitor output meter: Scaled 0-3, 0-10 and dBV.
Mains input: 110V/130V, 220V/240V
Size: 17" (43cm) x 7" (18cm) high x 8 1/4" (22cm) deep
Price: 150 ohms unbalanced output: \$950.00.
150/600 unbalanced/balanced floating output: \$1070.00.

Distortion Measuring Set Series 3

A sensitive instrument with high input impedance for the measurement of total harmonic distortion. Designed for speedy and accurate use. Capable of measuring distortion products down to 0.001%. Direct reading from calibrated meter scale.

SPECIFICATIONS:

Frequency range: 5Hz-50kHz (4 bands)
Distortion range (f.s.d.): 0.01%-100% (9 ranges)
Input voltage measurement range: 50mv-60V (3 ranges)
Input resistance: 47Kohms on all ranges
High pass filter: 12dB/octave below 500Hz
Power requirement: 2 x PP9, included
Size: 17" (43cm) x 7" (18cm) high x 8 1/4" (22cm) deep
Price: \$770.00

AUDIONICS

10035 NE Sandy Blvd.
Portland, Oregon 97220

Authorized U.S. Sales Agency for
Radford Laboratory Instruments

the sync track (cont.)

words *shield* and *ground* interchangeably, especially when wiring cables. Well, you can call it anything you like, just as long as you remember what it's supposed to be doing, and what it's *not* supposed to be doing. A shield is supposed to protect (or shield) the inner conductors from evil influences: hum, buzzes, r.f., and all that. It's not supposed to be carrying a current, except in phantom powering. A ground is supposed to keep people from getting zapped, and is not supposed to be part of any audio line. If a shield winds up being used as a ground, you're not going to like what you hear.

It seems there's a charming notion going the rounds, that once you plug in a bunch of equipment—using three conductor a.c. lines and plugs—all the various chassis are at ground potential. That's a lovely thought, but it doesn't quite work out that way.

Somewhere in the building, there's a good solid ground, or earth, connection. (Well, let's *hope* there is). Usually, it's a water pipe, and your electrician has connected his ground wire to it, and off it current goes to all the a.c. receptacles in your building. *However*, the ground wire has a resistance—not such that you would notice, but it's there.

Now, one machine is plugged in near the earth connection, and something else is plugged in a little further away. If you ask your electrician, he'll tell you both devices are grounded and so they are. But, one's a bit more grounded than the other. If you want to hear all about it, just plug in a cable between the two devices—one with the shield connected at both ends. You've just created a nice low-resistance path between the two devices, and re-discovered the ground loop. Listen to that 60 Hz hum as it zips along your audio line! Your shield has become a ground, and you find out there *is* a difference between the two words after all.

The best way to prevent that shield from causing trouble is to leave it unattached at one end (*not* both ends). Connected at one end only, it *shields* without *grounding*. If you're starting your studio construction from scratch, it may be convenient to connect all cable shields at the equipment rack, since this is a central location electrically. Cables that do not run through the rack at all might have their shields connected at the output end of the cable, or perhaps at the input end.

The important thing to do is establish a standard and stick to it. Other-

wise, it'll be strictly guess work later on, when new equipment is added, or modifications are made. That's why so many studios have to suffer through the cut-and-solder method. No one's really sure just what the last crew did, and it's strictly 50-50 chance in trying to decide about connecting the shield.

CENTRAL GROUND POINT

It's also nice to have a central ground point, again perhaps in the rack. Run the biggest piece of wire you can find from the water pipe to this point. Then run separate ground wires to the chassis of each (yes, *each*) piece of equipment from this point. This grounding system takes the place of the standard a.c. receptacle ground, which should be disabled if your local electrical ordinance permits. Attach these various ground wires so that they cannot come undone by accident. Now, even if some machine is unplugged, it is still solidly grounded.

It's very easy to check the system out for accidental ground loops. With the power off, lift the ground connection from a chassis and measure the resistance between the disconnected wire and the chassis. You shouldn't get any reading. If you do, there's an accidental ground loop somewhere. Start unplugging audio cables until it goes away. As soon as it does, you've got your hand on the bad cable. Fix it. Then plug everything back in, and don't forget to re-attach the ground wire.

We followed this procedure in our control room at the Institute of Audio Research. After all, it *is* embarrassing to be discussing some fine point in mixing technique, and have to shout to be heard above the 60 Hz. Everything worked fine, until we turned the console monitor control to maximum. Then we got some horrendous squealing noises. It seems we had overlooked a ground wire to our power amplifier. The normal chassis-to-rack grounding that occurs just by screwing the amplifier in place was not good enough. A run of grounding cable from our central grounding point to the amplifier solved everything.

Make sure you do *not* follow this shielding technique when preparing your microphone lines. These should have their shields connected at *both* ends, so that the microphone remains connected via shielding, to the console regardless of how many extension cables are used. Since the microphone is out in space somewhere, there's no danger of a ground loop occurring. ■

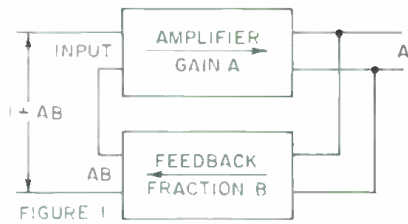

Figure 1. The accepted block diagram for illustrating the action of feedback.

● Some years ago, when I was writing for another publication, the editor said to me, "Why don't you do an article on . . .?" My answer was that I'd already said most that could be said on that subject, in his magazine, on previous occasions. Somehow, I have a sort of fear of repeating myself.

Part of that may have a legal basis: most everything published becomes copyrighted and if you write the same thing twice, and sell it both times, either to the same or different publishers, then you are infringing the copyright the publisher already has on what you wrote before. And perhaps the fact that such is the law, regardless of the fact that it seldom gets applied, makes me think it must therefore be unethical, even if I should not get caught doing it.

Years ago, I wrote a book about *Feedback*. It has long since been out of print, so I would not be stealing anyone's copyright if I quoted the whole thing as originally written. One of the reviews of the book said, "It explains the Nyquist diagram, for example, in terms understandable to the average technician—a new feat in audio literature."

That plug carried the book through a number of printings before it eventually died. For a long while, I avoided covering the same subject matter elsewhere, anxious to avoid unnecessary repetition. But the same misunderstandings that prompted me to write the book in the first place, still persist.

FEEDBACK THEORY

So let us run through feedback theory briefly. The usual way is to draw a block diagram (FIGURE 1) in which the forward gain is given the symbol "A." Of this a fraction, "B," is fed back, reducing the input, or re-

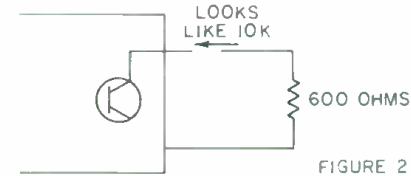

Figure 2. Connecting an output load to amplifier can change things, with or without feedback.

quiring a larger input, to produce the same output. Now, the product AB is called the *loop gain*. This is usually a number. You may use 20 times log to the base 10 of the number, and call it *dB loop gain*.

That assumes negative feedback. If you start with unit input, which could be 1 volt, 1 millivolt, 1 milliamp, or whatever is relevant, then the output is "A" times whatever that is. And the feedback portion is AB times the input. So the input needed to provide the same output, A , must be $1 + AB$.

To see what that means, let us try some figures. Suppose input is 1 millivolt, and A is 10,000. Then output will be 10 volts. Now suppose B is $1/1000$. Then AB , or the loop gain, will be $10,000/1000 = 10$. And $1 + AB$ will be $1 + 10 = 11$. So an overall input of 11 millivolts will produce an output of 10 volts. Gain with feedback will be $10,000/11$, which is about 910.

All right, to make this a more modern example than would have been relevant in my book of 30 years ago, suppose this is an op amp, whose minimum open circuit gain is rated as 10,000. But it could also be as high as 100,000. What then? Now A is 100,000, AB is $100,000/1000 = 100$. And $1 + AB = 1 + 100 = 101$. So gain with feedback is now $100,000/101$, which figures to about 990.

In dB, loop gain would be 20 dB, or 40 dB respectively. And gain with feedback is close to 1000, or 60 dB. More precisely, when loop gain is 20 dB, gain with feedback is 59.17 dB and when loop gain is 40 dB, gain with feedback is 59.91 dB. Both of them are within 1 dB of 60 dB. The feedback fraction, $1/1000$, is 60 dB.

In most textbooks, this theory is then applied to what feedback does, such as stabilizing gain, reducing dis-

ortion, changing input or output impedance, etc. We have already applied it to stabilizing gain. Without feedback, the change in gain was 20 dB, from 80 to 100 dB. With feedback, it was 0.74 dB, from 59.17 to 59.91 dB.

Suppose the distortion without feedback is 2 percent. It is reduced by the feedback factor, $1 + AB$. In the first case, this is 11, reducing distortion to 0.18 percent. In the second case, this is 101, reducing distortion to 0.02 percent.

MODIFICATION OF IMPEDANCE

So far no serious problems with the figuring. But next we come to modification of impedance. This gets a little more complicated. First, it depends on whether the feedback is voltage or current derived at the output and then whether it is series or shunt injected at the input. And after that—well, let's take that first.

Suppose the internal resistance is 10k and the amplifier is intended to feed a 600 ohm load. Without feedback, if the amplifier delivers 10 volts open circuit, it will deliver only 0.6 volts when the 600 ohm load is connected (approximately, FIGURE 2). Now put the two values of feedback in. With-



the new standard in professional audio design

amplifiers



**DX, TAX
SERIES
70 TO 250
WATTS RMS**

INCOMPARABLE solid-state amplifiers for continuous-duty performance, available in a broad selection to meet professional audio amplification requirements.

mixer-amplifiers



**SPECTRUM
SERIES
40, 80, 120
WATTS RMS**

SUPERIOR mixer-amplifiers with less than 1.5% THD and program equalization provisions. Flexible, advanced design; professional in every sense of the word—for the most demanding applications.

input equipment



**4907R
PREAMP

4908
MIXER-
EXPANDER**

OPTIMUM mixing performance in maximum flexibility input equipment. Ideal for broadcast and recording use, theaters, auditoriums, and churches. Distinguished for ultra-low distortion and wide-range performance.

for equalization



**6101
SPECTRUM
MASTER**

PRECISE professional acoustical analysis and system correction in minimum time is now at your command with this all-new $\frac{1}{2}$ Octave Active Filter Test and Correction Instrument-System.

WRITE FOR TECHNICAL BULLETINS

RAULAND-BORG CORPORATION
3535 W. Addison St., Dept. N. Chicago, Ill. 60618

theory & practice (cont.)

out a load, the feedback factors, $1 + AB$, are 11 and 101, respectively. But with the load, this gets knocked down to 1.6 and 61 respectively.

As the gain, the way we figured it first, was close to 60 dB in each case, let us assume we put in 10 millivolts, to get nearly 10 volts out (open circuit) in each case. Actually, the open circuit voltage would be 9.1 in the first case, and 9.9 in the second. Now load it with 600 ohms. With the load connected, gain without feedback was 600, instead of 10,000 without the load connected, or in the second case, 6,000 instead of 100,000. So for the first case, output with load will be 10 millivolts multiplied by the gain of 600 divided by 1.6, or 3.75 volts. And in the second case, output with load will be 10 millivolts multiplied by the gain of 6,000 divided by 7, or 8.57 volts.

In the first case, an open circuit voltage of 9.1 is loaded down to 3.75 by connecting 600 ohms. So the internal impedance is $5.35/3.75$ times 600, or 856 ohms. In the second case, an open circuit voltage of 9.9 is loaded down to 8.57 by connecting 600 ohms. So the internal impedance is $1.33/8.57 \times 600$, or 92.2 ohms. Quite a difference!

Can you justify those step by step calculations from the usually given formulas? These figures confirm the general conclusion, that voltage derived feedback reduces output internal impedance. In this case, from 10k down to 856 ohms or 92.2 ohms.

If the feedback is current derived, the output internal impedance is increased by the feedback.

At the input end, if the feedback is series injected, as shown in FIGURE 1, then input impedance is increased by feedback. If it is parallel injected, the input impedance is reduced by feedback.

NYQUIST DIAGRAMS

All that seems fairly simple. But it assumes perfect, negative feedback. And that was where Nyquist diagrams came into the picture. Before looking at intermediate phase angles, let us see what positive feedback does. There, if the feedback signal ever gets to be as big as the original input, the amplifier will oscillate, become unstable.

That is the bane of feedback design. All the while feedback is negative, loop gains of 100, 1000, anything you like, are okay. But the feedback must never get to be positive, with the loop gain more than 1. Why should that be difficult?

This is all tied up with rolloffs and

other aspects of frequency response. Low frequency rolloffs can be avoided by using direct coupling and avoiding any need for decoupling. But every circuit has high frequency roll-offs. Extending frequency response, out to megahertz, many more than that, may put the rolloff beyond the audio band, but it will not get rid of it.

At the 3 dB point, any rolloff has a phase shift of 45° . Beyond that, it gets to be nearly 90° quite rapidly. An octave beyond the 3 dB point, attenuation is 7 dB, phase over 60° . Two octaves makes it 12.25 dB, about 76° . Three octaves puts it to 18 dB, about 83° .

One rolloff is okay. It can never get beyond 90° . Two rolloffs double the possible phase shift, but it can never get beyond reversal. Three rolloffs triple possible phase shift, so that reversal can occur with as little loop gain as 8, which is 18 dB. However, careful design can stagger the rolloffs, so that bigger loop gain can be used.

We will not attempt to get into the detail of feedback design here. We have said enough, we hope, to show that it is more complex than many seem to realize. Various texts help in the design problem and if anyone is interested, I will be pleased to supply details of where such data may be found.

B.Y.U. WORKSHOP

Meanwhile, the plans for the audio/recording technology workshop at BYU June 9-27, are moving ahead. What we are doing now is something I mentioned earlier, that has now materialized: preparing mediated materials for individual study, with tape and workbook, to cover much of the "nuts and bolts" type of matter.

With this preparation, participants will be able to utilize their time on campus, and particularly in the classroom and in hands-on situations far more effectively. The outline we have put together, and the way it is shaping up, give us great confidence.

One thing that feedback has been misrepresented in is the impression that to make better whatever is amiss all you need do is to add oodles more feedback. That is just not true, any more than the government attitude that anything can be cured with more money—you know who pays!

Discriminatingly applied feedback, like the use of well-designed mediated materials, can do wonders. We wonder if there is any way that government funds could be applied that usefully? ■

the a.a.s. convention

● Although most of our readers are familiar with Audio Engineering Society conventions, a small handful (if that many) might be aware that the American Association for the Advancement of Science also had a recent convention in New York City, running for a week at the end of January. Headquarters were at the Americana Hotel and City Squire Motor Inn and activities took place at about ten other New York locations, including the Lincoln Center for the Performing Arts, the Metropolitan Museum of Art, New York University Institute of Fine Arts, Bell Labs., and IBM.

Founded in 1848, the AAAS is the world's leading general scientific society. It is non-profit, has over 120,000 members; through its 284 affiliated societies with interests in science and technology, it reaches about two million people. The objectives of the organization are to further the work of scientists and to improve cooperation among them. The society publishes a weekly magazine, *Science*, which has 160,000 worldwide subscribers and contains articles by scientists, and others well known in their fields on topical developments in the sciences, as well as on matters of public interest to the broad scientific community.

In addition to publishing and conducting meetings, the AAAS helps other organizations and conducts activities and programs on such diverse subjects as Public Understanding of Science, Science in the Promotion of Human Welfare, Science Education, Opportunities in Science, Science and Society, etc.

The theme topic of the 141st annual meeting was Science and the Quality of Life, pretty staggering in its scope, but of course the meeting did not pretend to do more than make a start in its consideration of human problems. Sub-themes stemming from the main theme were: Human Health, Human Imagination, Human Environment, and The Metropolis. They were treated in a total of 122 symposia, supplemented by nine public lectures. The subjects and participants stirred a great deal of interest, attracting more than 8,000 persons.

Meetings, discussions, talks, and panel sessions took place at the Amer-

icana and City Squire hotels in more than twenty-six different meeting rooms. Just to show you the depth of some of the meetings, a brief look at a few of the subtopics and the talks themselves will suffice. Then we'll take a look at the T.V. equipment on display.

SCIENCE AND HUMAN HEALTH

The subject of *Science and Human Health* was subdivided into Health Policy and Research, Understanding Human Behavior, and Health Care and Delivery. There were sub-divisions in each of these. The first, for example, took up such subjects as Aging and the Quality of Life, Human Sexuality as a Science, Brain Functions and Physical Well-Being, among others.

A talk that might interest people who care about the fourth form of pollution—noise, entitled *Effects of Noise on People*, was delivered by James D. Miller, professor of psychology at Washington University, St. Louis. The address covered ear damage and hearing loss, their implications and prevention; masking and interference with communication; general psychological and sociological effects; physiological effects. The professor came to some seemingly self-evident conclusions, such as "Noise can permanently damage the inner ear, with resulting permanent hearing losses that can range from slight impairment to nearly total deafness . . . noise can result in temporary hearing losses . . . repeated exposure to noise can lead to chronic hearing losses" and ended with the finding that "Noise can affect the essential nature of human life—its quality."

FIELD TRIPS

We were only kidding about the convention taking place in the ten wide-spread locations around the city. Actually tours were set up for visitors who wished not to attend a few of the sessions. Sites included were museums, a zoo, backstage at the opera, and so on. There was no fooling, though, about the video exhibit and the multi-image presentation put on at the Lincoln Center Library in conjunction with the conference.

The exhibition was set up under the guidance of the Media Development Dept. of Lincoln Center, Inc. and the purpose was "to acquaint the performing arts with the latest video technology and, at the same time, stimulate the arts into taking the initiative to assure the presence of cultural events in future television programming." The multi-image display was also on the same theme to show the possibilities of linking the arts with television, to the benefit of both.

The projection showing took place in the auditorium of the Lincoln Center Library which contained seating for several hundred viewers. The screen was curved and about 30 feet in width. The show was designed and produced by John W. Doswell, Inc., of New York City using slides provided by the library itself.

SLIDE TRICKS

On entering the auditorium, the visitor saw words related to the arts and technology running across the screen in all directions, off onto the walls and ceiling, and then reappearing from another direction and continuing off the screen again. Once the show itself started, the images seemed to settle down to a simple 3-image presentation with the images overlapping each other where they came together. The images dissolved to the next picture in each position; then images started to move across the screen again as at the beginning.

Slide changes took place in sync. with an audio track which talked about the fact that the opera, for example, lost several thousand dollars each time the curtain went up. There had to be a way to link the arts with television technology, the presentation continued, so that both could gain. The images first showed scenes from operas, including some of the equipment and the people, and concluded with an invitation to the viewers to see the latest in video equipment across the hall at the exhibition. As the images showed some of the hardware, a voice discussed the possibilities and offered the invitation. Then the travelling words started again. There were about 15 minutes of worthwhile listening and watching with a message.

This presentation was actually quite simple but with a few interesting innovations. The dissolve images were put on the screen by three pairs of carousel slide projectors, each with a dissolve unit. The moving images were also cast from slides from three indi-

ATTENTION!! STARBIRD MICROPHONE BOOM OWNERS

Available Now From
DIACOUSTIC LABORATORY
GENUINE STARBIRD
BOOM PARTS

- Fix that wornout or broken boom now!
- All parts NEW and original.

Let us know your needs . . .

Contact:

ERNEST M. KNIGHT
DIACOUSTIC LABORATORY
1063 Vine St.
Hollywood, Calif. 90038
Or phone: 213-467-5121

Circle 27 on Reader Service Card

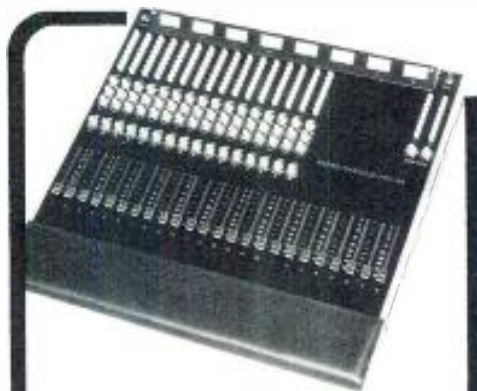

PORTABLE CONSOLES

Internal Batteries or AC Line Powered
with automatic switchover
THE ROBINS/FAIRCHILD
FPC SERIES

Four full-featured models available with:

- MIC/Line inputs with equalization.
- Push button switching-active mixing.
- Solid state electronics.

FPC 28 8 inputs - 4 outputs
FPC 34 12 inputs - 4 outputs
FPC 42 16 inputs - 4 outputs
FPC 50 16 inputs - 8 outputs

NAB Booth 911

FOR COMPLETE DETAILS
CALL OR WRITE RICK BELMONT

ROBINS & FAIRCHILD
A Robins Industries Corporation
75 Austin Boulevard, Commack, N.Y. 11725
(516) 543-5200

Circle 28 on Reader Service Card

sound with images (cont.)

vidual carousels, each with a rotating prism in front of the lens.

The operation of the system was controlled manually from a console, which had originally been designed for a more complex show. On the left, a series of switches permitted each of the eight input channels to be set for either manual or automatic operation. On the right, preset and control buttons set up the function to be activated and allowed manual activation. The operating buttons were cleverly set up in an arc which fit comfortably under the fingers of a hand held in a restful operating position.

To permit more than eight controls to be handled, the system was provided with a 40-channel expander. Not all channels were required, of course, in this show, but dissolve operation, prism rotation, projector lamp on/off, etc. could be managed very easily. The ¼ inch tape which provided the sound track was played on a stereo Sony unit. The equipment described in the show was all demonstrated right across the hall.

LIVE TELECASTS

According to Mr. John W. Mazzola, managing director of Lincoln Center's Media Development Program, they have been "exploring new techniques and technologies for live-performance telecasts—both as a means of increasing the exposure of the performing arts and as a way of generating much-needed revenues. We hope this exhibit will focus the attention of the performing arts community on the potential of these new television developments, and that both television and the performing arts can mutually benefit from the new technology."

The hardware exhibit was divided into four categories: pickup, storage, transmission and display. Pickup devices included solid-state television cameras small enough to fit into the palm of the hand; image intensifiers that enable a television camera to operate in starlight; remote controlled cameras for inaccessible places; and inconspicuous microphones with studio quality. Storage units displayed home videodiscs the size of a phonograph record, capable of playing a complete color television program with stereo sound; frame grabbers that could select any one of 1800 different pages of information transmitted each minute on a single television channel or to catch a single frame of a TV show; and home video tape recorders.

The transmission category included cable and pay TV; video transmission

by laser; quadriphonic TV sound and satellite communications; projection TV; video printing; and flat-screen display systems. There was also an exhibit tracing the development of television from the first tubes to the latest recording system and computerized choreology.

About 60 exhibitions were set up quite close together in the small areas being used, but the walk through was worth the effort. Among the exhibitors were RCA with their early TV tubes and solid-state camera, GE and Bell Labs each with a small camera, and Fairchild Camera with a very unique mini-camera. This had a circular shape with a lens protruding from one flat side (like a low circular can with the lens sticking out of the top). The camera was 3 inches in diameter and 1⅞ inches long. The lens mounting was the standard "C" type for any TV or camera lens. The camera weighed 11 ounces.

An array of 10,000 photo sensors were assembled on a standard 24-pin dual in-line package. These charge-coupled devices (CCD) are a great improvement over vidicons for several reasons; they possess the broad spectral range of silicon, are drift-free, and are extremely tiny. Horizontal scan is the normal 15, 625 lines, but the vertical is 123 frames per second with 2:1 interlace. This requires a modification in the monitor if video information is required.

i/o Metrics showed the home video disc system, Tektronix had a video hard-copy unit, Akai presented the ¼ inch video recorder via Telemeasurements, Javelin showed its image intensifier, and large screen TV projection was demonstrated by Shannon, GE, and Advent Hitachi demonstrated its magnetic disc frame grabber and Hughes Aircraft displayed its scan converter frame grabbing unit.

There was no kidding about the advances made in the video electronics field, and the possibilities of tying in performing arts with TV. We have only mentioned some of the material in the talks and exhibit. There was much more. The entire convention was most informative. And we did not even get to mention that there also was a series of science films shown each day, all day, each film only once because there were so many of them—all on the subjects being discussed.

If we have whetted your interest, prepare to attend the next AAAS convention, or the one after that. The 1976 (142nd) session will take place Feb. 18-24 in Boston. ■

Kustom**ELECTRONICS, INC.**
CHANUTE, KANSAS 66720

DATE	TOLERANCES UNLESS NOTED	MOLES 1.008
9.3.74	LINEAR .XX ± 1.010	ANGLES 11 degrees
9.3.74	PLANE .XX ± 1.03	
MF-1012 DRIVER		
DRIVER	PART NUMBER	
HALF	OP	038-0081-00

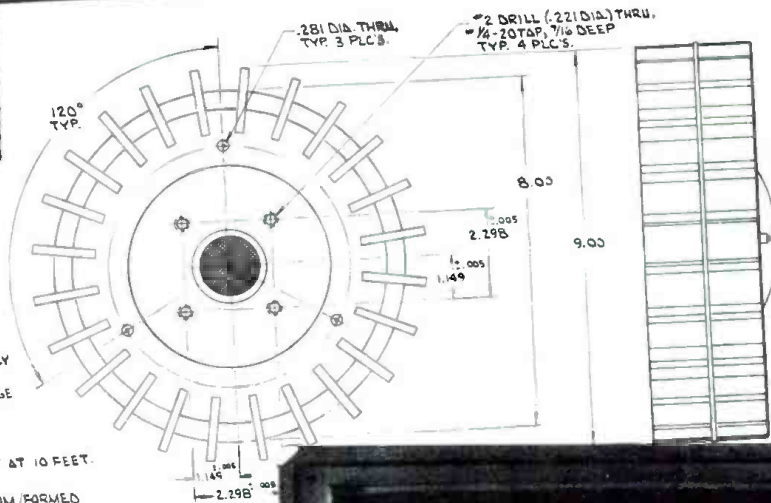
**NOTES:**

1. FREQ. RESPONSE: 400-13,500 HZ. ESSENTIALLY FLAT USING THE VIII OR XII SRS.
2. POWER CAPACITY: MINIMUM 40 WATTS AVERAGE OF PINK NOISE FOR 100 HRS.
3. MAX. ACOUSTIC POWER OUTPUT: 12 WATTS MID-BAND (400-2,000 HZ.)
4. SENSITIVITY: 119.5 dB WITH 40 WATTS INPUT AT 10 FEET.
5. DRIVER IMPEDANCE (NOMINAL): 8 OHMS.
6. DIAPHRAGM ASSY. CONSTRUCTION: ALUMINUM FORMED THERMOSET PLASTIC.
7. VOICE COIL CONSTRUCTION: EDGEWOUND FLAT ALUMINUM WIRE ON THERMOSET PLASTIC FORM.
8. MAGNETIC STRUCTURE: FERRITE & HIGH-PERMEABILITY STEEL, 15 LBS.
9. HORIZONTAL DISPERSION: 93° PLUS OR MINUS 10° IN 500-10,000 HZ. OCTAVE BANDS WHEN USED WITH HI-FREQ. HORN. 75° IN OTHER OCTAVE BANDS.
10. VERTICAL DISPERSION: 40° PLUS OR MINUS 5° IN 500-10,000 HZ. OCTAVE BANDS WHEN USED WITH HI-FREQ. HORN.

WHAT MAKES AN MF-1012 AN MF-1012 ?

Kustom's new MF-1012 is the most efficient portable, mid-range/high-frequency sound reinforcement product available today in the commercial market.

The system's efficiency results from the use of the exclusive Kustom MF-1012 driver, designed specially for use with the Kustom MF-1012 90° x 40° horn.

The driver provides extremely high power output over a wide bandwidth (400-13,500Hz), and its efficiency approaches 30% over a good part of this frequency range.

Employed with the Kustom MF-1012 horn, a 1-watt input to the MF-1012 driver produces a 103.5dB sound pressure level at 10 feet. 40 watts input produces a midband output of 12 acoustic watts, which translates to 119.5dB SPL at 10 feet outdoors. Power handling capacity exceeds 125 watts RMS.

Driver response extending smoothly to 13,500Hz is rarely attained in sound reinforcement. Key to this performance

factor is the driver's specially-drawn aluminum diaphragm which provides a much higher stiffness-to-weight ratio than the more often used phenolic material. Diaphragm output is channeled to the horn throat through a precision phasing plug molded of glass-filled Lexan to tolerances of ± 0.001 inch, providing in-phase transfer of diaphragm energy to nearly 20,000Hz.

The dispersion of sound from the MF-1012 modified radial horn is more uniform than that provided by multicellular or conventional radial designs. Sound quality at 45° to either side of the horn's vertical axis is identical to the sound on axis in octave bands from 2,000 to 10,000Hz. Sound quality at 20° above and below the horizontal axis is identical in the same octave bands.

KUSTOM'S MF-1012. HEARING IS BELIEVING!

Manufacturer's Suggested Retail List Price: \$650.00.

ELECTRONICS, INC. 1010 WEST CHESTNUT, CHANUTE, KANSAS 66720

Circle 29 on Reader Service Card

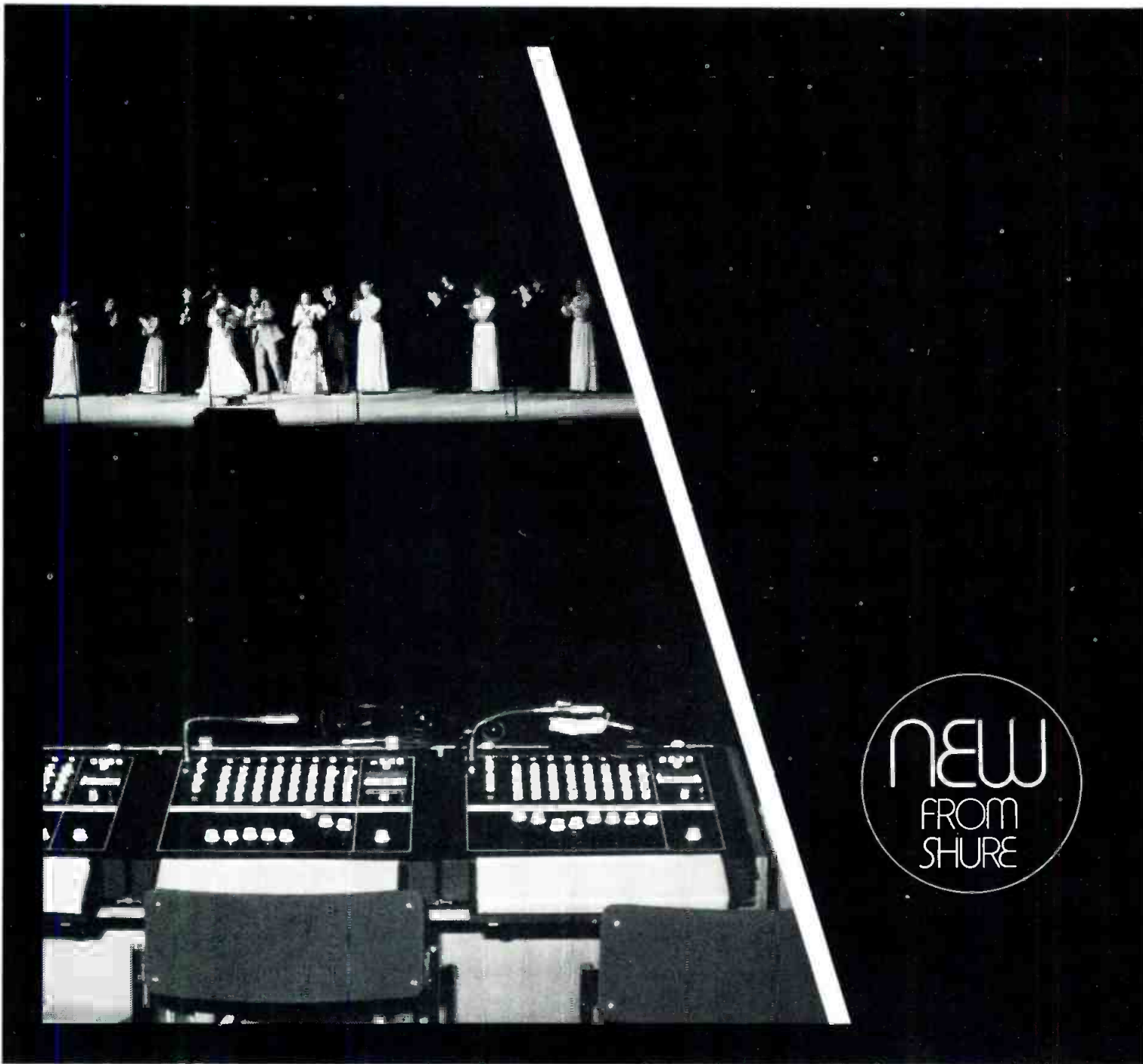

NEW
FROM
SHURE

SHURE SR PROFESSIONAL SOUND REINFORCEMENT EQUIPMENT

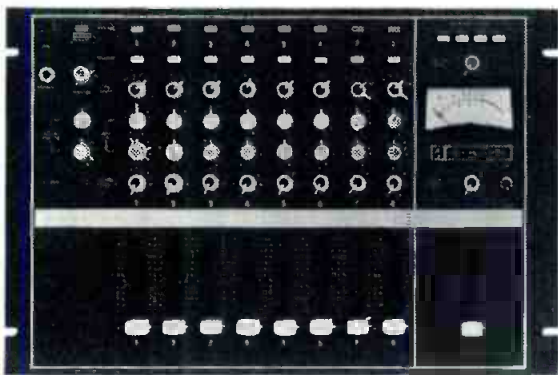

db April 1975

MISSION TO MOSCOW

...WORLD'S TOUGHEST TEST FOR THE NEW SHURE SR SOUND

When Opryland undertook the recent, eminently successful U.S. State Department five-city, 27-performance tour to Russia, soundman Tom Moores faced an overwhelming array of uncommon problems that called for an extraordinary sound system. Fail-safe reliability was a must due to time factors and remoteness—the nearest source of U.S. repair parts or equipment was often over 1,000 air miles away. Sound quality requirements were a matter of International Prestige. The system he chose consisted 100% of Shure SR Professional Sound Reinforcement Components and Shure SM54 microphones!

"... SIZE TO PERFORMANCE,
THE BEST I'VE EVER SEEN!"*

Years of research and development—plus four years of field-testing in every conceivable big sound application, coupled with in-depth consultations with a Who's Who of sound installers, soundmen, road managers, and auditorium technicians went into the design of this rugged, reliable, professional equipment. SR components can be used as a system (or inserted as individual links

within a system of quality componentry) in virtually unlimited combinations with assurance of uncompromising quality—in power, intelligibility, musical purity and controlled coverage. SR is already in use as the main sound system in many Vegas hotels, Chicago auditoriums and hotels, churches, and giant amusement parks.

A WHOLE NEW SPECTRUM OF AUDIO TOOLS

The Shure SR101 audio console accepts eight balanced low impedance microphones (two channels switch to high level inputs), each with individual controls for volume, reverb, high- and low-frequency equalization, and input attenuation. The SR105A 200-watt continuous (RMS) power amplifier with bridging capabilities to obtain 400 watts (RMS) permits either direct speaker coupling or direct- and transformer-coupled output for 70-volt lines. The SR108 is a wide-response, wide-dispersion speaker system, has biamp capability, and is suitable for permanent or temporary installations. And an array of custom accessories add further flexibility.

*Tom Moores talking about SR equipment.

Read all about it in the brochure between pages 20 and 27.



Call collect for
Technical information, the name of
your dealer, and sound installation
application guide and catalogs.
SHURE HOT LINE
(312) 679-8565



Manufacturers of high fidelity components, microphones, sound systems and related circuitry.

Send technical information, name of dealer, and sound installation application guide and catalogs.

Name _____

Address _____

City _____

State _____ Zip _____

Call me (Tel. No.): _____

Shure Brothers Inc., 222 Hartrey Ave., Evanston, IL 60204
In Canada: A. C. Simmonds & Sons Limited

A Remote Powered Direct Box

New design surpasses transformer-in-box approach and it ensures quality and power.

DIRECT BOXES are generally used in studios or for sound reinforcement to match a very low-level, high-impedance voltage source from an electric guitar or bass to a console line or microphone input.

Most direct boxes that I have used usually consist of a matching transformer in a box with the appropriate connectors. That approach seems to have some merit since many of these devices are in use around the world. The disadvantage is that electric bass and guitar pickups are designed to work into a very high, 0.50 meg. ohm or higher resistive load. The net result is that the musician is unhappy. Being a musician of sorts, but primarily an engineer, I hear such complaints as: "I don't like the sound" (studio application) or "It cuts my power" (concerts), and a variety of other ills which may or may not be the direct box's fault.

The direct box design that follows is the result of a request from Leon Russell for use in his house, 40-track facility. The requirements were that it could be used with the existing API console microphone inputs which are 48.0 Vdc powered, and that loading effects were to be negligible. These requirements necessitated more than a transformer-in-box approach.

A battery-powered amplifier with a transformer-coupled output was considered until Roger Lynn, a talented

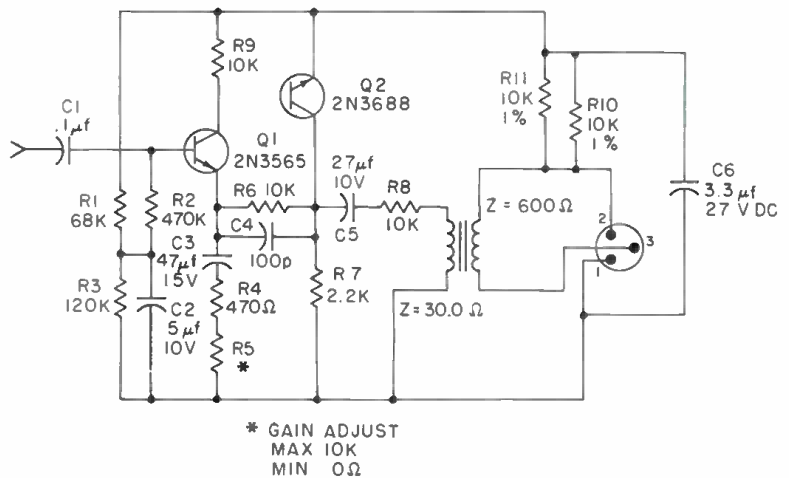

Designed for Leon Russell House Studio, above circuit is for a direct box that is phantom-powered from an API console.

musician, asked "What would happen if the battery went dead when the 40-track was rolling?" That prompted the following design approach.

ABOUT THE CIRCUIT

The circuit itself is a straightforward d.c.-coupled two-stage amplifier with provision for gain adjustment. The minimum input impedance is approximately 0.50 meg. ohm, and the gain is adjustable to allow for the use of different output transformers. The transformer is used for impedance matching and d.c. isolation for remote powering from the console. The transformer used in the author's circuit has a 30.0 ohm primary and a 600 ohm secondary. Resistor R8 allows the use of any type of transformer so long as the transformer itself meets the frequency response,

distortion, and power-handling requirements. The amplifier is designed to drive a 10k load, thus the use of R8 in this circuit.

The only critical components are R10 and R11, which must be of 1.0 percent tolerance. That value is not critical so long as the voltage at the emitter of Q2 is approximately 24.0 volts. It is also suggested that the circuit be enclosed in a steel box rather than aluminum to prevent outside fields (such as power transformers in guitar amps) from being induced in the transformer.

Acceptance by the musicians and studio staff has been excellent. Musicians like it because they can't tell it's there, and the engineers don't have to worry about the level being high enough or batteries going dead in the middle of the session. ■

Lothar A. Krause is electroacoustical consultant and product definition manager, Kustom Electronics, Inc., Chantue, Kansas.

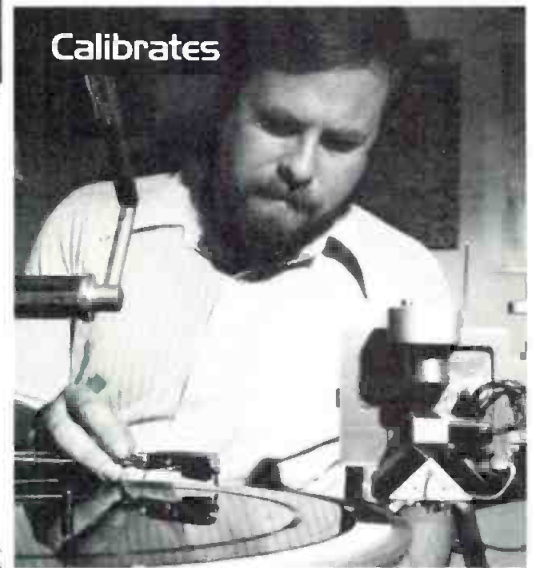

Capitol Records Calibrates · Evaluates · Approves · Tests · Repairs · Quality Controls · and Reviews with the Stanton 681 Cartridge Series

The physical process of making phonograph records is not for amateurs. It is a job for craftsmen of the highest order, craftsmen who know exactly what they are doing. Naturally, they need the precisely right tools to do the job.

In the case of Capitol Records, the highest quality tools are employed throughout the process. That is why Stanton 681 Calibration Standard Series Cartridges are used, with various styli that are designed specifically for each critical measuring and listening job.

It has proven to be a great advantage to Capitol Records to standardize their entire operation with the 681 Series and three basic styli:

The D6807A — for cutting system check-outs.

The D6800EEE (our famous Triple-E) — for the most critical listening.

The D6872AMC — for tough nickel-plated "mothers".

The Stanton 681 Calibration Standard Series enjoys almost universal acceptance throughout the Recording

Industry. After all, it was created in order to satisfy the need for a cartridge of sufficient sophistication to be used as a primary Calibration Standard in system check-outs for linearity and equalization. Stanton Magnetics met this need by producing an "absolute" cartridge standard . . . stereo cartridges of such linearity and overall quality as to gain immediate acceptance within the Recording and Broadcasting Industries.

The fact that Capitol has selected the Stanton 681 Calibration Standard Series for use throughout its operation is a testament to its quality.

All Stanton Calibration Standard Cartridges are guaranteed to meet specifications within exacting limits. Their warranty comes packed with each unit . . . the calibration test results for that individual cartridge.

Whether your usage involves Recording, Broadcasting or Home Entertainment, you can enjoy professional audio quality with Stanton Products.



Write today for further information to Stanton Magnetics, Inc., Terminal Drive, Plainview, N. Y. 11803

Circle 31 on Reader Service Card

db new products & services

THREE-MOTOR TAPE DECK



● Reel/reel (10½ inch) tape deck model A-7300 contains a direct-drive d.c. capstan/servo motor with the motor shaft as the capstan, as well as two a.c. reel motors. The unit has three heads, for erase, record and playback. A built-in mixer allows the recordist to blend up to four mic or line signals; there is a separate master input level control for all mic/line inputs, as well as separate output level controls. Interface equipment includes two sets of output jacks, tape/source and tape only. There are separate three-position bias and eq. switches, as well as dual scale vu meters and a vu meter switch which adjusts for both standard or high-energy tapes. The A-7300 has a microswitch push-

button transport control, separate cue lever, constant wind control, and pitch control for precision matching of pitches of two separately recorded passages. Other features include pause control with indicator light, plug-in printed circuits, digital counter and memory markers on the level controls. A half track unit, model A-7300-2T, is also available with additional features.

Mfr: TEAC

Price: A-7300: \$1,399.50

A7300-2T: \$1,449.50

Circle 50 on Reader Service Card

MINIATURE TRANSFER KEY



● Twelve-terminal, four-pole, double throw TK-12 transfer key is available in fifteen instrument coordinated col-

ors. The arrangement of the terminal pads in a multi-level design provides positive separation. Contacts are available in gold or silver. The manufacturer also makes similar 6- and 9-terminal keys.

Mfr: Crest Industries, Inc.

Circle 51 on Reader Service Card

AUDIBLE CONTINUITY TESTER



● An audible pitch, varying in tone according to the amount of resistance (0 to 50 ohms) issues from ACT-1 tester while monitoring electrical wiring and electronic circuits. The manufacturer claims complete safety for delicate components, sensitive circuits and semiconductors. Probes produce 2.5V when circuit is open, and 6mA when shorted. Powered by a 9 Vdc battery, the unit measures 2¾ x 1-3/16 x 3¾ inches. It comes complete with 30-inch probes, battery and alligator clips.

Mfr: Calcomp Consumer Products, Inc.

Price: \$12.95

Circle 52 on Reader Service Card

BROADCAST PRODUCTION CONSOLES



● Flexible BC-5 series production consoles are expandable through the choice of modular plug-in components (770 input and 873 series output modules). The console contains four outputs with individual vus and monitors, cue, foldback and equalizers. It is flexible up to 16 low-level inputs or 28 high-level inputs. There is echo send on all inputs and echo return on all masters.

Mfr: Audio Designs

Circle 53 on Reader Service Card



Only the best is good enough. And that's exactly what you get with CBS Laboratories power twins, Audimax and Volumax. Audimax delivers a distortion free signal by eliminating thumping, background "swish-up" and audio "holes." And Volumax prevents overmodulation and permits maximum per-watt coverage power. The power twins! From CBS Laboratories, of course.

CBS LABORATORIES

A Division of CBS Inc.
227 High Ridge Road, Stamford, Connecticut 06905

Circle 32 on Reader Service Card

 SHURE[®]

INTRODUCES

SR

PROFESSIONAL
SOUND
REINFORCEMENT
EQUIPMENT



audio console

electronic
crossover

power
amplifiers

speaker
systems

custom
accessories

THE COMPONENTS
YOU SAID YOU NEEDED ...
FOR
PROFESSIONAL
PERFORMANCE
WITH PROFESSIONAL
FEATURES

SR108 EXTENDED RANGE SPEAKER SYSTEM

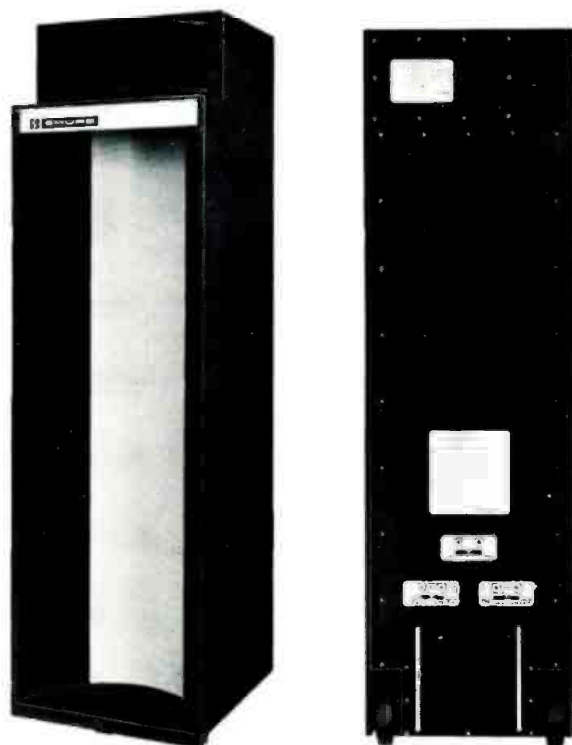

The Shure SR108 is an extended range, two-way speaker system designed for high sound-pressure-level reproduction of wide frequency range program material in sound reinforcement applications. The speaker system utilizes six eight-inch cone-type speakers with a total speaker cone area of 1097 cm² (170 in²) and four high frequency drivers. The SR108's pressure sensitivity has an EIA rating of 54 dB at 9.2 m (30 feet) from 1 milliwatt (equivalent to 102 dB at 1.2 m (4 feet) with a 1-watt input).

SR106 ELECTRONIC CROSSOVER

The Shure SR106 Electronic Crossover is a rack-mountable, unity gain, selectable-frequency dividing network, designed for use with two- or three-way speaker systems such as the Shure SR108 Extended Range Speaker System in high-quality sound systems. It utilizes the principle of bi-amplification to separate an audio console or mixer-preamplifier output into two frequency bands for distribution to separate power amplifiers. In this manner, the advantages of lower distortion, increased high-frequency power, wider dynamic range, and maximum efficiency are obtained.

The SR106 provides switch selected crossover frequencies of 500 Hz, 800 Hz and 2600 Hz. It can be used to provide two output frequency bands or, with a second SR106, three output frequency bands, with each output routed to a separate power amplifier (tri-amplification).

The SR106 is supplied with a protective power switch cover, and rack-mounting screws for mounting in standard 19 in. (483 mm) audio equipment racks or in optional carrying cases.

The SR106 measures 44.5 mm (1 3/4") high x 483 mm (19") wide x 216 mm (8 1/2") deep, and weighs 3 kg (6 lb, 8.8 oz).

INPUT CAPABILITIES

Balanced bridging input accepts balanced line level or unbalanced signals through parallel three-pin female professional audio and three-circuit 1/4-inch phone jack connectors.

The sound power distribution is nominally uniform over a 140° angle in the horizontal plane and a 90° angle in the vertical plane. The speaker system's bass reflex design provides extreme low-frequency enhancement, with low-frequency speakers column-mounted in a horn-loaded, front-ported enclosure. The four high-frequency drivers are coupled to a single radial horn.

The uniform response is peak-free from 40 Hz to 15,000 Hz when driven by a constant-voltage amplifier and radiating into an acoustical half-space.

INPUT CAPABILITIES

- Continuous 100-watt maximum power rating (40-volt source). 16-ohm nominal impedance in single-amplifier operation.
- Accepts up to 100 watts of program material in the low-frequency section and up to 30 watts in the high-frequency section during biamplified operation.
- Inputs consist of three pairs of parallel-wired phone jacks for (1) conventional full-range operation, (2) low-frequency biamplified operation, and (3) high-frequency biamplified operation.

CONTROLS

- Rear-panel Loudspeaker Operation switch provides four high-frequency level positions of -4, -2, 0 and +2 dB for conventional full-range operation and a BIAMP position for biamplified operation.

The SR108 Speaker Cabinet is ruggedly constructed of wood measuring 15.9 mm ($\frac{5}{8}$ ""). It is covered with scuff-resistant vinyl paint, has rear-panel rails and handle, two wheels and a cable storage compartment. The radial horn is made of high-density, structural urethane foam. A plug-in 15.2 m (50-foot) speaker cable is included. The SR108 measures 1730 mm high, 495 mm wide, and 517 mm deep ($68\frac{1}{8}$ " x $19\frac{1}{2}$ " x $20\frac{3}{8}$ "") and weighs 64.5 kg (142 lb), including speaker cable. Operating temperature range is from -7°C to 43°C (20°F to 110°F), with storage temperatures from -29°C to 71°C (-20°F to 160°F).

SR105 POWER AMPLIFIER



The Shure SR105 is a high-quality, high-power, rack-mountable amplifier designed for use with the SR101 Audio Console and most other associated equipment used in professional sound reinforcement systems. It is available in two models: The Model SR105A, which provides both direct- and transformer-coupled, constant-voltage 70-volt output, and the Model SR105B, which permits direct speaker coupling only. Both units measure 178 mm (7") high x 483 mm (19") wide x 270 mm (10 $\frac{5}{8}$ "") deep. The SR105A weighs 15.66 kg (34 $\frac{1}{2}$ lb); the SR105B weighs 12.23 kg (27 lb).

Each SR105 amplifier is capable of delivering 200 watts rms to a four-ohm load, and may be interconnected with additional units to provide the greater sound power required by especially large coverage requirements. Harmonic and intermodulation distortion are low, and frequency response is flat, 20-20,000 Hz, ± 1.5 dB.

Both the SR105A and SR105B are completely protected against short or open circuit loads, and can operate at ambient temperatures up to 42°C (110°F.) without derating.

INPUT CAPABILITIES

- Accepts line level or auxiliary level signals through a professional, three-pin balanced bridging input connector and dual, unbalanced, paralleled phone jacks, for compatibility with all Shure audio control components and virtually all professional consoles.

OUTPUT CAPABILITIES

- Provides four direct-coupling output jacks for connection to speaker systems, along with a two-screw terminal strip for additional direct speaker coupling.
- Model SR105A, with 70-volt output provision, delivers 150 watts rms output to 70-volt distributed speaker systems.

CONTROLS AND METER

- Both SR105 units incorporate a power On-Off switch and a volume control.
- Accurate, front-panel output voltage meter indicates output voltage as a percentage of 100% maximum voltage.
- Thermal overload indicator lamp is provided to indicate if thermal cycling has occurred due to improper ventilation or operation.

OPTIONAL ACCESSORIES

- Both the SR105A and SR105B may be used with the Model A105A Carrying Case. (See back page.)

OUTPUT CAPABILITIES

- Outputs are +18 dB m, 600-ohm, balanced, line level with greater than 110 dB signal-to-noise ratio.
- Provides parallel three-pin male professional audio and three-circuit phone jack connectors for high and low frequency line level output.

CONTROLS

- The SR106 Electronic Crossover incorporates a power On-Off switch and indicator lamp.
- A three-position Crossover Frequency switch adjusts to select crossover frequencies of 500, 800 or 2,600 Hz.

OPTIONAL ACCESSORIES

- May be used with Model A30A or, A105A Carrying Case. (See back page.)



SR102 & SR103 SPEAKER COLUMNS

The Shure Models SR102 and SR103 Speaker Columns were developed especially for use with high-power amplifiers such as the Shure Model SR105 in system installations requiring very high quality sound reproduction. Both models offer wide frequency response (100 to 15,000 Hz), very low distortion, and exceptional Penetrating Power.

- Both models are 16 ohms, and are rated at 100 watts maximum program material.
- Two 10-inch and four 8-inch heavy-duty speakers, along with twin high-frequency speakers that function as both dome radiators and acoustic horn radiators, are used in both models.
- Both models employ an enclosure with a specially tuned rear port that heightens Penetrating Power by producing a highly directional characteristic (dispersion is 140° horizontally, 65° vertically).
- Both models produce optimum auditorium penetration, with maximum feedback reduction.
- Both the SR102 and the SR103 may be used with either direct (4 to 16 ohms) or constant-voltage (25 or 70 volts) amplifier outputs without matching transformers.

MODEL SR102: The SR102 is a portable speaker column, and is intended primarily for temporary installations. It measures 1522 mm (59 1/4") high x 354 mm (13 1/4") wide x 241 mm (9 1/2") deep, and weighs 32.62 kg (72 lb). Its enclosure is fitted with anodized solid aluminum siderails for protection, and with a strong retractile handle for ease in transportation. The enclosure is covered with a tough, scratch-resistant, moisture-proof vinyl fabric. Connections are made through a six-screw terminal strip, or through twin, parallel-wired phone jacks. A 15.2m (50-foot) rubber-jacketed connecting cable with locking phone plugs is supplied.

MODEL SR103: The SR103 is intended for permanent installations, and may be used outdoors for extended periods without adverse effects. All electrical components, hardware and enclosed surfaces have been designed for maximum resistance to adverse weather conditions. Adhesives used are moisture-resistant, and all trim and fastening hardware are highly corrosion-resistant. Drain holes are provided to minimize moisture accumulation. Connections are made through a six-screw terminal strip. It measures 1513 mm (59 5/16") high x 352 mm (13 7/8") wide x 240 mm (9 7/16") deep, and weighs 31.8 kg (70 lb). Designed for use with Model A103A Wall-Mount Speaker Bracket shown below.

CUSTOM-DESIGNED SR ACCESSORIES

**Model A101B
Panel Lamp**



A small, low-intensity light unit to illuminate SR101 Audio Console controls in dimly lit areas. Attaches quickly to front panel with screw-down connector, and draws its power from the SR101. Flexible neck affords variable positioning.



**Model A101A
Carrying Case**

Designed to give complete portability to the SR101 Audio Console. Tough, weather-resistant outer covering and solidly attached carrying handle. Rear panel removes to provide a padded operator armrest. Contains space for carrying A101B Panel Lamp and operator cue sheets. The A101A measures 370 mm (14 5/16") high x 518 mm (20 3/8") wide x 256 mm (10 1/8") deep overall.

Model A30A Carrying Case

Similar to A105A above with 3/2" (89 mm) of rack-mounting. (Not shown) "for SR105"



**Model A105A
Carrying Case**

A sturdy, weather-resistant case designed for easy transportation of either SR105A or SR105B. Front-and-back hinged removable panels permit access to front and back of unit for operation. May also be used to create a portable, "custom" stack of smaller audio control components (such as the Shure M67 Mixer and M610 Feedback Controller with appropriate rack panel kits). The A105A measures 533 mm (21") high x 232 mm (9 1/4") wide x 311 mm (12 1/4") deep overall. Provides 178 mm (7") of rack-mounting space (such as the SR106 or controller with kits). Weighs 6 kg (13 1/2 lb).



**Model A102A
70-Volt Transformer**

A high-efficiency, low-loss autotransformer that mounts easily on back of a speaker enclosure to provide wattage taps of 50, 25, 12, and 6 watts in 70-volt distributed systems, and impedance taps of 8 and 16 ohms to accommodate a wide variety of speakers. Five-screw 70-volt terminal strip and three-screw impedance terminal strip.

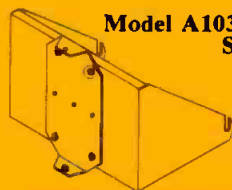

**Model A103A Wall-Mount
Speaker Bracket**

A strong wall bracket designed especially for permanently mounting the SR103 Speaker Column on almost any vertical surface. Allows the installer to aim the speaker for optimum audience coverage. Tilts as much as 19° left or right, and 18° up-tilt or 12° down-tilt, then locks in selected position.



**Model A3S-T
Speaker Tilt Stand**

A tubular steel stand that provides added stability for SR102 Portable Speaker Column, and permits an upward tilt of up to 30°.

Model A50XC

15.2 m (50-ft.) speaker Extension Cable. (Not shown)

INSTALL IT AND FORGET IT!

WE BUILD AND TEST EACH AMPLIFIER WITH THE CONVICTION THAT WE'LL NEVER SEE IT AGAIN

That's why 25% of our people work in inspection and verification. And we have this confidence in our amplifiers because our people make sure you receive a better amplifier than you ordered. You'll find the Crown line of power amplifiers unique in both specifications and operation. And that kind of confidence you can pass on to your clients.

Output Power: 30 watts per channel minimum RMS (both channels operating) into an 8 ohm load over a bandwidth of 35 Hz—15 KHz at a rated RMS sum total harmonic distortion of 0.05%.
Dimensions: 19" wide by 8¾" deep by 1¾" high.
Weight: 10 lbs.



The Crown D-60 stereo amplifier, small in size, big in value and adaptability. Its uses include headphone power supply for system monitoring; ideal power for high-efficiency speakers; can be easily used in bi-amping and tri-amping situations and can be field modified to produce 25 volt monaural output power for industrial sound distribution systems.

Output Power: 75 watts per channel minimum RMS (both channels operating) into an 8 ohm load over a bandwidth of 1 Hz—20 KHz at a rated RMS sum total harmonic distortion of 0.05%.
Dimensions: 17" wide by 8¾" deep by 5¼" high.
Weight: 24 lbs.



The D-150 medium power amplifier, is by design an ideal audio amplifier with the kind of rugged reliability needed in portable sound systems. Especially where one to one amp/speaker ratios are used. Well known Crown protection circuits are an integral part of the D-150. Protection from mismatched or shorted loads is provided, and a series limiting resistor protects against excessive input signals. Controlled slewing-rate voltage amplifiers protect against RF burnouts. And a thermal switch cuts AC line power if overheating occurs from improper ventilation.

Output Power: 155 watts per channel minimum RMS (both channels operating) into an 8 ohm load over a bandwidth of 1 Hz—20 KHz at a rated RMS sum total harmonic distortion of 0.05%.
Dimensions: 19" wide by 9¾" deep by 7" high.
Weight: 45 lbs.



The Crown DC-300A. High power is first thought of when referring to a "super" amplifier. However, this Crown amplifier is also super in its reliability; super in its capability to deliver sound without distortion, and super in its ability to power any type of load, from 2.5 to 16 ohms, resistive or reactive! And whether it powers a multi-speaker theatre system or is on line with a group of twenty or thirty DC-300A's for an outdoor rock session, this amplifier delivers 100%. And we know that in whatever application you use it, the DC-300A will give you the kind of reliability you're looking for.

Output Power: 600 watts minimum RMS into an 8 ohms load over a bandwidth of 1 Hz—20 KHz at a rated RMS sum total harmonic distortion of 0.05%.
Dimensions: 19" wide by 16½" deep by 8¾" high.
Weight: 92 lbs.



The Crown M-600 power amplifier was designed specifically for applications requiring relatively high power levels. The M-600 maintains all the exacting Crown laboratory performance standards, plus featuring built-in cooling for continuous full power operation.

The M-600 also features Crown's patented protection circuitry allowing it to drive highly reactive and low impedance loads without adverse effects. A newly patented output bridge circuit permits extremely high power levels to be sustained safely.

If by this time you do not have enough power to do the job, consider the M-2000, DC-1200 or the DC-4000. These configurations are combinations of the M-600 and are specifically designed for applications where huge amounts of power (2 kilowatts plus) are needed.

Crown amps are widely known for superior performance and reliability, and like every Crown product are covered by a comprehensive warranty which includes parts, labor and round-trip shipping for three years.

 **CROWN**
BOX 1000 • ELKHART, IN. 46514 • 219 / 294-5571

BE TMS 200 TURNTABLE PRE-AMPS



Versatility is the perfect description for our new BE TMS turntable pre-amps. For example, phase reversal on one channel gives five modes of stereo/mono operation including independent dual channel mono and mono playback of stereo recordings. Transformer output.

Spotmaster[®]

ALSO
CONSOLES
AND CARTRIDGE
MACHINES



BROADCAST ELECTRONICS
8810 Brookville Road
Silver Spring, Maryland 20910
Phone: 301-588-4983

Circle 36 on Reader Service Card

new products & services (cont.)

LINE-LEVEL MICROPHONE

MINIATURE SOUND LEVEL METER

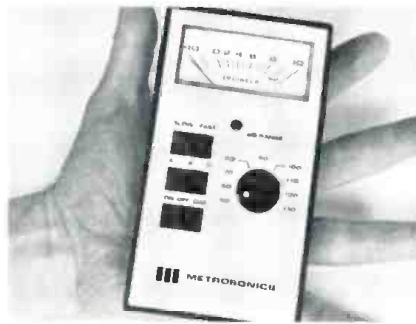

● Small enough to fit into a pocket, model db-201 is offered with an accessory clipboard providing one-hand operation. The unit's miniature microphone is mounted on a telescoping boom, which can be placed close to the sound source. db-201 covers a full 90 dB dynamic range and includes weighting networks for A, B, and C frequency response and fast or slow meter damping. The unit operates on low power solid state integrated circuits, on one battery. An accessory earphone is available.

Mfr: Metrosonics, Inc.

Circle 54 on Reader Service Card



● Designed primarily for sports broadcasts and news remotes, SM82 line-level unidirectional microphone contains its own line-level amplifier, peak limiter, and 9.8V battery. Its balanced line-level output can drive telephone lines or other line-level inputs. Up to a mile of unshielded cable can be used between the mic and the broadcast equipment without equalization. Frequency response is 40-15,000 Hz. Supplied with the unit are a windscreen and a locking swivel adapter.

Mfr: Shure Bros.

Price: \$165.00.

Circle 55 on Reader Service Card

DYNAMIC EXPANDER



● Up to +20dB expansion is possible with the Dynamic Volume Expander, which increases the signal-to-noise ratio of music reproduction by the dB value of expansion. Its circuitry senses when compression has taken place and adjusts the gain accordingly to decompress the recording used in tape, f.m. broadcasts, and disc reproduction. High slewing rate devices and wide dynamic range integrated operational amplifiers are utilized within a closed loop feedback system which is non-linear to allow automatic variability of attack and decay time constants which reflect the input musical wave form. It also takes into account the characteristics of the human ear in reception. Leds indicate expansion in 2dB intervals; the expansion attack rate is approximately 100 milliseconds; expansion decay rate is approximately 30 sec. from +15dB down to +1dB.

Mfr: IAD

Price: \$265.00

Circle 56 on Reader Service Card

Clear-Com intercom systems

Product mix...and match.

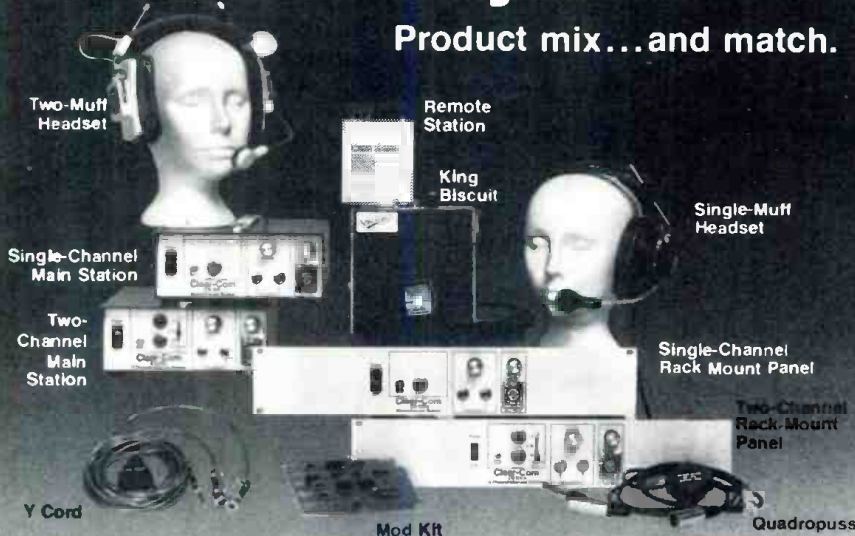

You can custom design the exact intercom system you need. Whatever your application. Our full line of intercom products are interchangeable and compatible. And our engineers will be happy to help. Call us. Our product mix makes a good match.

Dealers nationwide, Canada and England.

Clear-Com Division of Lumiere Productions, Inc.
759 Harrison St., San Francisco, CA 94107 (415) 989-1130

Circle 37 on Reader Service Card

“Whose equipment did I look at when I was spec'ing recorder/reproducers?

Everyone's.

Whose equipment did I buy?

Electro Sound's ES-505.”

As chief engineer for one of the nation's oldest and most respected stations, Dave Finley's primary concern is quality — both in equipment and over-the-air product.

Here's what Dave told us about the ES-505:

“My business is to compare equipment. When we had an opportunity to use an ES-505 against two XXXXXX's* in our production room, I was

very, very impressed — not only with the machine's quality of reproduction, but with its ease of operation and unique features.

“Our particular application for the four-track ES-505 is in radio production, where recording with a great deal of creativity in mixing is needed. If there's a lot of editing involved, the third reel offered on the ES-505 is an especially nice concept.

“The emitter follower on the playback head to minimize noise and hum vulnerability is an unusually clever idea. In fact, it's one that's been long overdue in the industry.

“Some exceptional human engineering went into the ES-505. It's not only well built and simple to maintain, but it's completely operator-oriented. For instance, the disappearing head gate which makes for easy editing and head cleaning; and the built-in test oscillator which speeds and simplifies calibration.

“A definite plus is Electro Sound's replaceable capstan idler, which allows you to instantly change the tire and not the entire assembly. We used to spend \$35 for replacement assemblies on our previous machines. Now we only pay \$8.50 for a spare tire.

“All in all, the ES-505 is a highly professional recorder/reproducer with a very competitive price tag that makes it a most important addition to our production facility.”

That's what the man said. He looked. He compared. He bought. We rest our case.

But don't rest yours. Call or write us today for complete details on the ES-505 and Electro Sound's other professional broadcast products.

*competitive brand name on request.

Dave Finley

Chief Engineer, KSL-AM/FM,
Salt Lake City

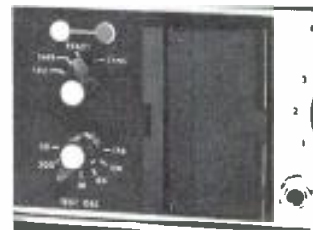

ELECTRO SOUND®

725 Kifer Road
Sunnyvale, CA 94086
Phone (408) 245-6600
Telex 34-6324 LECTROSND SUVL

Circle 46 on Reader Service Card

SESCOM'S NEW CABLE TESTER

Tests For: Continuity • Opens • Shorts • Phasing — Professional Net \$21.50/Send for Spec Sheet



Quality Engineered Sound Products
SESCOM, INC.
P. O. Box 590, Gardena, CA 90247 U.S.A.
(213) 770-3510 • TWX-910-3286189

Circle 14 on Reader Service Card

Plastic Reels Shipped from Inventory
Mfrs. of Amerline reels
Polyline Corp.
312/298-5300
1241-Rand Rd. Des Plaines, Ill. 60016

Circle 15 on Reader Service Card

FREE CATALOG
HARD-TO-FIND PRECISION TOOLS
Lists more than 2000 items—pliers, tweezers, wire strippers, vacuum systems, relay tools, optical equipment, tool kits and cases. Also includes ten pages of useful "Tool Tips" to aid in tool selection.

JENSEN TOOLS
4117 N. 44th Street, Phoenix, Ariz. 85018

Circle 16 on Reader Service Card

new products & services (cont.)

CARD EDGE ADAPTER

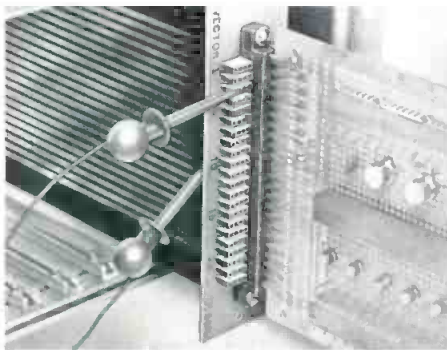

● Front-panel troubleshooting of gage-mounted circuit boards is made more convenient with models TP-1 and TP-2 adapters. Designed for boards with 22/44 edge contacts on 0.156 inch centers, the adapters provide four external test clips for each receptacle contact. Signals may be inserted, jumpers installed, components added, and measurements taken without probing the board. For testing, a circuit board is removed from the cage, the extender and adapter installed, and the board is inserted in the adapter. Probes can then be connected to any of the input/output connections. Model TP-1 is designed for bench use and holds the board vertically. Each of the four clip test points accepts 0.010-

0.032 inch wire. Clip-on test probes, 0.040 to 0.080 inches, may be hooked into the ends. Numbers and letters corresponding to connector position indicate the test point.

Mfr: Vector Electronic Co.

Price: TP-1 card edge adapter: \$17.59

TP-2 for cage testing: \$22.05

8" extender card: \$10.66.

Circle 57 on Reader Service Card

SEVEN-INCH METAL REEL

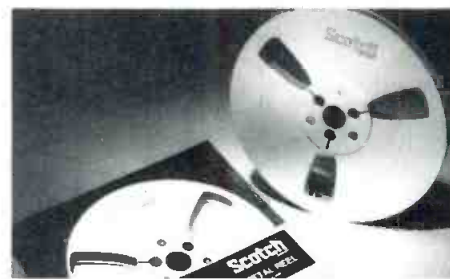

● Security and safety for audio tape is offered by these 7-inch metal reels designed with heavy duty aluminum flanges. The flanges are tightly secured to the hub for protection and to assure even tape alignment. The reel has three threading slots. The tape is designated Scotch RB-1/4-7M.

Mfr: 3M

Price: \$9.35

Circle 58 on Reader Service Card

Complete Audio Distortion and Frequency Response ... Automatically



RADIOMETER COPENHAGEN

Comprehensive distortion and frequency response measurements are easily performed with the BKF10 Automatic Distortion Analyzer. This unique instrument combines a distortion meter, a low distortion audio sweep oscillator (<0.01% t.h.d.) and an input/output ratio meter. Operation is totally automatic... No balancing, nulling or level setting is required. Addition of a recorder provides complete distortion and frequency response curves. Send for complete information.



THE LONDON COMPANY / 811 SHARON DRIVE / CLEVELAND, OHIO 44145 / (216) 871-8900

Circle 45 on Reader Service Card

PORTABLE STEREO MIXING SYSTEM

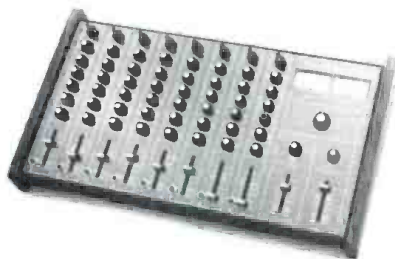

● Based on an 8-input mainframe and expandable at any time without recalibration, this mixer features fold-back and echo send channels, echo return, illuminated vu meters, and a separate monitoring system with cue buttons, capable of driving headphones or stereo power amplifier. Each input channel includes XLR type input, 5-position input attenuator; pre-eq. foldback level, 3 frequency eq., echo send level, pan pot, sealed straight line fader, and monitor cue button. Plug-in type integrated circuits are used for all amplification functions.

Mfr: *Richmond Sound Design, Ltd.*
Price: \$1,600

Circle 59 on Reader Service Card



● Repeatability is notable on model 3100 graphic/shelf equalizer. Model 3100 has three independent overlapping frequency ranges: 50 Hz-500 Hz, 300 Hz-3 kHz, and 1.5 kHz-15 kHz, with eleven detented center frequencies per range. Other features include selectable bell-shaped or shelf response curves on high and low frequency ranges, -15 dB to +15 dB cut and boost with eleven detented positions, silent equalization in/out switch with led indicator, high output capability of up to +27 dBm into 600Ω. TYP THD 0.05 percent, and low noise of -90 dBm unweighted, 20Hz to 20kHz. The modular unit measures 1½ x 5¼ x 5¾ inches.

Mfr: *Modular Audio Products*
Circle 60 on Reader Service Card

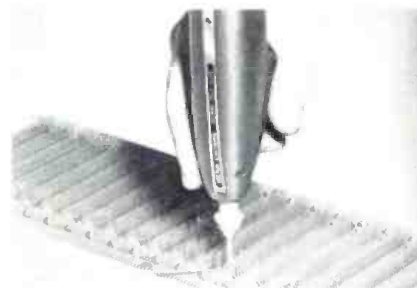

● Shaped in a straight configuration for convenient wiring of both horizontal and vertical boards, nine-ounce P160-4 wrapped wire power tool operates with a side-mounted trigger. A touch of the index finger provides six to eight gas-tight wraps. The tool, which comes with extension and installed P-160-2 hardened steel wrapping bit, includes battery line cord and recharging unit. The tool wraps 0.025 inch to 0.028 inch square posts with 26 to 30 ga. wire. The 0.070 inch bit radius allows wrapping of posts spaced on 0.10 inch centers. Continuous bussing is possible because wire can be loaded from either end of the tool. The tool operates on a nicad battery.

Mfr: *Vector Electronic Co. Inc.*
Price: \$59.69

Circle 61 on Reader Service Card

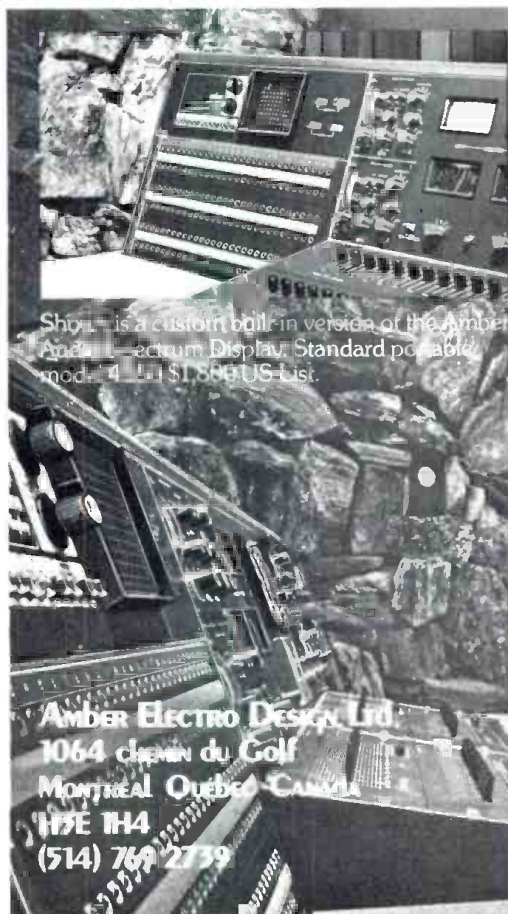

Why does Capitol Records use an Amber Audio Spectrum Display?

Capitol Records, Hollywood, built an Amber 4550 Audio Spectrum Display into their impressive new Disc Mastering facility. Mike Edson, Recording Supervisor, explains why:

"We wanted this room to be one of the best equipped anywhere and when we ordered our custom mastering console we specified that an Amber Spectrum Display be built in.

"The Amber 4550 has proven to be a very useful instrument in the mastering room. We have found that observation of the spectral energy distribution of the program material shows, beforehand, problem areas which may cause groove overcutting, undercutting, and mistracking problems on the master. It is also of great help in selecting the equalization necessary in order to transfer to disc the instrumental and vocal balance that the artist and producer have worked so hard to create.

"Our new facility will be available to our custom clients as well and we want to be sure to give them the highest quality product we can produce. We feel the Amber display will help us achieve that result."

Disc Mastering, tape duplication or recording studio — the Amber Spectrum Display has a place. Contact Amber for the name of a dealer near you and arrange for a demonstration — you'll see what we mean.

Sho... is a custom built-in version of the Amber Amber Spectrum Display. Standard portable mod... 4... \$1,885 US List.

Amber Electro Design Ltd.
1064 chemin du Golf
Montreal, Quebec, Canada
H3E 1H4
(514) 769-2739

Circle 34 on Reader Service Card

How Speech Can Be Compressed and Expanded

Methods of speeding or slowing speech reproduction without distorting nuances or intelligibility are growing in sophistication. The applications are fascinating.

IN OUR speech-oriented technology, the recorded voice is becoming increasingly significant in the transfer of information. But owing to the physiological limitations of the organs of speech, we lack the ability to produce speech as rapidly as the ear-brain perceptual mechanism can process it. Normally, average speaking rates range from about 110 to 175 words per minute, whereas the capacity of the human auditory system to absorb speech in real time is more than twice that rate. It follows, therefore, that in order to cope with the proliferation of audio data, we should take advantage of our higher listening-rate capability by utilizing some form of rate-controlled speech processing.

The simplest approach is to reproduce tape-recorded speech at a faster rate than it was originally recorded. This may be feasible for small speed-up ratios, but larger variations (on the order of 50 percent) would result in serious deterioration of quality and intelligibility. What happens, of course, is that the speech spectrum is proportionately scaled-up in time, thus distorting the normal voice pitch. One solution to the problem lies in compressing the recorded speech signals as a function of time during playback, so as to accelerate the speaking rate without altering the pitch or tonal quality of the voice. Conversely, the speech rate could be slowed down by expanding the recorded signals in a pitch-invariant manner.

In past years, variable speech-control devices employing electromechanical techniques have been commercially available as an auxiliary unit for reel-to-reel tape machines. Recently, however, with the advances in sophisticated electronics and complex solid-state circuitry, rate-variable equipment has been produced as a built-in facil-

ity in cassette machines for the time compression and expansion of recorded speech. With these devices, the listener is allowed to control the playback rate of audio presentation, and hence, select his optimum listening speed without sacrificing intelligibility and comprehension.

POTENTIAL APPLICATIONS

Although rate-controlled speech has already proven its usefulness in some fields, modern methods have opened up a wide range of potential applications. For example, listening to time-compressed speech can provide an efficient learning medium for individuals with special educational problems, such as the visually handicapped. With high-speed listening, recorded conference proceedings can be reviewed rapidly, since more subject matter is reproduced in a given time.

In transcribing recorded speech directly to the typewriter, the word rate can be adjusted according to the individual's typing ability. Also, program material for radio broadcast transmission can be played back within the desired time limit, without the need for editing the recorded text.

During expansion, recorded speech can be slowed down to a convenient word rate for teaching retarded children, and in speech therapy in general. Low-speed listening can also be helpful in learning a foreign language, where the listener is able to set his own listening pace, making it easier to imitate the articulatory gestures of speech production. Similarly, in linguistic studies, a low word rate enables the listener to make more precise phonetic transcriptions.

In order to gain better insight into the technical aspects of compressed and expanded speech in time, one must appreciate the dynamic and phonetic characteristics of vocal sounds. Therefore, before considering the methodology of rate-altered speech, it would be useful to explore briefly some of the fundamental features of the speech process in acoustical terms.

Sidney L. Silver is on the supervisory staff of the Telecommunications Section of the United Nations, where he is in charge of sound and recording.

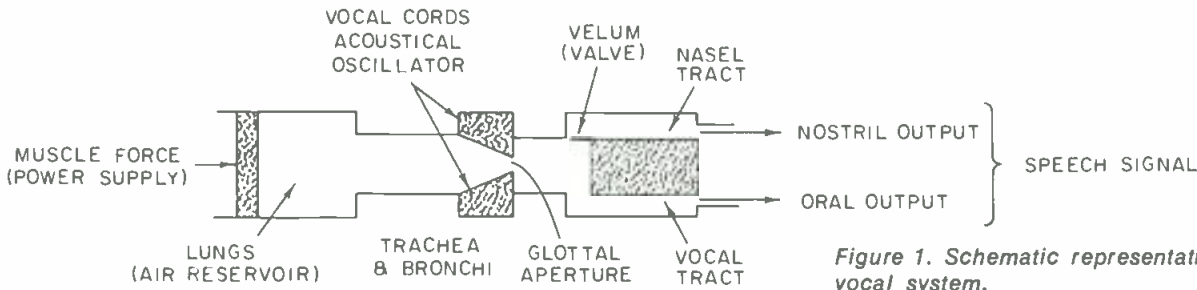

Figure 1. Schematic representation of the human vocal system.

MECHANISM OF SPEECH PRODUCTION

At the acoustical level, speech signals consist of rapid fluctuations in air pressure, wherein sound energy is generated and radiated by the vocal system. A schematic representation of the voice-producing mechanism is shown in FIGURE 1. For voiced speech, a column of air is expelled from the lungs, passes through the glottal aperture, and drives the vocal cords into forced oscillation. The vocal cords, acting like an acousto-mechanical relaxation oscillator, chop up, or modulate the air stream into near-periodic sawtooth pulses. These time-pressure patterns, in turn, excite the vocal tract where the position of the articulators (tongue, lips palate, etc.) establish certain resonant conditions.

The resonances concentrate the acoustical energy into specific regions of the frequency spectrum, known as formants, which shape the spectral characteristics of the output signal, giving rise to the quality, or timbre, of each speech sound. The sound energy is finally radiated through the vocal tract, nasal tract, or both; it is the relatively slow variations in pitch, intensity, and harmonic resonance that constitute the information-bearing elements of speech production.

In English speech, the vowel sounds, as well as certain consonant sounds, are normally produced by vocal cord excitation. Examples of voiced consonants are the initial and final sounds in the word "dog." In some cases, the vocal tract is coupled to the nasal tract by the valve-like action of the velum, so that the nasal tract provides the main sound transmission channel. Nasal consonants are illustrated by the initial and final sounds in the word "man."

Unvoiced sounds, on the other hand, are not produced by the vibration of the vocal cords; instead they are generated by air turbulence through a narrow constriction formed by the articulators at some point in the vocal tract. Sounds formed in this way are inherently random noise components characterized by breathy or hissy quality, e.g., the initial and final consonants in the word "fuss."

Another source of unvoiced excitation is created by momentary air pressure buildup at a closure point in the vocal tract, followed by an abrupt release of excess pressure by the articulators. Examples of these sharp transient sounds are the initial and final consonants in the word "pit." In general, all of these vocal sources, whether near-periodic voiced sounds, or aperiodic unvoiced sounds, have a fairly broad spectrum of frequencies, the principal components extending over the voice-frequency range from about 100 Hz to more than 3000 Hz.

SAMPLE-AND-DISCARD METHODS

Human speech may be regarded as the process of transforming a message from a sequence of basic sound units—the *phonemes*—into a continuous acoustical signal that conveys information to the listener. Phonemes are considered to be the minimum recognizable speech components that can be distinguished from any other speech sounds produced. Natural connected speech, however, does not merely consist of isolated sound elements or discrete events. The acoustical attributes of each sound unit constantly change the flowing speech pattern due to the

merging influence, or interaction, between adjacent phonemes. In this process, phonemes are produced at the rate of about 10 to 20 per second, the duration of a single sound element ranging up to about 100 msec.

Fortunately, the time interval of the average phoneme in continuous speech exceeds the minimum duration necessary for intelligible perception by the listener. The temporal redundancy of vocal communication, in effect, is sufficiently high to permit direct manipulation of the time-scale of a complex waveform. This is an important factor when considering the sample-and-discard method of speech processing.

In an experimental demonstration of speech compression, Garvey^{1,2} edited recorded voice tapes in such a way as to produce speech sounds with a high word rate. Using a manual sampling technique, he carefully cut the tape into periodic sections (independently of the speech content), discarded tiny interspersed segments, and spliced the remnants together. He found that the shortened composite tape, when reproduced at normal speed, retained most of the original voice quality.

Subjective tests were then carried out to determine the effects of increased compression rates on intelligibility. The results are illustrated by the curve plotted in FIGURE 2. Here the compression rate, expressed in percentage, is defined as the ratio of the playback speed to the normal recording speed, e.g., a compression rate of 100 percent corresponding to normal reproducing speed. Speech compression at 200 percent indicates that reproduction is twice as fast, so that playback time is 50 percent of recording time. Clearly, the curve shows that intelligibility is

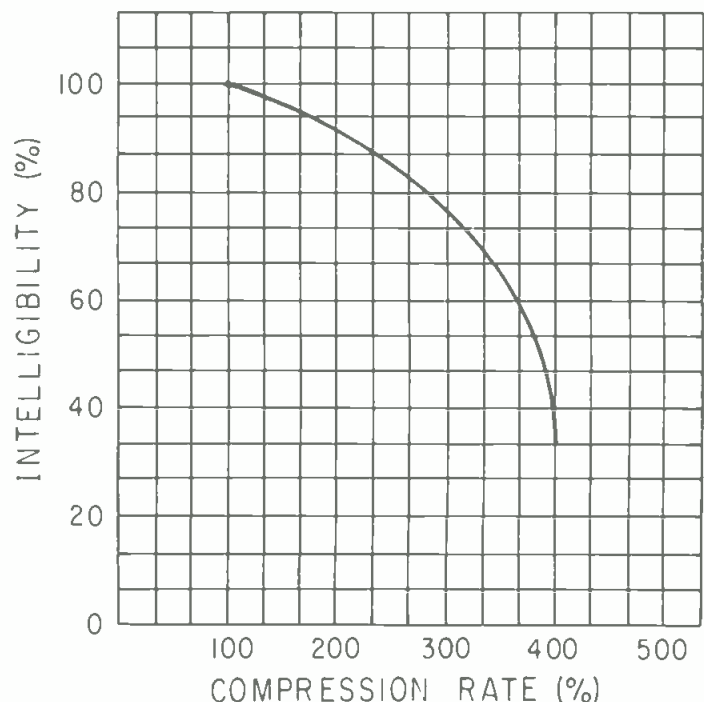

Figure 2. Speech intelligibility vs. compression rate curve (after Garvey).

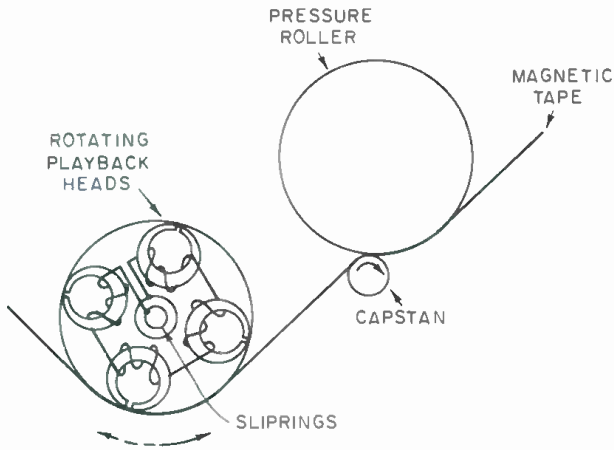

Figure 3. Schematic view of the rotary head assembly (after Springer).

remarkably good at compression rates up to 200 percent, after which it declines sharply to 400 percent, where it becomes extremely poor.

It should be pointed out that a distinction must be drawn between the intelligibility of single words and the comprehension of complex information. A word is considered intelligible if the listener can recognize it and repeat it, but comprehension signifies the retention of ideas in which specific facts can be subsequently recalled. Generally, as the word rate of compressed speech is accelerated, comprehension declines more rapidly than intelligibility. Another point of consideration is that the degree to which speech sounds can be speeded up without loss of listening comprehension is highly dependent upon the difficulty of the recorded passages and the familiarity of the listener with the subject matter.

ELECTROMECHANICAL TECHNIQUES

Obviously, the manual sample-and-discard method is time-consuming and impractical, and it would be necessary to implement the control of speech rate by automatic means. It is possible to perform time compression by the elimination of those pauses between words that exceed a preset time interval. Pause suppression, can be accomplished by means of a fast-acting stop-start clutch, which automatically stops the tape player during the pause interval and restarts it in the presence of speech signals.

Unfortunately, such a system ignores the fact that speech is not merely a chain of words randomly linked together, but is structured by grammatical rules to transmit complex data to the hearing mechanism. In this process, the pauses (as well as the stress levels, intonation patterns, and inflections) introduced by the talker are used by the listener to decode these complex ideas. Accordingly, the natural pause-to-speech sound relationship at the juncture of phrases and sentences, and even the intermittent hesitation pauses between words, should be maintained for maximum listening comprehension.

In order to preserve the relative rhythm of the original recorded speech sounds during speech processing, time-controlled speech may be achieved by automatically sampling the signals in periodic segments. About thirty years ago, Gabor³ proposed an electromechanical scheme for compressing speech by implanting a magnetic head assembly in a rotating wheel and scanning a magnetic tape.

In the 1950's, Fairbanks et al.⁴ developed apparatus employing multiple pickup heads set in a revolving drum operating in conjunction with a magnetic tape loop. The differential tape-to-drum speeds could be varied independently to attain any degree of compression or expansion. Subsequently, the Acoustical Time Regulator designed by

Springer,⁵ utilized a rotary head assembly capable of direct reproduction because of synchronization between tape speed and head rotational speed. Further development of this device produced the Information Rate Changes, which combined the functions of pitch and tempo regulation.

HOW ROTARY-HEAD PROCESSOR WORKS

Referring to FIGURE 3, the rotary-head processor incorporates four separate playback heads mounted in quadrature, with the tape wrapped around the head assembly for one-quarter of the perimeter. Signal outputs from all heads are connected in series and passed through a slipping arrangement, then fed to a preamplifier in a conventional way. In the tempo-change function, the rotational speed of the playback heads is linked in such a way with the rotational speed of the capstan, i.e., the linear speed of the tape, that a constant pitch is maintained over a wide range of speeds.

In the compression mode, the playback time is shortened by skipping individual segments of the taped speech. Here the head assembly rotates in the same direction as tape travel, with the tape-to-head gap velocity equal to the speed at which the tape was recorded. The absolute tape velocity (with respect to the tape deck) determines the time duration of the compressed speech. During this operation, one head gap leaves the tape-contact area while an arriving head establishes contact. However, at the instant of transition, a definite interval will recur when the tape-segment signal between the head gaps will be effectively omitted, thus contributing nothing to the reproduced output.

In the expansion mode, the playback time is lengthened by repeating individual segments of the recorded tape. Here the head assembly rotates in a direction opposite to tape action, while maintaining a constant relative tape velocity equal to the recorded speed. In this case, two head gaps establish tape contact almost simultaneously; one head gap picks up an individual tape segment as the next head gap reproduces the same segment. In order to prevent the occurrence of detectable distortion, the repetitive interval during expansion (or the discard interval during compression) must be shorter than the average basic sound unit. For this reason, the segmented lengths are fixed precisely in time, say 30 msec, which is considered below the perception threshold of audible disturbances.

In the pitch-change function, it is possible to raise or lower the pitch simultaneously with, or independently of, the tempo. Under these conditions, rotating the head assembly in the direction of tape motion and decreasing the relative tape-to-head gap velocity will result in a lowering of the pitch. Rotating the heads in a reverse direction will have the opposite effect. The pitch-change function may have potential value as an aid for individuals with certain types of hearing impairment. For example, by shifting the voice spectrum down by some factor, say one octave, in real time, speech sounds can be transposed within the range of hearing of partially deaf persons.

ELECTRONIC TECHNIQUES

In contrast to electromechanical systems, speech compression can be performed electronically without discarding discrete portions of the input signal. An example of this approach is the Harmonic Compressor⁶ which uses spectral analysis and synthesis to produce a pitch-normalized output. Initially, the speech signal is applied to a bank of 36 bandpass filters (covering the range from 200 to 7,400 Hz) which separate the signal components into 200-Hz bands. The filtered output of each channel, in turn, is fed to its corresponding frequency divider, thus halving the frequencies of the narrow-band signals. The output from all channels is finally combined in a summing

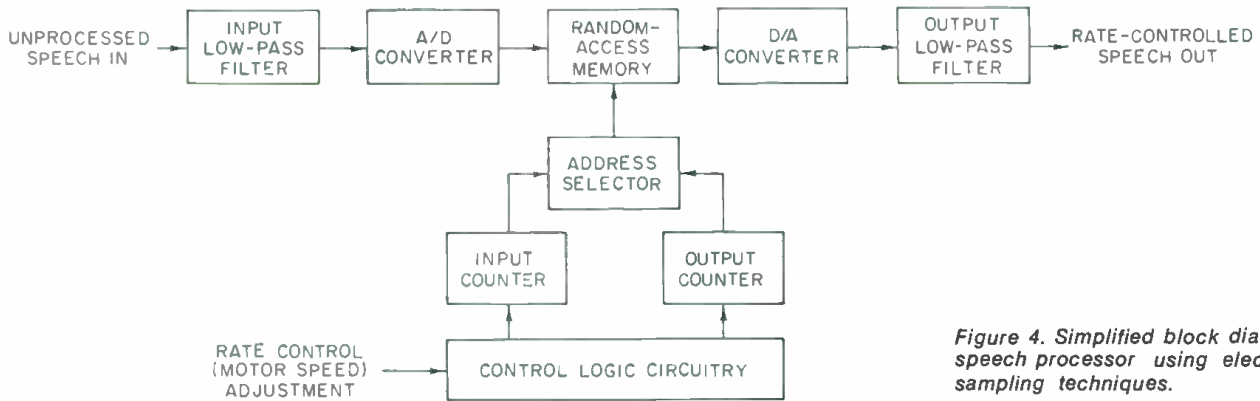

Figure 4. Simplified block diagram of speech processor using electronic sampling techniques.

network, and filtered to remove the distortion components.

To restore the half-frequency signals to their normal values, the synthesized speech is recorded on tape and then reproduced at double speed. The word rate is now twice the normal rate, with the voice pitch normalized with the original speech signal. Although the Harmonic Compressor is restricted to a compression factor of 2, the principle, of course, is applicable to other speed-up ratios. Speech expansion may be accomplished by frequency multiplication instead of division.

At the present state of the art, time compression/ expansion of speech is being implemented with digital processing using electronic sampling techniques.⁷ The sampling theorem states that if the sampling rate is a minimum of twice the highest frequency components of a continuous signal, the sampled version of that signal can be converted back to its original form. Accordingly, the speech signals to be processed are low-pass filtered at the input to ensure that there is no acoustic energy above the maximum frequency of interest, then applied to an analog-to-digital converter at the appropriate sampling rate. If, for example, the desired upper frequency limit of the filtered signal is 7 kHz, and the speech to be compressed is speeded-up by a factor of 2.5, then the sampling rate is required to be a maximum of 35 kHz.

HOW SPEECH PROCESSORS WORK

In the electronic speech processor shown in FIGURE 4, the input counter stores the sampled signals in successive locations of the random-access memory (RAM), with the final location followed by the initial one. The stored samples are retrieved by the output counter (at a fixed rate) from consecutive locations of the memory. Finally, the data are converted back to analog form, then low-pass fil-

tered at the output to reconstruct a rate-altered version of the original speech signal.

In effect, the RAM provides a means for sequential storage of and presentation of signal samples, and since the frequencies of the original signal have been restored with respect to memory space, they are reproduced at their normalized values. The relationship between the variable read-in rate and the constant read-out rate determines the compression and expansion ratios of the pitch-corrected output. Thus, if the read-out rate from the memory is made variable, the speech processor can function as a pitch-changer.

The accompanying photo shows a commercially available cassette machine which incorporates a digital signal processor, the basic assembly of which is made up of printed circuit cards. In the playback mode, the listening speed can be varied continuously (with a single control) from 0.5 to 2.5 the normal recording speed, without altering the pitch characteristics of the signal. Tape speed automatically reverts to normal when the machine operates in the record mode. The transport mechanism employs servo-regulated speed control with tachometer feedback to establish a linear relationship between read-in rate and capstan motor speed. Also, an input facility is provided to compress or expand audio signals from an external variable-speed source.

Another electronic sampling approach to speech processing makes use of analog shift registers, commonly known as bucket-brigade devices. These units, however, are still undergoing development, the main objective being to integrate the basic system on a low-power chip. ■

REFERENCES

1. Garvey, W. D. "The Intelligibility of Abbreviated Speech Patterns." *Quarterly Journal of Speech*, vol. 39 (1953), pp. 296-306.
2. Garvey, W. D., "The Intelligibility of Speeded Speech." *Journal of Experimental Psychology*, vol. 45 (1953), pp. 102-108.
3. Gabor, D. "Theory of Communications." *Journal of the Institution of Electrical Engineers*, vol. 93, part 3, Nov. 1946, pp. 429-457.
4. Fairbanks, G., Everitt, W. L., and Jaeger, R. P. "Method for Time or Frequency Compression-Expansion of Speech." *Transactions of the Institute of Radio Engineers*, vol. AU-2, Jan.-Feb. 1954, pp. 7-15.
5. Springer, A. M. "Acoustical Time Regulator." *Journal of the Acoustical Society of America*, vol. 29, Mar. 1957, pp. 341-343.
6. Bruel, J. W. and Levens, L. M. "The Harmonic Compressor, a System for Doubling Information Rates of Speech." Presented at the 37th Convention of the Audio Engineering Society, Oct. 1969. Preprint #658.
7. Lee, F. F. "Time Compression and Expansion of Speech by the Sampling Method." *Journal of the Audio Engineering Society*, vol. 20, Nov. 1972, pp. 738-742.



Speech time compressor/expander using standard cassette. (Courtesy Gotham Audio Corp.)

Ways to Evaluate Monitoring Loudspeakers

Make sure that your monitor is not deceiving you. Here are some simple tests that will help ensure realistic sound reproduction.

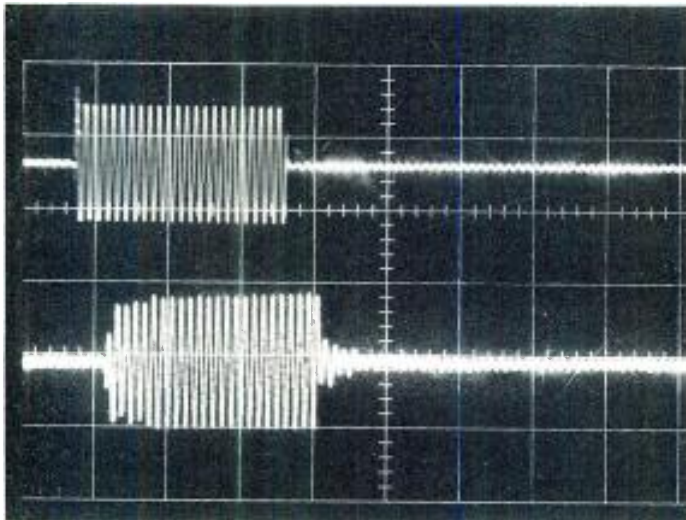

Typical toneburst response of a medium quality domestic loudspeaker system. Upper trace: amplifier input; lower trace: loudspeaker output.

THE LOUDSPEAKER is usually the weakest link in an audio system. Possibilities are greater for large reproduction errors in its application when compared with other audio system components. Therefore, its accurate evaluation takes considerably more effort than that of most other audio equipment.

MONITORING LOUDSPEAKER REQUIREMENTS

A flat frequency response is essential to ensure that people making quality judgments, assessing microphone placement or listening for noise and distortion, are not deceived by a monitor which alters the effect of different parts of the spectrum. Recent work by the BBC¹ indicates that a slight overall downward slope in the response (3 dB over the audio range) provides more realistic reproduction in typical listening environments. Our experience is that loudspeakers adjusted for flat anechoic response tend to produce complaints of insufficient bass from program production people, thus confirming the BBC findings.

The second requirement for a broadcast monitor is good dispersion at all frequencies. In practice, a major fault of many loudspeakers is inadequate high-frequency dispersion. That is essential even in cases where the listener always sits on the loudspeaker axis. In a listening room, the frequency response actually heard is not simply the axial response, but a weighted combination of the axial and off-axis responses. Therefore, a speaker with a flat axial response but inadequate high-frequency dispersion will sound weak in highs in typical listening rooms.

A third requirement is that the monitor loudspeaker have adequate transient response. Loudspeakers with similar response and dispersion characteristics may still

C. R. Heft is in the Development Department of CBC, Montreal. This article has been adapted from CBC ENGINEERING REVIEW.

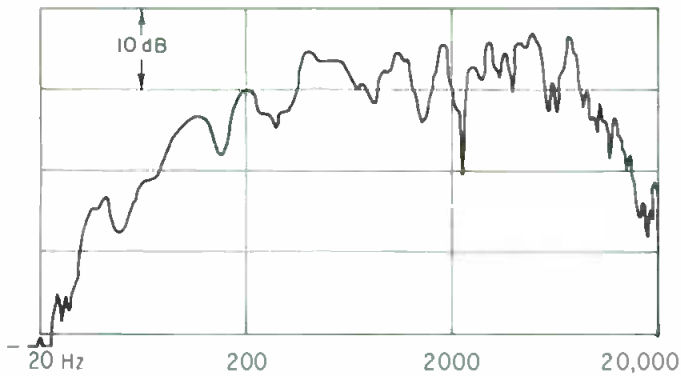

Axial frequency response of a well-known studio monitor system.

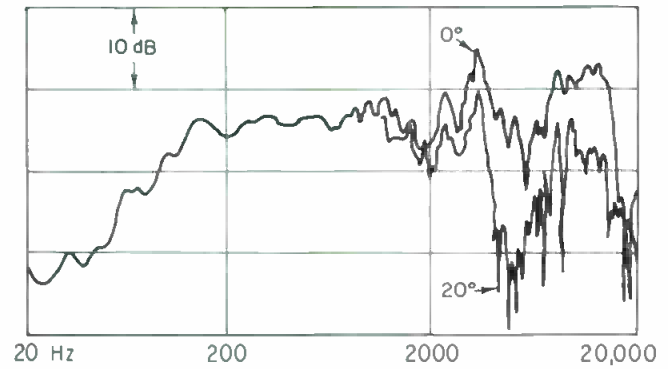

Axial and off-axis (20 degrees) response of an inexpensive (\$15) domestic speaker in a 0.3 cu. ft. cabinet.

sound very different because of transient response differences.

A monitor loudspeaker must be capable of operating at all monitoring levels continuously without failure of any component. Loudspeakers with otherwise satisfactory performance may have to be rejected because of insufficient maximum sound output capability. Finally, and possibly most importantly, the monitoring loudspeaker must satisfy the program personnel who will be working with it daily. Any colorations it may have should not produce listener fatigue over a long period.

REALISTIC PERFORMANCE TARGETS

A uniform frequency response of the entire audible spectrum of 20 to 20,000 Hz is impractical in a production loudspeaker. Although a 12 kHz bandwidth is adequate for reproducing program material accurately, a 15-kHz bandwidth is desirable for detecting tape hiss. At the low frequency end, response down to 60 kHz bandwidth is essential so that hum will be detected. If the response falls off rapidly below 60 Hz, experience has shown that coloration is introduced by the rolloff. Therefore, uniform response should extend down to 50 Hz.

Better quality loudspeakers are capable of level response within ± 4 dB, from 50 to 15,000 Hz. That appears to be about the best that can be achieved in a production unit at the present state of the art.

In an ideal case, the frequency response away from the loudspeaker axis should resemble the axial response over a wide angle, say ± 30 degrees. Such an angle represents the average dispersion of many orchestral instruments. In practice, the best units will have uniform response, within ± 3 dB, up to 10 kHz over an angle of ± 30 degrees from the loudspeaker axis.

So far as transient response is concerned, a realistic performance target is less than 5 msec. of "hangover" on tonebursts of any frequency between 50 and 15,000 Hz.

From a survey of monitoring levels in several control rooms, the median monitoring in CBC, Montreal, was found to be 87 dB, with occasional program peaks to over 100 dB. Most high-quality monitoring loudspeakers are able to deliver continuously without failure.

MEASUREMENT TECHNIQUES

To determine how well the requirements of frequency,

TONE ARMS
TURNTABLES
PREAMPLIFIERS
STUDIO FURNITURE
TAPE CART RACKS
ANTENNA HEATER
CONTROLS

"MICRO-TRAK 303"
THE INTERNATIONALLY ACCEPTED
PROFESSIONAL STANDARD



MICRO-TRAK CORPORATION

620 RACE STREET, HOLYOKE, MASSACHUSETTS 01040 413 536-3551

dispersion, and transient response are met, it is necessary to perform measurements in an anechoic room. With measurements made in listening rooms, it is difficult to determine which effects are caused by the loudspeaker and which are the result of room characteristics.

The equipment needed to measure frequency response and dispersion are a swept pure-tone oscillator, a logarithmic pen recorder, and a specialized measurement microphone. Other methods (for example, the use of warble tones or third-octave noise bands) tend to obscure the details of the response.

Although measurements of harmonic and intermodulation distortion are frequently recommended in evaluating loudspeakers, we have found them to be of very little value. Measurements of harmonic distortion are of little significance because most modern high-quality loudspeakers give a very low figure, typically under 1 percent under normal operating conditions.

Intermodulation distortion measurements are mainly of comparative value only; no reliable criteria exist to relate them to perceived quality. Even a simple comparison of different loudspeakers with respect to intermodulation distortion is complicated by the irregularity of the frequency response, for which a time-consuming correction must be calculated. In addition, mechanical resonances which produce peaks in the intermodulation distortion will also appear with toneburst tests.

TONEBURST RESPONSE MEASUREMENTS

Toneburst response measurements correlate well with the results of listening tests, particularly at high frequencies. To measure toneburst response, a sinusoidal burst of approximately 20-msec. length is applied to the loud-

speaker, and the output is recorded using a small condenser microphone. The decay portion of the burst contains most of the useful information. A slowly decaying tail represents a severe coloration in the output, even though the frequency response curve may be smooth around the frequency in question.

Most monitoring loudspeakers exhibit fairly clean burst response below 1 kHz, but poor responses are usually observed at higher frequencies. In our measurement techniques, the burst frequency is varied slowly while observing the scope display. Excessive hangover at any frequency is noted, and the overall performance is observed. (Recording the mean output during the silent periods of the burst, as a continuous function of frequency, results in better presentation of the data, but requires considerably more apparatus.)

Irregularities in the toneburst response are usually very sharply tuned. For example, a clean response might be seen at 3000 Hz, whereas a large amount of hangover might appear at 3010 Hz. For this reason, a photograph of toneburst response at a single isolated frequency is meaningless without additional data, since it is always possible to find some frequency with a clean burst response. For the same reason, when presenting toneburst photographs it should be indicated which are typical and which represent the worst cases.

OTHER MEASUREMENTS

Other transient signals, such as rectangular pulses or third-octave band bursts, tend to obscure the details of the transient response because of their wider bandwidth compared to sinusoidal tonebursts. Cabinet wall vibration is useful, particularly when comparing enclosure designs. Vibration of the cabinet is sometimes a source of coloration and may affect the judgment of program perspective or microphone placement. If numerical results are desired, an accelerometer may be attached to the cabinet walls.

You can, however, get a good idea of cabinet rigidity by a simple knuckle test: rapping each surface with the knuckles. Any tendency for a panel to "boing" or ring at a definite pitch indicates a need for bracing or damping of the surface. Vibration measurements have helped to explain audible differences between enclosures that are not apparent in other measurements.

To determine the maximum output capability of a loudspeaker, a random noise source is used. The amplifier is driven with a power amplifier conforming to the manufacturer's power recommendations, and the output is increased until audible clipping occurs. The resulting sound pressure may then be measured. Noise generators with shaping networks to simulate the average spectral energy distribution of music and speech are recommended for this purpose. Once the maximum output has been measured at a specified distance in the anechoic environment, the maximum output in any control room of specified acoustical properties may be calculated.

SUBJECTIVE TESTS

In addition to objective measurements in evaluating loudspeakers, subjective listening tests are also necessary to ensure that the measured colorations do not have a serious effect on the quality that is actually heard.² For meaningful results, any listening test should involve more than one loudspeaker. The faults of high-quality loudspeakers are usually only evident on comparison. If only two loudspeakers are compared, the criterion tends to be "which sounds better" rather than which has the least colorations. Therefore, in our formal listening tests we prefer to compare three or four loudspeakers at one time.

The Sensible Alternative MX-7300-8

- Under \$7,300—save 24 to 32%
- Compatible one-inch/eight-track format
- Motion sense logic prevents tape damage
- Optional remote synchronous-reproduce on all channels
- Professional type 600 ohm +4dB outputs and XL connectors
- 7½ / 15 or 15/30 ips.

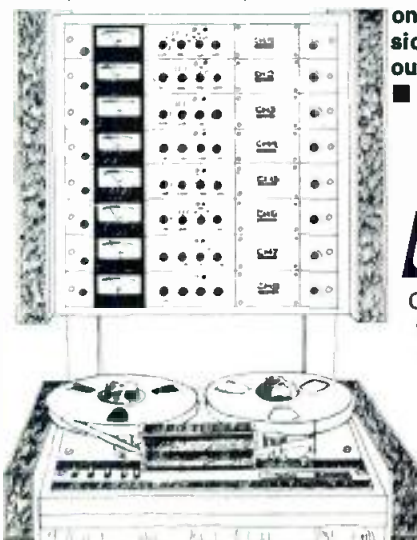

OTARI

Otari Corporation
981 Industrial Road
San Carlos, CA 94070
(415) 593-1648
TWX: 910-376-4890
In Canada: Noresco

The loudspeakers are concealed from view behind acoustically transparent drapery. That prevents the participants from being influenced by the appearance of the units. Each participant undergoes the tests privately, both to aid his concentration and to prevent his being influenced by other's votes or remarks. The participant selects the different loudspeakers by means of numbered pushbuttons. A wide variety of three-minute excerpts are used as program material. The participant indicates an order of preference for each type of program material.

Some loudspeakers contain response-adjusting controls, usually as part of the crossover network. To ensure a fair comparison, these controls must be set to give similar response trends on all units. That may be conveniently done in the listening room, using one-third octave bands of noise and a sound-level meter. Disc recordings of one-third octave noise bands are available for this purpose.

The loudspeakers are placed in the listening room so that the effect of low-frequency room modes is similar for each unit. A good listening room makes the test more accurate. The mid-frequency reverberation time should be under 0.5 sec.

PROGRAM CHOICE CRITICAL

Care must be taken in choosing program material. A poor choice could make the test meaningless. Male voices are excellent for showing up colorations below 500 Hz. A selection of closely-miked piano, banjo, or xylophone is useful in judging high-frequency transient performance. Complex orchestral passages, such as symphonic music, are useful if the listener is to determine whether the individual instruments are clearly defined or whether there is a confused blend due to poor overall transient performance.

One type of material to avoid is solo instruments recorded with normal microphone techniques. The instrument will appear to have a different timbre on each loudspeaker, but nobody will be able to decide which rendition is "correct." The voting in such a case will reflect personal preferences rather than judgment of accuracy.

A useful subjective appraisal of a loudspeaker may also be made while it is monitoring a live performance. By walking between the studio and control room, to compare live and reproduced sound, it is often possible to detect colorations.

The selection of participants can influence the outcome of a listening test. For example, program production personnel who have worked continually with a particular model of loudspeaker may become preconditioned to any peculiarities it may have. There is also an important difference in the assessments of technical vs. non-technical people. Technical personnel will generally listen specifically for certain faults, such as restricted bandwidth, distortion, poor transient response, etc. Non-technical people are more responsive to such things as microphone placement, solo vs. orchestral balance, and ambience. The voting, particularly of the non-technical listeners, may reflect personal preferences for a particular sound rather than judgments of accuracy. Participants should be encouraged to comment in writing, explaining why they voted as they did.

The introduction of any new monitoring system may mean that program production personnel will have to revise their studio techniques. Therefore, it is desirable to have them live with a proposed system before it is definitely implemented throughout the organization. ■

REFERENCES

1. Harwood, H. D., "Testing High Quality Loudspeakers," Part II, *Audio*, Aug. 1971.
2. Toole, F. E., "Selecting Loudspeakers, Part III, The Listening Test," *Electron*, Sept. 1971.

Solve all studio timing problems with ingeniously simple, low-priced digital timers from...



ES-300



ES-302



ES-500



ES-134

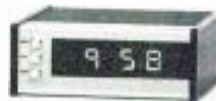

ES-400



ES-510

ES-300: A 100 minute up/down timer with incandescent digital display & momentary pushbutton controls on top of an etched aluminum case.

DIMENSIONS: 2 3/4" high x 8" wide x 5 1/2" deep
ELECTRICAL: 117 VAC 60 Hz 10W max
OPTIONS: B.D.G.H.I.K.P.Q.R.S.T.W.Y

Price: \$168.00

ES-301: Same as the ES-300 except with Planar gas discharge display

DIMENSIONS: 2 1/2" high x 8" wide x 6" deep
ELECTRICAL: 117 VAC 60 Hz 7W max
OPTIONS: B.D.G.H.I.K.P.Q.R.S.T.W.Y

Price: \$185.00

ES-302: Same features as the ES-301 PLUS lever-wheel, fast-set programming

DIMENSIONS: 2 1/2" high x 10" wide x 6" deep

Price: \$238.00

ES-400: Three-digit, ten minute timer in etched aluminum case

DIMENSIONS: 2 3/4" high x 6" wide x 5 1/2" deep
ELECTRICAL: 117 VAC 60 Hz 8W max
OPTIONS: B.D.J.K.P.Q.R.S.T.W

Price: \$98.00

ES-510: Four-digit, sixty minute timer with momentary pushbutton controls and etched aluminum case.

DIMENSIONS: 2 3/4" high x 6" wide x 5 1/2" deep
ELECTRICAL: 117 VAC 60 Hz 8W max.
OPTIONS: B.D.J.K.P.Q.R.S.T.W

Price: \$125.00

ES-132: Twelve volt, 12 hour DC digital clock in black anodized aluminum case, no 60 Hz Hum-m-m-m.

DIMENSIONS: 4 3/4" high x 3 3/4" wide x 1" deep
ELECTRICAL: 12 VDC
OPTIONS: B.D.E.F.J.K.P.Q.R.S.W

Price: \$200.00

ES-134: Same as the ES-132 except 24-hour, military time.

Price: \$200.00

ES-500: A twelve-hour, six digit, combination clock/timer with five action momentary pushbutton controls, etched aluminum case

DIMENSIONS: 2 3/4" high x 8" wide x 5 1/2" deep
ELECTRICAL: 117 VAC 60 Hz 12W max
OPTIONS: B.C.D.J.K.P.Q.R.S.W

Price: \$150.00

OPTIONS			
B	BCD Output	J	220 VAC, 50 Hz
C	Crystal Timebase	K	Kit
D	Remote Connector, 6' Cable and Pushbutton Set	P	1 1/2" Front Panel, 3 1/2" high
E	AC Operation with Crystal Timebase	Q	3/4" Front Panel, 3 1/2" high
F	AC Operation with Line Frequency Timebase	R	Remote Connector
G	Stop at Zero	S	Slave
H	Relay Contact Closure and Stop at Zero	T	Tenths of Seconds
		W	Three Wire Cord and Molded Plug
		Y	Relay Contact Closure at Zero

Call or Write for our catalog of Timers, Counters, Measurers, Programmers, Clocks and Simple Solutions To Custom Problems.



505 1/2 CENTINELA - INGLEWOOD, CA 90302
(213) 674-3021

Reliable, Simple Products Designed To Serve You, Not "Break You."

Recording Studio Acoustics, Part 5

After completion, a new studio must be tested for noise, echoes and sound foci, reverberation, cell isolation, loudspeaker and transfer response—all of which could take weeks.

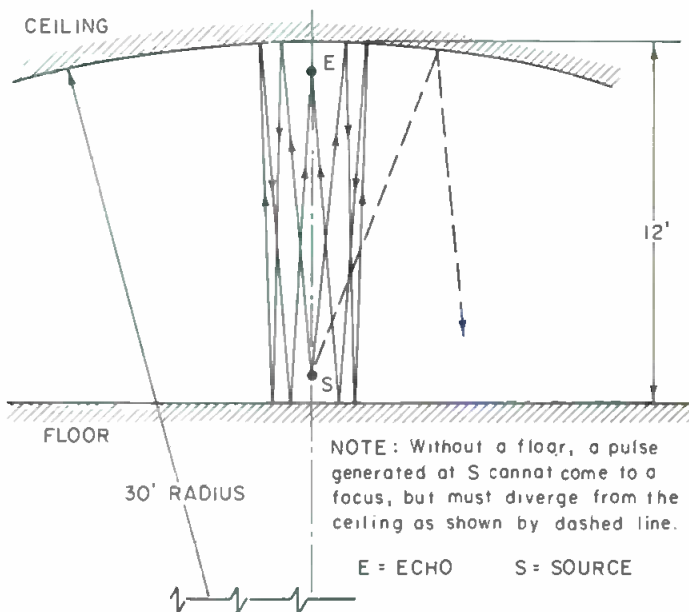

Figure 1. Geometric construction of echo produced by a reflective dome whose radius of curvature is 2.5 times the distance between floor and ceiling. Only the central reflecting area of the dome can produce a sound concentration.

AFTER THE STUDIO has been completed, how should it be tested? This is generally a period of anxiety for the acoustic designer, who knows well that many acoustic conditions are dependent on the quality of workmanship and material employed in the construction, over which he has no control. The tests may extend over days and weeks, particularly when sample recordings are to be made and the room is to be tuned to best performance by the adjustments of reflective or absorbent panels, loudspeaker response, noise control measures, etc.

Here is a set of tests for a new recording studio:

NOISE

This is best assessed by a 24-hour noise exposure level recording on a graphic level recorder to learn if it meets the specified limits of NC-20 or 30 dB-A for L_{10} or L_1 , i.e., that for only 10 percent or 1 percent of the test period does the noise level exceed these values. If another NC is called for in the specifications, the corresponding A-weighted sound level, L_A , is closely given by

$$L_A = 10 + NC$$

Thus, for NC-30, $L_A = 40$ dB-A.

Another noise or sound-insulation test consists in placing a microphone in the stage and then gradually increasing the available amplification in the mixing console to learn if feedback between stage and monitoring room will occur. By this test it was learned, in one instance, that a feedback loop existed between the air-conditioning system ducts of the two rooms. That was corrected by installing a duct-silencer (a short section of duct with sound traps) in the system.

On another occasion, a rumble could be heard over the monitoring room loudspeaker system when the gain was wide open, although it was not audible on the stage. The rumble was finally traced to a distant traffic vibration which carried into the microphone support. The cure consisted in the use of a very soft microphone suspension to act as a mechanical low-pass filter with a 4 hertz cut-off

frequency for the transducer mounting.

To check the insulation of the boundaries themselves, a 24-hour noise exposure level recording of the outside of the studio may be carried on simultaneously with the indoor recording. If only one graphic level recorder is available, the outside noise recording may be done on magnetic tape, which is later reproduced on the strip chart for direct comparison of the two exposure levels.

Still another noise test consists in "cranking" an audio oscillator through a powerful loudspeaker system on the stage and listening for rattles and clattering sounds produced by loose fixture parts, various panels, etc.

ECHOES, FLUTTER ECHOES, AND SOUND FOCI

An *echo* is a wave that has been reflected or otherwise returned with sufficient magnitude and delay to be detected as a wave distinct from that directly transmitted. A *flutter echo* is a rapid succession of reflected pulses resulting from a single initial pulse. A *sound focus* exists at a point where a sound wave converges, as by reflection from a hard concave surface; this sound concentration may give rise to an echolike effect. A line or area of focalization is known as a *caustic curve or surface*. These phenomena are detrimental to good recording conditions, and should be avoided in planning. Further information on the subject will be found in the writer's *Acoustic Design and Noise Control* available through the office of **db**.

I was once called to a newly completed studio which experienced a pronounced multiple echo from a 12-ft.-high concave reflective ceiling which had a radius of 30 ft. The inexperienced designer of the room showed me several "acoustic bibles" which stated that focusing from a concave surface could not occur within the room when the radius of curvature was twice the ceiling height or greater, because it would fall outside the flat boundary region. There was even an illustration of the geometry. Yet, there were clear and disturbing echoes when you clapped your hands directly below the ceiling dome. FIGURE 1 shows the reason for this unexpected acoustic condition.

REVERBERATION

It is doubtful whether even a first-class musician can tell the difference in a recording made in a room with a reverberation time of, say, 0.5 sec at 500 hertz, and one made in the same type of room having a reverberation time of ± 10 percent of 0.5 sec. The reason is that most of the audible decay takes place during the first 10 or 15 dB drop in the maximum signal level, which occurs within 0.1 sec when the reverberation time is 0.5 sec.

Nevertheless, the reverberation time at 500 hertz and the corresponding reverberation time characteristic constitutes a valuable criterion of the studio's qualitiveness in recording. By definition, the reverberation time at any one frequency refers to the decay of the signal after it has reached steady-state conditions before it is suddenly discontinued. FIGURE 2 shows various sound decay curves and states reasons for their shapes.

CELL ISOLATION

This term refers to the difference in the C-weighted sound levels between adjoining instrument enclosures used in multi-track recording when a signal of varying frequency is generated in one cell. This difference is expected to come to more than 10 dB.

LOUDSPEAKER RESPONSE

Because a studio is often used for listening to a recorded music track, it is desirable to establish a satisfactory loudspeaker response in the enclosure. Again, a graphic level recorder is desirable for this measurement; a

take advantage

Don't settle for just any professional power amplifier. Take advantage of the BOSE 1800.

Advantages like high power, ruggedness, reliability, serviceability, LED power indicators, and a full 5-year warranty.

The 1800 gives performers the advantage by providing them with all the power they need to handle the dynamics of their music.

BOSE 1800 pro power amp: designed to be taken advantage of.

Please send information on the BOSE 1800 to

Name _____

Address _____

City/State/Zip _____

BOSE The Mountain Framingham MA 01701 (617) 879-7330 Dept. DP

BOSE 1800

Wattnott Product Generator

The Wattnott, a package of effects that goes beyond the scope of present day signal processing equipment. By generating the product of two incoming signals (X and Y) vibrato effects, tone modulation, triggered expansion as well as V.C.A. applications for synthesizers are achieved. Special introductory offer for a limited time only \$495.00. Ask about our offer on the remarkable V.S.O. Resolver.

from acoustic design
to down beat...

Westlake Audio

6311 Wilshire Blvd
Los Angeles California 90048
(213) 655 0303

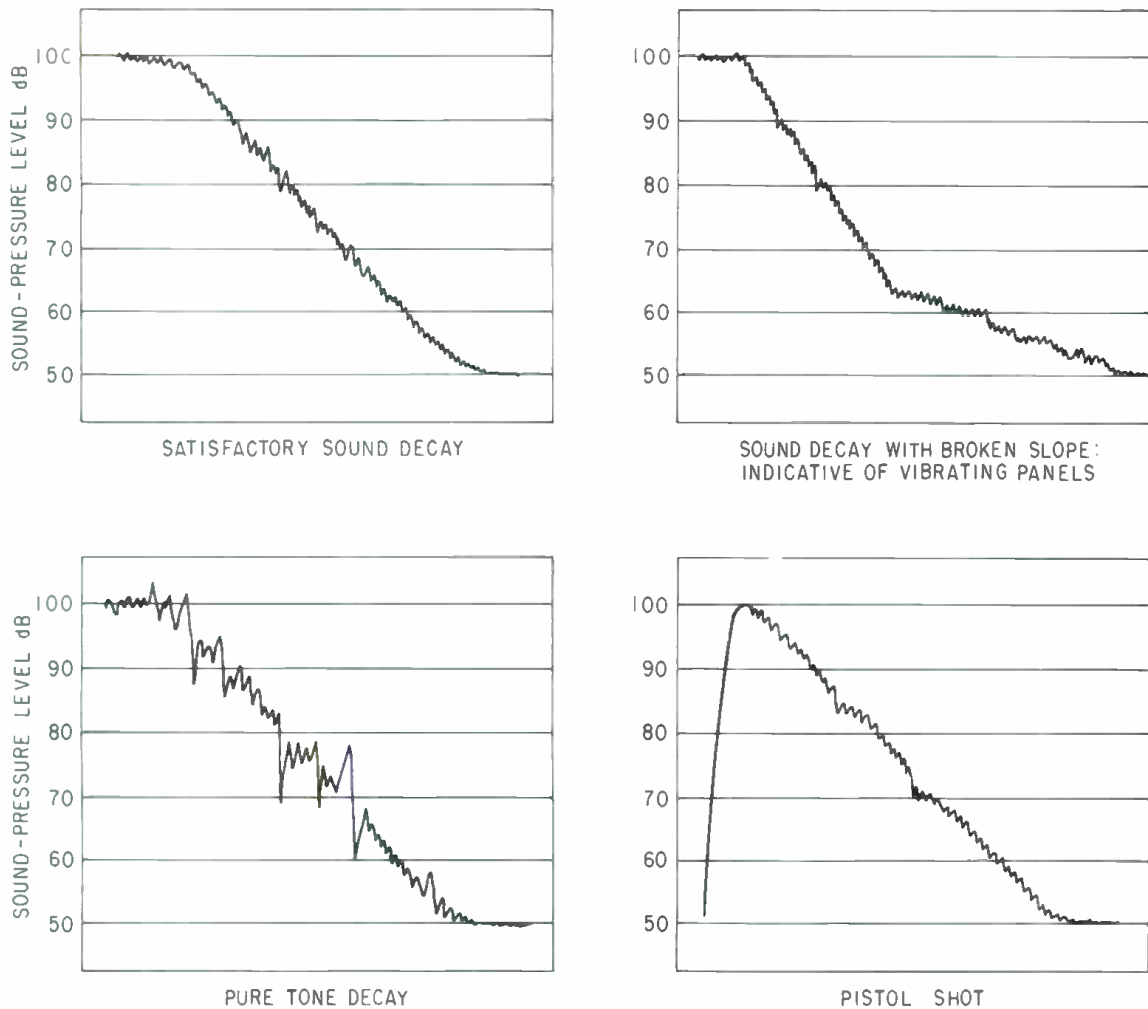

Figure 2. Sound decay curves recorded in various studios.

real-time analyzer will also be helpful.

We should note that there is no clearing house for speaker response, nor standard loudspeaker response for a music-recording studio, such as the guidelines set up by SMPTE (Society of Motion Picture and Television Engineers) for the loudspeaker-reproduce characteristic in a motion picture theater. Such a standard would be of great help to prevent the large response differences of disc and tape recordings. For this reason, SMPTE, as well as the Academy of Motion Picture Arts and Sciences, has recordings of speech and warble frequencies by which the reproduce-characteristic of a monitoring room in a motion picture studio can be standardized.

TRANSFER RESPONSE

Measure the frequency response of the unit near a loudspeaker in the studio. Then measure the signal output in the monitoring room after the studio microphone has been directed through the mixer. Now compare the two response curves. In other words, the tape played back on the stage should sound no different when played back in the monitoring room.

Studios which were designed to have variable absorption rather than a variable volume often exhibit a disappointingly small change in the reverberation time. This is not the fault of the designer, but is characteristic of those enclosures which display a goodly amount of room bound-

ary absorption even when all reflective panels on one wall are exposed. As a numerical example of this condition, consider a studio 20 ft. high, 30 ft. wide, and 50 ft. long, with a volume of 30,000 cu.ft., a total interior boundary surface of 6200 sq.ft., a reverberation time of 0.5 sec at 500 hertz when one of the large 20 x 50 ft. walls exhibits an absorptivity of only 0.1. The total absorption in the room comes to 3,000 sabins under these conditions. Now change the absorptivity of the 20 x 50 ft. wall to 0.90—a very high absorptivity indeed. The total absorption in this room now comes to 3800 sabins, and the reverberation time to 0.4 sec, a bare 20 percent reduction in the time, and one not markedly noticeable.

The main advantage of the absorbent or reflective wall treatment is to provide a live or dead locale for instruments situated near it. A similar increase in the absorption in an equally large reverberation chamber with an original reverberation time of 6.53 sec could have resulted in lowering the period to 1.45 sec, a 4.5-fold reduction.

But even when the volume of an enclosure is reduced by half, the reverberation time is still not likely to be cut in half, because the absorption is not halved. Thus, when the ceiling of a room is lowered, only the sidewall absorption is reduced while the ceiling and floor absorption remain the same. Such effects should be pointed out to the owner of the studio before the studio is even designed, and not explained to him after construction. ■

Closing date is the fifteenth of the second month preceding the date of issue.

Send copy to: Classified Ad Dept.

db THE SOUND ENGINEERING MAGAZINE

1120 Old Counry Road, Plainview, New York 11803

Rates are 50¢ a word for commercial advertisements.

Employment offered or wanted ads are accepted at 25¢ per word.

Frequency discounts: 3 times, 10%; 6 times, 20%; 12 times, 33%.

FOR SALE

ONE WAY NOISE REDUCTION for cutting rooms/tape copies; retains highs, rids hiss/surface noise & clicks/pops by a full 10-14 dB and costs \$150 up per channel! **Music & Sound, Ltd., 11½ Old York Rd., Willow Grove, Pa. 19090. (215) 659-9251.**

ORTOFON

DYNAMIC MOTIONAL FEEDBACK mono disc cutting system. Complete amplifier system: drive, feedback, and feedback-playback monitor preamp; rebuilt, original factory parts. Guaranteed. **Albert B. Grundy, 64 University Place, New York, N.Y. 10003. (212) 929-8364.**

DYMA builds roll-around consoles for any reel-to-reel tape recorder. **Dyma Engineering, Route 1, Box 51, Taos, New Mexico 87571.**

SCULLY, ELECTRO-VOICE, Neumann, Shure, Spectrasonics, Quad Eight, Masterroom, ARP, Crown, Microtrak, Russco, dbx, Interface, EMT, and others. **The Audio Marketplace, Div. United Audio Recording, 5310 Jockwood, San Antonio, Texas 78238. (512) 684-4000.**

FOR SALE: SPECTRASONICS MODEL 1020-8/16; 14 buss; 20 input; 16-track; monitor; quad; all factory wired; mint condition. \$20,000.00. Contact: **Brian, Paramount Recording, L.A. (213) 461-3717.**

AMPEX AG-500-2, 7½/15 ips 2-track stereo recorder, \$800.00. **Steve Lewis, 6427 N. Ridge Blvd., Chicago, Ill. 60626. (312) 338-9459.**



CATV—MATV PRODUCTS

- CONNECTORS
- WALLPLATES
- SPLITTERS
- AMPLIFIERS



AVA ELECTRONICS CORP.
242 Pembroke Avenue, Londisdowne, Pa. 19050
(215) 284-2500

BABY BOOM STANDS and a snake, 100' or >, 15 pair or >. **Ray Eldred, 2703 W. 9th, Olympia, Wash. (206) 357-6885.**

REEL SPECIALISTS: 14-inch new NAB Ampex metal flanges, in original box of 10, \$8.75. 10½-inch x ¼ NAB and Precision reels bought and sold. New Precision 10½ x ¼, \$6.00 each (add \$.60 for new box) plus 10% postage. **Soundd Investment Co., P.O. Box 338, Dunwoody, Ga. 30338.**

SCULLY ¼"-½"-2" RECORDERS, immediate delivery; console kits, 16/2, \$2,995.00, 16/4, \$3,295.00, 16/16, \$5,495.00, W/E.Q., available wired. All electronics, modular plug-in, Spectra-Sonic cards. **Stereotronic Industries Inc. (since 1940), 700-29th St., Zion, Ill. 60099. (312) 336-2222.**

BROADCAST AND RECORDING EQUIPMENT: Scully; Metrotech; Langevine; Electrodyne; Q.R.K.; Micro-Trak; M.R.L.; Nortronics; McMartin; U.R.E.I.; Revox; Crown; Byer; Lamb; Master Room; Stellavox; E.V.; A.K.G.; Sennheiser; Atlas; Ferroglyph; HAECO; Stevenson; Gately; dbx; Advent; Altec; Fairchild; Audio Designs; 3M; Magnacord; Telex; Inovonics. Disc recording systems; package deals; installations; service. **Wiegand Audio, Middleburg, Pennsylvania 17842. (717) 837-1444.**

\$1. MILLION USED RECORDING—PA—BROADCASTING EQUIPMENT. Send \$1.00 for list, refundable, to **The Equipment Locator, P.O. Box 99569, San Francisco, Ca. 94109.**

SOLID-STATE AUDIO MODULES. Console kits, power amplifier kits, power supplies. Octal plug-ins—mic. eq., line, disc, tape play, tape record, amplifiers, Audio and tape bias oscillators. Over 50 audio products; send for free catalog and applications. **Opamp Labs, Inc., 1033 N. Sycamore Ave., Los Angeles, Ca. 90038.**

KING MODEL 800S TAPE WINDER (hub); pre-recorded tape winder, will wind either ¼ in. or 150 mil. widths; as new condition. Also used Rangertone resolver, as is. **Gary E. Taylor, Continental Film Productions Corp., P.O. Box 6543, Chattanooga, Tenn. 37408.**

B.B.C. REFERENCE MONITORS, pre-equalized J. B. L./Altec monitors; Dahlquist phased arrays; I. M. F. transmission lines; Infinity electrostatics; Crown/McIntosh 16 Ω/bridged bi-amps; Scully/Revox A-700 recorders; Micmix reverbs; Eventide phasors/omnipressors; Lexicon digital delays; dbx/Burwen N.R. compressors; Little Dipper hum/buzz notch filters; Cooper Time Cube echo send; moving coil Supex/Ortofon; B & O straight line arms/cartridges; Schoeps/AKG/Sennheiser condensers; Beyer ribbons, U.R.E.I. comp/limiters/crossovers; Gately pro-kits; Q.R.K. tt. 1000s more. **Music & Sound Ltd., 11½ Old York Rd., Willow Grove, Pa. 19090. (215) 659-9251.**

→ All Shipped Prepaid + Insured ←

CASSETTE DUPLICATION; 25 or more pieces—C-60 or shorter; monaural. **TARZAC, 638 Muskogee Avenue, Norfolk, Virginia 23509.**

BROADCAST QUALITY MIXER for disc jockeys, theater sound men, background music operators, video and film sound men. Simultaneous mixing of two stereo phonographs, a tape machine, and a microphone. Precue for all inputs with built-in monitor headphone amplifier. Send for literature. \$325.00. Professional discount, use letterhead. **GLI, Box 2076, Dept. D, Brooklyn, N.Y. 11202. (212) 875-6992.**

BODE FREQUENCY SHIFTERS since 1963... Advanced designs for electronic music studios and high performance P.A. systems. Synthesizer compatible model with built-in B.F.O., exponential interface, \$995.00. Anti-feedback model: audio range 35 Hz-16 kHz for speakers, entertainers, bands, \$575.00. Prices f.o.b. North Tonawanda. Delivery: stock to 6 weeks. For details and information on other models, write to: **Bode Sound Co., Harold Bode, 1344 Abington Place, N. Tonawanda, N.Y. 14120. (716) 692-1670.**

CROWN CX844 4-track recorders (2). Many extras, including VSO, remote, Dolbys (4), custom cabinets. Low time, excellent condition; any reasonable offers considered. **P.O. Box 9245, Berkeley, Ca. 94709. (415) 527-4043.**

AMPEX MODIFICATION — update old Ampex units with new capstan drive, tension control, for better frequency response/overall performance. \$795 for models 300, 3200, 3300. Prices on request for others. **AUDIO/TEK INC., 503F Vandell Ave., Campbell, Ca. 95008. (408) 378-5586.**

Be sure
to attend . . .

THE AUDIO ENGINEERING SOCIETY'S

51st Technical
Meeting and
Exhibition of
Professional
Equipment
at the
Los Angeles
Hilton
May 13-16

For details, write or phone:

AUDIO ENGINEERING SOCIETY

• 60 E. 42nd St., N.Y., N.Y.
10017 (212) 661-8528

• 11916 Salem Dr.,
Granada Hills, Calif.
(213) 363-5111

FOR SALE

NEUMANN LATHE, rebuilt, Lyrec motor, Scully saddle with EICO L.P.I., \$5,000.00. Write: A. Angileri, 6331 S.W. 80th St., S. Miami, Florida 33143. Phone: (305) 667-4148.

HARMONIC PERCUSSION for any Hammond organ. Quick, simple. **Linear Devices, Dept. 3, Box 5750, San Francisco, Ca. 94101.**

STUDIO SOUND—Europe's leading professional magazine. Back issues available from June, '73. \$1 each, postpaid. **3P Recording, P.O. Box 99569, San Francisco, Ca. 94109.**

MONITOR EQUALIZERS for your Altecs & J.B.L.s are a steal at \$75/channel

+

FREE ROOM EQUALIZATION with purchase of 1/3 octave filters. This is not a misprint. **Music & Sound, Ltd., 11 1/2 Old York Rd., Willow Grove, Pa. 19090. (215) 659-9251.**

→ **S.M.E. Damping Mods—\$30.00** ←

NEW MODELS: Ampex AG440C 2-track, servo capstan motor; Scully 280B; used AG440Bs; used Scully 280, 8-track, new heads, in console, excellent condition; Sennheiser mics. Immediate delivery from stock. **Malaco Recording, Jackson, Miss. (601) 982-4522.**

TARZAC PROFESSIONAL CASSETTES—Custom Cassette Labels. Complimentary samples. **TARZAC, 638 Muskogee Avenue, Norfolk, Virginia 23509.**

CUSTOM CROSSOVER NETWORKS to your specifications: 1 or 1000. Power capacities to 1,000 watts. Networks duplicated. High tolerance air and iron core inductors. Outline your needs for rapid quotation. **TSR ENGINEERING, 3673 W. 113th St., Inglewood, Ca. 90303. (213) 678-1979.**

AMPEX SPARE PARTS; technical support; updating kits, for discontinued professional audio models; available from **VIF International, Box 1555, Mountain View, Ca. 94042. (408) 739-9740.**

SPLICE TAPE FASTER, BETTER, BY SHEARING. Experts recommend Nagy splicers. Quality long-lasting instrument. Reasonably priced. Details, **NRPD, Box 289, McLean, Va. 22101.**

TASCAM REVERBS—\$500; Tascam mixing consoles—\$2,350; Tascam 1/2-inch recorders—\$2,750; Tascam 8-track recorders—\$4,600. All shipped prepaid/insured, including free alignment/equalization/bias/calibration. **Music & Sound, Ltd., 11 1/2 Old York Rd., Willow Grove, Pa. 19090. (215) 659-9251.**

TIMEKEEPER Telephone Line Equalizer

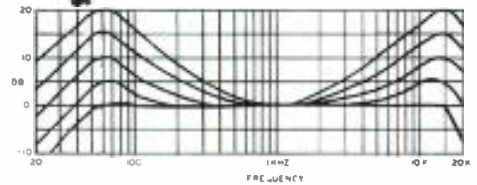

Here is a compact, self-powered telephone equalizer for use in radio, TV or communications systems that helps restore signals lost in long transmission lines. It can be easily inserted into any existing system and provide additional gain when necessary. The equalizer has balanced input and output to assure complete line isolation.

The TIMEKEEPER MODEL TLE-1 uses the latest OP AMP active filter design to provide excellent stability, low distortion and low noise.

Radio talk shows and remote pickups will find this unit essential. You can pre-equalize the signal to improve response with less noise as well.

The TLE-1 is built to the highest standards in the industry and is unconditionally guaranteed for one year. If you find it does not improve your signal — return it for a full refund. You will find the TLE-1 a great buy at only \$295.00.

PERFORMANCE SPECIFICATIONS Telephone Line Equalizer Model TLE-1

Gain, variable	unity—20db
Input impedance	600 ohms
Output impedance	20 ohms (designed to work into 150 or 600 Ohm loads)
Max. input level	+20 dbm (at unity gain)
Max. output level	+20 dbm
Frequency response	± 1/2db 50-15,000 Hz
Available boost (cont. controlled)	20 db max at the extremes of covered spectrum
Distortion	less than 0.2%
Noise	70 db below 0 db level
Input and output isolation	transformer, balanced floating line
Power required	117VAC ~ 1 watt
Amplifiers	IC OP amps, plug-in
Controls	ON-OFF switch Gain control Low end boost High end boost
Indicators	LED pilot light

TIMEKEEPER

P.O. Box 35, Great Neck, N.Y. 11021

Please send me _____ Model TLE-1 Telephone Line Equalizer(s) at \$295.00. N.Y.S. residents add 7% sales tax. I enclose _____.

Name _____

Address _____

City _____

State _____ Zip _____

MULTI-TRACK

- ★ SERIES "B" MIXING CONSOLE
- ★ VARI-BAND 5 SECTION PARAMETERIC EQUALIZER
- ★ DUAL EQUALIZED REVERB
- ★ LONG & SHORT THROW SLIDE FADERS
- ★ HIGH BALLISTIC VU METER

P.O. BOX 3187
HOLLYWOOD, CA 90028
(213) 467-7890

AMPEX, SCULLY, TASCAM, all major professional audio lines. Top dollar trade-ins. 15 minutes George Washington Bridge. **PROFESSIONAL AUDIO VIDEO CORPORATION, 342 Main St., Paterson, N.J. 07505. (201) 523-3333.**

Looking for SYNTHESIZERS? Make one stop at EMSA. We carry the finest systems in the world. Write **E.M.S.A., 460 West St. (S), Amherst, Mass. 01002.**

WHATEVER YOUR EQUIPMENT NEEDS—new or used—check us first. We specialize in broadcast equipment. Send \$1.00 for our complete listings. **Broadcast Equipment & Supply Co., Box 3141, Bristol, Tenn. 37620.**

THE LIBRARY . . . Sound effects recorded in STEREO using Dolby™ throughout. Over 350 effects on ten dlscs, \$150.00. Write, **The Library, P.O. Box 18145, Denver, Colorado 80218.**

TUNED ROCK P.A.s Customized high intensity touring/permanent installation sound systems, including narrow band (5 Hz!) feedback suppression, detailed regenerative response Acousta-Voicing/environmental equalization (± 1 dB at your ears), room design/measurement/treatment, $\leq 15\%$ articulation loss of consonants; 1000s of customized professional products, including fiberglass horns, consoles, comp/rms/peak limiters, 18 dB continuously variable electronic crossovers, digital/acoustic delays, omnipressors, phasors, reverb, echo, doubling/tripling effects, P.A. noise reduction; piezo transducers; frequency shifters from: J.B.L./Altec pro, Tascam, U.R.E.I., Eventide, Gately, Schoeps, Beyer, Crown, Community Light/Sound, Mom's Audio, McIntosh, Bozak, Allen & Heath, etc. etc. All shipped prepaid/insured. **Music & Sound, Ltd., 11½ Old Yark Rd., Willow Grove, Pa. 19090. (215) 659-9251.**

Inventars/Engineers

FOR SALE: AUDITRONICS CONSOLE; 24-in/24-out; full quad; quad reverb with two API joy sticks; built-in stereo radio speakers; two producers' desks; used nine months; will include 16 ITI parametric equalizers (brand new). Total original cost of this package: \$37,720—your price: \$27,000! (If you want only 18 inputs, the total cost will be \$24,000.) Will separate and will finance. Contact **Paul. (312) 225-2110, Chicago.**

CROWN D1200, M600, and M2000; drives RTR "Monitor" speakers, on demo now in our showroom. **Barclay Recording, 503 Haverford Ave., Narberth, Pa. (215) 667-3048.**

WANT TO GO BI-AMP?
DeCoursey Electronic Dividing Networks are available from \$89.10 (monaural bi-amp) to \$205.00 (stereo tri-amp). Price includes plug-in Butterworth filters; 6, 12, or 18 dB per octave at any desired cutoff frequency. **DeCoursey Engineering Laboratory, 11828 W. Jefferson Blvd., Culver City, Ca. 90230.**

LOWEST PRICES IN THE COUNTRY on microphones, power amps, speakers, musical instruments, P.A. equipment, including Peavey, Heil, J.B.L.; huge stock, top brands only. **Gracin's 110, 606 Rte. 110, Huntington, N.Y. 11746. (516) 549-5155.**

AMPEX MM1000, 8-track recorder, 7½-15 i.p.s.; used 20 hours, mint condition. Cost \$17,850.00, now \$8,500.00. **Agency Recording, 676 N. LaSalle St., Chicago, Ill. (312) 236-3632.**

MIXER MODULES: modular construction provides economical route to studio-type mixing console; modules available with mic/line, pan, echo send, plastic element slide faders; equalization is also available as an add-on module. Typical cost of 6-in, 2-out mixer (no EQ) is less than \$450.00. Send for catalog: **Wall of Sound, 2406 Mountain Rd., Pasadena, Md. 21122.**

NAGRA SNN TAPE RECORDER, 3¼-1⅞ in/sec, never used, original cost: \$1,800.00. Best offer. **K&W ComCepts, 10 Vanderwater St., Farmingdale, N.Y. 11735. (516) 293-0588.**

SINGLE EDGE RAZOR BLADES, tape editing. \$23/M. Flyer. **RALTEC, 25884 Highland, Cleveland, Ohio 44143.**

**ONE STOP
FOR ALL YOUR PROFESSIONAL
AUDIO REQUIREMENTS
BOTTOM LINE ORIENTED
F. T. C. BREWER CO.
P.O. Box 8057, Pensacola, Fla. 32505**

NEW YORK'S LEADING PRO AUDIO/VIDEO DISTRIBUTOR for audio, video, broadcast, public address, and hi-fi systems; representing over 130 audio/video manufacturers, featuring such names as Ampex, Scully, Tascam, Sony, J. B. Lansing, Neumann, Altec, McIntosh, AKG, Dynair, T.V. Microtime, UREI, 3M, and other major brands; the largest "in stock" inventory of equipment, accessories, and parts; competitive discount prices; factory authorized sales, service, parts, systems design, installation. Write for free catalog! **Martin Audio/Video Corporation, 320 W. 46th St., New York, N.Y. 10036. (212) 541-5900.**

DYMA builds custom studio consoles, desks, enclosures, studio furniture. **Dyma Engineering, Route 1, Box 51, Taas, New Mexico 87571.**

COHERENT CONCERT SOUND—not just P.A.! We work with musicians to create an aural environment in concert that matches studio production. **(212) 947-1271.**

STELLAVOX TAPE RECORDER, recent model. \$1,500.00. **Michael Clement, 19 Grove St., New York, N.Y. 10014. (212) 924-9388.**

WANTED

WANTED: FOR NORTHWEST AUDIO DEVELOPMENT, Phase 8 console: schematics, spare modules, or any information whatsoever. **Cliff Petroll, Charles Lane Studios, 7 Charles Lane, New York, N.Y. 10014. (212) 242-1479.**

EMPLOYMENT

WANTED: EXPERIENCED SENIOR RECORDING ENGINEER with solid following to join forces with growing top quality studio. Terms: negotiable. Contact: **Jerry Kornbluth, A&J Audio Visual Services, 119 W. 57th St., New York, N.Y. 10019.**

SOUND DEPARTMENT PROJECT MANAGER — for well-established, small Musak operation. Experienced, with technical understanding of P.A., intercom, paging, phones, background music, studio equipment. Ability to work with architects and engineers, handle take-offs, write specs, design systems, make surveys, supervise/service/install systems. Sales-oriented, efficient, good personality essential. Live in Wisconsin's most beautiful city! Send resume to **Accent Music, Inc., 20 N. Butler St., Madison, Wisc. 53703.** Call collect any time for Mr. Johnston or Mr. Conrad (608) 256-7181.



SHEAKS



ALLEN



LINK

- West coast activities of sales representatives for **Blonder-Tongue Laboratories** of Old Bridge, N.J. will be coordinated by newly appointed **Harold Sheaks**. Mr. Sheaks will also develop new markets for the company's line of T.V. reception products for the home as well as MATV and CATV installations. Mr. Sheaks comes to **Blonder-Tongue** from **General Telephone of California**.

- **Eddor**, manufacturers of professional wireless sound equipment, of Costa Mesa, California, has signed a contract with **Calrec Audio Ltd.**, British manufacturer of professional recording condenser microphones to be exclusive U.S. marketing representatives for Calrec's line. It is hoped to establish further dealerships and distributorships for the Calrec mic in the domestic market. Eddor is currently seeking both distributor and dealer inquiries.

- **Ampex Corporation**, of Redwood City, California, has made an arrangement, through the **Ohmtec Corporation**, to distribute **Burwen Laboratories'** dynamic noise filters, including both professional and consumer products. The agreement gives Ampex exclusive distribution rights in international markets and non-exclusive rights within the United States.

- Developing new markets and areas of activities have spurred a series of organizational changes at **Dolby Laboratories**, of New York and London. **Elmar Stetter**, formerly technical sales manager, takes on a new position of European sales manager. This will

enable **Ioan Allen**, marketing manager, to increase his responsibilities in the area of motion picture servicing. **Steve Katz**, applications engineer, will leave New York to relocate in Hollywood, where he will concentrate on film industry activities. **Adrian Horne**, former licensing manager, has become head of advertising and information, replacing **Bob Berkovitz**, who has returned to **Acoustic Research** after four years with **Dolby Laboratories**. The new licensing manager is **Ian Hardcastle**, who will coordinate links with **Dolby's** more than 50 licensees.

- **Charles Link** has been named president of **Electro Sound, Inc.**, of Sunnyvale, California. Mr. Link joined **Viewlex**, **Electro Sound's** parent company, in 1972. His most recent assignment has been that of vice president and general manager for **Electro Sound**. **Capital Communications Company**, of Los Angeles, has been selected to handle the marketing support program for **Electro Sound, Inc.'s** products. A sizable campaign has been planned. Personnel involved in the **Electro Sound** account are **Don Kader**, **George Foon**, and **Kathy Scully**.

- **AMTEC '75**, Canadian Educational Communications Conference of the Association for Media and Technology in Education will be held in Calgary, Alberta June 15-18. The theme, "Partnerships in Learning," will feature seminars, discussions, and hands-on workshops. The keynote speaker will be **Knowlton Nash**, director of information programs, **CBC** network. In conjunction with the conference, there will be an educational media compe-

tion. Contact for registration: **Garry Smith**, **ACCESS Television South**, Calgary Health Sciences Centre, 1600 29th St. N.W., Calgary, Alberta T2N 4J8. The registration fee for the conference is \$85 for **AMTEC** members and \$100 for non-members; student rates, \$25. Entries for the media competition may be submitted to **David Cormack**, at the above address. Categories include print, audio materials, filmstrips and audio/slide combinations, videotapes, films, and learning kits in the following classifications: individual schools, school systems, post-secondary institutes, government media agencies, and commercial producers.

- Two of broadcasting's pioneers, **George B. Storer** and the late **Jack Benny**, were honored by the **National Association of Broadcasters** during its annual convention in Las Vegas. **Jack Benny** received a special posthumous award in affectionate recognition of his years in radio. Mr. Storer was the recipient of the 1975 **Distinguished Service Award**, the industry's highest honor. Mr. Storer's career in the broadcasting industry commenced in 1928 when he acquired station **WSPD** in Toledo, Ohio. His company, **Storer Broadcasting Co. of Miami, Florida**, now owns and operates six radio and six television stations throughout the country.

- Litigation regarding fair trade agreements is under way in a suit filed by **TEAC Corporation**, of Montebello, Ca. against **S & M Stereo Center** and **Ultralinear Sound Corp.** asking for a preliminary injunction against the two companies. **TEAC's** suit alleges conspiracy between the two companies to violate **S & M's** fair trade agreement with **TEAC** and the fair trade laws of New York and New Jersey. **Ultralinear** trades in Brooklyn and Long Island under the name of **Crazy Eddie's** and **S & M's** store in New Jersey is known as **Sound Machine**. The two distributors are counter-suing, charging that **TEAC** is in violation of the **Sherman Act**.

savEnergy

Our new E series audio equipment will improve your sound and cut your costs . . . or your money back!

**TURNTABLE
PREAMPS**

**MIC & LINE
AMPLIFIERS**

AUDIO DISTRIBUTION AMPLIFIERS

AUDIO CONSOLES & CONTROLLERS

**STUDIO MONITOR
AMPLIFIERS**

**REMOTE POWER
CONTROLLERS**

**AUTOMATIC TAPE CARTRIDGE
& CASSETTE LOADERS**

TEN DAY FREE EVALUATION AND 2 YEAR GUARANTEE INSURE YOUR UNCOMPROMISED SATISFACTION

TURNTABLE PREAMPS

Preamps costing almost 3 times more will not compare with these units. RIAA/NAB equalized ± 1 db, 0.5MV sensitivity at 1KHz for +4dbm out, balanced outputs, -75db s/n at 10mv in, 0.05% distortion, +21dbm max. out. Internal power supply.

MP-8E Mono \$86 SP-8E Stereo \$137

MIC & LINE AMPLIFIERS

Dual function and superb performance. Inputs for mic and line, ± 0.5 db response 10Hz-20KHz, 67db gain on mic channel(s) +26db gain on line inputs. Balanced inputs & outputs, +21dbm out max, 0.1% distortion. Internal power supply.

MLA-1E Mono \$98
MLA-2E Dual Mono/Stereo \$139

AUDIO DISTRIBUTION AMPLIFIERS

From 1 in/6 out to 20 in/80 out in one small package. Whatever your distribution requirements we have an answer. All units meet or exceed the following specifications: Balanced bridging/matching inputs, balanced 600ohm outputs, ± 0.5 db response 10Hz-20KHz, ± 3 db 5Hz-40KHz, 26db gain, +21dbm out. max. capability, 0.1% or less distortion, outputs isolated by 80db, hum and noise 90db down referenced to +21dbm out. Internal power supply.

DA-6/E Table top. 1 in/6 out. \$131
OA-6R/E Rack mount. 1 in/6 out. \$149
DA-6BR/E Rack mount. 1 in/6 out. Individual level controls for each output. \$165
DA-6RS/E Rack mount. 1 in/6 out stereo or 2 in/12 out mono. \$229
DA-16BR/E Rack mount. 1 in/8 out stereo or 2 in/16 out mono. Individual output level controls, selectable metering & headphone monitoring. \$287
DA-2080/E Rack mount main frame with protected

power supply, metering & headphone monitor. Will accept up to 10 slide in modules. Each module has 2 inputs & 8 outputs. Individual output level controls & selectable meter switch. Up to 20 in/80 out.

DA-2080/E Main Frame \$150
DA-2080/E Modules 2 in/8 out \$135 ea.

AUDIO CONSOLES & CONTROLLERS

Our new series 35 audio controller introduces a new concept in audio mixing. Allows separation of controls from the audio functions. Controls can be placed in any convenient location in the studio, while electronics may be mounted anywhere for easy maintenance & hookup. Remote DC control for completely unaffected audio.

This versatility gives you a custom designed console at a standard production model cost.

Features include; 8 channels, mono, dual channel mono, stereo, dual channel stereo, or combinations; paralleling 2 units for quad, fail safe power supply & plug in interchangeable cards.

Performance specifications are; 0.3% or less distortion, 124dbm equivalent noise on low level channels, approximately 25w power consumption, -70db crosstalk, balanced bridging/matching inputs & response within ± 2 db 20Hz-20KHz. Series 35 audio controllers start at \$1200.

AUTOMATIC TAPE CARTRIDGE AND CASSETTE LOADERS

So easy to use & accurate that our largest winder competitor has been using one of these to load their own carts.

Eliminates guesswork. Set the dials to the length desired. The exact amount of tape is fed onto the cart or cassette hub and then shuts off automatically. Also has exclusive torque control for proper tape pack on different size hubs. Winds at 30 IPS.
ACL-25/E \$185

Winders also come in higher speed models (ACL-60 series). Same operation as above but winds at 60 IPS. Accepts 14" pancakes.

ACL-60T/E (tone stop only) \$266
ACL-60B/E (Blank tape loader) \$331
ACL-60BT/E (for both prerecorded and blank tape) \$375

STUDIO MONITOR AMPLIFIERS

Exceptional reproduction! Internal muting. ± 2 db response from 20Hz-40KHz. 25w music power, 20w RMS into 8 ohms. Hum & noise 65db below rated outputs.

Distortion less than 0.25% at less than 20w out, 1% or less at 20w. Works into 4-16ohms. Balanced bridging inputs, variable bass contour, internal overload & short circuit protection.

SMA-50/E Table top (mono) \$125
SMA-500/E Rack mount (mono) \$142
SMA-1000/E Rack mount (stereo-40w) \$196

REMOTE POWER CONTROLLERS (DUAL)

Safe, transient free means of controlling 110V/AC. Turntables, on the air lights, etc.

PR-2 (toggle switch on/off) \$39
PR-2B (momentary contact actuation) \$54

Give us a call or write today for further details. You'll be money and performance ahead.

CALL COLLECT — (916) 392-2100

WRITE — 3516-C LaGrande Boulevard
Sacramento, California 95823

RAMKO RESEARCH

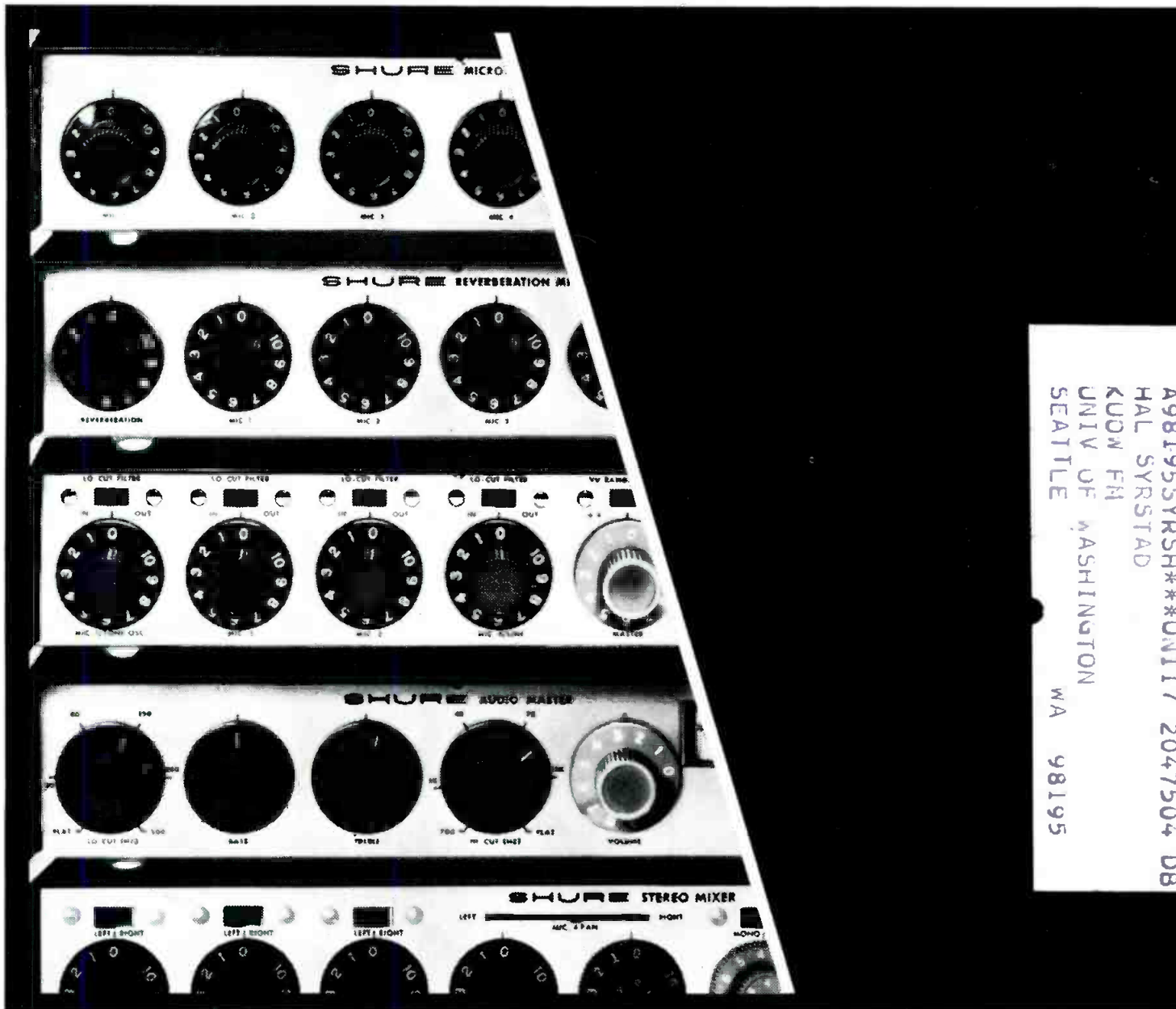

A981955YRSHH**UNIT 7 2047504 DB
 HAL SYRSTAD
 KUOW FM
 UNIV OF WASHINGTON
 SEATTLE WA 98195

Panel full of miracles.

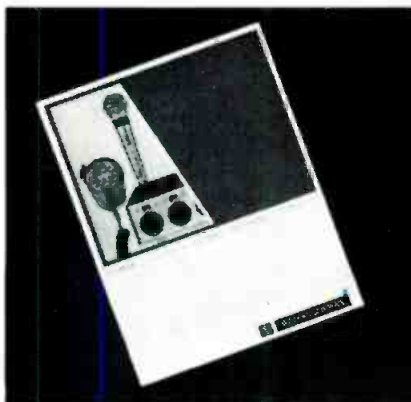

Shure mixers, audio level controllers, and feedback controllers are all designed to deliver more audio control, more features, and more performance dollar for dollar than any other components with similar audio features. Their compact size and modular "stackable" design mean they can be easily combined in various configurations in even the smallest spaces. And they're versatile—their input-output flexibility equips them for an extremely wide range of audio applications, giving you control you never thought possible without bulky, expensive installations. You can easily put together a system that's exactly right for your precise needs without putting extra dollars into built-in features you really don't need. For the details on our entire line of miracle workers, write:

Shure Brothers Inc.
 222 Hartrey Ave., Evanston, IL 60204
 In Canada: A. C. Simmonds & Sons Limited



Manufacturers of high fidelity components, microphones, sound systems and related circuitry.

Circle 12 on Reader Service Card