

SN0011-7145

THE SOUND ENGINEERING MAGAZINE

NOVEMBER 1978
\$1.95

db

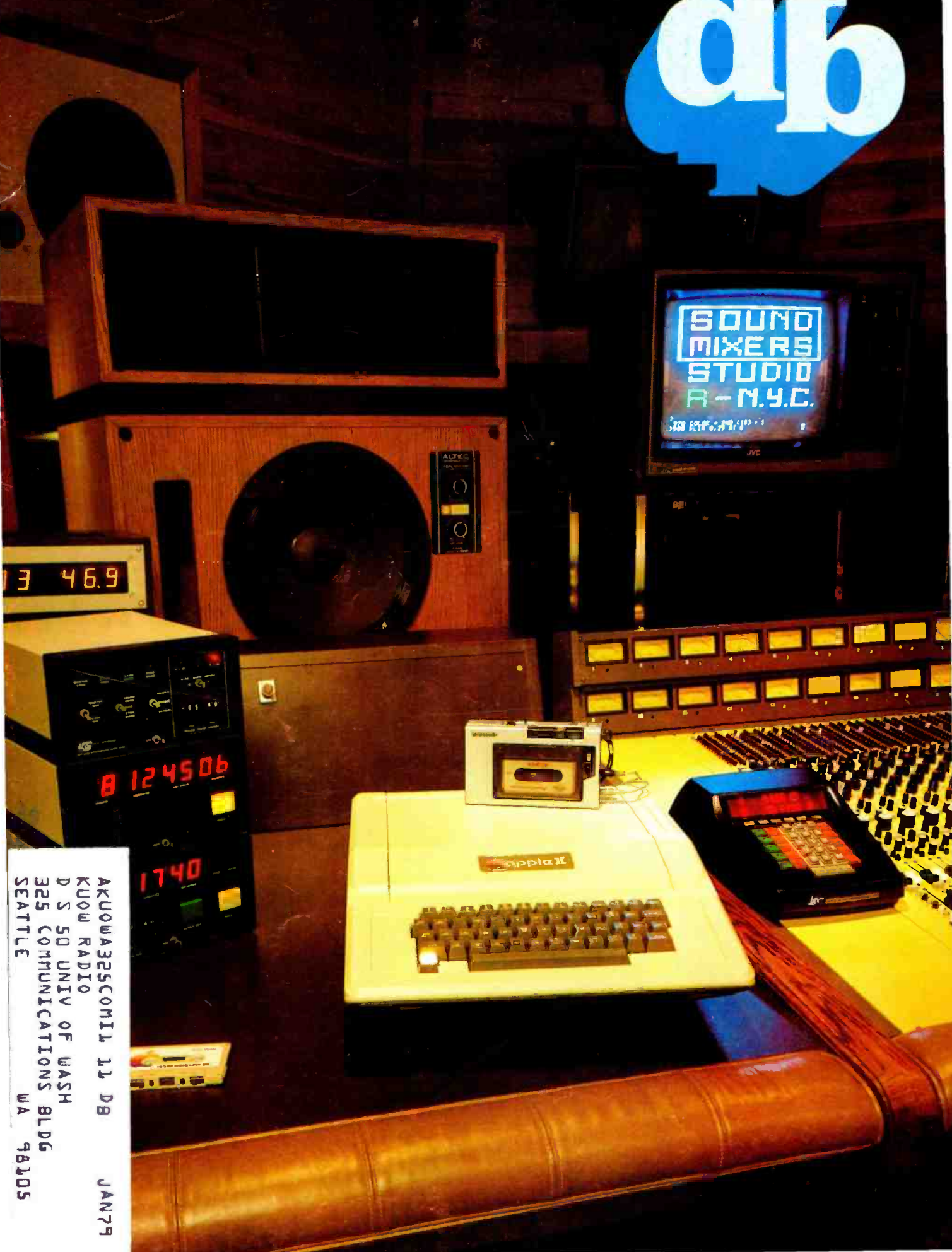

AKUOWA325COMILL 11 DB JAN79
 KUOW RADIO
 D S 50 UNITV OF WASH
 325 COMMUNICATIONS BLDG
 SEATTLE WA 98105

**BRINGING THE
TECHNOLOGY
WITHIN EVERYONE'S
REACH**

Sound Workshop

Sound Workshop Professional Audio Products, Inc.
11114 Memorial Parkway, Houston, Texas 77037 (713) 667-8270

*CARL,
HERE ARE SOME
THOUGHTS ON OUR THING!
Michael*

Notes-New Product Release

Audio Machinery Shared Access Memory System

The Audio Machinery Shared Access Memory System approaches digital signal processing hardware from a totally new perspective. The system is built around an active mainframe which contains up to six seconds of Random Access Memory (RAM). The mainframe accepts up to eight plug-in modules that can access all or part of the memory. The memory "distribution" is under microprocessor control. This computer is part of the mainframe, and also keeps track of how much time (at full bandwidth, 16kHz) is available in the memory.

If the amount of time called for by the various modules exceeds the RAM space available, several modes of operation allow for lowering of the sampling rate to accommodate the "time request" (at reduced bandwidth). The sampling rate may be adjusted manually, or the microprocessor can handle it. In either case the processor adjusts the filters to match the sampling rate selected.

Design Parameters:

- availability of long delays (up to 6 seconds)
- exceed present performance standards
- quick setting of delay times
- 1 ms steps plus sweepability
- internal oscillator control of VCO
- external voltage control of VCO
- straight A/D and D/A without companding, compression, or pre/de-emphasis
- cost effectiveness
- eliminate splice clicks inherent in pitch shifting
- true room simulation reverberation with complete control of variable parameters (including width and length of room)

The mainframe contains two readouts which display how much time is available in the memory and at what bandwidth. Three momentary pushbuttons control the operating modes which include computer setting of the sampling rate, manual setting of the sampling rate, and the initial set-up mode. The mainframe also provides 2 audio input busses and 2 voltage control auxiliary busses which are all accessible from each module. The memory "tap" switch bypasses the analog signal input and "taps" the memory being used by the adjacent adjacent module allowing the 2 to be in series without additional D/A and A/D conversion.

Modules available include Pitch/Delay, Delay, Output, Reverberation, and more

Coming Next Month

● In December, we'll take a look at "nuts 'n bolts"—that is, those all-important behind-the-scenes components that no one ever thinks about up-front.

For instance, you've just bought "super-board" and maybe one of those new three-inch (*three?*) tape recorders. What sort of cable were you planning to use? Or weren't you? Perhaps you hadn't given it much thought. After all, how exciting can cable be? It can be quite exciting, if you choose the wrong kind. And of course, out in the studio, someone shows up with a new gadget, with the wrong impedance. Or, as the experts say, "the goes-inta don't work with the goes-outa." What to do? Well, check with us next month for at least a few of the answers.

We'll also have something to say about second-guessing what sort of spare parts you'll need next month. And, we'll take a close look at phase-locked loops. Everyone talks about them, but how many know just exactly what they are?

About The Cover

● This month's cover photo by Robert Wolsch is a catalog of new devices, fast making an appearance in today's state-of-the-art recording studio. On the left, we find three Btx "black boxes"—an Edit Code Synchronizer, Edit Code Reader, and Edit Code Generator. In the center-foreground is an Apple II computer, supporting Panasonic's RQ-212 cassette recorder. The latter is not there by accident—it's all that's needed to store the program generated on the Apple. Sitting on top of the MCI console is a prototype version of Btx's Model 4600 micro-processor-based control system, and just above that, the JVC color monitor displays the first page of a program generated by the computer.

But for more information, see the contents of this issue.



THE SOUND ENGINEERING MAGAZINE

NOVEMBER 1978 VOLUME 12, NUMBER 11

	EDITORIAL	34
A PROPOSED DIGITAL AUDIO FORMAT	Edwin W. Engberg	35
SMPTE TIME CODE COMES TO AUDIO	Bruce Mallion	39
AUTOMATING THE AUTOMATT	John M. Woram	42
THREE GENERATIONS OF AUTO-LOCATORS	Diane Wendt	46
	DIGITAL NEWS BRIEFS	50
A MINI DIRECTORY OF MICRO COMPUTERS		52
	LETTERS	2
	BROADCAST SOUND	6
	Patrick S. Finnegan	
	THE SYNC TRACK	16
	John M. Woram	
	THEORY AND PRACTICE	24
	Norman H. Crowhurst	
	SOUND WITH IMAGES	28
	Martin Dickstein	
	CLASSIFIED	53
	PEOPLE, PLACES, HAPPENINGS	56



is listed in **Current Contents: Engineering and Technology**

Larry Zide
PUBLISHER

Bob Laurie
ART DIRECTOR

Eloise Beach
CIRCULATION MANAGER

Ann Russell
ADVERTISING PRODUCTION

Crescent Art Service GRAPHICS AND LAYOUT

John M. Woram
EDITOR

Hazel Krantz
COPY EDITOR

Lydia Anderson
BOOK SALES

Suzette Fiveash
ASSOCIATE EDITOR

db, the Sound Engineering Magazine is published monthly by Sagamore Publishing Company, Inc. Entire contents copyright © 1978 by Sagamore Publishing Co., Inc., 1120 Old Country Road, Plainview, L.I., N.Y. 11803. Telephone (516) 433 6530. db is published for those individuals and firms in professional audio-recording, broadcast, audio-visual, sound reinforcement, consultants, video recording, film sound, etc. Application should be made on the subscription form in the rear of each issue. Subscriptions are \$7.00 per year (\$14.00 per year outside U.S. Possessions, Canada and Mexico) in U.S. funds. Single copies are \$1.00 each. Controlled circulation paid at Brattleboro, VT 05301. Editorial, Publishing, and Sales Offices: 1120 Old Country Road, Plainview, New York 11803. Postmaster: Form 3579 should be sent to above address.

THE EDITOR:

I read with great interest John Woram's August article, *A Backward Glance at Cardioid Microphones*.

In discussing the old omnidirectional plus bi-directional dual system cardioid microphone, you state: "Two transducers? Now when was the last time anyone saw such a microphone in day-to-day usage? Apparently, a better way was discovered, for today the two-transducer cardioid microphone is pretty much a museum piece. People may still debate the relative merits of moving coils, ribbons, and condensers (electret or otherwise), but there isn't much to argue about when it comes to selecting the optimum number of transducers. We all seem to agree: that number is ONE."

Taken as you intended—applying to the dinosaur design what you state is quite true.

However, there *are* some two-transducer dynamic cardioid microphones currently on the market. These are the

patented AKG "Two-way" cardioid dynamic microphones: the D-200E1, D-202E, and D-224E.

The design concept of the AKG "Two-Way" series is quite different.

If you would like to publish this information, please do so.

GEOFFREY M. LANGDON
Technical Manager
AKG Acoustics
Mahwah, N.J.

Ed Note:

We'll do worse than that. We've asked Mr. Langdon to send us a *complete* story on the theory and practice behind AKG's unique design, and in a moment of weakness, he agreed. We'll have it soon. (Isn't that right, Geoff?)

THE EDITOR:

I have been following the controversy of cleanness vs. loudness in your magazine since the middle of last year.

As an audio engineer involved in radio program production, let me side with cleanness. When I put together a program, I know what I want to accomplish and how to accomplish it. I dislike broadcasters' doctoring our programs. I would even suggest that it may be a matter of moral obligation on the part of broadcasters to reproduce a program with an absolute minimum of processing in order to be faithful to the program producers' efforts to air a clean, quality program.

By processing, I refer to the severe limiting/compression, reverb etc. that the program is frequently subjected to in airing. We produce the program. We have limiters and reverbs. We do to the program what we want done. If broadcasters feel that our programs need more limiting or reverb, or whatever, they should tell us. We'll be happy to make any suggested changes that improve the program.

Regarding limiting to increase loudness, my philosophy is simple. I believe we can attract more listeners through low distortion, high-quality programs than we can by being on the "loudest" station in town. Potential audience size is the same either way and I believe quality does attract listeners on a much larger scale than does loudness.

LEONARD BUDD
Nazarene Communications
Kansas City, Missouri

index of advertisers

ADC	33
Altec	29
Audio Design Recording	22
BGW	23
Bogen	21
Bose Corporation	7
BTX Corporation	26
Clear-Com	14
Crown International	27
dbx, Inc.	15
Eastern Acoustic Works	19
Garner Industries	12, 49
Hammond Industries	8
HM Electronics	10
Industrial Research Products	25
Inovonics	32
J&R Music World	32
Kenwood	4
MCI	Cover 4
Orange County Electronics	11
Orban Associates	16
Otari	31
Panasonic	13
Pioneer	9
Pro-Audio Specialties	30
Recording Supply	24
Robins Industries	24
Sescom	30
Shure Brothers	3
Sony Corp. of America	17
Sound Workshop	Cover 2
Standard Tape Labs	6
Tandberg of America	4, 5
TEAC Corp. of America	Cover 3
Tentel	51
Waters Manufacturing	10
White Instruments	12
Yamaha	18, 20

Introducing the SE-3000 Acoustic Measuring System.

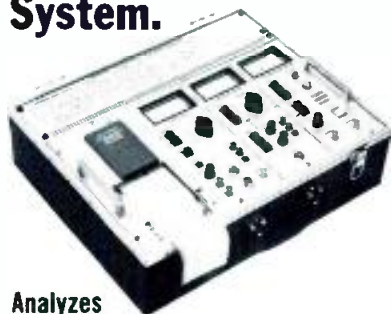

Analyzes sound field characteristics accurately, easily, and quickly.

It measures transmission frequency response from a mix of direct and reflected sound. Reverberation characteristics measured and recorded for each frequency. Also measures sound insulation characteristics and other pertinent information.

The SE-3000 can be used to evaluate the stereo equipment itself: Integrated amplifier frequency response. Tone control and equalizer characteristics. Tape deck and cartridge frequency response. And more.

Please write for complete information.

KENWOOD
 P.O. Box 6213, Carson, CA 90749



sales offices

THE SOUND ENGINEERING MAGAZINE

New York

1120 Old Country Rd.
 Plainville, N.Y. 11803 516-433-6530

Roy McDonald Associates, Inc.
Dallas

Stemmons Tower West, Suite 714
 Dallas, Texas 75207 214-637-2444

Denver

3540 South Poplar St.
 Denver, Colo. 80237 303-758-3325

Houston

3130 Southwest Freeway
 Houston, Tex. 77006 713-529-6711

Los Angeles

500 S. Virgil, Suite 360
 Los Angeles, Cal. 90020 213-381-6106

Portland

2035 S. W. 58th Ave.
 Portland, Ore. 97221 503-292-8521

San Francisco

Suite 265, 5801 Christle Ave.
 Emeryville, Cal. 94608 415-653-2122

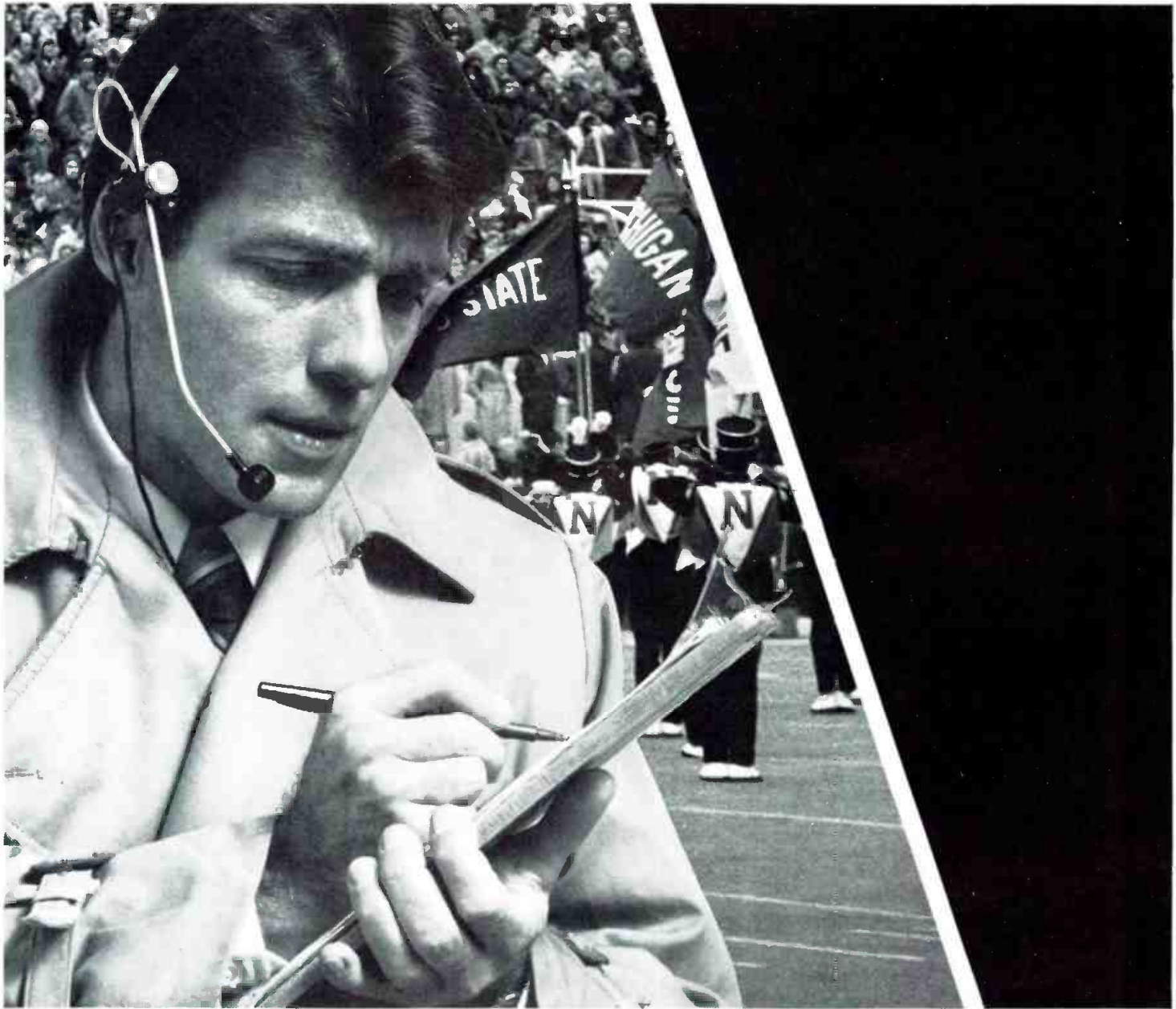

**Next best thing
to a sound proof booth.**

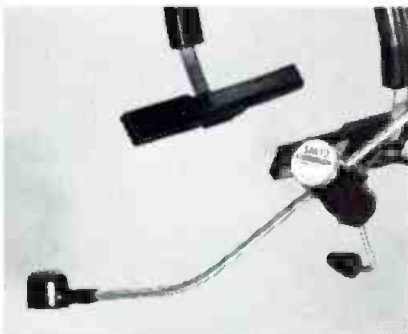

Shure's new headset microphones are coming through loud and clear. With their unique miniature dynamic element placed right at the end of the boom, Shure's broadcast team eliminates the harsh "telephone" sound and standing waves generated by hollow-tube microphones. The SM10 microphone and the SM12 microphone/receiver have a unidirectional pickup pattern that rejects unwanted background noise, too. In fact, this is the first practical headset microphone that offers a high quality frequency response, effective noise rejection, unobstructed vision design, and unobtrusive size.

Shure Brothers Inc.
222 Hartrey Ave., Evanston, IL 60204
In Canada: A. C. Simmonds & Sons Limited



Manufacturers of high fidelity components, microphones, sound systems and related circuitry.

Circle 13 on Reader Service Card

DEPARTMENT OF CORRECTIONS

Perhaps you've been wondering about Figure 5 in Joseph De Angelo's *The Dawn of A.M. Stereo*, in our September issue. Well, so have we. We're wondering what ever happened to the bar graphs that were supposed to be there. Invisible ink, maybe?

Anyway, here's the illustration, as it *should* have appeared in the first place.

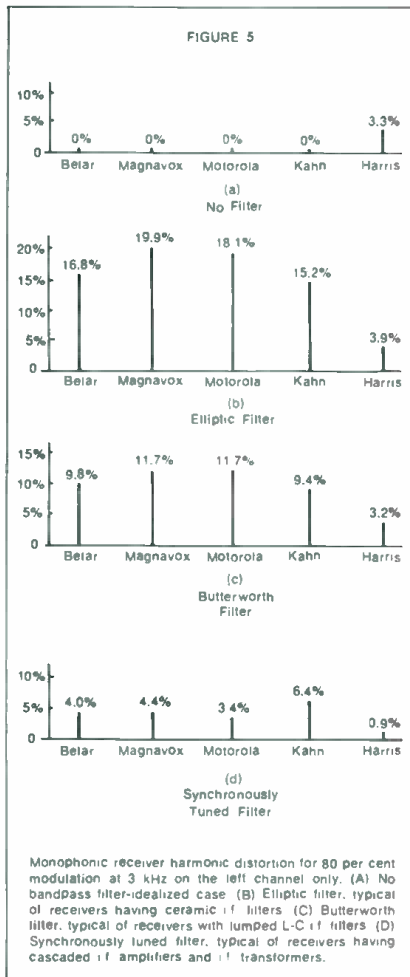

In the same issue, our Dolby F.M. Update feature omitted some very important credits. A major portion of the story was taken from a paper by David Robinson of Dolby Labs. The paper, entitled *Dolby B-type Processing for F.M. Broadcasting; a Progress Report and New Developments*, was read at the International Broadcasters' Convention in London last month. Additional information for our update was supplied by Kevin Dauphinee.

And finally, Howard Roberson's letter to the editor in the October issue was *supposed* to be followed by a note saying that we found several points of confusion in both Roberson's letter, and a reply from Patrick Finnegan, both of which apparently got lost on the cutting room floor.

The point is, how many readers are *really* sure of the proper bias procedure for all tapes at all speeds. If it's X dB over-bias at 10 kHz, at 15 in/sec, what is it at half that speed? Or at double-speed? What do *you* think? Often, the tape manufacturer's spec. sheet is cheerfully vague. So, we're preparing a feature article on the subject for our January, 1979 issue on Magnetic Tape.

Tandberg's New TD 20 A With The Exclusive ACTILINEAR Recording System

Tape recorders can no longer be looked upon as independent units in today's extremely sophisticated sound systems, but rather as components within a total system with performance capability as technically advanced as all other components of that system.

Drawing upon its unequalled 30 year tradition in magnetic recording technology, Tandberg has met this challenge by developing a completely new concept in tape recording known as ACTILINEAR Recording (Patent pending) for their new, advanced open reel and cassette machines.

In conventional recording systems, the summation of record & bias currents in the recording head is done through passive components, leading to inherent compromise solutions. The new ACTILINEAR Recording System is totally free of these compromises, as the passive components have been replaced with an active Transconductance amplifier developed by Tandberg. Just a couple of its many benefits are: up to 20 dB more headroom over any recording system currently available, and the ability to handle the new high coercivity tapes.

In fact, Tandberg's new ACTILINEAR Recording System, when used in conjunction with the soon-to-be-available metal particle tapes now under intense development in the U.S., Japan and Germany, offers performance parameters approaching those of experimental Pulse Code Modulation (PCM) technology, yet is fully compatible for playback on all existing tape recorders. It is literally a machine for the future, with no obsolescence factor, as it can be used with any type of recording tape, available now or in years to come.

Tandberg engineers have mated this new recording system to a logic-controlled, four-motor, solenoidless tape transport of advanced design, which, like the ACTILINEAR concept, is totally unique on the market today.

Other superior features of the TD 20 A include: built-in Sel. Sync. • front panel bias adjustment • front panel 2-position microphone sensitivity switch • frequency-corrected, peak-reading VU meters, with new graphics designed for improved readability • four line inputs + master gain control • a "free" mode + Edit/Cue facilities for easier editing • LED mode indicators • separate power supplies for operational functions and audio functions • rack mount capability • optional wireless, PCM infrared remote control.

Visit your authorized Tandberg dealer for a demonstration of the new TD 20 A deck, and discover how tape recording will be done in the years to come. For your nearest dealer, write: Tandberg of America, Inc., Labriola Court, Armonk, N.Y. 10504.

TANDBERG

Circle 33 on Reader Service Card

db Calendar

DECEMBER

12-14 **MIDCON Electronic Show & Convention.** Dallas Convention Center, Dallas, Texas. Contact: Electronic Conventions, Inc., 999 N. Sepulveda Blvd., El Segundo, Ca. 90245. (213) 777-2965 or (800) 421-6816.

JANUARY

6-9 **Consumer Electronics Show.** Las Vegas Center, Las Vegas, Nevada. Contact: William T. Glasgow, Consumer Electronics Shows, 2 Illinois Center, Suite 1607, 233 N. Michigan, Chicago, Ill. 60601. (312) 321-1020.

Tandberg Presents the Next Generation



Telco Interface

• Many local broadcasts today originate outside the studio and over Telco wire circuits. Wire circuits have their own problems, and these can be intensified or compounded by an improper interface to station equipment. Let's take a look at some of the more common methods of interfacing station equipment to Telco wire circuits for remote broadcasts.

BASIC CIRCUIT

When a circuit is ordered from Telco for a remote broadcast in the local community or adjacent areas, a *broadcast loop* will be provided. This is a two wire, balanced circuit. Each wire of this pair will be very small in diameter (usually a #26 gauge wire), and the pair will be only one of many pairs in a larger cable. None of the circuit pairs are shielded from other pairs in the cable, but are merely insulated from each other by

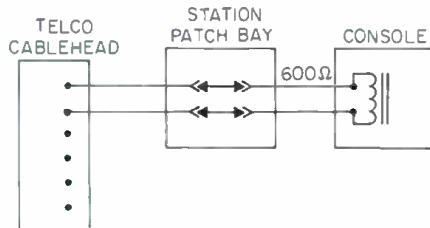

Figure 1. The usual interface at the studio.

a very thin wrapping of paper or plastic. The outside of the large cable itself is shielded by a lead or similar sheath.

Such a circuit immediately presents obvious problems to the transmission of audio program material, the first

of which is the high resistance of the small gauge wire. As longer cables are used, the resistance increases—cable lengths for many remotes are measured in miles. Consequently, there can be considerable loss of signal level. Along with the overall signal level losses are the shunt capacity losses of the higher audio frequencies. The longer the cable, the greater the capacity, and the worse the audio response curve looks. On long cables, audio frequencies from mid-range and up can all but disappear.

Since the pairs are not shielded from each other, crosstalk to and from the other pairs is a constant possibility. Signal levels into the cable (by all users) must be limited, normally to +8 dB maximum, and the telephone company would prefer it a little lower. Not all the crosstalk appears as such; it may appear as noise. This is due to the fact that all pairs in the cable may not be carrying voice signals. There can be a variety of different signals, such as telephone conversations, d.c. or tone pulses for teleprinters or wire news service, ringing currents, touch-tone telephone pulses, telemetry signals from a transmitter or other device being metered by remote control, etc. Besides crosstalk, there can be plain old-fashioned noise and hum. But with all the drawbacks, such wire circuits are being used successfully every day.

COMMON INTERFACE

The most common connection to the remote line is the high-level remote input of the console. Inside the console, this input has a 600 ohm balanced transformer for matching and isolation. A direct connection to the console however, would limit the use of that input, so the circuit normally routes through a jack on the station's patch panel first. Such an arrangement allows for easier testing as well as patching some other equipment to that input when a remote is not planned. Even though the line routes through a jack, when patched up for a broadcast it is essentially a direct connection to the console. Such a connection can allow any undesirable noise or hum on the cable to be routed through the station's audio wiring. If the circuit is 'clean' there is no problem. When it is not, patching the line to an isolation transformer

STL Offers The Most Complete Selection Of Test Tapes Available Anywhere

If you are looking for precision test tapes, look no further. STL can serve all your needs with tapes in 2", 1", 1/2", 1/4" and 150 mil cassette sizes. Alignment, flutter and speed, level set, azimuth and numerous special test tapes are available giving you the most accurate reference possible in the widest ranges of formats. Also available is the authoritative Standard Tape Manual, a valuable data book for the audio tape recordist, engineer or designer. This practical and much-needed reference source is compiled by Robert K. Morrison, an international authority in this field. The price of this book is \$45.00 prepaid.

Write or phone for fast delivery and further information.

STL STANDARD TAPE LABORATORY, Inc.
26120 Eden Landing Road / #5 / Hayward, CA 94545
(415) 786-3546

Introducing the Bose® 802.



So far advanced in materials and technology, it makes other professional speaker systems obsolete.

Feature for feature, the new Bose 802 incorporates more significant improvements in design and performance than any other professional speaker system on the market today.

The high-impact cabinet is the toughest enclosure we could make. Built to take the drops and knocks of hard, on-the-road use, yet is amazingly light. Comfortable recessed handles make it easy to carry a pair. Integral rails and grooves allow stable stacking.

One-piece multipurpose cover serves as stage pedestal, monitor cradle, and storage compartment for equalizer, spare fuse and mounting screws.

The all-new drivers feature edge-wound aluminum voice coils for greatly improved efficiency and power handling. The eight drivers are mounted on four separate panels to improve smoothness of dispersion, putting more sound directly out front.

Unique dual reactive air columns provide greatly increased bass output with lower distortion.

The new active equalizer has both balanced and unbalanced inputs. And its new output circuit will drive 600-ohm lines.

The new Bose 802 is powerful. Tough. Easy to set up, easy to carry. And, its unique contemporary styling sets it apart from all others.

But best of all, its sound is Bose. Clean, accurate, full. A sound which tells you that any other professional speaker you may want to look at is now probably obsolete.

BOSE®

Bose for Pros.



For full information on the whole Bose Pro Products line, fill out and mail this coupon to:

Dept. SE
Bose Corporation
The Mountain
Framingham, MA 01701

Name _____

Street _____

City _____

State _____ Zip _____

Tel. () _____

db November 1978

At Last, an Equalizer that Comes Clean...

Up until now, whether you tried to equalize your control room or contour your sound system for a concert hall, the end result was an increase in distortion.

That was yesterday.

Klark-Teknik equalizers are built for today, for tomorrow. Uncompromised. Unequaled.

If your livelihood depends on good clean sound, depend on us.

After all, if you're using yesterday's equipment, will you be ready for tomorrow?

Write to Hammond Industries Inc., 155 Michael Drive, Syosset, New York 11791 or call (516) 364-1900.

MODELS:

DN27: 1/3 octave mono, with bypass switch & gain control. **\$765**

DN22: 11 band, stereo, with high & low pass filters, separate gain controls & bypass switches. **\$815**

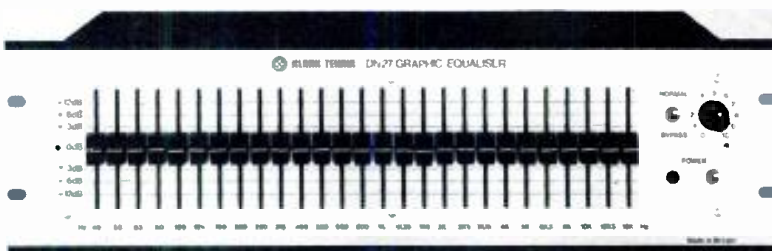

SPECIFICATIONS:

INPUT IMPEDANCE: Unbalanced, 10K ohms nominal. **OUTPUT IMPEDANCE:** Unbalanced, less than 10 ohms, short circuit protected. **OPERATING LEVEL:** -20 dBm to +24 dBm; input protection 60V RMS. **CENTER FREQUENCY ACCURACY:** $\pm 2\%$. **CALIBRATION ACCURACY:** ± 0.5 dB. **FREQUENCY RESPONSE (CONTROLS FLAT):** ± 0.5 dB : 20Hz to 20kHz. **OUTPUT CLIPPING POINT:** +22 dBm into 600 ohms load. **DISTORTION:** Less than 0.01% ... 1kHz at +4 dBm into a 600 ohms load; less than 0.05% ... 20Hz to 20kHz at +18 dBm into a 600 ohm load. **EQUIVALENT INPUT NOISE:** Less than -90 dBm unweighted, 20Hz to 20kHz.



KLARK-TEKNIK

A Member of the Hammond Industries Group

The Sound of Today.

Circle 19 on Reader Service Card

broadcast sound (cont.)

mounted in the patch bay will often remove or lessen any problems that could develop.

When a station does a considerable number of remotes, especially during certain periods of the year such as the basketball and football seasons, it is more advantageous to wire several jacks in the patch bay to a terminal board in (or next to) the Telco incoming box. How many to use depends upon the number of permanent remote lines in use as well as the peak number of temporary circuits anticipated. This method allows for easy cross-connection from station circuits to Telco pairs as they are assigned. Whenever a cross-connection is made, take special care not to "split pairs" on the Telco terminal board. This is often very easy to do, and it can raise all sorts of problems with hum, crosstalk and noise in the program circuit. The term "splitting pairs" means that you get one wire from the station equipment onto one of the assigned pair wires, and the other wire from the station equipment onto a wire of an altogether different Telco pair.

AT THE REMOTE END

Telco will ordinarily terminate their wiring on a terminal block at the position designated by the station, or the individual you name as the "contact" at the remote location. The most simple and common interface here is a pair of wires from the output terminals of the remote amplifier to the two audio wires on the connecting block.

Some amplifiers have more than one pair of output terminals. These are for different purposes and are at different impedances. The 600 ohm balanced output must be used to connect to the Telco line. The line is a 600 ohm balanced circuit, and if an unbalanced output of the amplifier is employed, or if one side of the bal-

Figure 2. A better arrangement to keep unwanted noise and signals out of the studio wiring.

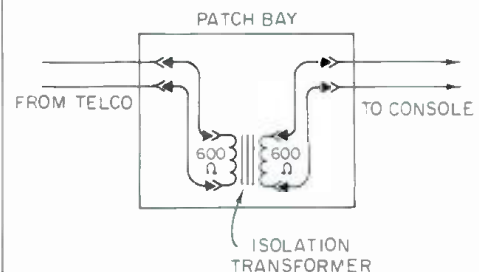

THE NEW TAD* DRIVER, IT GIVES YOU MORE BY GIVING YOU LESS.

The new one-inch TAD driver is truly unique. There is nothing else like it. Use it with your favorite horn and you'll get a frequency response from 800 to 22,000 Hz. So one speaker does the same job it used to take both a tweeter and super-tweeter to do. Saves weight. And money.

The secret is the TAD driver's beryllium diaphragm.

The diaphragm is the heart of a driver. It must be both light yet rigid. We used beryllium to achieve a standard of performance never before known to the professional. Every single tone — no matter how subtle or how complex — is captured and reproduced just the way it is played or recorded. The resulting sound is a revelation.

The quality of both parts and workmanship, plus the same care in assembly given a fine watch, makes the TAD driver a new standard for the entire industry. It allows the driver to reproduce frequencies up to 22,000 Hz without any major drop-off in response and permits it to withstand high input power.

If your job involves professional sound reproduction — on stage, in concert halls, in clubs or studios — you have an obligation to yourself to hear this remarkable driver.

With the arrival of the TAD driver the state of the art just took a quantum leap.

TAD Technical Audio Devices

A Division of U.S. Pioneer Electronics Corp.
142 Redneck Avenue, Moonachie, New Jersey 07074
Telephone: (201) 440-8234

TO: Technical Audio Devices db
142 Redneck Avenue
Moonachie, New Jersey 07074

Please send technical data for the TAD product line. (Dealer inquiries also invited.)

NAME _____ (Please Print)

TITLE _____

COMPANY _____

DIVISION _____

ADDRESS _____

CITY _____

STATE _____ ZIP _____

PHONE (_____) _____ EXT. _____
Area Code

TAD is an abbreviation for Technical Audio Devices, the professional products division of U.S. Pioneer Electronics Corp.

Circle 21 on Reader Service Card

Take a Waters slim-line space-saver

New MM thin-line faders are great for small portable mixers or lighting consoles. Only half the width of conventional faders, our 3/4-inch wide MM series lets you build a lot of mixing or control capability into a limited space. No performance compromise, either. You get Waters' proprietary MystR[®] conductive plastic resistance elements. Glass-hard. Smooth. Long-lasting. You get Waters' computer-controlled curve shaping for highest tracking accuracy. And, you can choose 2 3/4-inch or 4-inch travel; 600 ohm or 10,000 ohm impedance; linear, audio, or true log characteristic. For complete information, circle the reader service card, or call Don Russell at (617) 358-2777.



WATERS MANUFACTURING, INC.
LONGFELLOW CENTER, WAYLAND, MA 01778

Circle 20 on Reader Service Card



The new name for professional RF wireless microphones

Only the name is new. You will recognize the picture as the same field proven system that has gained universal acceptance in the industry under the label of the leading professional microphone manufacturer. But now this fine product is available from the people who engineered and built it: HM Electronics, Inc.

The System 22 is HME's top-of-the-line VHF Hi Band wireless microphone intended for

h m e

HM ELECTRONICS, INC.

use by professionals. Critical adjustments can be made by the audio engineer such as soft compression, transmitter power (can be switched to legal maximum), and internally supplied power for Electret microphones.

To learn more about the System 22 or our new executive and universal lines call or write HM Electronics, Inc. 6151 Fairmount Avenue, San Diego, Ca. 92120 Ph. (714) 280-6050

Circle 14 on Reader Service Card

broadcast sound (cont.)

anced output and ground terminal is used, the Telco line will be grounded on one side and become unbalanced. The most typical result of such an error in connection will be hum on the program circuit, but there can be an increase in noise and crosstalk also.

Another termination practice some local Telcos are now employing is utilizing a jack instead of the connecting block. This is the same jack that is used for portable extension phones in homes (the delicate type). If your local Telco has begun this practice, make sure they supply your station with a couple of cables that have the correct plug attached. Carry these in the remote bag—don't depend upon finding them at the remote site.

KEEPING TABS

Telco makes use of either of two methods to keep tabs on the fact that the circuit is still intact prior to the broadcast. One method is to hang a small, battery operated oscillator across the line at the remote site. The batteries last only a couple of days and then go dead. The one who sets up the station equipment at the remote site should disconnect this oscillator before he connects up his equipment. If that little oscillator is still singing, it will be in the background of the program audio. The other method is to attach a 10k resistor across the audio terminals of the connecting block. By use of an ohmmeter or resistance bridge, the Test Board can determine whether the circuit is still intact. If this type is used, the announcer *should not* disconnect the resistor. The 10k resistance is bridging and has no effect on the program or the circuit impedance.

VOICE COUPLER

Another very common method of doing longer distance remotes has grown in popularity in recent years.

Figure 3. Splitting pairs can cause many problems. Shown here is what is meant by the term. A station audio pair has been connected to two entirely different Telco pairs.

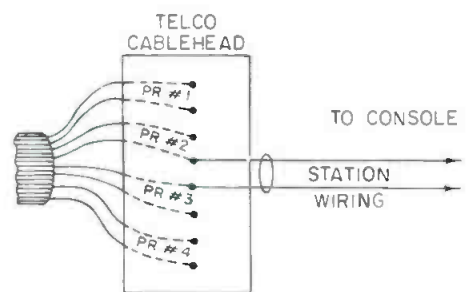

(WRONG)

Stressing Quality

Orange County Electronics, creators of fine professional audio products for over a decade, introduce the new VS-1 Stressor. The VS-1 combines the separate functions of a compressor with adjustable ratio, threshold, and attack and release times, a fast peak limiter with 250:1 slope, and a highly functional expander/noise-gate, and a full parametric equalizer, all in one beautiful 3½" rack mount.

This complete signal processing system gives you the power to handle problems such as level control, noise, and equalization in one package. These necessary processing functions are designed to work independently or in tandem with one another. For example, with the selection of one button which handles routing chores, the parametric equalizer can be inserted before, after,

or in the side-chain of the compressor. When in the side-chain mode, you have a frequency-sensitive compressor or dynamic equalizer, which can deal with sibilance problems on vocal tracks as a "de-esser."

The Orange County VS-1 Stressor is built to high technical standards and offers switchable balanced/unbalanced operation, with fully modular construction for easy service and performance flexibility, and noise and distortion specs equal to the best in the industry.

Applications for the VS-1 Stressor include recording studios, AM broadcasting, TV and broadcast production, film sound, and sound reinforcement. Quiet, powerful, and extremely versatile, the VS-1 Stressor belongs in your studio or station today. And for smaller studios or stations who want the fine sound of the VS-1 but don't need the full flexibility, try our VS-2 Stressor, which offers internally pre-set functions.



ORANGE COUNTY ELECTRONICS
INTERNATIONAL INC.

Exclusive Sales & Marketing:

Parasound

680 Beach Street, San Francisco, Ca. 94109 (415) 673-4544

Dealer Inquiries Invited

1 6 OCTAVE



SERIES 4300 ACTIVE EQUALIZERS

A new standard in equalizers!

- 28 ONE-SIXTH octave bands from 40 Hz through 894 Hz on and between I.S.O. one-third octave centers
- 13 one-third octave bands from 1000 Hz through 16 kHz on I.S.O. centers.
- 10 dB boost or cut on continuous, calibrated, Mil-Spec controls
- Equal Q in both boost and cut conditions
- Precision inductors in magnetically shielded enclosures for maximum hum rejection
- Noise guaranteed — 90 dBv or better
- Accessory socket to permit insertion of 12 dB/octave or 18 dB/octave low-level crossover networks for bi-amping or tri-amping
- Mid and high frequency output trimmers accessible from front panel
- Input attenuation control variable to 20 dB of attenuation accessible from front panel
- Variable high-pass filter 20 Hz through 160 Hz, 12 dB/octave
- Security cover

ONE SIXTH OCTAVE REAL TIME ANALYZERS AVAILABLE.

White

instruments incorporated
P.O. BOX 698 AUSTIN, TEXAS 78767
512/892-0752

Circle 40 on Reader Service Card

Perfection in duplicating.



The Garner 1056 High Speed Professional Tape Duplicator.

You'll get perfect dubs time after time with Garner's common capstan drive. It drives the master and 5 slaves at consistently the same speed. And Garner uses only glass bonded ferrite recording heads—which outwear ordinary metal heads 10 to 15 times. In addition to quality and accuracy, the 1056 is fast—2 minute tape loading and 60 ips duplicating speed. The 1056 has a 3-year mechanical and a 1-year electronic warranty. Garner is the choice of professionals. You'll see why.



Look to Garner for quality electronic audio and video products. For more information write or call:

GARNER INDUSTRIES

4200 N. 48th St., Lincoln, NE 68504
Phone 402-464-5911

Circle 38 on Reader Service Card

broadcast sound (cont.)

Its cost factor is (or can be) higher than that of a broadcast loop. This is the voice coupler or QKT circuit. In essence, this is nothing more than a private-line business phone at the remote location, provided by the telephone company in that community. Along with the phone instrument, a coupler is provided. The coupler contains a transformer, isolating capacitors, and resistors for improving the impedance match, plus a jack to accept the output of the station's remote amplifier. Unless you want the handset of the phone lying there picking up noise or other voices during the broadcast, better order the instrument with either a push-to-talk switch or an exclusion key. To originate a broadcast, the announcer simply dials the station's regular phone number (or one the station has assigned) and establishes contact, works out any cues etc. Without breaking the connection, he lets go of the switch or turns the exclusion key to the amplifier position and does the broadcast. The entire broadcast is done as a long distance phone call.

Remember that this *is not* a broadcast loop. At the station, a connection must be made to the circuit of the phone number that is called. Most stations have more than the main number but all are on a rotary system. They often have an unlisted number. On the rotary system, you still must connect to the correct number to get on the air with the broadcast. A simple interface connection can be made to the desired pair in the Telco box with a 1 MFd (paper) series capacitor in each side of the line for d.c. isolation, followed by a 600 ohm transformer for impedance match and a.c. isolation. The local phone instrument should have a push-to-talk switch or a "hold" button.

EQUALIZED LINES

Since the basic wire circuit has such a poor bandpass, it is acceptable

Figure 4. Troubles will develop at the remote site unless the remote amplifier is properly connected to the line. Use only the balanced output of the amplifier and connect it to the red and green wires in the Telco line.

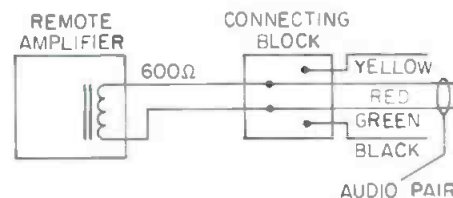

Introducing the system that can tape itself. Tune itself. All by itself. For up to a week.



Up to now using a tape deck to record Tchaikovsky's 4th at 4 PM on one station and Beethoven's 5th at 5 PM on another was easy. As long as you were home. Now Technics makes it just as easy when you're not, with the ST-9038 quartz synthesizer FM stereo tuner and its matching SH-9038 microprocessor.

When used with the ST-9038, the SH-9038 microprocessor can be programmed to tune eight FM stations in any order, at any time, on any day for one week. In fact, the SH-9038 can be programmed to remember 32 individual steps. Starting with the day of the week, the time, the FM station and AC line on/off.

All you do is simply select the "write" mode and the SH-9038's computerized memory does the rest. Then select the "read" mode for a readout of the programs you have selected. You can also override your preselected program by switching to the manual mode. What's more, the SH-9038 can be programmed to turn on or off three other components in addition to the ST-9038 tuner.

That's what the SH-9038 microprocessor can do. What the ST-9038 quartz synthesizer tuner can do is just as impressive. Unlike conventional tuners which use a series of variable capacitors to tune in FM frequencies,

the ST-9038 uses the quartz synthesizer tuning system. With this system the quartz crystal, one of the world's most accurate reference devices, becomes the reference for the local oscillator frequency and the broadcast frequency. The results: Only the frequencies on which a broadcast signal might exist can be received. At precisely spaced 200 kHz steps. And that means you don't have to worry about drift or misalignment due to temperature, time or mistuning.

The SH-9038 microprocessor and the ST-9038 tuner. Because you can't beat the memory of a computer or the accuracy of quartz.

SENSITIVITY: 1.2 μ V (75 Ω), 50dB QUIETING
SENSITIVITY (New IHF): Mono 18.1 dBf. Stereo 38.1 dBf.
THD (100% modulation): Mono 0.1%. Stereo 0.15%.
FREQ. RESP.: 20Hz to 18 kHz +0.1dB -0.5dB. SELECTIVITY: 75dB.
STEREO SEPARATION: 45dB (1 kHz), 35dB (10 kHz).
IMAGE REJECTION AT 98 MHz: 105dB.

Technics SH-9038 and ST-9038. A rare combination of audio technology. A new standard of audio excellence.

Technics

Professional Series

Circle 34 on Reader Service Card

broadcast sound (cont.)

only for voice communications, data, or similar transmissions within its usable bandpass. There are many occasions when a better grade line will be required. When Telco lines are used as the studio-transmitter link for example, then these must have a flat response from at least 50 Hz to 15 kHz or the station can't meet FCC proof-of-performance. The basic line can be upgraded by the use of equalizers.

The equalizer, then, is another very common interface to Telco lines. The station can order the grade of line it requires according to the listing in the Telco Tariff. In this case, the telephone company supplies the equalizers and also does the equalization. These cost more than the basic lowest grade line, so many stations order the low grade line and do the equalization themselves. The majority of these circuits are normally used for telephones, so Telco has loading coils at about one mile intervals along the circuit. These are series inductances which perform a degree of equalization from about 300 Hz to about 3200 Hz. With these coils in the line, it cannot be equalized above

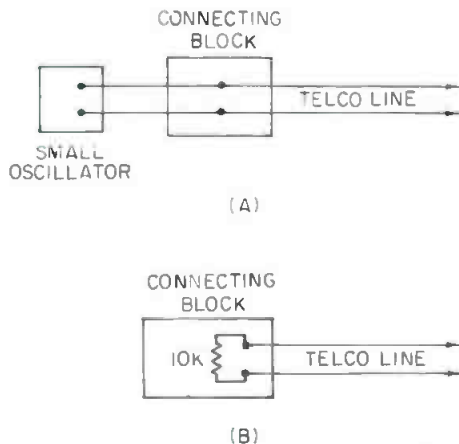

Figure 5. Two methods Telco uses to keep tabs on whether the line to the remote site is still intact. Shown in (A) is the oscillator method and in (B) is the resistor method.

3200 Hz—regardless of what you try with the equalizer. A broadcast loop is not supposed to have these coils in it, so Telco must take them out if you want to equalize it. If you don't intend to equalize and the remote will only be talk or a voice type of programming, the coils provide a better line for the purpose.

OTHERS

An average station will have a whole variety of Telco interface units in operation besides the more common ones we have discussed. Some will be for program purposes—for example, sports or national networks, or perhaps a network feed for an SCA channel on the f.m. transmitter. In the non-audio area, there may be interfaces for news and weather teleprinters, computer data terminals, data and remote metering and telemetry for a remote-controlled transmitter, burglar alarm system, and so forth. For the majority of local program remotes with wire circuits, the more simple forms of interface will be used on most occasions.

RECAP

The use of Telco lines for remote broadcast is growing. These lines have problems that can degrade the program audio, and unless we use the proper interface, the problems can become worse. Use of an isolation transformer at the studio can solve some of the incoming problems or reduce their severity. If we want a better grade line, then we can order it that way or equalize the lower grade line ourselves. ■

YOUR PRODUCTION DEPENDS ON OUR PERFORMANCE

VERSATILITY

We have achieved a degree of excellence recognized World Wide in the field of intercom systems.

Exceptional sound quality is achieved with our contoured frequency response (200 Hz to 12,000 Hz) and new audiometric type Series II headsets. Noise cancelling microphones and high output (112 dB) noise attenuating headphones insure communications under the most demanding conditions. Our Stainless Steel Belt Pack with State of the Art encapsulated electronics assures long life and reliability. Our belt pack will withstand a 60 foot drop to concrete.

QUALITY

- 1, 2 & 8-channel stage manager control stations.
- Over 200 remote station capability with 8-channel switchboard.
- Visual signaling between stations.
- Interconnects with standard 2-conductor shielded microphone cable and adaptable to other communication systems including telco lines.
- Catalogue with complete specifications available upon request.

 **Clear-Com**
intercom systems

759 Harrison St., SF, CA 94107 (415) 989-1130

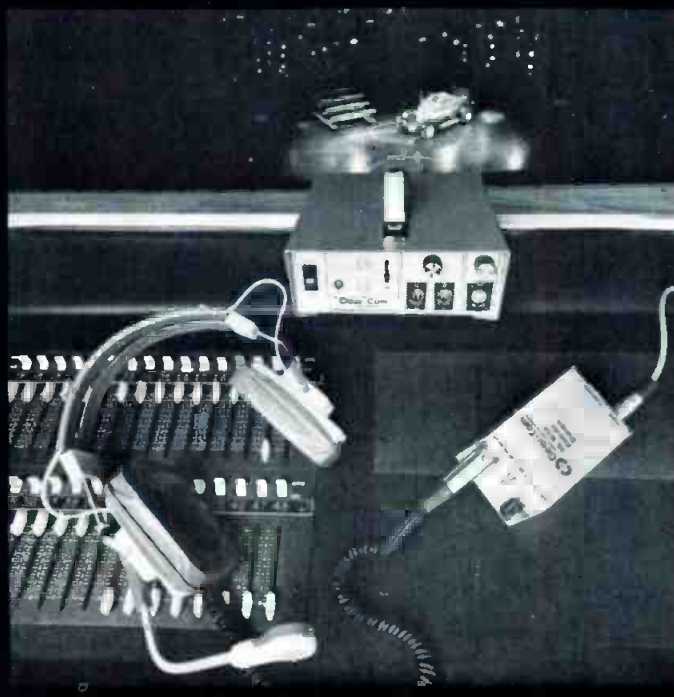

College of Marin Fine Arts Theatre, Larkspur, Calif.

HUSH MONEY.

The dbx 208 tape noise reduction system is a new product that will impress both your engineering staff and your accountant. The 208 features 8 channels of simultaneous noise reduction on plug-in modules, plus a spare, all in a compact 5¼" rack mount package.

dbx noise reduction is rapidly becoming the new industry standard because it provides 30 dB noise reduction and 10 dB headroom improvement, from 20 Hz to 20 kHz, without the problems of other systems. The dbx system does not require critical and time-consuming level-match adjustments. Its true RMS detectors are not sensitive to tape recorder phase shift. Its voltage-controlled amplifiers (VCAs) operate over a 100 dB range. Overall the dbx system provides a level of performance and a simplicity of operation that is unsurpassed.

But the 208 is also a great value. It is priced at \$3300. That's \$6600 for your 16-track and \$9900 for your 24-track.* And no matter how complex the future becomes, the 208 system expands simply and economically.

The dbx 208. The easy solution to your noise problems, today and in the future.

dbx, Incorporated,
71 Chapel Street
Newton MA 02195
617-964-3210



dbx

UNLOCK YOUR EARS

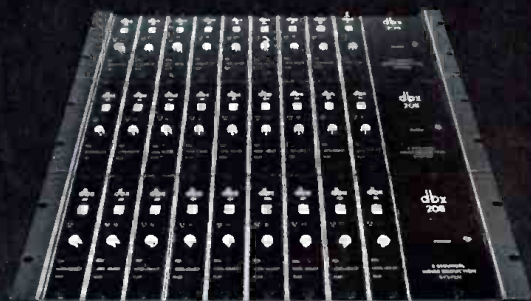

*Nationally advertised value.
Actual prices are set
by dbx dealers.

Circle 44 on Reader Service Card

db The Sync Track

Back to Basic Basic

● If you've had any lingering doubts about the direction in which the world of audio is moving, this issue of *db* should certainly help remove them. Digital technology and automation systems of one sort or another are springing up all over the place, as our various feature articles point out. And, with the exception (so far) of microphones and loudspeakers, there's hardly an audio device left that hasn't been touched by the new technology.

Like every other issue of *db*, this one has been in the planning stages for many months. And, as it happens, I've been involved in putting these things together. So, I got in on the ground floor in assembling this issue. Or rather, I got tossed into the basement. For, as the issue slowly took shape, one thing became crystal clear to me; I don't know what the hell is going on anymore!

Since I'm supposed to be the editor, this is not a very comforting position



Inside the Apple II Computer

to be in. I've always been told that editors know everything (mostly by the previous editor, who has recently escaped into the carefree world of publishing).

Well, on the off-chance that he's right, I set out to learn—if not everything—at least a little something about computers, digital audio, and all that stuff. But, how does one get started? Of course, if you've got all sorts of cash lying about, you can dash out and pick up the latest automated console, and then come home and try to figure out how it works. Or, you can proceed with caution, and get your feet wet first, before diving in over your head. After reviewing my check book, I decided on the latter course of action.

SMALL COMPUTERS

At about the time my thinking had progressed to this point, I found my-

The Parametric with Experience...

See us at
AES Booth 28

The Orban 622 Parametric Equalizer is a highly refined second generation design. It includes the features which make a professional's life easier: overload monitoring, RF suppression, balanced inputs (with a balanced output option), 115-230 volt AC power supply, "Constant-Q" curves (use the equalizer as a notch filter too!) and a host of others.

Your Orban Dealer can show you why the Experienced Parametric is the professional's choice. Ask him for a brochure with the complete 622 story and our "How to Choose Equalizers" booklet.

orban

Orban Associates, Inc.
645 Bryant Street, San Francisco, CA 94107 (415) 957-1067

Our microphones are more often heard than seen.

We really don't have to broadcast the virtues of our equipment.

Especially if you've ever broadcast on our equipment.

Infact, go into almost any professional facility, and it'll be easy to spot Sony. With one exception:

Our miniature omni-directional electret condenser mike. The ECM-50PS is so small, you'd never expect such big performance. Yet this tie-tac microphone offers a wide frequency response, with full coverage from any direction.

On your visit you'll also come across the Sony C-37P. This is a professional condenser mike that's at home on stage or in studios. This versatility is enhanced by a selector switch that lets you go from omni to uni-directional. And thanks to FET circuitry, the 37P boasts a remarkably wide dynamic range, allowing sound pressures of up to 154 dB.

With the ECM-56F, Sony moves in the direction of a uni-directional condenser microphone. Offering Sony's exclusive Back Electret design, this unit combines a wide frequency response, with uncanny smoothness.

The Back Electret also sets the ECM-53FP ahead. The microphone: a flexible Cardioid for desk or podium.

The Sony C-74 microphone (not pictured), is a gun-type. You'll often see it at news conferences, where loaded questions are asked. This uni-directional condenser microphone is acknowledged as the standard in its category.

It's no stranger to theatres, sound stages, large halls and television studios. When you can't get proximity, make sure you're not at a distance from Sony.

Sony's line of microphones is as complete as you'll find anywhere.

But it also has Sony's disciplined quality and on-going perfectionism. Which you won't find anywhere.

SONY®

© 1978 Sony Industries, A Division of Sony Corp. of America, 9 West 57 Street, New York, N.Y. 10019. Sony is a trademark of Sony Corp.



Circle 26 on Reader Service Card

self at the Las Vegas Consumer Electronics Show. Lo and behold, down on a lower level, I discovered the wonderful world of small computers. I also discovered the wonderful world of small computer people, who speak an alien tongue. Or rather, they type an alien tongue. Superficially, it resembles English, although it certainly was no Shakespeare who typed:

```
100 GR
110 XOLD = PDL (0)/7
120 YOLD = PDL (1)/7
130 COLOR = 2
140 PLOT XOLD, YOLD
150 XNEW = PDL (0)/7
160 YNEW = PDL (1)/7
170 PLOT XNEW, YNEW
180 IF XNEW=XOLD THEN
    COLOR = 0: PLOT XOLD,
    YOLD
190 IF YNEW=YOLD THEN
    COLOR = 0: PLOT XOLD,
    YOLD and so on.
```

This is the sort of deathless prose that brings a lump to the throat of a computer programmer and heartburn to everyone else. Obviously, these lines must mean something, or else why would a band of otherwise normal-looking people be standing around typing such nonsense and gazing thoughtfully at t.v. monitors that dutifully printed every word—or whatever those things are called.

And then, inspiration struck. If I could get one of these computer folks to solve a simple audio problem, maybe I would be on my way towards figuring out what was going on! And so, I made the rounds, asking a reasonably simple question; "If two cardioid microphones are placed back-to-back, and their outputs are combined, what is the resultant polar pattern?"

Aha! Now I had them on the run! Cardioid? Polar patterns? Speak English, please! Well, I thought I was, but then, they thought they were too. Obviously, different dialects, but I wasn't getting anywhere.

AN APPLE TO THE RESCUE

Finally, I wandered into the Apple Computer, Inc. exhibit, dragging along my problem. Here, I encountered Phil Roybal, the company's product manager, who did not seem to get upset with my dialect. In fact, the Apple people had not only heard of audio, but Jef Raskin—the publications manager—is a card-carrying subscriber to—yes!! db!

In a moment's time, my problem was typed into the Apple computer, and polar patterns began appearing on the monitor screen. And in color, no less. First, there was a cardioid pattern—then another one in the opposite

direction. And finally, a circle; that is, the omni-directional pattern that occurs when two cardioids are placed back-to-back.

I was home free! Why, all I had to do was figure out what they did, and I could do it too. And then I could invent new problems and in no time become a computer-programming genius.

Well, that was many months ago, and I'm still no genius at programming. But, I'm getting better with every passing day. I've acquired my own Apple computer, and actually programmed the color display you see on the JVC color monitor on this month's cover. Believe it or not, it wasn't that difficult. I worked out the program at home, stored it on a standard Ampex audio cassette—using the inexpensive Panasonic recorder also seen on the cover. At Soundmixers Studio in New York City (the big Apple, that is), the program was loaded back into the computer, and dutifully appeared on the screen.

Once in the computer, the program will be stored indefinitely, or until someone pulls out the power cord, whichever comes first. That's what makes the cassette, or some other storage medium, handy. You can hold on to your programs safely.

Well, this little exercise probably won't be recorded in the history of

The strong, silent type.



Just one glance at the Yamaha P-2200 power amp tells you the whole story. The case, the handles, the whole exterior relate a single, powerful message—rock-solid reliability, stability and high performance. The P-2200 is no hi-fi retread. It's designed for a wide variety of professional applications.

Strong! With 200 watts of continuous average sine wave power into 8 ohms, you've got plenty of punch to handle the high peaks essential to clean studio monitoring, as well as all-night cooking in "live" concert reinforcement or disco sound systems. (You can easily

convert it into a monaural super amp and/or 70-volt line output capability for distribution systems.)

Silent! With a 110dB S/N ratio and .05% THD from 20Hz to 20kHz, the P-2200 satisfies even the most critical ears.

How pro can you go? The P-2200's dB-calibrated input attenuators and 50dB peak reading meters are flush mounted. Inputs to each channel have XLR connectors with a parallel phone jack, plus a phase reversing switch. Speaker connectors are live-way binding posts that take wire or "banana" plugs.

There's not enough room to give you all the facts here, so send this ad along with six dollars. (Please, certified check or money order only. No cash or personal checks.) We'll send you the P-2200 operation manual filled with facts. Or better yet, see your Yamaha dealer.



YAMAHA

Musical Instrument, Combo Division
6600 Orangethorpe Avenue,
Buena Park, CA 90620.
Write: P.O. Box 6600, Buena Park, CA 90622

EASTERN ACOUSTIC WORKS ANNOUNCES A NEW CONCEPT IN PORTABLE SOUND REINFORCEMENT

THE CT SYSTEM

PREMIERING AT THE NEW YORK A.E.S. CONVENTION

THE CT SYSTEM IS A COMPLETE, PACKAGED SPEAKER SYSTEM THAT OFFERS SUPERIOR PROJECTION, SOUND QUALITY, DEFINITION, PORTABILITY, AND STRUCTURAL RIGIDITY. THE COMPONENTS OF THE CT SYSTEM ARE INDIVIDUALLY PACKAGED ALLOWING THEM TO WITHSTAND THE RIGORS OF ON THE ROAD ABUSE FOR YEARS. WHEN STACKED IN A VERTICAL ARRAY THEY CAN BE FLOWN AS ONE PIECE AND MAINTAIN TOTAL STRUCTURAL INTEGRITY. THIS PRECISION VERTICAL ARRAY FEATURES HIGH ACOUSTIC OUTPUT AND LOW DISTORTION THROUGHOUT THE ENTIRE AUDIO BANDWIDTH.

EACH COMPONENT OF THE CT SYSTEM IS CAREFULLY TAYLOR-ED FOR IT'S SPECIFIC APPLICATION, OF WHICH THE EASTERN ACOUSTIC WORKS' MODEL MR-109 MID BASS HORN AFFORDS A GOOD EXAMPLE. THE MR-109 CONTAINS ONE ATC PA-75-234 DRIVE UNIT WHICH IS MOUNTED ON A LEAD REINFORCED FIBERGLASS HORN FLAIR. MACHINED INTO THE DRIVE UNIT IS A PHASING PLUG TO MINIMIZE CANCELLATION AT HIGHER FREQUENCIES. THE BALTIC BIRCH SEALED COMPRESSION CHAMBER/ENCLOSURE PROVIDES THE ULTIMATE IN ROADIE PROTECTION.

THE COMPLETE EASTERN ACOUSTIC WORKS' CT SYSTEM WILL SOON BE AVAILABLE FROM A SMALL GROUP OF DEDICATED DEALERS THROUGHOUT THE UNITED STATES.

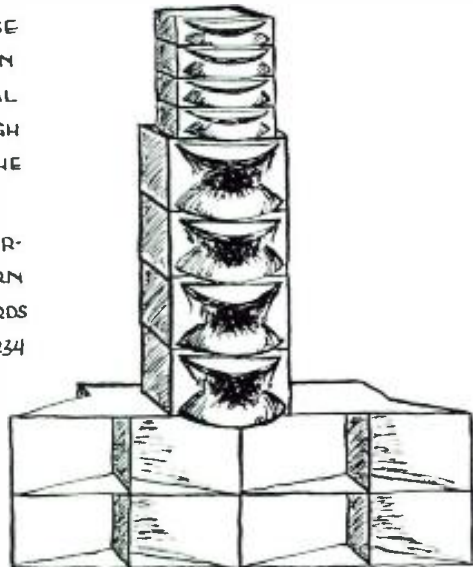

QUANTUM AUDIO
200 PARK AVENUE SOUTH
NEW YORK CITY, NY 10003
(212) 260-2500

FRED LOCKE PRO AUDIO
62 WOODLAWN ROAD
BERLIN, CT 06037
(203) 828-1124

WAH SOUND
1115 R STREET
SACRAMENTO, CA 95814
(916) 444-5491

E.U. CO. PRO
360 NEWBURY STREET
BOSTON, MA 02116
(617) 261-8144

DIMENSION 5
100 NORTH 17TH STREET
PHILADELPHIA, PA 19103
(215) 568-1545

24 NORTH 3RD STREET
WOMELSDORF, PA 19567

SOUND GENESIS
445 BRYANT STREET
SAN FRANCISCO, CA 94110
(415) 285-8900

 *eastern acoustic works inc*
who else would you trust

59 fountain street, framingham, ma 01701 see us in suite 1270 at the a.e.s. convention

Circle 17 on Reader Service Card

computer programming, but it did prove to me that programming is not necessarily the black art that it sometimes appears to be. I'm still a long way from solving all my audio problems, but I'm working on it, and will report back from time to time on my progress.

By now, I've probably lost the attention of the entire AES digital standards committee, but I suspect there are a lot of readers out there who are just as knowledgeable about computers—and digital technology—as I am. So, if I can figure out what it's all about, perhaps these readers will get something out of my adventures at the computer keyboard.

MORE ABOUT THE APPLE

Obviously, I'm no authority on computers, so my comments on the Apple are not the definitive word on the subject. But, I'll pass them on for the benefit of others who are as well informed as I was.

First—I'm impressed! The entire computer is seen in the photo accompanying this column. There's no rack-full of hardware just out of camera range. There are three connectors on the rear: tape recorder in and out, and video out. That's all there is. Of course, if you want to get fancy, you can add

all sorts of peripheral equipment, but that's not necessary to get started. In fact, you can even use your regular color t.v. set, by attaching a simple t.v./computer adaptor to the set's antenna terminals.

COMPUTER BASICS

The Apple—and most other computers in the same general category—understands the computer language known simply as *BASIC*. This is a reasonably straightforward set of instructions in semi-conversational English.

For example, suppose you would like to have the computer draw a nice yellow line across the monitor screen. (Notice I didn't ask *why* you would want a nice yellow line across the screen.) Anyway, you might try typing, "Hey computer, why don't you draw a nice yellow line across the monitor screen?" When you complete this simple instruction, simply hit the carriage return key to signal that you've finished giving orders.

For your effort, the computer will "beep" at you, and print out ***SYNTAX ERR. This is its way of informing you that you have committed a grievous error. You have forgotten that the computer—despite its incredible sophistication—is also incredibly

stupid, and can only understand BASIC instructions. So, it's up to you to translate your wishes into BASIC. Each instruction must be preceded by a line number, and the computer will execute these instructions consecutively, regardless of the order in which you typed them in.

Before starting, you should know that the computer thinks the monitor screen is divided into a 40 x 40 matrix, and that it must be in the graphics mode in order to draw colored lines and such. Therefore, the following instructions should get you your damned yellow line.

```
100 GR
110 COLOR = 13
120 HLIN 0,39 AT 20
130 END
RUN
```

Or, in English; 100 GR places the computer in the color graphics mode. If this instruction is omitted, the computer will do nothing with the others. 110 COLOR = 13 tells our dumb friend that the color will be yellow. As you may suspect, other colors are represented by other numbers. For example, blue = 6, and orange = 9. 120 HLIN 0,39 AT 20 means: draw a horizontal line from X = 0 to X = 39, and place this line at Y = 20. 130 END means once you've done this,

Divide and conquer.



Conquer distortion, defeat clipping, clean up your mix.

Bi-amplification or tri-amplification with Yamaha's F-1030 frequency-dividing network can take you a long way down the road to audio perfection.

By separating high, mid and low frequencies before amplification, the F-1030 increases efficiency and headroom to the point where you need fewer amplifiers and speakers to produce the same sound level. What's more, by dividing the sound for several amplifiers and many sets of speakers, the F-1030 eliminates the cost of individual passive crossovers.

Control your own! Unlike other dividing networks, Yamaha's F-1030 offers dB-calibrated detented controls on both inputs and outputs, as well as transformer-coupled XLR and standard phone jack connectors. Twelve selectable crossover frequencies range from 250Hz to 8kHz, with your choice of 12dB/octave or 18dB/octave slopes, plus a switchable 40Hz 12dB/octave high-pass filter.

Use with confidence! Noise and distortion are virtually extinct. The Yamaha F-1030 will drive a full +24dBm (12.3 volt) output into a 600 ohm load. It will also accept input levels to +30dB.

There's just not enough room here to give you the whole story. So send this ad along with three dollars. (Please, certified check or money order only. No cash or personal checks.) We'll rush you the F-1030 operation manual. Or better yet, see your Yamaha dealer.



YAMAHA

Musical Instrument/Combo Division
6600 Orangethorpe Avenue,
Buena Park, CA 90620.
Write: P.O. Box 6600, Buena Park, CA 90622

Crazy Like a Fox

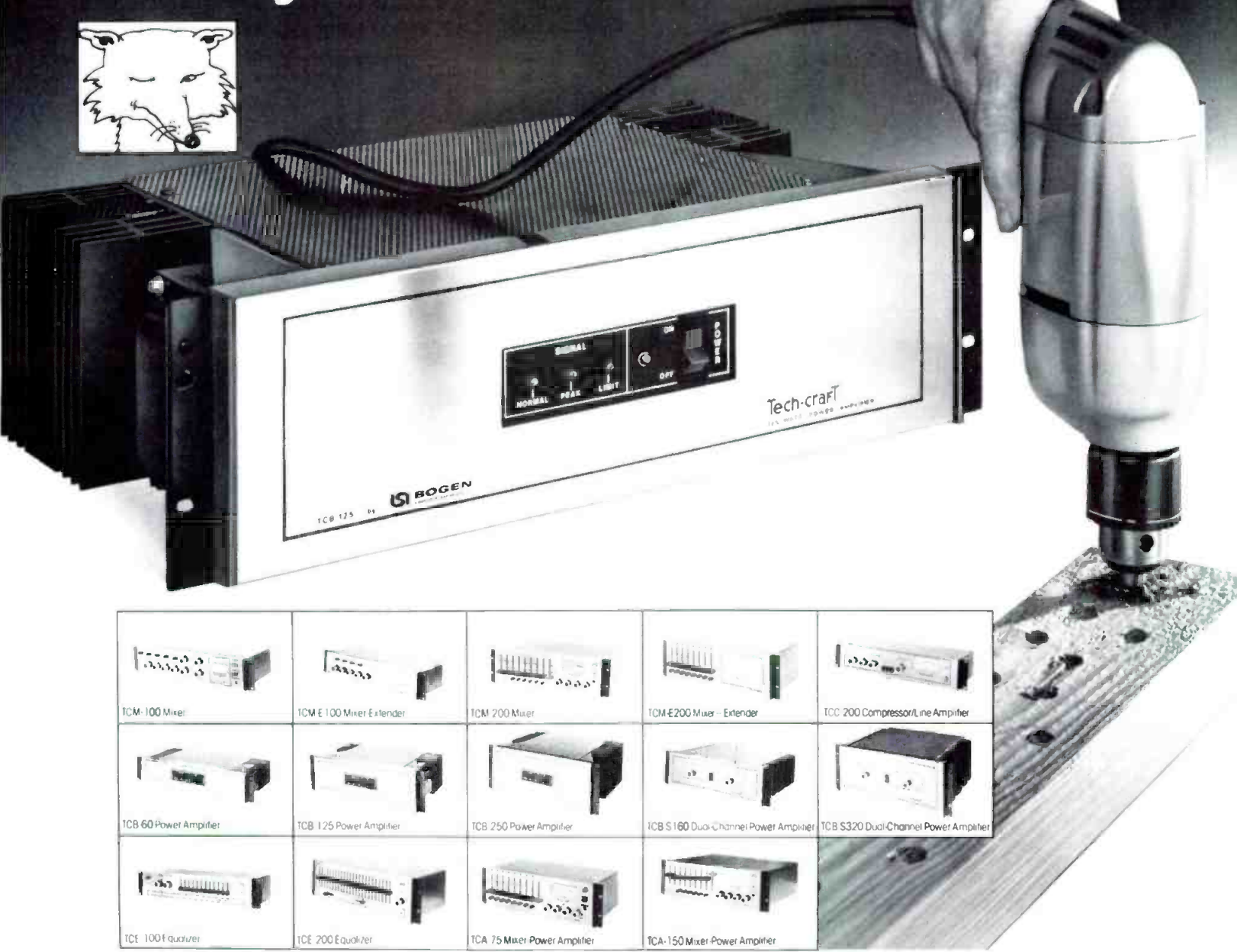
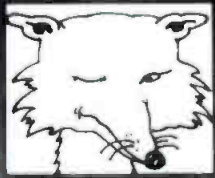

Drive a drill with a 125-watt audio amplifier? Of course you wouldn't. But we did...to prove a point. Our Tech-craft TCB-125 professional amplifier drove the drill for a solid week, continuously, even though we repeatedly clamped the chuck to overload it. Feeding an induction motor like that is one of the toughest torture tests you can give an amplifier, yet it drove the drill through a 2x4 again and again...thanks to our current limiting circuit which protected it from harm even under adverse overload. Crazy? Not if this unusual test convinces you that at Bogen, RELIABILITY is NUMBER ONE.

If it can handle a drill, you can be positive that a Tech-craft amplifier can handle any speaker load under virtually any conditions...beautifully. The performance specs include frequency response within ± 1 db from 20 to 20,000 Hz at rated output power...and total harmonic distortion less than 1% from 25 to 22,000 Hz, also at rated power.

What does it take to produce a line like Tech-craft? A company like Bogen.

The Tech-craft Professional Series incorporates all the knowledge and skill we've acquired during 45 years in sound. Yet it isn't encumbered by any earlier design concepts. We developed the entire series at the same time, using the latest state-of-the-art technology. It includes active mixers and mixer-extenders, single and

dual channel power amplifiers, mixer-power amplifiers, graphic equalizers, a compressor/line amplifier, and a wide range of accessories.

They are designed with unsurpassed features and specifications for today's sophisticated requirements, highest reliability and total system compatibility. We believe they offer the finest values in professional sound equipment.

Availability? Who but Bogen delivers a line like this from stock?

One last point. The drill we drove was made by another LSI division, National Twist Drill and Tool. They're tops in their field, too, and we mention it to emphasize the vast technological resources that stand behind us as part of a \$1 billion corporation.

ALL BOGEN PRODUCTS ARE G.S.A.-LISTED.

For more information, please write or phone us.

Tech-craft[®]
 PROFESSIONAL SOUND by
BOGEN[®]
 A DIVISION OF LEAR SIEGLER, INC.
 P.O. Box 500, Paramus, NJ 07652
 (201) 343-5700

Circle 35 on Reader Service Card

take the rest of the day off. RUN (with no instruction line) tells the computer to go ahead and execute this program.

Notice that although the lines are numbered consecutively there is an interval of ten between each number. This is not necessary, but it does allow us to insert additional instructions without re-writing the whole program. No big deal in this case, but if you're writing long, complex programs, it can come in handy to have a little room for changes.

For example, let's add a blue horizontal line, two spaces above the yellow line. This will begin at X = 0, and end at X = 20. (What will Y equal?) Next, we'll add an orange horizontal line four spaces below (Y = ?) the yellow line. This one will begin in the middle of the screen (X = 20) and end at the extreme right (X = 39). The following additional instructions should do it:

```
102 COLOR = 6
104 HLIN 0.20 AT 18
122 COLOR = 9
124 HLIN 20.39 AT 24
```

The computer will obediently insert these instructions in the original program, but if you're not the trusting type, simply type LIST, and the screen will display:

```
100 GR
102 COLOR = 6
104 HLIN 0.20 AT 18
110 COLOR = 13
120 HLIN 0.39 AT 20
122 COLOR = 9
124 HLIN 20.39 AT 24
130 END
```

Now, when you type RUN, you should get a display that looks something like this:

Note that the only thing you will see on the screen are the three horizontal bars in the above illustration. The X and Y axes, numbers and (blue, yellow, orange line) are sketched in here merely to help figure out what's going on.

By the way, the instructions listed so far are not unique to the Apple computer. With minor variations, most instructions can be used word-for-word by any other computer that handles BASIC.

Of course, the computer will also tackle mathematical problems, giving numerical or graphical readouts, as appropriate. If you want to solve the problem, 3 + 4, you type PRINT 3 + 4. When you hit carriage return, the computer obliges by printing 7.

On the other hand, if you typed

PRINT "3 + 4," the computer would take you literally, and print 3 + 4. So, in computerese, there's quite a difference between 3 + 4 and "3 + 4."

If you had earlier told the computer that A = 3 + 4, you could now type PRINT A, and you would get 7. On the other hand, what would you get if you typed PRINT "A"?

Well, I'm still a long way from polar patterns, and even further from a 32-track automated mixdown, but I think I'm getting there.

THE BOTTOM LINE

What does it cost to get started? The Apple II computer used here has a list price of \$1,195. It has 16K bytes of RAM (Random Access Memory). Depending on memory size, this price can vary between \$970 and \$1,795.

If you don't care about the color graphics mode, other manufacturers have computers available from about \$600 up. Depending upon reader reaction to this sort of thing, we'll get more-or-less involved in the capabilities (and limitations) of a variety of them in subsequent issues.

In the meantime, I'm going to try to figure out how the Apple draws polar patterns. And then, on to bigger and better computer problem solving in audio. ■

THE 19" PARKING SPACE

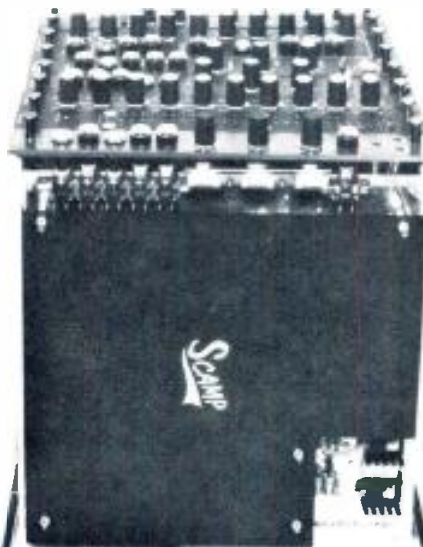
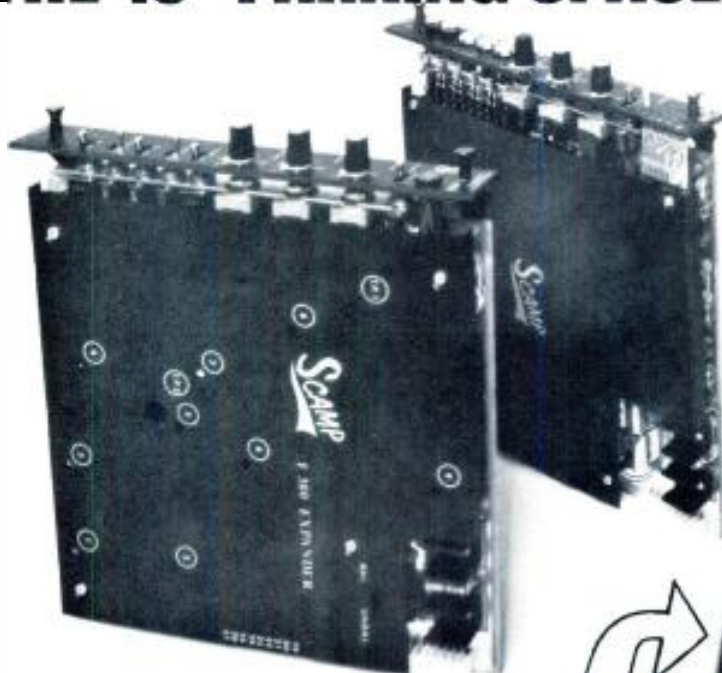

In this 19" parking space there is ample room for an impressive array of the kind of equipment successful studios need.

You choose the unit combination that suits your need and budget.

Parking lot flexibility means that as your business grows so can your SCAMP system.

Simply add the units you need, when you want them.

There's nothing like it on the market.

This space reserved for:

- S 03 Sweep Equaliser
- F 300 Expander-Gate
- S 01 Compressor-Limiter
- S 02 Microphone Pre-amp
- S 04 Parametric Equaliser
- S 05 Dynamic Noise Filter
- S 06 Dynamic Noise Filter
- S 07 Octave Equaliser
- S 14 Quad PPM I.e.d column
- S 23 PAN effects module
- S 24 ADT/ Flanger
- S 27 Dual Electronic Crossover



audio & design recording inc.

Gregg Dixon, PO Box 23047, Honolulu, Hawaii 96822 Tel: (808) 845 7226
Nigel Branwell, PO Box 902, Marina, Calif. 93933 Tel: (408) 372 9036

Circle 31 on Reader Service Card

EVERYBODY'S GETTING BEHIND BGW

Even Crown and Yamaha



	POWER* @ 8 OHMS	HEATSINKS/COOLING SYSTEM: TOTAL # OF OUTPUT TRANSISTORS @ 4 OHMS	SPEAKER PROTECTION:	MAINS (AC) PROTECTION:	CONSTRUCTION DESIGN:	TURN-ON DELAY:	CIRCUITRY:	T.H.D.	PRICE**	YEAR INTRODUCED:	
BGW 750 B/C	225 Watts/ch.	360 Watts/ch 20	Forced air cooling for 2 massive removable modules	Active arc- interrupting circuitry	Front panel magnetic circuit breaker	Modular all Teflon wiring	Relay operated transient delay circuitry	Full complimentary	\$ 999 - Model 750C \$1099 - Model 750B	1978	
CROWN DC300A	155 Watts/ch.	NO FTC RATING 16	Passive airflow only	None provided	Rear panel fuse only	Hard-wired, non-modular	None	Quasi- complimentary	Not specified*	\$ 919 ***	1974
YAMAHA P2200	200 Watts/ch.	NO FTC RATING 12	Passive airflow only	None provided	Rear panel fuse only	Hard-wired, non-modular	None	Full complimentary	Not specified*	\$1095	1976

Here they are — The big guns of professional amplification: The respected Crown DC300A, The cosmetically impressive Yamaha P2200, And BGW's new, no-nonsense 750B/C.

Top-of-the-line professional power amplifiers from the industry's most respected manufacturers. All boasting impressive reputations. All costing about \$1,000.

The table reveals the specifications.* You decide which one is best.

THE RELIABILITY FACTOR

Above all else, professional musicians and audio engineers want to know two things about their power amplifiers: How dependably they function under extreme conditions, and how well they interface with other components.

BGW's new 750 Series amplifiers have taken the lead in both areas. Twenty (20) output transistors as opposed to Crown's 16 and Yamaha's 12 provide a Safe Operating Area unmatched by either the DC300A or the P2200. While both Crown and Yamaha rely on passive "convection" cooling, the extensive heat sinks on BGW's pro amps are cooled by forced air for reliable, continuous performance even on the hottest outdoor concert stages. Unique new arc-interrupting circuitry protects speakers — not just the

amplifiers themselves — from catastrophic DC offset.

Like all BGW amplifiers, the 750B and C feature modular construction and front-panel circuit-breakers rather than hard wiring and cumbersome rear-panel fuses. The result: Maintenance is easier both onstage and in the studio — when time and tempers can be very short.

CLARITY AND PRESENCE

Now that audible Harmonic and Intermodulation Distortion have been all but eliminated from professional power amplifiers, Transient Intermodulation Distortion (TIM) has become important. Neither Crown nor Yamaha specifies TIM levels whereas TIM specs for BGW's 750's Series are published with the greatest of pride. The 750B and C consequently produce clearer, warmer, and more open sound.

Pros will also appreciate another BGW exclusive: A delay circuit that eliminates all transient "thumps" when the 750B and C are activated. Neither Crown nor Yamaha has anything like it.

POWER

This is where BGW really leaves the competition behind. While the Crown DC300A and the Yamaha P2200 are rated at

155 and 200 watts, respectively, BGW's 750B/C delivers a full 225 watts per channel into 8 ohms,** leaving the competition behind entirely at 4 ohms, with a whopping 360 watts. Only BGW has FTC rated 4 ohm power specifications.

Both the DC300A and the P2200 are good power amplifiers by conventional standards. But real recording pros don't deal with convention.

They get behind BGW.
Because the competition already is.

*Based on manufacturers' published specifications and prices available 7/1/78.

**BGW 750B/C FTC Specification: 225 watts minimum sine wave continuous average power output per channel with both channels driving 8 ohm loads over a power band from 20Hz to 20kHz. The maximum Total Harmonic Distortion at any power level from 250 milliwatts to 225 watts shall be no more than 0.1%.

*** Includes optional HMB-7 Handles (\$20.00, not shown)



Get Behind Us!

BGW Systems, INC.
13130 S. Yukon Avenue
Hawthorne, California 90250
In Canada: Omnimedia Corp., 9653 Cote de Liesse
Dorval, Quebec H9P 1A3

Circle 43 on Reader Service Card

Audio Tape
for professionals



REEL TO REEL TAPE
Ampex, 3M. All grades.
On reels or hubs.

CASSETTES, C-10-C-90.
With Agfa, Ampex, 3M tape.

LEADER & SPLICING TAPE

EMPTY REELS & BOXES
All widths, sizes.

— COMPETITIVE • FROM STOCK —

For your catalog, call or write: **Vito Cappi**
312/297-0955



Recording Supply Co.
Div. of Polyline Corp
1233 Rand Road
Des Plaines, IL 60016

Circle 23 on Reader Service Card

**RELIABILITY
FLEXIBILITY
PERFORMANCE...**



NEW LOW PRICES

RELIABILITY—advanced state-of-the-art technology, I.C. op-amp circuitry and high quality components throughout.
FLEXIBILITY—through multiple input preselect switches and a broad selection of optional plug-in modules to suit your individual requirements.
PERFORMANCE—with features like microphone input limiters which prevent overload. "Human Engineering" which provides maximum operator visibility, efficiency and comfort to minimize operator error. Readily available in 5, 8 or 10 channel models, mono or stereo. All sensibly priced.

THE ROBINS
30000 Series Broadcast Consoles



BROADCAST & SOUND EQUIP. CORP.
75 AUSTIN BLVD.
COMMACK, N.Y. 11725
(516) 543-5200

Circle 25 on Reader Service Card

The Systems Approach to Design – to Anything!

● Last November, in the 10th anniversary issue, reminiscing about Theory and Practice, I commented that the two must always really be in agreement even though they appear to contradict at times. This is central to a great many diverse subject areas. But there is something even more basic, and applicable to an even wider range of subject areas. This is the *systems approach*.

Back in the mid-30's, when I was chief engineer of a new young company called Tannoy, if someone had talked about the "systems approach," I would have perked up my ears and said, "What's that?" thinking that I might have missed something. Yet I was using the principle without ever giving it a name.

At Tannoy, more than being manufacturers of audio products, we were problem-solvers. If somebody had an idea for a system, whether it was automating electrical power plants, providing automated language translation systems for multi-lingual meetings, or a score of other things they would come to us, many times after not having been successful with larger firms, for a solution. Often, while everyone else was still thinking about the problem, we at Tannoy had solved it. Our motto was the familiar one, "The difficult we do immediately. The impossible may take a little longer."

By living up to that reputation, the company enjoyed phenomenal growth in the latter '30s, and through World War II. Of course we had our share of bungles in the process and were our own worst critics for it too. But Tannoy, producing new systems in less time than anyone else could, had little competition.

One of my tasks was to train new engineers. As an adjunct to that I

prepared a series of manuals setting forth design procedures applicable to any desired system. Once the engineers assimilated the method, they were able to apply it to the matter at hand quite rapidly and efficiently. Actually, what was being developed, because it was needed in a practical sense, was an approach that later became known as the systems approach.

THE SYSTEMS APPROACH

What is this systems approach? Many of the things I discuss in this column are an integral part of it. It could also be called a "problem-solving" approach. First, you seek a feasible way in theory. You figure what can be done, assuming you have all the hardware and software needed. (Consideration of that comes later).

The voice-print discussion in a previous issue is a good case in point. Without thinking at all about the bits and pieces needed, or how many memory banks it will take, you consider carefully what the system has to do, as opposed to what it does not have to do—and what it must not do. This serves two purposes: it gets the requirements of the system clearly established and it familiarizes you, as the system's designer, with the problem you face.

Now you think about ways to go about this, still not thinking too closely in terms of hardware or software. If you think of a recorded memory, for example, you don't care at this point whether it is on disc, tape, or in some other medium. That can come later, when you have everything else in place, and are considering the economics, reliability, versatility, etc., of the whole system.

TESTING THEORY

Inevitably, most new systems in-

NEW! from IRP Voice-matic Microphone Mixer

When two, four, six up to twelve microphones are used simultaneously in a sound system, the Voice-matic Mixer gives state-of-the-art control of the sound. The modular design makes possible selection of channels for the small conference room that requires only two microphones—or a large system where many channels are required—and everything in between.

By using a system that limits the number of open microphone channels to only those in use, background noise and reverberant sound are held to the lowest possible levels. This sophisticated system also assures maximum house gain before annoying "howl" caused by feedback. The result: improved sound clarity and overall system quality.

The new IRP Voice-matic system is illustrated and described in Data Sheet DE-4013. A copy is yours for the asking.

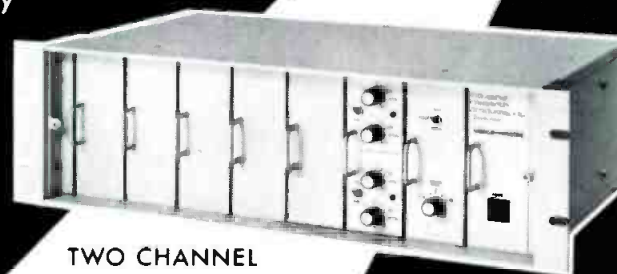

TWO CHANNEL

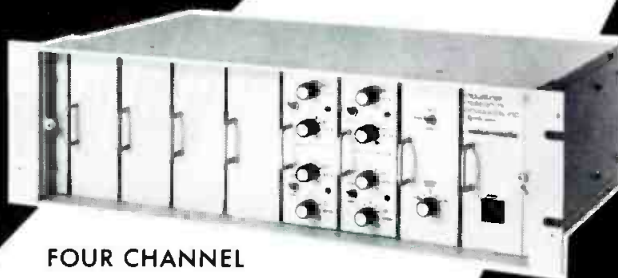

FOUR CHANNEL



SIX CHANNEL

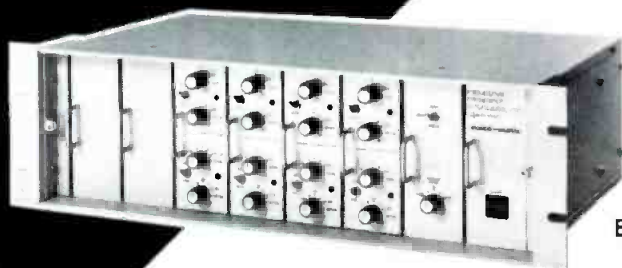

EIGHT CHANNEL

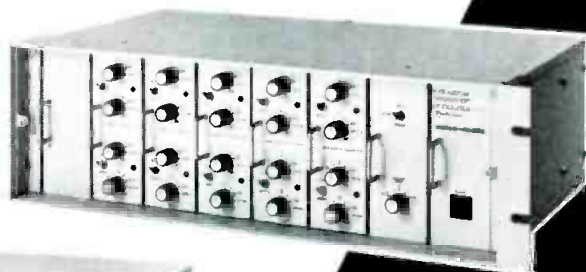

TEN CHANNEL

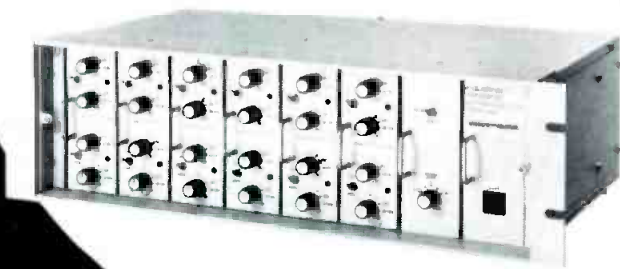

TWELVE CHANNEL

YOU NEED THESE IMPORTANT FEATURES

- Sophisticated circuitry suppresses feedback "howl".
- Dynamic Threshold Sensing (DTS) eliminates gating common to VOX systems.
- Adjustable attenuation for active or inactive channels.
- Low noise. Wide dynamic range. Transformer balanced inputs.
- Modular design—2 to 12 microphone inputs—allows economical selection of inputs.
- Multiple chassis may be tandem connected if additional inputs are needed.
- Second fully mixed output for tape recording, off-premise transmission, etc.
- Front panel channel status LED's
- Flexibility is provided by many options giving a custom-made system for each installation.

INDUSTRIAL RESEARCH PRODUCTS, INC.

321 BOND ST. • ELK GROVE VILLAGE, ILL. 60007 U.S.A.

Telephone: 312/439-3600

Circle 27 on Reader Service Card

A Knowles COMPANY

theory and practice (cont.)

volve some as yet untried capability which may be only a small piece of the overall solution, but quite vital to its final performance. So you initiate tests or whatever is needed, to establish this capability as a separate piece. If there is more than one way to go you give them both a shot and get data from each.

In this way you move positively from problem—what you want the system to do—to solution—a system that does it. All right, that briefly describes the process—there was a lot more to it in my manuals, of course. But how does this approach differ from others, those that Tannoy's competitors used, back in the '30s.

We had a name for the approach most often used by our competitors, if we did not as yet have one for our own. We called theirs the "brute force approach." Examining what they had done, it was obvious how they must have gone about it. They thought of a way to do whatever the system wanted done. They made it all up, only to find some flaw. Nothing ever works the first time, as any engineer knows.

At that point, they assumed that

the rest of the approach they had theorized was "perfect," and set about to solve the flaw. After several flaw-solvings, which can be a very time-consuming process, the system became quite awkward or unwieldy. What started as a simple idea finished up as a mass of solutions for flaws in its apparent simplicity.

There is a quite subtle difference between the two systems approach and the "brute force" method. You must think of any complex system in blocks, pieces that do certain parts of the whole problem, just as modern solid-state digital is built of blocks.

The American way—in fact the way prevalently used everywhere—shops around for the blocks to make the complete system and that is about it. Then when flaws develop, they shop for more blocks to cure the flaws. All that has changed has been the content of the blocks—what you can shop for. Where our systems approach—if that is the right name for it—differed was in that you always thought in both large and small terms at the same time.

AUDIO MATCHING

Audio matching is perhaps a good illustration. The classic textbook approach tells us that matching for

maximum power transfer requires the load impedance to equal the source impedance. I am sure that, even today, a lot of audio people fondly imagine that, when you connect an 8-ohm loudspeaker to the 8-ohm output tap on a power amplifier, you are doing that. The labels both read the same, so you have complied, right?

It will come as a surprise to them to learn that the internal, or source impedance, at that "8-ohm output" is much less than 8 ohms, probably a fraction of an ohm, and that it must be so in order to provide what is designated as a satisfactory "damping factor." Or that making the impedances equal will definitely not yield maximum power output from that amplifier.

If you must think in simple terms—and most of us find it easier to do so—think of a power amplifier as a "constant voltage" output device, rather than an impedance matching device. I have discussed this before, so I will not go into it at any length here beyond applying it to our systems approach discussion.

Perhaps I can complete that by asking, "How important is a damping factor?" Many people ask such questions, expecting some kind of absolute answer. The point is that the

btx presents the 30-track audio recorder

The btx 4500 SMTTE interlocking system lets you operate any two multi-track recorders in tandem for 14, 22, 30 or 46-track capability. Using standard SMTTE time code written on one track of each machine, any two recorders may be synchronized, including video and audio. You can even mix makes, formats, speeds, and numbers of tracks, with or without servo-controlled capstan drive. The btx 4500 is a micro-processor-based system capable of tracking within 50 microseconds of an actual mechanical lock. It's an economical direct plug-in system that's easy to use and ultra-reliable.

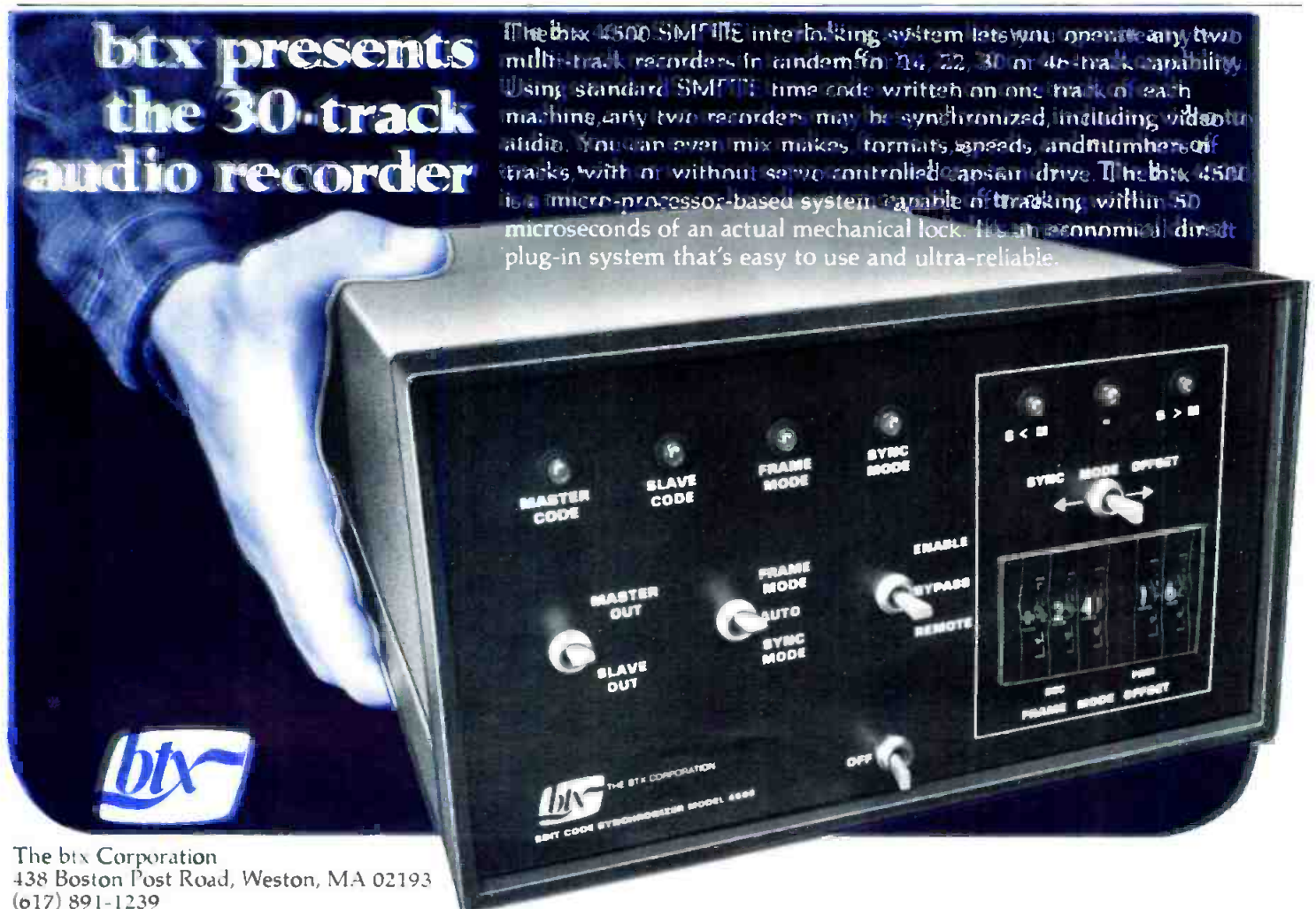

btx THE BTX CORPORATION
SMT CODE SYNCHRONIZER MODEL 4500

The btx Corporation
438 Boston Post Road, Weston, MA 02193
(617) 891-1239

The "better than" equalizer



CROWN EQ-2

The Crown EQ-2 is a $\frac{1}{2}$ -octave equalizer on octave centers with two channels, eleven bands per channel. ± 15 dB of boost/cut is available for each band. That's one reason why the EQ-2 is a better choice. But there's much more.

Adjustable center frequencies – The Crown EQ-2 is better than a parametric because you can control boost and cut for eleven-bands per channel with adjustable center frequency for all 22-bands. It cures many more room problems.

Simple set-up – The Crown EQ-2 is better than a $\frac{1}{3}$ -octave graphic because it's simpler to set up, yet provides full-range control. The EQ-2 can also be cascaded to create a 22-band, $\frac{1}{2}$ -octave mono equalizer.

Unique tone control – The Crown EQ-2 is better than other equalizers because of its unique tone control section. Shelving-type bass and treble controls with selectable hinge points reduce phase shift problems, since low and high frequency problems

can be resolved before equalizing begins. This feature also permits quick reshaping of the response curve for different room populations without altering basic equalization.

Superb specifications – The Crown EQ-2 is "better than" because of a signal-to-noise ratio 90dB below rated output, and THD less than .01% at rated output.

Reliability – It's "better than" because it's Crown. That means reliability, ruggedness, and better value.

New RTA – It's also "better than" because Crown now manufactures a real time analyzer which, used in conjunction with EQ-2, makes the job of equalizing even easier.

Write or call today. We'll be glad to arrange a demonstration of both the EQ-2 and the new RTA at your convenience. Your systems deserve to be "better than."



1718 W. Mishawaka Road, Elkhart, Indiana 46514

American innovation and technology...since 1951.

theory and practice (cont.)

damping factor is one of the many detail problems whose importance is determined by the nature of the whole big problem with which you are dealing. What kind of a system is your amplifier to be part of? Answer that, and you have a basis for putting the damping factor in its place.

ISOLATING TROUBLE

In any big system, application of "fail safe" principles is important. If any part of the system fails, you do not want a trigger, or domino action, pulling down most of the system so it will all have to be replaced, or perhaps leading to some dangerous catastrophe. Failure must work in such a way that the defective part is isolated, nothing too serious happens, and the defective part can be replaced with the minimum of effort.

I could go on to enumerate the different aspects that must be considered and correlated with all the other pieces for successful systems design. But one point I wanted to make is that the way of thinking can go through a wide range of subject areas.

The "brute force" method is much in evidence in our educational system. If a student has a problem memorizing the "multiplication facts," the system's remedy is to find some means of forcing the poor kid's memory to work—using flash cards, mechanical devices, or whatever.

The problem-solving, or systems approach method, seeks the cause of the individual student's difficulty. A number of students may share the same difficulty—often do—in which case the same remedy may work for all of them. But if the causes of their difficulties are different, the same remedy will not work. This is what is wrong with a common teaching practice: if the student gets this wrong answer, tell him so-and-so; it may not apply.

For example, a student's problems with fractions may stem from the fact that, though he was successful at *doing* division, he never really understood what he was doing. A lot of drill may eventually get him to also *do* fractions, but that approach compounds the injury, will make later efforts even harder for him.

The solution is to find where he first had difficulty, what he first failed to understand. Correct that, and his own mind will catch up, fast. If you think in terms of a mechanical analogy, suppose one bearing of a machine needs oil, and you give oil everywhere else: will the machine get going again? But give oil where it is needed, and the machine runs smoothly and efficiently. ■

MARTIN DICKSTEIN

db Sound With Images

Slides Do Funny Things

● It's true!

Take this huge company's seminar, for example. (As Henry Youngman would add: "Please!") It was a three day session of international higher-ups getting together to find out what the others were doing in business, management, and advertising. It only happened a couple of weeks ago but it seems like yesterday.

It took place at a large conference center out of town (New York, that is). 75 executives were brought in from all over the world and then limoused to this expensive conference center/resort. Material for distribution had been flown in, and the presenters had in their possession films, slides, and video cassettes to assist them in giving their talks. (I had been told of the meeting, but since no invitation was offered to attend as anyone's a/v consultant, I did not have any reason to go the first day.)

On the afternoon of the first day, I called the office of one of the attendees from New York to find out when he would be getting back so that I could make an appointment for a meeting on another project we were working on. His secretary told me that he had called and said that if I called in, to tell me to get up to the conference center the first thing in the morning. The day so far (up to the time he called) had only been a major disaster, but since there were still a couple of hours to go, it could get even worse.

When I asked the girl what went wrong, she said he was very upset—something had gone wrong with every presentation given that day either with slides, films, cassettes, or any combination thereof depending on what the speaker was using for audio-visual aids. (Incidentally, to digress a moment, note the way "audiovisual" was just spelled. I have been told that

The Rotor device atop the drum with the drum-attached interface unit and the control box.



The Final Component In A Sound System Isn't A Speaker, Driver Or Horn...

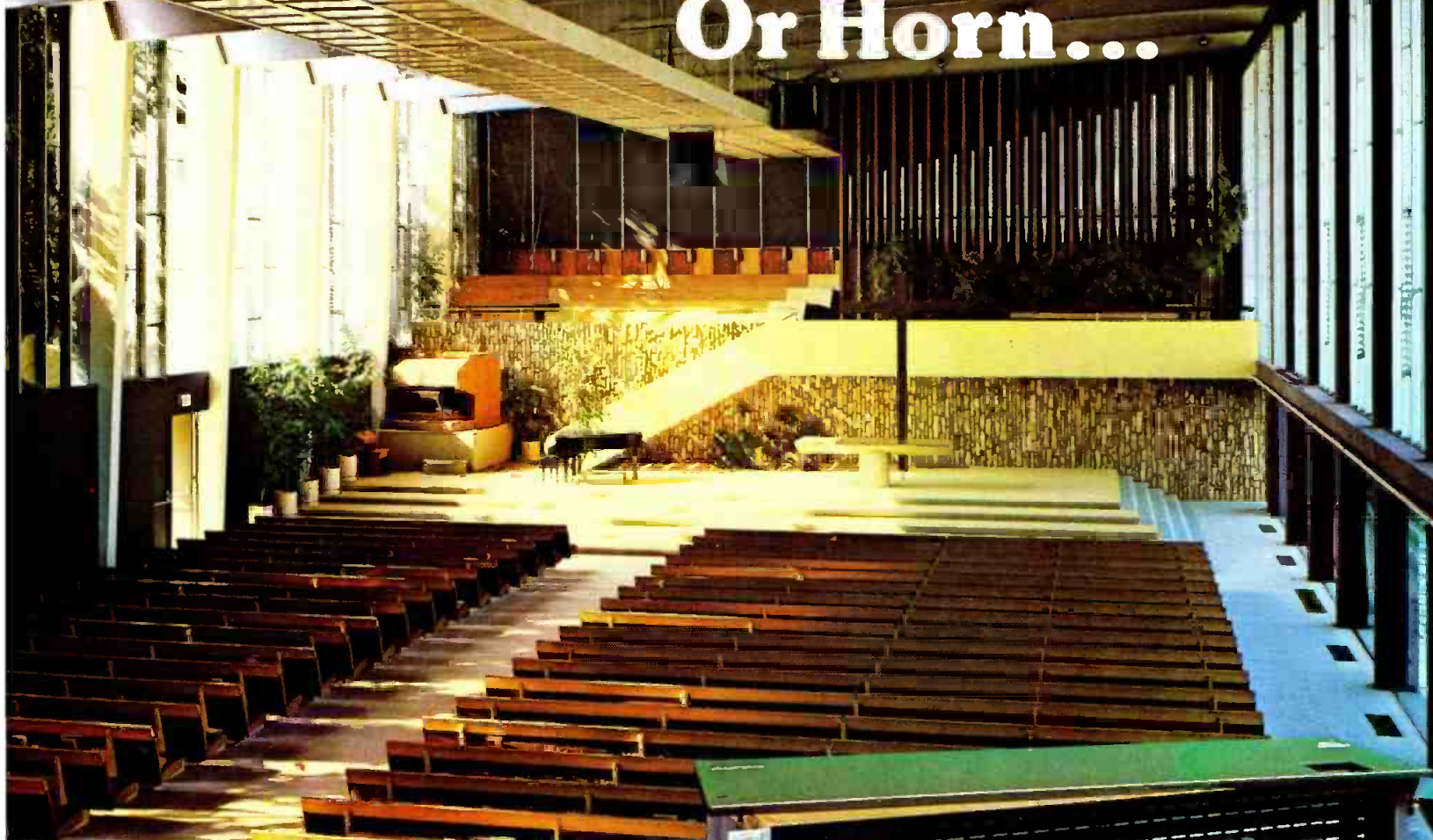

...It's The Room

As an audio professional you know that room acoustics can make system performance a real headache. You also know that equalization can be part of the solution. But some equalizers can add as many problems as they solve. Problems like uneven frequency response, increased distortion and volume loss.

At Altec Lansing we don't think you should have to live with problems like these and to prove it we've developed the 1650 Active Equalizer.

The 1650 is a 1/3-octave equalizer that delivers the high-performance levels that you need for difficult applications. Combining-type filters provide ripple-free summation and a frequency response of ± 1 dB from 20-20,000 Hz. Distortion is typically less than 0.5% at full rated output. And if you think equalizers have to add noise to the system, consider the 1650's extremely low noise rating of -100 dBm.



But high-performance is only part of the story. The 1650 also incorporates an impressive list of standard features that can help make your job a lot easier. Features like continuously variable high and low-pass filters, filter bypass switching, provisions for balanced input and output, dc operation capability and a gain restoration amplifier to make up for equalization losses. And to make sure that your settings aren't accidentally changed, there's even a hinged front panel cover to protect the controls.

The 1650. Another dependable performer from Altec Lansing. Check the Yellow Pages under Sound Systems for the name of your local Altec Lansing Contractor. And discover the difference that the 1650 can make in your sound system's final component.

1515 So. Manchester Ave., Anaheim, Calif. 92803 • 714/774-2900
ALTEC CORPORATION

Circle 36 on Reader Service Card

**ALTEC
LANSING**
SOUND PRODUCTS DIVISION

SWITCHCRAFT
AUDIO CONNECTORS
JACKS/PLUGS/PATCH CORDS

Shipped from STOCK!

Ask for Our Catalog

PRO-AUDIO SPECIALTIES CO.
 1291 RAND ROAD
 DES PLAINES, ILLINOIS 60016
 PHONE (312) 827-8388

Circle 42 on Reader Service Card

Direct Boxes & "Mic-splitters"

Passive Direct Box SM-1A	Active Direct Box SM-2
Deluxe Active Direct Box SM-3	Single "Mic-splitters" MS-1A
Quad "Mic-splitter" MS-4	8 x 2 "Mic-splitter" MS-8
12 x 2 "Mic-splitter" MS-9	16 x 2 "Mic-splitter" MS-10

Direct Boxes: Both active and passive SM-1A for guitars SM-2 and SM-3 for keyboards and electronic instruments

"Mic-splitters": Low impedance in and out. Will handle +6 dBm. Will pass phantom voltage. Isolated grounds

Thousands in use around the World!
 We also manufacture audio transformers, snakes, audio modules

SEND FOR YOUR FREE COPY OF OUR NEW CATALOG
 P.O. Box 590,
 12931 Budlong Ave.,
 Gardena, CA 90247 U.S.A.
 (213) 770-3510, (800) 421-1828,
 TWX (910) 346-7023

SES
 Quality Engineered Sound Products

Circle 32 on Reader Service Card

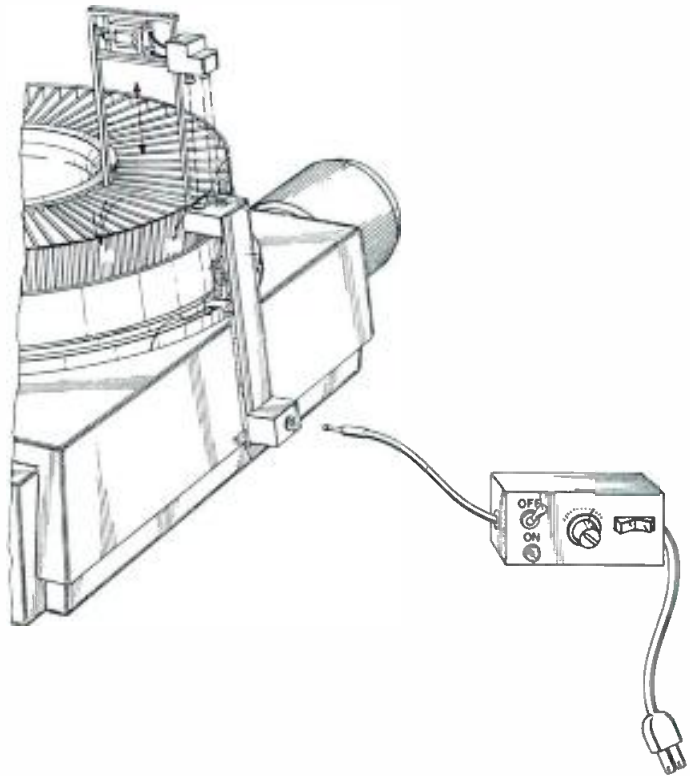

Figure 1. The Rotor, showing the direction of motion and the interconnections.

is the preferred spelling in one of the latest dictionaries . . . without a space between the two words and without a slash mark, or even a hyphen. What's the abbreviation, then?)

Anyway, I immediately found out the name of the supplier of the audio-visual equipment and called them. I was informed that the technician they had furnished for the meeting had been given loose slides, in the proper sequence, and had been asked to put them into trays for use during the meeting. The young man had evidently had *no* experience with slides and had put them in the proper sequence, but only one or two were inserted properly. All the rest were upside down, backwards, or both. It became even worse when he tried to maneuver the slides during the presentation to make them project properly. After several tries per slide they were okay, but by this time the speakers weren't.

To make matters even worse, some of the slides given the technician were mounted in the thick plastic holders and many of them either did not drop down into the projector, or did not come back up and jammed the drum. (I can just imagine the state the poor young man was in!) I asked the supervisor, to whom I was speaking, if he had ever shown the man how to insert slides into a drum. He hadn't. The man was sent up to set up the

equipment and to turn on and off the pieces of equipment needed for each speech. I asked the supervisor if he was familiar with the way to put slides into a drum, and he said he hadn't done it for some time and was not sure, but he was certain he could figure it out.

A DIFFERENT DRUM

I then asked if he was familiar with the different drums available for the carousel projector and he said he was—there was a black drum for 80 slides and a black one for 140. He was also well acquainted with the *old* grey drum but they did not use them anymore too much. They used the black trays. When I asked if he knew that there was a new black drum with an orange "tongue" in the center, he said that he did. He had a couple of those around and one or two of the grey ones, but he was not sure which black one he had left in the meeting room to be used during the presentations should there be a need for one.

I told him of the difference between the *old* black and the *new* black drum, and also of the difference between the *old* black one and the *old* grey one, and added that there was also another tray, produced between the *old* grey ones and the *new* black ones—which was translucent. I explained that the *old* black trays were

Birth of the two-track masterpiece. Otari MX5050-B.

The new Otari two-track machine is designed for discriminating recordists. Built with inside-out improvements over our long succession of compact professional recorders. With built-in operation ease and better serviceability. With fidelity, reliability and professional functions indispensable for every critical application you have in mind.

DC-servo direct drive for minimum wow/flutter and speed deviation. With $\pm 7\%$ pitch control and foolproof IC motion-sensing control logic. Optional remote control for all transport and mode functions. Maximum 30dBm input and 600 ohm +4dBm or -10dBm switch-over output with XLR connectors. Front-panel edit and cue, test oscillator, stepless bias and NAB or IEC equalization. Full professional four heads with extra quarter-track playback. And it's designed for both vertical and horizontal operation.

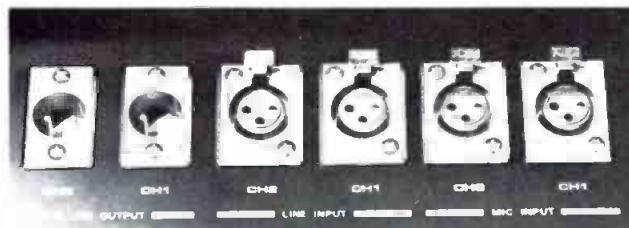

Resultant performance: smooth punch-in/punch-out mastering at 63dB S/N, 55dB crosstalk and 70dB erase with 30Hz - 20kHz (± 2 dB) response. It's the latest and wisest choice for your quality 15/7-1/2 or 7-1/2/3-3/4 ips masters. For the full story about the new generation recorder/reproducer, contact your nearest Otari dealer and see why we call it the masterpiece.

OTARI

U.S.A: Otari Corporation,
981 Industrial Road, San Carlos, California 94070
Phone: (415) 593-1648

Japan: Otari Electric Co. Ltd
4-29-18 Minami-Ogikubo, Sugiyama-ku, Tokyo 167
Phone: (03) 333-9631

Circle 41 on Reader Service Card

J&R BLANK TAPES & ACCESSORIES AT WHOLESALE PRICES!

BLANK TAPES CASSETTE TAPES

TDK D C 60	\$1.20
TDK D C 90	\$1.68
TDK D C 120	\$2.10
TDK J C 180	\$2.46
TDK AD C 60	\$2.46
TDK AD C 90	\$2.52
TDK SA C 60	\$1.22
TDK SA C 90	\$1.18

REEL TO REEL

Maxell UD C 90	\$2.84
Maxell UDXL I or II C 60	\$2.47
Maxell UDXL I or II C 90	\$3.47
Scotch low noise C 90 / 3 pk.	\$4.99 for 3 (10 3/4")
Scotch Master I C 90	\$3.29
Scotch Master II or III C 90	\$3.29
Sony Ferrichrome C 90	\$3.58
Maxell UD 35-90 1800 ft.	\$5.49
Maxell UDXL 35-90B 1200 ft.	\$6.62
Maxell UD 35-180 3600 ft.	\$14.70
Scotch 212 1800 ft.	\$6.35
Scotch 207 1800 ft.	\$6.19
TDK L 1800 1800 ft.	\$6.22

Minimum Order 12 Tapes - 100% Guaranteed

CARTRIDGES audio-technica

AT 20 SLA	\$119.00
AT 15 SLA	\$82.50
AT 14 SLA	\$46.50
AT 12 SLA	\$34.90
AT 10	\$12.00

SHURE

V15 TYPE IV	\$89.95
V15 TYPE III	\$63.50
M95-2D	\$26.50
M91E-1	\$21.95
M24H (QUAD)	\$36.50
M70E-2	\$9.95

PICKERING

XUV/4500 (QUAD)	\$58.00
XV/3000	\$29.95
XV15/750E	\$30.00
XV15/625E	\$20.95
XV15/400E	\$17.95

STANTON

881S	72.50
681EE S	55.00
681EE	42.00
680E	20.80
500EE	14.40

EMPIRE

2000Z	\$59.90
2000T	\$31.50
2000E (II)	\$19.50
4000D1	\$29.90

HEADPHONES PIONEER

HP-205	\$19.95
SE 505	\$46.70
SE 4	\$33.50
HP-500	\$38.95
SE 700	\$59.95

SENNHEISER

HD-400	\$24.90
HD-414	\$35.97
HD-424	\$59.95

KOSS

PRO 4 AA	\$37.05
PRO 4 AAA	\$45.00
HV1	\$19.97
HV1/LC	\$19.97
PHASE/2+2	\$82.00
TECHNICIAN/VFR	\$48.00
K/6A	\$14.97

PICKERING

DA 7	\$41.90
------	---------

HOW TO ORDER: For shipment within 48 hours, send money order or certified check. Two weeks delay on personal checks. Please add \$3.50 per order for shipping & handling. (\$5.50 for orders outside U.S.) N.Y.S. residents add tax. No C.O.D.'s. All merchandise 100% guaranteed, brand new & factory fresh.

J&R MUSIC WORLD

33 Park Row, New York City, 10038 (212) 732-8600

WRITE FOR FREE CATALOG

Circle 28 on Reader Service Card

Turn on a better idea

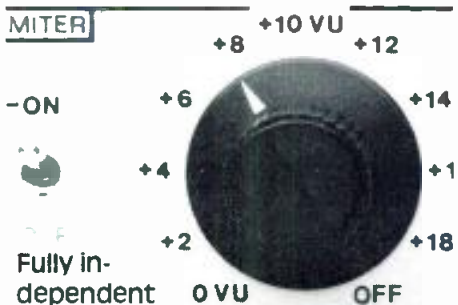

Fully independent average and PEAK CEILING peak limiting for studio recording, mastering, and broadcast production. Open-loop gain control with ripple-cancelling circuitry.

Inovonics' Audio Limiter

Model 201-\$480

Inovonics Inc.
503-B Vandell Way
Campbell, CA 95008
(408) 374-8300



Circle 24 on Reader Service Card

sound with images (cont.)

made for thin slides, those mounted in either cardboard or thin plastic, because the slots were not as wide as those of the old grey ones, and that thick slides would jam because they were too snug in the slide slot.

I suggested that he bring up an *old* grey drum or a *new* black one, or even a translucent one, because all of these would work better with thick slides and would not malfunction with thin slides. I also suggested that the technician had better figure out how to insert slides into the drums and offered an easy tip: hold the slide so that it can be read normally. Then, hold the slide at the bottom and "dunk" the slide into the slot. This rotates the slide upside down and reverses the left-to-right position in one step. He thanked me hurriedly, hung up quickly and raced off with an *old* drum to the rescue of the poor technician.

Seriously, I am not faulting the technician; he was not aware of what he would be expected to do. He didn't call for help because it would have embarrassed him and make him look bad with his supervisor. Actually, there's a good Life lesson involved—facing that matter squarely, he *should* have called for help at once. But he probably thought he would get the hang of inserting the slides after a couple of tries. Inasmuch as lecturers frequently come with their slides already in drums, the supervisor probably thought this would be the case and the technician would not have to process the slides. This is probably also—because it doesn't usually come up—why the supervisor had such a hazy knowledge of the different types of drums.

PRACTICE!

The moral of the story is that if you are either the person who has to set up an audiovisual meeting or the one responsible for someone else's doing it—you need to know your slide lore even if you seldom need the information. Practice inserting slides into a drum and then projecting them; get so you can do the operation as if it were second nature and teach the rest of the people in the shop how to do it. If you suddenly have to take over this responsibility in the middle of a meeting and everything gets goofed up, needless to say, the havoc makes things look bad not only for the meeting, but for your company.

Another point, check the drums you leave for use at meetings. There may be thick and thin slides, and they could be mixed. Always leave a truly "Universal" drum, the old tried-

and-true grey, the translucent, or the new black. (Incidentally, only in the case of rear projection should you try to avoid using the translucent ones because they leak enough light to cause some washout of the image in some cases. Use the old grey or the new black ones only. If you have to use the translucent type, put a layer of black tape—the wide kind—around the side of the tray. This will block most of the leaking light.)

ROTOR

Speaking of slides doing funny things, there is a device available which will make slides do funny things—on purpose. It is called a "Rotor" and is produced by Media Arts Workshop of Newton, Mass. This patented device uses a special mount to use to rotate the slides and rides on top of the drum. When it reaches the projection position, it comes in contact with a second part of the device, which is mounted on the projector at the zero position, which in turn is connected to a separate control box. A tiny motor on the mount can turn the slide either clockwise or counterclockwise, and the speed can be altered by the control box. The slide can be stopped at any point in its 360 degree rotation. (The effect might show a coffee cup—for coffee break time—being turned upside down, or right side up.) Effects can also be varied by using colors or any specially prepared slides.

Media Arts, a company set up by Audiovisual Producer Harry Prichett, makes good use of his 28 years in the broadcasting, advertising, and producing business. They specialize in educational, sales, and industrial shows and have produced many for a long list of impressive clients. They also do a good deal of creative thinking. The Rotor has now been improved to include a microprocessor and keyboard to permit programming of rotations at predetermined speeds with stops at any point in the cycle. They have also developed an Iris Rotor which, as its name implies, can open or close on cue. In addition, they now have a Split Frame Rotor where the two halves of the slide can move either up or down for a split screen or split image effect. They also get into the latest available technological developments and have made use of laser writing to create images and writing with the use of a laser which can also be programmed.

You can learn much more by writing to them or calling them. These devices are now, or soon will be, available. Please mention that you saw it here first. We said slides do funny things . . . we weren't kidding.



OUR ORIGINAL BUSINESS WAS MAKING SOUND CONNECTIONS

We're still at it. We started in 1935 as the Audio Development Company producing jacks and jack panels for the broadcast and telephone industries. Since then, ADC has produced such innovations as Bantam jacks, printed circuit board jacks and Wrapid terminal blocks. What are we doing for you today?



We are introducing our new line of low impedance audio connectors. We have six models now in production. They're reliable, compatible and competitively priced. Most important, they're available sooner. Ask about making a sound connection with ADC. Call or write today.



ADC Products

A DIVISION OF MAGNETIC CONTROLS

ADC Products, 4900 W 78th St., Minneapolis, MN 55435 / Telephone: (612) 835-6800 TWX 910-576-2832 Telex 29-0321

Sales offices in: Atlanta, GA (404) 766-9595 • Dallas, TX (214) 241-6783 • Denver, CO (303) 761-4061 • Fairfield, CT (203) 255-0644
• Lafayette, IN (317) 474-0814 • Melbourne, FL (305) 724-8874 • Menlo Park, CA (415) 323-1386 • Minneapolis, MN (612) 835-6800
• Washington, DC (202) 452-1043 • Montreal, Quebec (514) 677-2869

Circle 39 on Reader Service Card

Editorial

Last month's cover showed one of the earliest attempts at making a record, while this time around we show some of the latest in recording studio hardware. Lurking in the background of our cover photo is an Altec monitor speaker, and in case you're wondering, that's MCI's latest console off to the right. The scene is Harry Hirsch's Soundmixers Studio in New York City—one of the most up-to-date studios in the business. (We'll be back at Soundmixers soon, for a complete story on the studio.)

But in the meantime, how much of that other hardware can you immediately identify by name and function? (Not counting the Panasonic cassette recorder, of course.) Time code synchronizers, readers and generators, computers, micro-processor based control systems, video monitors—what's all that got to do with recording?

As you know, the answer is *PLENTY!* For the recording scene is changing, and changing very fast indeed. First, it was digital delay lines, then automated consoles and now of course, the digital tape recorder.

Which brings us to our first feature story. While digital authorities debate data rates, digital editing techniques, and error-correction schemes, some of us analog folks can get a bit confused. And so, we asked Ampex's Edwin Engberg for a little clarification, which he supplied in **A Proposed Digital Audio Format**.

Next, we find out what happens when **SMPTE Time Code Comes to Audio**. Author Bruce Mallion points out that time code editing is well-known in the broadcast industry, but is only just now finding wide acceptance in the recording studio. The code permits synchronization of two or more audio machines, Vidicue services, and electronic editing possibilities (providing you don't get your drop frames and jam syncs mixed up).

Can all these super-sophisticated toys be kept under control by mere mortals? Indeed they can, as John Woram discovered when he dropped in at the Automatt in San Francisco. Although Woram is having his problems coping with computerized charge accounts and hotel reservation services, the Automatt crew seems to be completely in charge of their various digital hardware systems. For more details, see **Automating the Automatt**.

Not too many years ago, a search-and-cue device was known as a "second man," whose job was to search for the right spot on the tape, and get it cued up quickly. Then MCI, and others, introduced the Auto-Locator. At first, some of these were "brute force" devices, but as you might expect, by now the microprocessor has taken over most of the Auto-Locator chores. MCI's newest Auto-Locator III is just such a device, and this gave us an excuse to ask Diane Wendt, who edits MCI's *News & Views*, to give us a brief history of **Three Generations of Auto-Locators**.

Digital News Briefs doesn't say much about digital editing, but then, there isn't much to say—yet. Other than that, it's on the way. With digital tape recorders slowly making their way into the studio, some form of digital editing system is on the way to becoming an absolute must. Hopefully, we shall have more to say about this before too long.

And as for that Apple computer on the cover, see this month's **Sync Track** for the first of an on-again, off-again series on penetrating the world of computer programming and audio problem-solving. And, for a bit more information about a handful of such wondrous machines, see our **Micro-directory of Mini-computers**. (Or is it a Mini-directory of Micro-computers?)

J.M.W.

A Proposed Digital Audio Format

Application of digital encoding to tape recording makes possible piecemeal correction of errors and an instant-comparison system that makes those errors rare.

ENGINEERS at Ampex are currently evaluating various digital audio tape recorder formats. The needs of the professional recording industry have guided this study to determine: reliability in typical operating environments, capability for current and future operating requirements, and potential for future technological growth. Our research has led us to the development of a digital audio recorder format that can serve as a basis for a standard throughout the industry.

Two approaches were initially considered—rotary head techniques such as those used in home and broadcast video recorders, and fixed-head techniques similar to those used in conventional analog audio and instrumentation recording. The choice was made for a fixed-head, longitudinal

digital recorder format, so as to provide multichannel (more than four channels) recording capability and high-resolution, manually—directed editing within the recorder for no additional cost. To explain the advantages of this format, let's first describe the data rate requirements of a digital audio channel.

DATA RATE

Sampling theory dictates that the sampling frequency must be at least one octave above the highest audio frequency; for professional recording usage, the bandwidth of any audio channel should be at least 20 kHz. Therefore, the sampling frequency must be at least 40 kHz. (For more on the subject, see *Digital Modulation For High-Quality Audio* in our June 1978 issue. ED.) To prevent unwanted signals (known as *aliasing products*) from “folding down” from the sampling frequency into the bandwidth of the audio channel, the input audio signal must be filtered, to remove all frequencies above 20 kHz, one-half of the sampling rate.

This is the job of an input (anti-aliasing) filter. However, practical limitations in the implementation of input

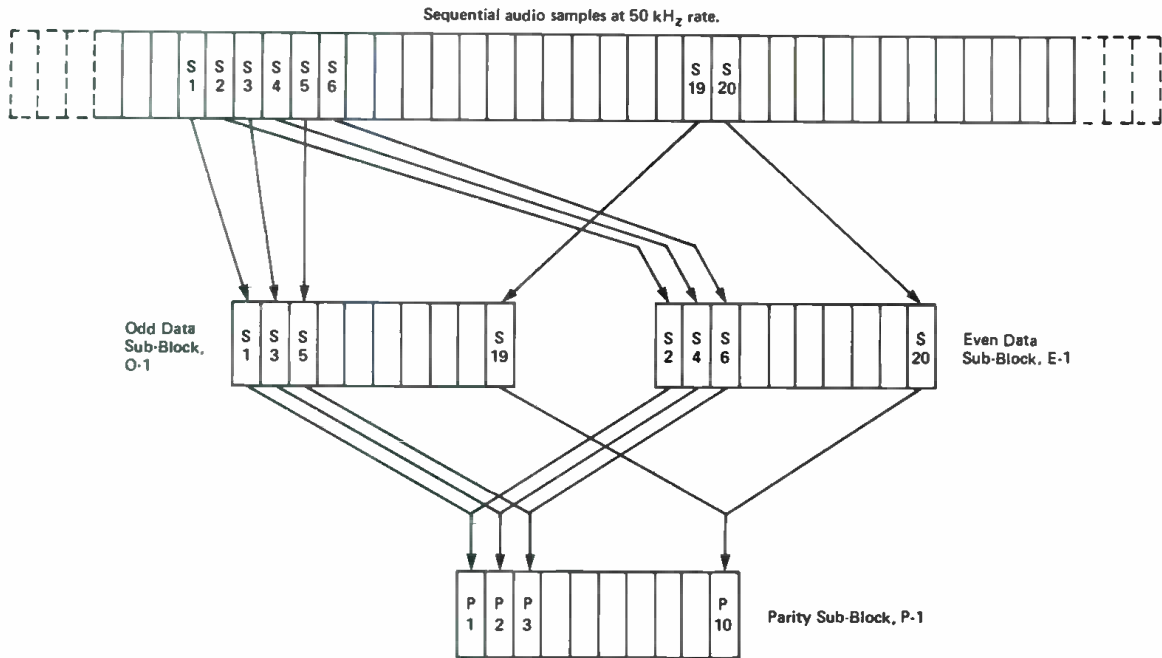

Figure 1. A generation of sub-block triad.

filters require that the sampling frequency be somewhat higher than that required by theory. In other words, some additional room must be given to allow the filter to roll-off the response, from a minimal attenuation at 20 kHz, to at least 60 dB at one-half of the sampling frequency. If the sample frequency was simply set at 40 kHz, there would be an unacceptable roll-off of the upper audio frequencies. This fact, plus a consideration for synchronization of digital audio recorders with future digital video recorders, led to the choice of 50 kHz as the sampling frequency.

16 BITS

The value of each sample is represented by a binary number of 16 bits. This provides a maximum dynamic range of approximately 96 dB, when using a linear encoding representation. Both the 50 kHz sampling frequency and the 16 bit linear sample representation have been endorsed as a potential standard by the Digital Standards Committee of the Audio Engineering Society.

The product of 50 kHz and 16 bits results in a basic digital audio data rate of 800,000 bits-per-second (800 kb/sec). When this basic data rate is to be recorded, additional data, called *overhead* must be added to allow format synchronization, plus detection and correction of data errors.

CHOOSING A TAPE SPEED

When the overhead is added to the basic audio data rate in the Ampex format, the composite (formatted) data rate becomes 1.5 Mb/sec. To provide economical usage of tape and to allow conventional recording time per reel of tape, 30 in/sec was chosen as the maximum recording speed. But with a data rate of 1.5 Mb/sec and a tape

speed of 30 in/sec, the recorded bit density becomes 50 kb/in. This is a bit-to-bit spacing on tape of 20μ in. For comparison, an analog recorder that records a 20 kHz sine wave at 30 in/sec produces a wavelength of $1,500\mu$ in., a difference of 75 to 1.

Experience at Ampex with digital instrumentation recorders has shown that for typical audio recording applications, the recorded bit density should not exceed 25 kb/in. Therefore, we have chosen to divide the composite data rate of 1.5 Mb/sec between two tape tracks, to achieve a data rate per track of 750 kb/sec. and thus, a recorded bit density per track of 25 kb/in.

Figure 2. A tape track format.

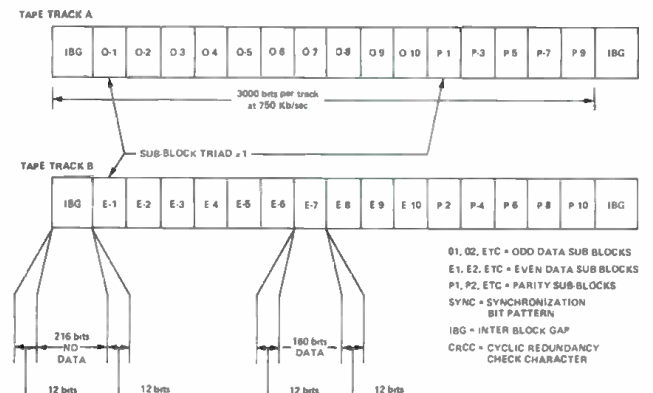

EDITING

The short wavelengths recorded in a digital audio recorder significantly influence practical editing techniques! For example, consider the matter of tape-to-head spacing. During playback, the signal amplitude will decrease at the rate of 55 dB per wavelength of separation between the tape surface and the reproduce-head gap. With 2 bits per cycle, a 25 kb/in. recorded density results in an effective wavelength of 80μ in. To minimize spacing losses, the head-to-tape contact must be held to less than 10 to 20μ in. Fingerprints can easily cause a spacing of 100μ in. and smoke particles are typically 25μ in. in size. Because of the problem of preventing tape contamination, we believe mechanical splicing techniques will not be considered practical for professional recording applications. Instead, editing mechanisms such as those now used in the production of video tapes will become the accepted and desired procedure.

The new format is specifically configured to provide the capability of manually directed machine edits, such as punch-ins, and edits directed by an automatic system. In this new format, the recorded entrance and exit points of edits are executed without destroying or disturbing audio data before, during, or after the edits.

Our mechanism to provide these editing features is to format the recorded data into "blocks" on tape, with defined gaps between each block. These gaps are used for going into—and out of—record, without destroying audio data. This is the same technique used in computer disc and tape drives.

BLOCK REQUIREMENTS

Both physical and electrical considerations led to the final choice of block repetition rate. Data drop-outs which occur must be prevented from destroying the recorder's error—correction mechanism. This requires that the block be physically long enough on tape so the data is adequately dispersed within the block. But this is counterbalanced by the need to repeat the blocks often enough so that physically there are at least two blocks between the reproduce and record heads. This provides for processing of the audio data contained within a block, both within the recorder and within an auxiliary electronic processor, for subsequent re-recording into the same block space as it passes the record head. This feature is necessary to maintain absolute timing between channels of a multichannel recording during editing procedures. The block repetition rate chosen is 250 times-per-second.

SUB-BLOCK DESCRIPTION

A pictorial representation of the electrical process used to format the basic audio data is shown in FIGURE 1. An analog-to-digital (a/d) converter—either within the recorder or without—creates a 16 bit binary number every 20μ s (50 kHz). The top of FIGURE 1 represents the continuous generation of these numbers. To aid this explanation, let's label one of these 16 bit numbers (one sample) S1. This will be the first in a series of 20 samples labeled S1 through S20. The first sample, S1, is placed in the Odd Data Sub-Block, O-1. The second sample, S2, is placed in the Even Data Sub-Block, E-1. Likewise S3 is placed in O-1 and S4 in E-1. This continues until all 20 samples have been divided between O-1 and E-1. Each data sample contains 16 bits and each sub-block contains ten samples; therefore, each sub-block contains 160 bits.

A third sub-block, called the Parity Sub-Block, is created by sequentially comparing the bits in O-1 with those in E-1. For example, the first bit in O-1 is compared with the first bit in E-1. Remember that a binary bit can have

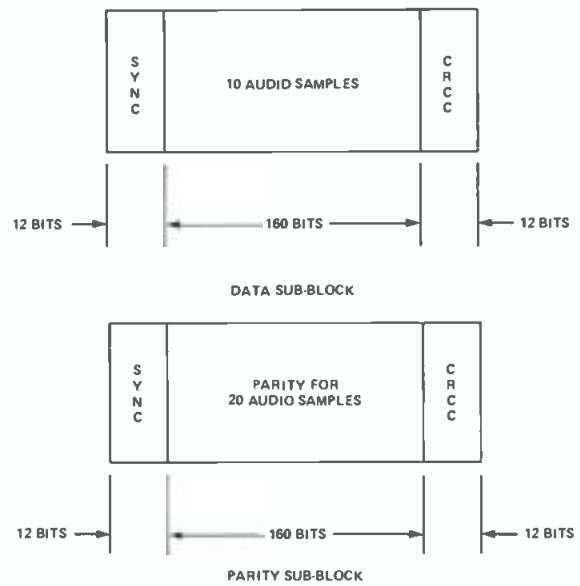

Figure 3. A sub-block construction.

only two values, a "one" or a "zero." If both bits are of the same value, a "zero" is placed in the first bit position of the Parity Sub-Block, P-1. If they are not the same, a "one" is placed in P-1. This continues on a bit-position by bit-position basis until all 160 positions have been compared and all 160 positions within P-1 have been filled. The result is a sub-block triad consisting of O-1, E-1 and P-1.

The next 20 samples will also be divided into a triad. Ten of these triads are then used to create the data block.

TAPE FORMAT

The ten sub-block triads that make up the data block are divided between two tape tracks as shown in FIGURE 2. Tape track A is separated across the tape from track B by at least one track width, to ensure that typical single-event drop-outs can only affect one track of the two-track pair.

Tape track A contains the odd data sub-blocks and track B the even data sub-blocks. Note that the parity sub-blocks are shared between the tracks, with P-1, P-3, P-5, P-7 and P-9 on track A and P-2, P-4, P-6, P-8 and P-10 on track B. This is important for error-correction reasons that will be explained later.

Also included in the data block is synchronization and error detection information. It is possible that when a major drop-out occurs, the recorder's electronics may lose synchronism with the format on tape. Synchronism must be regained as soon as possible to minimize any additional loss of data. To ensure rapid recovery, a 12-bit pattern is inserted at the beginning of each sub-block. This pattern is unique and cannot naturally occur in the audio, parity, or error detection data. A synchronization pattern thus occurs approximately every 0.25 ms.

Just as it is necessary to re-synchronize after a dropout, it is also necessary to quickly and un-ambiguously detect the data errors resulting from drop-outs; it is only *after* detection that errors can be corrected or concealed. A 12 bit error detection character is added to the end of each sub-block and thus occurs at the same rate as the synchronization pattern. This character is in the form of a Cyclic Redundancy Check Character (CRCC). The CRCC is the result of arithmetically dividing the data in the sub-block by a binary polynomial.

Actually, this is a conventional error detection technique and is much simpler to accomplish than to explain.

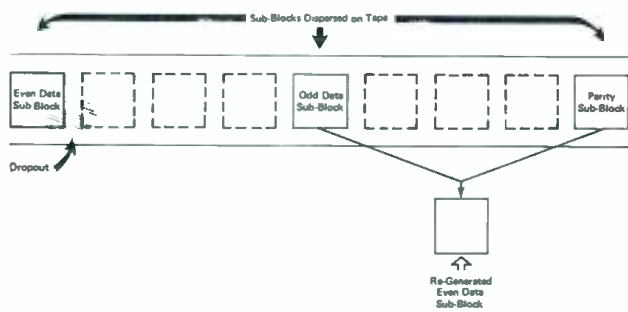

Figure 4. Error correction, using data and parity sub-blocks.

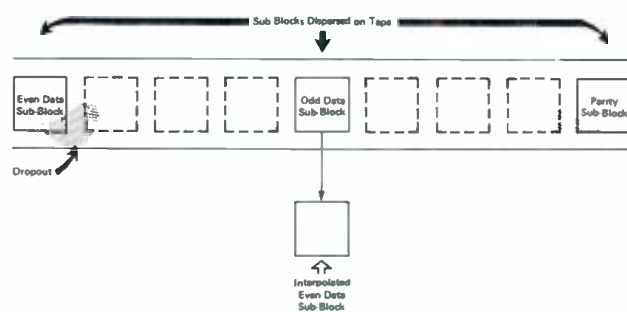

Figure 5. Error concealment by interpolating between samples in a data sub-block.

But stated simply, error detection is accomplished by again dividing the data by the polynomial during playback. If the remainder from this division matches the remainder represented by the CRCC, there is an extremely high probability that no errors occurred during playback in either the data or the CRCC. If an error burst occurred and that burst was less than 12 bits in length, the errors will be unconditionally detected. If the burst error is exactly 12 bits long, the probability of the error going undetected is one in 2048. For burst errors longer than 12 bits, the probability of undetected errors is one in 4096. This gives a potential to improve the recorder's basic bit error rate by 5,000:1, if all detected errors are corrected.

FIGURE 3 shows the construction of the data and parity sub-blocks. The Inter-Block Gap (IBG) that separates the data blocks (and is used to go into and out of record without destroying audio data) also contains a synchronization pattern and error detection character. In the future, the IBG can contain non-critical and generally repetitive information such as time code, data block identification, or editing information.

The data is recorded on tape in the form of an M^2 code, an Ampex-developed code that is self-clocking and d.c.-free, to match the recorder's fundamental lack of d.c. response. Each track has a recorded data rate of 750 kb/sec. The distance from one IBG to another is 0.12 inches and each IBG is 9.6 mils long.

Consideration for providing a good signal-to-noise ratio operating margin for the basic digital channel, together with concern for tape guiding accuracy and intermachine compatibility, limits the minimum tape track width to 15 to 20 mils. This format provides 4 audio channels on quarter-inch tape, 8 channels on half-inch, 24 channels on one inch, and 48 channels on two inches. An additional track is provided in the quarter-inch configuration, and two tracks are provided in the other configurations, that can read data in all tape transport modes for time code or other utility purposes.

ERROR CORRECTION AND CONCEALMENT

For any professional recording format to be accepted, its error-correction mechanism must survive the typical data drop-outs that will occur during playback. This format was designed so that the vast majority of drop-out occurrences do not harm more than one sub-block in a sub-block triad. Additionally, it is important that multiple

drop-outs have a small probability of disturbing more than two sub-blocks.

FIGURE 4 shows a general representation of the three sub-blocks of a triad dispersed on the magnetic tape. This dispersion is both longitudinally along the tape and transversely across the tape. If a drop-out causes errors in an even data sub-block, the odd data sub-block and the parity sub-block of that triad are used to absolutely regenerate the data that was in the even data sub-block. This represents the vast majority of error occurrences and results in complete error correction.

But if two separate drop-out occurrences cause errors in both a data and parity sub-block of a triad, as shown in FIGURE 5, the samples in the remaining data sub-block are used to interpolate the lost samples. The result is a very good approximation that is called *error concealment*.

If both data sub-blocks have errors, the recorder holds the last good sample until the next good one.

Ampex has conducted an evaluation of various concealment schemes using many types of program material specifically selected to expose concealment. Listening tests with concealment of errors representative of this format has shown that skilled listeners find it extremely difficult to detect deliberately repetitive interpolative concealment, even when they know precisely when it is occurring.

A significant advantage comes to this format through the use of two tape tracks per audio channel. If one track of a channel fails during playback, catastrophe is averted! The remaining good track allows interpolative concealment during the time the other track is faulty—a more acceptable situation than the complete loss of a channel.

CONCLUSION

This format was designed to provide the performance and operational features needed for professional and semi-professional recording applications, both in the near future and for those which will be a part of digital recording studios of the future.

We chose two tracks per channel not only to initially provide reliable recorders but to always provide the avoidance of catastrophic failure if one tape track fails.

A significant feature of this format is the ability to do insert recordings without any disturbances to audio recorded before or after the insert. This allows "punch-in" recording as is now done on analog recorders.

We believe this format to be the basis for the professional digital recording standards of today and tomorrow.

SMPTE Time Code Comes to Audio

Synchronizing through the Time Code is a gateway for a proliferation of effects that ordinarily would require multi-track equipment.

ALTHOUGH TIME CODE editing has been *de rigueur* in the broadcast industry for the past decade, it is only now that the SMPTE time code is achieving wide acceptance in audio. SMPTE (for Society of Motion Picture and Television Engineers) time code is a naturally-attractive medium for the audio engineer and studio operator because it improves product quality, productivity per man hour, and hence, profitability.

Not only can SMPTE time code be used to interlock your audio recorders to any video recorder; you can use it to lock together any or all of your existing (or rented) multi-track audio recorders, dramatically increasing the number of available tracks with minimal capital investment. The beauty of the SMPTE time code is that it is already the broadcast and television industry's universally accepted standard code. Thus, whatever you produce using the code can always be interfaced with other equipment at another time and location. Furthermore, as more advanced control, editing, and mixdown systems using SMPTE time code become available, you are assured of future compatibility.

WHAT IS SMPTE TIME CODE?

The basic SMPTE code format is simply a 2400Hz square wave, with data encoded at 4800Hz. It is recorded and played back on a single track, just like any other audio signal, except that the level is usually held to a maximum of around -10 dBm to avoid bleed-through onto adjacent program material. The SMPTE time code is used on magnetic tape just like edge numbers or sprocket holes on film.

The entire address location is coded onto the tape every 1/30th of a second. Each 80 cycles of the basic 2400 Hz tone has a specific meaning according to the universal SMPTE format shown in FIGURE 1. Information is expressed in binary terms (ones and zeros) indicating the presence or absence of an additional cycle at twice the frequency. In practice, the coded signal is created by a

SMPTE code generator as a square wave pulse train that is recorded onto tape during the normal recording process. In playback, a code reader then looks for the zero crossings or transitions between cycles to retrieve the basic code information for conversion back into time. The decoded SMPTE signal can be used to tell you instantaneous *location*, in which *direction* you are moving and at what *speed* you are traveling.

The SMPTE time code is expressed as hours, minutes, seconds and frames. The smallest unit of time actually decoded and displayed by SMPTE code readers is 1/30 of a second because this is the standard US video "frame rate." Although this degree of resolution is adequate for locating park, cue, and edit positions, the full 2400 Hz data rate is used for the continuous synchronizing and interlocking of professional audio recorders to achieve precise control over wow, flutter and phasing. Some synchronizers, such as the BTX 4500 seen in FIGURE 2, take advantage of this high sampling rate to achieve an accuracy within 50 microseconds of absolute mechanical lock.

SYNC WORD

Clearly, when retrieving code at speeds other than play, the frequency of the data is going to change. This doesn't bother the SMPTE reader because it is "self clocking" on what is called the sync word—sixteen consecutive "bits" from 65 to 80 in the SMPTE code format, shown in FIGURE 1. The diagrammatic representation of the code shows how the 80 bits of data are assigned by SMPTE. It's clear that the sync word pattern stands out as being totally different from all other data so it can be recognized by the decoder which, having recognized the sync word, then knows where all other bit locations are.

Approximately half of the available bits have been left unassigned on the diagram. These are referred to as *user bits* and are available for any additional information that may be useful. In practice, they are not generally used, although some studios may use them as a "slate" or, to

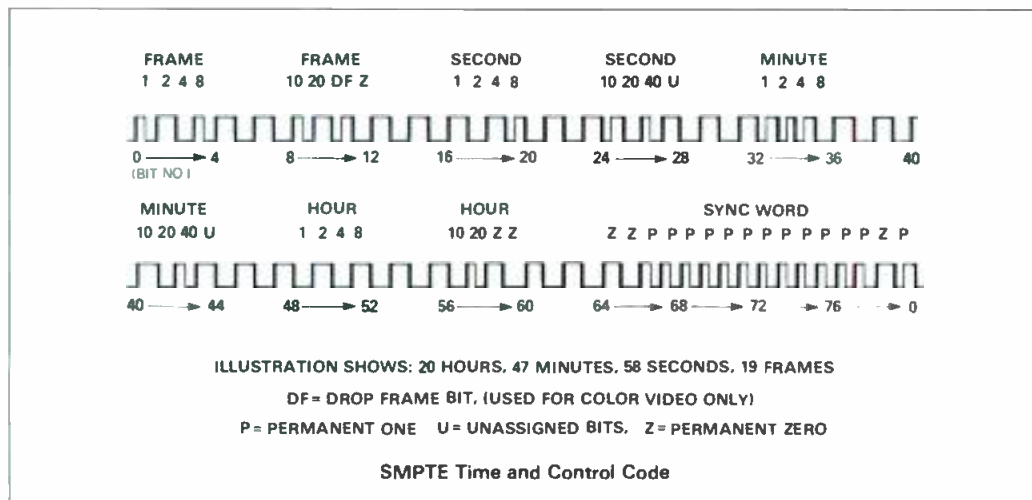

Figure 1. The format for the SMPTE time code.

record the time of day code so as to have a processing log when subsequently editing the program material.

PRACTICAL AUDIO USES FOR SMPTE TIME CODE

The most cost-effective and profit-producing audio application of the SMPTE time code is synchronizing any two multi-track recorders for additional track capacity. With more and more producers calling for 30- and 40-track capability, few facilities can meet their needs with existing recorders. Adding SMPTE time code synchronization can virtually double the multi-track capability of a studio at a minimal capital investment.

Typically, the maximum number of tracks is needed only during the final mixdown. For best economy, all the original session recording can be done on a single 16- or 24-track machine. The original master can be built up in the usual fashion to contain the instrumental tracks. A rough mix of this is dubbed to a 1/4 in or 1/2 in. machine for synchronized reference playback during the recording of a second master on the same 16- or 24-track recorder to contain the voice tracks plus any needed overdub. In this way, as many as 30 or 46 audio tracks may be laid down sequentially using only one multi-track recorder.

At the final mixdown, the two multi-track masters are played back to the board on two SMPTE-synchronized multi-track recorders (which may be located in different control rooms). While simple SMPTE synchronizers function only in record/playback mode, more complex SMPTE time code control systems provide full control of all tape motion from a single keyboard. This virtual doubling in channel capacity is achieved at the one-time cost of an SMPTE synchronizer, and the ongoing cost of one audio track on each multi-track tape to be synchronized.

GETTING INTO AUDIO FOR VIDEO PRODUCTIONS

With today's increasing interest in improving the production quality of t.v. audio, the audio studio or production house can significantly increase its market by equipping to handle the audio-video interface. The Soundmixers facility pictured on this month's cover typically makes a SMPTE time coded U-matic video cassette from a customer's 35mm film or video tape master. This duplicate can be viewed by the conductor, producer, et al. while creating a multi-track music master tape of any desired number of tracks or complexity. After editing and post production

are complete, the ultimate mix, still SMPTE-encoded, is transferred back to the video master.

Harry Hirsch of Soundmixers has introduced a Vidicue service, whereby a conductor is videotaped during an original recording session. His fully synchronized visual cues are then available for playback during subsequent rerecord and overdub sessions, even after he has left the studio, effecting a substantial saving in talent cost.

GETTING READY FOR ELECTRONIC EDITING

Beyond using code for location and interlocking, there is real potential for automation systems that provide the audio studio with the powerful editing capabilities now commonplace in video production. These benefits can be achieved without constraining the quality of the final product, or the flexibility in production techniques demanded by the audio professional.

The Studer TLS 2000 and Ampex MQS-100 systems, as well as the new BTX 4600 shown on this month's cover (to the right of the Apple computer), provide both control and editing functions from a single keyboard location. All these systems deliver programmable control over multiple

Figure 2. BTX Model 4200 edit code reader and a digital display and Model 4500 edit code synchronizer in a rack mount.

The edit code synchronizer is the basic SMPTE time code system building block. With one such unit and a master tape containing the SMPTE time code, a studio can begin using the code.



GO TO, FOLLOW, RECORD-IN and **RECORD-OUT** functions which can significantly reduce audio production times, and improve the final result. The Model 4600 micro-processor-based system even "learns" your conventional manual controls and allows you to preview and fine-tune your production sequence any number of times before committing to a final mix.

From an operation point of view, it is quite acceptable to pre-record the SMPTE code on all multi-track masters and then subsequently synchronize the tapes during the actual recording session. In this way, a time code generator is not required during live production. The alternative is to run the recording session with each recorder running on its own internal reference and simultaneously record time code on each tape from a master generator. The program and the code are thus exactly related for subsequent synchronization, even though the recorders were not interlocked during the recording session. It's worth noting that SMPTE synchronizers can handle code differences between the master and slave so you can mix tapes, codes and even speeds, provided you introduce the desired offset. Usually this is accomplished by ear or eye using an advance or retard "slip" function on the synchronizer itself.

CONFUSING TERMS MADE PLAIN

Two confusing terms that occasionally come up in discussions about SMPTE are *drop frame* code and *jam sync*. Drop frame refers to a special version of the basic code that has been modified to compensate for video color frequency that normally would cause a one-hour video show to play back 3.6 seconds longer. By dropping two frames every minute except every tenth minute (108 frames or 3.6 seconds per hour) the SMPTE standards committee enabled the time code for color video to agree with real time of day.

As long as you don't try to mix standard and drop frame time code, it doesn't matter which you use. To avoid any confusion between the two codes, the eleventh bit tells any decoder whether the code presented to it is standard or drop frame. Most SMPTE time code systems are switchable for either code format.

The term *jam sync* refers to the ability of code generators to lock on to an existing code to provide continuous code output when extending a recording or replacing a poor code. The system remembers the last legitimate code, and if the code drops out, becomes unreadable, or erroneous, the generator substitutes an ongoing good code from its internal time base. Also, some code readers simultaneously regenerate the code being read so that a freshly generated identical code can be simultaneously dubbed.

HOW TO GET SMPTE CODE ON THE TAPE

From a suitable source of SMPTE time code, a code track is recorded on any desired track of the master tape. Early video practice required code levels of the order of +3 dBm to decode accurately, leading audio users to allow a buffer track between the code track and the nearest program track. Fortunately, present state-of-the-art SMPTE products operate satisfactorily at code levels down to -18 dBm, which obviates the necessity for a buffer track and eliminates any possibility of the code signal bleeding through to an adjacent program track.

To use SMPTE for hand jogging or during fast forward or rewind, it is important to preserve the playback signal level without high and/or low frequency roll-off. High performance digital code readers, such as the BTX 4200 seen in FIGURE 2, are capable of reading playback signals all the way from 1/10 to 80 times play speed.



Figure 3. The BTX Model 4100A SMPTE code generator is used to lay down a code track on audio or video tapes.

The source of a SMPTE time code may be either a generator or a master tape on which the code has been pre-recorded. In the event that a time code tape is used, one must pay careful attention to the time base quality of the code source from which it was made. Wow and flutter, for example, grow exponentially with each dub, so each time the SMPTE code is transferred, it picks up time base jitter from both recorders, which is then faithfully followed during any subsequent synchronizer operation. Master SMPTE generators such as the BTX 4100A seen in FIGURE 3 are usually specified at 2½ microseconds maximum time jitter, which is an order of magnitude better than the flutter and wow of the finest extant professional audio recorders.

EQUIPMENT REQUIREMENTS FOR USING SMPTE CODE

There are several cost-effective levels at which to introduce SMPTE time code into your studio or production facility. The basic need is for a code generator or other source of code, such as a high quality SMPTE code master tape. Once you can record the code and lay it down on everything you do, even though you may not use automation now, the material can subsequently be processed when you do go the automation route, or used in the meantime by others who are automated.

A synchronizer comes next. This component can quickly pay for itself in increased track capacity and the ability to provide audio production services interlocked with video or film. The whole field of professional audio production techniques is now available for use in video programs and is already providing a booming add-on business for many studios.

Where the ultimate wow and flutter specs are not necessary (for exclusively in-house use or where the total number of generations is minimal), it's entirely possible to start with a synchronizer alone, and use a master tape containing code that has previously been recorded using someone else's generator. This technique is adequate for many studios initially, although having a master generator in-house is much more convenient.

The ultimate in production flexibility, of course, is to acquire a SMPTE control system which takes the engineer/mixer's hands off the tape machines and lets him concentrate on producing a first-class program. ■

Automating the Automatt

Even the ultimate computerized studio needs human expertise to push the right buttons.



The scene of our story—Studio C control room at the Automatt.

IF YOU'VE been watching any sci-fi movies lately, you already know that its only a matter of time before the computer takes over completely, while all us human-types are reduced to some level of space-age helplessness. In *The Forban Project*, an American and a Soviet computer join forces to keep humanity in line. And in *2001*, there were some nasty moments when "Hal" got carried away with himself (itself?).

A bit closer to the real world, I find that I have owed the computer at Gimbel Brothers some \$2.35 for about a year now. There's no point in writing a letter about it. The computer is not programmed to respond to humanity. There's only one thing that will clear me from its memory: \$2.35.

Moving right along, several blocks from San Francisco's Automatt Recording Studios (we'll get there in a few more paragraphs), stands the spectacular Hyatt Regency Embarcadero Hotel—a "must see" for every visitor to the Bay

area, and one of my favorite watering holes. Need I tell you the Hyatt's reservation service is run by a computer? This marvelous machine may quote you one rate in advance, then bill you at another (which is naturally higher). If you are a frequent visitor (I am), you may have a favorite room. Don't bother asking for it—the computer can't handle such matters. Things are worse at the Hiltons. There, a minor schedule change erases you entirely, and you arrive to find the computer has no record of you whatever.

And now—computers in the recording studio! What sort of indignities lie in wait for us as these infernal machines take over?

Well, it depends. Are the horror stories mentioned above (and you can all add your own to the list) *really* the computer's fault? Of course not. If I've learned nothing else during my expedition into computer-land (see this month's Sync Track), I have discovered that the computer

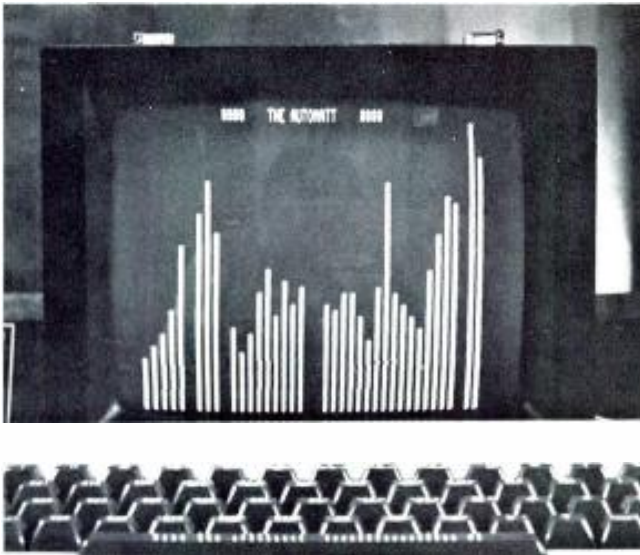

Figure 1. A graphic representation of the mix is displayed on the video screen.

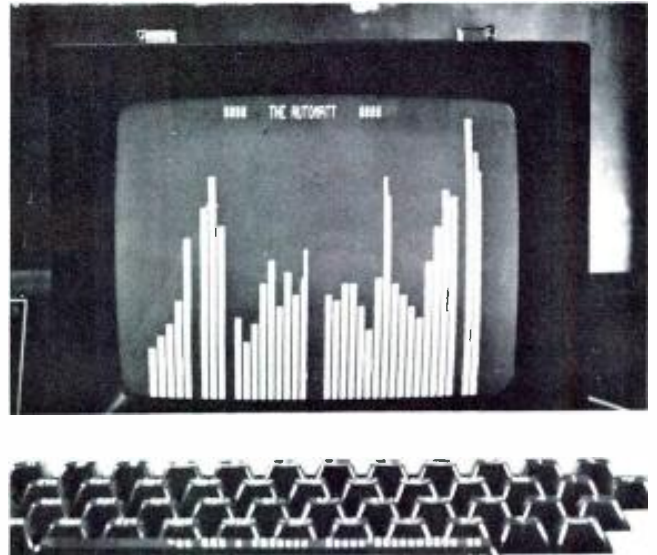

Figure 2. The visual display depicts current console settings alongside the "frozen mix" (see Figure 1). The three unmatched bars indicate that the current console settings do not match the previous mix.

is spectacularly dumb. It is incapable of interpreting nuances, of comprehending sudden changes, of appreciating hidden meanings, or of figuring out what you *really* mean, even if you don't say it quite properly. In short, it is only capable of responding to a properly-executed program.

Therefore, most of the problems with computers are really problems with computer programmers. There's the famous story of the computer that sent out "balance due" messages to charge account customers. If you owed nothing, you would get a bill for \$0.00. One month later, you'd get an overdue notice, and eventually your account would be turned over to a collection agency. Apparently, someone had forgotten to program the computer to ignore zero balances.

No doubt, the recording industry will see its share of such nonsense if recording engineers do not learn how to keep one or two steps ahead of their systems. In other words, a little knowledge of computer programming will be quite handy—perhaps even essential—as the computer takes on more and more significance in the studio.

AUTOMATT

And now, to the Automatt, and a look at how they're coping with the computer. But first, a little background might be in order. The studio opened in November, 1976—the brainchild of producer David Rubinson and recording engineer Fred Catero, who, along with Michael Larner, the Automatt's chief (design) engineer, have assembled an impressive array of automated recording hardware.

Actually, the Automatt now consists of four studios, two of which were formerly owned by CBS Records. These were incorporated into the Automatt complex when CBS closed its San Francisco operation. Studio A is the largest in the Bay area, with some 1,500 square feet of floor space. The A and B control rooms both contain CBS-custom designed boards, with 38-in/24-out capability. The fourth studio (D) is a private demo/rehearsal room, not yet available for outside clients.

But our story really begins and ends in Studio C—the original Automatt, where Rubinson and Catero spend

most of their time with up-and-coming artists like Santana, Patti LaBelle, Herbie Hancock and such. As a matter of fact, during my visit, I was able to successfully halt production of the latest Peter, Paul & Mary album (*Reunion*: Warner Brothers BSK 3231), while Rubinson, Catero, Larner and I rambled on about audio and automation, and Peter Yarrow had another cup of coffee. But, as the ad in *Billboard* says, it's the first PP&M album in nine years, so what's another hour or two?

The heart of the Automatt's Studio C control room complex is the Harrison model 4032 Master Recording Con-

Figure 3. This interface of systems is capable of storing any desired text along with the console automation data on the tape. Automatically recalled the text pictured includes information regarding track assignments, musicians, artist's name, title of song, and recording personnel.





Engineer Fred Catero explains the intricacies of the Harrison board, while Michael Lerner (far right) keeps an eye on things.



This is an automated system? Well, sort of. In his spare time, David Rubinson is an avid collector, polisher, and restorer of early jukeboxes. Some of his favorites are on display at the Automatt.

sole, and Allison Research's second generation "Memory Plus" 65k bit automation system. Mike Lerner has interfaced these with a Zilog Z-80 microprocessor computer system.

At the moment, Lerner's Autoscreen interface is the only one of its kind in the world. And the usual patents are out there pending somewhere. Of course, Harrison, Allison and Zilog products are all commercially available, but Lerner's interface isn't, so the following brief description may help.

AUTOSCREEN

Essentially, the Autoscreen is a visual monitor of the "Memory Plus" system. The Zilog computer is programmed to display dynamically—in real time—a bar graph format of the decoded analog voltage levels returned to the console. In English, this means that the bar graph seen on the CRT monitor presents a visual representation of the positions of each of the console's forty input faders. (In FIGURE 1, faders 6, 10, 20, 21 and 38 are off.) The display is an un-ambiguous visual confirmation that the total system is properly functioning. Note that the bar graphs do *not* represent audio levels, and should not be confused with peak reading or vu-type displays seen elsewhere.

Lerner has provided a "freeze" function which allows any mixdown setting to be displayed indefinitely. This can be handy if you're wondering what happened to the seventh guitar punch-in on track fifteen, during the next-to-last mixdown. At the appropriate moment, the display can be frozen, and then compared to the same moment during the last mixdown. For example, a close look at FIGURE 2 will reveal that three of the faders (19, 29 and 40) are in slightly different positions, indicating that the console settings do not match the previous mix.

This same function can be used to advantage to return all faders to their starting position during the course of any mixdown session.

Another Autoscreen function is the storage of several "pages" of information relevant to the session. For example, FIGURE 3 shows an obvious example, the "track sheet" for Patti Labelle's *Save The Last Dance*. Going one step further, it would be no big deal to store data about the

microphones used, equalization settings, or whatever, for recall two weeks later when you're trying to figure out how to match the sound.

By the way, all this information can be stored on the multi-track master tape, for future reference. Every time the master tape is put on the machine, the data may be dumped back into the Autoscreen's memory, and displayed on the CRT. That way, you can't misplace the information. (Unless you misplace the master tape, of course. But in that case, who needs the information anyway?)

Naturally, the computer can handle such mundane tasks as re-creating the entire mixdown, without the lead vocals. And this comes in handy when your favorite client (you know—the one who pays his bills on time) gives you at least an hour's notice that his group will be appearing on live t.v. tonight, and he'll stop by in a few moments to pick up a vocal-less mix, so the group can sync along on the show.

FUTURE APPLICATIONS

Lerner is now working (or thinking about working) on computer access to the audio lines for automated measurement of noise and distortion. Eventually, it should be possible to obtain on-screen readouts of either console or tape recorder output parameters. And, with more and more outboard equipment using digital technology, it should be possible to have the computer keep an eye on external signal processing devices. Which brings up some interesting new prospects.

Unless the studio has an unlimited budget, there comes a time when there just aren't enough signal processing devices to go 'round—especially with 24 or more tracks! So, why not let the computer move the signal processing devices around, as required—perhaps changing settings as well—and thus letting one device do double duty? (Within reason, of course.)

WHO NEEDS ALL THIS?

While the Automatt may be several steps ahead of the pack in creatively exploiting digital technology, there are still those who criticize the very concept of automation, and who blame technology in general for the often-rotten

sound of many modern recordings. Fred Catero feels that with the way recording technology is advancing these days, the computer becomes a necessity. He acknowledges that it will be used as a handy crutch by some, who view each new device as a means to encourage sloppier engineering. But these are the same folks who now routinely plug in a compressor *before* the session begins, since it saves the bother of keeping an eye on levels.

Since the computer is so incredibly versatile, it gives the incompetent user an unprecedented number of ways to destroy a performance. Even now, Catero notes that many of today's records are no better, and often worse, than those of twenty years ago. Why? Simply because the engineer (or producer) has either forgotten—or never learned in the first place—his craft. He or she relies on the vast array of buttons, knobs, and switches, and couldn't record a sweetening session in good old stereo if it were a matter of life and death. Rather, there would have to be a track-bouncing session first, to free up at least a half dozen tracks. Such folks shouldn't be allowed near an automated studio.

As a matter of fact, the Automatt does not actively encourage guest engineers, unless they really know what they're doing. Indeed, Catero finds that many are reluctant to use the computer. It's a whole new ball game, and many would rather not play, for fear of striking out.

Some of this reluctance is quite understandable. For even the best analog-trained engineer, the computerized studio is a strange new world. Ironically, some good engineers shy away from automation because—as professionals—they are well aware of their lack of competence in this specialized area. In the meantime, fools rush in, blissfully unaware of their total incompetence. And then, some critic will come along and blame "the technology." But, as Catero is the first to admit, in practically every case of malfunction, the fault can usually be traced back to the operator, and not to the computer. (Maybe someday, even the hotel reservation geniuses will figure this out too.)

FROM THE PRODUCER'S DESK

David Rubinson offered a general over-view of the world of automated audio, seen from the perspective of the producer. To him, the technical advances represent freedom from much of the "donkey work" (remembering to bring the vocal in on time; (killing the horn during the bridge, or whatever). It allows him to be a lot more creative, and less of a gymnast.

In the traditional multi-track mixdown session, the hardest thing to do is to listen to the overall performance. Too much energy is spent remembering cues. The great advantage of automation is to allow the producer to concentrate on listening, and hearing the performance emerge, while the computer does the dirty work. Now, there are no more reasons for not getting it completely right, and so, the producer may set his sights much higher.

The implementation of technological advances should really be a cooperative venture between the scientist and the philosopher (that is, the engineer and the producer). In a way, the automated control room is a microcosm of what we face in the world today. Who controls the computer? Who tells it what to do? Who decides when the mix is really finished? How do you prevent "it" from taking over?

Rubinson feels this is nothing new. The problem has been with us since the invention of the printing press—and maybe since the introduction of the wheel. In the control room, as elsewhere, education is the answer. The producer must learn how to deal with the technology. For him, part of the answer is to rely on his engineers, and not to lose sight of the whole while working on the sum of the parts.

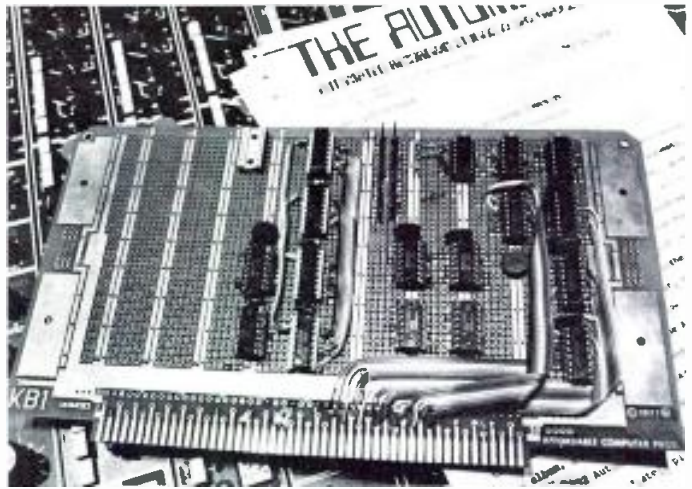

Michael Larner's Autoscreen interface card joins the Harrison, Allison, and Zilog systems, and permits CRT readout of the Allison functions.

When you're able to work in little bits and pieces, as you are in a computerized world—in fact, as you *must* from time to time—there is a tendency to lose sight of that whole. It's easy to get immersed in little fragments of a mix, getting each one right, while losing the overall thread of the performance.

So, it's important to keep an eye on that first priority—which is to make a record, not to assemble a collection of cues. But, how do you decide if the mix is good enough? One of the marvelous aspects of computerized mixdown is that it allows the added ingredient of time. It's not necessary to decide *now* (after too many hours, not enough sleep, and too much coffee). You can come back tomorrow, or the next day, after a good night's sleep, a little breakfast, and apply a little hindsight. If it would take hours to duplicate that almost-perfect mix, you might be tempted to compromise, and accept what you have. But if the computer will put you back in business within minutes, and those minor changes can be made without agony, then why accept anything less than perfection?

Of course, you've got to know when to stop. You can mix, and re-mix, for weeks, and be no better off than you were with "take 1." But that's not the computer's fault.

AFTER AUTOMATION, WHAT'S NEXT?

Why, digital tape recorders, of course. Not according to Rubinson, who views the tape recorder as somewhat of an anachronism in the computerized world. To him (a non-engineer), the idea of tape storage on a reel of finite length, is rapidly becoming an absurdity.

He recalls that Guillaume Appollinaire of the Dadaist movement said that once upon a time there were cavemen who wanted to be able to move about much faster. Surely, some of them thought about building bigger feet, but eventually someone discovered a better way—the wheel. At the time, it was quantum leap forward in thinking—a whole conceptual re-organization of movement.

Well, Rubinson calls for a conceptual re-organization of our thinking about data storage. Why tape? It has to be treaded and rewound, and it takes too long to get from one end to another, especially in comparison to the micro- and nano-seconds of the computer world. Why not a memory core of some kind with much easier data retrieval? Like the wheel, it would be another quantum leap forward.

Chances are, Michael Larner (and a lot of others) are working on it right now. So, hang in there David. Maybe for PP&M's next reunion album . . . ?

Three generations of Auto-Locators

*Special tape effects require locating the exact spot;
new technology provides speed and accuracy.*

TODAY'S sophisticated recording technology is often taken pretty much for granted, and it's easy to overlook the fact that our industry (that is, the one we know today) really got started not much more than twenty years ago. For it was in the late 50's that Les Paul and Mary Ford ordered a custom-built eight-track tape recorder from Ampex. With it, they set out to revolutionize the recording industry—their sel-syncing and re-recording techniques marked the beginning of the new era of multi-track processing.

However, the multi-track recording technique got off to a fairly slow start, and it was not until almost a decade later that significant numbers of multi-track recorders began showing up in recording studios. Then, as engineers and producers began developing their new multi-track recording techniques, it became obvious that this new technology would open up a whole new world of creative possibilities.

But while the multi-track recorder offered solutions to many old recording problems, it also introduced a few new ones. For example, more tracks meant more noise—a temporary problem until Dolby, and later, dbx, came along.

REWIND

Another problem—and the subject of this story—was the new-found annoyance of having to return again and again to the same spot on the tape, as producers discovered the fine art of “punching-in.” Often, it was necessary to assign a second man to the session; his sole job might be to rewind the tape (quickly!) each time the artist wanted to try the effect again. More often than not, the rewind would be to some intermediate location on the tape, and a lot of dexterity—plus some educated guesswork—was the rule of the day.

Along the way, countless tweeters were blown, and probably a few tapes were destroyed as well. Obviously, a solution was needed for this new problem so that the engineer's creative skills would not be wasted wrestling with the logistical problems of cueing up the tape recorder for the hundredth time.

REMOTE CONTROL

A tentative start toward solving the problem was the introduction of tape recorder remote control systems. These at least brought the transport and record/sync/playback controls together, into a reasonably compact package, which—in the case of the one-man session—could be placed near the recording console. In 1967, Scully introduced its Sync Master and at about the same time, Ampex adapted one of its video devices to work in a similar manner.

Scully's next offering was the Index Master. This was a remote readout device which enabled the operator to give



The first of its kind: MCI's early Auto-Locator, seen here sitting on top of an MCI JH-16 recorder.

a position on the tape an "address" with which it could be identified. This address had no relationship to time or the amount of tape used. The location was addressed by using four magnetic slugs in each quadrant of the circular brake disc of the torque motor. A reed relay attached to a counter would search the address while in rewind, and stop close to it. Due to tape slippage, the method was close, but not precise. But The Index Master can be considered as the forerunner of all true automatic locating devices.

Two key features of this first Auto-Locator were significant enough to be adopted eventually by all other manufacturers of automatic locating devices. The first innovation was a digital up/down counter. A sixty-aperture strobe-reader assembly was affixed to the takeup motor shaft, and its output was directed to a pre-counter, where a digital divide-by-twelve function occurred. This fur-

AUTO-LOCATORS: THE FIRST GENERATION

At the fortieth convention of the Audio Engineering Society (Los Angeles, April, 1971), Ampex, MCI and 3M each introduced a new tape location device. Ampex's Search and Cue Accessory and 3M's Selecake were similar, in that they were both "search-and-hunt" devices. Both would search for a pre-set reference point. The transport would go into rewind (or fast forward), and when the reference point was reached, the brakes would quickly be applied. Since there was inevitably some "overshoot," as the machine came to a halt, the transport would automatically shuttle in the reverse direction, again passing the pre-set point and applying the brakes. Each time this was done, the unit came closer and closer to the desired location, eventually coming to a complete stop.

The MCI Auto-Locator accomplished the same function in a somewhat different manner, which was described in the AES preprint, *An Automatic Tape Position Locator* (AES Preprint 804—II). The paper was written by James C. Strickland who, at the time, was MCI's chief engineer.

3M's earliest Selectake.



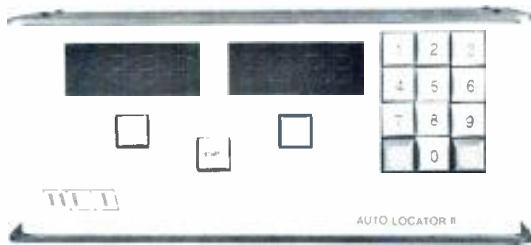

The Auto-Locator II added a keypad entry system and two readouts.



The latest generation: the Auto-Locator III, uses microprocessor technology to offer the harried engineer even more assistance.

nished a digital readout that incremented by five for each revolution of the take-up reel.

The second feature was a predictable digital-to-analog ramp, to convert the digital down-count to an analog ramp voltage. This gradually-diminishing voltage would slow down the transport until it stopped at the pre-selected zero point. Using a servo-controlled approach, the Auto-Locator brought the transport back to the pre-set display zero at a velocity which decreased as zero was approached, in contrast to the shuttling technique employed in the Search And Cue, and Selectake designs.

THE SECOND GENERATION

The Auto-Locator II took over servo-control of both spooling motors during the locate function, thus permitting a smoother "glide into zero," without tape slippage. It also incorporated two displays—one for *tape* position, and one for *locate* position. In addition, a 3x4 keypad was pro-

vided. Ten of the keys allowed the operator to enter a desired timing (in minutes and hundredths) into the *locate* position. If desired, another key would transfer this data to the *tape* position. Conversely, the *tape* position could be transferred to the *locate* position by depressing the twelfth key. Either *tape* or *locate* could be reset to zero simply by depressing the appropriate *reset* button. Finally, the *start* button would put the transport in the rewind or fast-forward mode, until the actual *tape* readout coincided with the *locate* readout. As mentioned, the transport would gradually slow down as the *locate* position was approached.

Similar units from other manufacturers include 3M's Selectake II, Studer's A80 Pre-Selector Unit, Lyrec's Tape Position Controller, and Ampex's Search-to-Cue for the MM-1100. An interesting feature introduced in the Selectake II was a nine-position memory, allowing storage and recall of nine different tape positions. (For a picture, and brief description of the Lyrec Tape Position Controller, see our May 1977 issue, page 30, 34, Ed.)

THE NEXT GENERATION: MICROPROCESSOR TECHNOLOGY

Automatic tape position locating devices have now entered a new generation with the advent of microprocessor technology. For the first time, a firm which does not manufacture tape recorders is offering such a device. Audio Kinetics Ltd. has available the XT-24 Intelocator; a microprocessor-based unit which will operate with tape recorders of almost any manufacturer. (And for more details on this incredible device, see our May, 1978 issue, page 41, Ed.). Such firms as 3M and AEG-Telefunken also offer automatic locating devices using microprocessors, as does MCI's new Auto-Locator III.

There are many advantages to using current microprocessor technology in tape locating devices. For example, it is now possible to increase functional capabilities, to minimize component count (thereby improving reliability), and to get away from mult-layer printed circuit boards.

Since the new generation of locating devices are all similar (although of course not exactly the same), a discussion of the Auto-Locator III should give a good idea of what to expect from the new generation of microprocessor-based designs.

THE AUTO-LOCATOR III

The new Auto-Locator III contains all the functions of the Auto-Locator II, plus ten individually-addressable memory locations. The unit displays real time in minutes

On the left, Ampex' Search-To-Cue and tape timing accessory. Next to it is the Audio Kinetics XT-24 Intelocator, which may be interfaced with Ampex, 3M, or other machines.





3M's Selectake II.

and seconds, with the *tape* readout giving indications in the negative or positive domain, depending on whether the actual tape position is behind, or ahead of, the *locate* readout.

A "shuttle," or repeat, function commands the transport to play a specific segment of the tape over and over again, until the operator commands otherwise. This can save a lot of tedium during rehearsals of punch-ins and such. An additional convenience is the conversion of "illegal" entries into minutes and seconds. For example, a keyboard entry of 01:99 will be displayed as 02:39.

TAPE VELOCITY INDICATOR

The Tape Velocity Indicator (TVI) is a completely new

Ampex' Multipoint Search-To-Cue for MM-1200 and ATR-100 series recorders. Up to twenty cues may be stored in memory.



function for the Auto-Locator. Although certainly not an absolute necessity, it is an excellent example of the type of new features that we will also take for granted eventually, as microprocessor technology becomes more widespread.

In the TVI mode, the *tape* readout indicates the running speed of the tape recorder, in inches-per-second, while the *locate* readout displays, in eighth-tone musical increments, the tape speed's deviation from normal. This convenience allows the operator easily to "tune" the playback pitch (that is, speed), using musical, rather than mathematical, values. Tuning is accomplished in the customary manner, using the variable speed control.

CONCLUSION

The early Auto-Locators—using the then state-of-the-art TTL digital circuitry—enabled the tape transport to decrease speed as the zero point was reached. The transport stopped just past zero, giving a short "cue up" time to the operator and musicians.

Now, using microprocessor technology, Auto-Locators are not only more accurate and dependable, but they also do more for studio personnel—such as offering real time read-out, shuttling features, memory functions, and of course, TVI. The value of the Auto-Locator to the recording industry is well on its way to being taken for granted: virtually no studio is without one. (And MCI's role in the development of sophisticated tape location devices is also taken for granted now. The term "Auto-Locator" was coined by MCI, just as "Sel-Sync" is the property of Ampex. Yet, what do you call your device? Even if it wasn't made by MCI, we'll bet you refer to it as your "Auto-Locator." ED.) ■

Tapes wiped clean in only 4 sec.



GARNER TAPE ERASERS

provide clean erasures in only four seconds—with no noise residue. Tapes are wiped cleaner than new. Our simple, safe, continuous belt operation handles all sizes of reels, cartridges and cassettes. Several models: Up to 16". Also Video Erasers.

Garner Erasers are now fulfilling the exacting requirements of many major organizations around the world...yet are so low priced that the smallest studio or station can afford one.

User reports... "It is a big improvement over what we used to use, or anything else on the market today."
— Ric Hammond, KNX Radio (CBS), Hollywood, Calif.



Call today or write for brochure.
GARNER INDUSTRIES
4200 N. 48th St., Lincoln, NE 68504. Phone: 402-464-5911

Digital News Briefs

Digital editing does away with the razor blade.



Frederick Fennel conducts the Cleveland Symphonic Winds at the first digital recording sessions April 4-5, 1978 at Severance Hall in Cleveland.

A FEW MONTHS AGO, 3M announced that A & M Records, The Record Plant, Sound 80 Studios, and Warner Brothers Records will be the first four studios to take delivery of the company's new Digital Audio Mastering System. For a photo of the system, see our July 1978 issue, p. 40.

These little \$150,000 trinkets record 32 channels on one-inch tape, and also include a 4- or 2-track machine for mixdown. But don't reach for your check book just now: for the moment, the machines are available on a lease-rental basis only.

Three of these systems have been assigned to studios near 3M's Mincom division manufacturing facility in California, while the fourth goes to Sound 80, near the company's St. Paul, Minnesota research facility. This enables 3M to offer maximum support in getting the machines off to a successful start.

WHAT ABOUT EDITING?

If you've been following digital developments, you know that editing is not quite the cut-and-splice technique so well-known in the analog world. Even if the

comparatively delicate digital tape could stand up to the abuse of the trusty, rusty razor blade, the most gifted editor would still have a hard time trying to figure out on which pulse to make the cut.

For the moment, digital editing remains in a sort-of limbo, but apparently the situation is about to be rectified. 3M has promised to unveil a prototype electronic digital editing system at the Audio Engineering Society convention in New York City (3-6 November).

Although preliminary information is sparse, the new system does away with razor blades by copying the digital signals in a pre-determined sequence, in order to create a splice-free master. While artistic judgments are left to the producer, the actual sequential-copying operation is microprocessor-controlled.

One of the advantages of electronic editing is that potential "splices" can be previewed and revised without chopping up the tape. To make the edit, the operator listens (at normal playback speed), then stops the tape and views a graphic representation of the sound on a video monitor. After satisfactory matching of sounds and

graphic representations, the time-encoded points on the tape are registered in the microprocessor for later automatic synchronizing, when the copying sequence occurs.

If you're wondering what all that means, you're in good company. We haven't got the foggiest idea either. But if you're at the AES show, come on over to the 3M demonstration, and we'll find out together!

For the moment, we can only say that the system comprises a table-based video screen and keyboard, selected tape recorder controls and associated microprocessor systems. Programming sequences are interactive; the system leads the operator through the appropriate steps, asking for human decisions at each point.

DIRECT-TO-DIGITAL RECORDING

Now that we've made digital editing perfectly clear, we should mention that the first commercial classical disc recorded in this country via digital processing should be waiting for you in your local high-fi haven.

The record, released on the Telarc label, features Frederick Fenell conducting the Cleveland Symphonic Winds in a program of Gustav Holst's *Suites Nos. 1 and 2 for Band*, Handel's *Music for the Royal Fireworks*, and the Bach *Fantasia in G*.

The program was recorded in Cleveland's Severance Hall, using Dr. Thomas Stockham's Soundstream digital



Key figures in Telarc's digital recording sessions listen to a playback at the mixing console. Left to right: Dr. Thomas Stockham, inventor of Soundstream digital tape recorder; Jack Renner, recording engineer; conductor Frederick Fenell.

tape recording system. No compressors, limiters or equalizers were used, and, to get the best pressings possible (no easy feat these days), the master was cut at half-speed at the JVC Cutting Center in Los Angeles by Stan Ricker. The LP's themselves were pressed in European plants.

The Telarc label is distributed by Audio-Technica, Inc. and this record (Telarc .5038) lists for \$14.95. ■

The operator's panel on 3M's Digital Audio Mastering System. (Maybe next month we'll have a picture of their new digital editing system.)

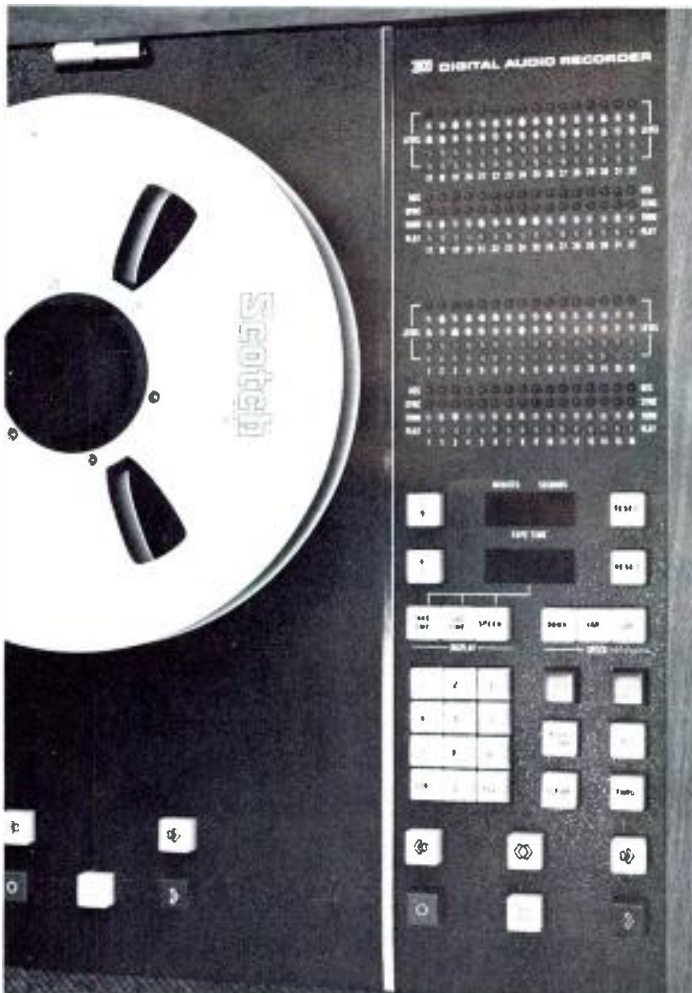

YOUR "FISH SCALE" WAS DESIGNED TO WEIGH FISH!

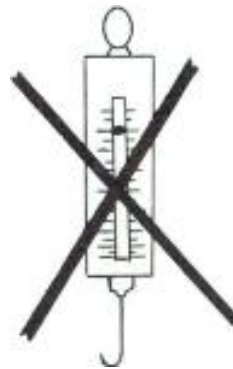

The Tentel tape tension gage is designed to diagnose problems in your magnetic tape equipment. Throw away your fish scales (or put them in your tackle box where they belong). The TENTELOMETER will measure tape tension while your transport is in operation, so you can "see" how your transport is handling your tape . . . smooth, proper tension for quality recording? or oscillating high or low tensions causing pitch problems, wow and flutter?

"See" what your heads "See" and HEAR the difference.

Tentel
50 Curtner Avenue

(408) 377-6588
Campbell CA 95008

A Mini Guide to Micro Computers

THREE computer systems are listed. We do not claim this to be a complete list of this fast growing product line. These three micros all share one special trait. Our staff has been using each of them for some time now.

A micro computer can be defined by its relatively small size. Micros can be virtually carried in suitcases, but they can perform jobs that are of real value to the audio profession.

APPLE II

The basic unit is a combined keyboard/central processing unit (CPU), and memory. It is not supplied with a c.r.t. but will work with any standard t.v. black and white or color. It will produce color graphics when used with a color set. For details on this unit see The Sync Track in this issue.

Apple Computer, Inc.
10260 Bandy Drive
Cupertino, California 95014



The basic Radio Shack keyboard/CPU system with the power supply shown behind. Expander units are available to increase capacity.

RADIO SHACK TRS-80 SYSTEM

The basic unit is a combined CPU and keyboard with a separate power supply which also serves for the separate c.r.t. As supplied by the company various levels of memory are installed with initial supplies of the minimum system readily updatable. Mass storage is by cassette or mini floppy disc systems, and printers are available. A rapidly expanding line of entertainment and business programs are already available on cassettes, with more coming each day from a variety of manufacturers. A basic TRS-80 system has been in our office for a while, and has proven useful in payroll and similar applications as well as functioning as a programmable calculator that will display a full roster of variables on its screen. At this writing, our unit is back at the factory for updating to greater capacity.

Radio Shack
Fort Worth, Texas 76102
and most Radio Shack
retail stores

HEATHKIT H8 COMPUTER SYSTEM

Separate component kits make up this system. The H8 is a complex kit to build (we're just about finished doing this job and will report on it in a later issue). The basic computer can stand alone and do some work with its numeric keyboard. Inside, a mother board permits the plug in of control, CPU, memory boards, and interface cards for peripherals. A Heathkit H9 keyboard and c.r.t. kit permits full use. Mass storage can be achieved on a cassette unit paper tape, or mini floppy disc units, and printers are available. Heath also makes a kit version of a Digital Equipment Co. mini. A more powerful unit than the H8, this unit is designated the H16. It too is available with a full peripheral line.

Heath Company
Benton Harbor, Michigan 49022
also Heath retail stores



A typical Heathkit H-8 system with the H9 video terminal and H10 papertape reader/punch. Not shown, a standard cassette unit can be used instead of the papertape unit.

POSTSCRIPT

The programming language for all three computer systems is *Basic*, a simple, but powerful language that is easy to master. Both the Heath and Radio Shack units are supplied at the lowest cost levels with an elemental Basic, but both offer an Advanced Basic that brings their units up to full capability. ■

Closing date is the fifteenth of the second month preceding the date of issue.

Send copies to: Classified Ad Dept.
db THE SOUND ENGINEERING MAGAZINE
1120 Old Country Road, Plainview, New York 11803

Minimum order accepted \$10.00.
Rates: 50¢ a word.
Boxed Ads: \$25.00 per column inch.
db Box Number: \$1.00 per issue.

Frequency Discounts: 3 times, 10%; 6 times, 20%; 12 times, 33%.

ALL CLASSIFIED ADS MUST BE PREPAID.

FOR SALE

REVOX MODIFICATION, variable pitch for A-77; in/sync for A-77 or A-700; programmer for A-77; rack mounts, slow speed 1 $\frac{7}{8}$; full track; auto rewind; high speed 15 i.p.s. for A-77; Slidematic for A-77. Machines available with or without mods at low cost (A-77 from \$695). All mods professionally performed by Revox trained technicians. Entertainment Sound Services, Inc., 78 N. Franklin Ave., Hempstead, N.Y. 11550. (511) 538-2220.

TEST RECORD for equalizing stereo systems. Helps you sell equalizers and installation services. Pink noise in $\frac{1}{3}$ octave bands, type QR-2011-1 @ \$20. Used with precision sound level meter or B&K 2219S. B&K Instruments, Inc., 5111 W. 164th St., Cleveland, Ohio 44142.

PRIVATE PARTY. New JBL 4350A grey studio monitors, 1 pair, \$3,000. Days: Paul Miller (212) 594-3775 or (201) 440-8020.

NAB ALUMINUM FLANGES. We manufacture 8", 10 $\frac{1}{2}$ ", and 14". Also large flanges and special reels to order. Stock delivery of assembly screws & nuts & most aluminum audio, video, & computer reels. For pricing, call or write Records Reserve Corp., 56 Harvester Ave., Batavia, N.Y. (716) 343-2600.

REK-O-KUT drive belts. Specify model. \$9.95 delivered. QRK Electronic Products, 1568 N. Sierra Vista, Fresno, Ca. 93703.

NAGY SHEAR-TYPE TAPE SPLICERS

FOR CASSETTE $\frac{1}{4}$ " &
 $\frac{1}{2}$ " IN. TAPES

- HAND-CRAFTED
- FIELD PROVEN
- FAST, ACCURATE
- SELF-SHARPENING



NRPD Box 289 McLean, Va. 22101

CANADIANS!

SEMI-PRO MULTITRACK RECORDING HEADQUARTERS FOR: TEAC/TASCAM, Soundcraft, Sennheiser, BGW, Altec, Lexicon, dbx, Bi Amp, Beyer, R.S.D., Tapco, and more.



Richard's Music Shop Inc.
6078 Sherbrooke W.
Montreal, Canada H4A 1Y1
(514) 487-9911

FOR SALE

IVIE SOUND ANALYZERS, all models in stock. Theatre Technology, 37 W. 20th St., New York City 10011. (212) 929-5380.

TAPCO and Electro-Voice: mixers, equalizers, amps, mics, and raw loudspeakers. Write or call for low mail order prices. Sonix Co., P.O. Box 58, Indian Head, Md. 20640. (301) 753-6432.

IMPRESS your manager. Save money on: Technics, Ampex, Scully, Nortronic, Stanton, Inovonics, UREI. Electro-Voice. Belar, Orban, etc. Val-tronics, Inc. Call collect, (717) 655-5937.

USED RECORDING equipment for sale. Professional mics, speakers, miscellaneous gear. Dan (415) 232-7933.

REELS AND BOXES 5" and 7" large and small hubs; heavy duty white boxes. W-M Sales, 1118 Dula Circle, Duncanville, Texas 75116. (214) 296-2773.

ROADSHOW EQUIPMENT. Clearing wide range new & used items including mixers (from \$350 to \$3,500), bass & treble bins (w & w/o speakers, \$125 up), lenses, horns, etc.; limited quantity; be first. (516) 538-2220. Entertainment Sound Services, 78 N. Franklin Ave., Hempstead, N.Y. 11550.

AUDIO TECHNOLOGY ELECTRONICS

Immediate openings for Instructors Part • Full Time

To teach basic and advanced theory and operation of multi-track recording studio equipment.

Audio field experience required. Teaching experience preferred. B.S. or B.E.E. preferred. Attractive, competitive salary.

Send detailed resume to:
Phillip Stein,
Director

INSTITUTE OF AUDIO RESEARCH

64 University Place
New York, NY 10003
212-677-7580



FREE CATALOG & AUDIO APPLICATIONS



CONSOLES
KITS & WIRED
AMPLIFIERS
MIC., EQ, ACN, LINE,
TAPE, DISC, POWER
OSCILLATORS
AUDIO, TAPE BIAS
POWER SUPPLIES

OPAMP LABS INC.
1033 N. SYCAMORE AVE.
LOS ANGELES, CA. 90038
(213) 934-3566

FREE PROFESSIONAL CASSETTE w/ specs. Larksong, Box 468M, Point Arena, Ca. 95468.

PROFESSIONAL AUDIO COMPONENTS: AKG mics; Badap 1; Crown; dbx; Delta Lab; Eventide; Frazier; Gauss; GLL; Ivie; Malatchi; MasterRoom; Nagra; Neumann mics; Orban; Otari; Pentagon; RTR; Sennheiser mics; Switchcraft; Tascam; Uni-Sync; and UREI. These products are on demo in our showroom and in stock for immediate delivery. Our shipping is insured and prepaid. Barclay Recording & Electronics, 233 E. Lancaster Ave., Wynnewood, Pa. 19096. (215) 667-3048 or 649-2965.

FOR SALE: Westrex 3DIH, \$3,495.00; Haeco SC-2, \$4,800.00; Haeco SC-1, \$1,495.00; Grampian D, \$385.00; Grampian BI/D, \$325.00; Westrex 2B, \$525.00; all Haeco cutterheads new, other cutterheads reconditioned and in specs. International Cutterhead Repair, 194 Kings Ct., Teaneck, N.J. 07666. (201) 837-1289.

24 CHANNEL sound reinforcement mixer 100 foot snake, balanced input, 3 band eq, 3 submixers, monitor, echo, solo . . . includes UREI model 527A graphic equalizer. Must sell! Asking price \$2,950.00. B. C. & G. Enterprises, P.O. Box 708, Arvada, Colorado 80001. (303) 751-5991 or (303) 424-6151.

MODERN RECORDING TECHNIQUE, by Robert E. Runstein. The only book covering all aspects of multi-track pop music recording from microphones through disc cutting. For engineers, producers, and musicians. \$10.50 prepaid. Robert E. Runstein, 1105 Massachusetts Ave., #4E, Cambridge, Mass. 02138.

UPDATED OUR EQUIPMENT. Used mics by Neumann; Sennheiser; Beyer; etc. for sale. (415) 232-7818.

MINI-STUDIO package systems from \$2,599, using pro-recording equipment from Revco, Otari, Lamb Labs, Trident, Beyer. Write for full details of offers to Entertainment Sound Services, Inc., 78 N. Franklin Ave., Hempstead, N.Y. 11550. (516) 538-2220.

FOR SALE: Mavis 15/4 road boards in road cases with snakes. SPR Systems. (616) 392-2379.

TEST GEAR Amber 4400 retrofit and factory recal, perfect. Philips PM3232 dual beam scope, two probe sets, cables, Polaroid Scope Camera. All for \$3,100. Richard Jennings, 2247 Clement. San Francisco, Ca. 94121. (415) 752-6209.

AMPEX, OTARI & SCULLY recorders in stock for immediate delivery; new and rebuilt. RCI, 7912 Georgia Ave., Silver Spring, Md. 20910. Write for product list.

FOUR 3M-64 2-track record/reproduce tape machines; all machines in excellent condition. \$16,000. O'Day Broadcasting, Don Winget, 1305 Third Ave., Suite 400, Seattle, Wa. 98101. (206) 682-2828.

AMPEX SERVICE COMPANY: Complete factory service for Ampex equipment; professional audio; one-inch helical scan video; video closed circuit cameras; video systems; instrumentation; consumer audio; professional audio motor and head assembly rebuilding. Service available at 2201 Lunt Ave., Elk Grove Village, Ill. 60007; 500 Rodier Dr., Glendale, Ca. 91201; 75 Commerce Way, Hackensack, N.J. 07601.

CURRENT MCI console, JH528; stereo quad; 28-in/24-out; operated only a few weeks; latest factory mods. Cherokee Recording Studios. (213) 653-3412.

GOING OUT OF BUSINESS. Ampex MM1100 16-track; Scully 280-2; Audiotronics 501 console, 18-in/16-out, wired 24 w/patch and producer's desk; dbx 158; dbx 157; Eventide harmonizer, H-910; much more onboard equipment—mics, amps, etc., all in perfect running order; most under one year old. (516) 295-0371.

GOTHAM AUDIO CORPORATION SALE

SUPERSEDED NEW & USED EQUIPMENT

- NEUMANN Console Modules
- TELEFUNKEN M-12 Tape Machines
- UREI Limiter
- LEXICON Digital Delay
- DANNER Quad Pan Pots & Faders
- K&H Graphic Equalizer
- M&W Light Beam VU Meters
- MELLOTHRON Sound Effects Generator
- FAYLON P.A. Mixer with Amplifier

For complete listing, send self-addressed stamped envelope to: **GOTHAM AUDIO CORP., 741 Washington St., New York, NY 10014.**

SUPER SALE

MARTIN

The world's largest electronic Everything House for the professional who is moving to bigger and better quarters on West 55th Street. . .

To ease the move, we're putting our entire stock of equipment and electronic parts on sale.

THIS IS A GOLDEN OPPORTUNITY TO BUY BRAND NEW PRO AUDIO AND VIDEO EQUIPMENT AT ONCE-IN-A-LIFETIME PRICES.

All products include standard warranty.

Cash or certified check only.

Call, write, or come in to:

**MARTIN
AUDIO/VIDEO CORP.
320 W. 46th St.
New York, N.Y. 10036
(212) 541-5900**

dbx 8-CHANNELS (four 157's in rack mount), 2 years old, LN, gone pro dbx. Alpha Recording, (312) 495-2241.

UREI Sonipulse with AKG calibrated microphone, used. \$900.00. (213) 761-9336.

ASSETS of bankrupt recording studio (Echo Sound, L.I.) for sale: 16-TRACK CONSOLE; tape recorders; electronics; speakers; mixers; cabinets; Van Epps disc cutting lathe w/Grampian head & 200W amp; F.M. tuners, etc. & misc. office equipment. Ed Chalpin, 301 W. 54th St., New York, N.Y. 10019. (202) 247-6010.

HARMONIZER, Eventide; Model H-910; new; plus p.a. and band equipment. Excellent condition (516) 742-3040. 16 McKinley Ave., Albertson, N.Y. 11507.

FOR SALE: Vintage Neumann M-49 mic with power supply. Needs some work. Best offer. Mastersound Recording, 4034 Easton Ave., Bethlehem, Pa. 18017.

AMPEX, SCULLY, OTARI, all major professional audio lines. Top dollar trade-ins. 15 minutes George Washington Bridge. Professional Audio Video Corporation, 384 Grand St., Paterson, N.J. 07505. (201) 523-3333.

AUDIO DESIGNS 16x8 board, separate stereo & mono mixdown. Now in service. Mint condition. \$17,500. Fred Arthur Productions. (303) 832-2664.

12½ in. NAB 0.050 in. ALUMINUM FLANGES. This new item in stock for immediate delivery. For prices, call or write, RECORDS RESERVE CORP., 56 Harvester Ave., Batavia, N.Y. 14020. (716) 343-2600.

AMPEX 300, 352, 400, 450 USERS—for greater S/N ratio, replace first playback stage 12SJ7 with our plug-in transistor preamp. For specifications, write VIF International, Box 1555, Mountain View, Ca. 94042. (408) 739-9740.

EIGHT-TRACK equipment: Audiotronics, Tascam, Revox, Eventide, Orban, AKG. (203) 795-3600.

SSI CONSOLE, 24 input, 16 bus, adapted to 24-track monitoring; 40 faders; separate monitor mix; 2 cue busses; 4 echo sends; 550 audio accessories jack field; 40 vu meters, plus 27 dBm out, plug together installation. Price \$30,000. Call or write Glenn Snoddy, Woodland Sound Studios, 1011 Woodland St., Nashville, Tenn. 37206, (615) 227-5027.

RECORDING CONSOLE, Langeman, 16 x 4, eq., echo s/r. Used video equipment. Info, Malcolm Montgomery, Chief Engineer, College-Conservatory of Music, University of Cincinnati, Cincinnati, Ohio 45221. (513) 475-4394.

THE LIBRARY . . . Sound effects recorded in STEREO using Dolby throughout. Over 350 effects on ten discs. \$100.00. Write The Library, P.O. Box 18145, Denver, Colo. 80218.

FULLY PROFESSIONAL 6-input stereo mixer kit for \$249.00. Get superior quality for less by assembling yourself. European design features linear faders, vu meters, tone, echo, cue, pan, and more. Direct from your U.S.A. distributor, ICB Audio, Dept. C-1, Box 2752, Erlanger, Ky. 41018.

CBS AUDIMAX 4450A; new, unused, in box, \$1,000. James Murdock, WRIU, Kingston, R.I. 02881. (401) 792-2398.

QUANTUM QM8 recording console, 8 x 4, good condition, \$1,600. (614) 224-7848, Columbus, Ohio.

WANTED

WANTED: Recording equipment of all ages and variety: Neumann mics. EMT. etc. Dan Alexander, 6026 Bernhard, Richmond, Ca. 94805. (415) 232-7933.

BUSINESS OPPORTUNITIES

RECORDING STUDIO FOR SALE. Fully equipped recording studio; one of the finest in Southern California. A viable recording business with Ultra-Potential! Flagship Realty, 7801 Mission Center Court, Suite 238, San Diego, Ca. 92108.

SERVICES

CUTTERHEAD REPAIR SERVICE for all models Westrex, HAECO, Grampian. Modifications done on Westrex. Avoid costly down time; 3-day turnaround upon receipt. Send for free brochure: International Cutterhead Repair, 194 Kings Ct., Teaneck, N.J. 07666. (201) 837-1289.

ACOUSTIC CONSULTING — STUDIO ANALYSIS, ROOM EQUALIZATION. Sugarloaf View, Inc., 31 Union Square W., New York, N.Y. 10003. (212) 675-1166.

EMPLOYMENT

STABLE, PROFITABLE 5 kW directional plus stereo stations in great area for living looking for a real chief and willing to pay for one. Send resume and salary requirements to Steve French, KMON, #7 Holiday Village, Great Falls, Montana 59404.

SOUND ENGINEER AVAILABLE. Sound man with seven years' experience, live mixing, seeks employment with sound company or touring band offering steady work and good salary. Have designed, maintained, and operated high level systems. Write Marc Griggs, RFD 1, Amesbury, Mass. 01913.

EXPERIENCED FREELANCE engineer with following or salesperson in recording/advertising field wanted for established, growing 16-track studio and production company in northern N.J. Commission basis to start. Call (201) 697-7540 or 697-3658.

ELECTRONIC MAINTENANCE engineer. Major NYC recording studio seeks qualified individual to head maintenance department. Responsibilities include maintenance of automated 24-track rooms, R&D projects. Analog and digital design experience desirable. Please reply with resume to Dept. 111, db Magazine, 1120 Old Country Rd., Plainview, N.Y. 11803.

NEEDED IMMEDIATELY: Two production engineers to do commercials, jingles, film mixes, records; direct talent at top rated film and sound production house which seeks ability over experience. EOE. Send tape, resume and letter to Stephen von Hagel, AUDIOFONICS, INC., 1101 Downtown Blvd., Raleigh, NC 27603.

- Receiving a presidential fellowship from the **Aspen Institute for Humanistic Studies**. **Thomas Frost**, Director of Masterworks Artists and Repertoire for **Columbia Records**, will write a comprehensive paper on the classical recording field. The paper, scheduled for publishing by the Institute this fall, will be used for seminars chaired by Frost and co-sponsored by the Aspen Institute and **Carnegie Hall Corporation**.

- Promoted to the newly-created position of executive vice president of the **Bogen Division of Lear Siegler, Inc.**, **John H. Ochtera** will supervise all departments at Bogen. Mr. Ochtera has been with Bogen since 1970.

- Joining other Harris Divisions in the new regional office complex of the Corporation, the **Broadcast Products Division** has moved its Houston office to 7000 Regency Square Blvd., Suite 200, Quincy, Illinois. District managers **London England** and **Vern Killion** are located in Suite 200 and may be reached at (713) 977-2411.

- Manufacturer of high technology broadcast equipment, **Time and Frequency Technology** has relocated its facilities in the Oakmead Village Industrial Park at 3090 Oakmead Village Drive, Santa Clara, CA 95051, telephone (408) 246-6365.

- The role of the communications industry in aiding the present thrust to bring the disabled into society's mainstream was strengthened by a grant recently awarded to **New York University** by HEW. The federal monies (\$1,499,815) were awarded to the University's Alternate Media Center to develop such techniques as two-way t.v. instruction for the homebound and instructional training for those who work with the disabled.

- Succeeding **Benjamin B. Bauer** to the post of vice president and general manager of **CBS Technology Center**, Stamford, Conn., is **J. Kenneth Moore**. Mr. Moore, a physicist, who joined CBS in 1957, served as director of advanced television technology at the center. Mr. Bauer, who retired after 21 years with CBS, will have a continuing relationship with CBS as a consultant.

- Serving a dual function for the **Ampex Corporation**, **LeRoy C. Cochran** has been appointed general manager of audio products for the audio-video systems division, and president of **Duca-Richardson, Inc.**, a recently acquired subsidiary of Ampex that manufactures electronic switching systems for the broadcast industry.



LeKASHMAN

- High fidelity pioneer **Lawrence L. LeKashman**, vice president of marketing and sales at **Electro-Voice, Inc.** of Buchanan, Michigan died on September 24, 1978 after a brief illness. Mr. LeKashman's career was interwoven with the development of Electro-Voice, which he joined in 1951 when the high fidelity industry was in its infancy. He not only sparked a good deal of the consumer-interest explosion in the hi fi field, but was instrumental in developing E-V's mass-produced stereophonic phonograph cartridge, a history-making achievement of 1958. Mr. LeKashman wrote more than 100 technical articles, was editor of two technical handbooks, and held patents and copyrights on three navigation calculators and radio direction finding aids. He had also been Radio Editor for **Aero Digest** early in his career, as well as a writer and consultant for **Raytheon Manufacturing**, vice president and general manager for **Radio Magazine, Inc.**, and advertising/sales promotion manager at **RCA Victor Tube Division**. After serving as president of the company, Mr. LeKashman left E-V for the period 1971-77, during which he served as president of **Teledyne/Olson Electronics**. He returned to E-V in 1977. Mr. LeKashman was one of the founders of the **Institute of High Fidelity** and an avid ham radio enthusiast.

- New emphasis on recording education is being felt at the **Berklee College of Music** in Boston, Mass. A studio, offering 40 hours of sessions each week, covering ten courses in audio and sound reinforcement has been established. Percussionist **Thomas R. Pabich** has joined the faculty to teach recording techniques. Director of the Audio Department is **Joe Hostetter**.

- A license to practice and to teach time delay spectrometry (TDS) has been granted **Don Davis' Synergetic Audio Concepts** by the **California Institute of Research Foundation**. The technique, developed by **Richard Heyser** of **Jet Propulsion Laboratories**, allows anechoic measurements in non-anechoic environments; the direct sound spectrum may be measured by itself.

- Veteran RCA engineer **Richard W. Sonnenfeldt** has been elected vice president in charge of the company's **SelectaVision VideoDisc** project. Mr. Sonnenfeldt, except for a time between 1962 and 1970, when he was with the **Foxboro Company** and president of the **Digitronics Corporation**, has been with RCA since 1949. Another longtime, since 1950, RCA engineer, **Arch C. Luther**, has been appointed to the new post of Chief Engineer in the Communications Systems Division.

- **Jon R. Kelly** has been named president of **Audio-Technica U.S. Inc.** with **Fred Nichols** promoted to the post of vice president in charge of marketing. **H. Matsushita** was named chairman of the board and **M. Nemoto** to the position of vice president for engineering. Mr. Kelly has been with the firm since its inception in 1972, when he served as general manager.

- Anticipating an increased concentration in the home video market, **Memorex**, of Santa Clara, Ca., has named **John C. (Jake) Rohrer** as program manager. Mr. Rohrer will supervise the production of half-inch blank video cassettes.

- After 25 years of recording for other labels, **Criteria Studios** of Miami, Florida, has established its own label, **Good Sounds Records**. Criteria is run jointly by the Albert brothers, **Ron** and **Howard**, who operate under the name of **Fat Albert Productions**.

No problem.

That's what TASCAM SERIES mixing consoles are all about because whatever stage of recording development you're in, we provide the solution, not create another problem.

Our attention to "human engineering" is what keeps TASCAM SERIES number one and the functions included in our mixers demonstrate just that.

Monitoring. If you already have a mixer, do you have to use the input section for monitoring? You don't if you have a Tascam. Any Tascam, not just the Model 15. So when we tell you you've got 8-in on the Model 3 or 5A, you've got 8-in. Plus enough monitoring combinations to satisfy anyone in a control room or studio.

Mixing Groups. Problem solving is an orderly pattern of thought. Thinking it through, one element at a time, is the most logical approach. In design you find our mixing groups do just that. Each element on every console that makes the total Tascam mixer has been positioned as a group. This means that each time you operate any Tascam console you are able to logically think about what you are doing, not which knob to twist or button to push.

Meters. Tascam meters are not options. They are an

integral part of every mixer we make and they're less visually confusing than a lot of multi-color LED displays we've seen. Compare and see what we mean.

Patch Points. How flexible is your mixer? We have the simplest external patching system in the business. Period. And every Tascam mixer is designed with the same flexibility to provide access to signals and increase your ability to influence and change them to suit your individual ideas.

Channel Assignments (Busses). We believe that channel assignments should be simple and comprehensive. Simple in number and visually comprehensive. All TASCAM SERIES consoles have identical channel assignment color coding, making it easy to see to which output channel any particular input is assigned. Additionally, we have a unique panning system. Whenever any two or more channel assigned buttons are depressed, the pan is automatically engaged. If only one button is pushed, then pan is totally out of the system. Easy, simple, and terribly logical.

A Special Note About The Model 1. Our model 1 is really an inexpensive compact eight by two line-level mixer. It gives you the additional submixes you'll need without costing you a fortune.

Where are our specs? In the equipment, where they belong. Because hearing is believing. So be a skeptic. Pick up the phone or drive to a TASCAM SERIES dealer near you. He has all the information and a personal systems planning brochure from us to you. And remember, whatever your recording needs, the TASCAM SERIES mixers is no problem.

TASCAM SERIES BY TEAC

A new generation of recording instruments for a new generation of recording artists.



TEAC Corporation of America • 7733 Telegraph Road • Montebello, CA 90640

Circle 10 on Reader Service Card



AutoLock

... A Reality

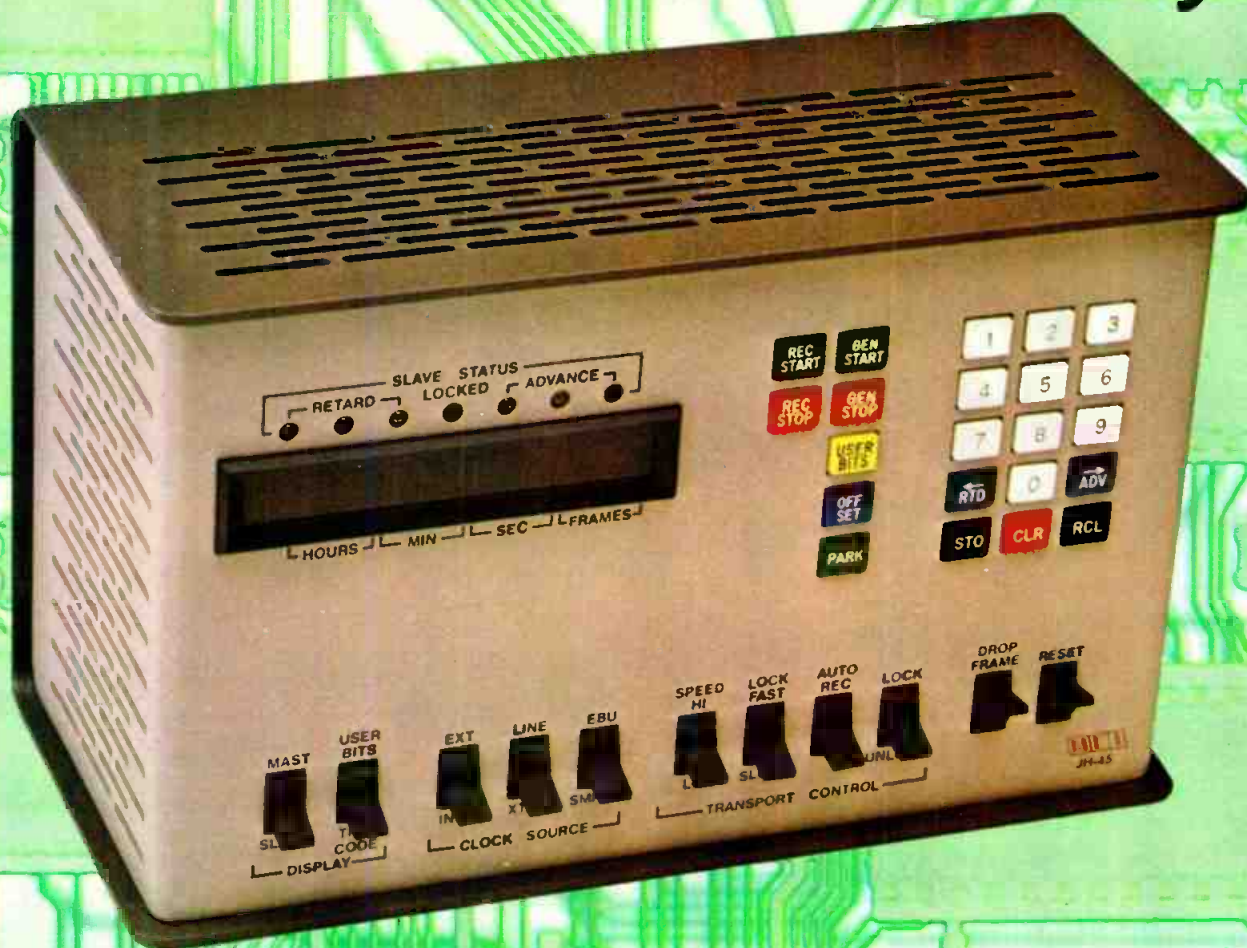

- ★ SMPTE/EBU Reader/Generator/Synchronizer
- ★ Microprocessor based
- ★ "Intelligent" software

- ★ Faultlessly locks Audio/Audio
- Video/Audio
- Film/Audio

★ One low-cost unit does it all!



4007 NE 6th Ave., Ft. Lauderdale, Fla. USA 33334 Phone (305)566-2853 Telex 514-362

Circle 11 on Reader Service Card