

# db



24523CHITEAS0640018 0579 9999  
 CHIEF ENGINEER  
 WILL  
 PO BOX 1510  
 LYNCHBURG VA 24505

**If your clients demand the highest level of sonic performance...**

**If you need to offer the most flexible digital processing equipment available...**

**If you would rather have your reverberation, delay, and pitch modification requirements handled by one cost effective, computer controlled signal processing system...**

**You've got no choice.**

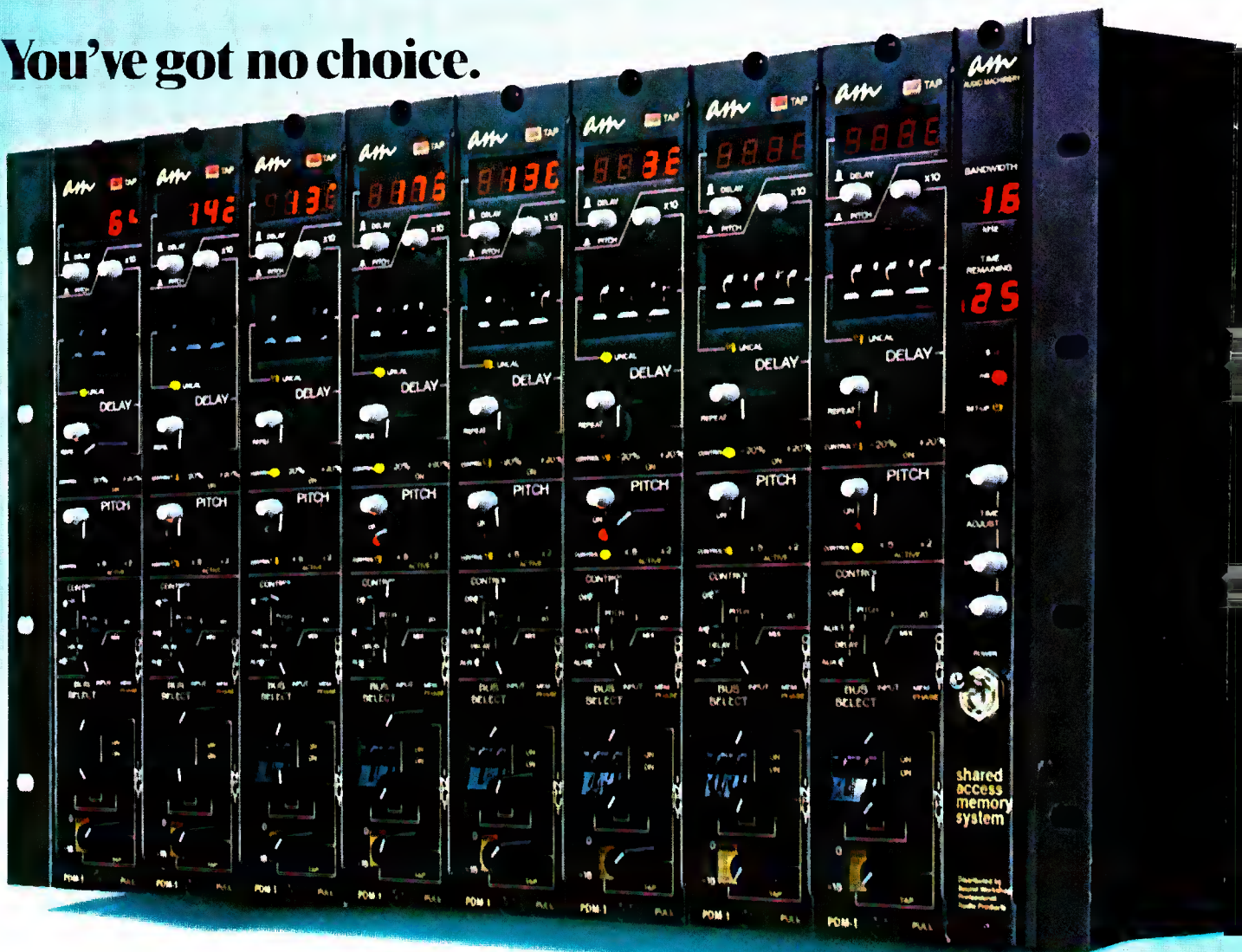

## **The Shared Access Memory System. By Audio Machinery**



The Audio Machinery Shared Access Memory System  
distributed by Sound Workshop Professional Audio Products, Inc.  
1324 Motor Parkway Hauppauge, New York 11787 516-582-6210

Circle 10 on Reader Service Card

## Coming Next Month

● In June, we conclude Wayne Jones' three-part survey of Audio Tests and Measurements, compare the features of various types of graphic recorders, and then tackle the subject of psychoacoustics. We'll also bring you up-to-date with the latest convention reports, and confess what we were doing in Vienna recently. Then it's back to the computer, for a little more audio problem solving. Basically, there's nothing to it. In addition, there will also be our regular columnists—Patrick Finnegan, Broadcast Sound; Norman Crowhurst, Theory and Practice; and Martin Dickstein, Sound with Images. All this, and more, in the June issue of **db**—the Sound Engineering Magazine.

## About The Cover

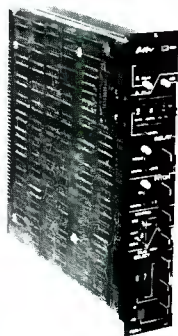

● Signal processing is featured in this month's **db**, and art director Bob Laurie shows us two views of one of the latest-generation devices: Audio Machinery's Shared Access Memory System. In the background, we see the art work for one of the p.c. boards in SAMS' mainframe computer system, where the system's microprocessor lives. Up front, one of the pitch/delay modules. For more details, see Michael Tapes' feature story in this issue.



THE SOUND ENGINEERING MAGAZINE  
MAY 1979 VOLUME 13, NUMBER 5

	EDITORIAL	38
SHARED ACCESS MEMORY—A NEW CONCEPT FOR DIGITAL SIGNAL PROCESSING IN AUDIO APPLICATIONS	Michael Tapes	42
AUDIO TESTS AND MEASUREMENTS—Part II	Wayne Jones	48
A PRECISION DYNAMIC RANGE CONTROLLER	Burgess Macneal	52
XY RESPONSE PLOTTERS FOR THE STUDIO	Brad Plunkett	56
DOOHICKII DIGITAL	Anthony Agnello & Richard Factor	62
EQUALIZERS FOR PROFESSIONAL RECORDING APPLICATIONS	Robert Orban	68
DESIGNING A NOTCH FILTER WITH A PROGRAMMABLE CALCULATOR	Albert E. Hayes, Jr.	73
DIRECTORY OF SIGNAL PROCESSING MANUFACTURERS		76
	CALENDAR	2
	LETTERS	4
	BROADCAST SOUND	12
	Patrick S. Finnegan	
	THEORY AND PRACTICE	20
	Norman H. Crowhurst	
	NEW LITERATURE	26
	SOUND WITH IMAGES	27
	Martin Dickstein	
	NEW PRODUCTS	30
	CLASSIFIED	77
	PEOPLE, PLACES, HAPPENINGS	80



is listed in **Current Contents: Engineering and Technology**

**Larry Zide**  
PUBLISHER  
**John M. Woram**  
EDITOR  
**Suzette Fiveash**  
ASSOCIATE EDITOR  
**Sam Zambuto**  
ASSOCIATE EDITOR

**Ann Russell**  
ADVERTISING PRODUCTION  
**Eloise Beach**  
CIRCULATION MANAGER  
**Lydia Anderson**  
BOOK SALES  
**Bob Laurie**  
ART DIRECTOR

**Crescent Art Service** GRAPHICS AND LAYOUT

db, the Sound Engineering Magazine is published monthly by Sagamore Publishing Company, Inc. Entire contents copyright © 1979 by Sagamore Publishing Co., 1120 Old Country Road, Plainview, L.I., N.Y. 11803. Telephone (516) 433 6530. db is published for those individuals and firms in professional audio-recording, broadcast, audio-visual, sound reinforcement, consultants, video recording, film sound, e.c. Application should be made on the subscription form in the rear of each issue. Subscriptions are \$9.00 per year (\$18.00 per year outside U.S. Possessions, Canada and Mexico) in U.S. funds. Single copies are \$1.95 each. Controlled circulation paid at Brattleboro, VT 05301. Editorial, Publishing, and Sales Offices: 1120 Old Country Road, Plainview, New York 11803. Postmaster: Form 3579 should be sent to above address.

ADC	5
Altec	19
Amber Electro Design	61
Ampex	40-41
Audio Design Recording	59
Audio Distributors	2
Bode Sound Co.	26
Bogen	11
Bose Corporation	15
BTX Corporation	27
Clear-Com.	29
dbx, Inc.	21
DeltaLabs	4
Eastern Acoustic Works	16
EKKOR	20
Electro-Voice	9
ESE	10
Garner Industries	66
GLI Integrated Sound Systems	58
Industrial Research Products	8
Ivie Electronics	18
J&R Music World	26
Klipsch & Associates	7
Midas Audio Systems	Cover 3
R.K. Morrison Illust. Mat's.	28
Nagra	13
Neptune Electronics	25
Neve	33
Northwest Sound	60
Orange County Electronics	51
Orban Associates	17
Otari	47
Penny & Giles	6
Pro Audio Seattle	23
QSC Audio Products	22
Quad-Eight	Cover 4
Recording Supply Co.	31
Saki Magnetics	34
Sescom	28
Shure Brothers	3
Soundcraftsmen	24
Sound Workshop	Cover 2
Standard Tape Lab	12
TEAC Corporation of America	36-37
Telex Communications	72
Tentel	67
White Instruments	75
Wireworks	14

### MAY

**12 1979 Midwest Acoustics Conference.** Topic: Digital Technology: Impact on Recorded Sound. Norris Center, Northwestern University. Contact: William R. Bevan, Shure Bros., Inc., 222 Hartrey Ave., Evanston, Illinois 60204. (312) 866-2364.

**15- 63rd AES Convention (Los Angeles),** Los Angeles Hilton, California; Chairman will be Martin Polon, Director, Audio Visual, U.C.L.A., C.A.S.O., Rice Hall 130, 405 Hilgard, Los Angeles, Calif. 90024. (213) 825-8981.

**22- Synergetic Audio Concepts**

**24 Sound Engineering Seminar:** Sheraton-Universal Hotel, No. Hollywood, CA. SYN-AUD-CON, P.O. Box 1134, Tustin, CA 92680. (714) 838-2288.

**22- B&K Instruments Seminar.**

**24 Topic:** Techniques and Instruments for Electroacoustic Measurements on Audio Equipment. Los Angeles, CA. For more information contact: B&K Instruments, Inc., 1440 South State College Blvd., Suite 1A, Anaheim, CA 92806. (714) 778-2450.

### JUNE

**3-6 13th Annual Summer Consumer Electronics Show.** McCormick Place, McCormick Inn, and the Pick Congress Hotel, Chicago, Illinois.

**20- The Twelfth Annual International Exhibition of Professional Recording Equipment (APRS).** Connaught Rooms, Great Queen Street, Kingsway, London. For more information contact: British Information Services, 845 Third Ave., New York, NY 10022. (212) 752-8400.

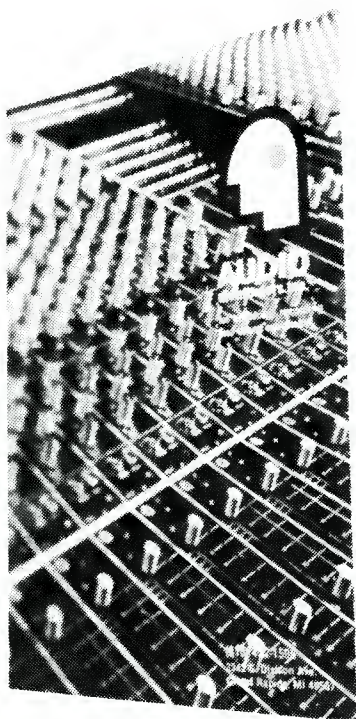

## the AUDIO catalog...

### Recording's Best Seller!

And it's FREE! 168 pages of broadcast, recording, and sound equipment by the names you trust. Ampex, Audiotronics, Autogram, Broadcast Electronics, Crown, DBX, Electro-Voice, Nagra, Neumann, Orban, Otari, Russco, Sennheiser, Shure, Tascam, Technics, and UREI to name a few. And most important, it's brought to you by AUDIO! For 18 years now, recording engineers like yourself, from California to Maine, have been discovering that for total product value, fast quality service, and top notch people you can rely on AUDIO.

For your FREE copy of the AUDIO Catalog, just write to us on your company letterhead and we'll fire back your copy of Recording's Best Seller! AUDIO for the Real Pro!



2342 S. Division, Grand Rapids, MI 49507



sales offices

### THE SOUND ENGINEERING MAGAZINE

#### New York

1120 Old Country Rd.  
Plainview, N.Y. 11803 516-433-6530

#### Roy McDonald Associates, Inc. Dallas

Stemmons Tower West, Suite 714  
Dallas, Texas 75207 214-637-2444

#### Denver

3540 South Poplar St.  
Denver, Colo. 80237 303-758-3325

#### Houston

3130 Southwest Freeway  
Houston, Tex. 77006 713-529-6711

#### Los Angeles

500 S. Virgil, Suite 360  
Los Angeles, Cal. 90020 213-381-6106

#### Portland

2035 S. W. 58th Ave.  
Portland, Ore. 97221 503-292-8521

#### San Francisco

Suite 265, 5801 Christie Ave.  
Emeryville, Cal. 94608 415-653-2122



**fact:**  
**this condenser microphone  
sets a new standard of  
technical excellence.  
& it sounds superb!**

The Shure SM81 cardioid condenser is a new breed of microphone. It is a truly high-performance studio instrument exceptionally well-suited to the critical requirements of professional recording, broadcast, motion picture recording, and highest quality sound reinforcement — and, in addition, is highly reliable for field use.

Shure engineers sought — and found — ingenious new solutions to common

problems which, up to now, have restricted the use of condenser microphones. Years of operational tests were conducted in an exceptionally broad range of studio applications and under a wide variety of field conditions.

As the following specifications indicate, the new SM81 offers unprecedented performance capability — making it a new standard in high quality professional condenser microphones.



### **SM81 puts it all together!**

- WIDE RANGE, 20 Hz to 20 kHz FLAT FREQUENCY RESPONSE.
- PRECISE CARDIOID polar pattern, uniform with frequency and symmetrical about axis, to provide maximum rejection and minimum coloration of off-axis sounds.
- EXCEPTIONALLY LOW (16 dBA) NOISE LEVEL.
- 120 dB DYNAMIC RANGE.
- ULTRA-LOW DISTORTION (right up to the clipping point!) over the entire audio spectrum for a wide range of load impedances. MAXIMUM SPL BEFORE CLIPPING: 135 dB; 145 dB with attenuator.
- WIDE RANGE SIMPLEX POWERING includes DIN 45 596 voltages of 12 and 48 Vdc.
- EXTREMELY LOW RF SUSCEPTIBILITY.
- SELECTABLE LOW FREQUENCY RESPONSE: Flat, 6 or 18 dB/octave rolloff.
- 10 dB CAPACITIVE ATTENUATOR accessible without disassembly and lockable.

### **Outstanding Ruggedness**

Conventional condenser microphones have gained the reputation of being high quality, but often at the expense of mechanical and environmental ruggedness. This no longer need be the case. The SM81 transducer and electronics housing is of heavy-wall steel construction, and all internal components are rigidly supported. (Production line SM81's must be capable of withstanding at least six random drops from six feet onto a hardwood floor without significant performance degradation or structural damage.) It is reliable over a temperature range of  $-20^{\circ}$  F to  $165^{\circ}$  F at relative humidities of 0 to 95%!

Send for a complete brochure on this remarkable new condenser microphone! (AL577)

## **SM81 Cardioid Condenser Microphone**



Shure Brothers Inc., 222 Hartrey Ave., Evanston, IL 60204, In Canada: A. C. Simmonds & Sons Limited  
Manufacturers of high fidelity components, microphones, sound systems and related circuitry.

**TO THE EDITOR:**

After reading the furor over "The Sound of Broadcasting Audio" I felt that there were a few comments that I had to offer that might seem worthwhile.

I am currently working at an a.m.-f.m. simulcast rocker, and most of our equipment dates back to the fifties. We *don't* expect our f.m. signal to sound like the (recording) studio, but we do expect a relatively clean signal with some of the dynamic range left in. And not only do we expect a clean signal, but we get it too. The equipment might be obsolete, but the approach we take is not, and it shows

when the Arbitron book comes out. It certainly can't hurt to put out a clean, uncoloured signal because the listeners that can't receive it as clean as we put out won't know the difference. Naturally, the growing number of audiophiles (and "just plain folks") who just spent all that money on their brand new system will certainly appreciate it. The a.m. is a whole different story, of course. No one expects "hi-fi" coming out of a hundred thousand midget car radios. Of course, if your signal sounds like it has been dragged through the mud several times over no one will listen. And there goes business. . . .

Second, let me say in reply to Mr.

Dunn of WDBF that broadcasters *do* have to alter the sound of the recordings somewhat to keep the gain up and the FCC off, but radio is *not* the most important aspect of the record industry: selling records is. Engineers and producers produce for the *public*, not the DJ, and since there is no lack of signal processing equipment available for broadcasting it is unreasonable to ask that records be produced with broadcasting alone in mind.

Also, I happen to like the wide frequency and dynamic range on the new releases. And I don't feel that all the new technology that makes this possible is just "an engineer's toy."



## How's THIS for an encore?

Modern Recording called our DL-1 Delay "probably the best we have encountered" . . . a tough act to follow.\* Now after more than a year in development DeltaLab introduces its encore - the ACOUSTICOMPUTER® - a combination digital-delay and special-effects processor designed for use both on-stage and in the studio, providing well-known functions (echo, doubling, chorusing, vibrato, flanging, etc.) plus new effects not available in any other device.

- Pre-reverb delay with two independent delay channels, variable from 0.25ms to 152ms with LED display.
- Delay up to 240ms in serial (mono) mode.
- Built in VCO with external control input at rear.
- Same no-compromise sound quality as in our DL-1 Digital Delay: Full 20-15 kHz bandwidth at all delay lengths with 90 dB dynamic range.
- Computer-synthesized acoustic space with 16 selectable reverb programs plus a new special effect in which the ACOUSTICOMPUTER scans the 16 programs.
- Two channels in and out. Built in reverb mixing and stereo imaging controls.
- Foot-switch controlled bypass.

It's impossible to describe in this space everything the ACOUSTICOMPUTER does; you'll have to experiment with it yourself. By carefully minimizing the number of separate controls and grouping them logically, we've made it easy for non-engineers to operate the ACOUSTICOMPUTER.

For further information call or write Phil Markham at DeltaLab Research, Inc., 27 Industrial Avenue, Chelmsford, MA 01824 Tel. (617) 256-9034.

\*See Modern Recording "Hands On Report," Sept. 1978.



DeltaLab Research, Inc. 27 Industrial Avenue, Chelmsford, Mass. 01824

Available at Quality Dealers



# OUR ORIGINAL BUSINESS WAS MAKING SOUND CONNECTIONS

**We're still at it.** We started in 1935 as the Audio Development Company producing jacks and jack panels for the broadcast and telephone industries. Since then, ADC has produced such innovations as Bantam Jacks, printed circuit board jacks and Wrapid terminal blocks. What are we doing for you today?

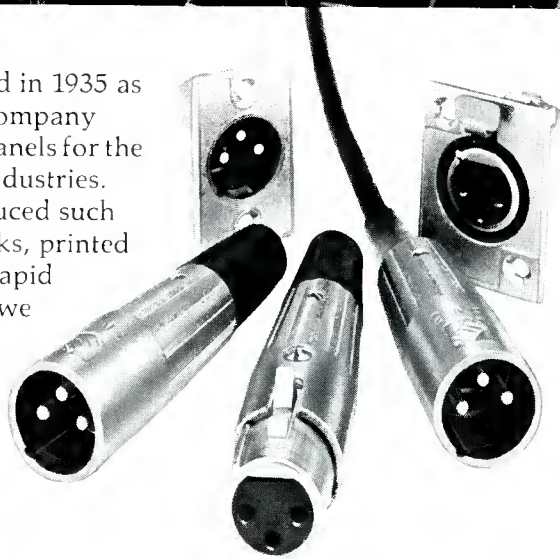

We are introducing our new line of low impedance audio connectors. We have six models now in production. They're reliable, compatible and competitively priced. Most important, they're available sooner. Ask about making a sound connection with ADC. Call or write today.



**ADC Products**

A DIVISION OF MAGNETIC CONTROLS

ADC Products, 4900 W. 78th St., Minneapolis, MN 55435 / Telephone: (612) 835-6800 TWX 910-576-2832 Telex 29-0321

Sales offices in: Atlanta, GA (404) 766-9595 • Dallas, TX (214) 241-6783 • Denver, CO (303) 761-4061 • Fairfield, CT (203) 255-0644  
 • Lafayette, IN (317) 474-0814 • Melbourne, FL (305) 724-8874 • Menlo Park, CA (415) 323-1386 • Minneapolis, MN (612) 835-6800  
 • Washington, DC (202) 452-1043 • Montreal, Quebec (514) 677-2869

Circle 24 on Reader Service Card

# SLIMLINE

## Penny & Giles small development in the fader business

Penny & Giles new Slimline fader is only 12.7mm wide with a 68mm electrical stroke. Yet, within that 12.7mm body width you can have mono or stereo outputs, linear or audio taper with an infinitely smooth and stepless fade – plus the other performance advantages of Penny & Giles conductive plastic faders.

Our small development sounds good – and has a small price to match.

Write for full details or phone our sales office.

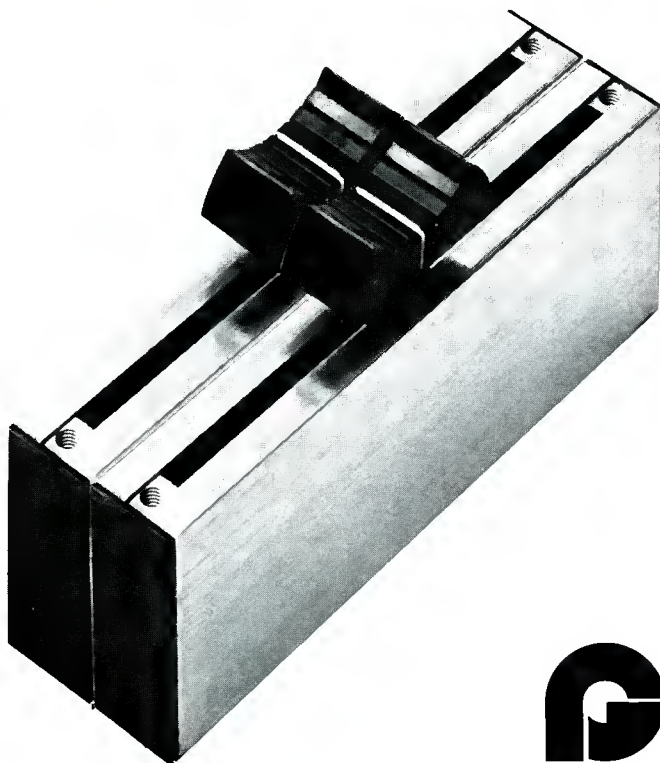

**Penny & Giles Conductive Plastics Limited**  
1640 5th Street Santa Monica California 90401  
Telephone 213 393-0014

With a good set of *ears* and a half decent stereo those increased ranges can do nothing but bring out the texture and the feel of the music—when used with taste, of course. And isn't that what it's all about?

As a broadcaster myself, I must point out to Mr. Edwards that (of course!) broadcasting is a business, but why did he go into radio instead of accounting? Radio pays my bills, too, but no doubt I'd do much better (moneywise) if I sold Xerox for a living. I think that many of us have the tendency to forget, once we're in a secure position, that this is not just *any* business and we wouldn't go through as many changes as we do if it were. The *music* is what brings us all together, not the money, and even though Mr. Edwards has his secure (for the moment) little gig in Bakersfield, he shouldn't lose touch with what got him there to begin with.

CARIN ABRAMSON  
KULA/KAHU, Honolulu

#### TO THE EDITOR:

Okay, I'll take on WDBF's Paul Dunn:

First of all, you need some understanding of my biases, if we're to explore his . . . and yours. I've been chief engineer of a couple of small stations over the years. I'm also nuts about nearly all music, have a good stereo system and a large collection of records and tapes.

I do agree with Mr. Dunn's feelings toward what he calls **db's** "de facto editorial line." I long sensed an air of condescension toward those in broadcast audio. I suspect you're not aware of it, but it is in your writings. And, that's a shame, because nobody writes better about audio than **db**. Broadcasting's own trade journals write either to station management or to their own advertisers. They do not write toward the working broadcast employee.

Now to Mr. Dunn: His main thrust seems to be toward audio processing, and although he does list the correct reasons for it, he just takes those reasons to the wrong conclusion. In my opinion, broadcasters use audio processing because they feel the end product, the transmitted signal, is better for it. Ultimately, that signal becomes more saleable. That's the real rationale, whether it's true is something for everyone's own subjective judgment. But, what most broadcasters don't stop to realize is that audio processing *does change the waveform* taken from the original tape or disc. That change can easily be considered by recording studio technicians as *a form of distortion*.



# CROWD PLEASER

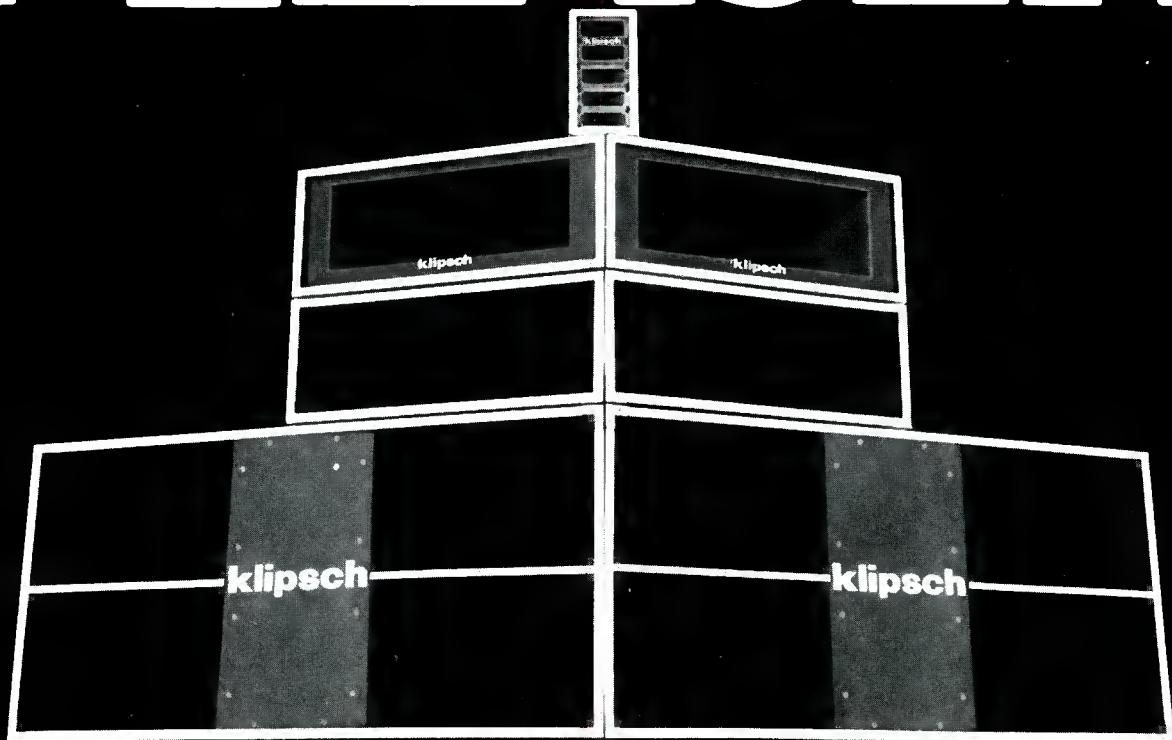

Here's the crowd pleaser—which nobody can match. The fabulous Klipsch MCM-1900 is designed to provide the same smooth, wide range response and freedom from distortion which has made the world famous KLIPSCHORN loudspeaker the standard of the industry since 1948. But this monster does it at **EIGHT TIMES THE ACOUSTIC OUTPUT POWER** of the Klipschorn . . . and without the aid of reflective surfaces.

This unique four-way Klipsch system is fully horn-loaded to drive crystal clear sound effortlessly. With continuous power of up to 1,500 watts, it can produce SPL's in excess of 100 dB at 50 meters.

Every seat is front row center with the Klipsch MCM-1900. Write for details and the name of your nearest Klipsch industrial loudspeaker dealer.



Please send me your FREE literature on the full line of Klipsch industrial loudspeaker systems, along with a list of Klipsch industrial dealers.

Name \_\_\_\_\_ Title \_\_\_\_\_

Company \_\_\_\_\_

Address \_\_\_\_\_

City \_\_\_\_\_ State \_\_\_\_\_ Zip \_\_\_\_\_

Clip and mail to Klipsch & Associates, Dept. D59, P.O. Box 688, Hope, AR 71801

Circle 19 on Reader Service Card

# INDUSTRIAL RESEARCH PRODUCTS THE PREFERRED DIGITAL DELAY SYSTEM

- superior subjective listening quality.
- new competitive prices.
- broad product line.
- available to all sound contractors.

We have nine different delay lines. From this broad range it is possible to tailor-make a digital delay system. Industrial Research Products is dedicated to providing optimized products for sound reinforcement.

## ANNOUNCING DIGITAL TANDEM CONNECTION FOR THE POPULAR DD-4012

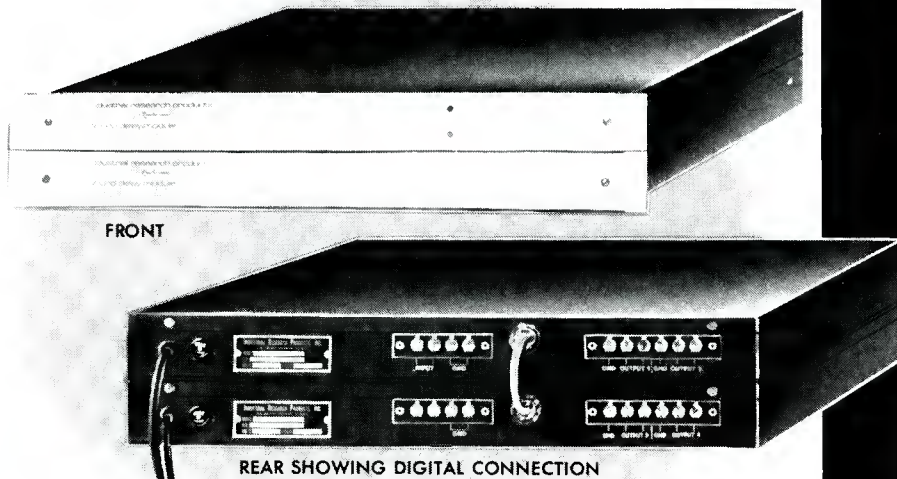

Where more than two outputs and 96 milliseconds of time are required we have added a digital connector that can link two of our DD-4012's with no signal degradation. This linkage gives the same high quality signal with 160 ms and four independent outputs.

For engineering data and pricing write:

**INDUSTRIAL RESEARCH PRODUCTS, INC.**  
321 Bond Street  
Elk Grove Village, Ill. 60007 U.S.A.  
Telephone 312/439-3600

A *Knowles* COMPANY  
Circle 42 on Reader Service Card

My own feeling: the extra help provided by audio processing (within reason) is probably needed when you're pushing a.f. thru what's basically an r.f. system.

Mr. Dunn obviously has large personal reservations about what he sees as a "deliberately wide dynamic range" of today's recordings. "The Music is always too loud for the system or too soft to hear," he adds. Frankly, it sounds as though Mr. Dunn has an undetected hearing disorder. Perhaps a visit to the doctor is in order. At any rate, I work in a newsroom full of music fans, and none of us share his problem.

If my memory is correct, the NAB equalization curves were for tapes and discs produced by stations themselves, plus agencies and networks. Actual entertainment, as I recall, was recorded using a set of curves drawn up by the RIAA. And, as I remember, nearly every turntable preamp was switch selectable to whichever curve was appropriate. Nobody ever said the NAB settings were appropriate for playback of lp's.

Design engineers fully realize the amplifier was invented long ago. But, until frequency response is infinite and distortion has been totally eliminated, there's room for improvement. And that's what designers and manufacturers are working toward.

The overall tone of Mr. Dunn's comments kind of baffles me; if he's that unhappy with the business, why doesn't he find another line of work?

IAN EVANS  
News Director, KRCR-TV  
Redding, California

### TO THE EDITOR:

It was a pleasure to finally read a couple of letters, in last month's issue of *db*, that dealt with the realities of broadcast audio processing, rather than the purist's laboratory analysis. Unfortunately for the purist, very few listeners do their listening in acoustic isolation with headphones on, staring at an oscilloscope! Listening is done in automobile traffic with horns blaring, in household kitchens with kids in the next room, at picnics, business offices, etc. THIS is the real world, and I wonder how many of these listeners, consciously or unconsciously, are influenced by the few tenths of a per cent of distortion introduced by a properly set up audio processing chain. They are more likely to be influenced by the signal-to-noise ratio—and by noise here we must

# Studio quality microphones that don't need a studio to survive.

## The CS15P condenser cardioid

microphone is equally at home in a recording environment or broadcast studio. When hand-held it puts sex appeal in a voice with its bass-boosting proximity effect. With shaped high-frequency response and its ability to handle high sound pressure levels (140dB with 1% THD at 1kHz), the CS15P is ideal for close-up vocal or solo instrument miking applications.

When boom mounted, the CS15P has better gain-before-feedback and a better signal-to-noise ratio than most shot-guns. It's phantom powered and it's rugged.

The CO15P condenser omni extends frequency response to the very limits of audibility, 20 to 20,000 Hz. Unlike other "omni's," the CO15P maintains its omnidirectional polar pattern at the very highest frequencies.

Perfect for the distant miking of an entire orchestra as well as up close on individual instruments. And like the CS15P, it's phantom powered and it's rugged.

## The Electro-Voice warranty

Electro-Voice backs up these two microphones with the only unconditional warranty in the business: for two years we will replace or

repair your CS15P or CO15P microphone, when returned to Electro-Voice for service, at no charge — no matter what caused the damage!

We can do this because we build these microphones to meet our standards for performance, ruggedness and durability. We accept nothing less, and if you're a professional, buying a professional quality microphone, you shouldn't either.

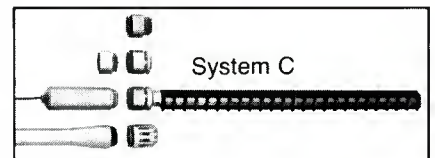

**EV** **Electro-Voice**<sup>®</sup>  
a gulton company

600 Cecil Street, Buchanan, Michigan 49107

Circle 50 on Reader Service Card

# Perfect Levels

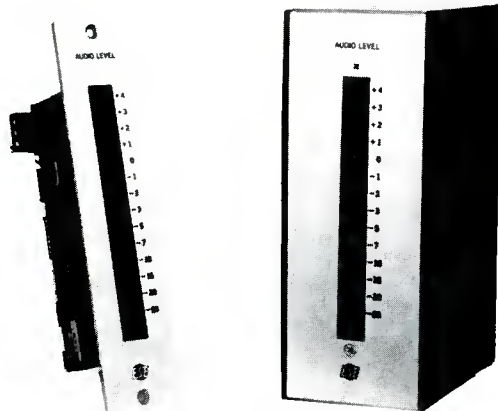

## ES 214 Dynamic Audio Level Indicator

made especially for the broadcaster  
and recording engineer

### Features:

- Peak Audio Levels or Apparent Loudness (Fast Averaging)
- Uses Standard V.U. Scale
- High Brightness, 3-Color Display
- Transformer Isolated Input
- Unregulated "Single-Supply"
- High Input Impedance and Sensitivity
- Low Cost

There are a number of Audio Level Indicators using L.E.D. bar graphs on the market today. Their acceptance is becoming widespread due to obvious advantages. However, the ES 214 gives you more: Transformer Isolated Input others consider too costly; A Power Supply Regulator on the circuit board, so you can use any unregulated D.C. voltage from +15 to +35 while others require dual supplies; The Standard Scale so you don't have to adapt to new numbers; and, the ability to select Peak Responding Mode or a special Fast Averaging Mode to approximate Apparent Loudness.

Get a handle on your levels  
with the ES 214

\$105.00



(213) 322-2136

142 SIERRA STREET • EL SEGUNDO, CA 90245

include noise in the listening environment, as well as in the receiver.

Nowhere, in any of the arguments for less processing, have I seen mention of s/n ratio. And yet, one of the primary objectives in signal processing, at least in a.m., is to bring the s/n ratio of the receiver in fringe areas up to an acceptable 7 to 10 dB. And this is at least 30 dB lower than most of the critics of processing would accept in any type of listening.

While I would never install a limiter, compressor, or even an equalizer on my home stereo, I endorse their use when properly set up at broadcast stations. The listening environments AND the source material are totally different. And let us not forget that radio is (or should be) much more than just music.

GARY E. LIEBISCH

Chief Engineer

WSPA, Spartanburg, S.C.

### TO THE EDITOR:

We noted that part of Paul Miller's article entitled "Audio Cable: The Neglected Component," dealt with "Star Quad" cable. In order to place credit where due, and also elaborate on the *modus operandi* of the cable, we offer the following:

1. "Star Quad" cable was originally developed by the British Broadcasting Corporation (B.B.C.) for use within their organization, particularly in television studios.

2. We believe Belden's introduction to the product was via specifications prepared by Purcell + Noppe + Associates, Inc. (P+N+A) for specific application in the Grand Ole Opry House.

3. Belden modified the sample of B.B.C. cable, originally submitted to them by P+N+A, to provide for increased shielding above the audio frequency range. This increased shielding however, does not improve the basic cable property, which is to provide a more random sampling of potentially interfering magnetic fields, thereby permitting closer equality of opposing currents "circulating" through the terminating amplifier input transformer; i.e., given a highly balanced input transformer, the common mode rejection (CMRR) of the system is thereby increased. A larger number of small conductors (greater than four) spiralled around a common axis should provide for a further improvement of the CMRR. However, the improvement would be dependant upon the available CMRR of the terminating amplifier input device.

RICHARD D. M. NEGUS

Senior Audio Systems Consultant  
Purcell + Noppe + Assoc., Inc.

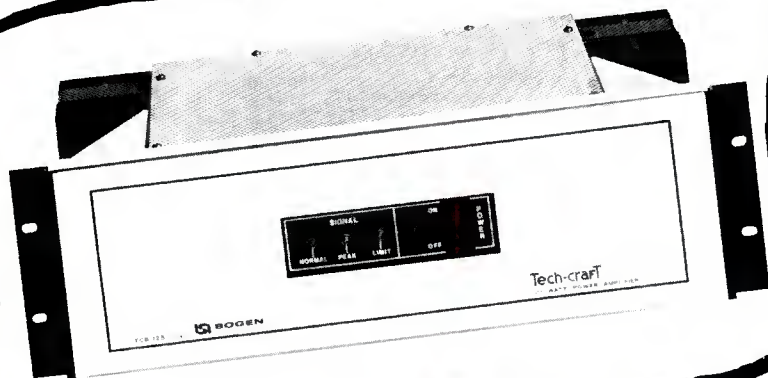

## For the Critical Link: Power Amplifiers You Can Count On EVEN IN CONTINUOUS USE, OVERLOADED, AND AT 131°F

No sound system can be any better than its critical link, the power amplifier. Whatever inputs, mixers, and speakers you use, if the power amp lets you down, the message won't go through, the show won't go on. We've designed Bogen's Tech-craft Professional Power Amplifiers to assure quality performance even under the most adverse conditions.

### UNEQUALED PROTECTION

These amplifiers can be operated 24 hours a day at rated power, into gross overloads, at ambient temperatures up to 131°F--and continue to perform superbly. They won't be damaged even if the speaker lines are shorted or the temperature goes still higher. In other words, you can't burn them out, even when overloaded. Computer-grade electrolytics are used exclusively.

### PURE POWER

The TCB-60, TCB-125, and TCB-250, rated at 60, 125, and 250 watts respectively, deliver their rated power at less than 1% total harmonic distortion, 25 to 22,000 Hz. At 20% higher power, THD is still under 2%, 30 to 18,000 Hz. Frequency response is within  $\pm 1$  dB, 20 to 20,000 Hz, at rated power. Output regulation, no load to full load, is better than 1 dB. We think, and believe you'll agree when you try them, that these are the best power amplifiers you can buy for sound reinforcement.

### ADDITIONAL ADVANTAGES

LED indicators show whether the amplifier is operating

in normal, peak, or limiting mode. You can use these three amplifiers virtually anywhere in the world, on 120 or 240 volts, 50/60 Hz. They require less rack panel height than others and their physical balance makes them easier to handle. In short, they reflect all the experience of our nearly 50 years in amplifier design and manufacture.

### 14 Tech-craft PRODUCTS

Our Tech-craft series includes, in addition, two dual-channel power amps, two mixers and two matching mixer-extenders, two graphic equalizers, a compressor/line amplifier, and two mixer-power amplifiers. All 14 products were designed by the same team, for highest performance and utmost reliability.

This is a franchised line sold through qualified professional sound installers. For more information, please write or phone us.

# Tech-craft®

PROFESSIONAL SOUND by

## BOGEN®

A DIVISION OF LEAR SIEGLER, INC.  
P.O. Box 500, Paramus, NJ 07652  
(201)343-5700  
GSA Contract #GS-00S-44859

## A.M. Proof-of-Performance

• Every a.m. broadcast station is required by FCC Rules, to make an audio proof-of-performance of its broadcast system at least once each calendar year. This in itself is a specific requirement, and what must be measured is not left up to the discretion of the station. Part 73.47 of the Rules spells out what measurements are to be made, and Part 73.40 defines the minimum technical tolerances the system must meet. Our

discussions this month will center on the various aspects of this annual activity a broadcast station must perform.

### WHAT IT IS

Although there are many and sundry component units combined into what we call a broadcast station, the "proof" measures the performance only of the "core" or basic chain of the system—the main microphone in-

put to the antenna output. The basic chain includes: the console and microphone pre-amplifier, audio processors, equalizers, telco lines or STL, the transmitter itself and its antenna load. Although a variety of units such as tape players, turntables, and so forth introduce audio programming into the head end of the system (the console), these are not part of the basic chain and are not considered in the proof measurements. All these external units do require their own maintenance so that they contribute good technical quality audio programming; but as far as the proof is concerned, they are not a part of the proof measurements.

The proof then, is a specified set of measurements to be made to the basic chain to demonstrate that it meets the minimum tolerances of the Rules. This is more than a mere exercise in measurements. If there is a fault in the system which would place the system outside tolerances, the fault must be corrected and new measurements taken to demonstrate that the system is within tolerances. Actually, the station must meet these minimum technical tolerances *all the time*—not one specific night of the year! No system will stay in top performance all the time, so an on-going maintenance program is necessary. When such a program is carried out on a continuous basis, making the proof will simply *confirm*, by measurements, that the system does meet FCC tolerances.

### STL Offers The Most **Complete Selection** Of Test Tapes Available Anywhere

If you are looking for precision test tapes, look no further. STL can serve all your needs with tapes in 2", 1/2", 1/4", cartridges for broadcast and 8-track, and cassette sizes. The most accurate reference possible in all popular test formats... Alignment, Sweep, Pink Noise, Level Set, Azimuth, and Flutter and Speed. Also available is the Standard Tape Manual which offers a ready reference for the busy recordist.

*Write or phone for fast delivery. Write for free catalog.*



STANDARD TAPE LABORATORY, Inc.

26120 Eden Landing Road / #5 / Hayward, CA 94545  
(415) 786-3546

### RESPONSE

The first parameter to be measured is the audio amplitude response across a relatively narrow band-pass. In terms of today's audio equipment and newer transmitters, this may seem somewhat short of capability. But remember that here we are measuring a sys-

# NAGRA

*Portable Perfection*

*Stereo Or Monaural With A "Flick Of A Switch"*

**Booth 68-AES Show**

*May 15-18, Los Angeles*



UNITED STATES DISTRIBUTION, SALES AND SERVICE

**NAGRA MAGNETIC RECORDERS, INC.**

19 West 44th Street, Room 715 • New York, NY 10036 • (212) 840-0999

West Coast Sales, Service & Technical Center — **RYDER MAGNETIC SALES CORP.**, 1147 N. Vine St. • Hollywood, CA 90038 • (213) 469-6391

In Canada — **ARRI/NAGRA, INC.**, 6467 Northam • Mississauga, Ont. L4V-1J2 • (416) 677-4033

\* Offer valid in U.S.A. only

Circle 23 on Reader Service Card

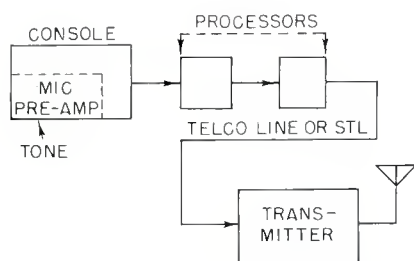

The basic chain is measured. Disable the AGC and other processing units, and make sure that the load on the transmitter is the antenna system.

tem and not an individual audio component unit.

Four sets of measurements are to be made. One set at each of these levels of modulation: 100, 85, 50 and 25 per cent. The basic audio tones in each set are: 50, 100, 400Hz, 1, 5 and 7.5 kHz. The reference to be used is 1 kHz, and the amplitude of the other tones in the range 100 Hz to 5 kHz must be within plus or minus 2 dB of the reference. Some transmitters cannot maintain a sustained tone mod-

ulation at 100 per cent, so 95 per cent modulation may be used instead. Remember that tone contains a considerable level of energy, and sustained tone modulation at high levels can cause considerable damage to transmitter and antenna components. Be as brief as possible in making the measurements, and then give the system a rest between measurements.

To make the measurements, first calibrate the modulation monitor at 100 per cent modulation. Use an oscilloscope to confirm the monitor's accuracy. The percentage of modulation is held constant for each series of tones by adjusting the amplitude of the audio input signal. Since the system output is held constant, the input signal levels must be measured in some manner. This may be done by an external audio voltmeter, or by an internal voltmeter of the signal generator. The actual system response, as plotted, will be the inverse of these measured signal input amplitudes. All AGC, limiter, and similar amplitude control devices must have their action disabled and the unit run as a straight amplifier, otherwise the resulting response curve would be meaningless.

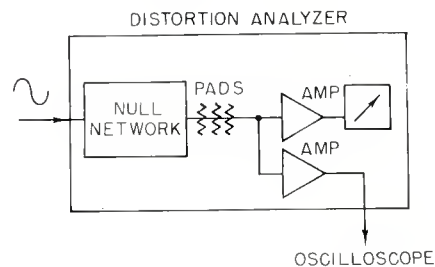

Basic modern analyzers null the fundamental tone and measure what remains as distortion.

## DISTORTION

Harmonic distortion in the audio bandpass is the next important measurement required. A series of distortion measurements, using the same audio tones and levels of modulation required for the response measurements, must be made. This is the total harmonic distortion in the bandpass. Most distortion analyzers today use a null network to cancel out the fundamental tone being observed, and then measure all that remains as distortion. Since everything else is measured, noise can become a significant part of that measurement. If the system noise is relatively high, the distortion figures will also appear higher than normal.

The minimum tolerance across the specified bandpass is 5 per cent at modulation levels up to 84 per cent. At higher modulation percentages, the tolerance is 7.5 per cent. Since these measurements are at the same tones and modulation levels as response measurements, the most convenient time to make them is at the same time the response measurements are made. After the proper modulation level has been set for a particular tone and the signal input amplitude recorded for response, calibrate the distortion analyzer to 100 per cent and proceed to make the distortion measurement for that tone.

The amplitude of the carrier should not change during modulation. Audio appears as two equal sidebands.

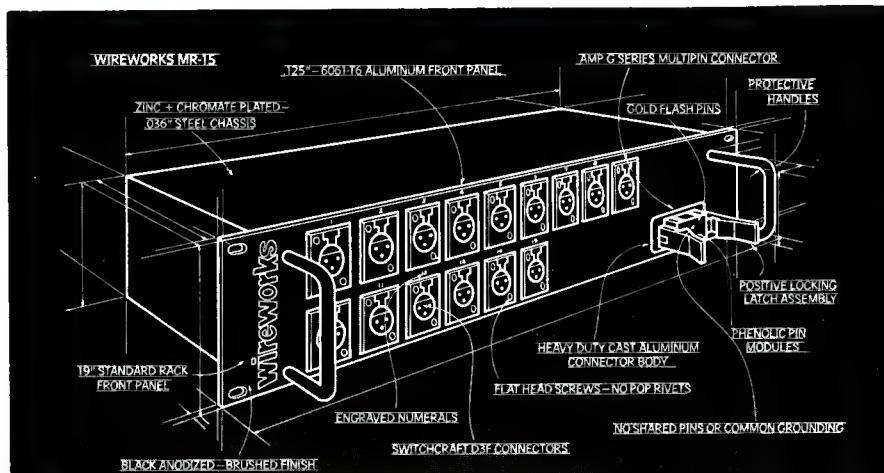
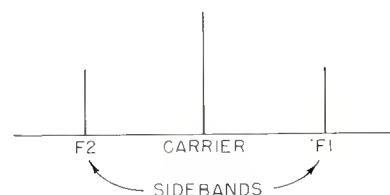

## rack & roll

Rack-pack Multicable Components:  
Multitracks from Wireworks

The MR-15 is one in a series of Multicable Components providing the features of our Multiboxes in a rack-mount package. Studio - P.A. - Remote applications, Multitracks put your cable termination where you need it.

Wireworks' Multitracks are part of our Microphone Multicable Components Group which offers you multicable in a variety of mounting and terminal configurations, ranging in size from 3 to 50 pairs. All feature AMP multipin connectors.

The Multicable Components Group from Wireworks:  
rack it and let your system roll.

wireworks

Wireworks Corporation  
380 Hillside Avenue, Hillside, NJ 07205 • (201) 686-7400

See us at AES - booth LA-1 See us at NAMM - booth 8121



# Bose for Pros

## Sound Reinforcement Components for Engineers and Performers.

The Bose Model 802 loudspeakers, PM-2 Powermixer, XM-6 Extramixer,™ and Model 1800 Power Amplifier are specifically designed to meet the demands of sound system designers and performing artists alike.

Performers applaud the exceptional sound quality, durability, and portability of Bose professional products.

Audio engineers and acoustics consultants appreciate these highly reliable, compact systems which are easy to place and install, yet deliver large amounts of sound from small enclosures.

Both acclaim the aspect of Bose products which has made them the standard of the industry; their ability to produce clear, uncolored sound with a fullness and spaciousness found nowhere else.

Send us the coupon, and we'll send you a four-color Professional Products Catalog and dealer listing.

Bose Corporation, Dept. SE  
100 The Mountain Road, Framingham, MA 01701

Please send me a copy of the Bose Professional Products Catalog and a dealer list.

Name \_\_\_\_\_

Street \_\_\_\_\_

City \_\_\_\_\_

State \_\_\_\_\_ Zip \_\_\_\_\_

Tel. ( ) \_\_\_\_\_

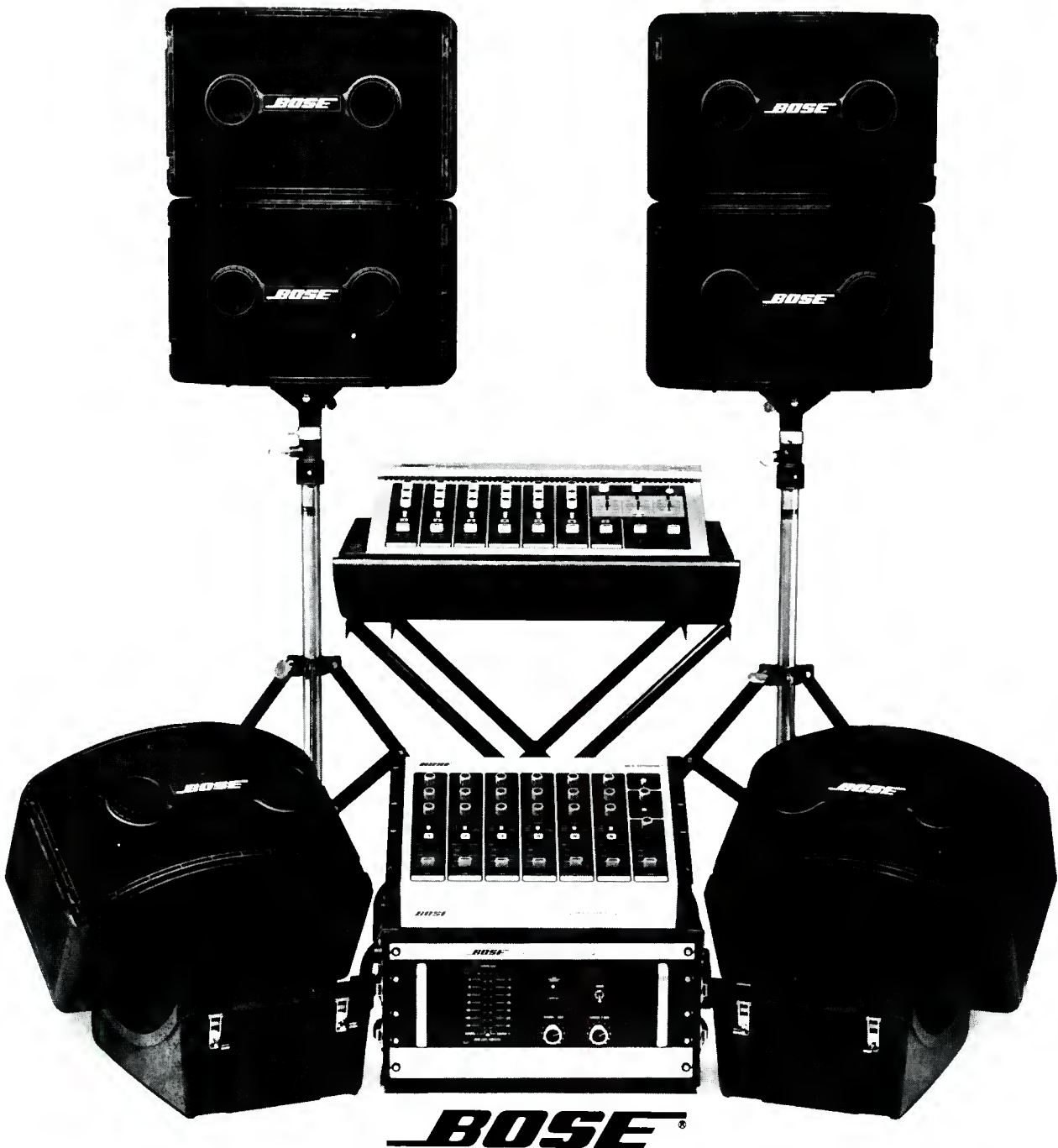

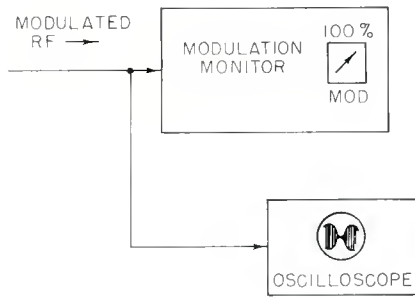

Check the accuracy of the modulation meter with an oscilloscope.

### NOISE & CARRIER SHIFT

Two other audio related measurements of the system are required—noise and carrier amplitude regulation (carrier shift). The noise is to be measured with 400 Hz tone as the modulation calibration signal, at 100 per cent modulation. The minimum tolerance is  $-45$  dB below 100 per cent modulation. Only one measurement is required, and this at the 100 per cent modulation level. This measurement can most conveniently be made during the 100 per cent level of the response and distortion runs when the series gets around to the 400 Hz area. With the transmitter modulated 100 per cent at 400 Hz tone, calibrate the noise meter. Remove the input signal to the system and terminate the input with a resistor. Then measure system noise with the calibrated noise meter.

Carrier amplitude regulation is also made with 400 Hz modulation, but a reading is required at each of the 4 levels of modulation. The tolerance here is 5 per cent. In amplitude modulation, the carrier amplitude itself does not (or should not) change—the modulation appears as two equal sidebands of that carrier. Should the carrier amplitude itself change, there is a problem somewhere. A number of faults can cause the carrier amplitude to change—poor tubes, tuning, poor power supply regulation, and so forth. Most modulation monitors have a carrier level meter on them, and this is marked off in percentage. This meter can be used for the measurement. First adjust the r.f. input to the monitor (without modulation) so the meter indicates 100 per cent. Then apply modulation at 400 Hz to each of the 4 modulation levels. Note any movement of the carrier meter in each case. If the meter increases above 100 per cent, this is positive carrier shift, but if it drops in level, this is negative carrier shift. The most convenient time to make this measurement is during the response measurements.

### SPURIOUS RADIATIONS & HARMONICS

Because of the relatively low frequency range the broadcast carriers occupy in the spectrum, they are in a position to cause havoc in the upper spectrum with spurious radiations and harmonics of the carrier. All such radiations must be suppressed, and a measurement is required to show they are at a low level. The actual tolerance is  $-80$  dB for power levels of 5

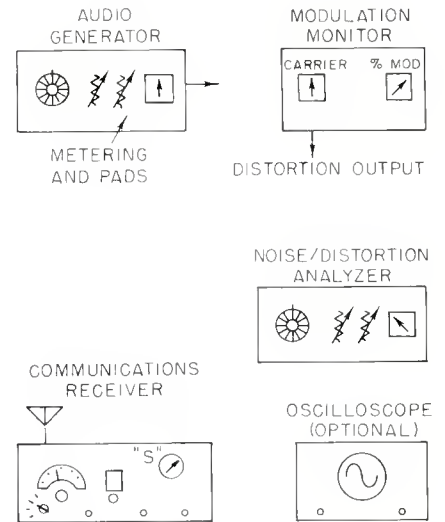

Equipment needed.

kW and higher. For lower power carriers the tolerance is different and is found from the formula:  $43 + 10 \log_{10}$  (power in watts). For a 250 watt station, this is about  $-67$  dB, a 1 kW station,  $-73$  dB. This tolerance in all cases is for radiations 75 kHz away from the carrier. Different tolerances are given for the spectrum closer to the carrier: 30 kHz to 75 kHz,  $-35$  dB; 15 kHz to 30 kHz,  $-25$  dB. These measurements can be made with an appropriate field strength meter, or a communications receiver. If there are problems or complaints, however, the FCC will require accurate measurements with a field strength meter.



We design and manufacture high-definition loudspeaker systems to exacting standards, making use of the finest materials available.

P.A. • Stage & Instrument Monitor • Studio Monitor

Eastern Acoustic Works, Inc.

59 Fountain Street, Box 111, Framingham, Massachusetts 01701/(617) 620-1478

Circle 43 on Reader Service Card

# The Orban 526A Dynamic Sibilance Controller:

the single channel de-ess specialist

Introducing the Orban 526A — an improved, single-channel version of our internationally-accepted Dynamic Sibilance Controller. It features a mike input, fully-balanced input and output, LED level display, and GAIN control.

The 526A performs the de-ess function *only* without the compromises inherent in multi-function processors. It's clean, quiet, stable, and easy to use. So it's invaluable anywhere speech is processed professionally: recording studios, cinema, broadcasting, cassette duplication, and more. It's a *simple* time-saver and problem-solver — and at \$399\* you can't afford to be without it.

The Orban 526A De-Ess Specialist is available at your Orban pro-audio dealer.

\*suggested list



**orban**

Orban Associates Inc.  
645 Bryant Street  
San Francisco, California 94107  
(415) 957-1067

See it at AES Booth 62.

## EQUIPMENT NEEDED

If meaningful measurements are to be made, then test equipment of suitable accuracy is necessary, and suitable procedures employed to insure accurate measurements. The most basic item is the station's modulation monitor that has been properly calibrated. The monitor provides the correct indication of modulation required for each measurement, and it also provides a detected audio output to drive the noise/distortion analyzer. Some analyzers have a built in detector for this purpose, and this can be

used by feeding modulated r.f. directly to the analyzer for distortion and noise measurements.

An audio signal generator is required to feed tones into the system as the audio modulating signal. Besides the input signal frequency, the input amplitude level to the system must be measured by an accurate audio voltmeter. This voltmeter may be a separate instrument, or it may be an integral part of the audio signal generator.

The noise/distortion analyzer must be a quality instrument that has a

wideband input. Most models available today have a bridge circuit which tunes out the fundamental audio tone fed to the unit, and its internal meter and amplifier measures all that remains as distortion. Since part of this indication can also be noise, an amplified output of the metering circuit is provided so oscilloscope observation can be made.

For the spurious radiations measurements, a communications receiver can be used, as few stations own a suitable field strength meter. Use the "S" meter of the receiver if it will provide suitable indications, or the AVC bus can be brought out and the d.c. voltage measured with a regular voltmeter. If this is done, the receiver must be switched into a manual r.f. gain control mode.

## A microprocessor-controlled audio analysis system.

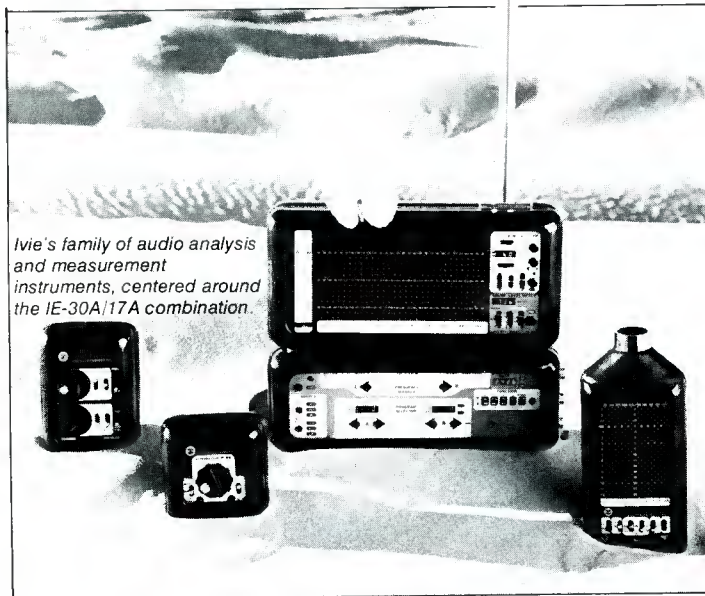

- 1/3 octave band real-time analyzer
- Precision sound level meter (Type 1, IEC 179)
- Peak, impulse, fast and slow responses
- Automatic spectrum plots
- System weight 4.5 lbs.

The new family of Ivie acoustic and audio analysis equipment is the most advanced measurement system in the world, yet is so light and compact you can place a complete acoustics laboratory under an airline seat.

Now you can accurately measure sound pressure levels and perform real-time, third-octave band analysis simultaneously. Measure  $RT_{60}$ , delay, decay, and program an infinite number of time/amplitude variables for gated time measurements. The newest computerized Ivie analyzer is a versatile, compact, acoustics laboratory that is completely independent of power cords. Plot amplitude vs. time, amplitude vs. frequency, etc., with precision accuracy, and generate "hard copy" automatically into any standard X-Y recording device.

Ivie has a complete family of audio analysis products and accessories designed for your particular application. Our products are sold and serviced worldwide.

Write for product catalogs containing specifications and applications information.



Ivie Electronics Inc.  
500 West 1200 South  
Orem, Utah 84057  
Telephone (801) 224-1800  
TELEX or TWX 910-971-5884

And see our newest ideas at AES booths 88/89.

## WINDUP

When all the measurements have been made and all within specifications, restore everything for normal programming—remove patch cords, terminations from jacks, re-activate the AGC, limiters and similar devices which were disabled and so forth. Make sure the place works or the sign-on operator will probably call you out of bed!

At some later time, when you have recovered from all this, draw the response curves, distortion curves and other data into a much more presentable package than your nighttime scribbles. Draw a block diagram of the line-up, and describe how the measurements were made. Sign and date the proof, and retain it at the station for the next 2 years, so an FCC inspector may look at it if he desires. ■

## MOVING?

Keep **db** coming  
without interruption!

Send in your  
new address *promptly*.

Enclose your old  
**db** mailing label, too.

Write to:

Eloise Beach, *Circ. Mgr.*  
**db** Magazine  
1120 Old Country Rd.  
Plainview, N.Y. 11803

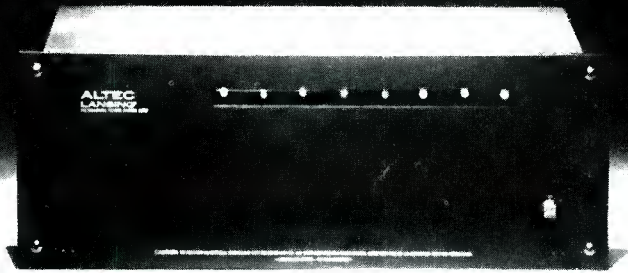

## Introducing Altec Lansing's Incremental Power System. And Its Closest Competitor.

Lately a lot of the big names in professional amplification have been making head-to-head comparisons with their competition. And, understandably, the brand being featured in each ad usually comes out on top. But one product that no one is comparing themselves with is Altec Lansing's new Incremental Power System.

That's not really surprising since Incremental Power is a lot more than just an amplifier. Each main frame actually contains a flexible array of power amps, electronic crossovers, line amps and input devices. So you get a complete amplification system that's prewired and ready to use. And since it is a system, Incremental Power offers a degree of flexibility that's unmatched by any single amplifier. In fact, to match the overall performance of one Incremental Power System you'd need a rack full of traditional components.

Skeptical? To prove the point we've devised a head-to-head comparison that you can make for yourself. Below you'll find the

published specifications for an Incremental Power System set up for stereo, triamplified operation. Simply select the competitive components that you'd need to match Incremental Power's performance and then judge for yourself.

There's a lot more to Incremental Power than we have room to tell you here. So if this kind of performance and package size sounds good to you, contact our Commercial Sound Sales Department for the details. Or check the Yellow Pages under Sound Systems for the name of your local Altec Lansing sound contractor. Either way you'll get the complete Incremental Power story. We think you'll agree that our short story makes the competition look a long way behind.

Altec Lansing Sound Products Division, 1515 South Manchester Avenue, Anaheim, California 92803.



Altec Corporation

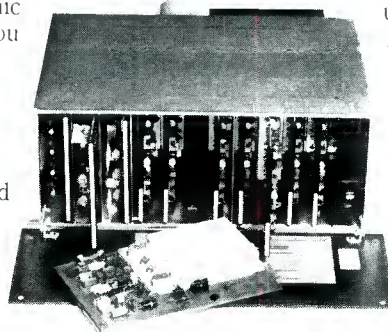

	Power Available for L.F. @ Mfg. Rec. Load	Power Available for M.F. @ Mfg. Rec. Load	Power Available for H.F. @ Mfg. Rec. Load	Electronic X-over	Cooling	Weight	Height	Reliability
Incremental Power System	300 Watt Total 150 Watt/Ch. @ 8 ohm	150 Watt Total 75 Watt/Ch. @ 16 ohm	150 Watt Total 75 Watt/Ch. @ 16 ohm	2 or 3-way Selectable Freq.	Built-in fan blows side- to-side	70 lbs.	7"	Excellent each unit factory tested

## Feedback and Phase

● As used in audio, the word feedback almost invariably implies "negative feedback." Perhaps we can explain what this means by using servo-mechanisms to illustrate, because this is a more visual application for feedback. A servo-mechanism is basically an error-reduction device. Suppose you have a weather vane on top of a building to indicate wind direction. And you want a remote indication in a weather station, down on the ground floor.

### MOTOR-GENERATOR SYSTEM

You could couple together the two indicators by means of a motor-generator, so that, whenever one moves, the other one moves with it (or with very little lag). This has two problems: to minimize lag, requires very tight electro-mechanical coupling; and when you have that condition, it means that it takes a little more effort to move both of them, than the sum of the effort required to move each separately.

If the wind is strong, it will move the vane on top of the building, and the one downstairs with it, with little trouble. But if the wind is only light, the force on the upstairs vane may not be enough to move both of them at all, so it will fail to indicate, when the wind changes direction. This is where a servo-system can help.

### SERVO-SYSTEM

In a servo-system, the wind has to move only the vane on top of the building. The system, in effect, reads the vane and tells the downstairs indicator what it should be. Now there are two direction indicators on top of the building: the one that responds to the wind, and one that follows the indicator downstairs, by a similar servo-mechanism—except now the gentle wind does not have to provide the driving force.

The power to drive the downstairs indicator, as well as the second one on the roof, is derived from any suitable power supply, in response to an "error signal." This is obtained by a device that measures the difference in angle between the vane moved by the wind, and the copy indicator moved by the follower power supply. And the error signal instructs the power supply to move the second indicator in a direction that will reduce the error.

When the error has been reduced to zero, the moving force from the supply power is switched off, because now both indicators say the same. That is a form of negative feedback, because its purpose is to reduce the error. But what if someone connects the error signal to the control circuit the wrong way? If we assume for the moment that both read the same, nothing will happen. But as soon as

**ENHANCE THE DANCE**

With the new LS/FOUR  
system light controller

**EKKOR**

A DIVISION OF OMNICO MP 5150 N 16TH ST, SUITE 253, PHOENIX, AZ 85016 602/264-2475

# HUSH MONEY.

The dbx 208 tape noise reduction system is a new product that will impress both your engineering staff and your accountant. The 208 features 8 channels of simultaneous noise reduction on plug-in modules, plus a spare, all in a compact 5¼" rack mount package.

dbx noise reduction is rapidly becoming the new industry standard because it provides 30 dB noise reduction and 10 dB headroom improvement, from 20 Hz to 20 kHz, without the problems of other systems. The dbx system does not require critical and time-consuming level-match adjustments. Its true RMS detectors are not sensitive to tape recorder phase shift. Its voltage-controlled amplifiers (VCAs) operate over a 100 dB range. Overall the dbx system provides a level of performance and a simplicity of operation that is unsurpassed.

But the 208 is also a great value. It is priced at \$3300. That's \$6600 for your 16-track and \$9900 for your 24-track.\* And no matter how complex the future becomes, the 208 system expands simply and economically.

The dbx 208. The easy solution to your noise problems, today and in the future.

dbx, Incorporated,  
71 Chapel Street  
Newton MA 02195  
617-964-3210

# dbx

## UNLOCK YOUR EARS



\*Nationally advertised value.  
Actual prices are set  
by dbx dealers.

Circle 22 on Reader Service Card

the wind moves the vane, the error will cause a drive that increases the resulting difference, and bingo, they move apart wildly. That is positive feedback.

### NEGATIVE FEEDBACK

Negative feedback in audio amplification serves a precisely similar purpose. You have an input of some specific waveform, with an amplitude of, say 1 volt. You want that amplified to, say 40 volts, across a load impedance of 8 ohms, which would be 200 watts. The output should be an

exact duplicate of the input, just 40 times bigger, and with power to "drive" an 8-ohm load. How does negative feedback achieve this?

Suppose we want 40 dB feedback. This means that the amplifier, instead of giving 40 volts output for 1 volt input, must give that output for 0.01 volt, or 10 mV input. So the feedback must offset that 1 volt input with 0.99 volts, to leave the 0.01 volt difference. Now, suppose that for some reason a point on the waveform that should represent 20 volts at the output, instead gives an output of

only 15 volts, without feedback to correct it.

The input, before feedback, would be 0.5 volt. And the feedback signal, assuming it does nothing to make the correction, will be  $0.99 \times 15/40 = 0.37125$  volt. Now, the difference applied to the input, will be  $0.5 - 0.37125 = 0.12875$  volt. And if 0.01 volt input gives 40 volts output, obviously 0.12875 volt will give a lot more, unless something else happens.

Let us apply a little feedback theory. The amplification without feedback, given the symbol  $\alpha$ , is normally  $40/0.01 = 4,000$ . That's voltage amplification. As the impedance is different, a real calculation would take that into account. If what should be 20 volts output, comes out at 15 volts, that means  $\alpha$  has momentarily dropped to 3,000.

The amplification with feedback is  $40/1 = 40$ , which means the amplification is divided by 100. That is what 40 dB feedback means. It also means that the feedback factor,  $1 + \alpha\beta$ , is 100, or  $\alpha\beta = 99$ . As we have already calculated  $\alpha$  as 4,000, this means  $\beta = 99/4,000 = 0.02475$ . Remember that  $\beta$  does not change. So we now put in  $\alpha = 3,000$ . That makes  $\alpha\beta = 74.25$ , and  $1 + \alpha\beta = 75.25$ . And gain with feedback is  $3,000/75.25 = 39,867.109$ .

Now, if the output should have been 20 volts, where it actually became 15 volts, the input at that point must be 0.5 volt—half that for the 40 volt output. So feedback brings the output to  $0.5 \times 39,867.109 \dots = 19,933.554 \dots$  which is much closer than 15 volts. You see what we mean by negative feedback being error-reduction?

### THE EFFECT OF PHASE

But now, to get to see the effect phase can have, we first consider reversing it, which is a change of  $180^\circ$ . We will get around to other angles later. First let's take the simple ones and, as we shall see, these are always the important ones. In positive feed-

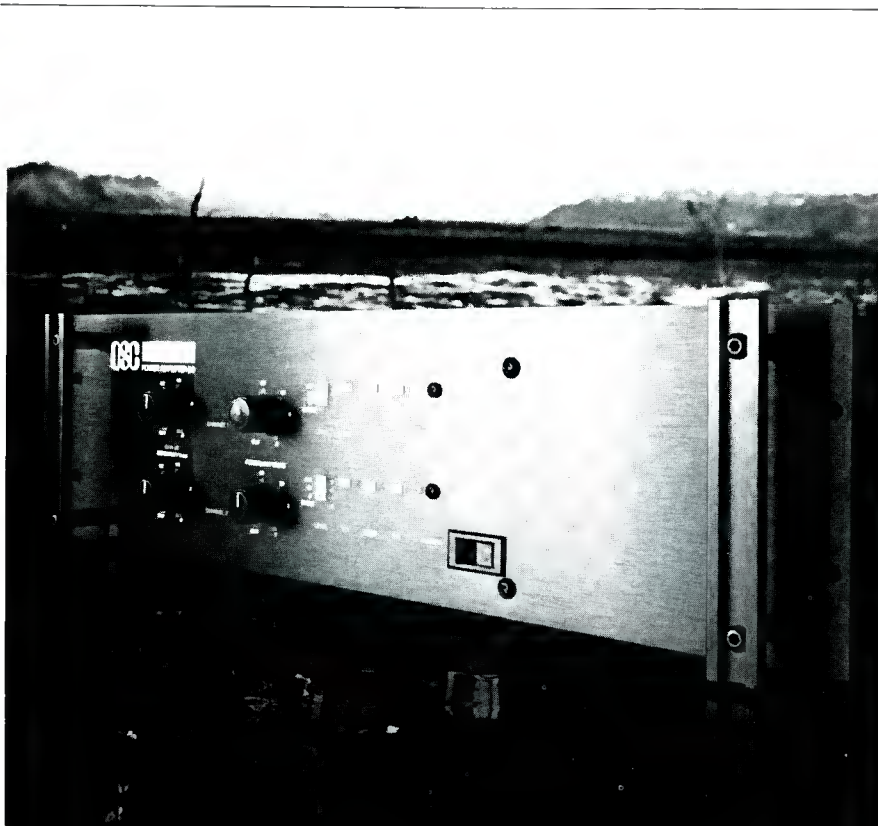

# LOADED... THE 600 WATT NO-OPTION AMP.

People kept asking us "How about a high-power amp with low distortion that's loaded with options and doesn't cost an arm and a leg?" We listened to them and set out to build "The Complete Amp" with reliability, power, specs, features, and price. We've succeeded. Our reputation has been built on the design and construction of cost-effective gear combining maximum performance with simplicity and reliability. Now QSC offers a package you can't find in any other amp. REGARDLESS OF PRICE OR OPTIONS. The A 8.0 delivers 300 watts of clean power to each channel (20-16kHz with less than .09% THD

rising gradually to 0.2% THD at 20 kHz into 4 ohms) and 600 watts into 8 ohms with the same specs in the bridged-mono operation.

Features include: PowerLimit Controls; Fan Cooling; 3-way Load Protection; LED displays for level, distortion, and limiting indicators; Balanced Inputs with XLR type 3-pin connectors; and Outputs with 5-way binding posts, phone jacks, and speaker protection fuses. Ask your Pro-Audio

**QSC**  
AUDIO PRODUCTS

1926 Placentia Avenue  
Costa Mesa, CA 92627  
714/645-2540

Dealer about the A 8.0 or write directly to us for a free brochure detailing the incredible features and specifications of this exceptional new power amplifier from QSC.

## Copies of db

Copies of all issues of **db—The Sound Engineering Magazine** starting with the November 1967 issue are now available on 35 mm. microfilm. For further information or to place your order please write directly to:

University Microfilm, Inc.  
300 North Zeeb Road  
Ann Arbor, Michigan 48106



# THANKS HOLLYWOOD

(Nashville, New York and San Francisco)  
For Hanging in There Until SEATTLE Was Ready to Happen

**PRO  
AUDIO  
SEATTLE**  
Professional Audio  
Equipment & Services



EXCLUSIVE MCI REPRESENTATIVE IN THE PACIFIC NORTHWEST

A lot of people in the recording business are looking at the Pacific Northwest as the next place to happen.

In the past 3 years Pro Audio Seattle has seen more and more national recording artists, producers and engineers become LA expatriates and head north.

To help build the new studios and upgrade the existing studios that will serve this influx of talent, PRO AUDIO SEATTLE is proud to announce that we are the newest franchised MCI dealer in America.

Thanks for helping us make it happen.

Craig G. Ingle  
President

Bob Ullius  
Sales Manager

2320 Sixth Avenue

Seattle, Washington 98121

(206) 622-6984

**PRO  
AUDIO  
SEATTLE**

Professional Audio  
Equipment & Services

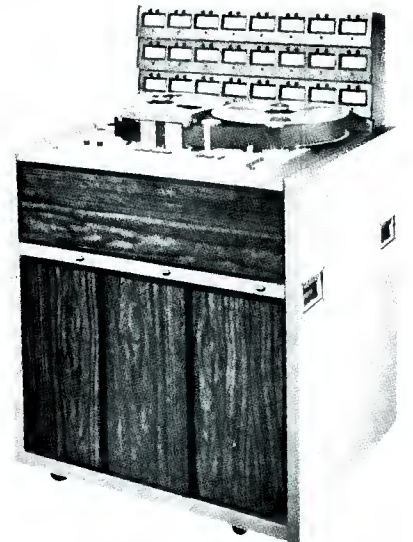

Exclusive MCI Representatives in the Pacific Northwest  
2320 Sixth Ave. • Seattle, Washington 98121 • (206) 622-6984

Circle 17 on Reader Service Card

back, the polarity of  $\beta$  is reversed. So the formula for gain with feedback is  $\alpha$  divided by  $1 - \alpha\beta$  instead of by  $1 + \alpha\beta$ .

Suppose we have an amplifier, without feedback, that gives 40 volts for 1 volt input, and we want it to give the same 40 volts output for 0.1 volt input. Positive feedback could do that. We make  $\alpha\beta = 0.9$ , so that  $1 - \alpha\beta = 0.1$ . We know that  $\alpha$  is 40, so  $\beta$  is  $0.9/40 = 0.0225$ . That does not change, but  $\alpha$  may.

Suppose  $\alpha$  drops to 39. Then  $\alpha\beta$  is 0.8775, and  $1 - \alpha\beta$  is 0.1225. Gain with feedback, is  $39/0.1225 = 318.367$ ,

which is quite a drop from the 400, when gain without feedback is 40. Now suppose  $\alpha$  rises to 41. Then  $\alpha\beta$  is 0.9225, and  $1 - \alpha\beta = 0.0775$ . So gain with feedback is  $41/0.0775 = 529.03$ , which is an even bigger rise in gain. In fact, if gain rises to reciprocal  $\beta$ , or  $1/0.0225 = 44.44$  . . . you have yourself an oscillator instead of an amplifier.

### PHASE ADVANCES & DELAYS

Now how do you apply that to phase variations that are not simple plus and minus quantities? If you have gone into the theory of coupling

networks, you will know that low-pass filters, or high frequency roll-offs, are accompanied with phase delays, while high-pass filters or low frequency roll-offs are accompanied by phase advances.

Each reactance element, inductance or capacitance, can contribute up to  $90^\circ$  in ultimate phase shift. So 2 reactances contributing to either kind of roll-off can reach  $180^\circ$  phase shift. But this is only reached at zero or infinite frequency, where gain has dropped to zero, so we do not have to worry about phase reversal in coupling networks with only 2 reactance elements—but we may get close enough to it to make a good response bad, even if it does not become unstable.

### PHASOR QUANTITIES

Any system with 3 reactance elements contributing to the same direction roll-off (low or high) can get you into instability problems. But how can we explore what is likely to happen? What helps is the fact that the quantities  $\alpha$  and  $\alpha\beta$  can be considered as vector, or phasor quantities. The important relationship, you may have guessed, is that denominator in the formula, which for simple positive or negative feedback, is designated  $1 - \alpha\beta$  or  $1 + \alpha\beta$  respectively.

If you establish a unit for your phasor diagram, that unit is 1. You measure that unit in a given direction from the origin of your diagram, which we will call "-1." Now, in the opposite direction, from the origin, you measure off a length representing the quantity  $\alpha\beta$ . That is, if you are considering negative feedback. Then  $1 + \alpha\beta$  is the length measured from -1 to the end of that phasor, instead of from the origin.

If you are considering positive feedback, you measure  $\alpha\beta$  in the opposite direction—the same direction as your "-1" unit. If  $\alpha\beta$  is less than 1,  $1 + \alpha\beta$  will be smaller than 1, but still measured in the same direction, from the "-1" point as reference. But if  $\alpha\beta$  is greater than 1,  $1 + \alpha\beta$  will reverse direction, representing instability, or oscillation.

### NYQUIST DIAGRAM

Now we can extend this to other angles. We measure the phasor representing  $\alpha\beta$  from the origin, in magnitude and phase. Then  $1 + \alpha\beta$  is the phasor, in the same diagram, that uses the "-1" point as origin. It's as simple as that. That is called a Nyquist diagram, named after the man who first applied this geometrical construction to arrive at it.

# Soundcraftsmen

**PROFESSIONAL**

## THIRD-OCTAVE EQUALIZER



**WITH PERFORMANCE/SPECIFICATIONS ABOVE ALL—  
at a price the budget-conscious pro can afford.**

FEATURES	SPECIFICATIONS
<ul style="list-style-type: none"> <li>• 15-band <math>\frac{1}{3}</math> octave equalizer—two channels</li> <li>• 6-band alternate <math>\frac{1}{3}</math> octave equalizer—two channels</li> <li>• Zero-gain level controls</li> <li>• L.E.D. indication of unity-gain in/out level balancing</li> <li>• System 1/line equalization—either channel</li> <li>• System 2/tape equalization—either channel</li> <li>• Low shelving—3dB @ 15 Hz, 12dB per octave roll off</li> <li>• Eq defeat—separate (each channel)</li> <li>• 600 ohm balanced or unbalanced operation</li> <li>• Zero insertion loss</li> <li>• Stereo operation</li> <li>• Mono operation—each channel separately</li> <li>• Tape monitor circuit</li> </ul>	<ul style="list-style-type: none"> <li>• TOTAL HARMONIC DISTORTION 01% @ 2V RMS</li> <li>• IM DISTORTION 01% @ 2V RMS</li> <li>• SIGNAL-TO-NOISE 114dB-10V RMS output—100dB-2V RMS output</li> <li>• INPUT CAPABILITY Maximum 10V RMS-22dBm</li> <li>• OUTPUT CAPABILITY 10V-22dBm</li> <li>• INPUT IMPEDANCE 47K—balanced or unbalanced</li> <li>• OUTPUT IMPEDANCE 600 ohms-balanced—300 ohms-unbalanced</li> <li>• ISO CENTER FREQUENCIES (Hz) (<math>\frac{1}{3}</math> Octaves) 40, 50, 63, 80, 100, 125, 160, 200, 250, 315, 400, 500, 630, 800, 1K; (Alternate <math>\frac{1}{3}</math> Octaves) 1.6K, 2.5K, 4K, 6.3K, 10K, 16K</li> <li>• BOOST/CUT INDIVIDUAL CONTROLS <math>\pm 22</math>dB (all other controls at max); <math>\pm 15</math>dB (all other controls at zero)</li> <li>• LO FILTER 3dB @ 15 Hz, 12dB/octave</li> </ul>

PRICE INCLUDES WALNUT SIDE PANELS AND COMPUTONE CHARTS **\$550.**

### NEW BASIC EQUALIZER \$249.00

#### 9 EQUALIZER FEATURES:

- 1—Environmental EQ Test Record and Computone charts
- 2—EQ Tape Recording
- 3—Tape Monitor
- 4—Two Master Output Level
- 5—EQ defeat
- 6— $\pm 16$ dB-12dB EQ/octave
- 7—S/N-10.5dB
- 8—Cabinet included as shown
- 9—THD less than 0.01% @ 2V.

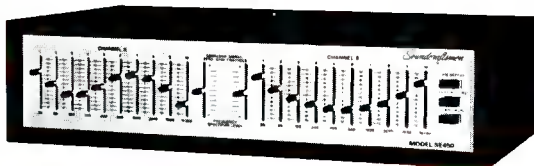

### FREE! 16-page Full-Color Brochure

Includes TEST REPORTS, complete specifications, Class "H" amplifier ENGINEERING REPORT, EQ COMPARISON CHART, and the "WHY'S & HOW'S" of equalization—an easy-to-understand explanation of the relationship of acoustics to your environment. Also contains many unique IDEAS on "How the Soundcraftsmen Equalizer can measurably enhance your listening pleasures," "How typical room problems can be eliminated by Equalization," and a 10-POINT "DO-IT-YOURSELF" EQ evaluation checklist so you can FIND OUT FOR YOURSELF WHAT EQ CAN DO FOR YOU!

SEND \$6.00 FOR EQUALIZER-EVALUATION KIT: 11" x 12" LP TEST RECORD, 1 SET OF COMPUTONE CHARTS, 1 COMPARISON CONNECTOR, 1 INSTRUCTION FOLDER



by SOUND-CRAFTSMEN, SANTA ANA, CA 92705 • Canada: ESS AUDIO (Canada) LTD., Ontario

The full Nyquist diagram plots the locus of the end of all the phasors for changing frequency. In mid-range frequencies, the locus will stay close to the zero-phase-shift phasor, in which its direction is  $180^\circ$  from the “-1” phasor. As either low or high frequency roll-off is approached, the figure opens out, and rotates, toward the opposite direction.

If the locus encloses the “-1” point, the amplifier, or whatever system is being plotted, is unstable, and will oscillate in a manner that may or may not be predicted by this particular diagram. If it stays inside the “-1” point, the system should be stable, although what happens to its frequency response, and phase performance may be something else.

At every frequency, there is a phasor construction, consisting of the zero, or origin, to the “-1” point, as a “base” line. Then the line from the origin to the apex of the triangle represents the quantity  $\alpha\beta$ , while the line from the “-1” point to the same apex represents the quantity  $1 + \alpha\beta$ , for the same frequency. As frequency changes, the position of the apex of this triangle changes, and the locus of the apex, traced out, represents the Nyquist diagram for the system, such as an amplifier, that is being portrayed.

Each line, at that frequency, represents the magnitude and phase of its specific quantity. And the angle at the apex of the triangle represents the transfer phase, with feedback, at that frequency. At most frequencies, that angle is much smaller than the angle of either the  $\alpha\beta$  or the  $1 + \alpha\beta$  line, being essentially the difference between those angles.

If the locus of the apex swings round inside the “-1” point, at the instant when the angle of  $\alpha\beta$  is  $180^\circ$  and the angle of  $1 + \alpha\beta$  is  $0^\circ$ , the angle at the apex is also  $180^\circ$ . This is the situation for a stable system, in which the  $180^\circ$  transfer point occurs with sufficient loss of gain to maintain stability. If the locus of the apex swings round outside the “-1” point, both base angles reach  $180^\circ$  at the same frequency, and the apex angle is  $0^\circ$ . Now that  $0^\circ$  represents in-phase, positive feedback, resulting in oscillation.

What happens if the locus encloses the “-1” point, at a value greater than 1? To maintain oscillation, it only has to be 1. If it is more than 1, oscillation will build up, more rapidly according to how much it exceeds 1. And it will do this until the system overloads, which must result in waveform distortion. As soon as such distortion occurs, more than one frequency is present—the diagram can

no longer represent the condition at a single frequency, which is the theory behind it.

### MULTIPLE FREQUENCIES

Now we are running into what really happens in practice, and how you can represent that happening in theory. You have two alternatives. Either you can analyze waveforms, when a stable condition is reached, into their component frequencies, and represent what happens in terms of those component frequencies. Or more realistically, you can treat what

happens, instant by instant through the waveform. At some points on the waveform, the amplifier will be inoperative as an amplifier, because some component is cut off or saturated, while at other points there will be an excess of gain.

In either event, the simple Nyquist diagram, formed on the postulate of treating one frequency at a time, no longer applies. It may apply briefly, while the oscillation is building up toward saturation, but once saturation is reached, you need a more complicated way of explaining what happens. ■

## Simple. Clean. Professional.

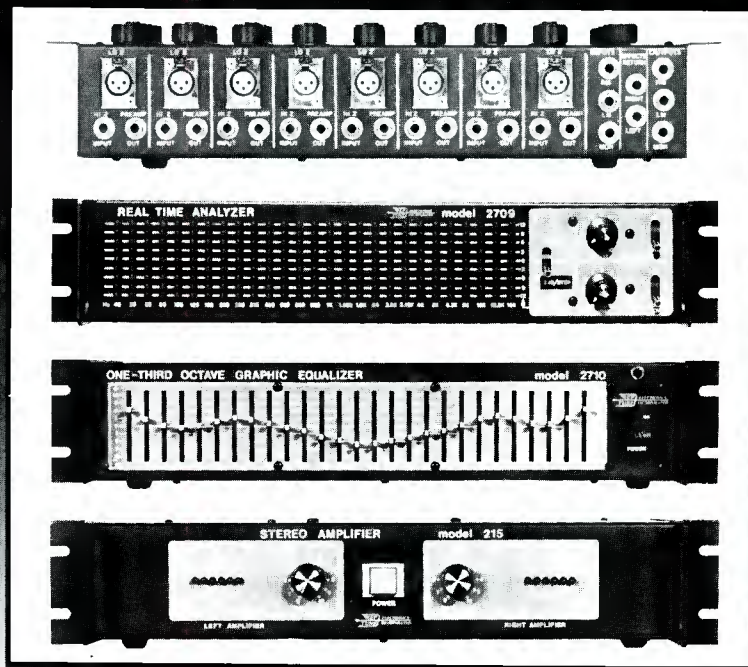



You won't find a lot of fancy knobs and flashy trim on Neptune sound reinforcement equipment. We concentrate on the engineering inside our cabinets rather than the “gingerbread” outside. Our configurations are clean and simple. Our designs are classically straight forward. This kind of engineering emphasis not only makes Neptune equipment much more affordable, but you are sure of receiving the kind of professional performance you require. See your Neptune dealer for a personal demonstration or write us today for information.



**Neptune**  
Neptune Electronics, Inc.  
934 N.E. 25th Avenue  
Portland, Oregon 97232  
Telephone (503) 252-4445

# db New Literature

  
**INTRODUCING THE**  
**BODE VOCODER**  
 SIXTEEN CHANNEL MODEL No. 7702



THE VOCODER FOR THE PROFESSIONAL  
 WHO DEMANDS TOP PERFORMANCE  
 AND ULTIMATE VERSATILITY.

**FEATURING:**

- PATCH SELECT CONTROL ACTIVATING PRESELECTED CROSS PATCHES.
- SAMPLE/HOLD TO SUSTAIN ENTERED TONE COLORS.
- VOCODER/BYPASS CONTROL.
- FAST 6 MILLISECOND RESPONSE TO PROCESS PERCUSSIVE SOUNDS.
- HIGH FREQUENCY EXTENDER CHANNEL FOR SUPERIOR INTELLIGIBILITY.

 FOR DETAILS CONTACT

**BODE SOUND CO.**  
 1344 ABINGTON PL.  
 NO. TONAWANDA, N. Y. 14120  
 716.692.1670

Circle 39 on Reader Service Card

**J&R**  
 THE ONE-STOP MUSIC  
 SHOP AT WHOLESALE PRICES

BLANK TAPES		REEL-TO-REEL	
Ampeg Grand Master I C-60	\$2.14	Maxell UD 35-90 1500 ft.	\$5.49
Ampeg Grand Master II C-90	\$2.79	Maxell UD XL 35-90B 1800 ft.	\$6.75
BASF Studio C-90	\$2.82	Maxell UD 35-180 3600 ft.	\$5.19
BASF Professional	\$1.99	TDK L 1800 1800 ft.	\$5.30
II or III C-90	\$1.92	Scotch 212 1800 ft.	\$4.35
Maxell UD C-90	\$2.85	Scotch 207 1800 ft.	\$5.22
Maxell UD XL I or II C-60	\$2.50		
Maxell UD XL I or II C-90	\$3.47	VIDEO TAPES	
Scotch low-noise (Dynaridge)	\$2.50	BETA FORMAT	
C-90 / 3 pk.	\$4.99 for 3	Sony L-750 (3 Hour)	\$18.95
Scotch Master I C-90	\$2.84	Sony L-500 (2 Hour)	\$13.95
Scotch Master II or III C-90	\$3.29	Scotch L-500 (2 Hour)	\$13.50
Sony Farachrome C-90	\$3.56	Zenith L-600 (2 Hour)	\$13.95
TDK D C-60	\$1.20	Ampez L-500 (2 Hour)	\$12.95
TDK D C-90	\$1.68		
TDK D C-120	\$2.10	VHS FORMAT	
TDK D C-180	\$2.99	JVC T-120 (4 Hour)	\$18.75
TDK AD C-60	\$1.79	Sony T-120 (4 Hour)	\$19.50
TDK AD C-90	\$2.59	Fuji T-120 (4 Hour)	\$17.95
TDK SA C-60	\$2.22	RCA VK-250 (4 Hour)	\$18.95
TDK SA C-90	\$3.18	RCA VK-125 (2 Hour)	\$14.95
		Panasonic NV7-120	\$18.95
		Panasonic NV7-60	\$14.95

Minimum Order 12 Tapes - 100% Guaranteed.

CARTRIDGES		SHURE	
audio-technica		V15 TYPE IV	\$39.90
AT-20 SLA	\$119.00	V15 TYPE III	\$64.95
AT-15 SA	\$45.90	M55ED	\$29.75
AT-14 SA	\$48.95	M91ED	\$21.00
AT-12 SA	\$4.90	M44E	\$13.80
AT-10	\$12.00	M70EJ	\$9.90
STANTON			
8815	\$72.50	PICKERING	
681EEE-S	\$55.00	KSV/3000	\$49.95
681EE	\$42.50	XV15/1200E	\$39.95
680EE	\$24.90	XV15/750E	\$32.50
500E	\$12.60	XV15/625E	\$25.77
		XV15/400E	\$22.45

HEADPHONES		KOSS	
HD-44	\$23.88	PRO 4AA	\$39.90
HD-400	\$25.28	PRO 4 AAA	\$48.00
HD-414	\$44.88	HV/1	\$29.97
HD-424	\$65.28	HV/1LC	\$35.97
		K/BA	\$19.97

**HOW TO ORDER:** For shipment within 48 hours, send money order or certified check. Two weeks delay on personal checks. Please add \$3.50 per order for shipping & handling. (\$5.50 for orders outside U.S.). N.Y.S. residents add tax. No C.O.D.'s. All merchandise 100% guaranteed, brand new & factory fresh.

**J&R MUSIC**  
**WORLD**  
 db 33 PARK ROW, NEW YORK, N.Y. 10038  
**ORDER TOLL FREE (800) 221-8180**  
**CALL OR WRITE FOR FREE 96 PAGE CATALOG**

Circle 33 on Reader Service Card

## A/V FURNITURE

• A full line catalog including all the new products recently introduced in the field of audio/visual library furniture. Source: H. Wilson Company, 555 West Taft Drive, South Holland, Illinois 60473.

## DIGITAL STORAGE OSCILLOSCOPES

• A 6-page illustrated bulletin explores the advantages of digital signal storage and provides specifications on two portable dual trace digital storage oscilloscopes. Source: Bulletin 449-5, Marketing Services, Gould Inc., Instruments Division, 3631 Perkins Avenue, Cleveland, OH 44114.

## PROTECTIVE JACKETS

• A new series of specification sheets, and an up-to-date selection chart are available on jackets for use in bundling and protecting wire, cable and other objects from wear, abrasion, heat or cold, moisture, chemicals, and other environmental conditions. Source: Zip-pertubing Company, 13000 S. Broadway, Los Angeles, CA 90061.

## NOISE MEASURING

The complete noise measuring instrument family is contained in a pamphlet "Noise; What to Measure, How to Measure." Source: Advanced Acoustical Research Corp., 1211 Stewart Avenue, Bethpage, New York 11714.

## INTERFACE PATCHING

• Detailed descriptions are given on items for interface patching in a 40-page booklet. Items included are: patch panels, patch cords, cable assemblies, jacks, looping plugs, power dividers, and rf connectors. Source: Catalog T-11, Trompeter Electronics, Inc., 8936 Comanche Ave., Chatsworth, CA 91311.

## BBC SOUND EFFECTS

A catalogue describing 2,000 effects available in locked-grooves on 35 lp records is available. All of the effects have been cleared for public use. Source: BBC Sound Effects Library, Films for the Humanities, Inc., P.O. Box 2053, Princeton, N.J. 08540.

## HIGH VOLTAGE CAPACITORS

• General information on the physical dimensions, design and applications of high voltage-resistant ceramic capacitors is outlined in a six-page catalog. Specific data regarding maximum voltage values, dissipation factors, and temperature coefficients is spelled out on easy-to-read charts. Source: KD Components, 3016 Orange Avenue, Santa Ana, California 92707.

## ELECTRONIC KITS

• Describing the latest in electronic kits, a 96-page catalog touches on such kit-builder product categories as amateur radio, color television, high-fidelity components, test instruments, personal computer systems and many products for home improvement. Source: Heath Company, Dept. 570-160, Benton Harbour, Mich. 49022.

## ELECTRONIC TEST ACCESSORIES

• The 100-page 1979 electronic test accessory catalog includes many new products in such lines as molded patch cords, cable assemblies, test socket adaptors, 3/4" spaced molded accessories, molded test leads, banana plugs, phone tip jacks, plugs and connecting cords, test clips, probes and holders. Source: ITT Pomona Electronics, 1500 E. Ninth St., Pomona, CA 91766.

## TECHNICAL MAGAZINE

• Making its debut, "Horizons" is a magazine designed to increase the flow of information within the electronics community. The inaugural issue features articles on the developing digital audio and digital video technologies. "Horizons" will be published twice yearly. Source: Public Relations Department, Ampex Corporation, 401 Broadway, Redwood City, California 94063.

## WIRE/CABLE CATALOG

Complete wire and cable line is detailed in a new 96-page catalog. Featured, are conduit capacity charts and an in-depth technical section including a metric conversion chart and information on all the physical properties and characteristics of solid and stranded copper. Source: Columbia Electronic Cables, 11 Cove Street, New Bedford, MA 02744.

MARTIN DICKSTEIN

# db Sound With Images

## The Eyes Have It

• What is most often compared to a camera and is very different from it, has awesome capabilities that are taken for granted, functions automatically, and requires a great deal of experience to operate properly? It is the eye/brain combination that allows all animals (including humans) to perceive objects both near and far, in dim light and bright, large and

small, and in a vast range of shapes and colors.

### EYE VERSUS CAMERA

The eye does not work alone. It is much like a camera in that it has a lens and appears to be similar to a camera because the image falls on a retina, which can be considered something like film in a camera. But let's

look at the differences. The camera lens is adjusted for proper focus by moving the lens system toward or away from the film plane while in the eye it is the lens itself that changes shape to get a clear image of the object being observed. Another difference is in the method and amount of light intensity control. The lens of a camera is made with a shutter and aper-

**btx 30-track audio** The superb BTX 4500 SMPTE interlocking system allows the operation of any two multi-track recorders in tandem for 14, 22, 30 or 46-track capability. Any two recorders may be precisely locked regardless of make, format, speed or number of tracks.

The BTX Corporation | 438 Boston Post Road, Weston, Massachusetts 02193 • (617) 891-1239  
6255 Sunset Boulevard, Hollywood, California 90028 • (213) 462-1506

The BTX Corporation 

 THE BTX CORPORATION  
EDIT CODE SYNCHRONIZER MODEL 4500

db May 1979

## STANDARD TAPE MANUAL



This valuable data book is for the AUDIO recordist, engineer or designer. Offered at \$45.00 you may order direct from publisher.

## MAGNETIC REPRODUCER CALIBRATOR

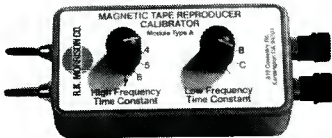







This is induction loop equipment of laboratory quality for primary standardization of tape recorders and tapes. Send for detailed information, prices and formats.

### R. K. MORRISON ILLUSTRATIVE MATERIALS

819 Coventry Road  
Kensington, CA 94707

Circle 28 on Reader Service Card

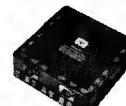
Direct boxes & Mic-splitters

<p><b>Passive Direct Box</b></p>  <p>SM-1A</p>	<p><b>Active Direct Box</b></p>  <p>SM-2</p>
<p><b>Deluxe Active Direct Box</b></p>  <p>SM-3</p>	<p><b>Single "Mic-splitters"</b></p>  <p>MS-1A</p>
<p><b>Quad "Mic-splitter"</b></p>  <p>MS-4</p>	<p><b>8 x 2 "Mic-splitter"</b></p>  <p>MS-8</p>
<p><b>12 x 2 "Mic-splitter"</b></p>  <p>MS-9</p>	<p><b>16 x 2 "Mic-splitter"</b></p>  <p>MS-10</p>

**Direct Boxes:** Both active and passive SM-1A for guitars SM-2 and SM-3 for keyboards and electronic instruments.

**"Mic-splitters":** Low impedance in and out. Will handle +6 dBm. Will pass phantom voltage. Isolated grounds.

**Thousands in use around the World!**  
We also manufacture audio transformers, snakes, audio modules

**SEND FOR YOUR FREE COPY OF OUR NEW CATALOG**  
P.O. Box 590,  
12931 Budlong Ave.,  
Gardena, CA 90247 U.S.A.  
(213) 770-3510, (800) 421-1828,  
TWX (910) 346-7023



"Quality Engineered Sound Products"

Circle 26 on Reader Service Card

ture which can regulate the amount of light hitting the film. The eye does not have a shutter in that sense; however the iris does help for a limited range of intensities, and the lid does help when the intensity becomes extreme. With normal illumination, the opening of the pupil can involuntarily go through a ratio change of 16:1 (something like the newer self-adjusting cameras). Moreover, the eye/brain combination can function in a brightness ratio of 100,000:1.

## RODS AND CONES

It is the operation of the retina's receptors, rods and cones, that allow this great difference in light intensity to be handled by this unique visual system. The rods operate in low light levels, while the cones function during high intensities; and together they perform like no film ever could. Under ideal viewing conditions, it has been suggested that the eye can detect as little as nine quanta of light; and yet the eye can function in the brightness of the noon sun. (Incidentally, it seems appropriate that we mention that "quanta of light" was introduced into our terminology by none less than Albert Einstein—whose 100th birthday would have fallen on this past March 14th if he had lived.)

Cones adjust automatically to different wavelengths of light, so that we can perceive color. While it takes different films to operate properly in different light, the eye adjusts, involuntarily, to color-balance shifts produced by different light sources.

And yet another difference exists. Because there are two eyes, and a brain in between, it is possible to perceive in stereo, or in 3-D; and it is the small spacing between the eyes (just about 3½-inches) that permits seeing shapes, distances, and spatial relationships.

## PERSISTANCE OF VISION

The eye has another characteristic which we take advantage of to provide the sense of motion with still images. It as found that when a changing image was passed before the eye at 1/10 of a second, the eye perceived a series of staccato movements, but when the same images were passed at 1/30 of a second, there appeared to be continuous motion. The rate of 1/16 of a second was found to be just about the slowest speed that could still fool the eye. We use 18 frames/sec. and 24 frames/sec. in motion pictures, the slower rate for silent movies, and the faster one for better sound. A study of this natural retentivity of the eye found that there

is a finite decay time just like with any photoexcitation of a solid, and that the eye functions like a photomultiplier. A photoexcitation mean life of 0.1 or 0.2 seconds followed by several seconds of gradual decay (of a still visible image after the cut-off of the excitation), with a gain in the visual system similar to a photomultiplier tube, results in image retentivity that allows motion pictures to act as they do. This also explains why, after we stare at a bright red square for a while, we see a green image on a black background when the red image is removed. However, there is one other factor that is necessary for the perception of continuous motion in films—it's called the critical flicker frequency. To make 24 frames/sec. look smoother, there is a 3-blade shutter which rotates to cut the image twice while it is on the screen and once during the black period between frames. Thus, the actual flicker frequency is 48 flashes/sec. which fuses the still images into continuous images. This is true at an image brightness of 20 foot-lamberts.

When projected images are brighter than 20 foot-lamberts, flicker becomes more apparent. This is also true when tv images are brighter than 40 foot-lamberts. The brightness levels above these maximums seem to make images flicker because they have exceeded the critical flicker frequencies. (Effects similar to motion pictures that take advantage of this characteristic of the eye are movie marquees with moving lights, cartoon signs where the figures are made to move by rapidly successive light changes, and even the flashing tail light.)

## STROBE EFFECTS

Stroboscopic effects also fool the eyes. Moving objects can be seen as moving stills by setting the correct timing on the lights. Wheels on cars in television commercials or movies, or airplane propellers, can be made to look like they are turning backwards or forward, or standing still, by regulating the speed of the flashing light and the speed of the camera. If the camera were slowed down, as compared with the speed of rotation, the projected image would appear to be rolling forward.

Another difference between the eye and the camera is that the eye, once open, is always "on," unlike a camera whose lens is closed off when a photograph is not being taken. It is more like a live tv camera or a still camera whose lens is kept open. In addition, the eye will always see objects along with the surround environment. Focusing the eye provides the brain with a

higher resolution of the object focused on, than the surround, but the object will still be seen in relation to the environment in which it is located. It is the distance between the eyes that allows the object, in focus, to stand out from the background; thereby putting things in perspective, in relation to distance from the eye.

Here several other factors come into play; two are learned relationships, the other is due to a characteristic of the eye system. First, the lens of the eye (and also the camera) puts a reversed and inverted image on the receiving surface. Consequently, it is by learning, that the human adjusts to this and puts the image right-side up. It is also by learning that the brain adjusts to images seen far away and puts them into proper size relationship. For instance, a child seeing a house in the distance believes the house to be smaller than the one that is closer. After all, it appears smaller, therefore, it is smaller. An adult sees the house farther away and mentally adjusts its size to see it, as perhaps, the same size as one that is closer. The involuntary operation judges distance between an object and its background on the basis of color. It has been shown that an object of a par-

ticular color will seem farther away from its background, if the surround color is cool. For example, a red or orange object will seem to stand out better against (or farther away from) a background of blue; and closer to the same background if it is yellow-orange or pink. It is the contrast, which the eye sees, that the brain tries to adjust for. The eye looks for a color balance between the object color and the background color. Tests have shown, that the color intensity of the object will determine the best balance, against the same background, as the color of the object intensifies (chroma shift). There can even be an apparent unbalance, when the intensity of the object color becomes too sharp against the background, and this will appear less comfortable to look at than the optimum balance combination. This is due to three perceptual attributes of light—brightness, hue and saturation.

#### HOW IT ALL RELATES TO A/V

All of this is preamble to a few simple facts about slides and projection. First, remember the color balance the eye looks for. When using multi-colors on a slide, choose combinations and intensities that are most

legible and most comfortable to look at.

Second, remember that only about 0.5 foot lamberts of ambient light should fall on the screen to avoid the necessity of having to use extremely bright light sources for the projectors. On the other hand, if the image is so bright that it appears washed out, a possible solution might be a lower wattage lamp, or a slower lens. If the contrast is too sharp, raising the ambient light in the room might help. (This is also true of tv images.) Check your image brightness and contrast for the light source and screen size being used. The source might have to be increased or the screen image made smaller, or the ambient light changed. Another consideration is light loss. Glass mounted slides lose more light compared to cardboard (or non-glass mounts).

#### ILLUSION AND MIRAGES?

The subjects of illusion and mirages were not mentioned but they might be subjects in a subsequent column. In the meantime, now that you know so much about the eye, see how creative and effective your slides and projection system can be, to get your message to the audience. ■

## THE STATE OF OUR ART

- New "series II" improved headsets
- 50 station capability with up to 8 channels using SB8 switchboard monitor
- External program feed with volume control
- Wide frequency response (200Hz to 12kHz) for exceptional intelligibility
- Designed for high noise environments
- Visual signalling uses bright amber lights
- Adjustable sidetone reduces feedback and background noise

- Mic on-off feature standard with headset and remote stations
- Single and two channel systems virtually immune to RF and SCR dimmer noise
- Remote stations available in portable, wall mount and rack mount versions including speakers for paging and monitoring
- Catalogue with complete specifications available upon request



**Clear-Com**  
intercom systems

759 Harrison Street  
San Francisco, CA 94107  
(415) 989-1130



# db New Products & Services

## OSCILLATOR

- Featuring a distortion rating of less than 0.005 per cent, the Model 4024A oscillator has a tuning range of 0.001 Hz to 100 kHz, selected with 3 digit rotary switches. The main sine wave output is controlled by a four digit attenuator, providing 1 millivolt resolution and a maximum output of 10 volts rms, with a frequency response better than 0.01 dB. The 4024A provides a quadrature sine wave output which leads the main output by 90 per cent,  $\pm 1$  degree, with an amplitude variable to 10 volts rms; and a square-wave and pulse output variable to 5V p-p, pulse width variable from 0.1  $\mu$ sec. to 100  $\mu$ sec.

Mfr: Krohn-Hite Corporation

Price: \$1600.00

Circle 60 on Reader Service Card



## EQUALIZER



- A 10-octave stereo graphic equalizer, the SE450 provides front panel selections for EQ defeat, tape monitoring, and tape recording. With a s/n ratio greater than 100 dB, and thd less than 0.01 per cent, the SE450 provides 15 dB boost/cut for each octave (with all controls set at maximum), 12 dB boost/cut (all controls flat). An 18 dB range of adjustment for the complete audio frequency band is available via the frequency spectrum level controls.

Mfr: Soundcraftsmen, Inc.

Price: \$249.00

Circle 63 on Reader Service Card

## HEAD-WORN MICROPHONE

- Offering dual monitoring capability, the SM14 head-worn microphone employs a low impedance, unidirectional dynamic microphone, and two integral earphone assemblies, each with its own transformer and phone plug. With stainless steel, aluminum, and high-impact thermoplastic construction, the SM14 is mounted on a cushioned headband and features an adjustment knob for boom pivoting and extension.

Mfr: Shure Brothers Inc.

Price: \$135.00

Circle 61 on Reader Service Card



## CASSETTE DUPLICATOR

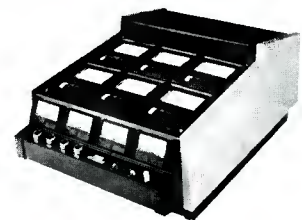

- With a cassette master and five slaves, the DP-4050-CCF in-cassette duplicator provides an 8:1 duplicating speed ratio. Cassette formats duplicated are:  $\frac{1}{4}$  or  $\frac{1}{2}$  track mono, or  $\frac{1}{4}$  track stereo, with all tracks recorded in one pass. The unit employs ferrite heads, and each plug-in slave unit is completely independent of the others, with its own servo-controlled capstan motor.

Mfr: Otari Corporation

Circle 64 on Reader Service Card

## MIXING CONSOLE

- Totally modular, for ease of servicing, the Model 1602a stereo mixing console features long-throw 100mm slide faders, three effects sends, a solo function on each channel, and a variable gain control on the microphone pre-amp over a 40 dB range. Each input has a pair of access jacks for patching external effects into a single channel. In terms of performance, the 1602a delivers a typical noise level of  $-128.5$  dBv, with a thd of less than 0.004 per cent at 1 kHz, and a slew rate with a minimum of 10 V/ $\mu$ sec. A three-spring Accutronics Type 9 reverb chamber is an internal option available with the 1602a.

Mfr: Tangent Systems, Inc.

Circle 62 on Reader Service Card

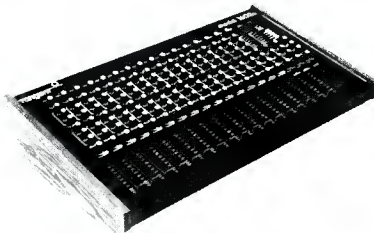



## REVERB SYSTEM

● Offering extended high and low frequency response, the 262 Stereo reverberation system utilizes the latest in spring design for professional studio applications. An equalizer section provides two channels of EQ, with a 15 dB boost/cut over a fully sweepable frequency selection—50 Hz to 1 kHz (low band) and 500 Hz to 10 kHz (high band). The unit features active balanced inputs and matched bi-FET preamps for ultra-low noise performance.

Mfr: Sound Workshop

Price: \$700.00

Circle 65 on Reader Service Card

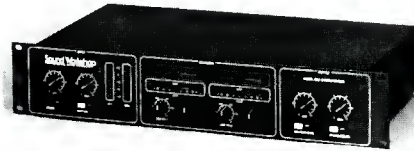

## SPEECH COMPRESSOR/EXPANDER

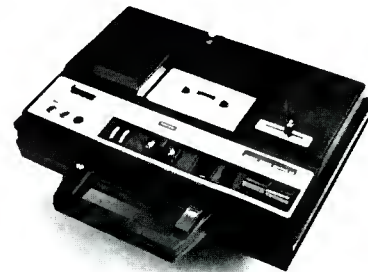

● Offering an increased bandwidth, the Model AV1 cassette speech compressor/expander plays back cassettes from 60 per cent to 2½ times normal with fully understandable pitch correction. Playback speed is regulated via a slide control. The Model AV1 features an, easy-to-insert, open well which is capable of accepting a micro-cassette adapter.

Mfr: The Variable Speech Control Co.

Price: \$439.00

Circle 69 on Reader Service Card

## EQUALIZER

● A four-band parametric equalizer module, the PEQ offers variable center frequencies from 20 Hz to 20 kHz, in overlapping five octave ranges. Each section of the module tunes over a 40 dB control range, with a variable bandwidth of 0.15 to 3 octaves. Offering low noise operation, the signal-to-noise ratio is 110 dB (with all sections in 20 dB boost), with a rated distortion measurement of 0.05 per cent thd @ 18 dBm output. Output capability is +30 dB (10k load); +24 dB (600 ohm load).

Mfr: Parasound Inc.

Circle 66 on Reader Service Card

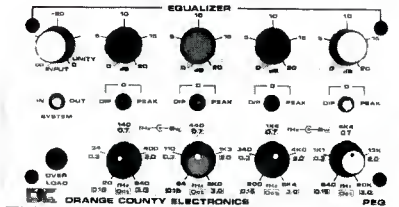

## DIGITAL DELAY

● With adjustable delay settings from 0 to 120 milliseconds, the Delta-T 91 audio digital delay system features muting of audio outputs during power up/down sequences; automatic bypass; and audio input/output transformers. With a dynamic range of 90 dB and a response from 20 Hz to 12 kHz ±1 dB, the Delta-T 91 checks-in with a typical total distortion and noise measurement of 0.06 per cent at 1 kHz.

Mfr: Lexicon, Inc.

Price: \$985.00

Circle 67 on Reader Service Card



## SOLVENT CLEANERS

● Ms-176 "Freon" TES and Ms-165 "Freon" TMS represent two new entries in the solvent cleaner line for the electronic industry. Ms-176 "Freon" TES is a mild solvent compatible with most plastics and elastomers; while Ms-165 "Freon" TMS is an effective agent in particulate soil removal. A special stabilizer, in Ms-165, gives improved stability with components made with reactive metals, like aluminum and zinc.

Mfr: Miller-Stephenson Chemical Co., Inc.

Circle 68 on Reader Service Card



## Audio Tape for professionals

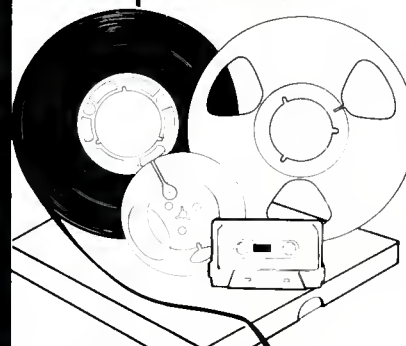

### REEL TO REEL TAPE

Ampex, 3M. All grades.  
On reels or hubs.

### CASSETTES, C-10—C-90,

With Agfa, Ampex, 3M tape.

### LEADER & SPLICING TAPE

### EMPTY REELS & BOXES

All widths, sizes.

— COMPETITIVE • FROM STOCK —

For your catalog, call or write: **Vito Cappi**  
312/297-0955



**Recording Supply Co.**  
Div. of Polyline Corp. 1233 Rand Road  
Des Plaines, IL 60016

Circle 16 on Reader Service Card

## MICROPHONE SHOCK MOUNT

- Designed to hold microphones with an approximate  $\frac{3}{4}$ -inch barrel diameter, the 313A shock mount clamp is manufactured from polycarbonate and metal. The microphone is suspended in the shock mount via four replaceable urethane bands. For those applications that require only temporary shock mounting, a hinged metal latch is provided; however, when used with the supplied set screw, the 313A becomes a semi-permanent shock mount for long term use.

*Mfr: Electro-Voice, Inc.*

*Price: Under \$23.00*

*Circle 70 on Reader Service Card*

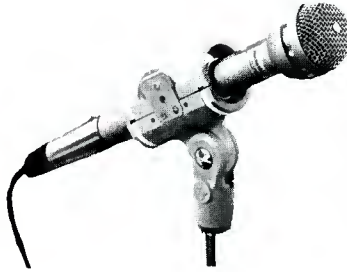

## TAPE MACHINE

- The SCM 381-8, a 1-inch 8-track tape recorder/reproducer, incorporates a tape transport based on a thick cast aluminum deck plate for optimum tape-path stability. The main control panel for all audio and transport functions is removable and can be used as a remote control (the module also contains a tape counter reading and search to zero facility). Spec-wise, the machine features a frequency response of  $+1/-2$  dB, 30 Hz to 20 kHz; s/n of 68 dB (unweighted 10 Hz to 100 kHz); and a wow and flutter reading of 0.03 per cent.

*Mfr: Soundcraft Magnetics Ltd.*

*Price: \$10,500.00*

*Circle 71 on Reader Service Card*



## LOUDSPEAKER

- Designed for professional applications in which a compact unit is required, the 4313 monitor loudspeaker system features a new 10-inch low frequency driver, as well as in-line mounting of all transducers. The 10-inch low frequency loudspeaker incorporates a 3-inch edgewound copper time-aligned voice coil and a 1.5-pound cast magnetic assembly. The 5-inch midrange loudspeaker, powered by a  $\frac{7}{8}$ -inch copper voice coil, is housed in an isolated sub-chamber to prevent interaction with the low frequency driver. Utilizing a 1-inch copper voice coil energized by a  $1\frac{1}{2}$ -pound magnet assembly, the 1-inch dome radiator provides high acoustic output. Level controls allow individual adjustment of midrange and high frequency output.

*Mfr: James B. Lansing Sound, Inc.*

*Circle 72 on Reader Service Card*



## LED METER



- Combining the functions of a peak power indicator and a peak line level monitor, the model 510 peak responding led display has a 45 dB dynamic range ( $-39$  dB to  $+6$  dB) with 1 dB resolution to either side of the 0 dB point. Sixteen led's per channel are used to display the peak value of complex waveforms to an accuracy of  $\pm 0.25$  dB. In the power mode, the 510 employs rear panel switches for setting the 0 dB reference to 25, 50 or 100 watts and to match speaker impedances of 4, 8 or 16 ohms. In the line level mode, each input is independently and continuously variable over a range from 50 millivolts to 5 volts for a 0 dB indication. In addition, a calibration feature is included to balance channels and return the instrument to a "0" VU ( $+4$  dBm) reference.

*Mfr: Audio Technology*

*Circle 73 on Reader Service Card*

## PITCH SHIFT MODULE

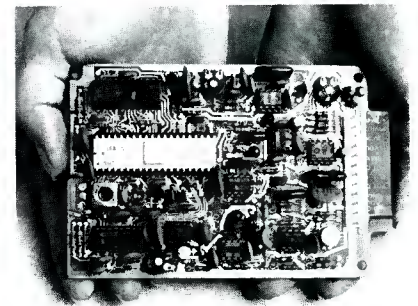

- The model 20, an LSI-based audio pitch shift module, produces off-speed audio intelligibility over a range from  $\frac{1}{2}$  to  $2\frac{1}{2}$  times normal sound speed. The unit offers a 100 to 5000 Hz  $+0/-3$  dB frequency response, a dynamic range greater than 56 dB, and 0.6 per cent total distortion and noise.

*Mfr: Lexicon, Inc.*

*Price: \$170.00*

*Circle 74 on Reader Service Card*

# LYREC. BEST QUALITY

The Lyrec 530 Multitrack Recorder is the most advanced studio recording machine ever designed studios demand the highest performance and most advanced features. Engineered and built by Lyrec, the Lyrec 530 is exclusively represented by Neve in North America. Lyrec is currently in successful and demanding use by many leading studios in the U.S. and Canada. Join our world of excellence. Please call or write.



Circle 47 on Reader Service Card

 **Neve**

Rupert Neve Incorporated Berkshire Industrial Park, Bethel, Connecticut 06801 Tel: (203) 744-6230 Telex: 969638

Rupert Neve Incorporated Suite 609, 6255 Sunset Blvd., Hollywood, California 90028 Tel: (213) 465-4822

Rupert Neve of Canada, Ltd. 2721 Rena Road, Malton, Ontario L4T 3K1, Canada Tel: (416) 677-6611 Telex: 983502

## CONSOLES

- Microtouch, a new line of audio consoles, features compact packaging and electro-mechanical switching. Designed for small to medium studios, newsrooms and remote vans, Microtouch's compact packaging provides 5 channels in a 21-inch width, and 8 channels in 26 inches. The unit is available with up to 21 inputs in 5 and 8 channel rotary or linear fader configurations, with dual mono and dual stereo outputs.

Mfr: Ampro Broadcasting

Price: \$1,495.00 to \$3,495.00

Circle 75 on Reader Service Card



## AUDIO CARTRIDGE SYSTEM

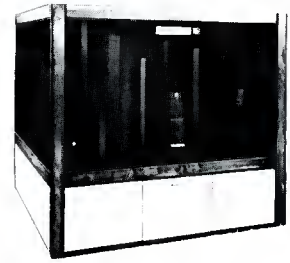

- Providing total, walk-away automation, the 1K audio library system receives, stores, moves, and plays 1024 cartridges, automatically. The 1K will accept four program lists, each 32 events long. Events can be added, deleted or re-sequenced. Back-to-back capability is provided through the use of up to 24 individual playbacks. Permitting crossfades and overlaps, the system feeds up to 4 stereo audio channels simultaneously (typically 2 for a.m. and 2 for f.m.). New cartridges are accepted through a reception compartment, where identifying numbers are read, cue tones are verified and storage spaces are assigned. Inactive cartridges, on command, will unload through a dump chute.

Mfr: International Tapetronics

Corporation

Circle 77 on Reader Service Card

## LOUDSPEAKER

- High performance and small size characterize the 934 loudspeaker. With the inclusion of the Mantaray constant directivity horn, the age-old high frequency dispersion problem is eliminated. Utilizing a radial phase plug in the high frequency compression driver, the high frequency response of the system is enhanced. The 934 employs a crossover network which features a built-in dual-band variable equalizer. Built to meet the portability requirements of a road tour, the cabinet measures 22" x 26" x 17".

Mfr: Altec Lansing

Circle 76 on Reader Service Card



## EQUALIZER/SPECTRUM ANALYZER



- This combination real-time spectrum analyzer and graphic equalizer features a 101 led display divided into ten frequency bands with nine vertical level led's and eleven green center reference led's activated in the real-time analyzer mode. For aid in room acoustic analysis, tape bias and speaker adjustment, a pink noise generator is built-in the unit. The equalizer portion of the unit features stereo-paired center-detent slide pots in ten octave bands from 32 Hz to 15.5 kHz, with a 15 dB cut/boost. An 18 dB-per-octave Tchebychev subsonic filter is also used. Frequency response checks in at 3 Hz to 100 kHz, with thd at less than 0.025 per cent.

Mfr: Audio Control Corporation

Price: \$549.00

Circle 78 on Reader Service Card

**Glass  
Is Class...  
It Lasts &  
Lasts!!!**

**Saki Hot Pressed Glass  
Bonded Ferrite Heads  
Outwear Metal Heads  
by 15 times.**

**We Make the Longest Wearing  
Heads in the World for All  
Models of Mincom Machines.**

Ferrite Heads Available for Most  
Professional Recorders.

Unconditional Warranty.



**Saki Magnetics**

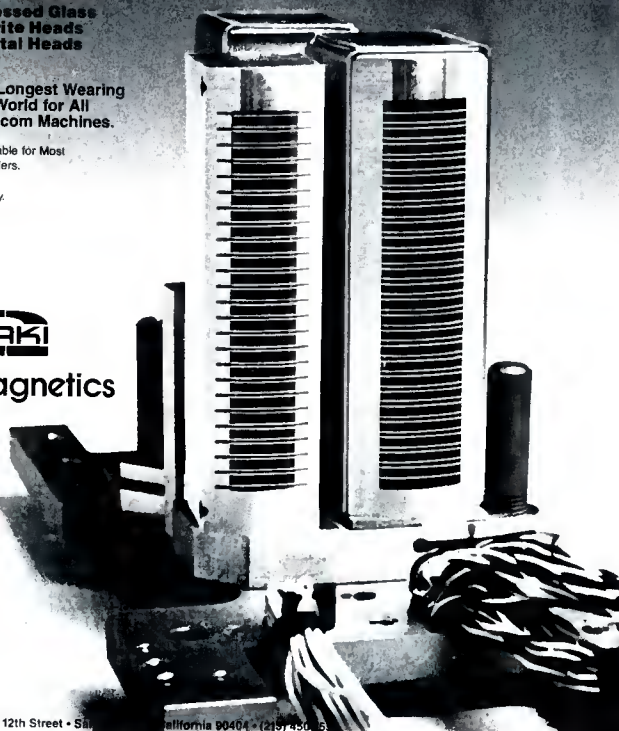

1649 12th Street • San Francisco, California 94041 • (415) 450-1234

Circle 40 on Reader Service Card

# SERVICE IS OUR MIDDLE NAME

“ He’s twenty, in the Army, married, and far from home. She’s 18, in the Navy, and stationed in a country whose language she can’t speak. They’re the kids next door or maybe your own son or daughter. You can’t be there to help with their personal problems or to give them a glimpse of back home. But the USO can, worldwide. Because thousands of USO volunteers care. The USO—service is its middle name. ”

**BOB HOPE**



“ The USO offers practical help to service people everywhere, things like helping cope with a foreign currency, finding off-base housing, help in using public transportation or learning a new language. The USO is civilians helping millions of military families with their problems. ”

**DINAH SHORE**



“ The USO works hard to make life a little easier, a little more pleasant, for millions of service people and their families and hospitalized veterans. The USO is on duty in more than 100 locations around the world, helping our friends and neighbors in the military cope with loneliness. ”

**HELEN REDDY**



“ You know, the USO isn’t all fun and games. Behind its friendly face and smile of welcome is help with serious problems, important information, a telephone to call home, an orientation tour of a new community, or a place to go to meet friends. Help the USO continue to provide recreation, education, and community service. Support the USO through your local USO campaign, OCFC, or the United Way. ”

**FLIP WILSON**



USO WORLD HEADQUARTERS 1146 19TH ST., N.W. WASH. D.C. 20036

---

**YOU'VE  
GOT  
IT WIRED  
WITH A  
MODEL 15.**

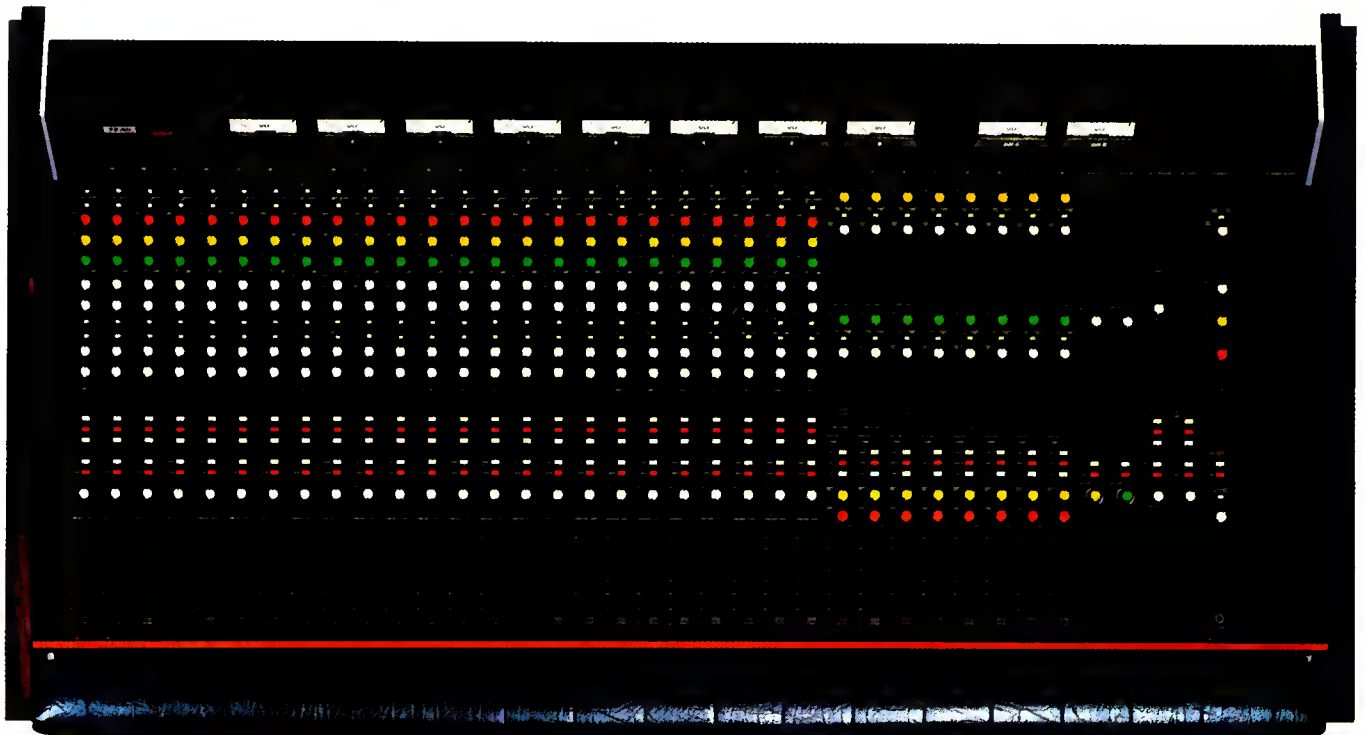

Buying a big mixer can be very deceiving. From the time of delivery to the moment your board is operational, you can run into quite a few additional costs and frustrating time delays.

But consider the Model 15. Rear panel patch points are already wired. Included in the cost. The meter bridge is already wired. Included in the cost. The separate power supply plugs right in. Also included in the cost. It's not unusual to get your board in the morning and do your first session that same night.

With the Model 15, you've got performance and flexibility wired, too.

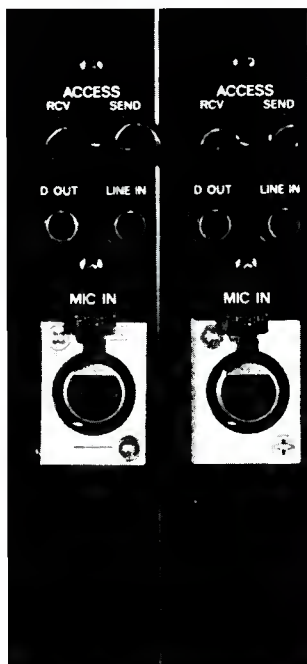

From the discrete microphone pre-amplifier, equivalent input noise is  $-126\text{dB}$  (weighted). With one input assigned to one output buss, signal-to-noise is  $76\text{dB}$  (weighted).

Formats are 16- or 24-channel input/8-buss output. Fully modular.

The Model 15 will drive any 16-track recorder and give you a vast array of mixing, monitoring and cueing capabilities. For example, the Cue mixing position can be fed by 48 sources simultaneously (all the inputs plus all 16 tape playback positions plus all eight echo receives).

Out of the crate, you'll have a lot more mixer in the Model 15 than you can get elsewhere for the money. Add your savings on installation (both parts and labor), and the Model 15 becomes even more cost-effective.

So think about the real, often hidden costs of buying a mixer. When you add it all up, we think you'll see the practical advantages of getting it wired with a Model 15.

The Model 15's functions, interior layout and complete specifications are described in our 10-page Product Information Bulletin. See your Tascam Series dealer or write us for a free copy.

Tascam Series, TEAC Corporation of America, 7733 Telegraph Road, Montebello, CA 90640.

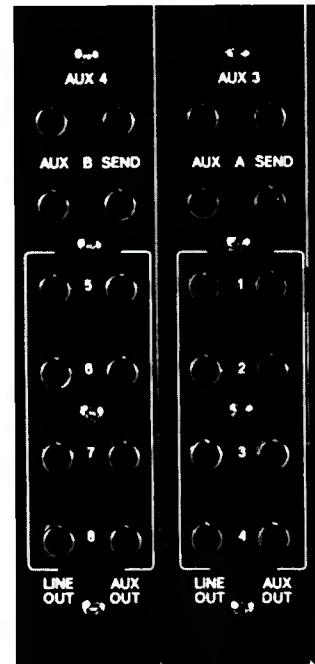

# TASCAM SERIES

TEAC Professional Products

# Editorial

**T**HE CONTROVERSY over the “sound” of broadcast audio shows no sign of easing up, as you’ll note by reading some of this month’s letters to the editor. And, one more reader takes us to task for our “air of condescension towards those in broadcast audio.”

Frankly, we’ve got mixed feelings about this. No recording engineer in his right mind should *ever* look condescendingly at broadcast audio. After all, your next mix-down probably doesn’t stand a chance of winding up on the charts unless the broadcasters get behind it.

However, we think that some broadcast people (and some record folks too) may have an air of condescension towards the public in general, and we cheerfully admit that we’ve taken a couple of shots at this crew from time to time.

Maybe we can explain ourselves (and at the same time, stay out of more hot water) by temporarily looking at broadcast *video*. (After all, no one in video would be reading this, would they?) Will most of you agree that some television programs are—to put it kindly—moronic? And those commercials!! Has anyone seen that dear old Aunt Bluebell—the one who prowls around in supermarkets, weighing paper towels? Or Mr. Whipple, who gets his jollies squeezing toilet paper? Or, what about that woman who gets into a screaming match at the local deli, about the joys of a certain brand of cold cuts?

Someone, way up at the top, is spending big bucks to grind out this sort of mindless drivel. Generally, the production and technology are first-rate—the producers and engineers have done the best they could, under the circumstances.

So, for those of us who look with dismay at such examples of broadcast video, are we really taking on an air of condescension towards our fellow engineers and producers? Hastily, we leap to our own defense and say, “Absolutely not!” Actually, we feel an air of sympathy towards those who must give their talents towards the preservation of such garbage. They’re in the same boat as the guy in the recording studio who is trying to produce (or engineer) a better-sounding tape, despite the odds, or the (audio)

broadcaster who is confronted with some of the day-to-day insanities that go along with the job. (More on this in a minute.)

There are obviously conflicting schools of thought about various aspects of pro’ audio. In the recording studio, it’s multi-mic/multi-track versus “pure” stereo. In the broadcast studio, it’s heavy signal processing versus “clean” audio. The trouble usually starts when someone gets so involved in his own thing that he forgets that—once in a while—there may be a better way. In the recording studio, *must* you put on ten microphones every time a drummer shows up? Or, if you are a “purist” would it kill you to try a third microphone—just once? For the broadcaster who is into heavy signal processing, do you *really* need reverb on the weather reports? Or, Mr. Clean, is your aesthetic soul soothed when the slow movement is *so* pure and clean that no one can hear it?

Obviously, for almost all occasions, there’s a sensible middle-of-the-road somewhere, and we think that most readers are aware of that fact (or opinion, if you like). In fact, this little magazine is more-or-less dedicated to exploring all aspects, and extremes, of the pro’ audio scene, so that our readers will have (we hope) a better shot at discovering what’s best for them—perhaps by taking a different direction now and then.

So, we certainly don’t want to look with condescension on *anyone* who explores these pages in the hopes of finding a way to do a better job. Sometimes, the reader finds himself in a circumstance where he is forced to do something he feels is technically wrong. Sometimes, it’s merely because “we’ve *always* done it that way.” Perhaps the reader is in a position to change things—perhaps not. (After all, it’s nice to keep those paychecks coming in.) On the other hand, another reader may disagree about what’s right and wrong—note the varying shades of opinion of our letter writers. Now and then, we throw a little fuel on the fire, just to get people thinking. That’s how this whole broadcast audio thing got started, isn’t it? But, we hope we never look with condescension on any of our readers, although we certainly do disagree with at least some of them, some



of the time. And it's just as obvious that some of our readers disagree with others—also, some (most?) of the time. But that's what pro' audio (and life, too) is all about. If we all agreed on what makes up the ultimate sound, there'd be nothing left to write about. And then we'd have to go out and *work* for a living (speak for yourself—Publ.). Let's hope we can continue to argue about the ways and means of better broadcasting and recording for a long time to come.

### DOWN WITH QUALITY?

And that brings us back to those day-to-day insanities which confront the broadcaster, and the rest of us as well. As we've noted before, the recording and broadcasting industries are closely linked. Fortunately (up until now, that is), the recording industry has not had any direct head-on collisions with that guardian of the public interest known as the Federal Communications Commission.

Like so many other bureaucracies, the FCC helps to "protect" the general public by bombarding the broadcaster with endless rules, regulations, and, above all else, *paperwork!* By the time the broadcaster has complied with every paragraph, conformed to every regulation and filled out the necessary paperwork, he is just too damn tired to plot the overthrow of the American way of life, become a commie menace, or otherwise mess up civilization as we now know it.

For a moment, consider the matter of quadrasonic broadcasting. The learned Commissioners have been doing nothing (and doing it very well, we might add) for some ten years now. But recently, a little ray of sunshine was seen, when the Commission published an FNOI (that's a Further Notice of Inquiry) on the subject. Despite the fact that poor old quad has had a very rough time of it, the Notice acknowledges that, "With few exceptions, comments (from broadcasters, manufacturers and the general public) were in support of quadrasonic broadcasting." In fact, some 98.5 per cent of the comments received by the Commission have been in favor of quad, but that's another story. Of course, every silver lining has its cloud, and, as the paperwork puts it, "This Further Notice of Inquiry is being issued to obtain additional information to assist the FCC as it gives further consideration to FM quadrasonic broadcasting." The Notice inquires, "What impact would the adoption of quadrasonic broadcasting standards have on the possibility of reducing the channel spacing in the FM broadcast band to 150 kHz or 100 kHz?" The rationale is that the more-crowded spacing would allow more stations to go

on the air, unless perhaps some sort of quad standard forced the FCC to leave the channel spacing right where it is—at 200 kHz.

### BACK TO MONO?

Of course, quad fans will object immediately, and we hope that means you too. But let's put aside our thoughts about quad broadcasting for the moment, and look at some of the other, more ominous, implications of a reduced channel spacing. These are the ones that vitally affect every reader of **db**, and just about everyone else as well. So, read on.

For one thing, just about every f.m. tuner or receiver in the country would be rendered obsolete. The overall quality of present-day f.m. reception would also deteriorate. In fact, in a foot-note, the Commission casually tosses off the following little bombshell; "We recognize that 100 kHz channel spacing would probably preclude presently-permitted operation, *such as stereo and SCA.*" (Our italics, and yours too, we hope!)

### APRIL FOOL?

No, this is not our traditional April Fool column, running one month late. The Commission is actually *asking* for comments from interested parties on this matter. So, if you think that what the recording industry really needs is a return to the good old days of mono, now's your chance. Let the Commission know how pleased it would make the record industry to get rid of stereo and SCA broadcasting. In fact, perhaps they could be persuaded to reduce the channel spacing even more, and then we could return to the purity and simplicity of the wax cylinder.

On the other hand, perhaps you think—as we do—that the Commissioners are a little out-of-touch with the public interest, or with reality in general. In any case, you can let them know what you think in several ways. Anyone may express interest in the proceedings by submitting one copy of their comments, without regard to form, *provided* that the Docket Number, 21310, is specified in the heading of your comments. If you're *really* concerned, submit an original and five copies of all comments. If you desire that each Commissioner receive a personal copy of your comments, an additional 6 copies are required. Or, you can do nothing, and let the Commission draw its own conclusions about the public interest.

Your comments should be addressed to;  
William J. Tricarico, Secretary  
Federal Communications Commission  
Docket 21310  
Washington, D.C. 20554

J.M.W.

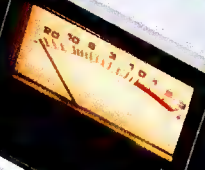

AMPEX  
456  
AMPEX

AMPEX

ON  
POWER  
OFF  
LOCKOUT  
30-  
18-  
7.5-  
3.75-

AMPEX

1	2	3	4	5	6	7	8	9	0	REWIND	STOP	PLAY
1	2	3	4	5	6	7	8	9	0	REWIND	STOP	PLAY

7.7477

AMPEX

# THE PERFORMER

## ATR-100

Sound is a perishable commodity, and Ampex has developed a way to keep it fresh. The way is an astounding tape recorder called the ATR-100. There isn't another machine like it anywhere in the world.

Unmatched for both audio performance and tape handling, the ATR-100 is truly transparent. You'll play back the original sounds with nothing added or subtracted by this recorder. And along with the most gentle tape handling you've ever seen on an audio machine, you'll get real time savings with the 500 ips shuttle and the Spool Mode that winds tape perfectly for storage.

Use the ATR-100 as a four, two or single-channel machine. The tape guides and head assembly change quickly when you go from mastering to mixdown, or to a dubbing assignment. And while this machine is doing the work, you'll keep your eyes on the studio action because the remote control unit contains fingertip switching and LED status indicators.

Ampex designed the ATR-100 as a simple solution to audio excellence. All signal electronics are in the overhead modular bay, and all mechanical parts are mounted on the transport deck with plenty of elbow room. (Rather than make claims about reliability, we'd prefer that you ask studios now using ATR-100s.)

No matter how you wish to measure audio tape recorder performance, the ATR-100 by Ampex comes out ahead. This is the performer that defines excellence in sound recording.

# AMPEX MAKES IT EXCITING.

Ampex Corporation, 401 Broadway, Redwood City, California 94063 415/367-2011

# Shared Access Memory— A New Concept For Digital Signal Processing In Audio Applications

*A non-technical look at some of the problems inherent in digital processing hardware and the solutions presented by the Shared Access Memory System.*

**A**S EVERYONE INVOLVED in professional audio circles is well aware, "digital" has become the ever-present topic of discussion. Tape machine manufacturers have alerted us all that digital technology is definitely on the way: even as this article is being written, several new digital machines are being introduced. Console manufacturers are also considering "digital" in their long range plans as well.

## WHY GO DIGITAL?

Once a digitized audio signal can be stored on tape (with hardware that is a bit more manageable than the presently-available prototype systems), the theory states that one should convert the analog audio signal to digital form in the console; being that it is the first link in the signal processing chain. Once converted (the theory continues), signal processing could take place on the digitized signal, utilizing digital processing techniques, adding little of the noise and distortion inherent in analog processing techniques.

---

*Michael Tapes is president of Sound Workshop Professional Audio Products, Inc. As marketing director for the Shared Access Memory System, Michael has been a key consultant in its development.*

However, until the validity of these concepts is conclusively proven, and the reality of affordable and practical digital hardware smacks us in the face, we are forced to manipulate most of our musical waveforms while they are still in an analog state. Yet even today, almost all studios already have at least one "black box" that can convert analog musical signals to a digital format, perform magic upon the binary bits, convert the whole mess back to analog form, and present its owner with three groupies and a gold record before the damn thing is even paid for!

Seriously, although the all-digital machine-plus-console may well be upon all of us within the next decade, for the moment the reality of this technology comes mostly in the form of digital signal processors. And, it is becoming apparent, even when touring state-of-the-art studios, that there is no continuity in the design of these digital signal processors. Even the top studios will have racks of digital processing gear, in which much hardware is duplicated, and tremendous amounts of random access memory (RAM) are going to waste. To achieve many special effects, units must be patched together. Long delays are only possible by putting several units in series, or by resorting to the hassles of tape delay. (A few broadcast delay systems now offer from 6-8 seconds of delay, but they are expensive single channel units which make them an unlikely candidate for studio use.) Beyond all of this, the audio quality of even the finest digital processors is not up to most other studio standards.

## AUDIO MACHINERY

In response to this dilemma, the Audio Machinery Corporation has developed a digital processing system which it hopes will satisfy some of the needs for performance and flexibility in digital signal processing. It introduces the concept of *shared access* memory, whereby random access memory is *not* committed to a given processing device; the RAM can be partitioned, or shared, by several independent processing channels.

The purpose of this article is to introduce this Shared Access Memory System, by taking an overview of some of the design criteria and compromises involved in digital signal processors.

## DIGITAL DELAY SYSTEMS

The most common digital signal processor is, of course, the digital delay system. However, other signal processors, such as Harmonizers (TM Eventide Clockworks, Inc.) are commonplace in the studio, as well as in sophisticated sound reinforcement systems. Also, several digital reverberation systems are being introduced in an effort to replace the plate-type reverb as the accepted standard for artificial reverberation.

For simplicity, I will direct this discussion of digital signal processing to delay systems specifically, although most of the concepts can be applied to digital reverberation and pitch modification as well. No attempt is made to be extremely technical in nature. Those wishing a detailed technical discussion of digital technology, as it applies to audio applications, should consult the articles listed at the end of this one.

Very simply, a digital delay system works like this:

1. The analog input signal is filtered, sampled and converted to digital format.
2. This now-digitized signal is stored or "written" into memory as binary bits.

3. Some time later (dependant on the desired delay) the signal is "read" or extracted from memory.
4. The signal is converted back to analog form.

The most common studio-oriented digital delay systems employ random access memory as their storage medium. Physically, the RAM is a collection of "chips" or integrated circuits. These are capable of storing binary information (ones and zeros). Strange as it seems, the RAM in your digital delay may be identical to the RAM in your bank's computer system. The RAM doesn't know (or care) whether it is storing the Bee Gee's latest harmony or Rod Stewart's social security number; to the RAM, life is just a bowl of ones and zeroes.

Random access memory has no effect on the quality of the audio signal which is created from the stored binary bits. That is to say, there is no such thing as good RAM or bad RAM. There are no "specs," involved except, How many bits of information can be stored? The more bits, the greater the delay capacity (assuming the resolution remains the same). What determines the quality of the audio and how much RAM is needed per-unit of time, are the sampling rate and the resolution of the analog-to-digital (A/D) converter.

The sampling rate must be high enough so that the bandwidth need not be restricted, and the A/D conversion must resolve the signal sufficiently, so that upon D/A conversion, nothing significant has been lost, and no objectionable noise or distortion has been added.

But in order to offer a cost-effective device that will steal sales from the competition, and still win the hearts of studio owners, a series of design decisions (or compromises) must be made.

## A/D CONVERSION

Conversion is not always a religious experience. Compromises in the A/D converter (and the reciprocal D/A) will limit the overall level of performance that a delay device can achieve.

It is generally accepted that, in order to digitize high-quality musical sources properly, 16-bit resolution is required. Most digital delays presently available, however, do not resolve to 16 bits and some well-known devices resolve to only 10 bits.

So the "Brand-X Super Delay 1000" only resolves to 12 or 13 bits . . . and it says here it should resolve to 16 bits! How can they sell that thing to anyone???

## ANALOG PROCESSING

To make up for inadequate A/D conversion, most delay units use some form of analog signal processing to make the signal easier to convert and/or to mask the resultant noise. FIGURE 1 is a block diagram of a basic digital delay system which employs such analog signal processing techniques. The two most common techniques are companding and pre/de-emphasis. When used in combination, companding and pre/de-emphasis form a basic noise reduction system. While the noise produced by the delay system will definitely be reduced, the loss of accuracy caused by the inadequate resolution of the A/D converter cannot be restored. The noise reduction system also has undesirable audible side effects such as noise modulation, "breathing," softening of transients, and an overall loss of transparency and "sparkle."

Companding, when used alone, does not offer as much overall noise reduction. Also, the audible effects of noise

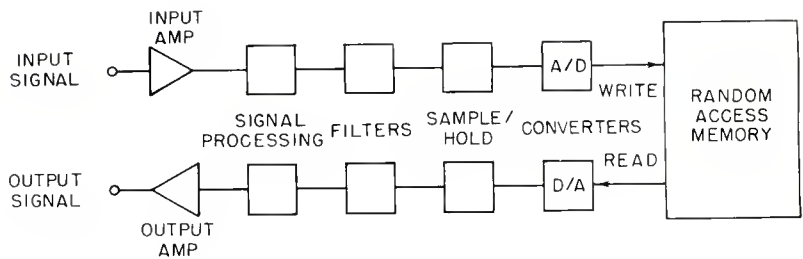

Figure 1. Basic delay system employing analog signal processing techniques before and after conversion.

modulation become much more severe. (Ironically, noise modulation tends to be more distracting than if the noise were constantly present.)

High frequency pre/de-emphasis when used alone presents none of the audible side effects of companding-type systems. This simple noise reduction technique depends on the fact that the musical spectrum does not contain as much high frequency energy as mid or low. The high frequencies can be boosted (bringing them up to the level of the mid and low frequencies) before the A/D conversion and lowered (by the same amount) after D/A conversion, lowering the noise produced as well.

The problem that rears its ugly head comes about because the premise regarding high frequency energy content is rarely true in today's studio and sound reinforcement processing applications. Due to close-miking techniques, electric instruments, and electronically-synthesized music, the high frequency energy content encountered in today's music is much greater than before.

If we operate our delay system so that the input level is just below clipping, we achieve an optimum signal-to-noise ratio. If we now pre-emphasize the high frequencies, they will exceed the level of the low and mid frequencies and therefore clip the device, unless the overall input level is reduced. This eliminates the complementary noise reduction effect that the pre/de-emphasis was to have accomplished. The more dynamic and wide range the source material, the more of a problem this becomes. The overall effect is that the usable signal-to-noise ratio of the device is about 15 dB lower than the spec sheet would tend to suggest. It will lower the static noise and it does allow the manufacturer to print that better noise spec on the product blurb sheet. Certain manufacturers demonstrate the drawbacks of pre/de-emphasis by including a "slew" meter on the front panel to show the reduced headroom. Some also indicate that the stated bandwidth is accurate only when measured or operated much below normal maximum operating level (usually about 15 dB).

So we see that less-than-adequate digital resolution can be "covered up" through the use of analog signal processing techniques. In fact, though, the noise is reduced but the distortion remains . . . and all at the expense of audible side effects and/or loss of headroom.

### IT'S ABOUT TIME

Most delay designs accept sonic compromise in favor of more product-per-dollar. In the delay business the "product" is time. After all, a delay device is capable of delaying audio by only a certain amount and that's it. Once the time capability is reached, there ain't no more.

Let's examine the parameters that affect the maximum delay time capability.

1. The Sampling Frequency is the amount of times per second that the input signal is looked at or "sampled."

2. For each sample, the A/D converter determines the instantaneous value of the input signal and converts it to a binary number or "word." The length of the word is dependent on the design and resolution of the converter.
3. The RAM compliment determines the number of bits available for storage.
4. The maximum delay time can be calculated as follows:  
 $T=R/SxL$ ; where  
 $T$ =Time in seconds  
 $R$ =Amount of RAM, in bits  
 $S$ =Sampling rate, in kHz  
 $L$ =Length of Word, in bits

For example, let's assume that the "Brand X Super Delay 1000" has a 160,000 bit RAM, a sampling rate of 41 kHz, and a 10-bit converter. This produces a maximum delay time of 390 milliseconds. Assuming that there is no provision for adding additional RAM, the only means of increasing the delay time is by lowering the sampling rate (which necessitates lowering the bandwidth as well).

If the same set of circumstances existed but the Brand X Company opted for a 13-bit converter, only 300 milliseconds would be available. To offer the original 390 ms, an additional 47,870 bits of RAM would be needed.

So the cost/time/performance compromise becomes a marketing decision:

1. The higher the performance capability, the more complex and sophisticated the converter, which requires more RAM for the same time capability.
2. Once the performance criteria are set, more time means more RAM.
3. Since most delay requirements are "short," providing enough RAM for long (>400 ms) delays becomes an impracticable luxury . . . Unless the RAM can be shared or distributed amongst several discrete channels or processing devices!!!

### THE SHARED ACCESS MEMORY SYSTEM

The Shared Access Memory System is a digital processing system designed with the intent of creating new performance standards in a cost-efficient manner.

In this world you don't get something for nothing and producing the "best" is usually not an inexpensive endeavor. An A/D converter with 16-bit resolution costs much more than lesser converters, and that additional RAM space needed for the higher resolution is still calculated from the same formula, already presented. In the development of the Shared Access Memory System, the design parameters were as follows:

1. Exceed present performance standards.
2. Use direct A/D and D/A conversion (with no analog signal processing).

3. Allow for extremely-long delay settings at full bandwidth.
4. Provide for cost-effective use of RAM by allowing several discrete modules (independent processing channels) to "share" the available memory.
5. Provide for additional output channels to be added to any processing module.
6. Delay settings must be quickly adjustable in 1 ms steps, with a sweepable capability.
7. Exact time readout must be available, even when delay setting is externally controlled.
8. Exceed the performance of present pitch shifters.
9. Provide true reverberation by room simulation, rather than multi-tapped delays.
10. Provide for future interface with automation systems and computer systems.

Basically the concept of Shared Access Memory is the collaboration of two overall design considerations. The first is to simply not skimp on the digitizing process. The second is to partition the RAM space (under computer control) so that the system can be tailored to the specific processing needs of the engineer, allowing for each session's requirements to be met.

For example, assuming that a given shared access system has a compliment of 800 milliseconds of RAM, a Reverberation module, a Pitch/Delay module, and two Delay modules, here are four possible set-ups:

	CHANNEL	FUNCTION	RAM (required)
1.	A	200 ms and 300 ms delays	300 ms
	B	50 ms delay	50 ms
	C	Pitch Modification	50 ms
	D	Reverberation	400 ms
2.	A	24 ms, 28 ms, 32 ms, 36 ms delays	36 ms
	B	Reverberation	400 ms
	C	100 ms delay with pitch modification	100 ms
	D	(264 ms available at 16 kHz bandwidth)	264 ms
3.	A	700 ms delay	700 ms
	B	50 ms delay	50 ms
	C	75 ms delay at reduced (12 kHz) bandwidth	50 ms
4.	A	2.4 seconds at 4 kHz bandwidth	800 ms

## A/D CONVERSION

Shared Access uses a proprietary floating-point converter, which yields 16-bit resolution while writing a 15-bit word. The sampling rate is 41.2 kHz, and is adjustable downward in 3 per cent steps (under computer control) to allow for extending the available time in cases where the RAM space cannot meet the time "requested." The computer takes care of the "housekeeping" such as adjusting the filter and updating the displays.

The random access memory is housed in the rear of the rack-mount mainframe, which also houses the processors and related circuitry. Up to 6,000 milliseconds (6 seconds) of RAM can be accommodated. The basic mainframe has 400 ms, and up to 14 additional 400 ms RAM cards may be added.

## PLUG-IN MODULES

The front of the mainframe accepts up to eight processing modules, each being able to access the common mem-



The Shared Access Memory System shown with 8 pitch/delay modules installed in the mainframe.

ory through its front panel controls. Each module displays the amount of memory space allotted to it, while the uncommitted memory space is displayed on a master panel along with the present system bandwidth.

As the time requests are made, the RAM space is assigned to each module automatically as it is needed. No additional controls need be dealt with. Setting a 100 ms delay on Module 2 automatically tells the computer to commit enough RAM to provide that delay. The module readout confirms that the memory space has been allotted. If other modules have been assigned memory space such that this new request cannot be met, the computer assigns what it can (let's assume it has 50 of the needed 100 ms available). The readout flashes the committed time (50ms), informing the engineer that the full time request has not been met. Using controls on the master panel the operator can have the computer lower the sampling rate (and therefore, the frequency response) of the mainframe so that the time needed to fill the request can be provided. Alternately, the sampling rate can be adjusted manually to create even more time. The mainframe bandwidth (which relates directly to the sampling rate) is always displayed on the master panel. Each module can be set to operate at the full sampling rate (providing a 16 kHz audio bandwidth) or at the mainframe's current sampling rate (reduced bandwidth). This allows for total utilization of the memory, by permitting critical signals to have full performance parameters, while allowing less-demanding signals the luxury of time that wouldn't have otherwise been available, as was demonstrated in the above examples.

By the time you are reading this (or shortly thereafter) the Mainframe, Delay module, and Pitch/Delay module will be available for delivery. In the final stages of design are the Output module, and the Reverberation module. Planned for early next year are modules that offer lesser performance and flexibility at reduced cost, thereby even further increasing the flexibility and cost-effectiveness of the system.

A very generalized module structure can be seen in the simplified block diagram shown in FIGURE 2 (I stress that this is a simplified diagram!) The following is a brief description of the currently-available modules:

## DELAY MODULE

The delay module provides a single input and two outputs. Delay times are selectable in 1-millisecond steps, with

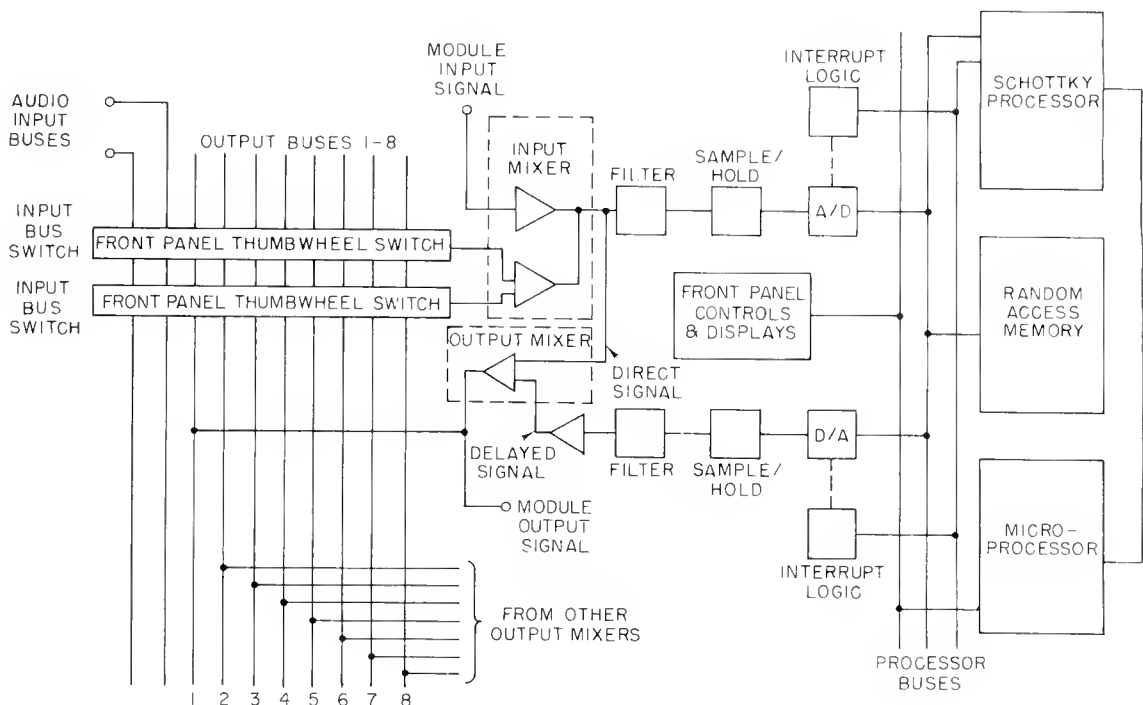

Figure 2. Simplified Block diagram of Shared Access Memory System, showing interface of one module with system.

a  $\pm 20$  per cent vernier also provided. A three-input mixer allows selecting input signals from the module's own input or from two input buses. By selecting its own output (via either input bus switch), regeneration effects can be created. An output mixer allows any blend of direct and delayed signals. Voltage control can be selected from an external source or from the mainframe's Voltage Control Bus. Input level is indicated on a 5-led column.

### PITCH/DELAY MODULE

The pitch/delay module is similar to the delay module except it is 1-in/1-out, with a pitch-modification section replacing the controls of the second delay output. This module contains its own oscillator for internal voltage control of pitch and/or delay. This oscillator may also feed other modules directly or through the Voltage Control Bus. Both the pitch/delay and the delay modules may be set to "tap" the memory of the adjacent module so that pitch or delay processing can be added to that module's signal without additional A/D conversion.

### OUTPUT MODULE

The output module adds three additional delay outputs to any other module without additional conversion.

### REVERBERATION MODULE

The reverberation module occupies two positions in the mainframe and requires a maximum of only 400 ms of RAM space. Rather than provide rigid programs, the reverberation module allows for the adjustment of critical room parameters including width, length, reflection ratio, absorption characteristics by frequency, and source placement by the engineer.

### COMPUTER INTERFACE MODULE

The computer interface module will allow for integrating shared access into automation or other computer-based

systems. This eventual realization of the module will be based on industry need and standardization.

### CONCLUSION

The Shared Access Memory System is literally the state-of-the-art in digital signal processors. Being that it is a new product, however, only time will prove its ultimate acceptance by the engineering community. In this article I have attempted to show the deficiencies in existing systems. This is not to condemn existing digital processors.

As discussed, design compromises are brought about by marketing decisions, and indeed if cost were no object, the Shared Access Memory System might be even more sophisticated than it is.

There are now digital delays on the market that can be purchased for well under \$1,000. There are also units of much greater cost. The Shared Access Memory System is not inexpensive and it will not be within everyone's reach. However, for those who need the highest level of sonic performance available, the Shared Access Memory System provides a most-sophisticated, yet extremely cost-effective, system.

### RECOMMENDED READING

For those desiring technical information regarding the application of digital techniques to high quality audio may I recommend the following articles. Mr. Silver's article is a general look into the digital technology, while Mr. Blesser's article is a complete in-depth study.

Digital Modulation For High-Quality Audio—Sidney L. Silver

db Magazine: June, 1978

Digitization Of Audio: A Comprehensive Examination Of Theory, Implementation, And Current Practice—Barry A. Blesser

Journal of the Audio Engineering Society; October, 1978



# 1 in. 8-TRACK WITH A PLUS

**MX-7800:** Full function capability with no compromise in reliability. Performance second to none. • Full-servo constant-tension tape drive • Dynamic braking • 30/15 ips operation • FET switching • \$8895 suggested retail USA.



**THE PLUS:** A unique multi-function remote, the CR-706, lets you do it all from your console • Overdubbing with automatic monitor switching • Silent punches • Fine and coarse speed variation • \$995 suggested retail USA • CT-501 real time counter with return to zero • \$495 suggested retail USA.

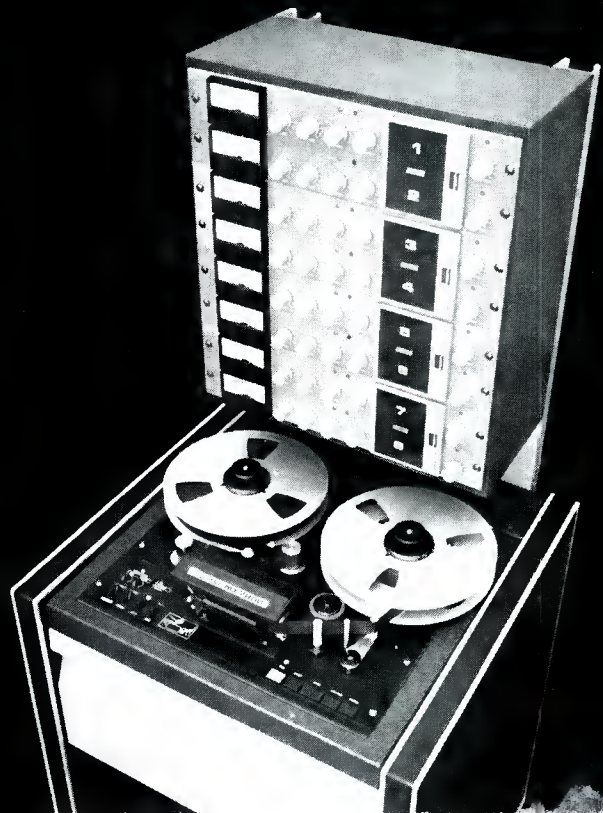

**EXPERTISE NEAR YOU:** We are proud to have these select dealers franchised to sell, maintain, and service the only 1-inch 8-track with a plus.

## WEST

**Accurate Sound**  
Call Greg 415/365-2843  
Redwood City, CA  
**ACI/Dave Kelsey Sound**  
Call Fred 213/851-7172  
Hollywood, CA  
**EAR Sound Consultants**  
Call Ed 602/968-8675  
Tempe, AZ  
**Express Sound**  
Call James 714/645-8501  
Costa Mesa, CA  
**Sound Genesis**  
Call Dave 415/285-8900  
San Francisco, CA  
**Westlake Audio**  
Call Bruce 213/655-0303  
Los Angeles, CA

## CENTRAL

**ASI/Abadon Sun**  
Call Galen 512/824-8781  
San Antonio, TX  
**Audio Distributors**  
Call David 616/452-1596  
Grand Rapids, MI  
**AVC Systems**  
Call John 612/729-8305  
Minneapolis, MN  
**Ford Audio & Acoustics**  
Call Jim 405/525-3343  
Oklahoma City, OK  
**Paul Westbrook Audio**  
Call Paul 512/578-4401  
Victoria, TX  
**Sonics Associates**  
Call Doug 205/942-9631  
Birmingham, AL 35209  
**Hy James Enterprises**  
Call Henry 313/994-0934  
Ann Arbor, MI

## Allied Broadcast

Call Jim 317/962-8596  
Richmond, IN  
**Milam Audio**  
Call Jerry 309/346-3161  
Pekin, IL  
**Houston Cinema & Sound**  
Call John 713/933-7180  
Houston, TX  
**Gill Custom House**  
Call Al 312/598-2400  
Palos Hills, IL  
**Ludwig Sound**  
Call Charles 713/449-8388  
Houston, TX  
**EAST**  
**Alpha Audio**  
Call Nick 804/358-3852  
Richmond, VA  
**Audio By Zimet**  
Call Sid 516/621-0138  
Roslyn, NY

## Audio Unltd.

Call Ed 919/274-4682  
Greensboro, NC  
**Blue Diamond**  
Call Joe 412/746-2540  
Cannonsburg, PA  
**Cathedral Sound**  
Call Don 518/465-5689  
Rensselaer, NY  
**Dimension Five**  
Call Charles 215/589-5312  
Womelsdorf, PA  
**Harvey Sound**  
Call Gene 212/575-5000  
New York, NY  
**Lebow Labs**  
Call Peter 617/782-0600  
Allston, MA  
**Martin Audio**  
Call Courtney 212/541-5900  
New York, NY  
**P.A. Palace**  
Call Ellis 404/636-3044  
Atlanta, GA

## Professional Audio Video

Call Paul 201/334-5310  
Paterson, NJ  
**Stereo Sonics Labs**  
Call Alan 305/831-2575  
Altamonte Springs, FL  
**VSM Leasing**  
Call Vince 716/759-2600  
Clarence, NY 14031  
**Harris Company**  
Call Michael 305/944-4448  
No. Miami, FL  
**Sounds Fine**  
Call Dave 703/951-3489  
Blackburg, VA  
**RCI Sound Consultants**  
Call Tom 301/587-1800  
Silver Spring, MD  
**Recording Services (of W.N.C.)**  
Call Ted 704/648-6012  
Canton, NC

# OTARI

For information on other Otari products and dealers, call Ruth Pruetz at 415/593-1648.  
Otari Corporation, 981 Industrial Road, San Carlos, CA 94070 TWX 910-376-4890  
In Canada: BSR (Canada, Ltd.), P.O. 7003 Sta. B, Rexdale, Ontario M9V 4B3 416/675-2425

Circle 18 on Reader Service Card

# Audio Tests and Measurements—Part II

*Two approaches to spectrum analysis—each has its own inherent advantages.*

**A** CURRENTLY-POPULAR TECHNIQUE in measuring frequency response doesn't use a sweep at all. The measuring device is a real-time spectrum analyzer, and the generated signal is a wide-band signal, such as pink noise. The real-time spectrum analyzer incorporates a series of band-pass filters, (typically 27 to 30), each with a constant-percentage bandwidth (typically one-third octave) and an amplitude-indicating device, such as a line on a CRT or an led bar graph. By arranging the center frequencies of the band-pass filters so that they are equally spaced on a logarithmic frequency axis, and contiguous over the frequency band of interest, the resulting display will be the frequency response. Pink noise by definition will produce equal time-averaged amplitude at the output of each band-pass filter.

The advantage of this method is that it is fast. The use of a pink-noise signal requires averaging the result over a significant length of time, sometimes in the order of seconds. This averaging time can be happening simultaneously in each of the bands; thus the results are presented rapidly (in seconds, or sometimes, fractions-of-seconds). The disadvantage is resolution; a 30-band device obviously gives 30 measurement points. This is a long way from the continuous sweep with a virtual infinity of points across the band of interest. Many acoustics practitioners argue that this lack of resolution is detrimental to achieving useful results.

To answer this requirement, new spectrum analyzers have been developed, with much-improved resolution. The first of these were the FFT (Fast Fourier Transform) analyzers using sophisticated computational circuitry to yield an instrument with significantly improved resolution. A typical device has the equivalent of 400 or so bands, more than an order of magnitude improvement over the one-third octave device. However, there is a catch. The FFT design has an inherently-linear frequency axis. Thus, those 400 bands are linearly spaced, with a constant *frequency* difference between the bands rather than a constant *percentage* difference. This means that a 400 band device, operating from 0 Hz to 20 kHz, will have 100 bands distributed between 0 Hz and 5 kHz, another 100



bands between 5 kHz and 10 kHz, and so on. Each frequency band in this illustration would be separated by 50 Hz. Therefore, the first two octaves (from 20 Hz to 80 Hz) are covered by a little less than two bands of the FFT analyzer. Therefore, on a log-frequency axis, the resolution at low frequencies is worse than one octave. On the other hand, the octave from 10 kHz to 20 kHz has a resolution of better than one-hundredth of an octave near the top end. So, if you are looking to generate high-resolution frequency response plots with the conventional log-frequency axis, you won't get them with an FFT analyzer.

Another approach to improve resolution in a real-time analyzer uses a digital filter method. Like the FFT approach, this method can yield a high resolution with hundreds of bands. Unlike the FFT approach, it can be configured to produce a log-frequency axis. However, it doesn't come easily, and such instruments are not inexpensive.

In spite of the problems of such digital-based instruments, one significant advantage that they offer is increased power in the processing and presentation of data. Also, time integration can be achieved with far more accuracy and consistency than by analog methods. Presentation of results, usually on a CRT, can be configured in the format of the user's choice. Mathematical manipulations of several results are possible, such as comparison, or subtraction of two results to yield a difference plot.

To summarize, real-time spectrum analyzers can offer significant improvements in some areas, but often at a

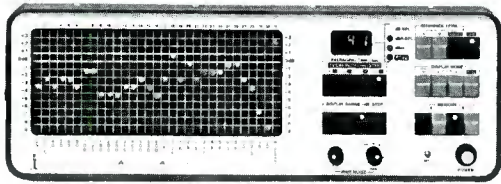

*Inovonics Acoustic Analyzer Model 500. A real-time, one-third octave audio spectrum analyzer with data presentation on a 13 x 11 led matrix and a digital readout. The portable instrument provides two digital memories, battery operation and internal noise generator. A flexible choice of averaging times, display range and input sensitivity cover a wide variety of applications. Two pole pair filters exceed ANSI class II requirements. A unique feature is the ability to both generate an RT 60 plot as well as display the RT 60 on digital readout. Connectors permit interface with an oscilloscope or digital peripherals.*

trade-off. One trade-off is cost. However, in situations where speed is essential, they are often the only technique that can be used.

## **SWEPT ANALYZERS**

One way to get around the resolution problem and cost considerations of real-time analyzers is to use a non-real-time spectrum analyzer. Whereas in the real-time analyzer several parallel filters are used, the non-real-time approach uses a single filter, which is swept over the band of interest. Such an approach requires only a single high-quality filter, a single detector, some storage medium and the control circuits to sweep the filter over the band. This approach offers virtually infinite resolution and considerable flexibility on the characteristics of the filter. With only a single filter to deal with, the bandwidth and other shape characteristics can be easily modified for particular applications. The approach is also inherently lower in cost. Of course, once again there is a trade off, and that is time: it obviously takes longer for a single filter to sweep over the whole band than it would for several filters, fixed across the band, to acquire the data. Often the trade-off is not significant, as the time to do the complete sweep is small in comparison with the total measurement time (that is, the time required to set up the equipment, make changes to the device under test and so on). The non-real-time analyzer may take a minute or more, but since the whole measurement session may take hours, the differences tend to diminish. The increased resolution of the swept frequency analyzer is sometimes highly desirable, and often essential.

The swept frequency analyzer uses a storage medium similar to that described for the sine wave response checks. It may be a paper recorder, a storage oscilloscope, digital storage, or some other means. If the storage is digital, the data manipulation features described in the FFT analyzer are also possible. In addition, such instruments usually have the capability of varying the filter characteristics, the sweep speed, the detector time constants and other parameters—all of which effect the final plotted curve. You might say that such flexibility makes the instrument complicated to operate, but the wide variety of measurement situations requires this degree of flexibility. The parameters of bandwidth—often called resolution—and sweep speed, are directly related. A wider filter bandwidth gives poorer resolution, but permits a faster sweep

speed. On the other hand, a very narrow bandwidth can give very high resolution, but at a cost of very long sweep times.

In this discussion of swept analyzers, we have mentioned two types of resolution. One is the resolution of the storage medium and the fact that the filter is swept over the band rather than a small series of points measured. This could be called plotting resolution. In the second case, related to the bandwidth of the filter, the resolution describes the ability of the analyzer to resolve fine details of signal components. This is the resolution most often referred to in specifications of spectrum analyzers. Typically the resolution of the plotting system greatly exceeds the resolving ability of the filter.

There are two basic configurations of swept filter analyzers. In one, the filter has a constant bandwidth over the full sweep range, and the frequency axis is usually linear. In the other, the filter has a constant-percentage bandwidth (that is, a constant fractional octave bandwidth), and the frequency axis is usually logarithmic. Constant-bandwidth instruments can have bandwidths as small as 1 Hz. Almost all of these devices are realized using the same technique; a local oscillator, a mixer and a single fixed filter followed by a detector. The local oscillator is swept and mixed with the incoming signal, the products are passed through the filter, and the resulting curve is just as if the filter itself had been swept. The technique is not new—it is used on most radio receivers for a similar purpose. Inherent in this technique is a filter with a constant bandwidth.

The second method requires that an actual filter be swept. The frequency-determining components of a band-pass filter are modified by the control circuits to continually re-tune the filter over the sweep band. This results in a swept, constant-percentage bandwidth, band-pass filter. For the constant-bandwidth filter, the first case, to have the same shape anywhere over the frequency range, frequency axis must be linear. On the other hand, for the

*Bruel & Kjaer 2131 Digital Frequency Analyzer. A completely digital real-time octave and one-third octave audio spectrum analyzer. Utilizes filtering, digital rms detection and digital averaging for highly accurate and predictable results. Data is presented on a large fully annotated CRT. Provides analog and digital input and output for system use, computer control and automatic test applications. Provides up to 42 channels (one-third octave), 60 dB display range, 13 averaging times in both linear and exponential averaging and digital storage. By connecting to an external computer and XY plotter, three dimensional plots of spectral energy-versus-time can be generated.*

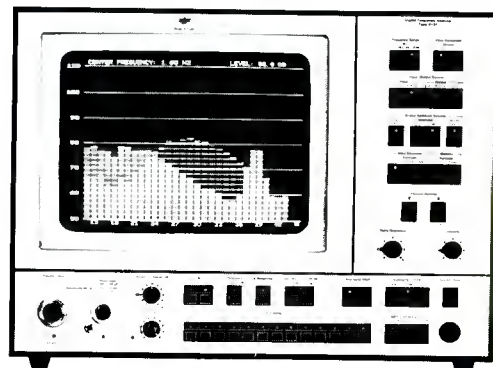

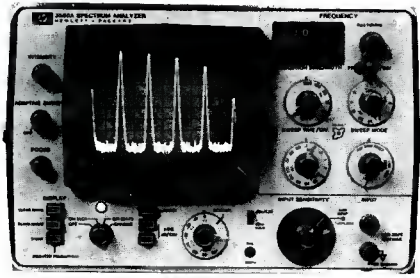

**Hewlett Packard 3580A Low Frequency Spectrum Analyzer.** A swept filter type analyzer optimized for audio frequency analysis to 50 kHz. Uses a digital storage technique for long term, flicker-free display. Dynamic range of over 80 dB permits distortion measurement to 0.01 per cent or better and a resolution bandwidth of 1 Hz allows separation of finely spaced components. A unique feature, Adaptive Sweep, can greatly reduce the sweep time required for high resolution, low frequency measurements. An internal calibration signal, ability to store one trace while generating a second for comparison and flexible parameter variation enhance operator convenience.

constant-percentage bandwidth filter to have the same shape over the frequency band, the frequency axis must be logarithmic. The application will usually point to which method is the best to use. For acoustic applications a log-frequency scale is usually preferred. Human perception of sound is on a logarithmic basis, and therefore it makes more sense to distribute the frequency axis logarithmically; that is, linearly by octaves. A constant-percentage bandwidth filter, swept logarithmically over the frequency band with pink noise as the source, will yield a horizontal line. This is the preferred approach for acoustic measurements. On the other hand, the constant-bandwidth analyzer does have its applications. There are several industrial applications involving vibration and other requirements, but in audio the primary application is that of distortion measurement. A linear frequency scale distributes the harmonics of the test signal evenly. The requirement of resolving a large number of harmonics of the test signal dictates the use of a constant-bandwidth filter and the linear frequency axis. So the constant-bandwidth analyzer has applications in electronic testing and the constant-percentage analyzer has applications in acoustic testing.

### SPECIALIZED ACOUSTIC TESTS

Several unique methods have been devised for generating swept frequency response plots of transducers in normal environments. The objective is to achieve the high resolution of a swept sine wave without the abnormalities characteristic of such a technique. Bruel & Kjaer have devised a gating system which uses a swept sine wave that is rapidly gated on and off during the sweep. The receive section has a similar gate with adjustable parameters. Used for speaker testing, the receive gate is adjusted so it only measures the incident waveform. The reflected waveforms are gated out of the measurement. By suitable adjustment of the send gate repetition rate, the ON time and adjustment of the receive gate delay and its ON time, a frequency response plot can be generated which ignores the effects of the environment. As in all test methods, there are low frequency limitations related to the

size of the environment. However, the method provides high resolution, is relatively inexpensive to implement, and has demonstrated accuracy of result.

### TIME DELAY SPECTROMETRY

Another novel approach is time-delay spectrometry. Originally developed by Richard Heiser of the Jet Propulsion Laboratory, this technique uses a very rapid swept sine wave on the generator end, and a similar very rapid swept band-pass filter on the receive section. Both the generator and the filter are swept over the audio band rapidly, in the order of a second or so, with a slight time offset in the swept filter. Since the measurement microphone is placed some distance from the loudspeaker under test, there will be a slight time delay in the received swept sine wave. The swept narrow-band filter is adjusted to coincide with the received sine wave. Reflections in the environment will produce even later received signals. By the time they are received the narrow-band filter will have moved to a higher frequency and will thus reject them. Like the gating method, there are low frequency limitations imposed by the size of the environment.

Both techniques are powerful tools for measurement of the frequency response of transducers and transducing systems. In both cases, the receiving window—whether it is time-related in the gating principal or frequency-related in the TDS principal—can be adjusted to look at a particular result. This does not necessarily have to be the incident waveform, but could be a particular reflection or, everything except the incident waveform. All of these can yield response plots that are useful in speaker development, monitor system and sound system optimization, and acoustical environment studies.

### REVERB TIME MEASUREMENTS

An area of acoustic measurement that is receiving increasingly more interest is reverb time measurements. It is being recognized that the reverb time characteristics of the environment significantly affect the perception of

*How filter shapes change as frequency is varied linearly or logarithmically. The log-frequency axis, popular in acoustics suggests the use of a constant-percentage bandwidth filter while the linear frequency axis, useful for distortion analysis, benefits from a constant-bandwidth filter.*

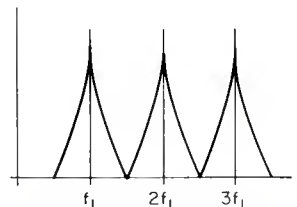

LINEAR FREQUENCY AXIS  
CONSTANT BANDWIDTH FILTER

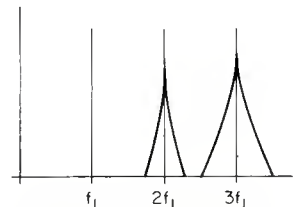

LINEAR FREQUENCY AXIS  
CONSTANT PERCENTAGE  
BANDWIDTH FILTER

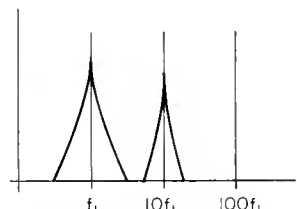

LOGARITHMIC FREQUENCY AXIS  
CONSTANT BANDWIDTH FILTER

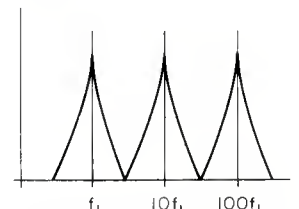

LOGARITHMIC FREQUENCY AXIS  
CONSTANT PERCENTAGE  
BANDWIDTH FILTER



*Acoustilog Model 232A Reverberation Timer. Room decay-time, RT 60, is computed and digitally displayed within each of 19 frequency bands—from 63 Hz to 12.5 kHz. With the internal pink noise generator and automatic level detection, repeatable and uniform readings can be obtained. Other features include: two noise averaging filters, zero-crossing circuitry for external inputs, AKG phantom-powering, and a recorder output.*

sound. The reflection characteristics of the room can often have a far more significant effect on the actual perceived frequency response than the response of the transducers themselves. Reverb time is defined as the time that the sound takes to diminish by 60 dB after it is abruptly shut off. The environment is excited with the test signal, its amplitude is measured in dB SPL, the test signal is removed and the time it takes for the test signal to decay 60 dB is recorded. Highly-reverberant rooms can have RT 60's in the order of several seconds. Studios on the other hand are usually in the order of tens or hundreds of milliseconds.

In many environments, it is difficult to achieve an amplitude difference of 60 dB between the test signal and the ambient condition of the room. It may be possible to achieve only 50 or 40 dB, or sometimes even less. In

this case, the results must be extrapolated from a measurement over a smaller window. Most reverb time meters use this technique. They measure the amount of time for the signal to decay 10, 20 or 30 dB and multiply the result by the appropriate factor to display the RT 60 times.

It is often important to see the actual shape of the decay curve. Again, this used to be quite difficult to achieve. With current available instrumentation, it is often as easy to achieve as a frequency response plot. The vertical scale is amplitude, linear in dB, and set to have an overall scale factor of 60 dB. The horizontal scale is time, linear in seconds, and usually set to have an overall scale of 1 or more seconds.

The test transducer in the environment to be measured is excited with the test signal and an amplitude as high as practical. The plotter is adjusted for full scale deflection. Then with the plotter running, the signal is abruptly cut and the curve of the decay is plotted. An ideal situation would show a straight diagonal line from full signal to ambient. In practice the condition is usually quite a bit different, the curve may show a variety of slopes, it may even fall for a portion then begin to rise and then fall again. Such conditions reflect abnormalities in the environment, no pun intended, and can significantly affect the apparent frequency response. By plotting such curves at several points over the audio band valuable information is gathered on the characteristics of the environment. Again, a graph gives considerably more data about the conditions than a simple number.

Some spectrum analyzers can be configured to plot this kind of curve. If the swept filter is held stationary the plot is the required amplitude-versus-time. Some of the newer real-time spectrum analyzers include this capability as one of the functions available from the front panel. ■

*(To be Continued)*

## Stressing Quality

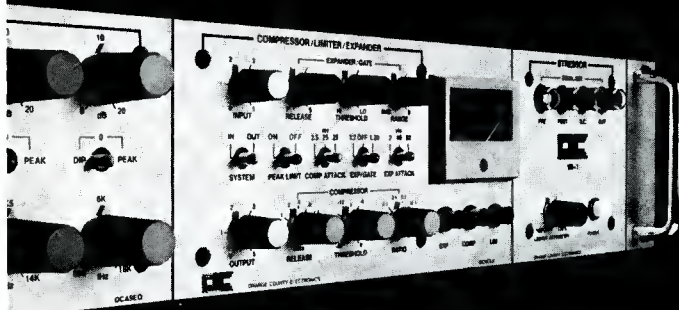

The Orange County VS-1 Stressor combines several necessary signal processing functions to give you the power to handle problems such as level control, noise, and equalization all in one 3½" package:

- Compressor with adjustable ratio, threshold, attack and release times, for loudness enhancement
- Fast peak limiter with 250:1 slope for overload protection
- Highly effective expander/noise-gate for noise reduction
- Full parametric equalizer with extraordinary tuning capabilities
- Overall performance specs and construction to the highest industry standard

The VS-1 Stressor belongs in your studio as a versatile and powerful production tool. It offers the creative producer/engineer the most control in any single package on the market.

Also investigate the VS-2 Stressor, which offers internally pre-set functions for the budget-conscious user looking for great sound.



ORANGE COUNTY ELECTRONICS  
INTERNATIONAL INC.  
Exclusive Sales & Marketing:

**Parasound**

680 Beach Street, San Francisco, Ca. 94109 (415) 673-4544

Dealer Inquiries Invited

# A Precision Dynamic Range Controller

*A system designed to provide independent processing of multiple channels of audio, without the use of redundant signal processing circuitry.*

WHEN IT COMES TO ADVANCES in the art of signal processing, perhaps disc mastering is one of the most neglected areas. The small size of the market and the peculiarities of the technology have led independent manufacturers to defer design to manufacturers of lathes and cutting amplifiers. But some lathe manufacturers seem to work on the principle that signal processing is either unnecessary or undesirable. This view may be correct but only if the lathe operates in an environment in which all tapes received for cutting have been uniformly and correctly pre-processed. Unfortunately, this ideal condition is rare.

Disc mastering engineers engage in a daily struggle to transfer from tape to disc the "masterpiece" created in the studio by musicians, recording engineer and producers. Typically an engineer is enjoined to "preserve the bass, keep the highs clean (but loud), brighten the mid-range, and keep the level up (after all, it has to sound commercial) . . . incidentally, the side runs twenty-four minutes." With instructions such as these flying in the face of both physics and the state-of-the-art in cutting heads and playback systems, it is not surprising that disc transfer personnel are always looking for methods of improving their control over the entire process.

Much equipment used in disc transfer is actually studio equipment—admittedly good studio equipment, but not equipment designed with the unique requirements of the cutting room as a prime consideration. Consider, for example, the problems resulting from the necessity for providing the lathe pitch control system—via the "preview"

head—with an exact duplicate of the program signal. Three processing choices for the preview signal are available:

1. Ignore the signal processing system completely.
2. Use the real-time audio signal for the preview feed, and then process the program signal through a time delay for the actual cutting.
3. Duplicate all the program signal processing equipment for the preview system.

Of these choices, the first was quite common five to ten years ago. Lathe manufacturers even advised clients that the preview signal could safely be processed with a bare minimum of equipment. Considering that appropriate equipment wasn't readily available, it was pretty good advice. Happily, a little knob called "Preview Offset" could be used to change the gain of the preview channel relative to the program, thus partially compensating for the use of equalizers or dynamic range reduction devices in the program chain.

From a systems standpoint, the time delay method is quite attractive, in that it eliminates the need for duplicate processing, and for the accompanying preview head with its associated tape loops, bearings, etc. Unfortunately, commercial realization of systems for this purpose has been less-than-satisfactory; not for lack of effort, but for lack of the technology required to process sufficient digital bits at a rate high enough to preserve dynamic range and transient response. If time delay could be used for preview instead of program, this would be an excellent method. But of course this isn't feasible, so we are more-or-less stuck with the third choice.

As technology has progressed, lathe manufacturers have heeded the call, and developed pitch control systems with higher sampling rates and more-precise control over groove packing. One commercially-available system boasts such accuracy that grooves can be spaced, just barely touching each other on peak excursions, as well as at lower levels.

As a result of all this technological progress, small discrepancies between program and preview signal processing result in substantial errors in groove spacing, in turn leading to ineffective utilization of the available disc surface. Better methods are needed.

## TRACKING SYSTEMS

Accurately-ganged level controls have been universally available for years, and tracking equalizers have been around since 1972. What has been lacking has been a good tracking limiter/compressor system. A so-called "tracking system"—equalizer, compressor or whatever—is merely a signal processing device in which two (or more) signal paths may be independently (but *equally*) modified with a single set of controls. The advantages for meeting the preview/program requirements of disc mastering are obvious, but the same system may also be used to advantage in any stereo (or quad) mixdown or transfer application.

## DESIGNING A TRACKING COMPRESSOR/LIMITER

Early in our design program for such a device, some basic requirements were established:

1. Audio quality sufficient so as not to be a limiting factor in the program chain.
2. A minimum number of controls for a maximum number of functions.
3. Responsibility for decision making resting upon the mastering or recording engineer, rather than upon an assortment of logic chips and R.C. circuits purporting to automatically adjust dynamics by formula.
4. Ability to interface other control functions without duplicating audio circuitry.
5. Intelligible and useable readouts and controls.

Requirement 1 was relatively easy. Voltage-controlled amplifier (VCA) development has now advanced to the point where commercial realizations have acceptably-low distortion figures, and are relatively stable. For development purposes, a dbx VCA in series with a Sontec HS-1000 discrete op-amp (slew rate greater than 200 V/ $\mu$ sec) provided the entire audio signal path, resulting in a simple, clean attenuator with a nominal gain of unity.

The real problem lay in developing control circuits to drive the VCA, which responds to a 1-volt change in control potential with a 20 dB change in level. First hurdles were the Log Converter, and Peak and rms Detectors. Although standard instrumentation circuits were available, none had the requisite performance, so new devices were designed. FIGURE 1 includes a block diagram of these components, whose functions are described below:

**LOG CONVERTER**—Processes the incoming audio into a d.c. function, corresponding to the logarithmic value of the incoming audio over a range equivalent to a level of +40 dBm to -50 dBm. At lower levels performance tends to become inaccurate, but at -50 dBm there is no audible effect.

**PEAK DETECTOR**—An analog circuit capable of detecting and holding, with an accuracy of 0.1 dB, without overshoot, peaks occurring for 10  $\mu$ sec. This accuracy is achieved over an 80 dB range and gradually deteriorates as the peak duration is reduced. In actual operation, the circuit will detect and hold the peak value of a 50 kHz sine wave within one full cycle. A d.c. control voltage programs the release time of the peak detector from 3 to 60 dB/sec.

**rms DETECTOR**—Extracts the true rms value of the audio signal. This isn't exactly an earth-shaking accomplishment in itself; however, the ability to program the attack and release times of the detector, without a shift in operating point, by two separate d.c. control voltages, provides significant flexibility.

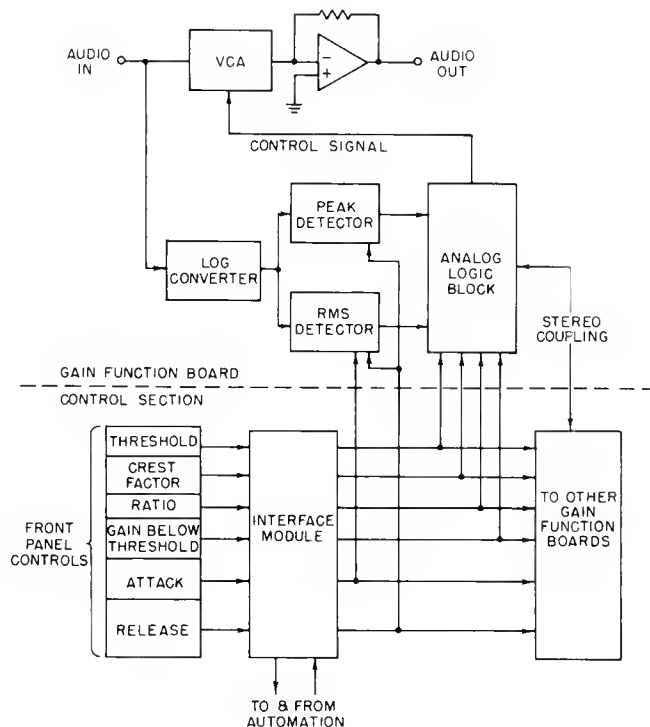

Figure 1. Dynamic Range Control System Block Diagram. The gain function boards may be paralleled for multi-channel operation.

Outputs from the Peak and rms detectors are then processed through analog logic circuits, where reference levels and breakpoints are established by d.c. voltage provided by the front panel controls.

## SYSTEM ORGANIZATION—THE GAIN FUNCTION BOARD

A complete channel of audio control is assembled on a Gain Function Board (GFB) consisting of VCA, op-amp, Log Converter, Peak Detector, rms Detector, analog logic blocks, and trim controls. You may have noticed that every time we refer to any control function it has been designated as a d.c. level. Each board processes its audio signal independently; however, the control ports of each board can be tied together, allowing the front panel control voltages to affect each board in an identical manner. Thereby two boards can process left and right preview signals, while two other boards process left and right program, thus satisfying the requirements of the disc-mastering engineer. A logic provision has been made for tying together the compression logic of two or more boards, thus avoiding stereo image shifts. Aside from disc mastering, the conventional stereo mixdown session would require just one pair of boards, although a complete set of four boards would of course serve the needs of quadraphonic mixdowns.

## DEFINING LIMITING AND COMPRESSION

At this point, we should differentiate between our descriptions of limiting and compression. We define limiting as a transfer function, where increases in input level do not result in increases in output level. In disc cutting, limiting is used primarily to prevent any signal from exceeding a given level. This does not necessarily prevent overcutting or the cutting of groove amplitudes which are unplayable. The input-output ratio is over 100:1, and is generally thought of as infinity.

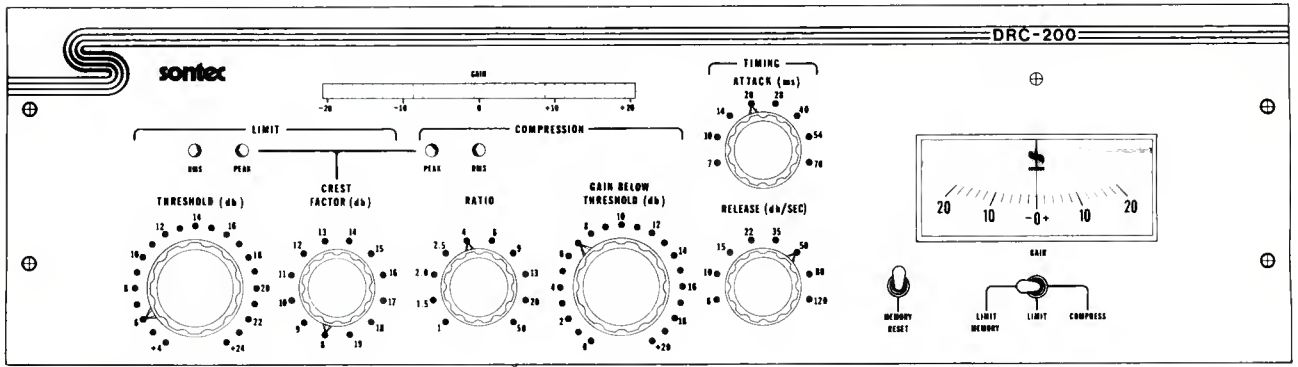

Figure 2. Front Panel Layout

In our system, compression is a reduction of dynamic range by the addition of gain at low levels. As the input level is gradually increased, the added gain is gradually removed until, at a preset **Rotation Point**, unity gain is achieved.

### PANEL CONTROLS

In the design and layout of the front panel, considerable trial and error was involved in the choice of functions, placement, and control increment. Essential requirements were repeatability and a lack of undesirable or unpredictable interactions between functions. As the system eventually evolved, six function controls were designated, and these are seen in FIGURE 2.

1. **THRESHOLD** (of limiting)—Sets the absolute maximum rms output signal level. Calibrated in 20 steps of 1 dB each, referred to the rotation point of +4 dBm (an internally-adjustable reference point). Peak excursions may exceed this level by an amount not exceeding the **Crest Factor** setting. With **Threshold** and **Crest Factor** controls both set at their maximums, no limiting function will occur at any input level below +44 dBm.
2. **CREST FACTOR**—Variable in 1 dB steps from 8 to 19 dB, this control has effects which vary according to input and output signal levels, and the setting of other controls. Above the **Rotation Point**, a **Crest Factor** of, say, 12 dB allows the peak excursions to be no greater than 12 dB above the rms level. Below the **Rotation Point**, the effect of the **Crest Factor** control is a function of the audio input level and the setting of the **Ratio** control. At very low levels, the peak excursions are virtually uncontrolled. As the input level is increased, the control function becomes operative and the actual maximum **Crest Factor** is gradually reduced until the rms level reaches the **Rotation Point**. At the 1:1 **Ratio** setting, there is no **Crest Factor** control function below the **Rotation Point**; an increase in **Ratio** is accompanied by an increase in **Crest Factor** control effectiveness.
3. **RATIO**—The classical input-output compression ratio control, variable from 1:1 through 50:1 in ten steps, while not affecting the limiting action. As seen in FIGURE 3, the 1.5:1 ratio gives an effective operating threshold at -50 dBm, linearly compressing a 50 dB dynamic range to 33 dB. (For set-up and for limiting-without-compression, the 1:1 position is used.)
4. **GAIN BELOW THRESHOLD**—Adds additional gain (20 steps of 1 dB each) to the audio circuit in the absence of signal. With no signal applied, the front panel gain metering will show a gain addition equal

to the amount added by this control (e.g., **Gain** control set to 4 dB will cause meter to read +4 dB). However, the application of any audio input within the compression gain window will cause a reduction of meter reading until, at +4 dBm (0 VU) audio input, the gain meter will again read zero. The setting of this control determines the maximum amount of compression available below the +4 dBm **Rotation Point**.

5. **ATTACK**—10 steps of adjustable attack time of the rms detectors only. Affects both limit and compress functions.
6. **RELEASE**—Simultaneously varies the release time constants of both rms and peak detectors. Although use of this control is most obvious on low-frequency signals, it is necessary that the peak detector release be varied simultaneously with the rms to maintain correct acoustic perspective.

Although each control provides a defined, predictable effect, it is not always possible to determine the precise operating point desired. The addition of four led's to the front panel resolved this difficulty. Peak and rms compression led's are associated with the **Ratio** and **Crest Factor** controls. Peak and rms limit led's are associated with the **Threshold** and **Crest Factor** controls.

Imagine that audio is flowing through the system, and after listening, we decide the really low level portions should be 5 dB louder. We turn the **GAIN** control to +5. If the **Ratio** is set at 1.5:1, the compression threshold will now be at -15 dBm. 5 dB of gain is added at levels below this point, as illustrated in FIGURE 3.

Assuming that the level is gradually rising from -40,

Figure 3. The Input/Output Transfer Function, showing limits for 20 dB compression, 10 dB peak limiting, and 10 dB crest factor.

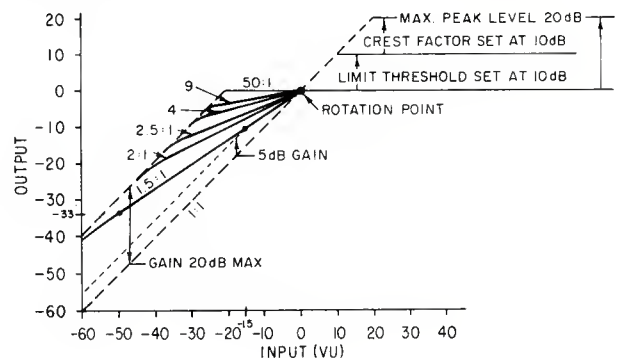



the function led's will remain extinguished. At  $-15$  input level, the rms Compression led will light and will remain lighted as long as the level is above  $-15$  but has not reached the point where any limiting action occurs. At  $+15$  in, the output will be  $+10$ .

Now, assuming you desire a limit on rms level, turn the **Threshold** switch counter-clockwise from its maximum position. At some level setting,  $+6$  for example, the rms limit led begins flashing, indicating your rms level at this time is  $+6$  dBm. If you want 3 dB more headroom, turn the switch to  $+9$ . Occasionally the rms Limit led will blink, indicating that the rms level has reached  $+9$ , and is being limited. Whenever the rms Limit led is lighted, the rms Compress led will be extinguished, as these functions are mutually exclusive. The two time constant controls (**Attack** and **Release**) are set to achieve the most audibly-satisfying control.

After the setting of these four controls, you have complete control over rms operations, but have no peak control. If peak limiting is desired, gradually reduce the setting of the **Crest Factor** control. At some point, the Peak Limit led will begin blinking. If that point is a switch setting of 8 dB, it indicates that the peak amplitude is reaching  $+17$  dBm ( $+8$  added to the previously-set rms **Threshold** of  $+9$ ). If this level of limiting is satisfactory, it may be left unchanged, and a certain well-defined sound will result, since the peak and rms level now share a definite ratio relationship. This relationship is preserved even as the rms **Threshold** control is varied—the peaks will always be limited 8 dB above the rms limit level.

During our early listening tests, a distressing effect became evident. As the audio level rose and fell, and the function shifted from compression to limiting at the rotation point, the character of the audio changes due to the shift from an area of peak limiting to an area of no peak limiting.

When this was discovered, a number of fixes were attempted, but the final solution came considerably later. A new control algorithm was devised, which develops a voltage related to the settings of both the Crest Factor and Ratio controls. As the signal leaves the area of limiting for the region of compression, a controlled amount of peak compression will occur, but this amount is gradually reduced as the signal amplitude is reduced. Transitions from one region to another are now accomplished smoothly, without change in the perceived crest factor.

One of the advantages of having all operations center around the Rotation Point is that adjustments in panel controls can quite-often be made with no apparent change in audio. If the audio signal is hovering around 0 dBm, a change in compression or limiting control settings will become apparent only as the input signal progresses into the areas where these functions are operative. It is never necessary to adjust one control to compensate for a change in another.

## PROGRAMMING

As the design progressed, a secondary benefit soon became obvious. Most control voltages generated were in the range of 0 to 3 VDC; ideal for interfacing to an Allison 65K programmer. Minor adjustments to the circuitry now provided the ability to completely program the functions and the breakpoints of the Gain Function Boards. A multi-pin connector on the rear of the control board provides a signal path to and from the Interface Module, where the programming functions are interpreted and controlled.

## ADDING AN EXPANDER

Several prospective users of the finished system had expressed concern that an expander function had not been

included. Luckily, the modular concept provided a means for remedying this. An external **Expander/Gate Module** processes audio and control signals from the GFBs and generates another control signal for the VCA. Individually-controllable functions include **Operating Threshold**, **Ratio (or Slope)**, **Range** (amount of expansion) plus **Attack** and **Release** time controls.

## METERING

Although much use of a device such as described here is based on the user's aural perception, it was felt that a significant improvement in flexibility could be provided if user-oriented readouts were included. Three distinct modes of display were:

1. The four-led function display previously described.
2. A real-time thirty-one element led moving dot display. Arranged in a row adjacent to the operating controls these led's display gain from  $-20$  (limiting) to  $+20$  dB (compression). Color coding provides an immediate approximation of the system gain with a speed great enough to catch limiting on short transients. The action of the panel controls is immediately obvious, even if no audible effect occurs.
3. An analog meter, switchable to read gain in three independent modes—compress, limit, or limit memory. Either of the first two modes displays gain change over a 20 dB range, but on a peak-hold basis. For example, if the maximum compression in the last time increment is  $+6$  dB, the meter will read  $+6$  for up to twenty seconds (the time is user-adjustable). The limit memory mode holds the maximum amount of limiting for up to thirty minutes. After cutting a reference disc, the engineer can decide if more or less limiting is desired and either adjust the program level or the limit threshold control to provide the exact change required.

In the preceding, no mention has been made of metering to provide audio level indication, either incoming or outgoing, and with good reason. With level metering already available at most important points in any audio systems, the addition of a VU meter to this unit would be redundant.

## EPILOGUE

This writer, masquerading as an audio purist, dislikes limiters or compressors in his audio circuits. If music was meant to have its dynamic range squeezed to a dull-gray uniformity, musicians would play it that way. It shouldn't be, and so, they don't. So much for philosophy.

The pages of publications catering to audio enthusiasts are replete with letters to the editor, lambasting record companies for reducing the dynamic range of recordings to a mere 70 dB. (So we've noticed—Ed.) The discouraging truth is that dynamic range compression is not new; it is here to stay, and if we must be forced to live with it, we may as well make the best of it. For, without compression and limiting, whether done by manual gain-riding or by an automatic device, many recordings would be unplayable or unenjoyable.

The goal, therefore, was to develop in the DRC-200 a device that, under the control of an intelligent engineer, would produce a finished product satisfactory to both production personnel and listener. Only time will tell if success has been achieved.

As a postscript, it should be noted that the unusual conceptual design of the gain control circuits, the rms and peak detectors, and the analog logic circuits were the product of the fertile mind of George Schlemmer, without whose tireless efforts the writer would look several years younger. ■

# XY Response Plotters For The Studio

*A "picture" of an audio system can serve as a handy reference aid—providing valuable hard-copy information.*

**F**ROM THE BEGINNINGS of civilization, men have used graphics to convey information, or to store it for later recall. As Almon Clegg reminded us last month, the expression, "A picture is worth one thousand words," is still quite true. In fact, considering the complexity and volume of modern data, it may even be somewhat of an understatement. (See "Three-Dimensional Analysis: It's About Space" in our April issue—Ed.)

For the recording or broadcast engineer, a "picture" of the frequency response of an audio system is one of the most basic and valuable types of information available. In fact, often the picture may tell us quite a bit more about the system than merely its frequency response. Potential instability, phase characteristics, slew-rate limiting, and audible performance may be inferred or predicted, by carefully examining the overall shape of the response plot. For example; an otherwise-unexplainable peak at some high frequency may indicate system instability, an irregular frequency response may be symptomatic of a phase problem, and so on.

## XY PLOTTERS FOR PRO AUDIO

Who needs XY plotting of audio signals? Certainly, laboratories and production test departments have found XY plotters and level recorders to be invaluable aids in the design of amplifiers, signal processors and transducers. But, in this era of high technology in recording studios, broadcasting, commercial sound, and hi-fi systems, the XY plotter can also perform valuable functions of verifying and/or documenting system or component performance—often with more simplicity and convenience than other measurement techniques.

## RECORDING STUDIO APPLICATIONS

An XY plotter can be extremely useful in recording studio maintenance. Response plots of all channels of a multi-track tape recorder or console can be on standard graph paper, in just a few minutes.

Maintaining a file of these graphs, taken over a period of time, will alert the engineer to slowly-developing problems, before they become severe. Separate graphs of play-back-only (using a standard test tape), and of record-playback, serve to verify the alignment technique of the technician, and the proper (or improper) adjustment of the tape recorder for the type of tape being used. The utilization of such an instrumentation system can also

help reinforce the credibility, technical competence and reliability of both the studio equipment and the personnel.

## BROADCASTING

Broadcasters are required to make, and document, annual "proof-of-performance" tests of their audio system quality, all the way from microphone input to the transmitter and antenna. A hard-copy XY plot of frequency-versus-amplitude is a simple, effective way to satisfy one important element of the "proof" report. And, once this instrumentation capability is available to the station, it can also be used to advantage during regular maintenance schedules, to generate permanent records of the performance characteristics of tape and cart machines, consoles, etc. By comparison of current and previous graphs, warning signs are documented, and costly down-time may be averted, while at the same time transmission quality is maintained. For example, tape head wear is a progressive defect that may go unnoticed until the program director or time salesman asks; "How come WZZZ sounds so much brighter than we do?"

## COMMERCIAL SOUND AND HI-FI

Both the sound system installer and the hi-fi systems specialist will find the XY plotter a valuable checkout tool to verify their work, and the performance of system components. Perhaps more important—as a growing number of systems people are discovering—is the potential

*The UREI model 200 Automatic Response Plotting System. The System consists of a mainframe, plus one of a series of plug-in modules. In the photo, the model 2020 DC Input Module is seen.*

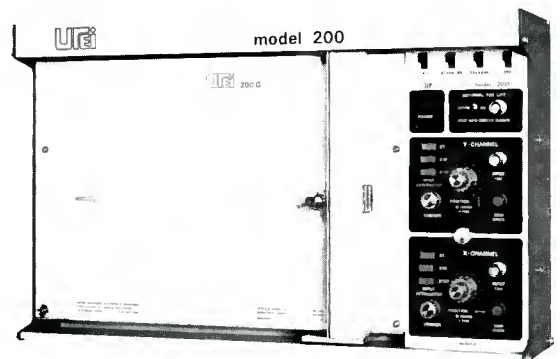

*Brad Plunkett is vice president, Engineering at UREI—United Recording Electronics Industries, Sun Valley, California.*

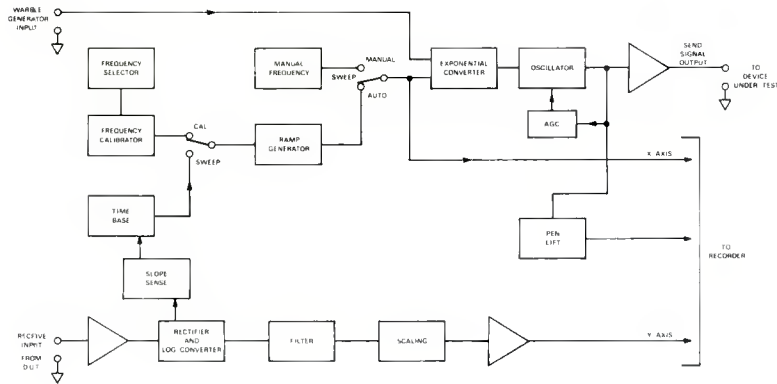

Figure 1. Block diagram, Model 2000.

value of an XY plotting system as a sales tool. As impressed as a customer may be with the sound of your well-designed system, he will be all-the-more impressed with an actual "hands-off" response plot—especially if he watches you make it. This could even be the clincher for that big-buck hi-fi sale, as you graphically point out the superiority of a top-of-the-line tape recorder, by comparing it to the El Cheapo model.

Later on, a reputation for quality service and good customer relations can be enhanced by supplying before-and-after response plots of the repaired audio system.

## A LITTLE HISTORY

Machines for automatically plotting amplitude-versus-frequency have been available for many years. But they have seen little use outside of "big-buck" high-technology laboratories, due to high cost and generally complex operation. Until recently, this has left the small radio station, recording studio, sound contractor and audio component manufacturer in the dark ages of response measurement, using manually-tuned oscillators and a.c. voltmeters to make laborious point-by-point tests in order to assess the performance of a network, transducer or other audio system. In addition, a great deal of expensive and bulky test gear has been required to plot the response of a tape recorder or phonograph arm/cartridge system.

In 1975, UREI began experimenting with the development of an in-house XY plotter, in order to meet our own internal needs for a compact, accurate, and reasonably-priced system which would automatically produce hard-copy plots of frequency-versus-amplitude, specifically designed for our own professional audio applications. The early prototypes—crude ancestors of the present model 200/2000 system—were used in our engineering lab and production lines, to develop and test our other products. As we gained experience through usage, the system was refined through a series of evolutionary changes. These contributed greatly to meeting our design objectives:

1. Accuracy and reliability.

2. Ease of operation.
3. Compact, modular configuration.
4. Expandable functions.
5. Cost-competitive with existing manual-instrumentation.

A number of new concepts, including a "slope-sense" and "smart" pen-lift circuitry were incorporated, and in 1976 it was decided to make the 200/2000 system commercially available. At the time, the system consisted of a basic XY plotter mainframe, with a plug-in sine wave sweep generator and response-plotting module. Since then, additional accessory components have been developed, and others are in the planning stages. Presently, the complete system consists of the following parts;

- XY plotter mainframe
- Automatic response plotting module
- Level and frequency detector module
- D.C. input module
- Oscilloscope display interface mainframe
- Selected AKG 451 omnidirectional microphone
- Microphone pre-amp/warble generator

These component parts can be combined into very powerful measurement systems, which can still be carried under one arm, allowing convenient use in recording studios, auditoria, etc.

**MAINFRAMES:** The cornerstones of the system are the mainframes, which allow hard-copy plotting, or temporary oscilloscope display of response curves. The hard-copy mainframe (UREI model 200) is used where detailed permanent records are desired, as in most engineering work. The oscilloscope-interface mainframe (model 201) is used where permanence is not important, such as in production testing. Of course, the two mainframes may be used together to provide hard-copy only when it is required, as in production line deviations outside of established limits.

## THE AUDIO-TO-XY INTERFACE

The standard XY recorder requires d.c. inputs, which are plotted along its X and Y axes. While this may be all that is required in the research laboratory, it doesn't offer

Figure 2. Typical set-up: electrical frequency response.

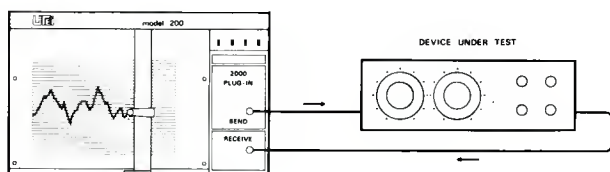
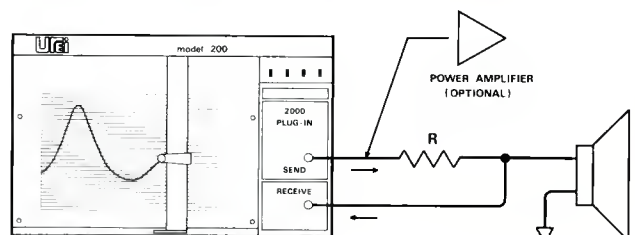

Figure 3. Impedance measurement of a loudspeaker.



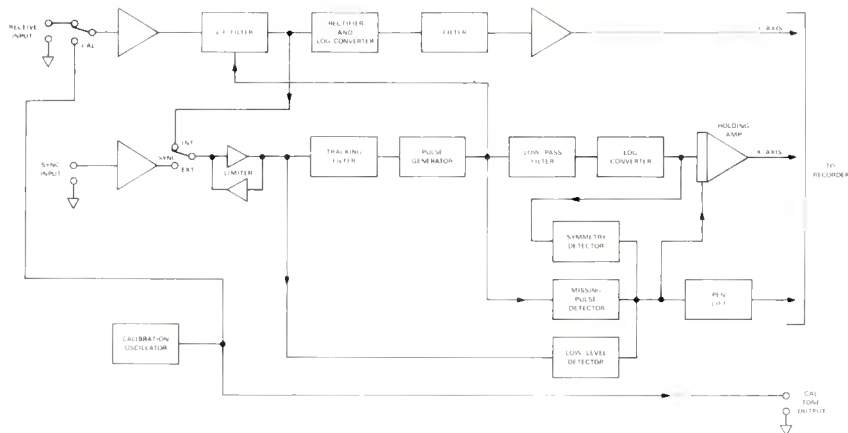

Figure 4. Block diagram, Model 2010.

much promise in the studio, where we are more concerned with a.c. levels and frequency. Therefore, some sort of audio-to-XY interface system is required. Some variations in the interface system may be necessary, depending upon the particular audio application.

The following paragraphs describe a selection of plug-in modules, in order to give the reader a better understanding of the methods of applying the XY recorder to audio tests and measurements.

#### AUTOMATIC RESPONSE PLOTTING MODULE

A block diagram of this module is shown in FIGURE 1. Basically, it consists of a voltage-controlled, swept sine wave oscillator for generating test tones, and a rectifier/“decibel converter” for receiving signals from the device

or system under test. The oscillator is sweepable by voltage control and includes an exponential converter, so that the frequency increase is at a constant ratio-per-unit time. In other words, during the automatic sweep, every unit of time represents the same number of octaves of frequency change. In linear form, the same control voltage is used to drive the horizontal axis of the display. This arrangement allows the use of standard 8½" x 11" audio graph paper, which is horizontally scaled logarithmically at about 0.9 inches-per-octave. This scaling produces the familiar bell shaped bandpass, or straight-line roll-off, curves with which we are familiar. Without this log scaling, the frequencies tend to “crunch up” at one end, producing distorted plots. Another way of looking at this is to say that one octave is “6 dB” of frequency, and the horizontal scale is frequency, laid out linearly, in decibels. (Enough of that!)

The vertical axis drive is derived from the signal received back from the device or environment being tested. After initial scaling with the input control, the received signal is rectified and logarithmically compressed to produce equal size decibels on the vertical axis. The “size” of decibels displayed on the vertical axis may be scaled by a front panel switch from 1 dB/inch to 10 dB/inch in four ranges. Centimeter scaling is also switch-selectable to allow the use of metric paper.

The large size of the display on the XY plotter allows

*The model 201 Display Interface Mainframe is used for direct interface with oscilloscopes, or for applications where a standard laboratory XY recorder is already available. In the photo, the model 2010 module has been inserted in the mainframe.*

**You're in business**  
**with the most dependable complete professional sound system money can buy**

**GLI has the answer:**  
 A dramatic heavy-duty component sound system with crisp, clear power so sharp that it sounds like money well spent.



GLI SA-2125 POWER AMPLIFIER

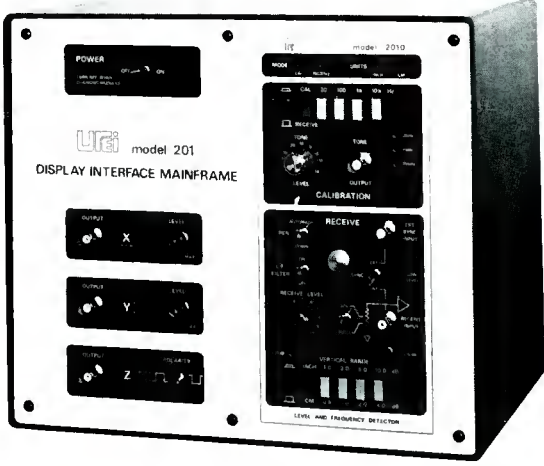

GLI model 201 DISPLAY INTERFACE MAINFRAME

**GLI** INTEGRATED SOUND SYSTEMS, INC.  
 29-50 Northern Blvd., Long Island City, N.Y. 11101  
 (212) 729-8400  
 A Subsidiary of The VSC Corporation  
 SPEAKS FOR ITSELF



Plug-in modules for the model 200 Mainframe. On the left is the model 2000 Sine Wave Frequency Response Module. Next to it is the model 2010 Level and Frequency Detector.

vertical resolution down to 0.05 dB, and horizontal (frequency) resolution to about 2 per cent. The specified accuracy is 1 per cent  $\pm$  2 Hz of indicated frequency, and 0.05 dB of the indicated amplitude on the 1 dB/inch scale. The sweep goes from 20 Hz to 20 kHz, with precise push-button-selectable calibration points at 20 Hz, 100 Hz, 1 kHz, and 10 kHz generated by internal circuitry. The vertical channel contains a 10 dB precision attenuator, which may be activated with a push-button switch to allow verification of the vertical scaling accuracy. FIGURE 2 shows a typical test set-up for measuring the response



The model 21 Warble Generator/Microphone Preamplifier.

of an amplifier, equalizer, record-through-play response, etc. The figure shows the 2000 response module in a 2000 XY plotter mainframe, but it could just as well be in a 201 oscilloscope interface mainframe with the response indicated on the screen. (Semi-permanently, with a storage scope).

Some of the less-common, but valuable, measurements that are possible are acoustical transmission characteristics of materials, and speaker impedance-versus-frequency. A typical impedance test set-up is shown in FIGURE 3.



## "NEW SCAMP EFFECTS MODULES OUTRAGEOUSLY VERSATILE"

...says Elliot Mazer

Elliot Mazer has been producing records internationally for 17 years - working with such artistes as Barclay James Harvest, Frankie Miller, Neil Young, Andy Fairweather Lowe, Linda Ronstadt, Gordon Lightfoot, The Dingoes, The Last Waltz (film) and Vandy.



"When I closed 'His Masters' Wheels' earlier this year to concentrate more on producing and my work with the Stanford University Centre for Computer Research in Music and Acoustics, the only equipment I chose to keep, apart from my favourite mikes and speakers, was my Audio & Design Recording Vocal Stresser and SCAMP system - they're clean, they're quiet, they're reliable, and most important, they sound right. My most recent project with 'Vandy' (A&M Canada LP 'Hot Rocks') uses to great effect the new SCAMP S 24 Time Shape Module and S 23 Pan Effects Module. Both are outrageously versatile."

"The S 23 Pan Effects Module can create many both startling and subtle psychoacoustic phenomena which were previously impossible to achieve."

"The S 24 Time Shape Module is simply the best Delay Line I have ever heard - and I've tried them all."

### audio & design recording inc.

W. COAST: Nigel Branwell Tel: (408) 372 9036      MID-WEST: Gregg Dixon Tel: (312) 252 8144

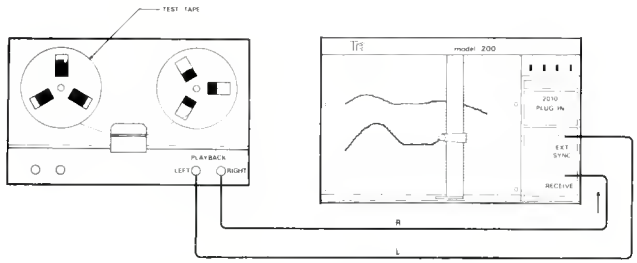

Figure 5. Test set-up for measuring playback response and channel separation.

### LEVEL AND FREQUENCY DETECTOR

A different module (UREI 2010) should be used whenever a signal source already exists; such as test records, test tape or test films, remote-oscillator testing of phone lines, phono cartridge testing, etc. The level and frequency detector module is block-diagrammed in FIGURE 4. It is capable of receiving any coherent signal between 20 Hz and 20 kHz, measuring and displaying its frequency on the horizontal axis, and displaying its amplitude on the vertical axis. The vertical axis drive circuit is much like the one described above, in the 2000 module. It includes a frequency tracking "rumble" filter, which filters the input signal to eliminate turntable rumble or other low-frequency disturbances, from the vertical signal. Without this filter, it would not be possible to measure high frequencies accurately from a test record, because of interference from low-frequency components. However, since the filter tracks with the received frequency (always

maintaining a cut-off point approximately two octaves below the received frequency), rumble is accurately reproduced at the low frequencies. (At a received frequency of 20 Hz, the -3 dB point is 5 Hz.)

Horizontal axis drive voltage is obtained from a frequency-to-voltage converter. This is capable of measuring frequency in the presence of noise, and over an amplitude range of more than 60 dB (the vertical scale length at 10 dB/inch). Sync signal is taken either from the input low-frequency filter, or from a front-panel connector. This allows measurement of crosstalk signals—the level of which might not be adequate to reliably operate the frequency detector circuitry. The sync signal is passed through a limiting amplifier, and then to the tracking band-pass filter. This band-pass filter is capable of centering on, and filtering, any signal from 20 Hz to 20 kHz, over a 70 dB or greater amplitude range. The output of the band-pass filter drives a pulse generator, which in turn feeds an integrating log converter. The output of the log converter drives the horizontal axis through a "track and hold" amplifier which ties in with the pen-lift circuitry.

A very important part of the 2010 level and frequency module is the "smart" pen-lift feature. The pen-lift (and horizontal axis drive) are controlled by 3 separate detectors. If the synchronizing signal drops to a level too low to guarantee good operation of the frequency detector, the pen-lift is activated. If output from the pulse generator ceases or, if pulses are not coming often enough (indicating a frequency below 20 Hz), the pen is lifted. Finally, if the output of the log converter is not steady, indicating an input which is rapidly changing in frequency, the symmetry detector will operate, and lift the pen.

The purpose of these detection methods is to permit the use of the system with non-continuous inputs, such as spot-tones (even with voice announcements in-between) with no danger of "scribbling" on the graph. With a spot-tone test record or tape, the pen simply lifts during voice announcements, silence or lead-in, and drops only after a legitimate tone has satisfied all three criteria of detection.

A precise (1 per cent) oscillator is included in the module, to facilitate horizontal-axis calibration, and a 10 dB precision attenuator allows verification of vertical calibration.

In use, the model 2010 is inserted in the 200 or 201 mainframe and receives signal from the device under test. A typical set-up is shown in FIGURE 5. When testing stereo separation-versus-frequency, the sync input receives the "signal" channel, while the channel to be measured for crosstalk is applied to the module's receive input. For normal response measurement, the sync is switched to

Figure 6. Comparison of sine wave warbled sweeps.

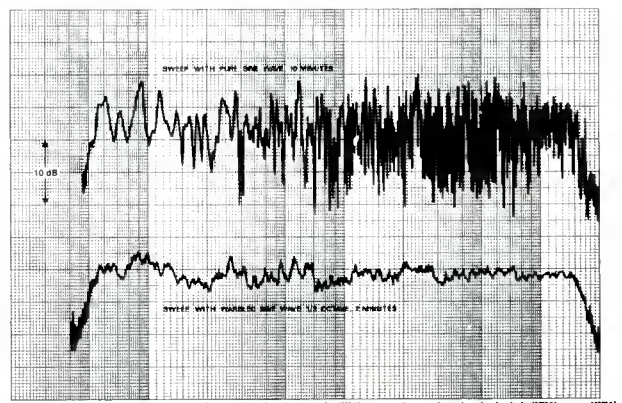

1 an

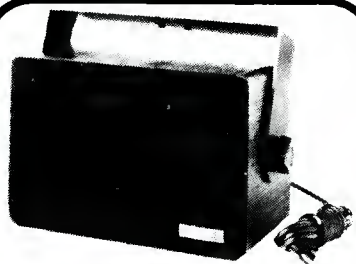

ANCHOR 200: 8" x 12" x 8"  
55 watts output 0.15% THD

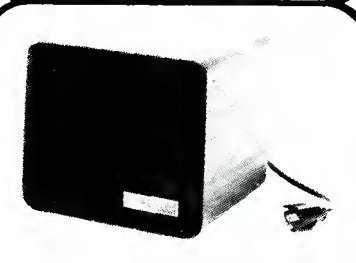

ANCHOR 100: 6" x 7" x 8"  
35 watts output 0.15% THD

**A  
SELF-  
ENERGIZED  
COMPLETE  
PA SYSTEM  
IN ONE  
NEAT  
PACKAGE.**

Compact, light-weight, easy to handle, versatile, with balanced microphone, phono and auxiliary inputs, speech/music equalization, and a "line output" mode that allows several units to be fed from a selected "master" unit. Send for free brochure.

**ANCHOR**   
BY NORTHWEST SOUND

Manufacturing Division  
P.O. Box 3586, Portland, OR. 97208  
(503) 223-1924

NAME \_\_\_\_\_  
ADDRESS \_\_\_\_\_  
CITY \_\_\_\_\_ STATE \_\_\_\_\_ ZIP \_\_\_\_\_

Circle 25 on Reader Service Card

the internal mode, and is therefore derived from the signal being measured.

### D.C. INPUT MODULE MODEL 2020

The 200 XY plotter mainframe is a modified Hewlett-Packard model 7015B Lab XY Recorder. As described earlier, the recorder is designed to produce displacements proportional to d.c. voltages at the X and Y axis inputs. The model 2020 D.C. input module has been designed to allow use of the system as a conventional XY recorder, for connection to any analyzer with d.c. analog outputs. Three ranges of sensitivity are provided: 0.1, 1.0 and 10 volts-per-inch on both axes. Remote pen-lift is also provided, which may be activated with a logic-low signal or a contact closure to ground.

### MICROPHONE PREAMP/WARBLE GENERATOR MODEL 21

A quite old, and in the past difficult-to-use, acoustic measuring method involves the use of a "warbled" or frequency-modulated sine wave. When a sine wave is frequency-modulated, additional frequency components are generated around the carrier frequency. This spectrum spreading tends to break up standing wave patterns and produce a sort of spatial integration of resonant peaks and valleys. Early systems using warble techniques involved large, bulky, heterodyne oscillators, which required constant resetting of bandwidth when the test frequency was changed. Due to the set-up complexity, this type of analysis was replaced in large part by pink noise techniques. However, pink noise suffers from lack of resolution, and where narrow-band analysis is required in a reverberant environment, warble testing can be the answer. The width of the analysis window can be ad-

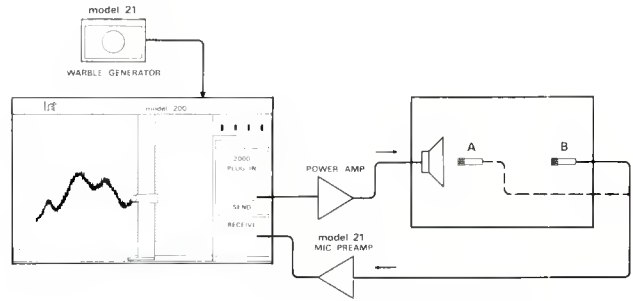

Figure 7. Acoustic frequency response measurement with warbled sine wave sweep.

justed, simply by changing the width of frequency modulation. A typical warble-tone analysis of a good speaker system is shown in FIGURE 6, with a typical sine wave response of the same speaker system above it. The sine wave response simply tells you too much. However, the swept one-third octave warbled-sine wave still gives more information than would be obtained with noise and a one-third octave fixed-window analyzer. The test set-up is as in FIGURE 7. These plots were made with a model 2000 module and a model 21 mic preamp/warble generator, with a selected AKG 451 omnidirectional microphone.

As noted earlier, a picture is worth one thousand words. And, there's another old axiom—especially true in any recording or broadcast studio: "time is money."

A modern response plotting system is a typical example of how modern audio instrumentation technology can save the studio engineer both time and money, and also, conveniently provide those thousand-word pictures. ■

# Amber 4400A: top studio performer.

**AMBER 4400A MULTIPURPOSE AUDIO TEST SET.** Designed for an industry where time is money, and maintaining top performance is essential. It saves you time by integrating virtually every test and measurement function you could need. It cuts setup time, and assures quality equal to or exceeding competitive equipment, but at a fraction of the cost.

With your oscilloscope, the Amber 4400A can plot the frequency response of a tape recorder or monitor system; measure the weighted noise of a console; plot the phase response of an equalizer or check the transient behaviour of a speaker; tune your room or measure the RT<sub>60</sub> of your studio. Optional interface lets you make hard copy plots with any XY recorder.

The Amber 4400A combines versatility with quality. It integrates sine, function, sweep, tone burst and noise generator; autoranging digital dBm meter and frequency counter; multimode filter; spectrum analyser; frequency response and phase response plotter.

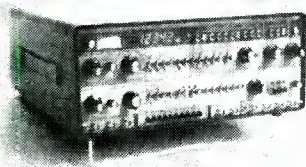

The Amber 4400A lets you make sure your product is always at its best.



Export  
Gotham Export Corporation, New York

Amber Electro Design Ltd.  
4810 Jean Talon West  
Montreal Canada H4P 2N5  
Telephone (514) 735 4105

# amber

Circle 20 on Reader Service Card

# Doohickii Digitali

*A "bit" here, a "bit" there, digital signal processing is growing by leaps and bounds.*

**"D**IGITAL" IS A POPULAR word of late. When you asked the time of day ten years ago, you would have received a reply "half past 7." Today you're more likely to hear "7:28:57." Digital data are easier to read, interpret, and remember than are equivalent analog data. One need not approximate the position of a watch hand, mentally correct for parallax, and then translate the data into a suitable format for the user.

Although it may not be instantly obvious, the watch hand is capable of giving more accurate information than the digital readout! For instance, one could position a microscope over the hand and watch it sweeping along. A mark could be made on the dial, indicating that when the hand passed a specific point, the time was precisely 7:28:57 and 31/100 second. Of course, one rarely needs to know the time to such a high precision, but the point is that it is at least theoretically possible to determine the time to any degree of precision using the above technique, or modifications thereof. On the other hand (not the watch), once one has QUANTIZED, or given a precise numerical value to the time, there is simply no way to extract additional information from the number. It might be almost 7:28:58, or much closer to 7:28:56, and the clock-watcher would have nary a clue. Again, in this case it hardly matters. But let's take our analogy into the world of signal processing.

One object of the recording art is to reproduce, as faithfully as possible, the input signal. While immense strides have been made in recent years, there are still flaws in the process. The primary flaws involve the introduction of noise into the signal chain. Every time a signal goes through a processing, recording, or reproducing step, a small amount of inaccuracy (noise) is introduced by the processor. Referring to our example, suppose the gears in the watch were a little worn and the hand moved in fits and starts: this "noise" limits the precision to which the actual time (or signal value) may be determined. As the number of processing steps increases (or as the watch, microscope, and observer all vibrate at different rates), it may well become impossible to determine the time (or the signal value) to the precision necessary. On the third hand,

once the time has been quantized to a specific number, it is not readily subject to additional distortion by misreading or misunderstanding. There is much more difference between a "1" and a "2" than there is between a watch hand and a mark several micrometers apart. So, if one can quantize one's signal *before* it is subject to noise and distortion-producing devices and procedures, one can recover it intact later. Of course, if this were all that were desired, there would be little need for companies specializing in digital manipulation of data and this article would be signed by different authors. Because it isn't (signed by different authors, that is); you may infer that we'll have something to say about what can be done with a signal once it's in quantized form.

Since we were talking about precision earlier, let's consider what's precise enough. The end-user of the quantized signal is an extremely complicated analog processor known as a human being (a "hey you" in some dialects). For audio signals, this is the limiting factor. Because there is a definite expense involved in improving the precision of our processing, it makes no sense to improve our capabilities significantly beyond the capability of the human to discern the difference. The precision of reproduction of an analog signal can generally be characterized by the term "signal-to-noise ratio." This ratio, measured in decibels, indicates that, below a certain level (referred to the maximum level present), the signal assumes a (usually) random or meaningless value, and no further information can be extracted. The major degradations of signal-to-noise ratio are usually caused by transmission or storage channels, such as radio transmission, tape recording, or disc pressing. The advent of digital recording and videodiscs (which may include digitally-encoded audio data), will eventually eliminate the major causes of degradation. This leaves the minor causes to be dealt with. As was stated earlier, every analog processing step adds some noise. Digital processing generally does not. If there were no other reason for digital, this would be sufficient. However, there are many other reasons, chief among which is the following:

Digital processing can routinely perform certain tasks which are difficult or impossible to perform with analog circuitry. This article will discuss some of the many possibilities.

## DELAY

Remember delay? There have been so many articles on the digital delay line in recent years that it's probably time to stop belaboring the process involved. Semiconductor memories and shift registers—rare beasts in the early



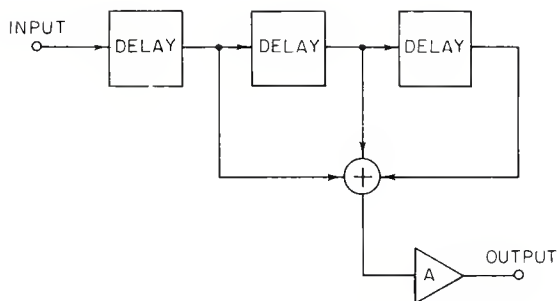

Figure 1. A basic digital low-pass filter.

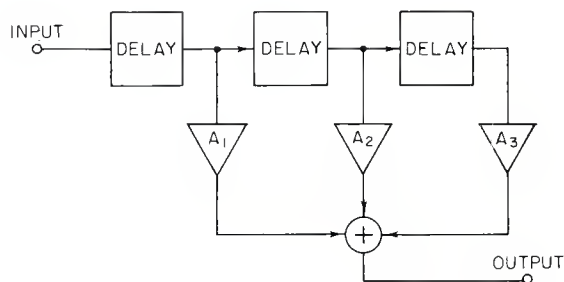

Figure 2. A tapped-delay filter.

'70's—are now so plentiful that almost every electronic device that can conceivably use them to advantage has one or more contained therein. Telephones that remember the last number dialed, television sets that remember which channel to turn on, and calculators that remember checkbook balances after being off for a week are a few examples that readily come to mind. Contravening inflation, the pricing of these components has decreased to the point where one can now purchase a delay line with 6.4 seconds of delay for little more than the price (and this in inflated dollars) of a 200 millisecond delay line of 1973! While the economics of delay remain essentially the same, wherein the amount of memory required is the product of the delay time and the frequency response, the price of memory continues to decline, to the point where a 6.4 second delay is practical and the price of shorter delay lines is buoyed principally by the cost of ancillary componentry, such as A/D and D/A converters, power supplies, and ever more by the complex, microprocessor and high-speed logic-intensive control circuitry.

We feel that we have pretty much exhausted the need for longer delay. The 6.4 second delay line was designed for broadcast obscenity policing. (See "There Will Be a Short (Expletive Deleted) Delay" in our September, 1978 issue—Ed.) Occasionally longer delays may be useful, such as for delaying network broadcasts for a few minutes to fit a particular format, but generally any further delays will have to be much longer, for archival storage. Since semiconductor memories lose their data when power is removed, it is unlikely that we will see people collecting Random Access Memories (RAMs) instead of records or tapes. Thus, at least in this one particular, digital processing will have to expand in other areas, such as quality and versatility.

To see where digital processing might be employed, let's look at some of the processing operations commonly performed during the recording/mixing process:

There are amplitude-related processes, such as compression, limiting, and noise-gating.

*The Eventide model H949 Harmonizer. Recent developments in memory technology make it possible to provide more delay, greater dynamic range and an improved frequency response.*



There are frequency-related processes, such as equalization and effects filtering.

There are time-related processes, such as automatic double-tracking, slap-echo, and artificial choruses.

There are multiple effects, such as flanging, which can be regarded as a time or frequency modification, and—most complicated of all—the simulation of room acoustics, using spring or plate devices, whose operation affects time, frequency and amplitude simultaneously.

Devices to perform all of these processes are commercially available and work well. It's possible to synthesize any of them with appropriate digital circuitry, usually with a substantial increase in capability and versatility. In fact, it is a credit to the versatility of digital computation that *all* of the above effects can be achieved simply (or more accurately, very complicatedly) by shifting numbers around under the proper kind of control.

## A BYTE OF HISTORY

The techniques employed in digital signal processing (DSP from here on) are from a branch of mathematics known as "numerical analysis," originally developed by the 16th and 17th century mathematicians LaPlace, Newton, Gauss, Napier, and others. The purpose then was to aid in the computation of the orbits of heavenly bodies. Fortunately for the development of mathematics, the data rate of the sky is quite low, and the results of the mathematical operations could be evaluated by hand and later by quite-complicated, but only mildly-effective, mechanical devices. The data or "sampling" rate of audio signals is of another magnitude. Far from being one, or a few, observations-per-night, audio theoretically requires 40,000 observations (or samples) per second, and practical considerations raise this number to about 50,000. When one considers that even the simplest digital application (such as attenuation, or multiplication by a number less than 1) requires 50,000 multiplications per second, and more complicated applications such as reverb synthesis can require millions of operations per second, it becomes obvious that pencil and paper won't do!

One fortunate simplification of what might appear to be an intractable problem is that only two basic operations are required for DSP. They are: addition and multiplication (Subtraction is mathematically equivalent to addition of a negative number, while division is equivalent to multiplication by a fraction). In fact, strictly speaking, even multiplication can be performed by repeated addition, so that conceptually DSP can be reduced to a rather long series of additions. The only other requirement is for storage. The input sample must be available, the output sample must be available, and—depending upon the processing being performed—anywhere from zero to many thousands of intermediate samples must be available, either sequentially or simultaneously. The problem of storage

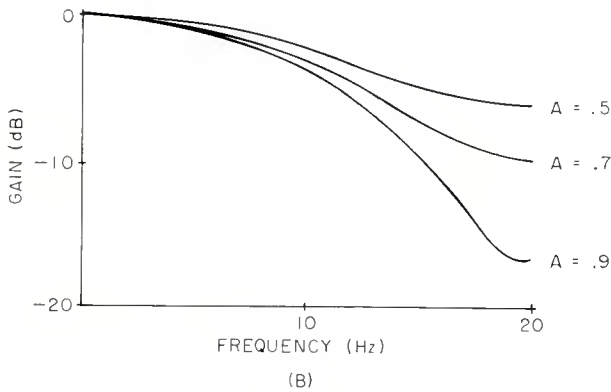
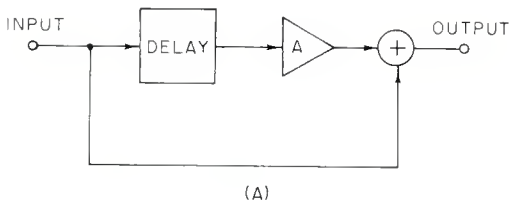

Figure 3. A first-order, non-recursive filter  
(A) Block diagram.  
(B) Frequency response.

has been solved historically (if ten years can be considered history) with shift registers, and more recently with RAMs. The problem of computation has been aggressively attacked and ground into the dust by hordes of semiconductor manufacturers, seeking to sell parts to the military and instrumentation segments of the industry. One of the most notably-successful is the TRW Corporation, which makes single integrated circuits capable of performing (are you ready?) 10 million multiplications of two 24-bit numbers per second! That's 16 million x 16 million x 10 million. If this fails to impress you, consider the following:

1. The chip, even with the power off, is damn cute, and
2. Despite the prodigious capability of such multipliers, it's not enough.

So complicated are real-world processes, such as reverb, that many characteristics cannot be synthesized, even with the computational capability alluded to above. Before we get to the difficult stuff, let's consider some readily achievable processes, such as compression and filtering.

## ARCHITECTURE

One cannot build a digital signal processor by throwing a multiplier and some RAMs into a pot, any more than one can build a console by stuffing some attenuators and VU meters into a hollowed-out control room. One must carefully plan the interconnection of the various components so that they may interact with each other in useful ways. One reason that there is such a profusion of delay lines nowadays is their architectural simplicity: a DDL is basically a series connection of processing elements, straight from the input to the output. In order to perform a series of numerical operations on a stream of digital words, there must be modes of interconnection between the processing element's inputs and outputs. For instance, consider a simple digital reverberation simulator, an effect performed analogically by feeding back the output of a DDL or tape machine to its input, through an attenuator. Achieving this digitally would require connecting the input of a multiplier to the output of a delay chain, and the output of the multiplier to one set of inputs of an adder. The

other set of adder inputs would come from the original signal. The adder outputs would go to the delay chain input, and the system output could be picked off in parallel with the multiplier input.

Carrying this just a bit further, assume it was also desired to use the same device as a digitally-controlled attenuator. It would be necessary to extract the output immediately following the multiplier, zero the delay, and suppress the feedback input to the adders. This type of switching is done frequently in the analog world with the infamous patch bay, which in itself can become almost impossibly complex during a mix. Contemplate if you will how it would be if each audio cable comprised the output of a 24-track tape machine (24 digital bits in parallel), and the entire patching arrangement had to be changed a million times per second! Digital circuits called multiplexers do this routinely. Processing other-than-switching signals and high-speed multiplication is best performed using the so-called "bit slice" microprocessor. These chips are individually not as versatile as the more common and much more familiar 8-bit MOS microprocessors, but they have three distinct and necessary advantages:

1. They are much (typically ten times) faster. Without this capability, they could not operate in real time, and would thus be about as useless as conventional microprocessors for high-speed signal processing.

2. They are expandable to any reasonable word width. The 8-bit width of the conventional micro is inadequate for more than telephone-quality audio. The bit slice can be 12, 16 or more bits wide at only a tiny speed penalty. The same accuracy can be achieved by a microprocessor only by using multiple instruction steps, almost inevitably causing an additional speed decrease of 3 to 10 times.

3. The instruction set can be defined by the user. For instance, if it is necessary in step one to take the output of a delay and feed it to the multiplier input, and in step two to take the multiplier output and add it to the next delayed element, one can program single-step instructions to do precisely this. Again, this can be done by a microprocessor, but only in many steps for yet a further speed penalty on the order of 5.

Thus, it is obvious that although the common microprocessor is excellent for control functions of audio equipment, such as automation and remote control interfacing, it is woefully inadequate for actually working with the audio data itself. This will not remain true forever, by the way. The newer generation of 16-bit microprocessors will be able to perform reasonable amounts of processing by virtue of their larger word size, slightly faster speed, and expanded instruction set. Another interesting development is the INTEL announcement of a microprocessor designed specifically for digital signal processing. Unfortunately, preliminary information indicates that this will have only a 9-bit input word width and will thus only be marginally adequate for some professional audio applications. For the reasonable future the bit-slice processor seems like the most economical way to go. Incidentally, there is obviously much more to the subject of architecture than selecting processors and connecting them to delays and multipliers. There's just as obviously not nearly enough room in this article for even a beginning.

Now that we've had a glimpse of how a digital processor might be put together, let's consider some applications. We mentioned compression and equalization earlier. We will also consider one of the more common digital processor applications; pitch changing.

## DIGITAL COMPRESSION

Compression, limiting, gating or what-have-you, can be characterized simply: the amplitude of the signal is measured and the result of this measurement is used to modify

the amplitude of the signal. The electronic circuitry which accomplishes this effect normally comprises a rectifier (either peak or envelope, depending upon whether compression or limiting is desired) and a variable gain stage such as a lamp/photo-cell combination or a FET. As the signal level increases, the lamp gets brighter, the photo-cell resistance gets smaller, and the signal is attenuated. This normally is done in a closed loop, so that as the signal gets lower, the photo-cell gets less drive, and the signal is attenuated less. An advantage of this technique is that it is simple. Precise gain control circuitry is not necessary because the process employs a good deal of negative feedback. A more versatile but far more critical method is to employ a logarithmic detector and logarithmic gain control amplifier so that the output of the level detector can be applied with any gain and polarity to the level control circuit. This permits a continuous variation of the compression (or expansion) ratio, even to "dynamic reversal," where a larger input signal is reduced in output below the level of a smaller one.

A limitation of these devices is that they cannot handle pulsed waveforms gracefully. If the time constant is set for limiting so that a signal beyond a given amplitude must be instantaneously squished, implying an attack time of 1 to 100 microseconds, gain change is so rapid as to cause high levels of distortion. Slower time constants will let initial transients through. Although one solution frequently used is fast attack and slow decay, this isn't entirely satisfactory, as it can cause "pumping" on signals with sharp transients but otherwise non-uniform levels.

An ideal solution would be to combine several of the digital elements discussed earlier. The signal would first be applied to a delay, and would simultaneously be "detected" by looking at the input bit pattern to the delay line. Following the delay line would be a multiplier, whose second input would be a gain control signal derived from the input level "detector." Both the detector and multiplier are inherently high-precision devices, and the time the signal spends going through the delay could be employed by using a computation unit to determine the proper gain profile for the output multiplier to apply to the delayed signal. A microprocessor might well be fast enough for this application, since it only has to deal with the signal envelope, not the signal itself. While this configuration is obviously not as economical as a simple analog one, the basic circuitry could handle multiple channels simultaneously.

Thus a single control section could compress, limit, or what-have-you a stereo or quad signal with almost the same facility as a mono one. There would be no problem with image shifting or gain mis-tracking, since level and delay are inherently controlled to an accuracy far beyond the limit of discernment.

In case the above seems simple and you're now wondering why there aren't bunches of these on the market, it's because the argument is simple but the realization is not. One of the major questions is exactly what form the gain control contour should take before, during, and after the transient reaches the multiplier. There is no one obvious answer and because "pre-limiting" simulates no natural phenomenon, almost any realization is likely to sound "unnatural," which is frequently equated with "bad," and may well be.

## DIGITAL EQUALIZATION

Another common studio operation is equalization or filtering. Confronted with a digital signal—nothing but a series of numbers—how can we perform an operation analogous to, say, analog low-pass filtering? Let's try an experiment: examine the following signal (sequence) 2, 9, 7, 5, 2, 6, 4, 8, 0.

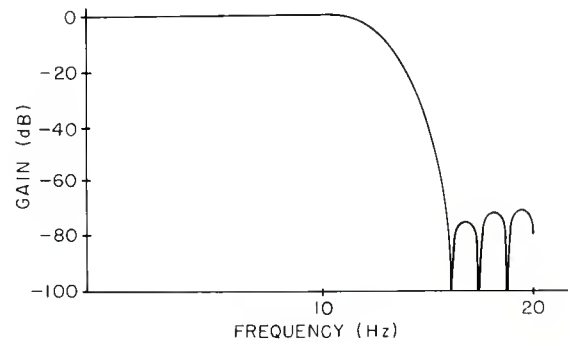

Figure 4. Frequency response of a 32-tap low-pass filter.

Note that the difference between consecutive samples ranges from 1 to 8. The larger inter-sample differences are indicative of a high frequency component. Using only the arithmetic operations of addition and multiplication, we would like to eliminate these high frequency components. So, let's play "digital filter": add the values of the first, second, and third samples, multiply the sum by one third, and record the result. Repeat this procedure for the second, third, and fourth samples, and so on. Your results should look something like this:  
6, 7,  $4\frac{2}{3}$ ,  $4\frac{1}{3}$ , 4, 6, 4.

## INTRODUCING THE ALGORITHM

Notice that the greatest difference is now only  $2\frac{1}{3}$ . Those rapid variations in amplitude are gone. In fact, the signal has been low-pass filtered. We should note that this filtering was accomplished by a repeated sequence of elementary operations. Such a sequence, in the jargon of DSP, is called an algorithm. In this example each sample value was utilized in the computation of three output samples. This illustrates the requirement for storage in signal processing.

FIGURE 1 is a block diagram of how this algorithm might be implemented digitally. Three consecutive samples are added and the sum is multiplied by  $\frac{1}{3}$  at A. In practice, however, a more general and versatile form of this filter is employed (see FIGURE 2). If each of the three multipliers (A1, A2, A3) is set equal to  $\frac{1}{3}$ , it should be evident that this filter is equivalent to the one shown in FIGURE 1. However, the structure of FIGURE 2 is preferred, because it allows the individual tap multipliers, called coefficients, to be selected independently. The greater the number of taps employed, the more control one has over the characteristics of the filter. The name given to this class of tapped-delay filter is "non-recursive, finite-impulse, linear-phase response." FIGURE 3(A) shows a first-order, non-recursive filter, while FIGURE 3(B) demonstrates the effect of varying the coefficient of the filter multiplier, A. Not surprisingly, a single tap doesn't result in impressive performance. However, if enough taps are used, and the coefficients are correctly chosen, any arbitrary frequency response may be realized. FIGURE 4 is an example of the type of response possible using only 32 taps. Although the response is nifty, an awful lot of operations are required to obtain it. Take heart: there is a more-efficient method.

If the signal is fed back around the delay line, a more frequency-selective (higher Q) filter results. Once again, delay, addition and multiplication are all that are needed. As shown in FIGURE 5, the frequency response varies with the value of the feedback coefficient, B. The most-widely-used form of digital filter employs a combination of feed-

forward and feedback coefficients. This is an extremely-versatile second-order structure analogous to the general-purpose analog second-order active filter. Examples of second-order analog and digital filters are shown in FIGURE 6. Higher-order filters are formed by cascading second-order sections in both analog and digital processors.

By now you are wondering "Why go?" to all this trouble, if you can do the same thing with a few op-amps. One reason is the precision of which digital circuitry is capable. Many analog filters require one per cent components—frequently difficult to obtain. But small fractional per cent precision is easy to obtain digitally, allowing many sections to be cascaded for sharp response. Digital filters are immune to temperature-induced drift, and their frequency response may be easily varied, simply by changing clock frequencies instead of changing a host of analog element values. Finally, it is usually possible to generate several filters from one set of hardware. Although studio filtering requirements are not usually as severe as those encountered in other disciplines, such as communications, the versatility and protean quality of the digital filter makes it a natural to replace parametrics and other equalizers, once the cost of the hardware is reduced by another order of magnitude.

### PITCH CHANGE

One increasingly-familiar effect is that of "pitch change"; a multiplication of every frequency component of the input signal by a constant. This constant defines the "pitch ratio," which for most practical applications is between 0.5 and 2.0 (corresponding to an octave down and an octave up). The natural process most akin to pitch changing is "doppler shift," in which pitch changes in a manner proportional to the relative velocities of the source and listener. Pitch change should not be confused with "frequency

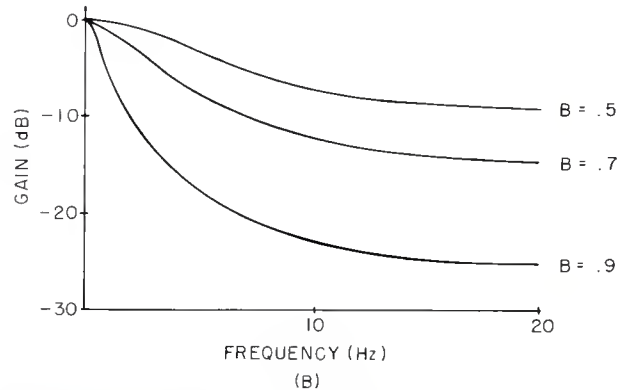
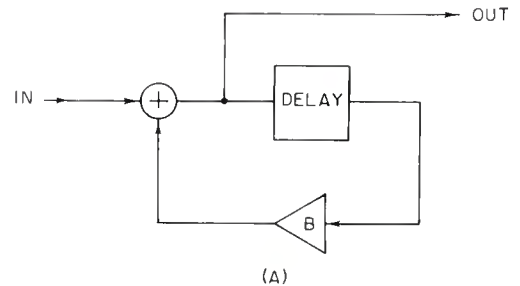

Figure 5. A first-order, recursive filter  
(A) Block diagram.  
(B) Frequency response.

shifting"—an effect achieved quite easily by analog or digital means—which adds a fixed frequency to all components of the original signal. Frequency shifting ("ring modulation") creates disharmonies by the modification of the spacing between fundamental and harmonics. As an example, if the fundamental of the original signal is at 1000 Hz, the second harmonic would be 2000 Hz. Multiplying both frequencies by any constant preserves the relationships (i.e. a ratio of 1.1 gives 1100 and 2200 Hz.) Adding 100 Hz to both gives 1100 and 2100, which are no longer harmonically related.

Using digital techniques to change pitch can employ one of two general processes. The first is an analysis/synthesis process, in which the input signal is filtered into many very-close bands (using a digital filtering algorithm called the "Fast Fourier Transform"). After this analysis is performed, the filter characteristics are changed to perform the desired pitch shift and the inverse transform is applied. Unfortunately, even with the current state of the art, this is an expensive and time-consuming process, and we know of no hardware realization of such a device capable of operating in real-time. Another method takes advantage of the analogy to doppler shift: if the input signal is stored at one rate and read out at another rate, the pitch varies by an amount equal to the ratio of the two rates. This would be a 100 per cent-effective solution, but for the splicing problem. A moment's reflection will point out that, if a signal is read in at one rate and out at another, eventually one will run out of (or overlap) input! Anyway, it would be unsatisfactory for another reason—if an unlimited amount of signal were available, changing read-out rate would not only change pitch but would change tempo as well. For this reason, a technique of "splicing" is universally employed, in which certain segments of signal are deleted or overlapped electronically. This leads to yet another problem; "splicing glitches." Real-world signals are extremely complex. Adding or subtracting time segments from music or speech can result (depending upon how it is done) in anything from extremely-annoying



Garner Audio Tape Erasers wipe tapes cleaner than new... with no noise residue. Simple, safe, continuous belt operation handles all sizes of reels, cartridges and cassettes. Several models: up to 16 inches. Also Video Erasers.

Garner Erasers are now fulfilling the exacting requirements of many major organizations around the world...yet are so low priced that the smallest studio or station can afford one.

User reports... "It is a big improvement over what we used to use, or anything else on the market today."

—Ric Hammond, KNX Radio (CBS), Hollywood, Calif.

Call today or write for brochure.



**GARNER INDUSTRIES**

Dept. db-5 4200 N. 48th St., Lincoln, NE 68504, Phone: 402-464-5911

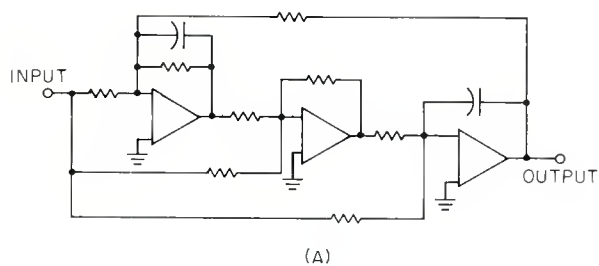

(A)

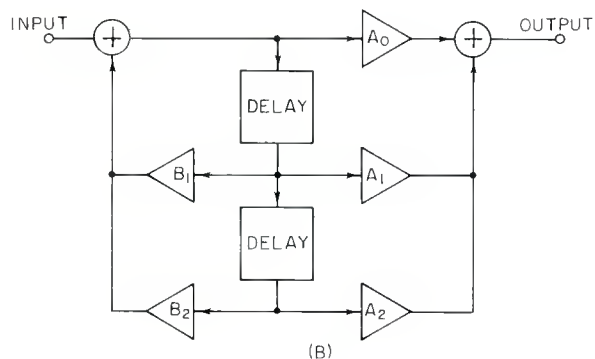

(B)

Figure 6. Second-order filters

(A) An analog filter.

(B) The digital equivalent.

clicks and pops, to an almost-unnoticeable change. The way these glitches are handled is itself governed by an algorithm, which may be simple or complex, and effective or ineffective, not necessarily one in relation to the other! Complicating the problem is the fact that an algorithm which may work perfectly for one type of signal is completely ineffective on another. As digital circuitry becomes more complex, one can expect the handling of these splicing glitches to become more effective, but never perfect. One recent improvement in this field employs a bit-slice architecture to determine operational characteristics. The new Eventide Harmonizer contains (programmed-in-replacable Read-Only Memory) two different splicing algorithms which are user-selectable. Taking advantage of recent developments in memory technology, the unit offers more delay, greater dynamic range, wider frequency response, and much greater control versatility for only a modest increase in price. Because of the extremely-high speed of the bit-slice processor, many decisions can be made during each sample period as to, for instance, the location, amplitude, and phase of the next signal sample. Other enhancements, such as stable control and readout of very small pitch ratios, are rendered possible.

## REVERBERATION

Possibly the most difficult problem facing the DSP people is the simulation of natural reverberant spaces. It is possible to fill many articles this size with just a description of the problems. The "solutions" would fill volumes.

Designing a digital reverb is a very desirable end of DSP. Unlike, for instance, the analog equalizer, which sits merrily in its little cabinet and behaves in a convenient and tractable manner, the quality of a reverb unit frequently seems proportional to its physical size. Frequently, one of the best ways to simulate a reverberant room is to use (you guessed it), a dedicated reverberant room! In addition to the problem of size, mechanical reverbs are sensitive to shock and vibration.

The reason it is so difficult to simulate a reverberant space digitally is the immense number of computations required to recreate the physical situation. A given room has at least four walls, a ceiling, and a floor. Let's say a pulse of sound is created in that room. A listener would hear the pulse, followed by its reflections from the various surfaces of the room. Each surface has its own reflection coefficient, which in turn is frequency-selective, depending upon the material covering the surface. Even this wouldn't be so bad, were it not for the problem that each reflection generates additional reflections from each of the room surfaces! In most rooms, the number of reflections becomes so high after several hundred milliseconds that an analytical attempt to simulate it becomes technologically impossible. At this point, psychoacoustics takes over, and the question becomes, "What kind of digital simulation is sufficiently convincing so that the simulator can be manufactured at a less-than-prohibitive price?" Several manufacturers have brought to market quite good-sounding units, and we can confidently predict that others are working on them. None of the good units are inexpensive, however, and it will be quite a while before we have "echo-on-a-chip."

In this article we have summarized some of the possibilities of digital signal processing (and completely ignored digital recording, a probably-more-important subject). While we don't have the "all-digital" studio yet, it can be reasonably foreseen that before too long, all the components will be available to make one, so that the only analog elements remaining will be the microphone and the speaker. Since these are the primary limitations of the recording process at present, we anxiously await the development of a standard digital I/O bus for the human element. ■

## YOUR "FISH SCALE" WAS DESIGNED TO WEIGH FISH!

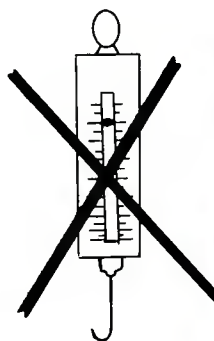

The Tentel tape tension gage is designed to diagnose problems in your magnetic tape equipment. Throw away your fish scales (or put them in your tackle box where they belong). The TENTELOMETER will measure tape tension while your transport is in operation, so you can "see" how your transport is handling your tape . . . smooth, proper tension for quality recording? or oscillating high or low tensions causing pitch problems, wow and flutter?

"See" what your heads "See" and HEAR the difference.

Tentel  
50 Curtner Avenue

(408) 377-6588  
Campbell CA 95008

Circle 38 on Reader Service Card

# Equalizers For Professional Recording Applications

*Equalizers—“three and four knob” modules, graphic, or parametric—a survey of design characteristics.*

AT THE CURRENT state-of-the-art, there are a number of practical techniques for achieving musically-useful equalization of audio program material. The state-of-the-art has changed greatly in the last twenty years: the old classical passive LC equalizers have given way to active devices, using transistors and integrated circuits. The advent of low-cost integrated circuit operational amplifiers, in particular, has resulted in a revolution in equalizer circuit design, and a dramatic improvement in the cost/performance ratio achievable.

The purpose of this article is to provide an overview of the different types of equalizers available today, and to clarify some of the important performance characteristics which can make or break an equalizer design. Hopefully, this information will help you determine which type of equalizer is the best one for your particular needs. We have tried to include enough basic material to inform the newcomer, and enough more-challenging material to provide some insight for the more experienced user.

We will be discussing four basic types of equalizers found in modern sound equipment: tone controls, “three knob” and “four knob” console equalizers, graphic equalizers, and parametric equalizers. Each equalizer function can be achieved electrically in various ways, each with associated compromises. Each technique has relative advantages and disadvantages in a given situation.

## BACK TO BASICS: TONE CONTROLS

The simplest form of equalizer found in professional use is the bass and treble tone control. While lack of flexibility and control limits usefulness, they have definite and often-unappreciated advantages over more elaborate equalizers.

Typically, tone controls are “shelving” equalizers with a maximum slope of 6 dB-per-octave, and “reciprocal” characteristics. What do we mean, exactly?

By shelving, we mean that the frequency response of the equalizer has a shape similar to FIGURE 1. The gain of a treble control starts out at 0 dB at low frequencies. Then it starts to slope upwards (or downwards, depending on whether you are boosting or cutting). Finally, it reaches a new level at some higher frequency, and stays there. It doesn't slope downward (or upward) again—at least not until the frequency is outside the audible range. The curve shape resembles a shelf—thus, “shelving.”

Because the electrical network which produces this curve is “first-order” (has only one capacitor or one inductor), the maximum rate at which the voltage gain can change is to double (or halve) every time the frequency doubles—a 6 dB-per-octave slope. Higher-order networks (containing more than one capacitor or inductor, or combination thereof) can produce steeper slopes, and more complicated curves.

One advantage of a first-order (6 dB-per-octave) response is that it can't ring under any circumstances. Ringing occurs when some higher-order networks are hit with transients. The transient forces the network to produce a tone, which may decay slowly or rapidly, depending on the degree of “damping” or the “Q.” This tone can cause nasty coloration of speech or music.

Finally, our tone control is reciprocal. This means that if we take two identical tone controls, connect them in series, and adjust one for a given amount of boost and the other for the same amount of cut, that the overall frequency response is flat, and square waves are not degraded by passage through both tone controls. The effect of the second control has entirely nullified the effect of the first.

Reciprocal curves are highly desirable in equalizers without adjustable bandwidth, because they permit an engineer to “undo” equalization that he may have performed when a track was originally cut. However, as we'll see later, reciprocal curves may not always be desirable.

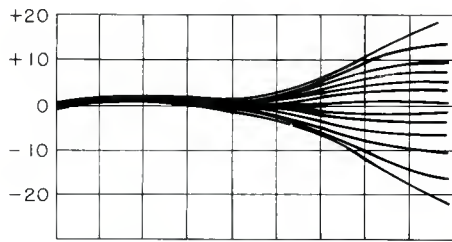

Figure 1. The frequency response of a treble tone control at various settings. Note the shelving shapes, and the fact that the curves are reciprocal: that is, the boost and cut responses are mirror images of each other.

## THE HARD FACTS ABOUT RINGING, PHASE, AND FREQUENCY RESPONSE

It is often heard in the studio that such-and-such equalizer sounds bad because it has phase shift or ringing. The subject is often treated like black magic. The truth is very simple: with one qualification (below), knowledge of either an equalizer's phase response, square wave response, or frequency response uniquely determines the other two characteristics. Therefore, if an equalizer is ringy, it means that the frequency response is excessively peaky, and that there is a rapid change in the phase response around the peak. Any other equalizer with the same frequency response will have the same phase shift and the same amount of ringing.

There are two qualifiers. First, the frequency response outside the audible range can have substantial effect on the phase shift and ringing inside the audible range. Just looking at one section of the frequency response isn't enough. Second, the equalizer must be "minimum phase." This is of little practical importance, since practically every equalizer is minimum phase, just because minimum phase circuits are simplest and least costly.

In general, it can be said that the ear is far more sensitive to the frequency response than to phase response, so that the shape of the frequency response curves that an equalizer produces are of paramount importance in determining its musical utility.

## "THREE KNOB" AND "FOUR KNOB" CONSOLE EQUALIZERS

The next most complex equalizers found in contemporary studio practice are so-called "three knob" and "four knob" equalizers. These equalizers, true to their name, have either three or four sections of equalization. The highest and lowest frequency ranges are often switchable between shelving and peaking response.

A peaking response is produced by a second-order network, and is generally the most musically-useful equalizer response because it is capable of far more selectivity over the frequency range it affects when compared to a first-order shelving equalizer. But this selectivity is not without its drawbacks. If too much selectivity (too narrow a bandwidth) is attempted, the equalizer will ring, and can intro-

The Orban model 622B—a representative example of a parametric equalizer.



duce bizarre and highly unpleasant coloration into the signal. Therefore, the peaking equalizer must be used with more care and taste than the shelving equalizer. In addition, if the bandwidth is not user-adjustable, then the manufacturer must be trusted to provide musically useful characteristics at all degrees of boost or cut. Too often, the same circuitry used to produce reciprocal curves also results in an increasingly sharply peaked frequency response, as equalization is increased towards maximum boost. This can make large peak boosts musically intolerable. This tends to be less of a problem in those "three-knob" etc. equalizers which employ stepped switches to determine the amount of peak or boost, and more of a problem in those equalizers with continuously-variable adjustment. In addition, nearly all such equalizers provide switches in several of the equalization sections to vary the frequency at which the maximum equalization occurs. This switching is in discrete steps. The shape of the equalization curve usually stays constant as these switches are operated, and varies only in frequency.

Certain "three-knob" equalizers also provide switchable lowpass and highpass filters. These filters sharply discriminate between frequencies in the "passband" (perhaps 100 Hz to 8 kHz), and frequencies in the "stopband" (perhaps above 8 kHz or below 100 Hz), rolling off stopband frequencies at a rate of 12 dB-per-octave or greater. They are useful for noise reduction in cases where the dominant frequency of a sound being recorded lies in the passband, and interference exists in the stopband.

## GRAPHIC EQUALIZERS

A graphic equalizer provides a series of peaking equalizers whose center frequencies are equally spaced according to musical intervals. Therefore, an "octave band" graphic equalizer might have eleven equalization controls spaced at octave intervals: 20, 40, 80, 160, 320, 640, 1.25k, 5k, 10k, and 20 kHz for example. The equalization controls for the various bands are usually linear slide controls, and are arranged side-by-side. Therefore, the physical positions of the controls gives a rough approximation of the actual frequency response of the overall equalizer—thus "graphic."

Note that we said rough. The graphic's controls are almost invariably reciprocal, and graphic equalizers seem particularly prone to the problem of excess ringing due to narrow bandwidth, when large amounts of peak boost are used. While it is possible to minimize this sort of behavior by careful design, the most inexpensive graphic equalizer circuits are particularly prone to it. The practical result is that it is not possible, with many graphics, to obtain broadband boosts of more than 6-7 dB. Beyond this, the responses of the individual equalizers which must be boosted in tandem to obtain the broadband response begin to peak excessively, and the curve becomes uneven ("ripply"), eventually becoming intolerably colored and ringy.

Graphic equalizers are manufactured commercially with bandwidths as wide as two octaves, and as narrow as one-third octave. Octave-wide bandwidths seem most accepted

The Orban model 672A, a quasi-parametric equalizer.

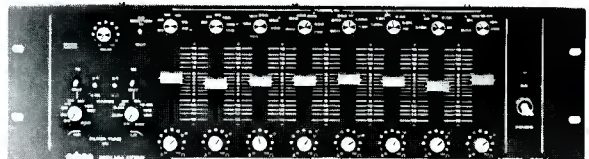

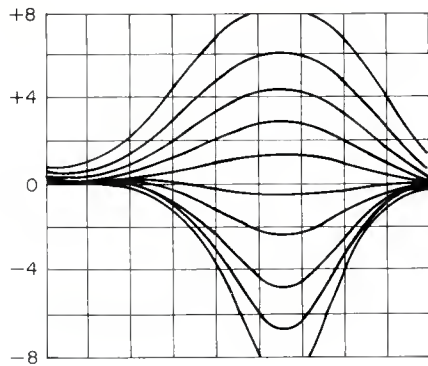

(A)

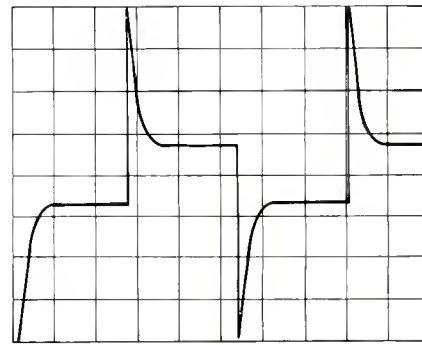

(B)

Figure 2. (A) A set of frequency response curves for a constant-Q equalizer with a Q of 0.29. Note that the affected portion of the frequency spectrum is greatest at the maximum-boost position, and continuously decreases as the equalization is moved towards maximum cut. This characteristic tends to produce an equalization effect whose tolerability to the ear remains

relatively constant as the amount of boost/cut is varied. (B) The equalizer's square-wave output for a 12 dB boost. Note that the very low Q of 0.29 produces a very large overshoot, and that it takes a relatively long time for the overshoot to decay to the final level. However, no ringing is present.

for equalization "by ear." One-third octave graphics are utilized to correct frequency response of loudspeakers, and to a certain extent, of rooms. They are particularly useful in sound reinforcement, where flattening the frequency response of the entire sound system can result in striking gains in intelligibility, and in the availability of far more gain before feedback than would be the case where the system unequalized. In addition, very narrow-band notch filters are sometimes utilized in sound reinforcement systems to damp "ring modes," which are narrow bands of frequency where the gain of the sound reinforcement system is too high, and where feedback would otherwise occur.

It is generally considered impractical to adjust one-third octave graphic equalizers by ear, and it is therefore customarily done with a "real-time analyzer." This instrument provides an approximate measure of the acoustical frequency response of an entire sound system, averaged over one-third octave intervals. Because the frequency response is read out graphically, and updated practically continuously, it is easy to adjust a one-third octave graphic equalizer to secure the desired frequency response. However, these instruments are not foolproof, as they can be fooled by unfavorable acoustics, and a practiced ear is still the final judge of the success of a system's equalization. The

equalizers used in a one-third octave graphic are particularly prone to ringing, and it is often necessary to perform rough equalization using wider bandwidth equalizers (even tone controls!), and then perform the final detailed trimming with the third-octave graphic, using minimum amounts of equalization.

There are two varieties of third-octave graphics. One type provides both boost and attenuation, while the other type provides attenuation only. The attenuation-only type is favored by many practitioners because its broadband curves tend to be smoother than the boost/attenuate type.

#### BANDWIDTH AND "Q"

A second-order equalization curve can be described by three parameters:

1. The maximum amount of boost (or dip) in dB;
2. The frequency at which the maximum amount of boost (or dip) occurs (in Hz);
3. The "bandwidth," which defines the shape of the equalization curve. The "bandwidth," as used here, has no precise engineering meaning, but is related to the "Q" of the circuit. The meaning of "Q" is well-defined. ( $Q = \frac{\text{The ratio of the center frequency to the bandwidth at the half-power } [-3 \text{ dB}] \text{ points—Ed.}$ ) Most generally, it determines the speed with which the ringing in a circuit is

Figure 3. (A) A set of frequency response curves for a constant-Q equalizer with a Q of 0.5. (B) The equalizer's square-wave output for a 12 dB boost. Note that the overshoot decays much faster than

in Figure 2(B), but there is still no ringing. (C) With a Q of 1.0, the overshoot again decreases, but now ringing is visible. However, it is rapidly damped out, and would not tend to be audible.

(A)

(B)

(C)

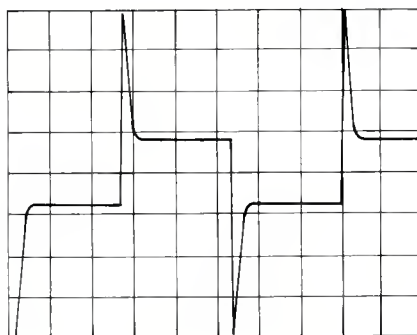
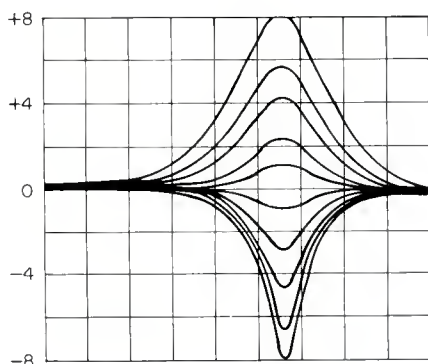



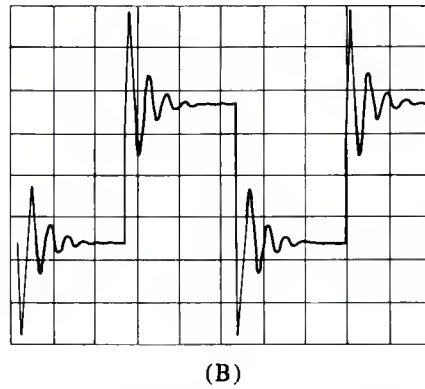
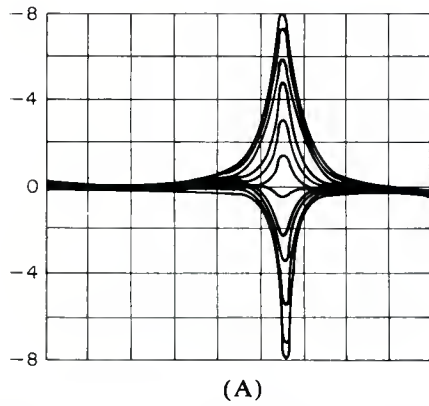

Figure 4. (A) A set of frequency response curves for a constant-Q equalizer with a Q of 3.2. Curves with such a narrow bandwidth tend to cause objectionable coloration when used in the boost mode, and are useful only for special effects, such as telephone filters or simulation of old-time recordings. However, in the cut (or "notch") mode, such curves are useful for filtering

out hum, camera whine, etc., with negligible effect on the overall sound quality.

(B) The equalizer's square wave output for a 12 dB boost. Again, the overshoot is decreased, but the ringing takes a much longer time to damp out, and would tend to be audible in the boost mode.

damped out. As the "Q" increases beyond 0.5, the ringing hangs on for more and more cycles and becomes narrower and narrower. At  $Q=0.5$ , the circuit no longer rings, and is said to be "critically damped." As the "Q" goes below 0.5, the bandwidth continues to increase, with no ringing. The shape of the peaking curve approaches a flat top with skirts falling at 6 dB-per-octave—like a pair of tone control shelving responses.

### PARAMETRIC EQUALIZERS

In general, the term "Parametric Equalizer" means what an individual manufacturer wants it to mean. It tends to imply that the center frequency is continuously adjustable, rather than switchable in steps. Some control over the bandwidth or "Q" is provided, although some manufacturers provide only two discrete choices of bandwidth, rather than making the bandwidth continuously variable. Finally, the amount of boost or cut is usually continuously variable, rather than stepped. Some parametric equalizers provide independent and non-interacting control over all three parameters. It can be shown that in order to provide constant "Q" as the equalization control is varied, that the

peaking and dipping curves are not reciprocal. However, because the curves are all second-order, reciprocal curves are easily generated by readjusting the bandwidth control, if such curves are desired.

The "constant Q" characteristic in both peaking and dipping modes is prompted by musical and practical considerations. The reciprocal circuit most often used increases the "Q" as the amount of boost is increased. Therefore, equalization extremes become extremely colored and ringy. In contrast, if the "Q" of the equalizer remains constant, it reduces or eliminates the need to readjust the bandwidth control as equalization is increased.

The constant "Q" characteristic has several other advantages. First, it is possible to provide an infinite depth notch, which is invaluable in removing interference of fixed pitch, such as hum or camera sprocket noise. Second, the utility of the infinite depth notch is augmented by the fact that the constant "Q" characteristic results in wider peaking curves than dipping curves, thus permitting a notch to be introduced with negligible effect on most sound passed through the equalizer. On the other hand, the widest bandwidth (minimum "Q") results in very gentle, totally

Figure 5. (A) A set of reciprocal (non-constant-Q) frequency response curves. The curve shape tends to become "peaky," and the bandwidth increasingly narrow as the boost is increased. Compare these curves with the constant-Q family seen in Figure 3(A). (B) The reciprocal equalizer's square-wave output for a 10 dB boost. Note the large amount of ringing, and

the time it takes for the ringing to damp out.

(C) The square-wave output for a 5 dB boost. The ringing damps out much faster, indicating that the Q has been lowered. While the ringing seen in Figure 5(B) would tend to be audibly offensive, the curve in this figure would probably be acceptable.

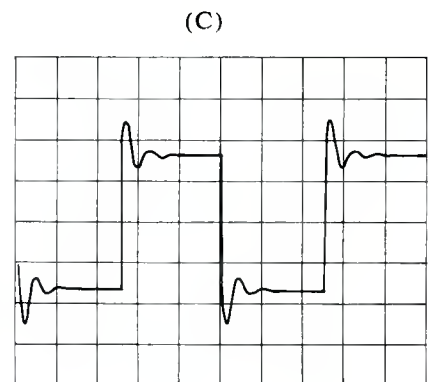
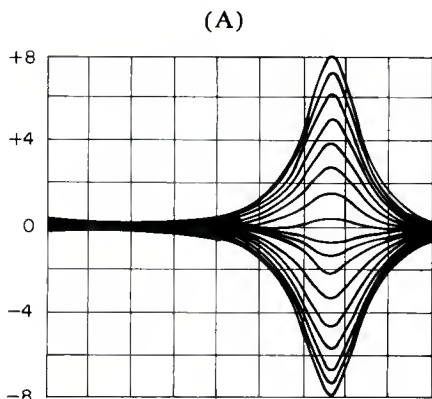

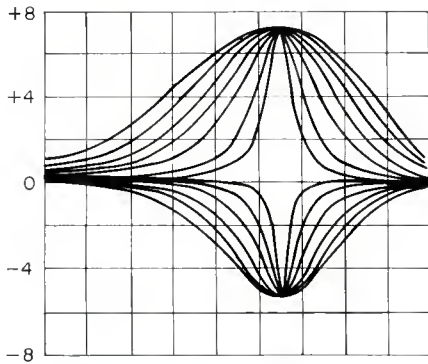

Figure 6. The frequency response of an Orban parametric equalizer for one peak setting, and one dip setting of the equalization control, as the bandwidth control is varied. The gain at the maximum peak (or dip) remains constant, and the skirts of the curves move in and out.

non-ringing peak equalization, which can be as subtle and innocuous as simple tone controls, with the added advantage of continuously variable control over the frequency at which the control begins to act. Attempts to get the same effect with a graphic equalizer are doomed to failure, as the graphic equalizer's simulation of the curve consists of a large number of higher-"Q," ringy peaks.

Orban prefers to use a series connection of its parametric equalization sections—each section is cascaded with the next. Most graphics use a parallel connection. Parallel connections raise the possibility of interaction between ad-

acent bands because of phase additions and cancellations around the skirts of the individual bands' curves. In the series connection, such interactions are totally absent: the total equalization is simply the sum (in dB) of the equalization contributed to each of the sections.

The parametric is highly useful in sound reinforcement work, as the notches can be exactly tuned to the desired frequencies to suppress feedback. A useful variation is the use of a dual-channel parametric equalizer with both sections cascaded: one section providing broadband equalization to correct the "sound" of the system, and the other section providing narrowband notches to suppress feedback.

#### QUASI-PARAMETRIC EQUALIZERS

The Quasi-Parametric equalizer, like the true parametric, provides control over bandwidth, center frequency, and amount of peak or dip. However, unlike the true parametric, in quasi-parametrics, these parameters can interact. In particular, changing the tuning and/or changing the amount of peak or dip will also cause a change in the "Q." Orban quasi-parametric equalizers provide reciprocal curves which are carefully controlled so that the "Q" does not change in "peak" mode (although as it must, the "Q" does change in "dip" mode).

The reason for providing quasi-parametric characteristics is simple—they are considerably less costly to provide than true parametric characteristics. The user trades the convenience of true parametric operation for substantially lower cost per channel of equalization. Also, because the user still has control over all three parameters, he can eventually obtain the same curves and same flexibility as with a true parametric—he just has to work harder. The only exception to this is that infinite-depth notches are not available because of the reciprocal characteristics. ■

# Split Second Time Machine

The Telex/Magnecord 1400 recorder. Split second timing with a grid of 524 lines passing a quartz crystal control reference each capstan revolution. This senses, and corrects, the speed of the DC servo drive some 4000 times per second\*. Speed stability is so accurate the National Weather and the Environmental Satellite Services selected Telex/Magnecord 1400's over all others to record meteorological display data.

Of course, broadcasters also favor the 1400 for the rugged stability of the die cast main frame, DTL logic and exceptionally clean electronics. Compare our speed, specs, and price. We invite you to make a split second decision.

\*At 7½ ips, adjustable ± 1% to compensate for tape thicknesses and mechanical wear.

**TELEX**  
COMMUNICATIONS, INC.

9600 ALDRICH AVE. SO. • MINNEAPOLIS, MINN. 55420 U.S.A.  
Europe: 22 rue de la Legion d'honneur, 93200 St. Denis, France  
Canada: Tetak Electronics, Ltd., Scarborough, Ontario

Circle 46 on Reader Service Card

# Designing A Notch Filter With A Programmable Calculator

*With a little help from his HP-67 calculator, Dr. Hayes shows us how to design a notch filter.*

WHEN IT BECOMES NECESSARY to null out some undesired frequency, it's hard to beat the standard bridged-T notch filter. Stray pickup on long phone lines often brings with it some strange hums, buzzes and whistles. By using a filter such as illustrated in FIGURE 1, any single frequency can be pretty-well notched out of the audio spectrum.

The conditions for the null are:  $2X_C = X_L$ , and

$$R = \frac{X_L Q}{4}$$

$X_C$  = the capacitive reactance of each capacitor.

$X_L$  = the inductive reactance of the coil.

$Q$  = the  $Q$  of the coil.

However, since the user normally asks for a null at a specific frequency, and the coil is the hardest component to find at a specific value, the problem is usually to find out what values of  $R$  &  $C$  will make a null network with whatever coil is at hand. For this state of affairs, the design formulas are:

$$C = \frac{1}{2\pi^2 f^2 L} \text{ and } R = \frac{\pi f L Q}{2}$$

$$\text{Now, since } Q = \frac{2\pi f L}{R_L}, \text{ therefore, } R = \frac{(\pi f L)^2}{R_L}$$

$C$ ,  $L$ , and  $R$  are in farads, henries, and ohms, while  $R_L$  is the d.c. resistance of the coil, also measured in ohms.

These relationships lend themselves readily to implementing on a programmable pocket calculator, which makes the task of identifying which of a series of available inductors comes up with the most practical values of  $R$  and  $C$  in a given case. It would take several minutes to make each calculation by hand, and less than five seconds for each one on the calculator.

Table 1 is a 51-step program which has been written for the Hewlett-Packard HP-67 calculator. It can be stored on a recorded magnetic card, so as to be readily available any time a bridged-T filter design is required.

Figure 1. The bridged-T Notch Filter. One of the simplest, and still one of the best, ways to introduce a null into a pass-band.

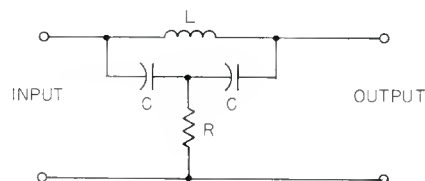

Table 1—The program for the bridged-T notch filter, run on an HP-67 programmable calculator. It can be slightly condensed for use on the HP-25 by eliminating steps 014, 030 and 045, which are included for programming convenience only.

001	f LBL A	enter first input (=f)
002	STO 1	store f in register 1
003	h RTN	continue program—stand by to
004	f LBL B	enter next input (=L)
005	STO 2	store L in 2
006	h RTN	continue program—standby to
007	f LBL C	enter next input (=R <sub>L</sub> )
008	STO 3	store R <sub>L</sub> in 3
009	h SF 3	set flag (see text)
010	E	skip to 015, or,
011	f LBL D	enter next input (=Q)
012	h CF 3	clear flag (see text)
013	STO 4	store Q in 4
014	E	
015	f LBL E	continue program
016	RCL 1	recall 1 (=f)
017	g X <sup>2</sup>	square f (=f <sup>2</sup> )
018	h π	enter π
019	g X <sup>2</sup>	square π (=π <sup>2</sup> )
020	×	multiply f <sup>2</sup> by π <sup>2</sup>
021	2	enter 2
022	×	multiply f <sup>2</sup> π <sup>2</sup> by 2
023	RCL 2	recall 2 (=L)
024	×	multiply 2f <sup>2</sup> π <sup>2</sup> by L
025	h 1/X	1/2f <sup>2</sup> π <sup>2</sup>
026	EEX	see text
027	6	
028	×	
029	DSP 4	
030	STO 5	
031	R/S	
032	RCL 2	recall 2 (=L)
033	h π	enter π
034	×	multiply L by π
035	RCL 1	recall 1 (=f)
036	×	multiply Lπ by f (i.e., πfL)
037	h F? 3	is Flag 3 set? If no, then skip 038
038	GTO 1	go to LBL 1 (@ 047)
039	RCL 4	recall 4 (=Q)
040	×	multiply πfL by Q
041	2	enter 2
042	÷	πfLQ/2 (=R)
043	LBL 2	
044	DSP 1	display R
045	STO 6	store R in 6
046	R/S	run/stop
047	LBL 1	πfL
048	g X <sup>2</sup>	(πfL) <sup>2</sup>
049	RCL 3	recall 3 (=R <sub>L</sub> )
050	÷	(πfL) <sup>2</sup> /R <sub>L</sub> (=R)
051	GTO 2	go to 043 and display R

### PROGRAM ANALYSIS

Let's say we wish to remove a certain troublesome frequency, *f*. In the program, steps 001-002 store the value of *f* in register 1. Similarly, 004-005 store the value of *L* in register 2. If it is known, the value of the inductor's series resistance is stored in register 3, using steps 007-008, and then, 009 "sets" Flag 3. This "flag" informs the pro-

gram that a value for *R<sub>L</sub>* has been entered. On the other hand, if the *Q* of the coil is known, 011-014 stores this value in register 4. In this case, 012 "clears" Flag 3, to indicate that the formula using *Q* (rather than the one involving *R<sub>L</sub>*), will be used to calculate *R*.

$$\text{Steps 015-025 solve } C = \frac{1}{2\pi^2 f^2 L}$$

026-031 convert *C* to microfarads, set the display to show a four-decimal-place value, and halt the calculation to display the desired value of *C*.

032-036 calculate the value of π*fL* (actually, *Lπf*), which is used as part of the computation of *R*. 037 tests to see if Flag 3 is set or cleared, to make a determination as to which formula for *R* will be used. If the flag is set, 038 directs the program to branch to 047-050, where we calculate

$$R = \frac{(\pi f L)^2}{R_L}$$

The program then returns this value to 043 for display. However, if the check at 037 had shown that the flag was *not* set, the calculator would skip over 038, and then 039-042 would calculate the value of *R* from the formula:

$$R = \frac{\pi f L Q}{2}$$

In either case, 044-046 sets and displays the value of *R* to one decimal place.

It should be noted that normally either *R<sub>L</sub>* or *Q* will be known, but not both. If both values do happen to be known, the chances are that the value of *Q* will have been measured in the audio range, and the use of *Q* (rather than *R<sub>L</sub>*, which can be measured with an ohmmeter) will yield a slightly-deeper null.

As an illustration of the program, it is desired to null out an interfering signal of 1020 Hz. A 0.088 toroid coil with a d.c. resistance of 15 ohms happens to be lying about. What values of *C* and *R* will we need to fashion the notch filter?

After entering the pre-recorded magnetic card containing the program, the notch frequency is entered as 1020, A. Next, the inductance is entered as .088, B. The coil resistance is 15, C. At this point, the answer, 0.5533 (microfarads) is displayed. Since this is not an unreasonable

Figure 2. A parallel-T Notch Filter—no inductors required.

$$R = \sqrt{2R_{GEN}R_L}$$

$$C = \frac{1}{2\pi f R}$$

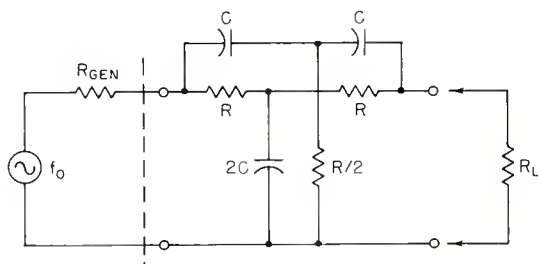

value for a capacitor, the value of R is computed by pressing R/S. The resultant display is 5301.2 (ohms)—also not an unreasonable value. Obviously, no 5301.2-ohm resistor is going to be available, but it's usually no problem to get close enough to the required value with two stock resistors in series.

#### FILTERING WITHOUT COILS

No inductors in sight? Then with a basketful of resistors and capacitors in hand, we can re-design the notch filter, as shown in FIGURE 2. In the illustration,  $R_{GEN}$  is the source resistance of the interfering signal—say, a 600-ohm phone line—and  $R_L$  is the load into which we're working, which is a 72-ohm video modulation input terminal. The frequency of the offending tone again turns out to be 1020 Hz, and we want to come up with the proper R and C values to clean up the signal.

The program is given in Table II—this time without explanatory remarks in the table. Try deciphering it yourself, before reading the program analysis.

Table II—The program for calculating R and C for the parallel-T notch filter shown in Figure 2.

001	f LBL A	015	×
002	2	016	f √X
003	×	017	DSP 1
004	h π	018	R/S
005	×	019	f LBL E
006	STO 1	020	RCL 1
007	h RTN	021	×
008	f LBL B	022	h 1/X
009	h RTN	023	EEX
010	f LBL C	024	6
011	h RTN	025	×
012	f LBL D	026	DSP 4
013	×	027	R/S
014	2		

#### PROGRAM ANALYSIS

As in the earlier program, we begin by keying in the offending frequency, followed by the letter, A. Steps 002-006 multiply f by  $2\pi$ , and store this value in register 1. Step 007 instructs the calculator to continue the program. Now, we enter the values of  $R_{GEN}$  (600, B) and  $R_L$  (72, C).

So far, no operations have taken place, but the two resistance values are stacked in the input registers of the calculator. To initiate the calculation of the value of R required for the notch filter, we press D, and at step 013, the calculator multiplies  $R_{GEN}$  by  $R_L$ . In steps 014-018, this product is multiplied by 2, the square root is found, and the calculator displays the calculated value of R, rounded-off to one decimal point. The correct answer is 293.9 ohms.

After noting the value of R, we initiate the calculation of the capacitance by pressing E. This brings us to 020, where the value of  $2\pi f$  is recalled. Next, this is multiplied by the value of R that we recently calculated (293.9 ohms). Now, the reciprocal is found ( $1/2\pi fR$ ) and this value is multiplied by  $10^6$  to convert from farads to microfarads. By now, the calculator (and hopefully, the reader), is at 026, where the value of C is displayed to four decimal places. The display should read 0.5308 (microfarads).

In assembling the notch filter, take care to note that the shunt capacitance is about 1.06 microfarads, and the series capacitors are about 0.53 microfarads each. The series resistors can be selected from stock values in the 5-percent range (say, 300 ohms) and the 147-ohm value needed for the shunt resistance should be found in a batch of 150-ohm units. ■

## A NEW STANDARD IN MONITOR EQUALIZERS...

# 1/6 OCTAVE

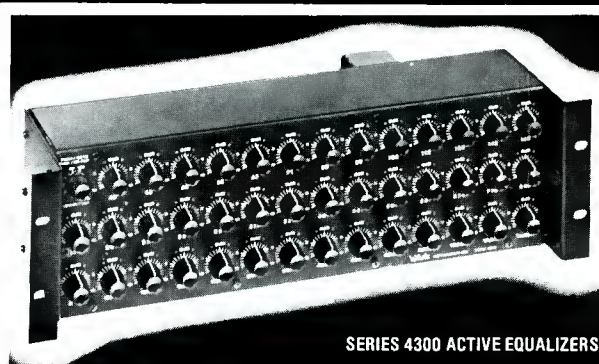

#### FEATURES

- 28 ONE-SIXTH octave bands from 40 Hz through 894 Hz on and between I.S.O. one-third octave centers
- 13 one-third octave bands from 1000 Hz through 16 kHz on I.S.O. centers.
- 10 dB boost or cut on continuous, calibrated, Mil-Spec controls
- Equal Q in both boost and cut conditions
- Precision inductors in magnetically shielded enclosures for maximum hum rejection
- Accessory socket to permit insertion of 12 dB/octave or 18 dB/octave low-level crossover networks for **bi-amping** or **tri-amping**
- Mid and high frequency output trimmers accessible from front panel
- Noise guaranteed — 90 dBv or better
- Input attenuation control variable to 20 dB of attenuation accessible from front panel
- Variable high-pass filter 20 Hz through 160 Hz, 12 dB/octave
- Security cover

ONE SIXTH OCTAVE REAL TIME ANALYZERS AVAILABLE

# White

instruments incorporated

P.O. BOX 698 AUSTIN, TEXAS 78767 • 512/892-0752

## Directory of Signal Processing Manufacturers

**Altec Lansing International**  
1515 South Manchester Avenue  
Anaheim, California 92803  
(714) 774-2900  
Equalizer, Limiter, Delay Systems

**Ashley Audio**  
1099 Jay Street  
Rochester, New York 14611  
(716) 328-9560  
Limiters  
Equalizers, Compressor/Limiter

**Audio & Design Recording**  
P.O. Box 902  
Marina, California 93933  
(408) 372-9036  
Equalizers, Compressor/Limiter,  
Noise Filter, Expander

**Audio Machinery**  
Sound Workshop Professional Audio  
Products, Inc. (Distributor)  
1324 Motor Parkway  
Hauppauge, New York 11787  
(516) 582-6210  
Digital Signal Processing System

**Automated Processes, Inc.**  
790 Park Avenue  
Huntington, New York 11743  
(516) 427-6024  
Equalizers, Compressor/Limiter

**Bode Sound Co.**  
1344 Abington Place  
North Tonawanda, New York 14120  
(716) 692-1670  
Vocoder, Feedback Stabilizer

**Bogen**  
P.O. Box 500  
Paramus, New Jersey 07652  
(201) 343-5700  
Equalizers

**Crown International**  
1718 West Mishawaka Road  
Elkhart, Indiana 46514  
(219) 294-5571  
Equalizer

**dbx, Incorporated**  
71 Chapel Street  
Newton, Massachusetts 02195  
(617) 964-3210  
Noise Reduction, Compressor/Limiter

**DeltaLab Research, Inc.**  
25 Drum Hill Road  
Chelmsford, Massachusetts 01824  
(617) 453-7551  
Digital Delay Systems

**Dolby Laboratories, Inc.**  
731 Sansome Street  
San Francisco, California 94111  
(415) 392-0300  
Noise Reduction Units

**Dukane Corporation**  
2900 Dukane Drive  
St. Charles, Illinois 60174  
(312) 584-2300  
Dynamic Range Limiter

**Dynacord Electronics, Inc.**  
P.O. Box 26 038  
Philadelphia, Pennsylvania 19128  
(215) 482-4992  
Digital Delay System

**EMT**  
Gotham Audio Corp. (Distributor)  
741 Washington Street  
New York, New York 10014  
(212) 741-7411  
Reverberation Units,  
Limiter/Compressor/Expander Units

**Eventide Clockworks, Inc.**  
265 West 54th Street  
New York, New York 10019  
(212) 581-9290  
Digital Delay Systems

**Furman Sound, Inc.**  
616 Canal Street  
San Rafael, California 94901  
(415) 456-6766  
Equalizer

**Heil Sound System**  
2 Heil Industrial Boulevard  
Marissa, Illinois 62257  
(618) 295-3000  
Equalizer

**Industrial Research Products, Inc.**  
321 Bond Street  
Elk Grove Village, Illinois 60007  
(312) 439-3600  
Digital Delay Systems

**Inovonics, Inc.**  
503-B Vandell Way  
Campbell, California 95008  
(408) 374-8300  
Broadcast Processors  
(A.G.C./Compressor/Limiter),  
Studio Compressor/Limiter,  
Noise Reduction Unit

**Intersound, Inc.**  
Box 1864  
Boulder, Colorado 80306  
(303) 443-5050  
Equalizer-Reverb Unit

**KLH Burwen Research, Inc.**  
145 University Avenue  
Westwood, Massachusetts 02090  
(617) 326-8000  
Dynamic Noise Filter

**Klark-Teknik**  
Hammond Industries, Inc.  
155 Michael Drive  
Syosset, New York 11791  
(516) 364-1900  
Analogue Time Processor,  
Digital Time Processor

**Lexicon, Inc.**  
60 Turner Street  
Waltham, Massachusetts 02154  
(617) 891-6790  
Digital Delay Systems

**Loft Modular Devices, Inc.**  
91 Elm Street  
Manchester, Connecticut 06040  
(203) 646-7806  
Delay Line/Flanger

**Micmix Audio Products, Inc.**  
2995 Ladybird Lane  
Dallas, Texas 75220  
(214) 352-3811  
Delay Line/Flanger

**Modular Audio Products**  
50 Orville Drive  
Airport International Plaza  
Bohemia, New York 11716  
(516) 567-9620  
Equalizer Module

**Musimatic**  
4187 Glenwood Road  
Decatur, Georgia 30032  
(404) 289-5159  
Equalizer

**Neptune Electronics, Inc.**  
934 N.E. 25th Avenue  
Portland, Oregon 97232  
(503) 232-4445  
Equalizer

**Opamp Labs, Inc.**  
1033 North Sycamore Avenue  
Los Angeles, California 90038  
(213) 934-3566  
Reverberation System

**Orban Associates, Inc.**  
645 Bryant Street  
San Francisco, California 94107  
(415) 957-1067  
Telex: TLX 17-1480  
Reverberation Unit, Limiter/  
Compressor, Dynamic Sibilance  
Controller, Equalizers, Stereo  
Synthesizer

**Parasound, Inc.**  
680 Beach Street  
San Francisco, California 94109  
(415) 673-4544  
Equalizers

**Quad/Eight Electronics**  
11929 Vose Street  
North Hollywood, California 91605  
(213) 764-1516  
Reverberation Unit,  
Compressor, Noise Gate

**Rauland-Borg Corporation**  
3535 West Addison Street  
Chicago, Illinois 60618  
(312) 267-1300  
Equalizers, Tunable Notch Filter

**Sennheiser Electronic Corporation**  
10 West 37th Street  
New York, New York 10018  
(212) 239-0190  
Vocoder

**Shure Brothers Incorporated**  
222 Hartrey Avenue  
Evanston, Illinois 60204  
(312) 866-2200  
Equalizer

**Soundcraftsmen, Inc.**  
2200 South Ritchey  
Santa Ana, California 92705  
(714) 556-6191  
Equalizers

**Spectra Sonics**  
3750 Airport Road  
Ogden, Utah 84403  
(801) 392-7531  
Compressor/Limiter System

**Teac Corporation of America**  
7733 Telegraph Road  
Montebello, California 90640  
(213) 726-0303  
Equalizer

**Technics**  
1 Panasonic Way  
Secaucus, NJ 07094  
(201) 348-7000  
Equalizer

**United Recording Electronics Industries (UREI)**  
8460 San Fernando Road  
Sun Valley, California 91352  
(213) 767-1000  
P.A. Processing Systems, Equalizer,  
Compressor/Limiter, Filter Set,  
Delay Line

**White Instruments, Inc.**  
P.O. Box 698  
Austin, Texas 78767  
(512) 892-0752  
Equalizers

# db Classified

Closing date is the fifteenth of the second month preceding the date of issue.

Send copies to: Classified Ad Dept.  
db THE SOUND ENGINEERING MAGAZINE  
1120 Old Country Road, Plainview, New York 11803

Minimum order accepted \$10.00.  
Rates: 50¢ a word.  
Boxed Ads: \$25.00 per column inch.  
db Box Number: \$1.00 per issue.

Frequency Discounts: 3 times, 10%; 6 times, 20%; 12 times, 33%.

ALL CLASSIFIED ADS MUST BE PREPAID.

## FOR SALE

MCI JH 428 PROFESSIONAL recording console. Excellent condition, fully operational, 3 years old, 28 x 24 with quad. & stereo outputs, light meters, full patch bay and power supplies. \$25,000. For more information write: **Console, P.O. Box 3015, Washington, D.C. 20010. Or call (202) 347-1420.**

MCI 24 TRACK with 16 track heads. Well maintained work horse—reasonable. **M. Guthrie (212) 581-6505.**

MODERN RECORDING TECHNIQUE, by Robert E. Runstein. The only book covering all aspects of multi-track pop music recording from microphones through disc cutting. For engineers, producers, and musicians. \$10.50 prepaid. **Robert E. Runstein, 1105 Massachusetts Ave., #4E, Cambridge, Mass. 02138.**

SPECK 800D CONSOLE; 16 in; 16 out; 16 mon; 2 cues; 2 echo's; parametric EQ; stereo solo; console/prod. desk; \$5,500.00. **Jay Sound, 4300 Watertown Rd., Maple Plain, MN 55359. (612) 475-3151.**

MCI-JH 16-RECORDER, with autolocator, 8-track heads, vari-speed, mint condition, best offer over \$12,500.00. 16-channels dbx-157, \$2,500.00. Call: **(201) 359-5520.**

FREE CATALOG & AUDIO APPLICATIONS



CONSOLES  
KITS & WIRED  
AMPLIFIERS  
MIC, EQ, ACN, LINE,  
TAPE, DISC, POWER  
OSCILLATORS  
AUDIO, TAPE BIAS  
POWER SUPPLIES

**OPAMP**  
LABS INC.

1033 N. SYCAMORE AVE.  
LOS ANGELES, CA. 90038  
(213) 934-3566

BEST PRICE ON TEAC, Tascam, Ampex, Sennheiser, Allison, Eventide, Sound Workshop, UREI, BGW, Electro-Voice, JBL and more. **Paul Kadair's Home and Commercial Audio, Baton Rouge, Louisiana (504) 924-1006.**

12½ in. NAB 0.050 in. ALUMINUM FLANGES. This new item in stock for immediate delivery. For prices, call or write, **RECORDS RESERVE CORP., 56 Harvester Ave., Batavia, N.Y. 14020. (716) 343-2600.**

AMPEX TAPE. Factory fresh, quality inspected. ¼-inch and wide widths. We ship around the world. **Techniarts, 8555 Fenton Street, Silver Spring, MD 20910. (301) 585-1118.**

JFET TUBE REPLACEMENTS for first playback stages in most Ampex Professional audio tape recorders/reproducers available from **VIF International, Box 1555, Mountain View, CA 94042. (408) 739-9740.**

TAPCO and Electro-Voice: mixers, equalizers, amps, mics, and raw loudspeakers. Write or call for low mail order prices. **Sonix Co., P.O. Box 58, Indian Head, Md. 20640. (301) 753-6432.**

**MIKES FROM STOCK!**  
AKG/EV/SONY/SHURE/SENNHEISER



DETROIT'S  
PRO-AUDIO WAREHOUSE  
**(313) 739-7020**

(continued)

## TASCAM!

FROM DETROIT'S PRO-AUDIO  
WAREHOUSE

# Sound Solutions

(313) 739-7020

THE LIBRARY . . . Sound effects recorded in STEREO using Dolby throughout. Over 350 effects on ten discs. \$100.00. Write **The Library, P.O. Box 18145, Denver, Colo. 80218.**

SONY DXC-1200 color video camera. Like new with tripod. Call **Bill (419) 385-4724.**

PROFESSIONAL AUDIO COMPONENTS: AKG mics; Badap 1; Crown; dbx; Delta Lab; Eventide; Frazier; Gauss; GLI; Ivie; Malatchi; MasterRoom; Nagra; Neumann mics; Orban; Otari; Pentagon; RTR; Sennheiser mics; Switchcraft; Tascam; Uni-Sync; and UREI. These products are on demo in our showroom and in stock for immediate delivery. Our shipping is insured and prepaid. **Barclay Recording & Electronics, 233 E. Lancaster Ave., Wynnewood, Pa. 19096. (215) 667-3048 or 649-2965.**

1,200 FIDELIPAC tape carts, 40 second—10½ minutes. \$1,000 for lot, or \$100 per 100. **Dan Brennan (205) 870-9900.**

NAB ALUMINUM FLANGES. We manufacture 8", 10½", and 14". Also large flanges and special reels to order. Stock delivery of assembly screws & nuts & most aluminum audio, video, & computer reels. For pricing, call or write **Records Reserve Corp., 56 Harvester Ave., Batavia, N.Y. 14020. (716) 343-2600.**

SCULLY 1-INCH 8-track—great machine—went 16—**Wells Sound, 2036 Pasket, Houston, TX 77092. (713) 688-8067.**

SCULLY 280-8 . . . 8 track reel-to-reel recorder/playback, one inch tape, in console with remote syncmaster panel. Good condition. Need to sell. **Dan Brennan (205) 870-9900.**

## WANTED

## RECORDING

## EQUIPMENT

## OF ALL AGES AND VARIETIES

*microphones, outboard gear,  
consoles, tape decks, etc.*

**Dan Alexander**

6026 Bernhard

Richmond, Ca. 94805 USA

(415) 232-7933 or (415) 232-7818

AMPEX AND NAGRA TAPE RECORDERS: ART-100, ATR-700 stocked. Laboratory alignment, calibration, and quality assurance. Washington's most experienced professional audio dealer. **Techniarts, 8555 Fenton Street, Silver Spring, MD 20910. (301) 585-1118.**

3M-M 79, MINT condition, 8 track—used less than 6 months total. \$10,000. Including 15 rolls new 206-1" on reels. **(203) 322-5778.**

API CONSOLE 16 input, 8 bus 8 direct, adapted full 16 track monitoring, 24 faders, separate monitor mix, 2 cue sends, 4 echo sends, jack field, 16 VU meters. 3M model M56 track recorder/reproducer with Auto Locator both in very good condition \$25,000. **Pat Costa (617) 685-1832.**

REELS AND BOXES 5" and 7" large and small hubs; heavy duty white boxes. **W-M Sales, 1118 Dula Circle, Duncanville, Texas 75116. (214) 296-2773.**

TASCAM MODEL 10 input & output modules. Inputs \$160.00, Outputs \$110.00. **Jay Sound, 4300 Watertown Rd., Maple Plain, MN. (612) 475-3151.**

AMPEX, OTARI & SCULLY recorders in stock for immediate delivery; new and rebuilt. **RCI, 8550 2nd Ave., Silver Spring, MD 20910.** Write for complete product list.

UREI TIME ALIGNED MONITOR SPEAKERS, a significant advancement in reproduction technology, may be auditioned in our demonstration studios. **Techniarts, 8555 Fenton Street, Silver Spring, MD 20910. (301) 585-1118.**

AMPEX, SCULLY, OTARI, all major professional audio lines. Top dollar trade-ins. 15 minutes George Washington Bridge. **Professional Audio Video Corporation, 384 Grand St., Paterson, N.J. 07505. (201) 523-3333.**

STOP GETTING ZAPPED! Phillips transient voltage protector has nano-second response time, *rated* 30,000 watts within 1 microsecond per plug-in cell, resets automatically, includes neon pilot indicator. No varistors—will not age! \$38.00 each, quantity discounts available. Thousands installed nationwide. **Fultec-Transvolt Inc. 4672 Nisqually Rd., Jackson, MS 39206. (601) 362-5489, or 948-2474.**

## CANADIANS!

SEMI-PRO MULTITRACK RECORDING HEADQUARTERS FOR TEAC/Tascam, Soundcraft, Sennheiser, Bryston, Altec, Lexicon, dbx, Bi Amp, Beyer, JBL, Ashly, Electro-Voice, many more.

Check Our Prices Before You Buy



**Richard's Music Shop, Inc.**  
6078 Sherbrooke W.  
Montreal, Canada H4A 1Y1  
(514) 487-9911

## USED STUDER CONSOLE FOR SALE

Model 189-080 Swiss made like a fine watch—a steal at \$20,000 complete & in perfect condition.

**Steve (212) 765-2005**

SOUND LEVEL METER and analyzer, General Radio Precision Type 1933 with ½-inch microphone. **(201) 540-8811.**

FOR SALE: ELECTRODYNE Model 1608C console, 20 inputs, 16 track monitoring, many gold records made on this console. Available immediately, \$14,500. Also, Ampex AG350 2 track in console, \$1,500. Spare parts also available. **Condor Recording Studios, 143 51st Street, New York, NY 10019. Tel. (212) 581-3674.**

TEST RECORD for equalizing stereo systems; Helps you sell equalizers and installation services; Pink noise in ⅓ octave bands, type QR-2011-1 @ \$20. Used with various B&K Sound Level Meters. **B&K Instruments, Inc., 5111 W. 164th St., Cleveland, Ohio 44142.**

SPECTRA SONICS CUSTOM P.A./Prod. console, 16 in. quad/stereo/mono out; separate sub/mon. mix section. 3 Quad pans, 2 F.B., cost over 20K new. Exc. Cond., Perfect for school, church, performing arts, production studio. 13K or offer. Call **Michael (602) 267-0653 days.**

## WANTED

WANTED: Recording equipment of all ages and variety; Neumann mics, EMT, etc. **Dan Alexander, 6026 Bernhard, Richmond, Ca. 94805. (415) 232-7933.**

WANTED: YAMAHA PM 1000 mixing consoles, any condition. Sennheiser 421 and 441 microphones. Call **Jim at (914) 633-8556.**

## EMPLOYMENT

AUDIO ELECTRONICS ENGINEER. Install, service electronic music studio, other audio equipment. Ampex and Scully recorders. Training, experience in voltage-controlled, digital units, interest in R&D. Send resume to **Professor Se-megen, Music Dept., SUNY at Stony Brook, Long Island, NY 11794. AA/EEO.**

## INSTRUCTION

SHORT INTENSIVE SUMMER courses in recording techniques, electronics, electronic music, jazz improvisation, contemporary song writing, popular and jazz harmony, musical instrument repair and instrumental workshops in saxophone, clarinet, flute, trombone, and percussion, with Allard, Oberbrunner, Rascher, Goebel, Purcell and Strohman. Write or call **Frank Stachow, Summer Workshops. (717) 867-4411 Ext. 275, Lebanon Valley College, Annville, Pennsylvania 17003.**



## BUSINESS OPPORTUNITIES

FOR LEASE: Denver recording studio. 6,000 square feet; two control rooms . . . "live" chamber. Attractive offices . . . ample parking. Centrally located near downtown. Plus equipment for sale: Audio Designs board . . . *mint*; two ampex, 440 B mono machines; two 3M, M64 2-track machines; assorted speakers, amplifiers, etc. Write or call . . . **Fred Arthur Productions, Ltd., 1218 E. 18th Ave., Denver, CO 80218. (303) 832-2664.**

24 TRACK STUDIO closing out. Everything goes. MCI 24 channel console, MCI 24 track recorder, MCI-Scully recorders, AKG/EMT reverbs, Neumann, Sennheiser, Shure, etc. Mics., Limiters, Amps, Speakers, 9-foot Steinway, Yamaha CS 80. Phone (214) 651-9982.

## SERVICES

AMPEX SERVICE COMPANY: Complete factory service and parts for Ampex equipment; professional audio; one-inch helical scan video systems; video closed circuit cameras; instrumentation; consumer audio; professional audio motor and head assembly rebuilding. Service available at 2201 Lunt Ave., Elk Grove Village, IL 60007; 500 Rodier Dr., Glendale, CA 91201; 75 Commerce Way, Hackensack, NJ 07601.

ACOUSTIC CONSULTATION — Specializing in studios, control rooms, discos. Qualified personnel, reasonable rates. Acoustilog, Bruel & Kjaer, HP, Tektronix, Ivie equipment calibrated on premises. Reverberation timer and RTA rentals. Acoustilog, 19 Mercer Street, New York, NY 10013. (212) 925-1365.

PARTS-SERVICE, Akai, Ampex, Professional & Consumer, Dokorder, Pioneer, Tandberg, Teac, etc. **Electronic Engineers, Inc., 1639 West Evergreen Ave., Chicago, IL 60622. (312) 227-2600.**

MAGNETIC HEAD relapping—24 hour service. Replacement heads for professional recorders. IEM, 350 N. Eric Dr., Palatine, IL 60067. (312) 358-4622.

CUTTERHEAD REPAIR SERVICE for all models Westrex, HAECO, Grampian. Modifications done on Westrex. Avoid costly down time; 3-day turnaround upon receipt. Send for free brochure: **International Cutterhead Repair, 194 Kings Ct., Teaneck, N.J. 07666. (201) 837-1289.**

SPECIALISTS IN THIELE cabinet designs & conical exponential horns; tour systems, permanent installations using Electro-Voice, BGW, White, dbx, Soundcraft, Harrison, Otari, David Clark, DeltaLab, Lexicon, Sennheiser, Sony and Wireworks components. Contact: **Engineering and Sales Group, Star Tech Sound, Inc., (609) 779-7887.**

# Lake Placid 1980. Our only home advantage will be your support.



## Without your help, we can't afford to win.



A \$ \_\_\_\_\_  
contribution  
is enclosed.

Make check payable to U.S. Olympic Committee,  
P.O. Box 1980-P, Cathedral Station, Boston, MA 02118

Name \_\_\_\_\_

Address \_\_\_\_\_

City \_\_\_\_\_

State \_\_\_\_\_

Zip \_\_\_\_\_

Please send me the symbol of support checked below.

- Belt Buckle (\$10)     Winter Games Tote Bag (\$25)  
 Ski Cap (\$25)         Bookends (\$50)

Your contribution is tax-deductible.

**Benjamin B. Bauer**, former vice president and general manager of the **CBS Technology Center**, Stamford, Conn., died of a heart attack in Stamford Hospital on Saturday, March 31, 1979. He was 65 years old. A towering figure in the audio and acoustics fields, he had remained a consultant to CBS following his retirement in July 1978, after 21 years of service.

Mr. Bauer's first invention came shortly after his graduation from college in 1937. It was the single-transducer cardioid dynamic, or directional, microphone whose acoustical phase-shift principle is, to this day, used almost universally in commercial microphones for broadcasting and public address systems. At that time a novice development engineer for **Shure Brothers, Inc.**, manufacturers of microphones and phonograph pickups in Evanston, Illinois, he was to become Shure's director of engineering and vice president before joining CBS Inc. in 1957 where he assumed responsibility for audio technology development at the then-CBS Laboratories in Stamford, Conn.

Many contributions in the ensuing four decades followed Mr. Bauer's landmark 1938 microphone invention, spanning a broad range of technology disciplines. He was awarded 75 U.S. patents. Foreign patents swelled the total to more than a hundred. His long list of achievements included microphones created for acoustical measurements, piston-phones, heartbeat measurements, hearing aids, public address systems, broadcasting, sound ranging, and civilian and military communications; headphones and artificial voice and ear devices; loudspeakers and loudspeaker enclosures; vibration measuring instruments; stereophonic test records and transducers for phonograph recording and reproduc-

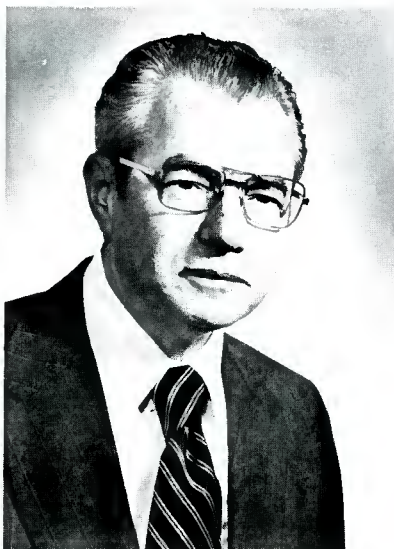

tion; magnetic recording heads and transports; directional hydrophones and hydrophone calibrators; devices for automatic level control in broadcasting; psychoacoustic research related to the measurement of loudness and to directional hearing in air and underwater; and techniques and instrumentation for reproducing and broadcasting quadruphony.

Mr. Bauer was born in Odessa, Russia, in 1913, and spent his youth in Cuba. Coming to the U.S. in 1930, he earned a degree in Industrial Engineering from Pratt Institute, in New York City, before attending the University of Cincinnati, where, in 1937, he received his electrical engineering degree. Postgraduate studies included physics, mathematics, and acoustics at Chicago and Northwestern Universities.

Dedicated to learning and scientific education, Mr. Bauer authored nearly 100 technical papers, lectured

widely in this country and abroad, contributed to textbooks on acoustical subjects, was technical editor and publisher of a textbook, "Acquisition, Reduction, and Analysis of Acoustical Data," for the U.S. Navy, and was visiting professor of Engineering Acoustics at Pennsylvania State University.

He was elected to the National Academy of Engineering in 1974, and was a member of the Naval Studies Board of the National Academy of Science. He was a Fellow of the Institute of Electrical and Electronic Engineers (IEEE), of the Acoustical Society of America (ASA), and of the Audio Engineering Society (AES). He was an Honorary Member of the latter organization, as well as a past president and recipient of its Gold Medal Award. In 1977, the Acoustical Society presented Mr. Bauer with its Silver Medal in Acoustics, only the third scientist so honored, "for his contributions to engineering acoustics, particularly in the development of techniques and devices used to pick up, record, and reproduce sound."

Recently, in March, 1979, Mr. Bauer had been inducted into L'Ordre de Chevalerie de L'Etoile de la Paix—a *chevalier of the Order of the Knights of the Star of Peace*—an international nondenominational organization founded in 1229 and dedicated to peace and which recognizes heads of state and leaders in the fields of government, international relations, diplomacy, the arts, and sciences.

We saw Ben this past March in Brussels at the AES convention and chatted with him about new editorial contributions that will now never come. We at **db Magazine** have lost more than a contributor; Ben was a friend whose generosity and warmth we shall miss.

# MIDAS 1979 extend the possibilities

Midas design philosophy has provided high quality signal processing in a compact and rugged frame of innovative modular design, making the P.R. system the choice of professionals.

Backed by extensive research into advanced technology components plus thorough understanding and analysis of over 350 consoles sold in the last seven years, the P.R. system has come of age.

24 into 6/2 VCA controlled Theatre Sound Reinforcement

Console providing six separate pre-set mixes with integral cross-fade and remote automation interface facilities, another example of P.R. system versatility.

How can MIDAS experience benefit you?



MIDAS AUDIO SYSTEMS LTD. DAVID SOLARI, 54-56 STANNHOPE STREET, EUSTON, LONDON N1 7EX, TEL: 01-388-7060 01-387-7679  
MIDAS AUDIO CORPORATION, BOB STELGRUIJE, 730 MAIN STREET, NIAGARA FALLS, NEW YORK 14301 U.S.A. TEL: 716-282-4100  
MIDAS CANADA, FRANK PITMISKERN, GERR ELECTRO-ACOUSTICS, 365 ADELAIDE STREET EAST, TORONTO M5B 4R8, ONTARIO, CANADA TEL: 416-868-0528  
See us in May of the L.A. AES exhibition

Circle 11 on Reader Service Card

# Wait till the Word gets out.

Big Sky Recording Studios  
Aspen, Colorado

1121 10:00  
1979  
APR 2 1979  
\$ 91,660.00 DOLLARS

*Gary Jones*

PAY TO THE ORDER OF  
**Peoples 1st Federal**  
Aspen Office Aspen, Colorado 81611

1: 4 2 2 2 6 0 7 6 1: 4 4 2 4 m 0 2 m 3 9 6 7 4 2 m

Description  
One Model MBA02ACX Automated Console

For the Artist in Every Engineer



Quad/Eight Electronics

Quad/Eight International, 11929 Vose Street, North Hollywood, California 91605, (213) 764-1516 Telex: 662-446

Circle 12 on Reader Service Card