

db

-AUD 01  
-VISA-  
X0.

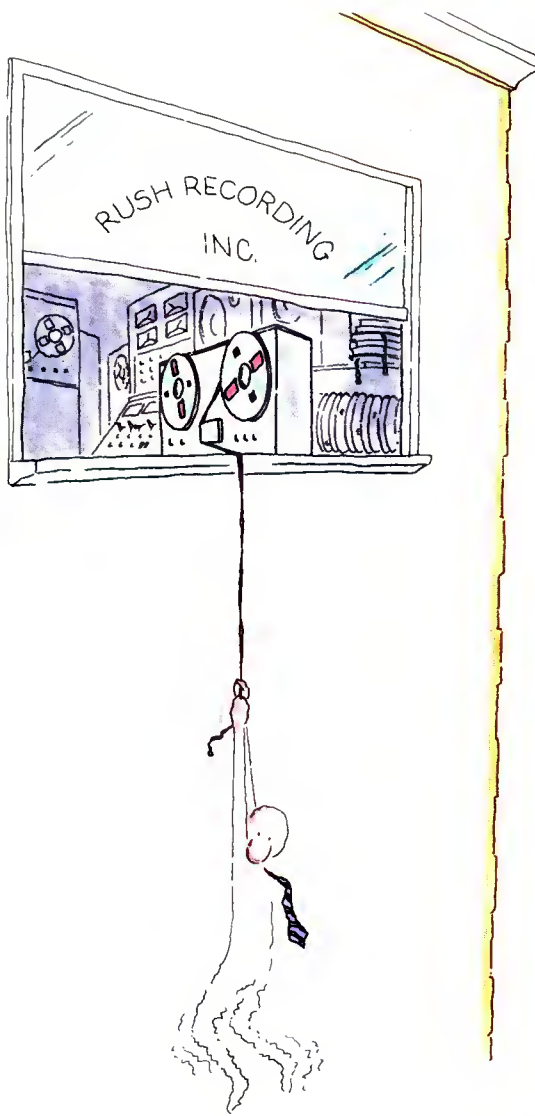



## Audio engineers who try Maxell won't let go.

Maxell quality saves a lot of recording situations. Maxell meets your 1/4" open reel and audio cassette needs, no matter how demanding you are. Because we're more demanding. We've developed a name that means unique quality all around the world. For example, Maxell cassettes give you a productivity boosting four-function leader with A/B side indications, directional arrows, non-abrasive head cleaner and five-second cue to set timing and level.

You can see Maxell excellence in the cassette construction and on the 'scope or meter. The physical construction is strong enough to meet all professional requirements. Maxell open reel tape and cassettes give you quality you can hear. And your clients can hear as well.

We'll give you all the technical information you need to form your own opinions. But if you're like just about every audio professional that tries Maxell, you won't let go. Remember, we warned you!



**maxell**<sup>®</sup>

PROFESSIONAL/INDUSTRIAL DIVISION

**Our success is magnetic.**

Maxell Corporation of America, 60 Oxford Dr., Moonachie, N.J. 07074 (201) 440-8020

Circle 10 on Reader Service Card

Publisher  
**Larry Zide**

Editor  
**John M. Woram**

European Editor  
**John Borwick**

Associate Editor  
**Mark B. Waldstein**

Advertising Production & Layout  
**Karen Cohn**

Classified Advertising  
**Carol Vitelli**

Book Sales  
**Lydia Calogrides**

Circulation Manager  
**Eloise Beach**

Art Director  
**Bob Laurie**

Graphics  
**K & S Graphics**

Typography  
**Spartan Phototype Co.**

sales offices

**Roy McDonald Associates, Inc.**  
Dallas, Texas 75207

First Continental Bank Bldg.  
5801 Marvin D. Love Freeway  
Suite 303  
(214) 941-4461

**Denver, Colorado Area**  
Englewood, Colorado 80112

14 Inverness Dr. East  
Bldg. 1—Penthouse  
(303) 771-8181

**Houston, Texas 77036**  
6901 Corporate Drive  
Suite 210  
(713) 988-5005

**Los Angeles Area**  
Glendale, California 91204

424 West Colorado Street  
Suite 201  
(213) 244-8176

**Portland Area**  
Hillsboro, Oregon 97123

510 South First  
P.O. Box 696  
(503) 640-2011

**San Francisco Area**  
Emeryville, California 94608

265 Baybridge Office Plaza  
5801 Christie Avenue  
(415) 653-2122

**Sagamore Publishing Co.**  
New York

Plainview, NY 11803  
1120 Old Country Rd.  
(516) 433-6530



JULY 1982 VOLUME 16, NO. 7

## DEPARTMENTS

LETTERS	CALENDAR	EDITORIAL	CLASSIFIED
6	8	26	51
SOUND REINFORCEMENT			John Eargle
10			
THEORY AND PRACTICE			Ken Pohlmann
14			
DIGITAL AUDIO			Barry Blesser
18			
SOUND WITH IMAGES			Len Feldman
24			
NEW PRODUCTS AND SERVICES			
49			
PEOPLE, PLACES, HAPPENINGS			
54			

## FEATURES

RIDING THE NEW WAVES	Howard Sherman
28	
NOISE REDUCTION: WHERE TO NEXT?	Ralph Hodges
34	
NOISE REDUCTION UPDATE	
35	
A db SPECIAL REPORT: THE NEW WORLD OF DIGITAL AUDIO	John M. Woram
38	
THE NAB CONVENTION—PART II	John M. Woram
44	

## About The Cover

• This month's cover features Suzanne Ciani's new album propped upon the Buchla Series 200 synthesizer. For more information on the Ciani album, see the feature article on page 28.

db, the Sound Engineering Magazine (ISSN 0011-7145) is published monthly by Sagamore Publishing Company, Inc. Entire contents copyright © 1982 by Sagamore Publishing Co., 1120 Old Country Road, Plainview, L.I., N.Y. 11803. Telephone (516) 433-6530. db is published for those individuals and firms in professional audio-recording, broadcast, audio-visual, sound reinforcement, consultants, video recording, film sound, etc. Application should be made on the subscription form in the rear of each issue. Subscriptions are \$15.00 per year (\$28.00 per year outside U.S. Possessions; \$16.00 per year Canada) in U.S. funds. Single copies are \$1.95 each. Editorial, Publishing and Sales Offices: 1120 Old Country Road, Plainview, New York 11803. Controlled circulation postage paid at Plainview, NY 11803 and an additional mailing office.

**FitzCo**  
SOUND, INC.

AAE "Concept One"  
Automation

AKG

AMPEX

AMPEX TAPE

AUDIOARTS ENGINEERING

BGW TANNOY

HANNAY  
(Cable Reels)

EVENTIDE

IVIE

LEXICON

SENNHEISER

TECHNICS

VEGA

WIREWOKS

**FitzCo**  
SOUND, INC.

204 N. Midkiff  
Midland, Texas 79701  
(915) 684-0861

**db Letters**

**Index of Advertisers**

Alpha Audio ..... 29  
 Ampex ..... Cover IV  
 Audio-Technica ..... 11  
 Cetec Gauss ..... 25  
 Community Light & Sound ..... 16  
 Crown ..... 15  
 Dolby ..... 19  
 Emilar ..... 12  
 Fitzco ..... 6  
 JBL ..... 13  
 Klark-Teknik ..... 7  
 Maxell ..... Cover II  
 MCI ..... 37  
 Orban ..... 27  
 Otari ..... 17, 20-21  
 PMPEA ..... 53  
 Polyline ..... 22  
 Russeo ..... 12  
 Soundcraftsmen ..... 23  
 Sound Technology ..... 9  
 Standard Tape Labs ..... 41  
 Studer ..... 31  
 Tascam Div., Teac Corp. .... Cover III  
 Telex ..... 42

**STATEMENTS OR MISSTATEMENTS?**

It is unfortunate that even in a technical publication, the facts too often suffer. I like to feel that blatant misstatements are not published, but this is not the case in the May Sound With Images column. While I could write pages on the mistakes, I shall limit this note to the following.

The camera does *not* provide "the reference for the tape transport drive." That is dated, and goes back to umbilical cords. Both use sync (sometimes, crystal) generators which are close enough to be considered as one.

The film synchronizer "...is a mechanical contraption with series of sprocket holes arranged side-by-side." How about sprocket *teeth*? And if that were not enough, it goes on to tell us that "...those common sprocket holes run all the strips simultaneously."

"The field rate was changed to approximately 59.94 frames (or a frame rate of 29.97) per second." Does 59.94 refer to Hz s, and what then does 29.97 mean?

As for a Moviola rental at "\$25 per hour," the going rate of \$25 is high for the *day*.

So, after these gems, how much of the

**Coming Next Month**

• In August, we'll be taking a look at speaker and monitor systems. Robert Harvey checks in with an informative, anecdotal article on the Altec 604 loudspeaker; Wolf Schneider brings us the inside information on the installation of a 16,000 watt sound system in Seattle's Paramount Theatre; and William Matthews gives us a brief history of custom equalization. In addition, there will be a loudspeaker monitor roundup, and Michael Rettinger returns to our pages with a piece on sound insulation. Of course, our regular columnists and departments will also be on hand. All this — and more — coming in August's **db—The Sound Engineering Magazine**.

# Better than all measures of delightful sound.

(Shelley 1792-1822)

For further information on our complete range of professional audio equipment and application details telephone (516) 249-3660

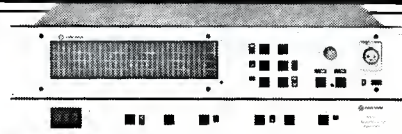

## DN60 REAL TIME SPECTRUM ANALYSER

The DN60 Real Time Spectrum Analyser is a new audio measurement system. It is capable of performance checks on virtually any audio equipment, and is especially well suited for aligning audio tape recorders. On site performance verification, whether of a 10,000 seat arena, or a studio control room, is easily effected with the DN60.

The microprocessor based circuitry makes the DN60 very cost effective and with the inclusion of Three Memories, and a Peak-Hold function, you can expand the scope of your sound check and provide that extra edge of excellence.

## RT60 REVERBERATION ANALYSER

The optional RT60 unit further extends the capabilities of the DN60, facilitating accurate and comprehensive reverberation time analysis. RT60 figure is displayed for any one of 30  $\frac{1}{3}$ rd octave frequencies or 'wide band' and the reverberation decay curve is automatically plotted on the DN60 L.E.D. matrix display.

The RT60 features a variable decay window, three memories, selectable display times and curve accumulate function. Both impulse and gated noise methods are automatically recognised.

An XY plotter and hard copy printer is available for the DN60 and RT60.



**KLARK TEKNIK**  
*sound science*

**Klark-Teknik Electronics Inc.**  
262a Eastern Parkway, Farmingdale,  
NY 11735, USA. Telephone: (516) 249-3660

**Klark-Teknik Research Limited**  
Coppice Trading Estate, Kidderminster, DY11 7HJ,  
England. Telephone: (0562) 741515 Telex: 339821

**Omnimedia Corporation Limited**  
9653 Côte de Liesse/Dorval, Quebec H9P 1A3,  
Canada. Telephone: (514) 636 9971

Circle 26 on Reader Service Card

rest is true? Does the editorial department bear some responsibility for what is printed? My faith in your magazine was high up to now—please reassure me!

BEN SOBIN

Ben Sobin Motion Picture Sound,  
Recording and Equipment

#### db replies:

*Be assured, Mr. Sobin! Everything you read in db is true ( $\pm 3$  dB, of course). Mr. Feldman reminds us that he was reporting on the comments of several speakers at a recent AES section meeting. For example, the reference to the sync system was a direct quote from a speaker who may have been referring to an ancient system, but one that was still in use. Agreed, sprocket holes should have been sprocket teeth, but one could argue that without the holes, the teeth ...oh, never mind.*

*Most readers will realize that 59.94 refers to fields. Dividing by two frames-per-field, we get a frame rate of 29.97 frames-per-second. We don't think either fields or frames should be referred to in Hz, and certainly not in Hz/s.*

*The reference to \$25 per hour includes the use of the editing room—not just the Moviola—and again, is a direct quote from the meeting.*

#### THE SUMMER OF '33

TO THE EDITOR:

It seems as though recording techniques are more important than the music to be recorded. As each new development comes along, a new set of problems are encountered.

In the summer of 1933 I pulled my '27 Chevrolet Coach up to a side window of a club where I was playing. We ran the line from a Universal "BB" carbon microphone out to the car along with a power line to the "equipment" mounted where the passenger seat used to be. The equipment consisted of a modified Victor RE-32 amplifier with push pull '45's driving an "Acratest" lathe driven "cutter" across a blank aluminum disc. The "cutter" must have weighed several pounds which embossed the grooves and somehow managed to get them loaded with audio. The excitement of hearing ourselves mitigated the somewhat restricted audio range. There was a "night and day" difference over the previous recordings made with pregrooved discs which suffered from noise and insufficient audio level.

This writer went through the whole gamut of change since that time. The experiences since 1932 when the first attempts were made could fill a novel length book. Some of those early aluminum discs are still around and are occasionally played although not with the recommended cactus needles. Pickups weighed "tons" in those days.

As time went on, the quality improved. Today we can cut a disc with virtually zero noise level that is loaded with a wide range reproduction of the original sound pickup. Dynamics? In 1935, RCA produced a home player that had a "volume expander." They are available today if some isolated individual must have this.

Some of the finest pressings were made in the mid fifties when only monaural recordings were made. Other than two track sound, there has been little in the way of actual improvement since then.

To capture in detail the sound of an orchestra when the only system was monaural required a magnificent skill in blending or mixing. It was really an artistic endeavor. Multi-track taping is no substitute for this artistry. Resisting change is anachronistic, but when those changes contribute to inferiority in even the least extent, they should be avoided.

'27 Chevrolet Coach? That's a two door sedan in today's terminology.

HENRY R. KUHN

Kuhn Recording Service

#### BACK TO MONO

TO THE EDITOR:

Ken Pohlmann's Theory & Practice column titled "Doppelgangers" (May 1982) offended me. Maybe Mr. Pohlmann believes that stereo is "more than twice as good" as monaural recording, but I don't.

Granted, a stereophonic (or quadraphonic, or hexaphonic, etc.) record playback system can produce phantom images. So what? The illusion doesn't work unless the listener is located exactly on axis. Moreover, who cares? Personally, the sound of a multichannel playback is irritating to me. When I hear an instrument coming out of one speaker and not the other, I get an uncomfortable sensation of unbalance.

Multichannel playback has a place in theaters and other specialized installations. For ordinary entertainment use in the home, it's an unwarranted expense and a vulgar effect.

Please pass along the enclosed lapel button to Mr. Pohlmann. It's certain to stimulate conversation, and it may make him think twice about monophony.

HOWARD RUSSELL

*Mr. Russell need have nothing to fear. We're sure that stereo is just a passing fad. As soon as the novelty wears off, we'll fire Pohlmann and buy us a '27 Chevy mobile rig to do club dates. (P.S. the "Back to Mono" lapel button has been passed along to Mr. Pohlmann, who is probably too young to understand what it means.)*

#### JULY

25-27 **Midwest Music Exchange—A National Music/Record Industry Convention.** Bismarck Hotel, Chicago, IL. For more information contact: Midwest Music Exchange, 704 N. Wells St., Chicago, IL 60610. Tel: (312) 440-0860.

#### AUGUST

29- **NAB's 1982 Radio Programming Conference.** New Orleans Hyatt Regency Hotel, New Orleans, LA. For more information contact: The National Association of Broadcasters, 1771 N Street, N.W., Washington, DC 20036. Tel: (202) 293-3570.

#### SEPTEMBER

12-15 **NRBA '82 Convention and Exposition.** MGM Grand Hotel, Reno, NV. For more information contact: NRBA, 1705 DeSales St., N.W., Suite 500, Washington, DC 20036. Tel: (202) 466-2030.

28 **7th Sound Broadcasting Equipment Show.** Sponsored by Audio & Design (Recording) Ltd. Albany Hotel, Birmingham, England. For more information contact: Audio & Design (Recording) Ltd., North St., Reading, Berks, RG1 4DA, England.

#### OCTOBER

22-25 **72nd AES Convention.** Disneyland Hotel, Anaheim, CA. For more information contact: AES Headquarters, 60 E. 42nd St., New York, NY 10165. Tel: (212) 661-8528, or Robert Trabue Davis, Altec Lansing, 1515 So. Manchester Ave., Anaheim, CA 92803. Tel: (714) 774-2900.



# THE INTELLIGENT TEST SET THAT CLEANS UP YOUR ACT.

## The Sound Technology 1500A

It's the first microprocessor controlled audio measurement test system. It can do in minutes what used to take hours with more conventional and ordinary test set-ups. And, it can show you things you've never seen before.

Designed around the most advanced microprocessor hardware, the 1500A will show you the whole story on an integral CRT with adjustable cursor. Push a "Copy" button, and it delivers a hard-copy printout from the optional VP-150 Video Printer.

### What Will It Do?

Conceived to be the ultimate precision test instrument for tape recorder analysis, the 1500A evolved into a comprehensive audio test system for many applications. Here's just a small sample of the varied jobs it will do:

- Complete tape recorder mechanical and electronic performance checks
- Thorough phono cartridge analysis
- One-third octave spectral analysis

- Evaluation of audio quality for VTR's
- Acoustical room analysis including microphone and loudspeaker measurements
- Quality control for high speed tape duplication systems
- Semi-automated production testing
- Research and development for the audio tape manufacturer
- Quality assurance for the audio distribution network
- Exclusive asynchronous inputs and outputs for remote location testing (satellite, transmitter, studios, etc.)

Here's the kind of data you can get:

- Frequency Response
- Azimuth at 4 discrete frequencies
- 2nd and 3rd Harmonic Distortion Vs. Level
- Wow & Flutter; noise; weighted or flat
- Channel Separation 20Hz - 20k
- Delta Speed & Drift

Because of the modular plug-in design, the 1500A is designed to grow with you. Many accessories are now available which include a 1/3 octave spectrum analyzer card (noise: 20Hz-20kHz, Wow & Flutter, .5Hz-200Hz) that easily plugs into the mainframe; a hard copy printer; a comprehensive test record that lets you test cartridges, tonearms and turntables; a balancing system that will allow you to interface balanced I/O test applications; and a heavy-duty transport case. There's even a kit for rack mounting.

Add to the above the powerful new GPIB, IEEE interface for computers, and you have an extremely broad range of functions and applications that the advanced 1500A can tackle.

### Who Can Use It?

Broadcaster. Recording studio. Film sound studio. Audio manufacturer. Audio dealer. Service technician. Researcher. Virtually anyone whose job requires accurate evaluation of audio equipment performance. Wherever you are in the audio spectrum, it can make life a whole lot easier.

Clean up your act with the 1500A. It's intelligent. And so is a phone call to Sound Technology. We'll be pleased to send full information on the 1500A and our other industry standard test equipment.

**SOUND TECHNOLOGY**

1400 Dell Avenue, Campbell, CA 95008  
(408) 378-6540 Telex: 357445

Circle 15 on Reader Service Card © Sound Technology, 1982

## Ported Low-frequency Systems in Sound Reinforcement

• Ported, or bass reflex speaker systems have been around since the earliest days of the dynamic loudspeaker. Their designs were more often "cut and try" than rational, and bad "boomy" systems were more common than good ones. The main advantage of a properly-ported system over a sealed one is the reduction of distortion at low frequencies. This is shown in FIGURE 1.

There are two coupled resonances in the system, the loudspeaker and the tuned enclosure, and it is the proper matching, or alignment of the two that will result in a desired response. In the figure, note that in the region of enclosure resonance, the actual output from the cone is at its minimum. The enclosure is receiving power from the loudspeaker in that frequency range, but the cone's motion is at a minimum. Through resonance, the volume velocity at the port is maximized, and considerable acoustical output results. At resonance, the port output is shifted in phase by 90 degrees relative to the cone; below resonance, the output of the port approaches 180 degrees relative to the cone, and the response falls off quickly, at 24 dB/octave.

Since the cone's motion is relatively slight in the region of the enclosure resonance, the normal displacement nonlinearities of the low-frequency transducer are minimized, and the device is usually able to handle its full thermal power rating down to the region of enclosure resonance. Because of system unloading below enclosure resonance, it is standard practice in ported systems to high-pass filter the program just below resonance.

### ANALYSIS OF THE SYSTEM

During the fifties, excellent analyses of ported systems were carried out by Beranek (2), Locanthi (4) and Novak (6). However, it remained for Thiele and Small, elaborating on the work of Ben-

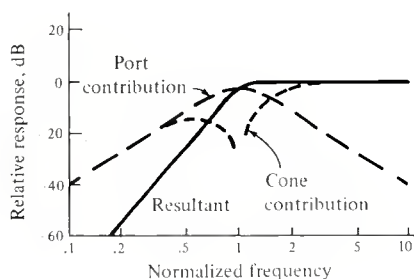

Figure 1. Relative Output from Cone and Port in a Ported System.

son, to provide relatively simple means of system synthesis (7,8). Their work is richly detailed in the *AES Loudspeakers Anthology*, which all serious designers should consider as essential source material. Today, just about every serious speaker system designer has a calculator or micro-computer program available to tabulate the response of a system prior to building it.

Thiele and Small identified a set of parameters for low-frequency transducers which enable the designer to calculate the response of a system, with enclosure volume and tuning as the variables. The parameters useful in this phase of the design are:

- $f_s$  the free-air resonance of the transducer, in Hz.
- $Q_{ts}$  the total  $Q$  of the transducer. The  $Q$  we are referring to here has to do with the sharpness of the resonance curve of the transducer when driven by an amplifier with a low source impedance. It is not to be confused with the use of the symbol  $Q$  as the directivity factor of a loudspeaker.
- $V_{as}$  the volume of air providing a restoring force equal to that of the transducer's mechanical compliance, in liters ( $\text{ft}^3$ ).

### A DESIGN EXAMPLE

As an example of how these parameters can be used, let us take a 380 mm (15 in) low-frequency transducer such as might be used in a studio monitoring system. The parameters are:

$$\begin{aligned} f_{as} &= 20 \text{ Hz,} \\ Q_{ts} &= 0.25, \text{ and} \\ V_{as} &= 460 \text{ liters (16.2 ft}^3\text{).} \end{aligned}$$

The alignment we will calculate is a so-called *flat alignment*: an alignment which will have no ripple or bump in its response as it reaches its lower frequency limits. The approximate design equations, as given by Keele (3), are short cuts to estimating certain aspects of system response. They have an accuracy of about ten percent. A more thorough realization of a vented system program on a micro-computer would actually plot out the relative frequency response of a given simulated system. The equations are:

$$V_b \approx 15 (Q_{ts})^{2.87} \times V_{as} = 129 \text{ liters (4.5 ft}^3\text{),}$$

$$f_3 \approx 0.26 (Q_{ts})^{1.4} \times f_s = 36 \text{ Hz, and}$$

$$f_b \approx 0.42 (Q_{ts})^{0.9} \times f_s = 29 \text{ Hz,}$$

where

$$V_b = \text{the volume of the enclosure,}$$

$$f_3 = \text{the 3 dB-down point, and}$$

$$f_b = \text{the enclosure resonance frequency.}$$

The response of this system is shown in FIGURE 2 as curve A.

Let us further calculate the effect of making the box somewhat smaller; say, 85 liters ( $3 \text{ ft}^3$ ). Again, according to Keele, the 3 dB-down point will be given by

$$\begin{aligned} f_3 &\approx \sqrt{V_{as}/V_b} \times f_s = 46 \text{ Hz.} \\ H &\approx 20 \log[2.6 Q_{ts} (V_{as}/V_b)^{0.35}] \\ &= 1.4 \text{ dB, and} \end{aligned}$$

$$f_b \approx (V_{as}/V_b)^{0.12} \times f_s = 34 \text{ Hz,}$$

where

$$H = \text{the response hump, in dB.}$$

This humped curve is shown in FIGURE 2 as curve B.



# Now your ENG units can afford the same "line" microphones bought by every major network!

You can pay as much as \$1,500 or more to get a good long-reach line microphone. Or, you can put the new Audio-Technica AT815 in every production unit for under \$230 each, or the phantom-powered AT815R for under \$300 each.

What you'll hear is performance closely rivalling our more expensive brethren. So close, in fact, that every major network has tried and bought our line microphones. And you'll get some advantages which can be very important in the field.

For instance, the phantom-powered AT815R can interface with supply voltages from 9 to 52 volts without adapters or extra circuits. So you don't have to rebuild present equipment to put it on the air. We also have a neat 2-battery 9V power supply you can use. When one battery is in use, the other is on standby. For your peace of mind.

Our internal-battery AT815 uses a standard AA "penlite" cell available everywhere. And in intermittent use, a premium battery should last about 4,000

hours. That's over a year even if used eight hours every day! Just one less thing to worry about when time is short.

The AT815 and AT815R weigh barely over 9 ounces, to make them easy to "fishpole" or hand hold. And each comes with a foam windscreen which slips on in a second. Our optional shock mount can be added as well. And the AT815R has a bass roll-off switch if needed to control rumble.

Both models are designed to take the rough-and-tumble life of an ENG unit or remote film crew, and keep delivering excellent sound. With the narrow directivity which makes line microphones so useful in suppressing noise and "reaching out" beyond normal mike range.

If you thought line microphones were out of reach of your budget, ask your Audio-Technica sound specialist to show you the AT815 or AT815R. We think you'll agree that the networks are onto something great!

**AT815  
Line + Gradient  
Microphone.  
Under \$230.  
Optional  
shock mount extra.**

**AT8410a Shock  
Mount. Under \$40.**

**AT8501 9V Dual Battery  
Power Supply. Under \$100.**

**AT815R Phantom-Powered  
Line + Gradient Microphone.  
Under \$300.**



**audio-technica®**

AUDIO-TECHNICA U.S., INC., 1221 Commerce Dr., Stow, OH 44224 216/666-2600

Circle 13 on Reader Service Card

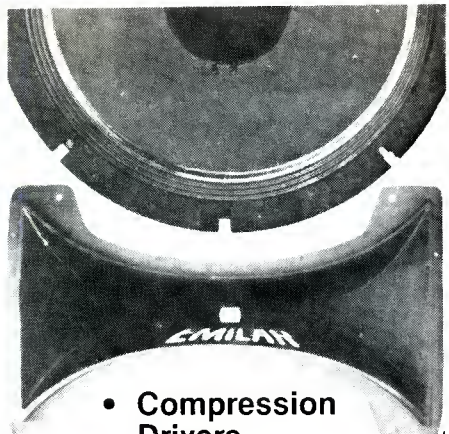

- Compression Drivers
- Cone Drivers
- Horns
- Crossovers

# EMILAR

For complete information call  
714-632-8500 — 800-854-7181

**EMILAR CORPORATION**  
1365 N. McCan St.  
Anaheim, CA 92806

Circle 34 on Reader Service Card

## RUSSCO MLD / 22 MIKE TO LINE PREAMP



# versatile!

The MLD / 22 dual-channel Preamp drives a 600 Ohm line to +18dBm. It's really MULTI-USE! For line to line booster, unattended remote, stereo preamp, line combiner for single out, remote mike & mike to line combiner, long line use for distant mikes, adding mikes to non-preamped mixers, feeding telephone lines and MORE! Use it balanced or unbalanced. It's self-powered, Russco Rugged and BARGAIN PRICED!

**RUSSCO**  
ELECTRONICS INCORPORATED

5690 E. Shields Ave., Fresno, Calif.  
U.S.A. 93727 • Phone (209) 291-5591

Circle 33 on Reader Service Card

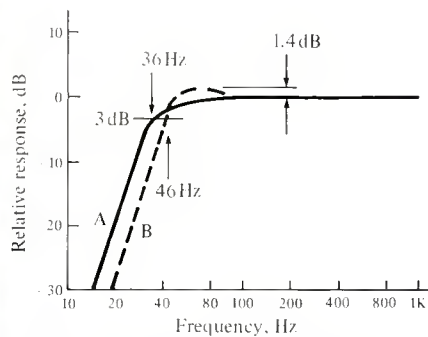

Figure 2. Two Alignments. Curve A is a natural flat alignment, and curve B is a "humped" alignment using a smaller enclosure.

Both kinds of response may be useful. Curve A is obviously the choice for smoothest low-frequency response in a studio monitoring system, while Curve B might be more useful, and convenient because of size, for certain kinds of musical instrument amplification.

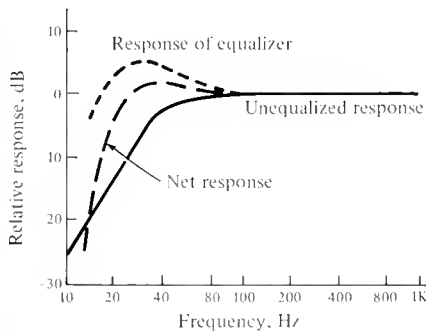

Figure 3. Example of a rolled-off alignment (computer generated), which can be electrically equalized for flat acoustical response.

Another type of alignment is shown in FIGURE 3. Here, a 460 mm (18 in) transducer is mounted in a 450-liter (16 ft<sup>3</sup>) enclosure, tuned to 20 Hz. This alignment makes use of a larger enclosure and lower tuning than would be dictated by a flat alignment. The parameters of the transducer are:

$$f_s = 20 \text{ Hz,}$$

$$Q_{ts} = 0.27, \text{ and}$$

$$V_{as} = 821 \text{ liters (29 ft}^3\text{).}$$

The resulting response begins a smooth roll-off around 100 Hz, and is no more than 6 dB down at about 25 Hz. It can therefore be equalized electrically for flat response down to that frequency, assuming that the voice coil can stand the extra power input. Had we opted for a flat alignment for this transducer, we would have a value for  $f_3$  of about 33 Hz.

Such a system as this would have application—especially in multiples—as a sub-woofer in either live sound reinforcement of music or in the motion picture theater for special effects.

### LARGE-SIGNAL PARAMETERS

Thus far, we have considered only those parameters which determine the shape of the frequency response curve. They are the so-called small-signal parameters. The large-signal parameters include:

- $X_{max}$  the allowable cone displacement from its rest position. Typically, it is the displacement at which non-linearity does not exceed ten percent.
- $S_d$  the effective cone area.
- $P_{E,max}$  the maximum sustained power input that the transducer can withstand, based on thermal limitations of the voice coil.

We will not work out any examples using these, but with them it is possible to determine maximum system output, as a function of frequency, identifying those parts of the frequency range where the output is either thermally limited or cone-displacement limited.

Additional calculations have to do with port dimensioning, aimed at providing adequate port area for the maximum air volume velocities to be encountered at resonance with full power input.

### CONCLUSIONS

This overview of ported system design via the Thiele-Small parameters has of necessity been a limited one. Those readers who are interested in knowing more about this design approach are referred to the AES *Anthology* cited earlier, as well as to the recent AES paper by Margolis and Small detailing a hand-held calculator program (5). ■

### REFERENCES

1. J. E. Benson, "Theory and Design of Loudspeaker Enclosures," *AWA Technical Review*, vol. 14, no. 1 (August 1968).
2. L. L. Beranek, *Acoustics*, McGraw-Hill, New York 1954, pp. 239-258.
3. D. B. Keele, "Vented Box Design Using a Pocket Calculator," unpublished correspondence, 1976.
4. B. N. Locanthi, "Application of Electric Circuit Analogies to Loudspeaker Design Problems," *IRE Transactions on Audio*, vol. PGA-6 (March 1952).
5. G. Margolis and R. H. Small, "Personal Calculator Programs for Approximate Vented-Box and Closed-Box Loudspeaker System Design," *Jour] AES*, vol. 29, no. 6 (June 1981).
6. J. Novak, "Performance of Enclosures for Low Resonance High Compliance Loudspeakers," *Jour. AES*, vol. 7, no. 1 (January 1959).
7. R. H. Small, "Vented-Box Loudspeaker Systems. Parts I-IV," *Jour. AES*, vol. 21, nos. 5-8 (June-October 1973).
8. A. N. Thiele, "Loudspeakers in Vented Boxes, Parts I and II," *Proceedings of the IRE Australia*, vol. 22 (August 1961).

# Before you invest in new studio monitors, consider all the angles.

No one has to tell you how important flat frequency response is in a studio monitor. But if you judge a monitor's performance by its on-axis response curve, you're only getting part of the story.

Most conventional monitors tend to narrow their dispersion as frequency increases. So while their on-axis response may be flat, their off-axis response can roll off dramatically, literally locking you into the on-axis "sweet spot." Even worse, drastic changes in the horn's directivity contribute significantly to horn colorations.

## Introducing the JBL Bi-Radial Studio Monitors.

At JBL, we've been investigating the relationship between on and off axis frequency response for several years. The result is a new generation of studio monitors that provide flat response over an exceptionally wide range of horizontal and vertical angles. The sweet spot and its traditional restrictions are essentially eliminated.

The key to this improved performance lies in the unique geometry of the monitors' Bi-Radial horn! Developed with the aid of the latest computer design and analysis techniques, the horn provides constant coverage from its crossover point of 1000 Hz to beyond 16 kHz. The Bi-Radial compound flare configuration maintains precise control of the horn's wide  $100^{\circ} \times 100^{\circ}$  coverage angle.

1. Patent applied for.

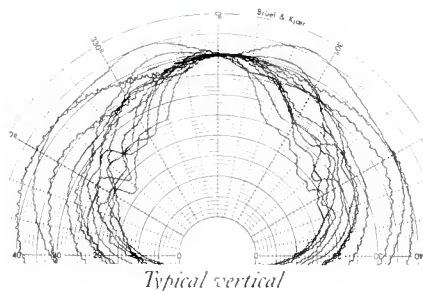
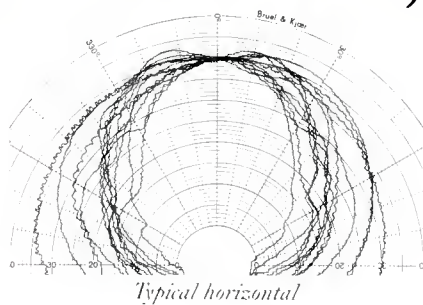

*Polar response comparison of a typical two-way coaxial studio monitor and JBL's new 4430 Bi-Radial studio monitor from 1 kHz to 16 kHz.*

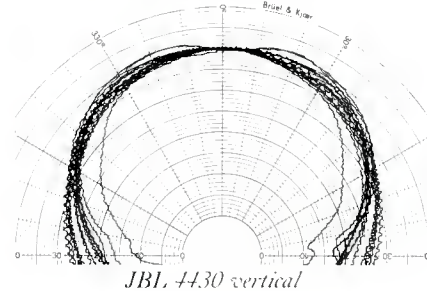
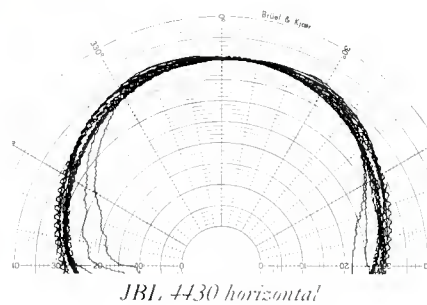

And the Bi-Radial horn's performance advantages aren't limited to just beamwidth control. The horn's rapid flare rate, for instance, dramatically reduces second harmonic distortion and its shallow depth allows for optimal acoustic alignment of the drivers. This alignment lets the monitors fall well below the Blauert and Laws criteria for minimum audible time delay discrepancies.

But while the Bi-Radial horn offers outstanding performance, it's only part of the total package. The new monitors also incorporate JBL's most advanced high and low frequency transducers and dividing networks. Working together, these

components provide exceptionally smooth response, high power capacity, extended bandwidth, and extremely low distortion.

## Judge For Yourself

Of course, the only way to really judge a studio monitor is to listen for yourself. So before you invest in new monitors, ask your local JBL professional products dealer for a Bi-Radial monitor demonstration. And consider all the angles.

James B. Lansing Sound, Inc.  
8500 Balboa Boulevard  
P.O. Box 2200  
Northridge, California 91329 U.S.A.

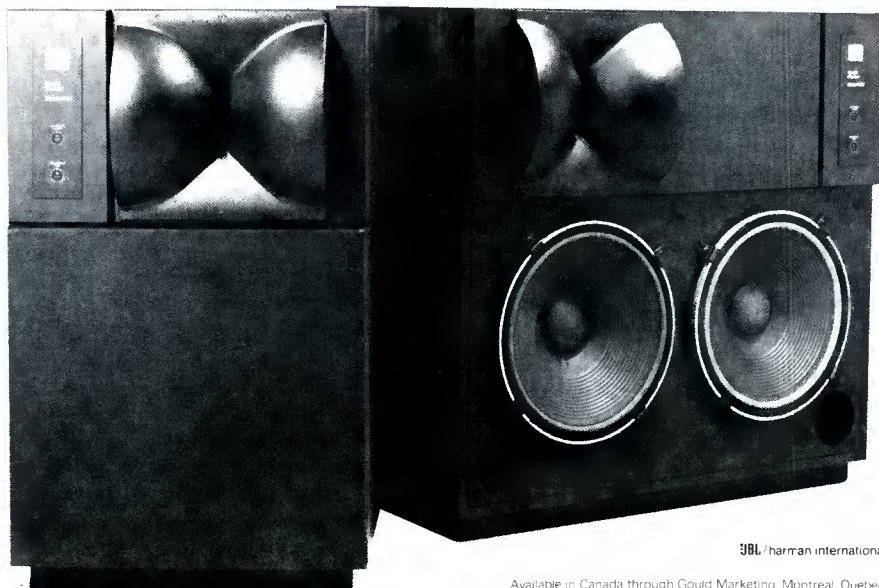

**JBL** Professional Products Division

JBL/harman international

Available in Canada through Gould Marketing, Montreal Quebec.

Circle 32 on Reader Service Card

## The Audioprocessor

• Friends—let's consider reality for a moment. While we weren't looking, the entire entertainment industry was transformed. And audio people—don't turn away—yours is essentially an entertainment commodity. Coin-operated amusement games have shifted the way people spend their leisure time and their leisure money. The U.S. coin-operated amusement game industry earned approximately \$5 billion in 1981. And that outranks the domestic film and recording industries combined. It was a, truly ominous day for the recording industry when the Pac-Man tune became a hit record. Consider what that indicates about the interests of the contemporary (and formerly, record-buying) public. Is that the recording industry's fate—to be a spin-off to other more sophisticated forms of entertainment?

Well, that last statement was merely a speculative one; my reality-span has diminished substantially lately—it's down to about ninety seconds. But surely you get my point. We must ask ourselves, "What is it about these video games?" Hard to tell—we'll have to ask a social scientist. But one thing is for sure. The games are technically sophisticated devices which can perform very complicated and entertaining tasks while utilizing relatively cheap hardware and software. In part, they are successful because they contain microprocessors. Now, I submit to you that ours is the age of microprocessing. Many types of electronics without such a technical advantage are essentially obsolete because their performance and cost are ineffective. Consider for a moment the kind of video, and audio extravaganza a Pac-Man game delivers for a quarter. Meanwhile, you're sitting in a control room filled with knobs, and you have to fiddle with every one of them to get your product, turning something to vary frequency, pushing something else to attenuate gain. No wonder one can't compete. To become competitive again, the recording studio must allow itself to be overcome by superior technology, to be replaced by microprocessors. We are tired of being antediluvians—we want the audioprocessor.

Sure, the idea isn't new. It's been around since the early days, and everybody has discussed the issue and outlined the scheme to revolutionize the audio industry. Yet that revolution is slow in coming. Audio people are still stuffing metal boxes with discrete circuitry and controlling them with plastic

knobs and calling them phasers, flangers, delay lines, reverberators, and equalizers, and they are still building heavy furniture covered with the same kind of knobs, and calling them mixing consoles. It's simply embarrassing, or criminal, depending on your point of view. Hardwiring is antiquated—a technological curiosity. The idea of a fixed-function, single-purpose, single-minded circuit is obsolete. Audio devices can be much smarter than that now, because they can have microprocessors.

### THE REVOLUTION

It's easy (the very nature of new technology makes itself accessible), and we might save the recording industry yet. Everyone knows that in terms of cost effectiveness, flexibility, and artistic creativity, microprocessor-controlled audio could easily overtake any other method of signal processing. There only remains the final step: the development of an audio computer—the audioprocessor. The hardware is simple—it is a general-purpose device, potentially as well suited to flange a guitar as provide more ambient space for Mahler's Second. The devices are all apparently identical and essentially consist of a preamplifier input, an input filter, A/D conversion, a controller, D/A conversion, and an output filter. Then given that general purpose module, a library of software is the only thing we need to accomplish signal processing—any processing heuristically conceivable. Simply a question of redundant modules and software. That's all.

Let's consider the idea of a contemporary programmable system. More than anything, it's a question of miniaturization. Beginning with the development of discrete transistor technology in the early 1950s, the evolution has carried us toward a consolidation of circuitry, through small, medium, large, and now very-large-scale integration (VLSI). It doesn't make sense to work with individual components when entire subsystems, and even systems themselves, can be placed on a single chip. Of course, all systems are different, but chip development is costly, and unique integrated circuits would be tremendously inefficient. Thus, we choose the idea of standard, mass-produced chips—VLSI models which can be instructed to serve a variety of needs; you can use it for a fast Fourier transform, but I need it in my Men-From-Mars game.

### MICROPROCESSORS

Of course, companies have been marketing general purpose programmable systems for quite a while—they are called computers. But now, from the sophistication of miniaturization of individual chips has evolved the reality of the System-on-a-Chip, mass-produced to make it cheap, yet still sophisticated. These are called microprocessors. And they have emerged like a new species of radiation-hardened cockroaches to conquer the world. Today microprocessor innovation is commonplace, programmability is mandatory, and every industry can enjoy the benefits of that revolution—even audio.

We think of it as a familiar 40-pin package, although it's actually a silicon square about half a centimeter on a side. It is a complex device internally, containing a controller, a microprogram memory, an ALU, an array of registers, buffers, latches, flip-flops, decoders, multiplexers, and tri-state outputs, and the bus architecture between those components varies from model to model. With appropriate memory they can be programmed to control almost any process imaginable. Some are completely microprogrammed like a calculator to perform only a certain set of functions. With ROM they become dedicated programmable controllers, and with the addition of addressed RAM, they are microcomputers. The microprograms are permanently stored inside the CPU, the controller reads each instruction from memory, executes it and then proceeds to the next instruction. The conditional instructions cause the microprocessor to jump nonsequentially to a designated program step only if a special condition is met. These instructions are manifestly important. With them, the system is more than a complex logic unit, it is a computer.

So much for background. (Am I being paid by the word? Suffice it to say that the microprocessor opens a new dimension to circuit autonomy. It is now standard design procedure to choose a microprocessor to be the basic logic element in a whole family of related equipment. A microprocessor clustered with timing circuitry, ROM and RAM, and interface chips would be identically located in many different pieces of equipment which otherwise differ according to their use. But the only essential difference rests with the software which uniquely defines the special function. (It is by the

# POWER. PRECISION. CHOICE.



Build yourself a stronger reputation by selecting the unique flexibility and professional performance of two new Crown power amps: the PS-400 or the PS-200.

Choose only the special, low-cost options you need: plug-in balanced input, active or passive; 70-volt transformer; dual fans. Install them easily, quickly, anytime, in any combination – thanks to the fresh, innovative design of these amps.

Built-in features make these amps the first choice of professionals: instant mono/stereo conversion, terminal strip connectors plus phone jacks, IOC™ and signal-present indicators, low-frequency protection, and much more.

Select the power level you need. For full-time, reliable performance, both amps are built in the best Crown tradition. PS-200 rated (FTC) at 135 watts per channel into

4 ohms, PS-400 at 260. Mono ratings into 8 ohms are 270 watts (PS-200) and 520 (PS-400).

Introduce yourself to the new Crown MULTI-MODE™ output circuit, a new, three-deep design that eliminates audible distortion, and introduces a degree of precision sound reproduction that will delight performers and audiences.

Complete information on specifications and prices, for the amps and the optional accessories, is now available from Crown. For quick action, simply fill in the blanks below and send this corner of the ad to Crown.

Name \_\_\_\_\_

Address \_\_\_\_\_

City \_\_\_\_\_ State \_\_\_\_\_ Zip \_\_\_\_\_



PS-200



**crown**®



PS-400

...WHEN YOU'RE READY FOR REAL!  
1718 W. Mishawaka Rd., Elkhart, IN 46517, (219) 294-5571

Circle 24 on Reader Service Card

word, isn't it?) Thus we have redundant hardware, and unique programs. And, of course, when the function has to be changed, it is only a software modification, the hardware stays the same.

So, what about audio? The micro-processor is clearly a force to be reckoned with. Everything from tape machine counters to delay lines to automation packages have been designed around the ubiquitous product. And yet, the real beauty of the chip has not been exploited. There still remains the development of a general purpose hardware module—some kind of rack of micros—each potentially able to accomplish any designated signal processing. Need 24 compressors? Program for it. Or how about 24 delay lines? Re-program. Or how about a rack with three parametrics, four flangers, eight reverberation devices, five frequency multipliers, and four processors doing things no one has names for yet? Program! And don't forget a little bit of rack space so you can get rid of that dumb console that's been ruining your acoustics all these years.

All that we need is a module (or will it soon all be on a chip itself?) with an input filter, A/D, processor, D/A, and output filter—being driven by our designated program, accessed through a terminal. Sure, that hardware isn't cheap, but remember how many other pieces of gear it replaces. Think for a minute longer and consider that eventually that kind of

module could replace your entire studio, tape machines and all. Back to the idea of modules in your rack. It's still not cheap for 24 of them (16-bit converters are especially painful), but if you're on a budget, go with a 12-bit system for awhile; your flanger won't mind, and neither will the reverberation. I don't think the cost of hardware is going to be a problem in the future (you heard it here first).

#### SOFTWARE

Now let's consider the fun part—software. The first step is to write a straight-wire program. We can accomplish that by inputting data from the converter and outputting it without any processing. A simple loop does that, but remember that your processor is running a lot faster than your sampling rate of 20 kHz, so you will have to put in some NOPs to slow the program down. Speaking of sampling rate, that shouldn't be a problem; most good microprocessors are up to 6 MHz now, so the limiting factor will be the A/D converter, and they are getting faster too.

Once you have converted an analog function into digital samples, time is only a question of how long you want to store the information. Processing such as time delay, phasing and reverberation poses little problem, since it's simply a question of programming and memory size. Many programming techniques

could be used. (I refer interested readers to articles in BYTE magazine—the world's (second) best magazine, by O'Haver (June 1978) and Grappel (February 1978)—both are archaeologist's delights.) Perhaps the cleanest technique is a circulating data buffer, a first-in, last-out shift register. New data is continually added into the buffer as old data is released to the D/A. By scaling the process, different time delays and different effects are created. Short delays result in the familiar cancellation and reinforcement of a comb filter. As that delay varies in real time, flanging is produced. Longer cycle times through the buffer create echo which decreases in amplitude according to the programmed divisor decreasing the value of the sample each time as it passes through the buffer—the echoes die out ... die out ... die out ... Multiple data pointers cycling through the stack would yield reverberation, and each reflection could be digitally filtered to best simulate the acoustic effect of the reflecting surface. Obviously the complexity of this operation would tax most contemporary microprocessors—most likely the job would have to be shared among several.

The idea of a digital filter raises the opportunities for waveform modification. Transfer functions could be stored through which the data is passed in various manners, as in non-linear mapping. A linear table would return us to the straight-wire condition, a square wave table would simulate the musicality of a clipping amplifier, exponential shapes would yield fuzz effects, and overtone functions would produce frequency multiplication. And other functions, as yet undefined, would produce entirely unique sounds—the system really is limitless.

It's a great idea—why hasn't someone marketed a general-purpose audio computer yet? It's a problem of price more than anything else. Such a system, utilizing 16-bit hardware, would require still-costly technology. But consider how quickly digital tape recorders reached the consumer marketplace—thanks in part to VLSI chips. In the same way the declining cost of other computer hardware will soon make an audio computer very competitive with existing equipment in price, and in sound quality. The audio computer—the idea remains tempting and beautiful. It will happen, it's too good not to. The power of programmability will make believers of us all. And maybe we have no choice. Sooner or later, the A/D will take place at the microphone, or there will be a digital microphone, and there will be a box of hardware in a closet somewhere, and your software studio, your audioprocessor, will handle the rest. You can just sit back and pay the bills—well, the computer will handle that too. You can take the day off. Go out and have some fun ... Play some video games. ■

## BASS THAT MEANS BUSINESS!



### GOOD BUSINESS

- WEATHER-RESISTANT fiberglass
- LESS WEIGHT than wooden horns
- LOWER COST than wooden horns
- HORN PERFORMANCE as low as 50 Hz
- EXCELLENT SOUND QUALITY
- EIGHT MODELS accept 15" or 18" speakers
- AVAILABLE FROM STOCK on most orders

### YOUR BUSINESS

- CALL (800) 523-4935
- [(215) 727-0900 IN PENNSYLVANIA]

# Community

5701 Grays Avenue □ Philadelphia, PA 19143 □ (800) 523-4935

# With An Otari Duplicating System, You Can Duplicate The Success Of These Duplicators.

When it comes time to make the decision to expand your business capabilities in high-speed duplicating, it's also time to seriously consider the OTARI DP-7000 High-Speed system. It's an endless loop, 64:1/32:1 system that's specifically engineered for the tough environments and continuous-duty operation that's demanded in the professional facility.

Here's two testimonials from DP-7000 users that tell this story best:

## Frank Gspann, Sound Arts Co., New Jersey:

"We're a recording studio and duplicating company. In the studio we've worked with a pair of Otari 5050's for over four years and they have literally been Workhorses. So, we decided to invest in the DP-7000 High-Speed system when we wanted to expand our cassette duplication operation to a high-speed, high-output line. We duplicate a variety of materials from spoken word to computer program cassettes, which are much more demanding than music cassettes. The quality has been so consistently high that we violate all the rules and use the DP-7000 for some of our short runs because we know the product will be better. In this competitive business, you've got to sell a better product or you won't make it. The Otari DP-7000 lets us do that... The and profitably."

## Leonard Gross, Custom Duplication Inc., Los Angeles:

"Custom has been in the high-speed duplication business for a number of years and we had to add another line. In this business reliability and performance are number one, ...but, in today's economy, price is a close second. When we checked around, we discovered that our money could buy two OTARI systems for close to the cost of a single system from the nearest competitor. The Otari is already putting-out almost half our total volume of four to five million cassettes a year... and that includes everything from spoken word Bibles to game and program cassettes for one of the largest game/computer manufacturers."

Let Otari's over 15 years of experience as a world leader in tape duplication systems go to work for you as it has for Frank and Leonard. Find out how an Otari DP-7000 can be a profitable, economical addition to your company. Call Michael Pappas at OTARI (415) 592-8311. He'll tell you how you can duplicate the success of the duplicators.

**OTARI**<sup>®</sup>  
The New Workhorse

Otari Corporation  
Industrial Products Division  
2 Davis Drive Belmont, CA 94002  
(415) 592-8311 Telex: 910-376-4890

Please send me more information on the Otari DP-7000.

Name \_\_\_\_\_  
Address \_\_\_\_\_ State \_\_\_\_\_  
City \_\_\_\_\_  
Zip \_\_\_\_\_  
Phone \_\_\_\_\_

Mail to: Otari  
2 Davis Dr., Belmont, CA 94002

Circle 18 on Reader Service Card

## Digital Filters: The Basic Types

• In last month's column, we introduced the concept of the digital filter, made up of a delay line and some attenuation. This month, let's consider some of the interesting variations of filters.

Before we begin, we should review some aspects of analog filters. We often speak of the type of filter, using such names as Butterworth, Elliptic, Chebyshev, Bessel, etc. These names describe certain properties of the idealized shape of the filter's response. In most cases, the names are of the scientists who developed the mathematics of certain functions; these functions play a role in electronic filter design.

In the analog filter, mathematics is used to determine the ideal location for "poles" and "zeros," which are difficult to explain here because they rely on the concept of two kinds of frequencies: real and imaginary. For our purposes, the number of poles is equivalent to the number of capacitors and inductors in the total filter. Hence, it is the filter's order number. The number of zeros is the number of frequencies which have zero transmission. There is no easy way to determine this from a circuit without thoroughly analyzing it.

Implementation (that is, what kind of circuit is to be used), is another aspect of filters. Different circuits may have identical performance, with the same number of poles and zeroes, yet other circuit properties are quite different. For example, one circuit may be much more sensitive to component errors.

Digital filters can be classified in the same way. Again, mathematics define the poles and zeroes, which may be related to the number of delays in the filter. However, this is not always the case.

Next, digital configuration architecture is much like analog circuit design. In one sense, digital filters are simpler because we have only two kinds of elements: delay and gain. Analog filters have two kinds of storage information (capacitor and inductor) and two kinds of gain control (current and voltage).

### FIR AND IIR FILTERS

Digital signal processing uses one of two kinds of filters: FIR (Finite-Impulse-Response), or IIR (Infinite-Impulse-Response). The definitions will be clarified later on, but for the moment let's define FIR as a filter which contains no feedback, and IIR as one which does contain feedback.

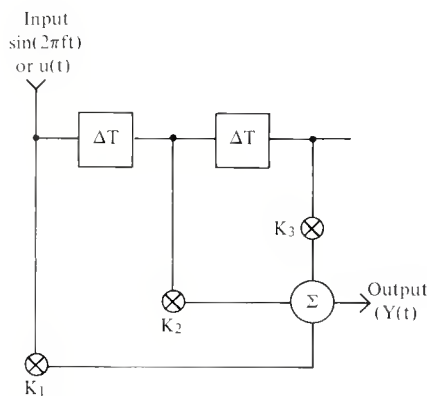

Figure 1. A low-pass digital filter with two delay elements and three gain elements. Each delay interval is usually one sampling interval in duration.

FIGURE 1 shows a three-tap filter using two delay elements and three gain elements. To determine the filter characteristics, we supply a sinewave  $\sin(2\pi ft)$  to the input, and determine the magnitude of the output sinewave. But first, let's add some constraints. All delays will be one sampling interval long, and the first and last gain coefficients ( $K_1$  and  $K_3$ ) will be the same. Second, let us normalize the coefficients so that the DC gain is 1. In other words,  $K_1 + K_2 + K_3 = 1$ . And, since  $K = K_3$ , then  $2K_1 + K_2 = 1$ , and  $K_2 = 1 - 2K_1$ .

For an input sinewave,  $\sin(2\pi ft)$ , we get an output of  

$$Y(t) = K_1 \sin(2\pi ft) + K_2 \sin(2\pi f(t - T)) + K_3 \sin(2\pi f(t - 2T)).$$

Those who like playing with trig will discover that this is the same as

$$Y(t) = [K_2 + 2K_1 \cos(2\pi fT)] \sin(2\pi f(t - T)).$$

Notice that the expression in the brackets is the magnitude gain of the filter, as a function of frequency and sampling period. If this expression turns out to be negative (e.g., when  $2K_1 > K_2$ ), this

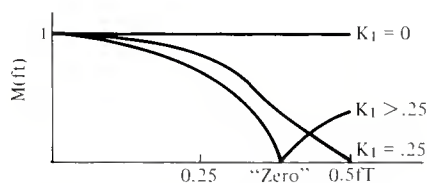

Figure 2. A plot of frequency versus amplitude for various values of  $K_1$ . When  $K_1 > 0.25$ , the response beyond the "zero" is 180 degrees out-of-phase.

simply indicates a 180-degree phase shift, and not a "negative gain." The last term is just the input sinewave, delayed by one sampling interval. The curve represented by the term in brackets is shown in FIGURE 2.

In the figure, notice that our horizontal axis uses the product,  $fT$ , as the frequency scale. This is a fraction of the sampling frequency. When  $fT = 0.5$ , the real-world frequency is half the sampling rate. At  $fT = 0.25$ , the frequency is one-quarter of the sampling rate, or half of the usable bandwidth.

This is a nice low-pass filter, with a fixed delay and no phase distortion, since the taps are symmetrical. To understand this, consider the center tap,  $T_2$ , as our reference point. The earlier tap is like a prediction, since it comes earlier. The later tap is like a delay, since it comes afterwards. With an equal amount of prediction and delay, there is no tendency for the signal to be advanced or delayed relative to the center. However, the center tap is of course delayed by one sampling interval. Thus, in such a filter there is never any phase effect except for the center-tap fixed delay.

We do not have much design freedom in this type of filter—only the choice of  $K_1$ .  $K_2$  is then defined ( $1 - K_1$ ) by the constraint that we wish the DC gain to be 1.

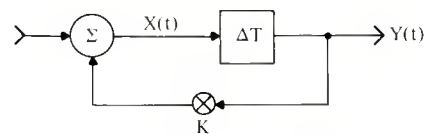

Figure 3. A representative Infinite-Impulse-Response (IIR) filter.

### IMPULSE RESPONSE

Instead of analyzing the filter this way, we could put a single impulse into it, and three versions of the impulse will appear at the output. Mathematically, if we say that our impulse is  $u(t)$ , then we get an output of

$$Y(t) = K_1 u(t) + K_2 u(t - T) + K_3 u(t - 2T).$$

continued on page 22



# There is a Dolby® noise reduction unit for every professional application

## Professional Recording and Transmission Applications



**360 Series.** The Dolby 360 Series are basic, single-channel A-type noise reduction units for encoding or decoding. With the model 360, the operating mode is manually selected, and the unit is normally used in a fixed encode or decode mode such as in disc cutting or landline sending and receiving. With the model 361, the operating mode changeover can be controlled automatically by a tape recorder by means of relay switching.

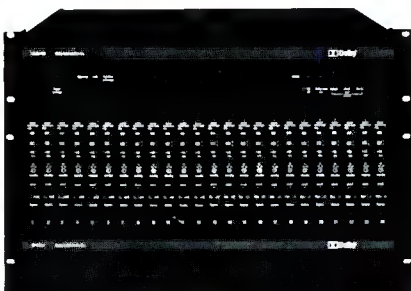

**SP Series.** The Dolby SP Series noise reduction units contain up to 24 tracks of A-type noise reduction in only 12 1/4" of rack space. They are designed specifically for professional multi-track recording, and are available in virtually any track configuration (SP-24 pictured).

## Noise Reduction Modules



**Cat. No. 22 and Cat. No. 55.** The Dolby Cat. No. 22 A-type noise reduction module is the basic functional unit employed in all free-standing Dolby noise reduction units and cinema sound processors. It is available as a spare or in quantity for OEM users. The Cat. No. 55, used in the Cat. Nos. 221 and 255 is a miniaturized A-type noise reduction module particularly suited for such OEM uses as building into audio and video tape recorders.

## Cinema Sound



**CP50.** The Dolby CP50 cinema sound processor is for the reproduction of all optical sound-track formats, including Dolby Stereo optical two-track, four-channel release prints. Standard circuitry includes two-channel optical preamplifier, two channels of Dolby A-type noise reduction, center channel/surround decoder, and third-octave equalization for left, center, and right screen speakers.

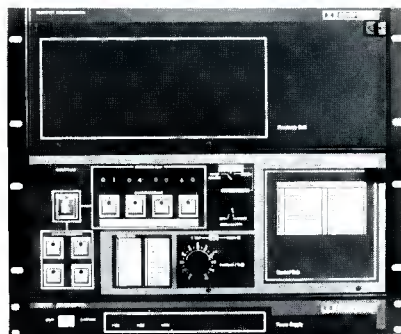

**CP200.** The Dolby CP200 cinema sound processor reproduces all current and presently foreseeable film sound-track formats, including 35 mm Dolby Stereo optical and 70mm Dolby Stereo six-track magnetic. In addition to providing comprehensive processing circuitry, the CP200 features an electronic format memory which greatly simplifies sound-track format selection and changeover in the theatre.

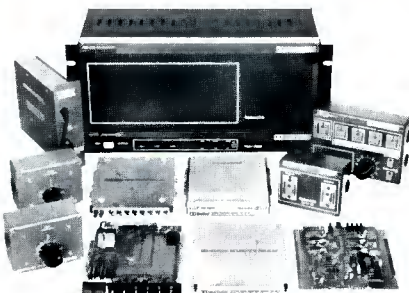

**Cinema Sound Accessories.** A wide variety of accessories are available for both the CP50 and CP200, including remote faders and control units, additional third-octave speaker equalizers, magnetic preamplifier units, spare power supplies, optical bass extension circuitry (standard with CP200), and automation interface modules.

## Professional Encoders for Consumer Media



**330 Series.** The Dolby 330 Tape Duplication Unit is a professional-quality unit for encoding duplicating master tapes with consumer Dolby noise reduction characteristics used in the duplication of audio and video cassettes, open-reel tapes, and cartridges. It is supplied with the Cat. No. 66 B-type NR module and/or the interchangeable Cat. No. 219 C-type NR module. Versions are available for half-speed mastering and other special applications.

The model 334 FM Broadcast Unit is for encoding stereo FM broadcasts with the Dolby B-type NR characteristic, while providing a reduction of high-frequency pre-emphasis to 25 microseconds. Dolby FM broadcasting substantially reduces the need for high-frequency limiting, which improves reception quality for all listeners; listeners with receivers equipped with Dolby FM decoders enjoy an improvement in signal-to-noise ratio as well.

## Professional Video Tape Recording



**Cat. No. 221 and Cat. No. 255.** The Dolby Cat. No. 221 and Cat. No. 255 are two-channel A-type noise reduction modules which plug directly into 1" Type C video tape recorders and improve their audio performance to nearly professional studio quality. The Cat. No. 221 is for use in Sony® BVH 1000/1100 machines, and the Cat. No. 255 is for use in the Ampex® VPR-2.

## Accessories

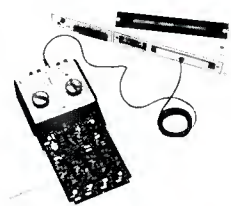

**Cat. No. 35 Test Set.** The Dolby Cat. No. 35 permits rapid verification of performance of Cat. No. 22 noise reduction modules without additional test equipment. It is particularly recommended for the professional music recording or film sound studio equipped with many tracks of Dolby A-type noise reduction.

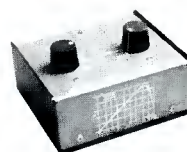

**Cat. No. 98A Noise Weighting Filter.** The Cat. No. 98A uses the CCIR/ARM characteristic and operates with an average responding meter (ordinary mil/voltmeter) to make noise measurements on tape recorders, tapes, FM receivers, etc., which correlate closely to the subjective effect of the noise. The CCIR/ARM characteristic is in wide use throughout the world; the Cat. No. 98A can be used for testing both professional and consumer audio equipment.



Dolby Laboratories, Inc., 731 Sansome Street, San Francisco, CA 94111, Telephone (415) 392-0300, Telex 34409.

346 Clapham Road, London SW9, Telephone 01-720-1111, Telex 919109.

Dolby and the double-D symbol are trademarks of Dolby Laboratories Licensing Corporation. S82/2518/3730

Circle 14 on Reader Service Card

# Still The Best Investment In A Professional Two Channel Tape Machine.

## The Otari MX-5050B

There's a very simple, straightforward reason the MX-5050B has become the world's best-selling professional tape recorder: value. If you were to ignore all of the production features, dismiss the six year track record for unsurpassed reliability, you would still discover that the "B" is the best performing machine for your money. When you shop around you'll find out that it's easy to spend a little less or a lot more, but very difficult to justify to yourself that you are getting more. When you compare other machines, spec' by spec', you'll begin to see why there's more value in putting your money into an Otari. Spec's of course, don't tell the whole story. But, it's a damn good place to start your serious comparisons.

To experience the full potential, and thus the value of any product you purposely put it to the test. After a few hours in the studio or on location, you can become painfully aware of the differences between a professional machine and those with a Hi-Fi heritage. Because Otari's only business is to serve the dedicated audio professional, you won't find cosmetic facelifts every couple of years; or, dredged-up product from another era that's labeled "Pro." At Otari we improve each product by subtle engineering refinements that make the basic product that much better—without fanfare and expensive model changes that you end up paying for. And the "B" is the embodiment of this philosophy. It's been around for three years (5050 Series, 6 years) and we plan you'll keep it around a lot longer. If you're a knowledgeable audio person who already owns an Otari you'll know what we're talking about. If you're not, then it is well worth your time to review the Performance and Feature facts we've

detailed in this ad. If you're in the market for a fully professional, super-reliable two-track, the time you spend to acquaint yourself with the "B" just might mean the difference between spending your money on a machine that will do for now—or deciding to make the investment in a basic creative tool that will pay you back handsomely in the years to come.



### THE FACTS: PERFORMANCE.

Overall Signal-to-Noise: 66 dB unweighted @ 520 nWb/m, 30 Hz to 18kHz.  
Dynamic Range: 72 dB unweighted: 30 Hz to 18 kHz.  
Headroom: +24 dB. Maximum output: +28 dBm.  
Overall Frequency Response: 30 Hz to 22 kHz  $\pm 2.0$  dB (15 ips @ +4 dBm).  
Playback Frequency Response: 31.5 Hz to 20 kHz  $\pm 2.0$  dB (15 ips @ +4 dBm).  
Distortion: less than 0.7%, 1 kHz @ 250 nWb/m.  
Crosstalk: greater than 55 dB, 1 kHz, adjacent tracks.  
Wow and Flutter: less than 0.05% (15 ips).  
Rewind Time: 90 seconds for 2500 feet.

### THE FACTS: FEATURES.

Three switchable speed pairs: 15/7½ or 7½/3¾ ips (automatic equalization).  
NAB/IEC selectable equalization.  
Selectable +4 or -10 dBm output.  
D.C. servo capstan motor with  $\pm 7\%$  varispeed control.  
Selective reproduce for overdubbing.  
Four heads: ½ track erase, record, reproduce, ¼ track reproduce plug-in assembly.  
Noise-free punch-in/out; transport remote (optional).  
Built-in test oscillator.  
Front panel adjustable bias and equalization.  
Choice of three alignment levels: 185, 250 & 320 nWb/m.  
Dump edit and tape lifter defeat; precision aligned; and indexed splicing block.  
Zero memory return.  
10½" reel capacity; XLR connectors.  
Large, illuminated V.U. meters with adjustable peak-reading L.E.D. indicators.  
Independent Mic/Line mixing (20 dB pad).

### THE FACTS: PRICE.

\$2,295.00 Suggested Professional Net.

Your nearest Otari qualified professional audio dealer has The New Workhorse in stock. Check-out for yourself why you should place your money on the MX-5050B. If your dealer shows you anything but an Otari, tell him, "No thanks, I'm only interested in making a sound investment."

Call us for the name of your nearest dealer.

The New Workhorse

**OTARI**®

OTARI CORPORATION  
2 Davis Drive  
Belmont, CA 94002  
(415) 592-8311

© Otari Corp. 1981

Circle 31 on Reader Service Card

# THE NEW WORKHORSE



Notice the correspondence between these terms and those we found with the sinewave input.

### INFINITE IMPULSE RESPONSE

The IIR filter shown in FIGURE 3 has an infinite impulse response because of feedback. Analysis is more difficult without using mathematics, but we will try to do so with a simple sinewave. As before, consider the input to be  $\sin(2\pi ft)$ , and the output as some amplitude,  $A$ , of a similar sinewave with a phase shift of  $\theta$ . The task is now to find the values of  $A$  and  $\theta$ , as a function of frequency.

The task is difficult with feedback, but there is an old trick. By assuming we know the output, which we don't, we look at the summing point to see what signals are present. The summing point has two inputs and one output. Since we have assumed that we know the output, we can write

$$X(t) = \sin(2\pi ft) + KA \sin(2\pi ft + \theta).$$

The next step is to observe that the summing point output,  $X(t)$ , is related to the actual output,  $Y(t)$ , by the delay element.  $X(t)$  and  $Y(t)$  must be the same, except for the delay. This allows us to write

$$Y(t) = X(t - T), \text{ or}$$

$$A \sin(2\pi ft + \theta) = \sin(2\pi f(t - T) + \theta) +$$

$$KA \sin(2\pi f(t - T) + \theta).$$

This is complex to solve unless you have lots of extra time, so here are the answers:

$$A = 1 / (1 + K^2 - 2K \cos(2\pi fT))^{0.5}, \text{ and}$$

$$\theta = 2\pi fT - \arctan [(\sin(2\pi fT) / (\cos(2\pi fT) - K))].$$

The fact that these look complex is not important. If we plot the frequency response, we see that it is a low-pass filter as shown in FIGURE 4. Moreover, we can adjust  $K$  to vary the cut-off frequency. In some sense, this filter can be made to be a better filter since we can control the cut-off frequency. On the other hand, notice that there is real phase distortion, rather than just a constant delay.

The gain at DC does not stay fixed but rises to a value of  $1 / (1 - K)$ . To give this filter unity gain requires us to add a gain at the output to offset this factor. We would need a post-multiplier of  $1 - K$  to re-normalize the output. If you have a calculator or computer available, you can easily program it to calculate the various frequency responses at different values of  $K$ .

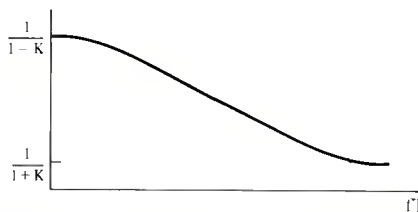

Figure 4. The frequency response of the IIR filter seen in Figure 3.

But now, instead of a sinewave, let us suppose that we place an impulse at the input to the system. This pulse will appear at the output at  $T = 1$ , with an amplitude of 1 unit. It would also go around the feedback path and re-enter the delay to emerge at  $T = 2$ , with an amplitude of  $K$  units. At  $T = 3$ , it would be  $K^2$  units, and so on. When  $K$  is less than 1, the amplitude will approach zero asymptotically (that is, closer and closer, but never arriving there). Thus, there is less an Infinite Impulse Response (IIR). We now see that the names really mean "with feedback" (IIR), and "without feedback" (FIR). Of course, we could mix the two types in one design.

### FREQUENCY ALIASING

In all of the above examples, notice that the delay-line segments are always one sampling interval long. But now, let's look at a filter with a delay of two sampling intervals, and consider the relationship between input and output. Begin by taking the highest frequency possible (that is, half the sampling rate). In one sampling interval of delay, there can be a phase shift of half-a-sinewave, or 180 degrees. In two delay units there will be a full cycle, or 360 degrees, and at this

frequency the output is the same as the input. As before, the DC output is also the same as the input. Thus the response of such a filter must be the same at both DC and  $f_{MAX}$ .

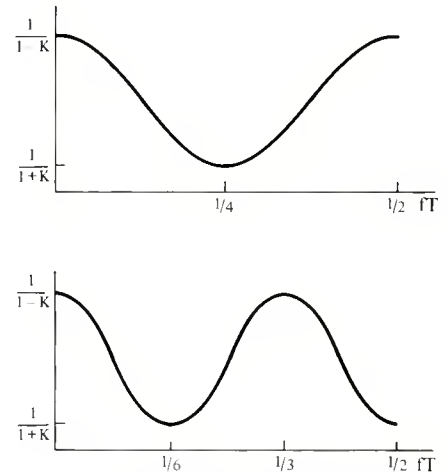

Figure 5. The frequency response of an IIR filter when the delay is (A) two sampling intervals long, and (B) three sampling intervals long.

Now, let's look at a different sinewave, with 45 degrees of phase shift in the two units of the delay. And still another sinewave with 315 degrees will also have the same output. In other words, there are always two symmetrically-placed frequencies which have the same response. So if we use segments of two-unit delays in the filter of FIGURE 3, the response look like that shown in FIGURE 5A. Notice that the response is "folded over," at one-quarter  $f_s$ . With a delay of three sampling intervals, the symmetrical response is folded at one-sixth  $f_s$ , and again at one-third  $f_s$ , as seen in FIGURE 5B.

This foldover response is called frequency response aliasing. It is important not to confuse response aliasing with the previously-discussed alias frequencies. In the digital filter, the signal frequencies are not affected, or aliased, since that is strictly a function of the sampling rate. Here, the response is aliased, which is quite a different matter. And since response aliasing is not usually desirable, digital filters use delays of one sampling unit between segments.

### COMPLEX FILTERS

Real digital filters are made up of more complex versions of those which we have just discussed. The method for choosing the values of the gain coefficients is extremely complex, and often requires special computer programs to do the computation. Only a few cases can be presented in simple form. That is a sad-but-true fact. Otherwise, digital filter design would actually be easy! ■

## Audio Tape for professionals

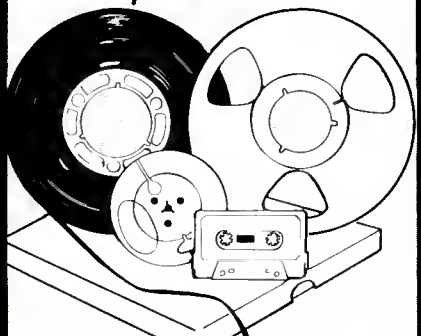

**REEL TO REEL TAPE**  
Ampex, 3M. All grades.  
On reels or hubs.

**CASSETTES, C-10—C-90**  
With Agfa, TDK tape.

**LEADER & SPLICING TAPE**  
**EMPTY REELS & BOXES**  
All widths, sizes.

**Competitive!**  
**Shipped from Stock!**

Ask for our recording supplies catalog.

**Poly Corp.** 312/298-5300  
1233 Rand Rd. • Des Plaines, IL 60016

Soundcraft, Inc.  
 20610 Manhattan Place  
 Suite 120  
 Torrance, CA 90501 USA  
 (213) 328-2595  
 Telex: 182-499

**INTRODUCTORY  
 SPECIAL**  
 APPROVED BY WF

**Soundcraft  
 Electronics** 

5-8 Great Sutton Street  
 London EC1V 0BX England

DATE JUNE 8, 1982

INVOICE

N<sup>o</sup> 2498

TO:- SYNCHESTRA STUDIOS  
 3127 North 33rd Avenue  
 Phoenix, AZ 85017

CUST/ORDER NO. PHONE	F O B TORRANCE	SHIP VIA BEST	TERMS NET 30	SALESMAN FREEMAN	OUR ORDER # SC-022
-------------------------	-------------------	------------------	-----------------	---------------------	-----------------------

QUANTITY	DESCRIPTION	AMOUNT
1	SERIES 1600 24-TRACK RECORDING CONSOLE with 24 inputs, 24 track monitoring, 8 Aux sends, 4-band semi-parametric EQ	\$19,950
1	METER BRIDGE	N/C
1	PATCH BAY	N/C
1	FLOOR STAND	N/C
1	POWER SUPPLY	N/C



WA NO	GOODS TOTAL	\$19,950
	INVOICE TOTAL	\$19,950

WHITE: ORIGINAL INVOICE  
 CANARY: NORTH AMERICA OFFICE

GREEN: LONDON OFFICE  
 GOLDENROD: CUSTOMER FILE



# Sound With Images

## Who's Afraid of TV Stereo?

• A couple of months ago, we discussed some of the techniques involved in original and post-production recording of audio for video programming. We dealt with such technical matters as SMPTE time code, the various methods employed in synchronizing separate audio tracks with video frames, and the like. What we didn't discuss at all were some of the artistic and economic considerations involved in live and post-production audio-for-video.

Last month, we also discussed the status of TV stereo and the fact that in as little as a year from now, we just might be faced with a whole new series of problems and challenges. We may be making a transition from mono audio for TV, often of questionable fidelity, to stereo audio of (hopefully) high fidelity. Most of us (especially those who have worked in both recording studios *and* modern broadcast studios) could write reams of instructions (to management) on what's going to be needed, both in hardware and software, to create acceptable stereo audio programming for TV. That is, *after* the FCC grants us permission to go on the air in two-channel stereo (or even bilingual audio). As technically-oriented audio people, we have often been accused (perhaps rightly) of being able to accomplish anything at all when price is no object. The real challenge, our management people keep telling us, is to achieve the desired result (in this case, good-sounding TV stereo) with a minimum cost (or better yet, *no* cost) increase for in-studio and post-production audio.

At the recently concluded Midwest Acoustic Conference—MAC for short—sponsored by the Chicago area AES section, the Acoustical Society of America, IEEE, Chicago Acoustical and Audio Group, and the Illinois Institute of Technology Research Institute, the subject was "Audio Technology for Video." Among the highly informative papers presented during the day-long seminar was one by Dr. Richard R. Green, Senior Staff Scientist, CBS

Engineering Development Department, entitled "Stereophonic Audio Production Technology for Television." If, as a TV audio broadcast engineer or technician, you've been dreading the coming of TV stereo, fear no more. Dr. Green's insights (some of which will be described in the following paragraphs) proved to the MAC audience that it is indeed possible to produce high quality stereophonic sound for TV programs without inordinate increases in production budgets.

Dr. Green reminded us that upgrading television audio has been an ongoing process since about 1978, when all three major networks switched to diplexing for audio (instead of using land phone lines). This provides a frequency response capability all the way out to 15,000 Hz (as good as FM radio). The Public Broadcasting Service, using satellite transmission of audio (and even digital communication in some instances) also provides high-fidelity TV-audio capability. As for post-production audio facilities, in many TV stations and studios these are as elaborate and capable of producing high-quality results (in multi-track and stereo mix-down) as some of the finest recording studios in the country. So the problem, as perceived by Dr. Green, is not so much transmission quality, or even the quality available in post production. Rather, it is a question of how much additional cost will be incurred by having to record original studio performances in stereo, as opposed to the present practice of "live on tape" mono recording.

### DON'T OVER-PAN!

Remember those first stereo records made in the late 1950s and 1960s? Many listeners called them "ping-pong" productions because of the over-use of wide, wide stereo localization that was anything but realistic. But, the producers and engineers were having fun with the new medium, and the novelty aspect was there also.

Today, the small size of the typical TV screen suggests that over-use of stereo panning and overly-wide separation will result in a negative reaction by an audience that has long since tired of "ping-pong" games. Fortunately, this makes it a little easier for the recording engineer and producer to create TV stereo sound that will be both aesthetically satisfying *and* economical. Dr. Green's paper gives three examples of programming and how CBS has experimentally arrived at satisfactory approaches to preparing stereo sound tracks for such programs.

### THE MUSICAL VARIETY SHOW

Even now, most of the musical elements in this type of show are pre-recorded using multi-track recording facilities. So, the tracks could ultimately be mixed down to a two-channel version just as they are now mixed to single-track mono. During the actual videotaping session, vocalists in such productions are generally asked to "lip sync" anyway, so the final audio version (stereo *or* mono) could easily be done in post production, where consoles as sophisticated as those in recording studios are now found.

Even if certain vocal performances need to be recorded "live on tape" at the time of performance, CBS has found that these should be recorded mono; and obviously, there must be no panning whatever of a vocalist who remains center-screen during the entire performance. To pan the vocal track under such visual conditions would lead to stereo exaggerations which the viewer would not tolerate. But so long as the vocalist's track remains centered, the viewer will not object to tasteful stereo placement of accompanying musical instruments, even if these sounds now seem to come from way beyond the screen's limited confines. A microscope placement diagram for a concert or variety TV show was used to illustrate a successful blend for this kind of show,

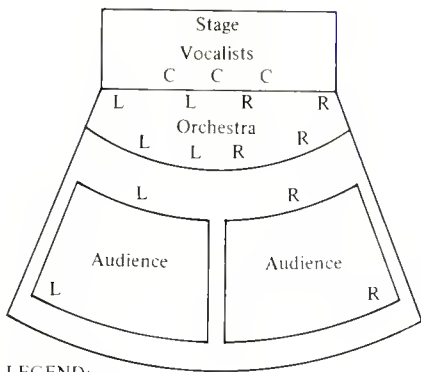

LEGEND:  
 C = Center  
 L = Left channel  
 R = Right channel

and I've reproduced it here (FIGURE 1) as nearly as I can recall the layout. Note that the on-stage mics for vocalists will all be mixed to center, while the orchestral members *and* live audience sounds will be panned left-and-right later on, during post-production mixing with the mono vocal track.

#### DRAMATIC SHOWS

Despite the obvious temptation, Dr. Green suggests that dramatic shows (such as soap operas or even prime-time dramas) do *not* resort to exaggerated stereo effects either. In fact, the final audio for such shows will probably vary only slightly from present-day mono. Again, all dialogue will be retained in mono. Stereophonic background music, where applicable, can be added later, in post production. Generally, off-screen sound effects can also be added later, but even here, the CBS experience is that no large-scale panning should be used. Moderate stereo panning is OK, and enhances the dramatic illusion, while stereo extremes tend to distract the viewer from the dramatic elements of the plot.

#### SPORTING EVENTS

CBS has already experimented with stereo sound for two types of outdoor sports programs: a golf tournament and a football game. In both instances, commentators' remarks were recorded monophonically, as they always had been. Stereo crowd noises were picked up by a pair of microphones with a minimum distance between them. A few parabolic microphones were employed to pick up specific, special sounds such as the cracking of the golf club striking the ball, or the crashing of a pair of football helmets running into each other! Having watched stereo sports events on Japanese television—such as Sumo wrestling—I can confirm that enhanced effects are achieved merely by incorporating crowd noises in stereo, even if the major, primary sounds (such as the grunts and groans of the opponents in the wrestling ring) remain monophonic.

No doubt, there will be other televised

events (such as live coverage of news happenings) which will involve little or no post-production stereo audio processing. In such situations, CBS also suggests that a mono sound track be used for the commentator (e.g. the roving reporter), and that stereo be used only for crowd or ambient sounds.

In summary, the points made in Dr. Green's paper were that, in the final analysis, the majority of stereo audio requirements will be easily met during the post-production phases of TV program development. The incremental cost incurred in providing a stereo mix in post-production is relatively small. Therefore, in most cases, the cost of stereophonic programming for video

can be minimized simply by sticking with a conventional multi-channel audio production in the *studio* followed by a stereo post-production mix-down and lay back to videotape.

Fortunately for some of us, the appearance of videodisc players and some home video cassette recorders with stereo playback capability means that a fair amount of video software (pre-recorded disc and tapes) is going to be produced over the coming months, well before we actually get the nod from the FCC. Stereo TV on cable networks is also a reality now. All of which should give an increasing number of us a chance to "practice" stereo TV audio before it really hits the "big time." ■

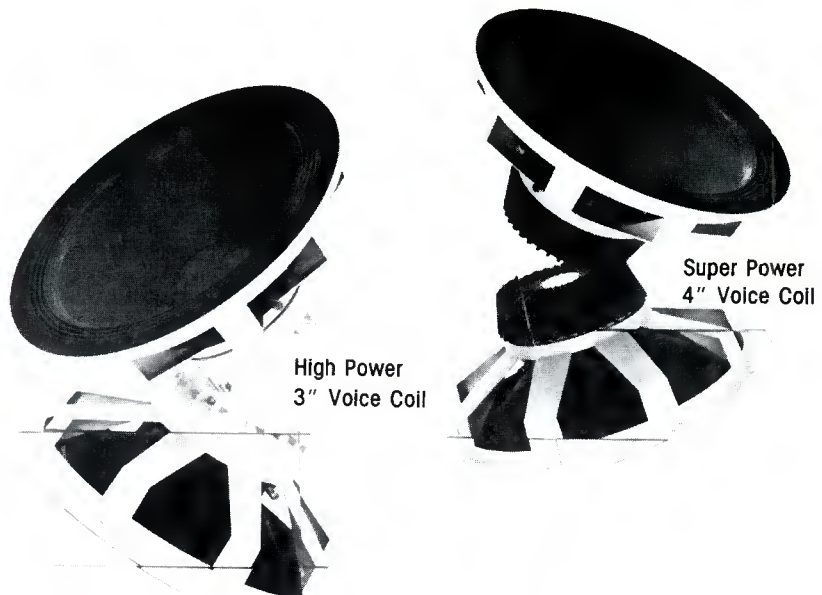

**See them.** Write for your nearest dealer.

**Cetec Gauss**  
 9130 Glenoaks Blvd.  
 Sun Valley, CA 91352

Circle 19 on Reader Service Card

## Fact vs. Opinion

A RECENT LETTER from a concerned reader takes us to task for "... the publication of articles on products by people with a financial interest in those products. Whether engineers, marketers, or salesman, objectivity is rare, and opinions are rampant. Unfortunately, authors who are knowledgeable, disinterested, and articulate are much harder to find than those with a direct interest in product sales, but this difference separates trade journals from professional publications."

*Hard to find? They're impossible to find!* In fact, we quickly scanned our reasonably complete library and found that the overwhelming majority of authors (especially in professional journals) have a direct financial interest in the products or ideas they describe.

This seems to make a lot of sense to us. After all, who would know more about a new whatever-it-is than the author is is—gasp!—*employed* by the company that makes it? Frankly, we can't imagine anything more futile than trying to ferret out someone who is: a) unemployed, and b) knows more about the subject than anyone else.

Of course, this certainly leaves us trade-types open to thinly-disguised "sales pitches" masquerading as feature articles. The professional journals attack this problem with an editorial review board, which carefully dissects every submitted paper. Typically, the approval cycle takes more than one year for each paper that eventually gets published. You can check this out by reading the fine print that tells when the paper was received, and comparing this to the date of publication. Such a review

policy is quite reasonable for a "learned journal," but would be suicide for a trade book such as *Billboard*.

We think we may be somewhere in the middle of this spectrum. If someone builds (or is even just thinking about building) a better mousetrap, we'd like to tell you about it while it's still news. We rely on your native intelligence to tell you whether the product, concept or idea is right for your needs. And if you do enough reading, you'll soon discover that there are precious few absolute truths. However, there are lots of opinions, and the more you read, the better you'll be at eventually forming one of your own. If one of our authors says, "I feel that so-and-so is such-and-such," we appreciate his enthusiasm, and we feel our readers don't need us to tell them that this is just one more opinion being presented for consideration.

We hope you'll agree that our authors are entitled to their opinions, as long as we make sure that these are clearly represented to you as opinions, and are not represented as facts. Facts, by the way, may need supporting evidence; opinions certainly don't.

Of course, any opinion invites a counter-opinion. That's what makes audio—and the world in general—so interesting. Too many of us think that everything we read in print is some sort of divine revelation. As a result, some people who shouldn't be trusted with the time of day are regarded as oracles when they say (in print) that  $1 + 1 = 3$ . In short, don't believe everything you read (except *db* editorials of course), and if you don't agree, say so! If it's an opinion, you're probably right. JMW



# Truly superior. We'll prove it!



## The Orban 424A Gated Compressor/ Limiter/De-Esser

There are lots of production limiters out there. Old favorites. Pretenders to the throne. The competition is fierce. So, when Orban set out to design a new production limiter, we knew it had better be superior.

The result of our research is the "Studio Optimod"—a Gated Compressor/Limiter/De-Esser with versatile controls, simple set-up, and a natural, transparent sound that must be heard to be appreciated.

Try one and A/B it against your current favorite. You'll notice the **sound**—remarkably smooth and natural over a wide range of control settings—even at high compression ratios where apparent loudness and punch are significantly enhanced. It's no accident: The unit is a direct descendent of our super-popular, second-generation OPTIMOD-FM broadcast limiter. So it exploits our years of experience in making an AGC device sound natural on diverse program material without critical re-adjustments. Yet full versatility exists for special effects in production.

A bonus is a smooth, natural de-esser. It's independent of the compressor/limiter section so you can simultaneously compress and de-ess vocal material without compromise. You can even de-ess sibilant vocals which have been mixed with other program.

The icing on the cake is unique gating and "idle gain" functions which prevent unnatural noise-producing gain variations during pauses and abrupt gain changes when the unit is switched in.

Our new Model 424A (dual channel) and 422A (single channel) are destined to become the new industry standards in dynamic range control. Prove it to yourself. Contact your Orban dealer today.

## orban

Orban Associates Inc.  
645 Bryant Street  
San Francisco, CA 94107  
(415) 957-1067  
Telex: 17-1480

# Riding the New Waves

*Suzanne Ciani took new wave six steps better, as she and a host of synthesizers combined to create the Seven New Waves lp.*

PRIMARILY KNOWN FOR HER work with an impressive arsenal of synthesizers including Synclavier II, Prophet V, Roland MC-4, and the Buchla Series 200, Suzanne Ciani is considered to be one of the most imaginative producer/composer/arranger/performers designing commercial music today. She has created hundreds of rock, pop, MOR, jazz, classical, C&W, punk, new wave, old wave and any number of musical styles and variations for a blue ribbon list of clients.

Ciani music has graced commercials for Coca Cola ("Have A Coke & A Smile"), Merrill Lynch's "Bull In A China Shop," Eveready's Energizer, Lincoln-Mercury, Magnavox and Atari, among others. She has also created the original score for Lily Tomlin's "Incredible Shrinking Woman" feature film; designed and performed the synthetic vocal sounds for Xenon, a sexy new pinball machine from Bally, and won a gold record for writing and performing the electronic sound effects for Meco's "Star Wars" lp.

But, for all the critical and financial rewards this amazing body of work has won for her, Suzanne Ciani has not been content to coast along on the crest of commercial success. The



*Suzanne Ciani and arranger Mitch Farber going over the score for Ms. Ciani's "Seven New Waves" lp.*

very basic desire for a wider audience and more personally satisfying creative fulfillment has been tugging at Suzanne Ciani's sleeve. This story relates the odyssey of her search for the perfect new wave.



# SONEX

## FOR CLEAN SOUND

After WLEE installed SONEX, people called about the "clean, new sound!" Was it new equipment?

No. The answer is simple and inexpensive:

SONEX kills all the stray reflections, so the mike processes a clean signal of the announcer's voice. The announcer hears himself in a warm environment, and there's

less clutter to waste watts. The result is a noiseless, clear signal and greater market penetration.

Get the facts today. SONEX is available in five colors, in three thicknesses, and in standard four-ft. square panels. Use it in broadcasting, recording, videotaping or performing areas for really pure, clean sound.

**Alpha  
Audio**

2049 West Broad Street  
Richmond, Virginia 23220 (804) 358-3852  
*Acoustic Products for the Audio Industry*

COLOR  
OPTIONS  
AVAILABLE

Sonex is a product of Illbruck/USA

Circle 30 on Reader Service Card

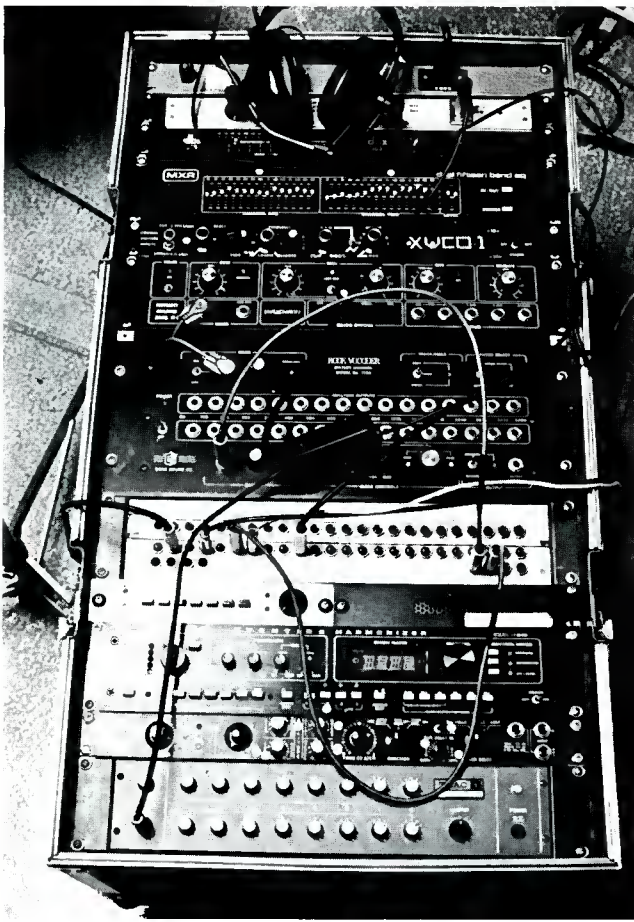

Suzanne Ciani's innovative "Voice Box," featuring the Polyfusion FF-1 Frequency Follower, Bode Model 7700 Vocoder, Eventide H949 Harmonizer® and Marshall Time Modulator.

"The basic concept in the beginning was to have a strong melody, a definite form and ocean waves. I'm not sure where they came from initially, but I put the waves in the first piece and they worked in the second and third and I thought, well, perhaps they'll serve as a thread that might weave through the entire album."

The music of *Seven New Waves* plays on a number of levels. Each piece is highly individualistic and capable of standing on its own, and yet, they are all connected; they move and flow, one into the other, the waves crashing in and out from one piece to the next 90 percent of *Seven New Waves* was composed prior to recording. As Ciani explains, "Much of the work is book-keeping! Keeping track. You begin in 'black space,' starting from zero, and you've got to have a formal guide to keep you moving in the right direction. Then, that last 10 percent, the inspiration, is what brings it to life. You've got to be free in the midst of all this bookkeeping to sparkle and be spontaneous. There's a magic that happens; it's the performance aspect that occurs while you're recording."

*Seven New Waves* music is soft and sensual, but at its underlying core is a pulse, a dependable rhythm created basically by computer. "The majority of the album is Roland MC-8 and MC-4 combined with the Prophet V, which generates the sound," Ciani explains. "The Roland *controls* the sound. Blended into the overall sound are the free-form elements: melodies that are played on touch keyboards, vocoding done with breathing. If something is off just the tiniest bit in the context of this electronic texture, the entire work can fall apart."

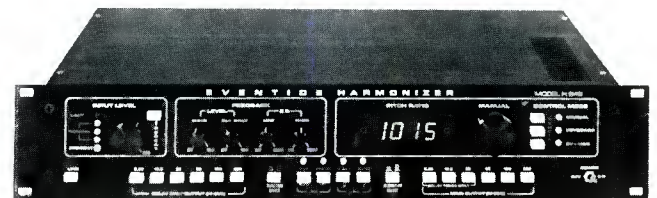

The Eventide H949 Harmonizer.®

"I had been listening to myself talk about doing an album of original music for years," Ciani says, "but there were always other priorities—deadlines and assignments that had to be done first. My own album always seemed to be off in the future. It was one of those things I expected to get around to in time. The problem was the time never arrived."

"Finally, around Christmas, 1979, I made the commitment. I set a date to record a piece that I had originally written for piano and which I now decided to orchestrate electronically. The pre-production notations were done with Mitch Farber, an extremely talented arranger I've worked with on numerous commercial projects. Mitch also served as my co-producer throughout the entire two year project. Next step was booking time at New York's Secret Sound Studios for a weekend. The studio has a wonderful engineer, Gus Skinnie, who is very patient with layering the tracks, careful about noise, and who loves synthesizers."

"The recording and mixing were spread out over a long period since the only time I had available for my 'private project' was on weekends. I'd go into the studio on a Friday night and work around the clock until Sunday. After the third piece, there was a considerable time lapse when I became very much involved with the score for 'The Incredible Shrinking Woman' and a rush of commercial work, but the album was always on my mind."

## THE MUSIC

One of the early conflicts Ciani encountered in starting off her album project was one of attitude: Should she go rock 'n roll or soft and fanciful? Her decision to go soft was based on a personal preference which, in retrospect, seems obvious, for this is a most personal recording.

## THE EQUIPMENT

Ciani works with customized equipment, some of which she has designed herself, to answer specific technical needs which arise in her own creative process. One of these innovations has been christened the "Voice Box." For this electronic wonder Ciani combined an Eventide H949 Harmonizer, a Marshall Time Modulator, Polyfusion FF-1 Frequency Follower, Bode Vocoder, MXR equalizers, dbx compressors, microphone preamp, mixers, patch bay, etc. This unique configuration was selected to give her the most creative control over the sounds she designs.

"For example," Ciani explains, "I might take a drum pattern and Vocode it with my voice to create what you might consider 'talking drums' or, I could just as easily create drumming strings by the same process. I could, for instance, take a saxophone solo, extract its pitch with a frequency follower and map that onto a newly synthesized sound. Or, I could take a sound from the real world without moving pitch and make it sing with the Harmonizer. The combinations and re-combinations are infinite. In the album, at the end of the fifth wave, for instance, I



The Ursa Major Space Station SST-282.

# We designed the Studer A800 for video post-production, and it quickly found its way into the world's best...recording studios.

## Interesting.



Over the past couple of years, a remarkable number of "first-line" recording studios have bought Studer A800 multi-tracks. And, currently, the A800 is winning over a new group of admirers—video producers. Little wonder. After all, the A800 was originally designed with video requirements in mind. It is fast enough to keep up with the VTR's, and it has sophisticated microprocessor controls for unparalleled production flexibility. As for the sound quality, well, that's what convinced the people at the recording studios!

If you're planning to update your audio, take note of these particulars:

- **Editing System Compatibility**—Operates with Audio Kinetics, Adam Smith, BTX, CDL, CMX, Electro-Optical, EECO, and Studer SMPTE-based systems.
- **Superior Tape Handling**—Accelerates quickly to 400 ips fast wind, slows, stops, and changes modes with uncanny smoothness.
- **Microprocessor Control**—The microprocessor governs all transport functions as well as audio, bias and erase switching.
- **Edit Rehearse**—Used with SMPTE-based controllers, the A800 lets you simulate electronic edits before making the "hot" edit.
- **Separate Time Code Channel**—The time code track is routed through special electronics, not the regular audio channel. SMPTE code-reading in fast wind is standard.
- **Remote Unit**—Options include 20-address autolocator, channel remotes, vari-speed remote, and SMPTE synchronizer.
- **All Formats**—8, 16, and 24-track standard; 4-track 1/2" on special order.
- **Legendary Craftsmanship**—Lift the top plate off an A800 and the competition disappears. Nothing else performs like a Studer because nothing else is built like a Studer.

Treat your video to the ultimate audio. Call or write today for more information.

## STUDER REVOX

Studer Revox America, Inc.  
1425 Elm Hill Pike, Nashville, TN 37210 (615) 254-5651  
Offices: Los Angeles (213) 780-4234 / New York (212) 255-4462  
Dallas (214) 760-8647 Canada: Studer Revox Canada, Ltd.

make the wave 'breathe,' and at the end of the second wave, Sirens. I use my vocoded voice to give the strings a female aura."

With the Voice Box, Ciani is able to isolate elements of her voice—pitch, dynamics, formant characteristics—in order to process the voice itself or use the voice as an expressive control for another sound. This gives her sound a life far beyond a basic synthesizer effect.

"The processing is an inherent part of the sound," Ciani confides. "Using an Ursa Major Station—or the way I deal with reverb—these techniques are totally open. Sometimes I turn the tape over so that the reverb sound will precede the direct signal. I use this technique on the opening of the sixth wave. I use very long reverbs, up to five seconds, when mapping my voice onto strings, so I get a continuous smooth expression even though I have to stop for breath. In *electronic music*, there is no acoustic space, and the Ursa Major lets me specify a room size for a sound if I want.



Polyfusion's Model FF-1 Frequency Follower.

"The new Eventide Signal Processor, which I acquired in prototype form, is invaluable to me as both a reverb and delay. It is absolutely amazing, and I'm totally in love with it!" (The Eventide SP2016 Programmable Effects Processor is a microprocessor-controlled device that does everything from five-second reverb to sophisticated programs for various kinds of delay.) "Occasionally, a delay is used to 'fatten' a sound," Ciani continues, "or, it can be used precisely and rhythmically to accent a beat so that every beat or every fourth beat is strong. This is done by setting the delay time to the precise number of milliseconds for a beat division and then adding in some feedback if desired.

"In another example, the ability to put a time delay and different amplitude level on the delay of each part of a signal enabled me to design an *authentic* wave sound. A wave crashes before you on a beach and continues to crash on down the shore. As it travels, the low frequencies are going to fade at a

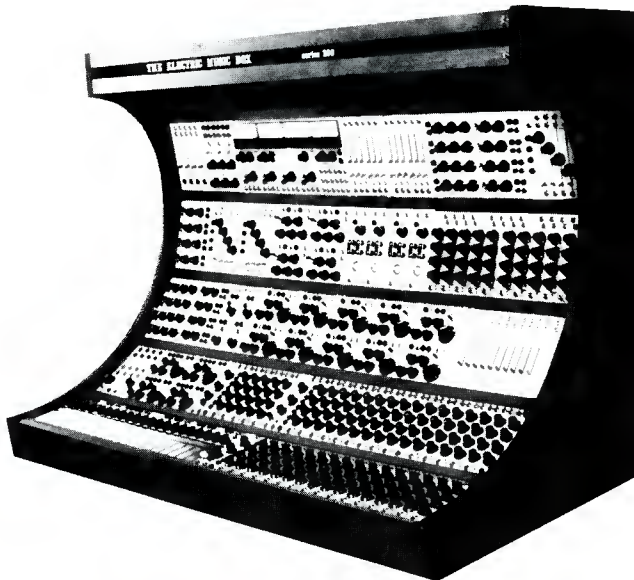

The Buchla Series 200 Electric Music Box, circa 1971.

different rate from the highs. With the Eventide, these sounds can be programmed right into the band delay program, allowing the wave to crash with the high sounds wisping off and the lows repeating simultaneously.

"The Buchla Series 200 was the only piece of equipment which would allow me the flexibility of creating the waves I wanted," Ciani explains. "It has much more control over the shape of the envelopes for amplitude and filter than any other instrument and the white noise is much more specific and refined. Also, I can frequency modulate the band-pass filters, something you can't do on other machines. This was especially helpful in creating the ocean sounds."



New England Digital Corp's Synclavier II.

Early on in the project, Ciani tried to use as many of the instruments at her disposal as possible: Arp Pro Soloist and String Ensemble, OB-X, Poly-Moog and a Steiner. In time, however, those pieces of equipment disappeared from her repertory altogether and she began focusing her attentions on the Prophet V, controlled by the Roland MC-8, the Buchla, and the Synclavier II which was added in the fall of 1980.

"Everyone has preferences in their 'colors,'" Ciani says. "Vangelis leans towards an Oberheim-type sound, Jean Michel Jarre favors a String Ensemble sound. For me, the Prophet V has a wide latitude of sound and a great deal of control. It's subtle too, and perfect for the approach I was searching for.

"At first I had some difficulty with the Synclavier because it couldn't be driven externally by click pulse, but they recently came up with some 'special sequencer' software which enables me to drive its sequencer externally. In order to record all the layers and have them 'lock' in, master clicks (which will drive all the synthesizers) are recorded on the tape. I usually lay down three independent triggers (sixteenths, eighths, quarters, including whatever might be the smallest rhythmic denominator) on non-adjacent tracks—on the first pass from the drum machine.

"It's difficult to drive the drum machine externally, so I have to *start* with it. Since I'm not so concerned with *realistic* drum sounds per se, I use the Roland TR-808 Rhythm Composer to store the entire drum pattern and then usually replace some of the sounds with ones I make up by using the drum sound to trigger a synthesizer. There are three independent trigger outputs in the machine which I use as the 'master clicks.'

"I'm currently having a pulse multiplier built so that in the future I'll need just a quarter-note click to generate all the necessary higher rates. This will also let me synch with video and compose directly to picture. It will be like a central control unit to integrate the ever-changing family of audio and video synthesizers, letting them 'talk' to each other."



Inside Suzanne Ciani's studio. Careful inspection will reveal the Buchla Series 200 synthesizer, Ms. Ciani's Voice Box, Synclavier II, Prophet 5, Sequential Circuits' Digital Sequencer, Teac's Model 15 mixing console, the Ursa Major Space Station, Otari's MTR-90 24-track tape recorder, and more.

## THE STUDIOS

Timing, studio availability and hardware selections found Ciani in a variety of recording studios during the two years she worked on *Seven New Waves*. The early portions of the album were cut at Secret Sound. The album was mixed at studios with automated boards: Automated (MCI), Soundmixers and RPM (Necam). "Automated mixing in this type of layered music is essential," Ciani says. "There might be hundreds of moves in any given piece. Also, it allows the noise to be cut down considerably by muting the inactive tracks and finally, it lets us concentrate on the spatial movement of the sound. The spatial location and movement of a sound is absolutely as important as any other parameter. For automated movement not of a panning nature, I use the voltage-controlled spatial locations in the Buchla."

Ciani also utilized her own Park Avenue studio, but found some advantages working in outside facilities. "It seemed to work more efficiently when I was away from my studio," she confides. "Even though I hire outside engineers, Leslie Mona or Vicki Fabry, when I'm on home ground there has been a tendency to drift. Leslie Mona did the bulk of the engineering for the album, and her proficiency with Necam was an invaluable asset throughout the production. The pressure of the clock can be a positive one. Psyching up to put down a specific number of tracks in a given period of time can be positively inspiring."

## THE FINISHED PRODUCT

Ciani estimates *Seven New Waves* cost her close to \$50,000 to create over a period of two years. This figure, however, does not include her own time (Ciani's services for commercial work command substantial creative fees), nor does it take into consideration the time spent in her own studio. Are there changes she would make in the music as she listens to it today in its finished form?

"Yes, there are things I'd do differently, but you must stop at a certain point. I tend to be a perfectionist, but I'm also aware that perfection is not necessary in most cases, that part of the life and interest of a sound in music can be its imperfections; like the brush strokes in a painting, they're there, but they make up the texture of the work, and that too is part of the artist's statement.

"Tuning, for example, can be a problem," Ciani points out, "especially if you're working over a long period of time and in a variety of studios. Certain sounds with pulse modulation have a built in de-tune. They can be fine at one stage, but further on down the line they just don't fit in because of the delicate accumulations of a variety of tunings. Sometimes it's a matter of sound appearing out of tune even though it isn't. This might be tied into the harmonic structure of an electronic sound, which tends to be mathematically rigid. Or sometimes, this is

due to the basically crude and constant way of adding interest to a synthesized sound: vibrato, pulse-width modulation, beating... the ultimate judge is the ear."

## THE HUNT FOR A LABEL

With the completion of her recording and mixing of *Seven New Waves*, Suzanne Ciani turned to the equally difficult and complex phase of bringing her music to life. The search for an audience begins with the search for a record label.

"Once I'd completed the first four pieces, I played them for people and got a positive response," she recalls. "U.S. labels were trimming their artist rosters at that time, as they continue to do today, and everything was tightening up here. I realized after a certain point that I had to go outside of this country to get a deal.

"I had sent tapes to France and Germany and was disappointed by their lack of enthusiasm. They'd offer me a very meager advance and say 'We'll get this out...' That was it, they had no real distribution or promotion, and I couldn't see putting all that effort into such a low energy situation. I decided to go to Japan, the world's second-largest record market.

"I knew a number of musicians who had been very happy with their experiences working and traveling in Japan, and I had the names of some label executives who, I was told, might be very interested in my work. Almost all the labels I visited showed serious interest in the product, but as it happened, Mr. Tadao Tokoro of Victor Musical Industries impressed me with his marketing and promotional creativity and I decided to go with them."

When Suzanne Ciani returned from Japan in August, 1981, she had four completed cuts for her *Seven New Waves* lp, pieces she had recorded and mixed over a period of eighteen months. She also had an October, 1981 deadline for a finished album, and that meant completing three additional pieces. Continuing to do her commercial work during the week and her personal recording on weekends, Ciani was able to meet her commitment to Victor.

As a commercial artist, Suzanne Ciani often works with a "committee" of ad agency execs and their clients, many of whom have specific needs, aims and requirements for the music she creates and produces. The music heard on *Seven New Waves* belongs to Ciani alone. When asked if the music on her album is the music she heard in her mind at the time she was writing, the music she hoped she would hear on her record, Suzanne has a simple two word answer: "Yes! Definitely." ■

## Manufacturers

<b>Buchla</b> P.O. Box 5051 Berkeley, CA 94705 (415) 848-0790	<b>Oberheim Electronics</b> 2520 S. Barrington Ave. West Los Angeles, CA 90064 (213) 473-6574
<b>dbx, Inc.</b> 71 Chapel St. Newton, MA 02195 (617) 964-3210	<b>Polyfusion Electronics, Inc.</b> 92 Benbro Drive Buffalo, NY 14225 (716) 681-3040
<b>Eventide Clockworks, Inc.</b> 265 W. 54th St. New York, NY 10019 (212) 581-9290	<b>Roland Corp.</b> 2401 Saybrook Los Angeles, CA 90040 (213) 685-5141
<b>MXR Innovations, Inc.</b> 740 Driving Park Ave. Rochester, NY 14613 (716) 254-2910	<b>Sequential Circuits, Inc.</b> (Prophet V) 3051 North First St. San Jose, CA 95134 (408) 946-5240
<b>New England Digital Corp.</b> (Synclavier) P.O. Box 546 White River Junction, VT 05001 (802) 295-5800	<b>Ursa Major, Inc.</b> Box 18 Belmont, MA 02178 (617) 489-0303

# Noise Reduction: Where to Next?

*Manufacturers specializing in noise reduction expect to make money this year. Whose money will they make, and how will they justify the making of it?*

“**I**T IS A TIME OF application, not evolution,” says Dolby’s marketing VP Ioan Allen, and most of his competitors seem to concur. If their collective statements are taken literally, noise reduction in its several varieties has reached its final form in a systems sense. The circuits themselves can and will get physically smaller, easier to power and interface, adaptable to more frames and chassis, and progressively cheaper. But they’ll continue to do to the signal exactly what they do now, as if the psychoacoustic formulae were graven in stone.

Whether or not this is true (and there is ample room for doubt), it is probably certain that noise-reduction manufacturers will expend most of their efforts for the next twelve months in getting maximum mileage out of existing technology. To paraphrase one designer: “It’s not the good studios that are asking for more noise reduction. It’s the sloppy operations. To build more effective—and therefore more complex—noise-reduction processors for people who cannot even deal with the complexities they have now would be throwing good money after bad.”

A challenge will be posed to this statement later on. But for the moment it can stand as one of several reasons why the noise-reduction emphasis of today is on market bases and the broadening of them. The broadest-based market is, of course, the consumer one, which is a mainstay for Dolby, a beacon for dbx, and virtually the whole works for CBS’s CX. (Little has been heard recently from other manufacturers. For reasons both clear and obscure, noise reduction remains a peculiarly American activity.) The first two companies are also insinuating themselves into new professional sectors, but ones that promise to lead them more or less directly into the gratifying numbers of the consumer sphere at a reasonably early date.

## BROADCASTING ETC.

Broadcast and cable are now the fastest-moving areas of audio, and both dbx and Dolby are snapping at the heels. dbx has looped the National Public Radio communications-satellite bounces with a specially designed 3-to-1 compander system, and is actively promoting this technology to others. Dolby has not yet gotten involved in the links except in local instances (for some years Boston’s WGBH-FM handled special programming with a Dolby A-type loop that enclosed studio and transmitter). But the company is highly active at the beginning of the chain, and in the case of cable transmission, what pops out at the end is often-as-not a B-type-encoded stereo signal, whether the ultimate consumer is or isn’t aware of it.

Ironically, although the Dolby FM project has fought an

uphill acceptance battle from the beginning, B-type encoding for the audio portions of video transmissions is being seized on with dizzying speed. The reason seems to be that, whereas FM broadcasters feel they need a loud (i.e., compressed/limited) signal to attract audience, in video the principal draw is the picture content; audio counts for so little that the sound people are able to do almost anything they want, even going so far as to make it good. There is also the factor that video programming is not normally experienced in a car amidst its problematic road noise.

Among the major cable operations routinely delivering a Dolby-B stereo signal to subscribers are CBS (particularly for its fine-arts programming) and Warner/Amex for MTV and its movie channel. The Entertainment Channel being put together by RCA and the Rockefeller Center group is expected to follow suit. According to a Dolby spokesman, the company is unsure of any video cable system providing stereo that does not employ B-type encoding. Considering that the overwhelming majority of VHS consumer stereo recorders now being introduced will be B-type equipped, the whole thing makes a very tidy package that has Dolby Labs expectantly if guardedly looking ahead to developments in high-definition TV, A-type transmission links (reportedly being resisted just now because of expense), and possibly surround decoders for home viewing of Dolby Stereo feature films (these, in their most grandiose forms, would require yet another stage of B-type decoding).

Up-chain, the Dolby Cat. No. 221 and 226, A-type replacement cards for the audio boards of the Sony and Ampex C-type professional VTRs, were major attractions at the recent NAB convention, to a point reminiscent of what happened when A-type for music studios began to catch on. And in an area a bit apart from broadcasting, Lucasfilm—boldly going where no one has gone before—has equipped its Nagra recorders with CAT. 55 portable add-ons. So, for *Revenge of the Jedi* (Star Wars number 3), noise reduction will be used in the pick-up location dialogue for the first time that anyone can think of.

Finally, it should be remembered that for years Dolby has also had a prototype NR system for the video *picture*.

## CONSUMERLAND

With Matsushita’s successful development of the dbx “NRX” IC (a compact 22-pin DIP that will operate off supply rails as low as 1.8 volts), dbx is preparing to take on the “personal portable” and car-stereo markets in earnest, supporting its efforts with dbx-encoded software generated through cross-licensing arrangements with record labels. Disc releases are remastered by dbx, which provides stampers to the label for pressing operations in the label’s facilities, after which dbx purchases the final product for distribution. Prerecorded cassette manufacture is undertaken entirely by dbx, through a sub-contracting pact with Master Digital in Venice, California,

*Ralph Hodges is a freelance writer/editor working out of the San Francisco bay area.*



which employs digital running masters for duplication purposes. No royalties are charged by dbx, although agreed-upon fees revert to the label, which is of course also free to make whatever other use of its material it wishes. Currently, there are about forty labels participating in the two dbx programs, with A&M being the major one, and an important subsidiary of WEA expected to join soon. Hardware licensees, besides Matsushita, include Alpine, BSR, Marantz, Onkyo, Trio/Kenwood, and Yamaha, amongst those who do, or quite possibly may produce equipment requiring low-voltage noise reduction.

On the Dolby side, experiments, reportedly very encouraging, are still taking place with Electrosound toward the object of applying Dolby HX Professionals to the high-speed duplication of prerecorded cassettes. (HX Pro was developed independently by Bang & Olufsen and announced about a year after the introduction of Dolby HX. The two companies have since entered into a cross-licensing agreement. The intent of HX Pro is to compensate for the biasing action of high audio frequencies, so as to keep the effective bias reaching the tape constant.) In Dolby's present scheme, interested duplicator people will pay a licensing fee for the use of retrofit modules on each slave. The fee will be shared by Dolby and B&O. (For more details, see AES Preprint 1852, "Recording With Feedback—Controlled Effective Bias"—Ed.)

### THE CX SITUATION

There's still not a lot that can be said about the fortune and future of the controversial CBX CX system for disc noise reduction. CBS spokesman Bob Jamieson, contacted in mid April, advised that, although the system remains in the same configuration as worked out by CBS Technology Center in later cooperation with UREI, the marketing slant is going to be changed a bit.

Compatibility, or rather acceptable playability without decoding, has been the major issue dogging CX from the start. CBS has always retorted that "blind" copies sent out to influential listeners have been accepted enthusiastically, and it intends to underscore its findings with a new "integrated release" policy. In case the term is new to you (it was to me), it means that dealers will receive a mix of CX and non-CX recordings whenever they order a title that is available with CX encoding. Both versions will bear the same catalog number, and encoded material will be differentiated only by the very small

CX logo at the bottom of the record jacket. On the basis of dealer and consumer reactions, CBS will adjust the proportions of the mix, but it plainly expects that a CX record, bought blind, will prove just as satisfactory as a non-CX copy to most ears.

But alas, there continue to be respected reviewers who receive CX albums without notification thereof and proceed to pan them on sound quality. In the latest instances, the reviewer involved (in a personal communication) called his review copy audibly compressed and "sounding like the voice and piano were recorded in separate acoustic environments." He was much happier about the sound when he finally heard it through a CX decoder, but the review was already in print.

Promotional efforts and increased prominence of logo are still under discussion by CBS as this is written. More than 130 new CX-possible productions (CX is introduced at the disc-mastering stage) are awaiting approval for release. Activity from other CX-participating labels continues about nil, although CBS has offered assurances that RCA and others will soon make a move. (RCA and the WEA group announced they were going to adopt the CX system in July, 1981—Ed.) Onkyo and Toshiba have joined the hardware-licensee corps, and CBS says that discussions with several other hardware majors are coming to a close.

As far as I can tell, opinions regarding CX already expressed by the engineering community remain the same.

### NEW NOISE REDUCTION?

There is certainly no indication that dbx is considering new widgets at present, and CBS has yet to fully establish CX. However, everyone is by now aware of Dolby C-type. Many are wondering about its possible application to professional activities, and more than a few know that Dolby has at least a passing interest in certain advantages of a sliding-band processor for studio work. The present C-type system is contoured for slow-speed cassette recording, and its several safeguards against high-frequency tape saturation are inappropriate for 15- or 30-ips operation. Also, it does not address itself to low-frequency noise, as Dolby has always insisted a professional processor should. Still, C-type right now is capable of a theoretical 16- to 17-dB S/N improvement (CCIR/ARM weighted) at 15 ips if the through-the-chain electronics are quiet enough to pass it. Isn't that worth something? Chances are, it is. So watch for the appearance of "something" within the next four to six months. ■

# Noise Reduction Update

*A mini-survey of some of the latest NR hardware.*

**A**CCORDING TO A CBS Technical Bulletin, the noise spectrum for the typical phonograph record is relatively strong at high and low frequencies, while the ear is less sensitive to the frequency extremes of low-level noise. For example, if the 30-phon loudness contour seen in FIGURE 1 is subtracted from the record noise spectrum, the resultant perceived noise is nearly flat across the audio bandwidth (or at least, from about 100 Hz upwards).

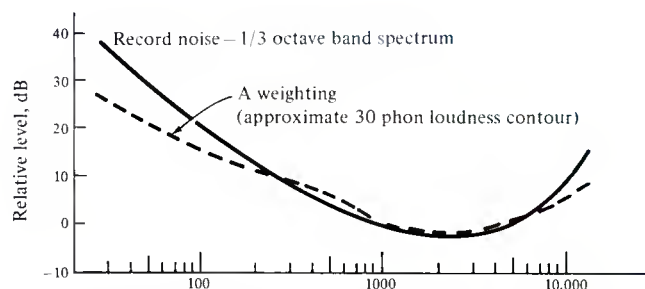

Figure 1. The difference between the 30 phon loudness contour and the record noise spectrum produces a reasonably-flat response across the audio bandwidth.

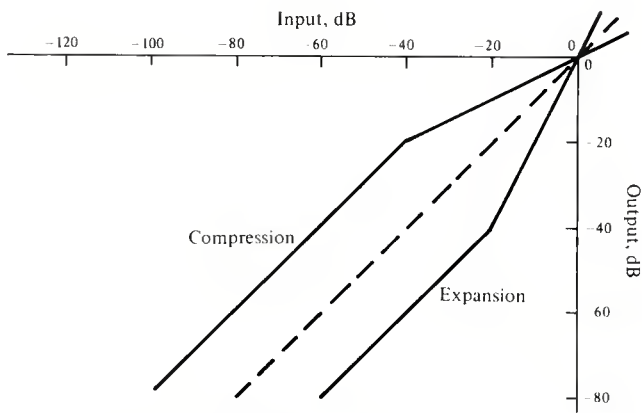

Figure 2. The CBS CX companding system.

Thus, CBS states that noise reduction systems which only process high-frequency noise are not suitable for phonograph records. Furthermore, existing disc noise reduction systems are "non-compatible"—that is, the playback quality is poor when the record is played back without the appropriate noise-reduction decoding.

In an attempt to overcome these limitations, the CBS CX system uses a wide-band companding system whose characteristics are shown in FIGURE 2. The system provides up to 20 dB noise reduction, which according to CBS is the difference between the signal-to-noise ratio of a two-channel master tape mixed down from a 24-track digital master, and that of a typical phonograph record.

CBS claims that its filter/time-constant circuit produces a decoded signal "without any associated distortion or pumping," and, that the CX process played back without decoding is virtually unnoticeable. In other words, the process has the power to improve the signal (decoded) while simultaneously having no audible effect on it (encoded), thereby putting a bit of a strain on the traditional rules of logic, to say nothing of on noise reduction theory.

Critical response to the system has been somewhat less than overwhelming. Generally, critics seem to feel the CXing has a minimal effect on the top-40-type records, and although some classical records are noticeably improved by CX, the process is definitely audible in its non-decoded format. (Here at **db**, this is all second-hand information. So far, CBS has resisted our various prayers, threats and entreaties for more details on the system—Ed.)

#### dbx

The dbx NRX chip is the product of a joint development effort between dbx, Inc. and Matsushita Electric Industries Co. Ltd. The 20-pin flatpack chip contains the active components for two channels of dbx noise reduction, and is now being manufactured by Matsushita. According to a recent press release, "the dbx system... will enable a digital disc to be copied onto analog (cassette) tape with the full dynamics of the digital performance." The NRX chip operates from a 3-volt nominal supply.

#### DOLBY

At the recent NAB convention, Dolby introduced two new A-type noise reduction modules for professional videotape recording. The CAT. No. 221 module is designed for Sony BVH 1000 and 1100 VTRs. The 226 is for Ampex VPR-2 one-inch type C VTRs, and is a direct replacement for the original Ampex audio card.

The CAT. No. 223 is an optional remote control interface for these modules. Although not necessary to the correct operation of either, the interface facilitates their use by providing remote control of the noise reduction function, activation of the Dolby-tone generator, and LED metering for calibration. Pull-out level controls permit temporary re-calibration for non-standard-level tapes.

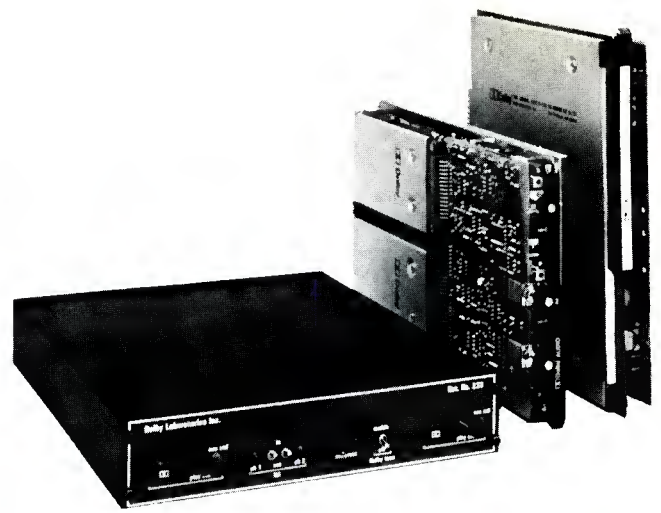

The Dolby Cat. No. 233 remote control interface (left) for use with Dolby VTR audio noise reduction modules (Cat. No. 226 for Ampex VPR-2, center, and Cat. No. 221 for Sony BVH 1000/1100, right).

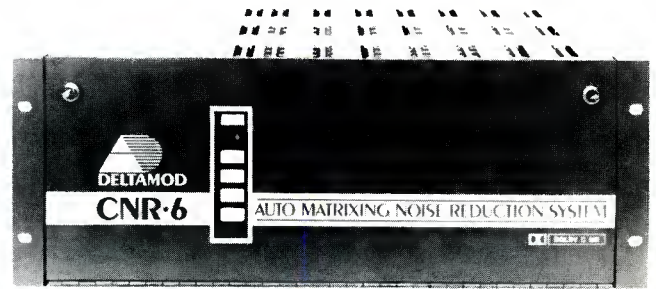

The Deltamod CNR-6 audio matrixing noise reduction system.

#### DELTAMOD

The Deltamod CNR-6 is an automatic matrixing noise reduction system designed for broadcast cartridge applications. The CNR-6 accommodates up to 12 channels of Dolby C noise reduction in a seven-inch standard rack-mount frame.

When cartridges are recorded with noise reduction, the cue track on the cartridge is automatically encoded with a signal that will be recognized by the reproduce module. In the matrix mode, left and right input signals are matrixed before recording into sum and difference signals, and an appropriate cue track signal is simultaneously recorded.

In either case, standard cue tones and FSK devices are not affected by the Dolby matrixing signals. Encode/decode modules may be under local or remote control. A bypass card inserted into an empty module slot enables straight-wire operation when a noise reduction module is not available.



The TTM-202B two-channel noise reduction peripheral electronics frame.

#### GOTHAM

The Gotham Audio TTM-202B is a two-channel rack frame which accepts dbx, Dolby and Telcom noise reduction cards. Multi-turn alignment potentiometers allow the user to optimize the TTM-202B for each noise reduction system, and gold-contact relays are employed for the by-pass mode, and in case of power failure, to remove all noise-reduction electronics from the signal path.



A Division of Sony Corporation of America



WHEN I WANTED  
MY OWN STUDIO,  
I WANTED MCI.

Country star Charley Pride knows what good sound is and what it takes to deliver it. So when Charley built his own CECCA Sound Studio in Dallas he turned to the recognized leader in pro recording equipment. His complete MCI system includes a JH-500D console, JH-24 multitrack and JH-110B recorders, one of them in MCI's new half-inch stereo format. MCI's "System Approach" and local dealer support made MCI Charley Pride's choice. Now make us yours.

1400 W. Commercial Boulevard, Fort Lauderdale, Florida 33309 USA.  
Telephone: (305) 491-0825. Telex: 514362 MCI FTL.

TWA6001-0002-82

Circle 29 on Reader Service Card

JOHN M. WORAM

# The New World of Digital Audio

June 4-6

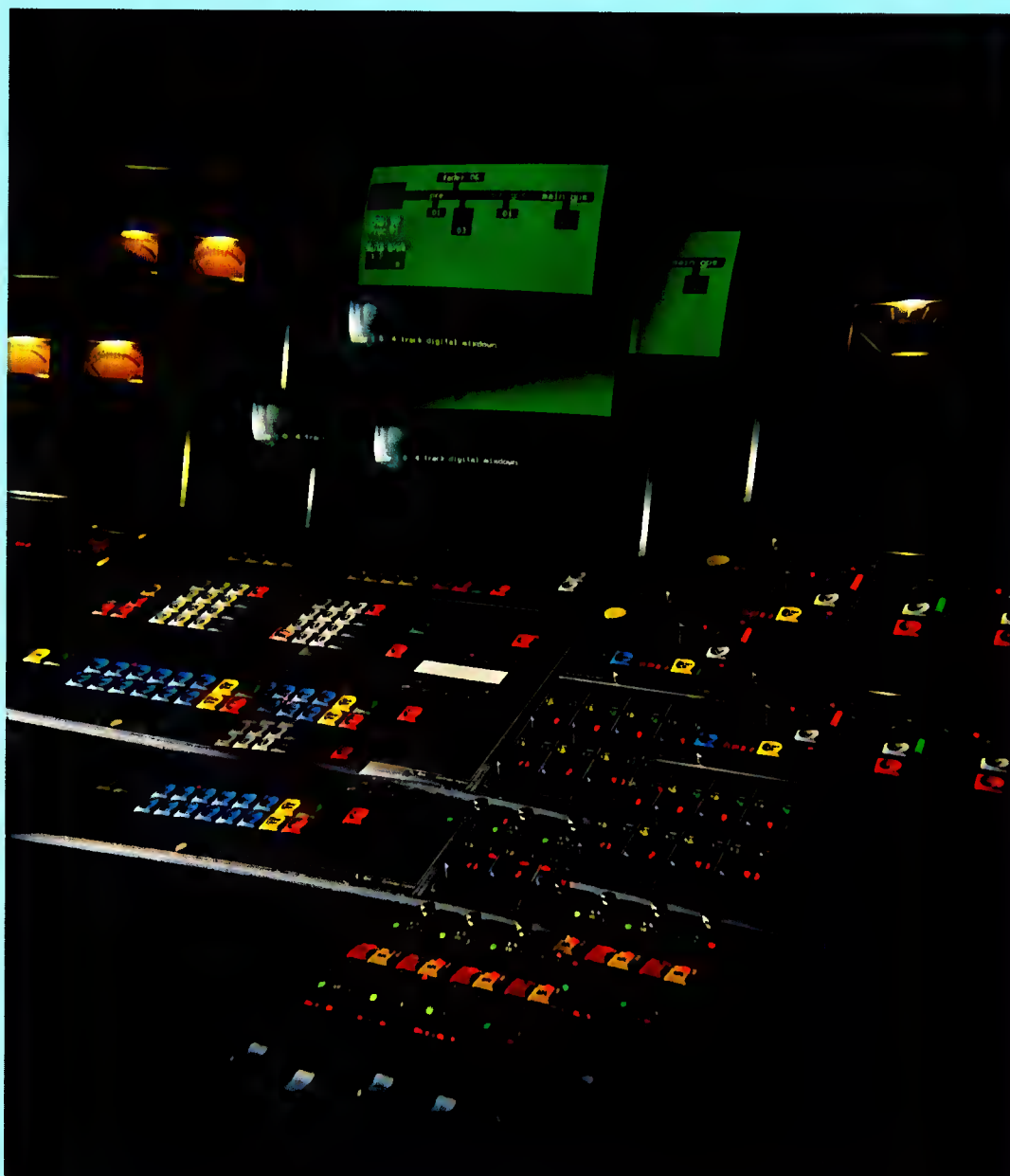

*The AES Digital Seminar featured a mind-boggling amount of information, and—at no extra charge—a simulated version of WW II.*

**R**YE, NEW YORK—Some 200 AES members and friends assembled at the Rye Town Hilton here, to discover ... *yes!* there is indeed such a thing as digital stress. The group survived three days of total immersion in “*The New World of Digital Audio.*” This conference, both intellectually stimulating and exhausting, was the first of its kind that the Audio Engineering Society has sponsored.

The conference began on a Thursday evening, with an introduction and overview, presented by Drs. Barry Blesser and Thomas Stockham. The next morning, the heavy guns were rolled out, and didn't stop firing until late evening on the next day. In all, 26 speakers presented 30 lectures, most of which were about an hour long.

The festivities concluded with Sunday brunch, by which time the audience had long since passed their respective digital saturation levels. Most were more than ready to retreat home, there to thoroughly digest both the Hilton's cuisine and the seminar contents.

As an AES first, the conference was on most counts a success. If nothing else, the sheer weight and diversity of the presentations was enough to convince most registrants of the complexity of the subject. The talks ranged from instructive to incomprehensible. A few were marred by a language barrier, at least one speaker was suffering from a terminal case of the mumbles, and a goodly percentage of the material sailed over the heads of some of the audience.

The entire seminar was divided into three parts; I: Introduction and Overview; II: In-Depth Analysis of Technology; and III: Applications of Digital Technology.

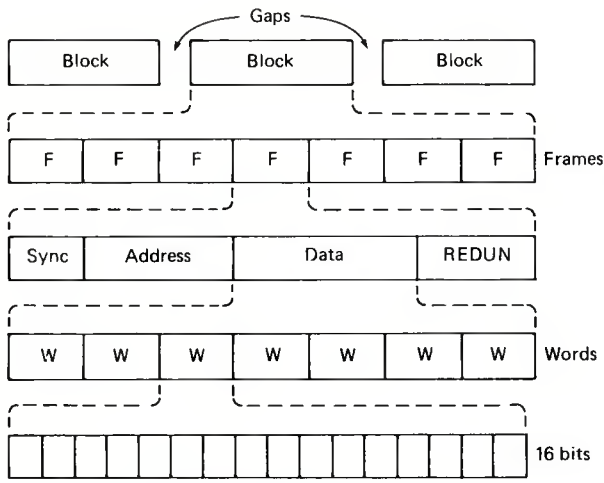

Figure 1. A block-coded digital format.

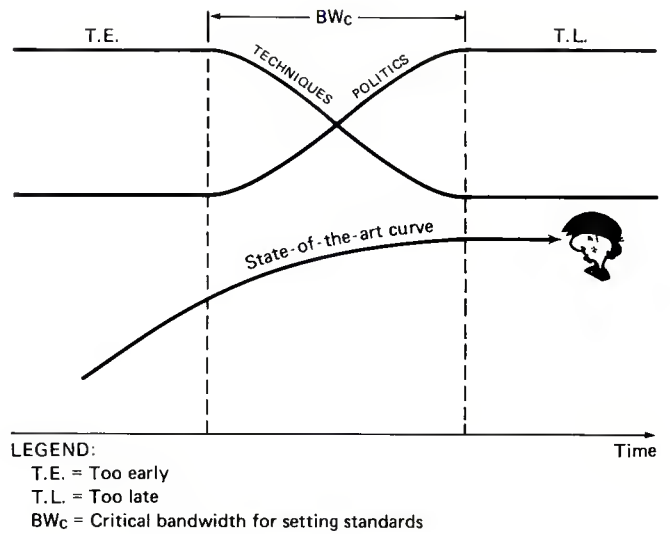

Figure 2. Dr. Doi's not-quite-official roadmap to digital standards.

### PART I: INTRODUCTION AND OVERVIEW

The proceedings got underway with a talk on Elementary and Basic Processing, in which Dr. Blesser presented some comparisons between the analog and digital storage media. As he has pointed out in his Digital Audio column here in *db*, the infinitely-variable analog medium is a fragile system, while the quantized digital domain is by comparison quite robust. Contrary to what one reads in the "hi-fi" press, information does not get lost in between samples. Due to low-pass filtering, there is no information present beyond the Nyquist frequency (that is, half the sampling rate), and so the sampling process cannot lose what is not there in the first place.

This is a clarification of a frequently misunderstood point, and not an answer to the larger question, "Can we hear (that is, recognize) digitally-recorded signals?"

Dr. Stockham concluded the evening with a talk about "The Promise of Digital Audio," in which he reviewed the advantages and disadvantages of digital technology. Among the former, he counted permanence, fidelity, and the ability to do complex processing without distortion. Sophisticated automation techniques are more easily realized, and linear-phase equalization now becomes possible. In addition, editing can be

