



18+
-AUI
SIA
710



Now! A balanced high-level output oscillator with the lowest distortion.

This is oscillator performance that's totally advanced, totally Tektronix! Depend on the new SG 505 Option 2 for balanced, high level output in the studio or at a transmitter site. It outputs a sine wave with less than 0.0008% THD, the lowest residual distortion of any oscillator on the market today.

Complex measurements are made automatically in tandem with the AA 501 Distortion Analyzer. These two TM 500 plug-ins can be mounted in the same or separate mainframes, or transferred to a portable mainframe for use in the field.

No other manufacturer offers this kind of flexibility: two separate devices that make one powerful package, side-by-side or miles apart. Still fully automatic, even when separated.

New state-of-the-art performance, by every measure! The SG 505 Option 2 features a completely balanced output configuration for compatibility with highest-performance audio systems. Source impedances are selectable among 600, 150 and 50 ohms. And when you're testing for clipping



margin or headroom, the SG 505 generates high level output of +28 dBm into a 600 ohm load and +30 dBm into a 150 ohm load.

Answers come quickly with the AA 501. No level setting, tuning or nulling required. Measurements are precalculated via digital processing and displayed on the LED readout automatically.

Part of the family: TM 500. These two plug-ins share the configurability that TM 500

is famous for: over 35 different plug-ins for a host of test and measurement requirements. Six mainframes provide bench, rackmount and portable packaging, each with built-in power supply.

Call the Tektronix National Marketing Center today for specifications, pricing and applications information. Technical personnel can answer your questions, accept your order and expedite delivery. Direct orders

include operating manuals, 15-day return policy, full Tektronix warranty and service back-up.

**Order toll free:
1-800-426-2200**

Ask for Dept. M3045
(In the State of Washington, call 1-253-5353 collect.)

**The Answer
By Any
Measure**

MICROPHONES!

At long last, all the questions you ever asked...all the problems you ever grappled with...are answered clearly and definitively!

The Microphone Handbook

In 256 fact-filled pages, liberally sprinkled with over 500 illuminating photographs, drawings and diagrams, John Eargle covers virtually every practical aspect of microphone design and usage.

Completely up to date, this vital new handbook is a must for any professional whose work involves microphones. Here are just a few of the topics that are thoroughly covered:

- Directional characteristics—the basic patterns.
- Using patterns effectively.
- Microphone sensitivity ratings.
- Remote powering of capacitors.
- Proximity and distance effects.
- Multi-microphone interference problems.
- Stereo microphone techniques.
- Speech and music reinforcement.
- Studio microphone techniques.
- Microphone accessories.
- And much, much more!

THE MICROPHONE HANDBOOK. You'll find yourself reaching for it every time a new or unusual problem crops up. Order your copy now!

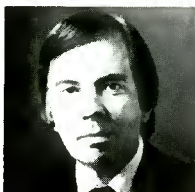

JOHN EARGLE,

noted author, lecturer and audio expert, is vice-president, market planning for James B. Lansing Sound. He has also served as chief engineer with Mercury Records, and is a member of SMPTE, IEEE and AES, for which he served as president in 1974-75. Listed in *Engineers of Distinction*, he has over 30 published articles and record reviews to his credit, and is the author of another important book, *Sound Recording*.

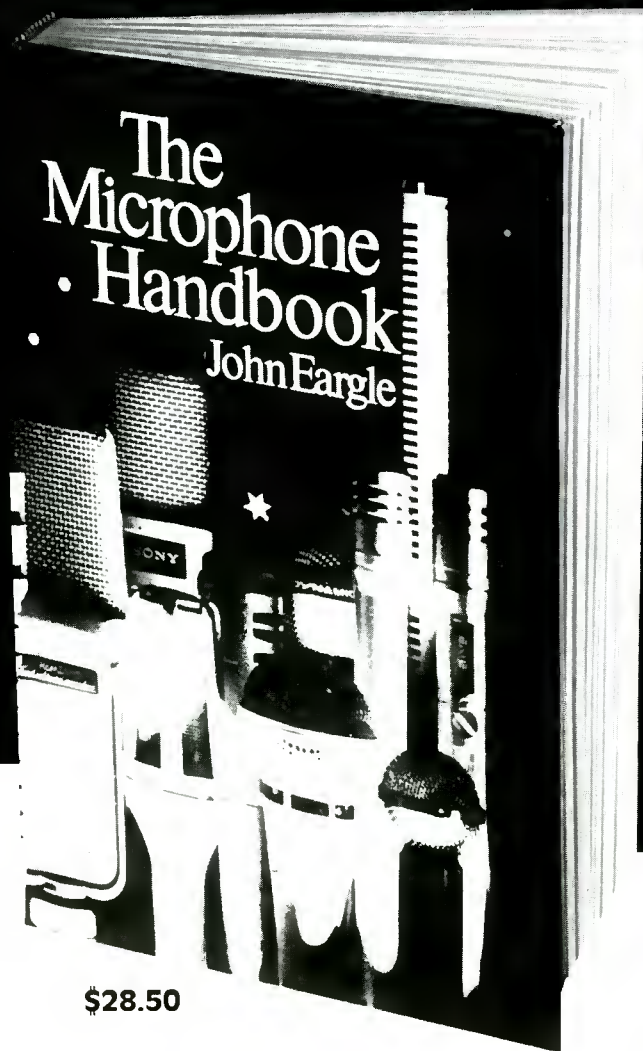

\$28.50

ELAR PUBLISHING CO., INC.

1120 Old Country Road, Plainview, NY 11803

Yes! Please send _____ copies of **The Microphone Handbook** (a \$28.50 per copy. (New York State residents add appropriate sales tax.)

Payment enclosed.

Or charge my MasterCard Visa

Acct. # _____ Exp. Date _____

Name _____
(please print)

Address _____

City _____

State/Zip _____

Signature _____

Outside U.S.A. add \$2.00 for postage. Checks must be in U.S. funds drawn on a U.S. bank.

If you aren't completely satisfied, you may return your copy in good condition within 15 days for full refund or credit.

db Bookcase

Please indicate the number of copies of each title you want and enclose check or money order for the total amount. In New York State, add applicable sales tax. Outside U.S.A. add \$1.00 per book. Allow several weeks for delivery. Address your order to:

Sagamore Publishing Co.
1120 Old Country Road
Plainview, New York 11803

	Quan.	Quan.	Quan.	Quan.	Quan.
— 1	— 10	— 19	— 28	— 37	
— 2	— 11	— 20	— 29	— 38	
— 3	— 12	— 21	— 30	— 39	
— 4	— 13	— 22	— 31	— 40	
— 5	— 14	— 23	— 32	— 41	
— 6	— 15	— 24	— 33	— 42	
— 7	— 16	— 25	— 34	— 43	
— 8	— 17	— 26	— 35	— 44	
— 9	— 18	— 27	— 36	— 45	

Total payment enclosed \$ _____ (Include N.Y.S. sales tax if applicable, or \$1.00 per book foreign.)

Name _____

Address _____

City, State, Zip _____

Check must be in U.S. funds drawn on a U.S. bank.

2. Sound Recording. (2nd ed.)

John M. Eargle. A graphic, non-mathematical treatment of recording devices, systems and techniques, and their applications. Covers psychoacoustics, physical acoustics, console automation, signal processing, monitor loudspeakers, basic microphone types, audio control systems, stereophonic and quadrasonic sound, magnetic and disk recording, and devices used to modify basic recorded sounds. 320 pages. **\$21.95**

3. Acoustic Design, M. Rettinger.

New, THIRD edition completely revised. Covers room acoustics and room design, with many practical examples. 1977. 287 pages. **\$24.50**

38. Television Broadcasting: Equipment, Systems, and Operating Fundamentals. Harold E. Ennes.

An extensive text covering fundamentals of the entire television broadcasting system. Discusses NTSC color systems, camera chains, sync generators, recording systems, mobile and remote telecasts, tv antenna systems. Excellent for new technicians and operators as a source of valuable reference data for practicing technicians. Tables, glossary, exercises and answers. 656 pages. **\$22.95**

39. Reference Data for Radio Engineers. ITT Staff. 5th Ed.

The latest edition of one of the most popular reference books for radio and electronics engineers, as well as for libraries and schools. Complete, comprehensive reference material with tables, formulas, standards and circuit information. 45 chapters, 1,196 pages with hundreds of charts, nomographs, diagrams, curves, tables and illustrations. Covers new data on micro-miniature electronics, switching networks, quantum electronics, etc. **\$34.95**

1. The Technique of the Sound Studio. Alec Nisbett.

A handbook on radio and recording techniques whose described principles are equally applicable to film and television sound. 60 diagrams, glossary, index. 264 pages. Cloth. **\$27.50**

4. Noise Control. M. Rettinger.

Revised and enlarged into a separate volume. Covers noise and noise reduction, measurement and control. Several graphs and charts. 1977. App. 400 pages. **\$28.50**

20. The Audio Cyclopedia (2nd ed.). Dr. Howard M. Tremaine.

Here is the complete audio reference library in a single, updated volume. This revised edition provides the most comprehensive information on every aspect of the audio art. It covers the latest audio developments, including the most recent solid-state systems and integrated circuits, and spans all subjects in the field of acoustics, recording, and reproduction with more than 3,400 related topics. Each topic can be instantly located by a unique index and reference system. More than 1,600 illustrations and schematics help make complicated topics masterpieces of clarity. 1,760 pages. Hardbound. **\$44.95**

25. Operational Amplifiers-Design and Applications. Burr-Brown Research Corp.

A comprehensive new work devoted entirely to every aspect of selection, use, and design of op amps—from basic theory to specific applications. Circuit design techniques include i.c. op amps. Applications cover linear and non-linear circuits, A/D conversion techniques, active filters, signal generation, modulation and demodulation. Complete test circuits and methods. 474 pages. **\$33.50**

31. Solid-State Electronics. Hibbard.

A basic course for engineers and technicians, and an extremely practical reference book for anyone who wants to acquire a good, general understanding of semi-conductor principles. Features questions and answers, problems to solve. 1968. 169 pages. **\$32.50**

32. Circuit Design for Audio AM/FM, and TV. Texas Instruments.

Texas Instruments Electronics Series. Emphasizing time- and cost-saving procedures, this book discusses advances in design and application as researched and developed by TI communications applications engineers. 1967. 352 pages. **\$34.50**

37. Television Broadcasting: Systems Maintenance (2nd ed.). Harold E. Ennes.

A thorough treatment of modern television maintenance practice covering maintenance of the tv broadcasting system from switcher inputs to antenna. Discusses day-to-day operation of systems, test and measurements, including proof of performance for both visual and aural portions of the installation. 624 pages. **\$22.95**

6. Sound System Engineering. Don and Carolyn Davis.

The first of its kind, this book is the one source of sound information you can rely on to give you everything you must know to design, install, and service commercial sound systems. The book covers acoustics environments, design applications, equalizing, installations, and interfacing. Hundreds of drawings, photos, charts, and graphs are supplied. 1975. 296 pages. Hardbound. **\$21.95**

28. Environmental Acoustics. Leslie L. Doelle.

Applied acoustics for people in environmental noise control who lack specialized acoustical training, with basic, comprehensible, practical information for solving straightforward problems. Explains fundamental concepts with a minimum of theory. Practical applications are stressed, acoustical properties of materials and construction are listed, actual installations with photos and drawings are included. Appendixes illustrate details of 53 wall types and 32 floor plans, and other useful data. 246 pages. **\$42.50**

36. The Handbook of Noise Control (2nd ed.). Cyril M. Harris.

Leading noise control authorities share their strategies and know-how in this in-depth treatment of all aspects of noise control. Tables facilitate rapid solutions to practical problems, and illustrations show noise control techniques for a range of common problems. Coverage includes the social, psychological, physiological, and legal aspects of noise and noise control. Hardbound. **\$47.50**

40. Studio Acoustics. M. Rettinger.

The author provides those first design principles of sound recording studios that are required for satisfactory vocal and instrumental recording conditions. All equations are presented in both English and MKS systems of measurement. Metric equivalents follow in parentheses when the studio descriptions include linear dimensions. The book is divided into three sections: Basics, Studios and Electroacoustics. 241 pages. **\$35.00**

OUT OF PRINT

OUT OF PRINT

Publisher
Larry Zide

Editor
John M. Woram

European Editor
John Borwick

Associate Editor
Mark B. Waldstein

Production & Layout
David Kramer

Advertising Coordinator
Karen Cohn

Classified Advertising
Carol Vitelli

Book Sales
Lydia Calogrides

Circulation Manager
Eloise Beach

Graphics
K & S Graphics

Typography
Spartan Phototype Co.



NOVEMBER 1982 VOLUME 16, NO. 11

sales offices

Roy McDonald Associates, Inc.
Dallas, Texas 75207
First Continental Bank Bldg.
5801 Marvin D. Love Freeway
Suite 303
(214) 941-4461

Denver, Colorado Area
Englewood, Colorado 80112
14 Inverness Dr. East
Bldg. 1—Penthouse
(303) 771-8181

Houston, Texas 77036
6901 Corporate Drive
Suite 210
(713) 988-5005

Los Angeles Area
Glendale, California 91204
424 West Colorado Street
Suite 201
(213) 244-8176

Portland Area
Hillsboro, Oregon 97123
510 South First
P.O. Box 696
(503) 640-2011

San Francisco Area
Emeryville, California 94608
265 Baybridge Office Plaza
5801 Christie Avenue
(415) 653-2122

Sagamore Publishing Co.
New York
Plainview, NY 11803
1120 Old Country Rd.
(516) 433-6530

FEATURES

STUDIO POWERING AND GROUNDING TECHNIQUES	Thomas M. Hay
26	
A db APPLICATION NOTE: ZAP—ZERO ACOUSTIC PHASE CANCELLATION	Bill Graham and Randy Churchill
36	
db CONVENTION REPORTS:	
THE 72nd AES CONVENTION: TECHNICAL SESSIONS AND WORKSHOPS	Ken Pohlmann
38	
THE 72nd AES CONVENTION: THE EXHIBITS	John Woram
42	

DEPARTMENTS

LETTERS	EDITORIAL	CLASSIFIED
6	24	52
DIGITAL AUDIO		Barry Blesser
8		
SOUND WITH IMAGES		Len Feldman
14		
SOUND REINFORCEMENT		John Eargle
20		
THEORY AND PRACTICE		Ken Pohlmann
22		
NEW PRODUCTS AND SERVICES		
46		
PEOPLE, PLACES, HAPPENINGS		
54		

About The Cover

• This month, we return to Philadelphia for a wide-angle view of the control room at Sigma Sound Studios. Our thanks to Spencer Zahn for providing us with this month's cover.

db, the Sound Engineering Magazine (ISSN 0011-7145) is published monthly by Sagamore Publishing Company, Inc. Entire contents copyright © 1982 by Sagamore Publishing Co., 1120 Old Country Road, Plainview, L.I., N.Y. 11803. Telephone (516) 433 6530. db is published for those individuals and firms in professional audio-recording, broadcast, audio-visual, sound reinforcement, consultants, video recording, film sound, etc. Application should be made on the subscription form in the rear of each issue. Subscriptions are \$15.00 per year (\$28.00 per year outside U.S. Possessions; \$16.00 per year Canada) in U.S. funds. Single copies are \$1.95 each. Editorial, Publishing and Sales Offices: 1120 Old Country Road, Plainview, New York 11803. Controlled circulation postage paid at Plainview, NY 11803 and an additional mailing office.

Audio Tape

for professionals

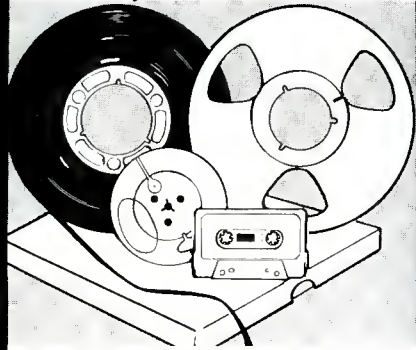

REEL TO REEL TAPE

Ampex, 3M. All grades.
On reels or hubs.

CASSETTES, C-10—C-90

With Agfa, TDK tape.

LEADER & SPLICING TAPE

EMPTY REELS & BOXES

All widths, sizes.

Competitive!
Shipped from Stock!

Ask for our recording supplies catalog.

Poly Corp. 312/298-5300

1233 Rand Rd. • Des Plaines, IL 60016

15

Circle 12 on Reader Service Card

Letters

Index of Advertisers

Alpha Audio	31
Ampex	Cover IV
Audio-Technica	15
Bose	13
Cetec Gauss	21
Cetec Vega	17
Crown	11
Datatronix	30
Emilar	6
JBL	9
Kimball	10
Klark-Teknik	29
Maxell	Cover III
Microtran	23
PAIA	47
Polyline	6
Russco	22
Shure	19
STL	49
Studer	16
Technics	32
Tektronix	Cover II
Telex	18, 33
IOA	7
UREI	12

CATCH A WAVE

TO THE EDITOR:

In the July 1982 issue of **db**, you featured an article on Suzanne Ciani's "Seven Waves" album. I would like to know where this album may be purchased. I have tried a number of record stores, but with no results. If you know of a store that carries it, I would appreciate the name and address.

J. HOLLINGSWORTH

db replies:

We're told that a distribution deal for Suzanne's "Seven Waves" album is currently in the works. For information about where to buy the album, contact Ciani/Musica, 1650 Broadway, New York, NY 10019. Tel: (212) 246-6625.

CONSOLE CREDIT DUE

TO THE EDITOR:

I may be mistaken, but isn't the console in the photo on page 40 of the August '82 issue of **db** actually a Yamaha PM-2000, and not a Midas as captioned? I don't mean to nit-pick, but I believe in credit where credit is due. Both are obviously fine consoles.

Thanks for a fine magazine.

JOHN C. REHNER

President

Sawmill Sound Co., Inc.

db replies:

You're right—it is a Yamaha board. The author forwarded the picture and caption as received from the theatre. We haven't been able to reach anyone there to determine where the slip-up occurred, but Phil Moon at Yamaha confirms that it is indeed one of their consoles.

Coming Next Month

• December is **db's** Sound With Images month. Art Shifrin of Thomson-CSF Broadcast brings us a look at what sound and film synchronization was like before SMPTE time code, television, or even *The Jazz Singer*; our European editor John Borwick reports on Pinewood Film Studios and the Barbican Centre for Arts and Conferences, and Ralph Hodges checks with the inside dope on the soundtracks of *Fantasia* and *Tron*. In addition, **db** editor John Woram continues his report on the recently concluded AES convention. All this—and much more—coming in December's **db—The Sound Engineering Magazine**.

EL-15 Woofer

- 25-5000 Hz
- 200 Watts
- 100 dB M/W
- 4" Voice Coil

EMILAR

For complete information:

(714) 632-8500

(800) 854-7181

EMILAR CORPORATION

1365 N. McCan St.,
Anaheim, CA 92806

Circle 14 on Reader Service Card

THE RUGGED, COMPACT TOA MONITORS

DESIGNED TO PERFORM WHERE YOU NEED THEM THE MOST.

For the stage, the powerful SM-60 stage monitor speaker system. For the studio or stage, the equally powerful RS-21M reference mini-monitor. Both as small and as rugged as we could engineer them—without compromising the performance you need for accuracy and higher power-handling. They're everything you've always wanted in smaller, high quality monitors. And less. Less bulk and less set-up hassles.

Our SM-60 is a full-range, dual transducer speaker system with a rated input of 70 watts*. It features a sensitivity of 90 dB SPL—for operation at levels that really cut through. The frequency response is 110Hz to 16kHz—extended top and bottom to cover a broad musical range. And instead of cheap plastic or flimsy wooden boxes, we enclose the SM-60 in a tough, extruded aluminum shell with solid cast end panels.

When you make your set-ups with an SM-60 you've got options too. The adjustable mounting bracket will securely attach the monitor to the top of the mic stand or anywhere along the stand itself. And when a speaker cable is stepped on, you're not going to lose the show because the connections are terminated with our exclusive positive-locking, 1/4" phone jack.

The RS-21M is a closed enclosure, full-range reference monitor that can handle a rated input of 35 watts**. It gives you a sensitivity of 88 dB SPL (1W@1m) and a frequency response of 100Hz to 17kHz. The RS-21M is designed to fit right where you usually need it the most—right on top of the meter bridge of our RX Series boards.

Both new monitors can take the toughest, continuous high power use on stage or in studio. They're companion

systems that join our compact RX Series consoles and the extension of our philosophy that professional sound gear doesn't have to be bulky, unsightly and a drag to set-up.

The SM-60, the RS-21M and our RX Series consoles—they're big on performance and stingy on space, the kind of studio equipment designed to perform where you need it the most.

*16 ohms **8 ohms



*Crafted in Japan
Proven in the States.*

TOA Electronics, Inc.

480 Carlton Court
South San Francisco, Ca. 94080
(415) 588-2538 Telex: 331-332

In Canada:

TOA Electronics, Inc.

10712-181 Street
Edmonton, Alberta T5S 1K8
(403) 489-5511 Telex: 037-43255

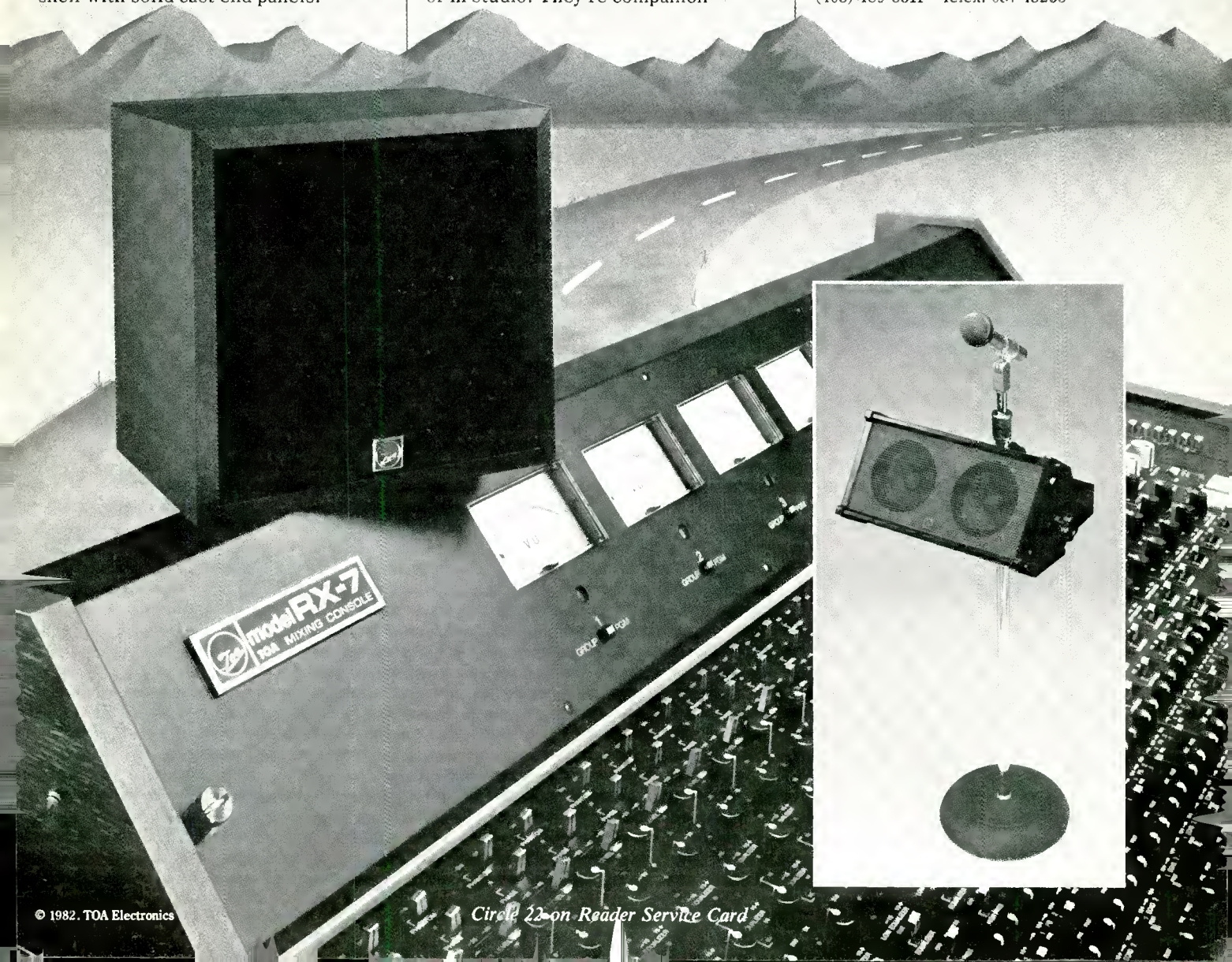

Digital Audio

Digital Filters: Part III

• Last month we began an example of "building" a digital filter on an ordinary programmable calculator. This month we will continue with this project, and I'd recommend that you dig out last month's column to refresh your memory.

We left off with the idea of implementing a delay line using the ring memory algorithm. The coding of the program steps was based on the idea of using the IND (indirect) function for storing data. The following program segment implements a 10-tap delay function: the program can be defined to begin at a particular location, or we can just name the beginning as "A." (Remember, the "\$" indicates the beginning of a comment.)

```

LBL A      $ the name of the
           program begin-
           ning,
1          $ the increment
           value for the
           pointer,
SUM 0     $ add 1 to the
           pointer in regis-
           ter 0,
RC 0      $ recall the pointer
           into the X-register
           for a comparison
           test,
X←T       $ place the pointer
           in the T-register,
19        $ a test value,
IF X≥T GOTO B $ if the pointer is
           greater than 20,
           then continue;
           otherwise, jump
           (to LBL B, below).
10        $ the reset value,
ST 0      $ store the reset
           value in the
           pointer register,
           (These two steps are
           executed only if the
           X ≥ T test failed.)
LBL B     $ the entry point for
           the jump from the
           test,
    
```

```

R/S       $ stop to allow the
           user to enter data.
           Press R/S to con-
           tinue,
ST IND 0  $ place new data in
           the register speci-
           fied by the
           pointer,
GOTO A    $ iterate for a new
           cycle by restarting.
    
```

To start the program, place a 9 into the pointer register and press A. The program will stop waiting for input data. The user provides the first sample (in the same way that an A/D converter would do so), and then presses R/S to continue. The program will again stop waiting for the second data point. Enter new data, and press R/S again to continue. After 11 iterations, the new data will overwrite the first data point which was stored in register 10.

COEFFICIENTS

The next step in completing the program is to multiply all of the stored data by the appropriate coefficients. First, we need to store these coefficients in registers in order for the program to have access to them. In digital audio hardware, the coefficients might be stored in a separate ROM or RAM. But since the calculator has no such separate storage, let's assign registers 30 through 39 to the coefficients. The algorithm for multiplication can be similar to that of data storage using pointers. However, we should note that the iterations for coefficient multiplication must go through all ten taps on each cycle of the input data. A separate loop is thus required with a fixed count of 10. Moreover, the loop pointer goes through a fixed sequence for the coefficients, but a variable sequence for the data. The current data does not have a unique location, but is defined by the data-input pointer.

As we continue, be careful with semantics. So far, we have had only one

pointer, but when we introduce a second one, we must make a careful distinction between them. We'll call our original pointer the data-input pointer, or D-pointer. Our new pointer will be the coefficient-multiplication pointer, or C-pointer.

A side note at the point concerning pointers: they all need to be circular. This is true of both the C- and D-pointer. Instead of writing this algorithm twice, we can create a sub-routine which will be called whenever we wish to force a pointer to be circular. The sub-routine will only convert a number equal to, or greater than, 20 into the reset value of 10. We'll enter the sub-routine with a number indicating the register containing the pointer:

```

LBL E     $ the name of the
           sub-routine,
ST 04     $ place register se-
           lector in (tempo-
           rary) register 4,
RC IND 4  $ recall the D-
           pointer,
X←T       $ place the pointer
           in the T-register,
19        $ the test value,
IF X≥T GOTO B $ if the pointer is
           greater than 20
           then continue;
           otherwise jump (to
           LBL B, below),
10        $ the reset value,
ST IND 4  $ store the reset
           value in the
           pointer register,
           (These two steps are
           executed only if the
           X ≥ T test failed.)
LBL B     $ the entry point for
           the jump from the
           test,
RTN      $ return to the call-
           ing program.
    
```

This sub-routine is essentially the same algorithm used in the original program segment. However, by pulling it out as a sub-routine, many different program segments can make use of it. A very real at-

At JBL, we design professional products with just one application in mind...

Yours.

Circle 15 on Reader Service Card

Whether you're designing sound systems for 20,000 seat concert halls or 20 seat boardrooms, one thing remains constant—the need for quality, high performance audio products. Yet the very performance characteristics that make an audio component ideal for one application can make it only marginally acceptable for another. And that can make component selection a real headache for you.

At JBL, we have a solution. We tailor each product in our extensive line to meet the demands of a specific application. So no matter what kind of system you have in mind, you'll find a JBL component that offers a perfect match.

If this approach makes sense to you, ask the audio specialists at your JBL professional products dealer for the details. They can help you get the exact performance you need without guesswork or compromise.

JBL Professional Products Division

JBL/harman international

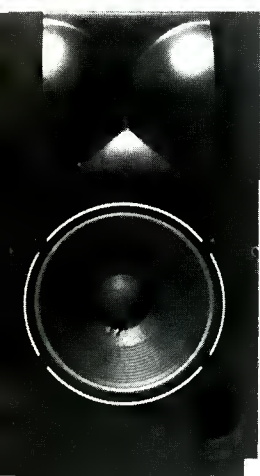

4435



2366



2225

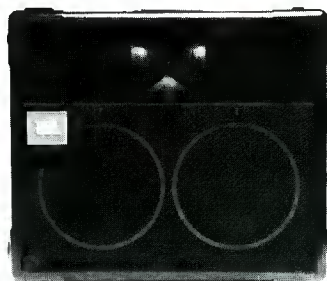

4612

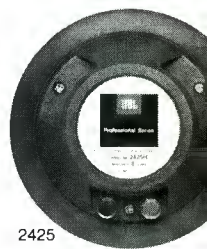

2425

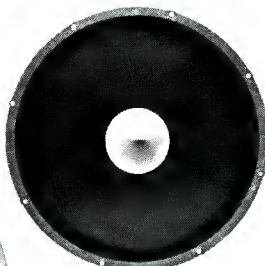

E130

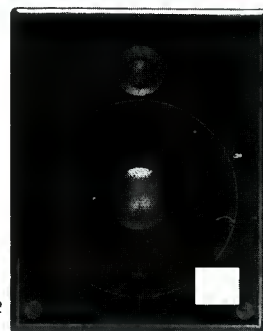

4602



2445



4411



2360

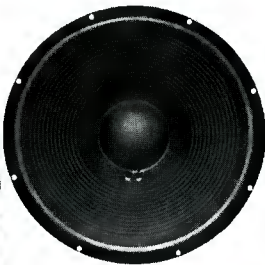

2235



4662

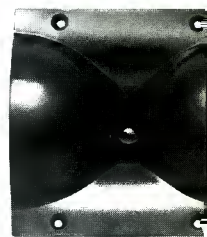

2404



4401

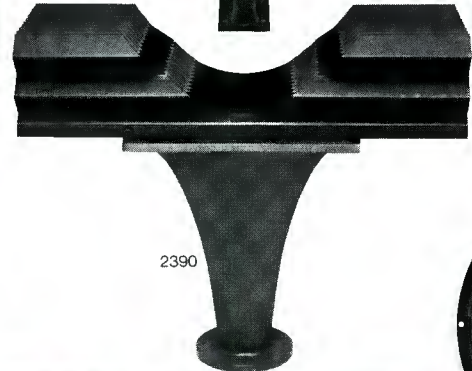

2390



2245

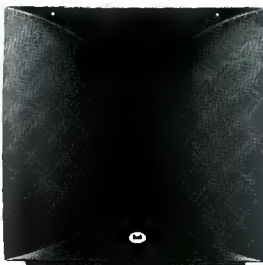

4675



2402

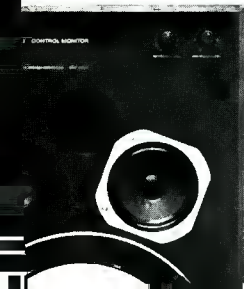

4312



2370

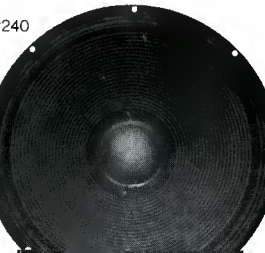

2240

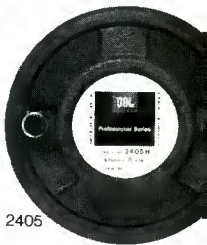

2405



2397

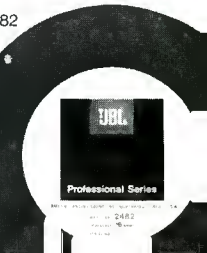

2482

traction of this approach is that once the sub-routine is debugged, we know that whenever this algorithm is required, it will be executed without error.

Our original program segment now becomes:

LBL A \$ the name of the program beginning,
 I \$ the increment value for the pointer,
 SUM 0 \$ add 1 to the pointer in register 0,
 0 \$ specify the register for the sub-routine,
 SBR E \$ call the sub-routine, to force the pointer to be circular and convert numbers greater than 20 to 10,
 R/S \$ stop to allow the user to enter data. Press R/S to continue,
 ST IND 0 \$ place new data in the register specified by the D-pointer,
 (output) \$ a new program segment to be added (see below),
 GOTO A \$ iterate for a new cycle by restarting.

The output computation segment must now be written. It will contain a new set of pointers for the selection of the required delay data and the coefficients.

We must first define a new group of registers for the new activities. Our C-pointer, which will scan all the delayed data registers, will be located in register 1. The accumulated products from the taps will be stored in register 2, and we will allow a temporary pointer to be in register 3. In all loops such as this one, there are three phases: Initialization of the loop, Computation iteratively, and Test for exit. The initialization is:

0 \$ 0 for clearing the accumulator,
 ST 2 \$ clear the accumulator,
 RC 0 \$ recall the original D-pointer, showing the current data,
 ST 1 \$ initialize the C-pointer with the initial value,
 30 \$ the initial location for the coefficient,
 ST 3 \$ store the initial coefficient pointer.

This is the initialization and we are ready to begin the loop. This loop must update the pointers, recall the data sample, recall the coefficient, multiply and accumulate the sum. The program segment is;

LBL C \$ the name of the loop beginning,
 I \$ the increment value for updating the C-pointer,
 SUM 1 \$ update the pointer,
 I \$ select the C-pointer when entering sub-routine E,
 SBR E \$ call the sub-routine, to make the pointer circular,
 RC IND 1 \$ recall the delay data named by the C-pointer,
 X \$ multiplication for delay-tap scaling,
 RC IND 3 \$ recall the coefficient for this tap,
 = \$ the result,
 SUM 2 \$ add this tap to the previous sum,
 I \$ increment the value for the C-pointer,
 SUM 3 \$ update the coefficient pointer for next pass.

The final issue is that of when we are finished. We can do this several ways. A count-down of ten iterations is one method. We can also take advantage of the fact that the C-pointer must again be equal to the D-pointer when it has looped through all data register. The exit becomes very simple:

X→T \$ place the pointer in the T-register,
 RC 0 \$ recall the initial D-pointer,
 X≠T GOTO C \$ continue looping until the pointers are equal,
 RC 2 \$ recall the final accumulator result,
 PRT \$ print the result (if a printer is available).

This completes our program. We can test it in a systematic way. However, we may wish to make one change before doing so. When the calculator stops to give us time to enter a new value, we may present the output value at that time. To make that change, add RC 2 just before the R/S.

TESTING

Before testing your program, there are several points to be considered. The most obvious one is that of the "typo" a typographical error. Almost any typo will result in an incorrect program and some errors will only show up in special cases. It should also be noted that the above program does not exactly follow the conventions of the TI-58, 59 series of calculators. The changes are for readability. Users of Hewlett-Packard calculators will have to make some other changes because these calculators use reverse-

More and more recording studios are discovering the great sound of the Kimball Professional Grand.

Here's why:

The Kimball 6' 7" Professional Grand derives its heritage of greatness from the world's finest piano—the Bosendorfer. The scale and plate design are derived from the Bosendorfer Model 200, and the plate is extra thick to assure maximum sustain and to avoid plate noise from hammer strikes. The Bosendorfer-derived scale and non-duplexed trebles enhance tonal depth, clarity, and pitch perception. The Kimball Professional Grand is specifically designed for clear, pure tonality, free of spurious noise and false harmonics. It also offers superior durability and tuning stability. Its entire structure, including the soundboard, is of precision-laminated woods, greatly reducing differential expansion in changes of temperature and humidity.

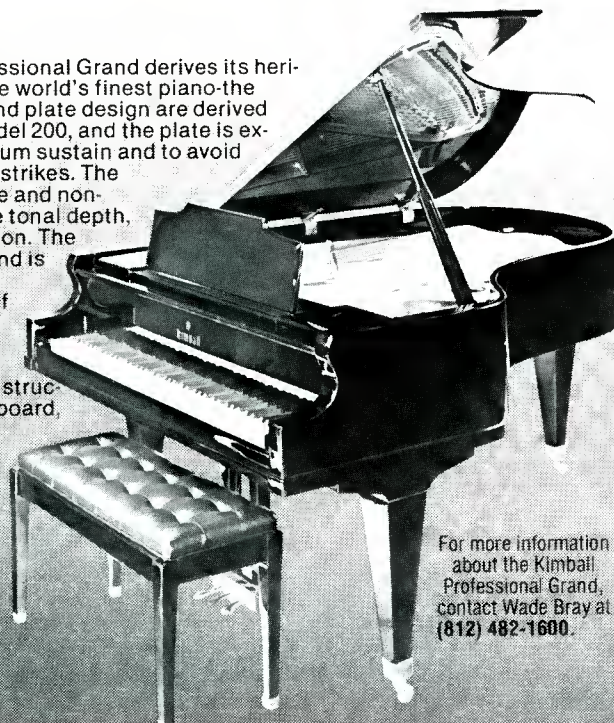

For more information about the Kimball Professional Grand, contact Wade Bray at (812) 482-1600.



kimball

"The key to sounding great!"
 1549 Royal St. Box 460
 Jasper, IN 47546

POWER. PRECISION. CHOICE.

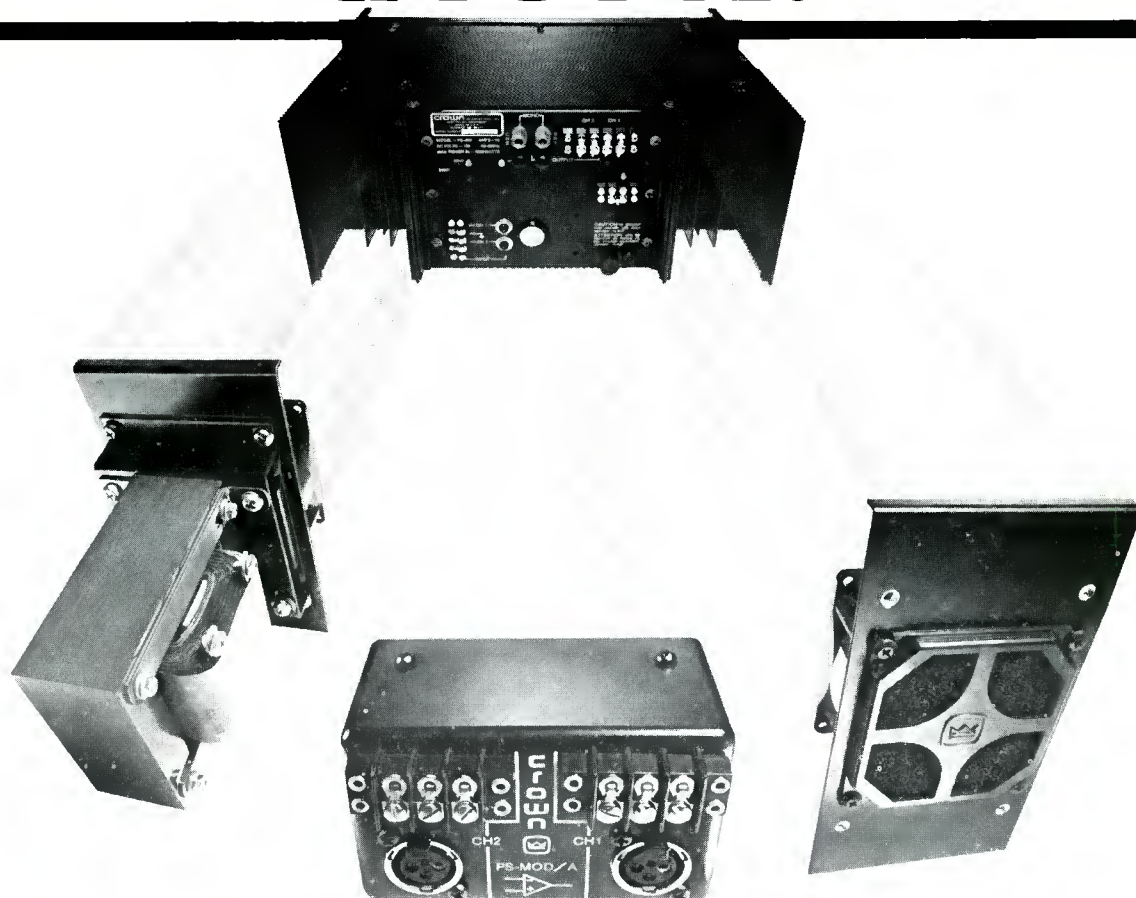

Build yourself a stronger reputation by selecting the unique flexibility and professional performance of two new Crown power amps: the PS-400 or the PS-200.

Choose only the special, low-cost options you need: plug-in balanced input, active or passive; 70-volt transformer; dual fans. Install them easily, quickly, anytime, in any combination – thanks to the fresh, innovative design of these amps.

Built-in features make these amps the first choice of professionals: instant mono/stereo conversion, terminal strip connectors plus phone jacks, IOC™ and signal-present indicators, low-frequency protection, and much more.

Select the power level you need. For full-time, reliable performance, both amps are built in the best Crown tradition. PS-200 rated (FTC) at 135 watts per channel into

4 ohms, PS-400 at 260. Mono ratings into 8 ohms are 270 watts (PS-200) and 520 (PS-400).

Introduce yourself to the new Crown MULTI-MODE™ output circuit, a new, three-deep design that eliminates audible distortion, and introduces a degree of precision sound reproduction that will delight performers and audiences.

Complete information on specifications and prices, for the amps and the optional accessories, is now available from Crown. For quick action, simply fill in the blanks below and send this corner of the ad to Crown.

Name _____

Address _____

City _____ State _____ Zip _____



PS-200



...WHEN YOU'RE READY FOR REAL!
1718 W. Mishawaka Rd., Elkhart, IN 46517, (219) 294-5571



PS-400

Polish rather than algebraic notations.

One almost-guaranteed way to get inconsistent results is to ignore the issue of initialization in the main program. When a calculator is turned on, all of the registers may contain zeroes. However, this is not defined. After running the program for some time, the machine is left in an unknown state. Hence, restating it will not give the same results. Because the main program loops at A, starting at A is equivalent to restarting from the previous state. Also, the ten-element delay is itself a memory of previous activities.

The following manual operations will preset the program to a known state. Enter a 9 into register-0, which will become 10 at the first increment; press RST

to clear the calculator of static information; clear all memories in registers 10 through 19. Alternatively, use CM (Clear Memories) and then load a 9 into register-0.

To start, press GOTO A, and then R/S. The calculator should display 0 as the answer to the previous computation. Enter the first value and press R/S. No matter what data is entered, the results will be 0 because we have not yet presented any coefficients. To test, we might place a 1 in register 39, as the coefficient for the first delay tap. Now, when we run the program the calculator will just return that value, since the program is unity gain with no delay. If register 38 is 1 and register 39 is 0, we should see a unity-delay system. Multiple coefficients in reg-

isters 30 through 39 will create the desired filter. Try it!

Let the input data be a single 1, followed by a series of 0s. That set of answers will be the filter's impulse response.

COMMENTS

When first running the program, you will be surprised at how slowly it runs. It takes about 15 seconds to produce one output. In a real-time environment, where the input data comes at a fixed rate, this digital filter would have a maximum sampling rate of 0.066 Hz and a signal bandwidth of 0.033 Hz. Clearly, this is not quite right for audio, although it might work for filtering weather data. One could speed up the program somewhat by using some programming tricks. Interestingly enough, the original program from last month will run faster, but it is 10 times larger. But no matter how we optimize it, the speed will still remain in the order of seconds. This means that this hardware is not appropriate for audio. A typical home computer will run somewhat faster than the TI-59 computer but the improvement is only by a factor of 2 to 10. For digital audio we need a hardware speed increase by a factor of about 1,000,000.

GOOD PROGRAMMING

Aside from comments, good programming requires that key information be in only one location rather than spread throughout the program. The reason is obvious; when we make a change we need to be concerned about having found all of the places for change. Consider making the filter 12 taps instead of 10. We may ask about where the information is located for this feature. It is only in sub-routine E which converts 20 to 10. If that sub-routine was changed to convert 22 or greater to 10, then the filter would have two more taps. Automatically, the data registers would be expanded to include registers 20 and 21; the corresponding coefficients would be located in registers 40 and 41. Further increases work until the line is 21 taps long. At this point, the data registers enter the coefficient registers. The program will still run, but the answers will be wrong. There is not a provision in the current program for catching this error. Of course, we could include some kind of error test in sub-routine E by testing for numbers greater than 29. To do so requires us to think about this error mode. Until the programmer has considered a way of making an error, he cannot write a program segment to prevent or report that error. This is one of the paradoxes of programs. They cannot be proven bug free since the lack of knowledge about a bug prevents us from testing that case except by accident. The strongest statement that can be made about a program is that there are no known bugs at this time.

Next month, we will explore using the filter. In the meantime, happy programming!

The Most Imitated Compressor/Limiter in the World: The UREI LA-4

For over 20 years, UREI electro-optical limiters have set the standard for automatic gain reduction. From the original LA-1 and the LA-2 vacuum tube "leveling amplifiers" to today's LA-4, these UREI compressor/limiters have given thousands of users the most musical and natural sounding results around.

The "soft-knee" compression curve, which eases the signal into control, is only one of the "LA" Series' features which have become models for the industry. The LA-4, like its illustrious predecessors, employs gain reduction circuits which respond much like your ears do.

These features, coupled with traditional UREI quality, make an unbeatable combination.

Insure the quality of your signal with the LA-4. It's the original, not an imitation. For more information on the LA-4 and other UREI signal processing equipment, see your authorized UREI dealer or contact:

Urei

From One Pro to Another
United Recording Electronics Industries
a URC Company
8460 San Fernando Road
Sun Valley, California 91352
(213) 767-1000 Telex: 65-1289 UREI SNVY
Canada: E. S. Gould Marketing, Montreal



The Super-Bose® System.

You can run everything through it.

It makes good acoustical (and economic) sense to run all of your instruments and voices through your PA system. Unfortunately, PA speakers are notorious for making musical instruments sound harsh and unnatural. Not to mention the small truck it takes to haul around a conventional PA system.

Introducing the Super-Bose System: two pairs of Bose 802 Loud-

speakers and an 802-E Active Equalizer. Together, they give you the wide-range response, unmatched clarity and smooth coverage you need to project the true sound of each instrument and voice to every seat. And the compact, lightweight design of the 802 enclosure makes set-up and storage hassles a thing of the past.

Send in the coupon for more information on the Super-Bose System. Better still, get a live demonstration at your authorized Bose Professional Products dealer, and find out how easy it is to run everything through your PA without making everything sound like a PA.

Bose Corporation, Dept. SE
The Mountain
Framingham, Massachusetts 01701

Please send me the Bose Professional Products Catalog and your technical data.

Name _____

Firm _____

Address _____

City _____

State _____ Zip _____

Telephone () _____

BOSE
Better sound through research.

Covered by patent rights issued and/or pending.
802 speaker design is a trademark of Bose Corporation.
© Copyright 1982 Bose Corporation.

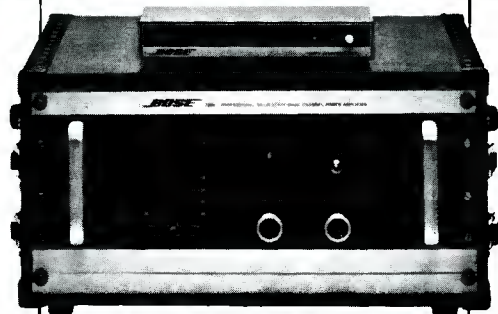

Sound With Images

Is Audio For Video Going Digital or FM?

• I have just finished listening to what is probably the most important new audio product to pass through my lab since I started testing audio equipment some fifteen years ago. As you've probably guessed, that kind of superlative could only be applied to a first-production version of a digital audio disc player, and that's what I've been listening to for about a week now, thanks to Sony Corporation and the Polygram group of European recording companies who supplied some of the first discs for my

listening pleasure.

So what's all that got to do with video and its relationship to audio (which is ostensibly the subject matter of this column)? Stay with me for a moment and you'll soon see.

If all of your video recording experience to date has been confined to consumer type VCRs, you know full well that the quality of the audio track leaves very much to be desired—even compared with the not-so-great video picture quality delivered by both popular half-

inch videotape formats. On ¾-inch videotape machines, such as U-matic, you'll find that while the picture resolution is certainly better than VHS and Beta format VCRs, audio quality is, at best, not much better than on a consumer-type cassette tape machine. As far as the audio is concerned, the tape is still traveling at a relatively slow speed; only the video tracks have the very high head-to-tape linear speed required for recording video signals. Audio wow-and-flutter is pretty high, too, in most cases.

VCA—the easy way for superior audio systems control



consolidate
control in broadcast, satellite,
production/recording audio systems

All the flexibility of modular design, All the convenience of rack equipment. The Protech Model 668VCA is 2, 3, or 4 channels of VCA control with integral power supply. Available with or without output transformers. Increase Profits & Reliability. Call or Write Today—

ProTechTM
Audio

(516) 584-5855
Flowerfield Bldg #1
St. James, N.Y. 11780

A BIT OF AUDIO DETECTIVE WORK

Last summer, at the Consumer Electronic Show, the word got out that Sony Corporation had developed a new kind of audio system for their Beta-format VCRs. Not only was the system capable of stereo audio recording on Beta cassettes, but it would have a frequency response capability from 20 Hz to 20,000 Hz and a signal-to-noise ratio and dynamic range capability far beyond anything that had been achieved with a VCR that employed rotating video heads. The word was that, somehow, Sony had managed to incorporate the audio signals in the form of a frequency-modulated signal that would be applied along with the video signal, using the fast-spinning videotape heads instead of the old-fashioned, stationary separate audio heads currently used.

For whatever their reasons, Sony did not want anyone from the audio/video press contingent to see or hear the new Beta machine, although, we were told they did show it to selected Sony distributors and some key dealers. Thus rebuffed, your enterprising reporter decided to hunt elsewhere for some answers.

My search led me first to a couple of papers which I found in the IEEE Transactions on Consumer Electronics, Volume CE-27, August 1981. The first of

In search of the ideal mixer.

In demonstrating our microphones throughout the country, we've found a serious limitation in most stage mixers. They are unable to handle wide range microphones on stage. And they just can't cut it when it comes to making demo tapes. Which means that the musicians need TWO mixers and perhaps TWO sets of microphones to get the sound they want on stage as well as on tape. It's a luxury not everyone can afford!

So, to solve your problem – and ours – we set out to create a "double threat" mixer which would be a great stage mixer, yet still give you the sound and control you need while taping. A mixer designed to take full advantage of every mike you own, including phantom-powered models.

Our standards (like yours) were high. Everything had to be rugged, reliable, and very clean. With wide basic frequency response, plenty of headroom, and very low distortion and noise. And the mixer had to be very natural to use. Finally, the price had to be right. We invite you to examine the new Audio-Technica ATC820 and ATC1220 stereo mixing consoles to see how well we have accomplished our goal.

Our prototypes have done a lot of traveling. Users were impressed with the features, the flexibility, and the sound. They liked the 3-band EQ on every input. And the 7-band stereo graphic program equalizers, plus another graphic equalizer for the monitor output. But most appreciated were the variable high-pass filters for each output. They permit you to use wide-range recording microphones on the stage, while exactly limiting bass response to suit acoustics and to keep from overloading your speakers. Yet during recording you can go all the way down to 20 Hz if you wish.

There's a long list of very practical features. Phantom power is available at each of the transformer-isolated mike inputs. Two 20 dB mike input pads plus an LED to warn of clipping on each input. A SOLO button to check any input with headphones without affecting the mix. "Stackable" design when 8 or 12 inputs aren't enough. Even an assignable talk-back input. And all the logical controls for the transformer balanced MONITOR, EFFECTS, SOLO, PHONES, and OUTPUT

busses. In short, very flexible, and quite complete.

With a very modest investment, you can do almost everything the single-purpose boards can do... and do it very well. And get the benefit of phantom-powered recording mikes on stage as well as during recording. The more you learn about the ATC820 and ATC1220 the more impressed we think you'll be. Ask your Audio-Technica sound specialist for a hands-on tour of this brand new breed of mixer. Or write for literature. We may have the ideal answer to your mixer requirements.



audio-technica®



AUDIO-TECHNICA U.S., INC., 1221 Commerce Drive, Stow, Ohio 44224 • (216) 686-2600
Circle 20 on Reader Service Card

these papers, surprisingly, was by a group of engineers from Hitachi. In discussing a prototype video camera, in which a tiny 1/4-inch tape cassette is installed in the one-piece camera recorder, the authors describe their "video composite" recording. To paraphrase their discussion, they first acknowledge that the slower tape speed, necessary in this compact VCR/camera combination, would degrade some recording quality if a stationary linear audio recording scheme was used. They then cite three advantages of composite video/audio recording:

1. Wow and flutter does not depend upon linear tape speed fluctuation.
2. Wide-band response is obtained easily, even with slow-moving tape, because frequency response is no longer dependent upon linear tape speed.
3. In high-speed playback modes (such as scanning), the audio signal remains clear enough to be intelligible, because audio pitch is kept constant.

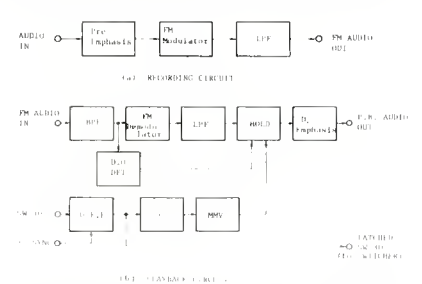

Figure 1. Block diagram of an FM Audio Recording System suitable for video recording.

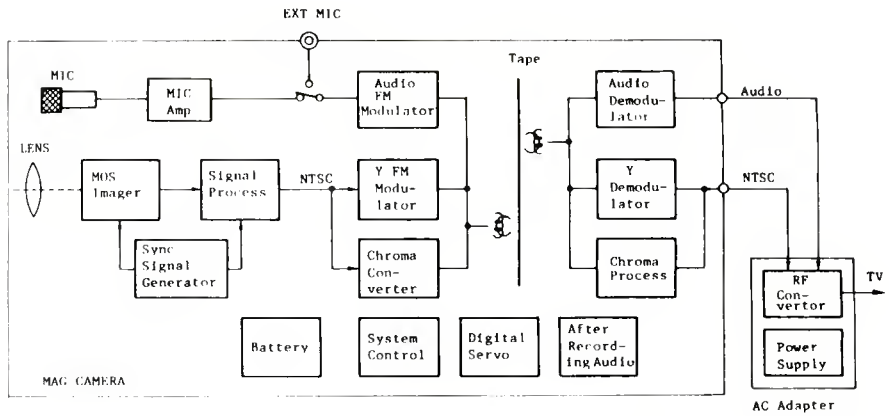

Figure 2. Block diagram of a complete video/audio camera/recorder system, utilizing FM audio as part of the overall video signal.

The Hitachi engineers then describe the disadvantages of video-composite FM audio recording, including the noise that appears at the switching point of the video output signals from the two video heads used in all helical-scan VCRs. They explain how this noise problem was solved and present a block diagram of the audio record and playback scheme (FIGURE 1) as well as a block diagram of the entire experimental VCR/camera (FIGURE 2). This overall system block diagram shows how the FM audio signal is simply combined with the video signal and applied to the video tape heads during recording, and read by the video heads during playback.

In that very same issue of the IEEE Transactions on Consumer Electronics, there appears an article by several Sony engineers. The subject of their paper parallels the Hitachi research effort. The paper was titled, "Development of An Extremely Small Video Tape Recorder." The unit described has been called a Video Movie Unit and has been demonstrated more than once at various trade shows and technical exhibitions here and in Japan. Just before the conclusion of the article, the authors suggest that longer recording time than the originally available 20 minutes would be desirable for their combination camera/VCR unit. To achieve this, tape speed would have to be brought down to as low as 7 mm/sec. That's little more than half the speed of the 5-hour Beta III mode and quality audio recording would be just about impossible with a stationary audio tape head. Now here comes the surprising conclusion. The authors note that various alternative approaches for sound recording have been proposed, such as



Revox PR99.
Not just another pretty faceplate.

Before you buy a compact audio recorder, be sure to compare what you're getting on the inside. Look at the chassis, the headblock, the motors, the switches, the PC boards, and the wiring. When you do, you'll notice a difference between the PR99 and everything else in its price range. The PR99 looks better because it must adhere to stricter standards of quality. Standards that have made Studer Revox the world's most respected name in audio recording.

- PR99 features:
- Balanced and floating line in and line out
 - Calibrate/uncalibrate switches
 - Servo controlled capstan motor
 - Edit mode switch
 - Tape dump
 - Self sync
 - Optional remote control and vari-speed
 - Cabinet, console, and rack mount versions.



STUDER REVOX OF AMERICA, INC. • 1425 Elm Hill Pike • Nashville, TN 37210 • (615) 254-5651

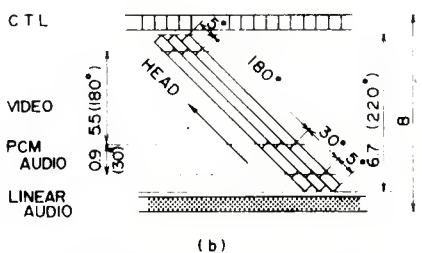
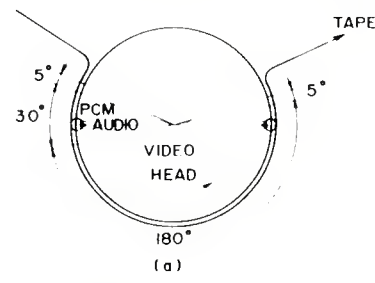

Figure 3. Adding another 30 degrees of tape-wrap around the rotating video head drum (A) allows for the addition of PCM digital audio information at the end of each video field scan (B).

Brilliant performer.

**NEW
WIRELESS**

Model 82 Wireless Condenser Hand-Held



The Model 82 condenser wireless microphone has been added to Cetec Vega's professional hand-held line. The Model 82 incorporates the popular Shure SM85 condenser element and attractive black windscreen to provide:

- Minimal handling noise, reduced mechanical vibration, and virtually no "boominess" (by means of controlled low-frequency rolloff).
- Clean reproduction of close-up vocals with moderate proximity effect.
- "Crispness" and presence with high-definition midrange.
- Clear, scintillating highs with crisp upper register.
- Cardioid pickup pattern for effective rejection of off-axis sounds.

All Cetec Vega hand-held wireless microphones (including the Model 80 with the Electro-Voice EV-671 dynamic element and the Model 81

with the Shure SM58 dynamic element) have an attractively contoured black case with internal antenna.

Used with Cetec Vega professional wireless receivers, the FM systems operate on any crystal-controlled frequency between 150 to 216 MHz, at a range up to 1000 feet or more. Transmit-to-receive frequency response is almost perfectly flat from 100 Hz to 12 kHz with gentle rolloffs to 40 Hz and 15 kHz. Total harmonic distortion is typically 1/2 percent. System dynamic range is 90 dB when "Dynex" (transmit compression and receive expansion) is incorporated, with a resulting low noise floor.

Cetec Vega hand-held wireless microphones are newly redesigned for 20 to 30 percent additional battery life, using a commonly available 9-volt alkaline battery (Duracell recommended). Microphone sensitivity is easily adjustable with an audio

gain control on the bottom, with an adjacent LED indicator to verify optimum setup. Power and audio on/off switches are also conveniently located on the bottom.

Write or call for further information and location of your nearest dealer: Cetec Vega, P.O. Box 5348, El Monte, CA 91731. (213) 442-0782
TWX: 910-587-3539
In Canada: A.C. Simmonds & Sons Ltd.



Cetec Vega

Division of Cetec Corporation



Circle 22 on Reader Service Card

FM multiplex recording on the video track and PCM (digital) recording on a track following the video signal. Considering the sound editing problems in FM recording and the rapid development of PCM recording techniques, the authors conclude that the solution is "most likely to lie with PCM sound recording."

IS IT PCM OR FM FOR BETA-HI-FI?

Armed with that seeming contradiction, I confronted a member of Sony's public relations department and asked him outright if the "secret" audio system devised for what they call the Beta-Hi-Fi VCR is actually FM recording on the video track or is it in fact digital PCM? He assured me that it was an FM system incorporated in the video signal. As further evidence of this, he told me that "internally" everyone was referring to the

Transmission Channels:	2
Sampling Frequency:	31.5 kHz (2 fH)
Frequency Response:	20 Hz-14 kHz
Quantization Bit:	8 bit Linear
Analog Noise Reduction:	> 27 dB
Total Dynamic Range:	> 75 dB
PCM Area:	30° Leasing Portion
Total Bits Per Field:	14.85 Kbit
Transmission Rate:	5.78 Mbit/Sec.
Overhead Redundancy:	43.4%

Figure 4. Specifications for an 8-bit PCM audio recording system.

new audio system as A-FM (for Audio/FM). In any case, he said it would all be disclosed at the next Consumer Electronic Show in January, 1983, in Las Vegas.

Not content with that still-evasive answer, I searched further. The next relevant technical paper I found was in a much more recent IEEE Transactions on Consumer Electronics; this one dated August 1982. This paper was entitled "A New 8-Bit PCM Audio Recording

Technique using an Extension of the Video Track." Surprise of surprises! It was by a group of Sony Engineers. They reported that the audio system of the earlier-announced Video Movie unit was now ready to be modified to a PCM system, thereby enabling the tape speed to be reduced to the previously announced goal of 7 mm/sec—an increase in recording time from 20 minutes to one full hour. To achieve a frequency response extending to beyond 14 kHz

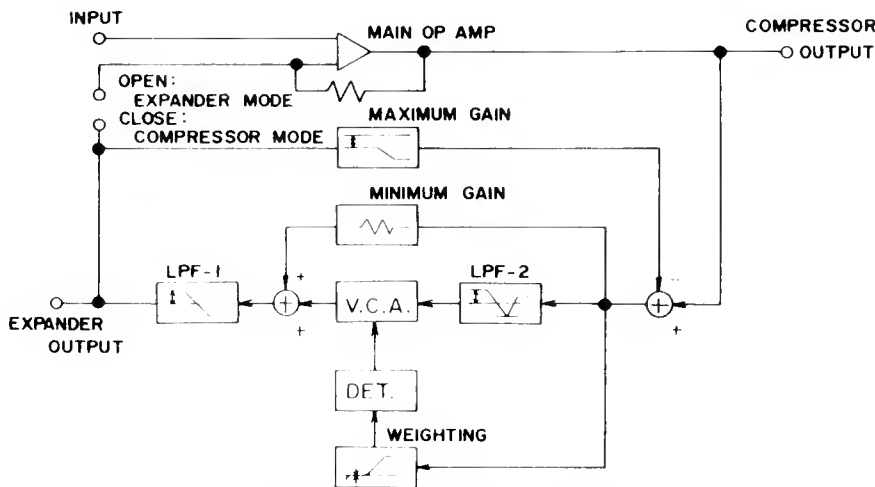
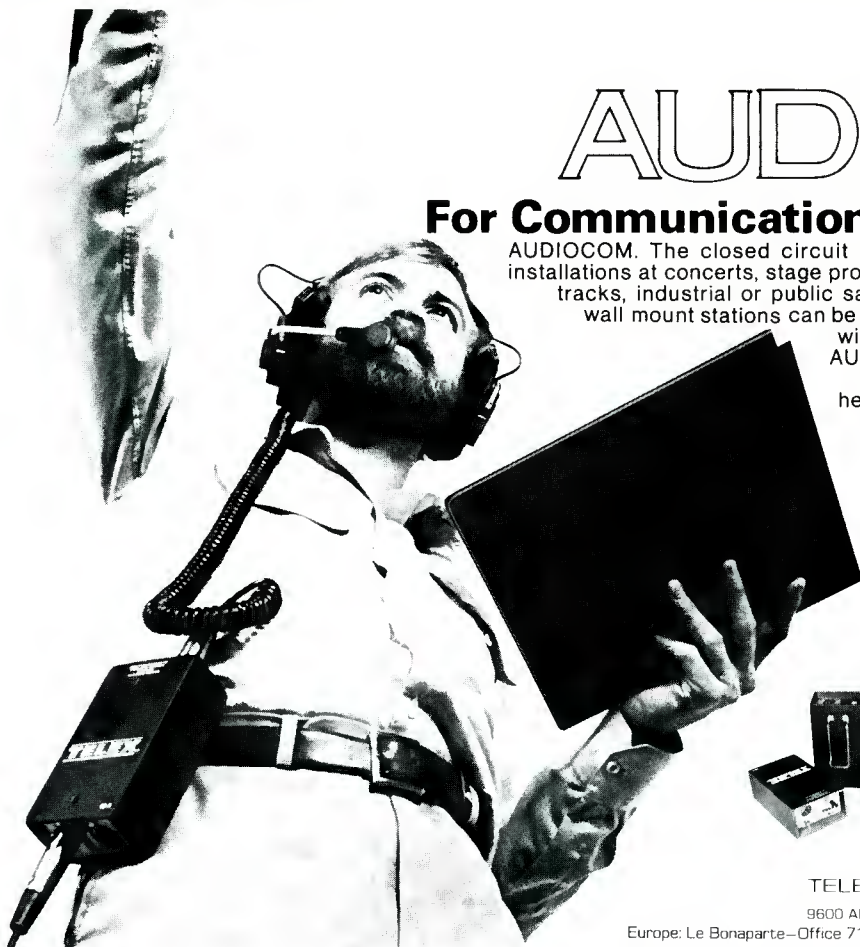

Figure 5. Block diagram of a proposed analog noise reduction system that extends the dynamic range of an 8-bit PCM audio-for-video recording system to 75 dB.

18 db November 1982



TELEX

AUDIOCOM

For Communications Behind The Scene

AUDIOCOM. The closed circuit intercom for small, large, portable or fixed installations at concerts, stage productions, film or TV studios, stadiums or race tracks, industrial or public safety applications. AUDIOCOM belt packs or wall mount stations can be "daisy-chained" by the dozens over five miles without degradation in signal quality or strength. AUDIOCOM interfaces with other sound systems and telephone circuits. AUDIOCOM includes headsets, mics, cables, switchboards, signalling kits, even battery packs for remote locations; the complete intercom system for communications behind the scene.

Quality products for the audio professional.



TELEX

TELEX COMMUNICATIONS, INC.

9600 Aldrich Ave. So., Minneapolis, MN 55420 U.S.A.

Europe: Le Bonaparte—Office 711, Centre Affaires Paris-Nord, 93153 Le Blanc-Mesnil, France.

Circle 23 on Reader Service Card

and a dynamic range of over 75 dB, the wrap angle between drum and tape was increased as shown on FIGURE 3. The resulting additional area (30 degrees of additional wrap on one side of the drum and 5 degrees more wrap on the opposite side) allowed for the recording of a PCM audio signal.

The Table in FIGURE 4 shows the specifications of the PCM audio recording technique used in this proposed Sony camera/VCR combination. Notice that it is an 8-bit linear system. Normally, that would mean a dynamic range of only 48 dB. But since an 8-bit system proved to be very economical and practical for this application, Sony decided to add an

analog noise reduction system. A block diagram of this new proposed analog noise reduction system is shown in FIGURE 5, while a block diagram of the entire recording and playback system is shown in FIGURE 6.

The new analog noise reduction system that makes up the needed difference between 48 dB of dynamic range and the desired 75 dB differs from conventional noise reduction systems in two ways. First, the level and the frequency of the input signal both influence the frequency characteristics of the feedback loops. Sony calls this approach "Dynamic Preemphasis" and they claim that it aids in obtaining noise-modulation-free

playback. Secondly, in the detector of the system, attack time varies with input signal and frequency. It is set to a minimum of 500 μ sec to avoid overshoot and transient distortion. Recovery time is set at 500 μ sec to take into account temporal masking during sudden decreases of input signal. A hold time of 20 μ sec is set to reduce possible low-frequency distortion. The paper goes on to describe a new and very sophisticated type of error-correction scheme which had to be developed for this PCM recording technique.

It was the last sentence of this scholarly paper which left me puzzled. It reads, "We believe that this 8-bit PCM audio recording technique is very suitable for use in future consumer VCRs." That being the case, why is it that the about-to-be announced Beta-Hi-Fi VCR has elected to go with an FM audio signal tacked on to the video signal instead of a PCM signal? Could it be that "above 14 kHz" response was still deemed "not good enough"? And if the new system that is incorporated in the yet-to-be-revealed Beta-stereo unit actually does have response to 20 kHz, surely that's going to have some bearing on professional audio for video, isn't it? Are the days of U-Matic, $\frac{3}{4}$ -inch video for professional use numbered? Stay tuned to this column. As soon as someone gives me the answers to these and other questions, I'll be the first to tell you. ■

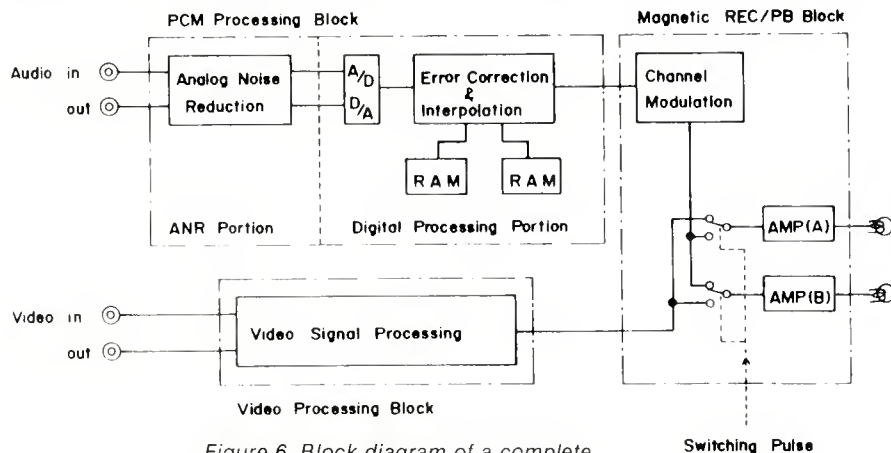

Figure 6. Block diagram of a complete PCM recording and playback system.

10 ways to solve your most common microphone problems.

- Input Overload A15AS Microphone Attenuator—inserts 15, 20 or 25 dB loss to prevent overload.
- Phasing A15PRS Switchable Phase Reverser for balanced lines.
- Low-Frequency Noise A15HP High Pass Filter—reduces low-frequency noise and proximity effect.
- High-Frequency Noise A15LP Low Pass Filter—reduces objectionable high-frequency noise.
- Lack of Presence A15PA Presence Adapter—adds intelligibility and brilliance.
- Excessive Sibilance A15RS Response Shaper—sibilance filtering, plus flattened response.
- Adapting Line Level to Mic Input A15LA Line Input Adapter—converts balanced low-impedance mic input to line level input.
- Matching Bridging/Isolating A15BT Bridging Transformer—matches balanced or unbalanced devices of different impedances.
- Troubleshooting A15TG Tone Generator—700 Hz signal helps check levels, connections, mixer inputs, and cables.
- Microphone Impedance Matching A95 and A97 Series Line Transformers—make it possible to connect low impedance lines to mid and high impedance inputs (or vice-versa).

Shure Brothers Inc., 222 Hartrey Ave., Evanston, IL 60204. (512) 866-2555.

SHURE®

THE SOUND OF THE PROFESSIONALS® ... WORLDWIDE

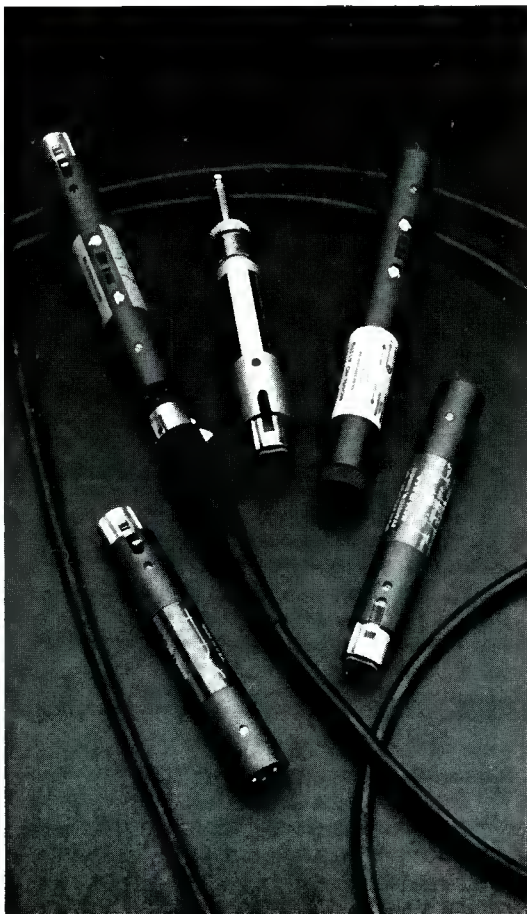

Sound Reinforcement

Sound Fields, Part 2

INTRODUCTION

• Last month we discussed steady-state sound field conditions, both indoors and out, and we also noted the effect which reverberation time has on the intelligibility of speech.

This month we will extend our discussion to include sound fields in relatively absorptive and semi-enclosed spaces. We will also examine the onset of reverberant fields indoors, noting some of the esthetic characteristics of developing sound fields.

ATTENUATION OF SOUND WITH DISTANCE IN HIGHLY ABSORPTIVE SPACES

The statistical model shown in FIGURE 1A, which illustrates sound attenuation with distance, holds only in enclosed spaces low enough in absorption, and high enough in diffusion, so that a uniform reverberant field exists throughout the room. However, when we observe the attenuation of sound with distance in rooms which are highly absorptive, we find that there is additional attenuation with distance beyond the critical distance, indicating that there is not a uniform reverberant field in the room. V. M. A. Peutz (1) studied these phenomena and has arrived at empirical equations describing the attenuation with distance. FIGURE 1B shows the general nature of the slope of the attenuation curve beyond critical distance. In rooms of fairly regular dimensions, the slope of the attenuation curve per doubling of distance beyond critical distance is given by:

$$\Delta \approx \frac{0.4 \sqrt[3]{V}}{T_{60}} \quad (1)$$

where Δ = the level difference in dB, per doubling of distance,
 V = the room volume, in cubic meters,
 T_{60} = the reverberation time, in seconds.

Where the room has a very-low ceiling in relation to its length and width, as in many meetings and assembly spaces, the

following equation is used:

$$\Delta \approx \frac{0.4 \sqrt[3]{V}}{hT_{60}} \quad (2)$$

where h = the height of the room, in meters.

Let us work out examples using each of these equations. A fairly regular room has dimensions of 25, 20, and 15 meters, and a reverberation time of 4.5 seconds. Therefore:

$$\Delta \approx \frac{0.4 \sqrt[3]{7500}}{4.5} \approx \frac{(0.4)(2.7)}{4.5}$$

$$\approx 0.4 \text{ dB.}$$

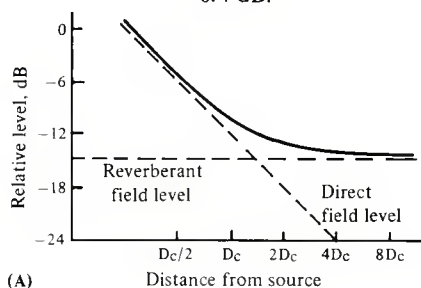

(A)

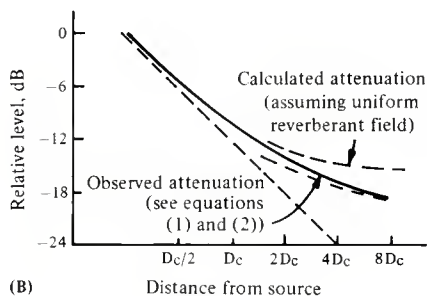

(B)

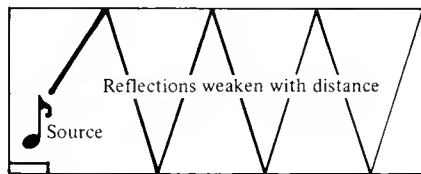

(C)

Figure 1. Attenuation with distance from a sound source indoors. (A) uniform reverberant field, (B) non-uniform reverberant field, (C) sound reflections in a low-ceiling room.

Obviously, with only 0.4 dB loss per doubling of distance beyond critical distance, we would be just as well-off to assume that a constant reverberant field existed in the room. However, if the reverberation time is reduced to say, one second, the corresponding fall-off per doubling of distance beyond critical distance is about 1.8 dB. Again, this is probably negligible in any practical design situation.

Now, moving on to rooms with quite low ceilings, let's assume the following dimensions: 10, 15 and 3 meters, and a reverberation time of one second. Therefore:

$$\Delta \approx \frac{0.4 \sqrt[3]{450}}{3(1)} \approx 2.8 \text{ dB.}$$

The additional fall-off of almost 3 dB per doubling of distance beyond critical distance is significant. What is happening in the space is similar to the situation shown in FIGURE 1C. Because of the large amount of absorption in the room and the relatively low ceiling height, the reflected sound field, as it attempts to stabilize with distance from the source, encounters many floor-to-ceiling reflections. It is thus reduced with distance, and the slope is somewhere between the 6 dB per doubling of distance characteristic of the direct field and the steady value of a uniform reverberant field.

Peutz stresses that his equations are only approximations and that we should not expect them necessarily to describe accurately what we observe in a given room. In particular, the presence of obstacles and large areas of highly absorptive surfaces will influence the slope of the attenuation beyond critical distance, and they may result in considerable fluctuations in the observed attenuation curves.

SOUND FIELDS IN SEMI-ENCLOSED SPACES

During summer months a good deal of music is performed in music tents, sheds and the like, in a variety of music festivals around the country. These performance spaces are often far from dead acoustically, but they usually have very short re-

verberation times. As a rule, there are significant *early reflections*—those that unfold during the first fifty or so milliseconds after the direct sound reaches the listener. These constitute what some acoustical designers call the *early sound field*, and they contribute to overall warmth and intimacy of sound. Studies have shown that early reflections are most effective when they come from the side walls, but in the kind of performance space we are discussing, the majority of these early reflections are apt to come from the stage housing and canopy areas.

FIGURE 2A shows the general distribution of direct, early, and reverberant sound field components as they might be perceived in a concert hall. At B we have shown what may be expected in a semi-enclosed performance environment.

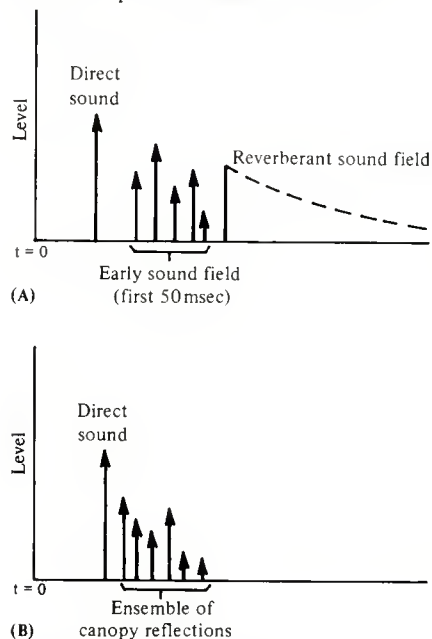

Figure 2. Build-up of early and reverberant fields. (A) in an auditorium, (B) in a semi-enclosed space.

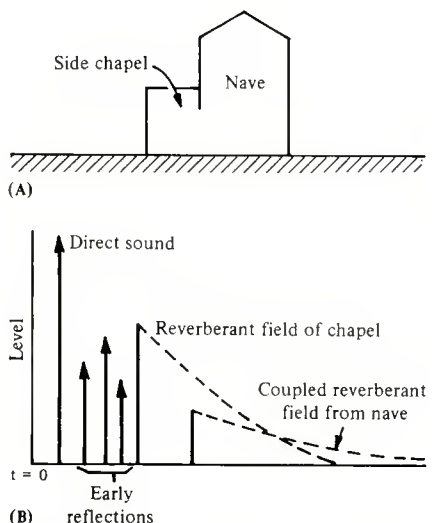

Figure 3. Reverberation in coupled spaces. (A) A large church with connected chapel, (B) sound fields as observed in the chapel.

While the listener misses the aesthetic contribution of a reverberant field, the ensemble of early reflections usually does provide enough loudness so that sound reinforcement is not routinely called for.

Almost the opposite conditions occur when a small space is coupled to a larger, more reverberant space. In many large European cathedrals, small side chapels, with their relatively short reverberation times, are coupled to the main structure, with its reverberation time often upwards of 6 or 7 seconds. FIGURE 3 shows what may happen under such conditions if a performance is taking place in the smaller chapel. The effect is as though another, almost unrelated, performance is taking place in the larger space, while listeners are located in the smaller space. Those readers interested in pursuing the study

of reverberation involving coupled spaces are referred to the excellent paper by Shankland and Shankland analyzing the acoustics of the basilicas of Rome (2).

Next month we will conclude our discussion of sound fields with an examination of some of the synthesis schemes which have been successfully used to simulate early and reverberant sound fields in enclosed spaces. ■

REFERENCES

1. Peutz, V. M. A., "Quasi-steady-state and Decaying Sound Fields," *Ingenieursblad*, vol. 42, no. 18, 16 Sep 1973 (in Dutch).
2. Shankland, R. S. and H. K., "Acoustics of St. Peter's and Patriarchal Basilicas in Rome," *J. Acoustical Society of America*, vol. 50, no. 2, 1971.

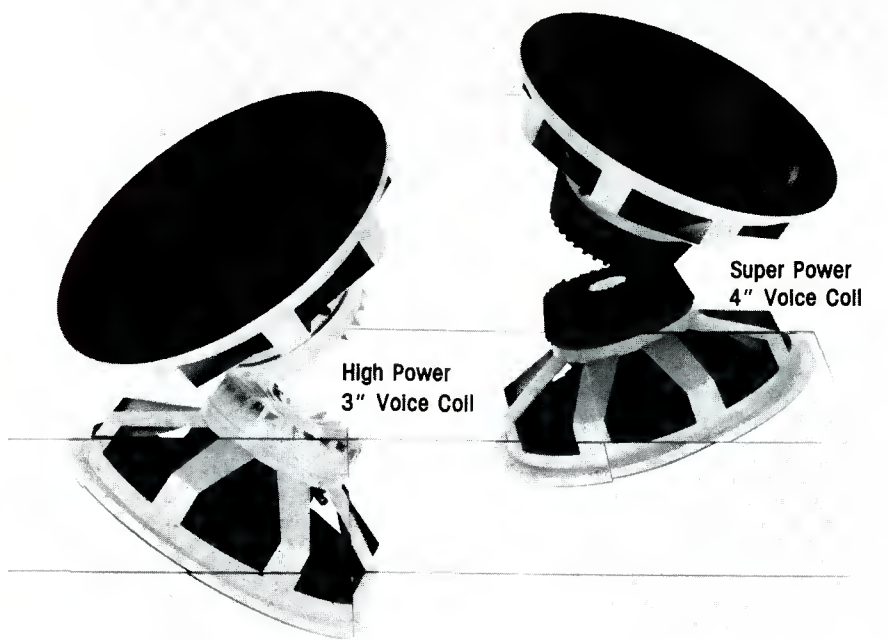

See them. Write for your nearest dealer.

Cetec Gauss
9130 Glenoaks Blvd.
Sun Valley, CA 91352

Circle 25 on Reader Service Card

Theory & Practice

Insomnia Distortion

• It's 3 A.M. and I can't sleep. I've been tossing and turning for 3 hours, but there's no hope. I'll have to try exercise—I get up and turn on my word processor. Its green screen has gotten me through many a bad night.

The evening started out well enough, a light dinner and a concert by the distinguished visiting London Symphony Orchestra playing in an undistinguished, local concert hall. That's where the trouble began: the hall acoustics were lousy. Reverberation was insufficient and acutely bottom-heavy, giving that familiar wooly sound. Clarity was nonexistent, and the orchestral smear syndrome gave rise to nearly impenetrable tonal textures. Balance was out to lunch, and there was no dynamic range, no breadth, no impact—the live concert sounded like a really bad recording broadcast on AM stereo, and decoded by the wrong manufacturer's method.

Don't misunderstand me—the or-

chestra had nothing to do with it. If anything, those musicians should be pitied. It must have been even more exasperating for them. I have, in fact, spoken with conductors who dread performing in this hall. They know that despite their best efforts, the sound reaching the listener's ears will be unflattering. I went home and went to bed.

I awoke in a cold sweat. It was a horrible dream—horrible. I was sitting in this concert hall in the best seat in the house—row 20, center aisle, thirty-five bucks a ticket. I was enjoying the concert, but not really. The sound was marred by improper balance and the strings were covering the woodwinds. The sound was too direct and harsh, with not enough ambient reinforcement. I got up and moved back ten rows. There was more ambience but it was altogether muddy, and the side walls hinted at a slap echo; the balance still wasn't good. I went upstairs to the balcony, first row. The balance was better, but now the percussion (the timpani in particular) had a funny ring to them—could it be those acoustic clouds around the proscenium? I moved back a few rows, and now the low strings had lost most of their bite, and the violins sounded thin. In desperation I climbed to the back of the hall, and now the reverberation was too much. I heard Brahms being played by a hall, not an orchestra. I went back forward, and off to one side to try to get a better violin sound—no good. Then I went downstairs again.

It was a horrible dream. And now in my sleepless state, the discomfort remains. I must ask the question—what *does* an orchestra really sound like? Every seat in every hall is different. What does the LSO really sound like? Does anyone know? Must concert goers accept the fact that the orchestra has many sounds, but no one sound? And how about recording engineers? When we record, and spend all morning arranging and rearranging microphones, and sit up there in a little room all afternoon twisting knobs supposedly locating a realistic sound of an orchestra that a concert goer might realistically hear, what is it that we are really searching for? What does the mind's ear hear? All of those knobs and faders—what are we looking for? Which of those infinite number of seats are we choosing and zeroing in on? Are we finding one, or creating a composite

of several? Does the sound actually exist, or is it a theoretical sound which we create especially for recordings? What is our reference? Should we treat an orchestra like a loudspeaker and test it in an anechoic chamber, or fly it in free field, or carry it out into a pasture, dig a hole, and bury it flush with the ground?

Sure—everyone knows through general consensus what an orchestra sounds like, but I'm a recording engineer and I have to know better than anybody else what every orchestra I record, in every hall I record in, sounds like. I have to know when my end product is an accurate documentation of a specific orchestra in a specific hall. Moreover, I have to try (impossibly) to make the recorded orchestra sound better than the real orchestra to somehow fudge against the inherent deficiencies in a recording. But what *does* an orchestra sound like in the first place? I mean, does anyone really know? Or is all that microphone hanging, knob twisting, and button pushing just some kind of joke—like a couple who can't decide to put the new sofa—and eventually the damn thing stays where it happened to be when they got tired of moving it. If we don't know what sound we are going after, then we don't know what we are doing.

Okay, let's try to get to high ground. First, understand that our answers here cannot be totally logical. That's why computers won't soon completely replace us. If there was a definitive orchestral sound, we could input that into the computer, hang microphones, let the orchestra rehearse and let the computer mix until it matched the reference, and then make the recording. But because there is no reference, it isn't that easy. Recording is an intuitive creative process; engineers are safe for at least another ten years.

Some of the problem *can* be empirically approached. The first step in that direction is to eliminate as many unknown variables as possible. Let's get rid of the concert hall immediately, and consider only the direct orchestral sound as it travels towards us. Even that small aspect of the problem isn't so easy. Consider, for example, the simple fact that sound is generated at a source, and must travel through air to reach our ears. That transmission alone introduces distortion and there's no way around it. Without air as a transmission medium the acous-



T112 Telephone to Studio Equalizer / Coupler

Get the maximum in fidelity performance with the T112 as your interface between the phone line and your studio. Or use it as an in-line equalizer amp between the broadcast loop and your studio. Either way, it greatly improves the on-air sound of remotes. Even at a low cost, you enjoy quality features: 3 band equalization to pep up frequency response, 2 adjustable 600 Ohm balanced outputs, 60 Hz notch filter, headphone amp & More! Get our catalog sheet today!

RUSSCO
ELECTRONICS INCORPORATED

5690 E. Shields Ave., Fresno Calif.
Zip 93727 • Phone (209) 291-5591

Circle 26 on Reader Service Card

tic event could never have taken place. We need air, but unfortunately air affects sound transmission nonlinearly.

All acoustic energy is ultimately dissipated in heat energy either at the enclosing boundaries, or in the medium itself. Obviously, in free field, or in a totally live room, all the energy is absorbed by the medium. Losses in the medium occur as viscous, heat conduction, and molecular exchange losses. Those losses are an integral part of the nature of sound transmission itself. For example, transmission is comprised of alternate compressions and rarefactions of the air pressure, that is, varying molecular density. Those pressure changes also produce alternate temperature changes since the process is adiabatic. Thus heat transfer takes place from compressed areas (high temperature) to rarefacted areas (lower temperature). This heat transfer acts to equalize pressure, and there is an amplitude loss as the sound propagates through the medium. Through similar mechanisms, even theoretically perfect acoustic transmission is inherently a lossy process.

As if theoretically perfect air wasn't bad enough, atmospheric air is a lot worse, primarily because of the presence of water-vapor molecules—humidity. This causes excess absorption, which for audio frequencies is especially critical at high temperatures and low humidity. Under most acoustic conditions, oxygen molecules exist in an unexcited vibrational mode. The relaxation time for the mode is several seconds. Thus they are not excited by audio waves. Water vapor molecules reduce the relaxation time to around 10^{-5} second because they apparently reduce the number of molecular collisions required to excite the mode. This shorter relaxation time means that audio waves can trigger the vibrational mode, and that yields a large excess attenuation. The phenomenon seems to be similar to the mechanism in Helmholtz resonators. As we might expect, the longer the path length, the greater the attenuation. The magnitude of attenuation is independent of percentage humidity but the frequency of maximum attenuation is approximately a quadratic function of humidity. For example, a humidity of 11 percent gives a maximum attenuation at 3 kHz, and 14 percent most attenuates at 6 kHz. Fortunately for us south Floridians, at humidity of 50 percent or greater, the effect climbs to the lower ultrasonic range. Still, it is another example of how air both creates an acoustic event and distorts it. In fact, even in simple, first-approximation equations concerning an acoustic event, we must take air absorption into account. For example, the Sabine reverberation equation, $T = 0.049V/A$ must be modified to $T = 0.049V/(A + 4mV)$, where m is the attenuation constant in ft^{-1} , an absorption fudge factor. As we might expect, the attenuation is nonlinear: the

constant m , and air absorption, increase with higher frequency.

And as if absorption wasn't enough, other kinds of more literal distortion take place in air. Let's look at the simple example of a typical diverging wave. In free space its sound pressure varies inversely with distance (yet another cruel twist to our paradox). Experiments show that the ratio of second-harmonic pressure to the fundamental pressure at a distance r centimeters from a spherical radiator of radius r_1 is:

$$\frac{P_2}{P_1} = \frac{(\gamma + 1)\omega p_1 r}{2\sqrt{2}\gamma p_0 c r_1} \ln \frac{r}{r_1}$$

- where P_1 = the fundamental sound pressure at a distance r (dynes/cm²),
- P_2 = the second-harmonic sound pressure at a distance r (dynes/cm²),
- p_0 = the atmospheric pressure (dynes/cm²),
- p_1 = the pressure at the listening point (dynes/cm²),
- γ = the ratio of specific heats (1.4 in air),
- $\omega = 2\pi(f = \text{frequency, in Hz})$,
- c = the velocity of sound (cm/sec),
- r = the distance from the radiator (cm),
- r_1 = the radius of the spherical radiator (cm).

Distortion can be calculated by using this information. (It can also help put you to sleep.) For example, using a direct-radiator loudspeaker, which produces a diverging wave as our model, the expression for the second-harmonic distortion in percent generated between a cone of radius r_1 and a listening point at a distance r is:

$$D = \frac{(\gamma + 1)\omega p_1 r}{2\sqrt{2}\gamma p_0 c} \left(0.85r + \frac{r}{r_1} \ln \frac{r}{r_1} \right) 100$$

How important is this distortion? Some actual numbers are not encouraging. For example, given a cone of 10 centimeters radius, at a distance of 3 meters with a frequency of 4 kHz, the distortion is 0.02 percent at 75 dB SPL, 0.1 percent at 88 dB SPL, and 0.8 percent at 107 dB SPL. That's not speaker distortion—it's interface distortion between the source and our ears; it's air distortion.

It's enough to make an audiophile cry in pain. And the sound of an orchestra? A hundred musicians at distances varying up to several hundred feet from the listener, playing in an unfortunately-dehumidified and slightly-warm atmosphere assembled and transmitting their combined efforts in that huge concert-hall air volume—it must be pure distortion. If we somehow took away all that air, to remove all that distortion, and listened to the orchestra directly, would the audiophile now cry in ecstasy? Well,

not exactly. We've gotten used to it; distortion is a natural part of everything we hear, and an orchestra just wouldn't sound the same without it. Besides, have you ever tried to cry in a vacuum?

It's 5 A.M. and I don't have enough energy to continue my sleeplessness any further into the areas of room acoustics, articulation and intelligibility, resonance and standing waves, modes, nodes, and antinodes. Our attempt to discover an orchestra's true sound through empirical analysis is probably doomed to failure anyway. There is only time for a simple thought. Plato fought the same representational battle we just did. He wondered: when we see a chair, how do we recognize it as a chair, and why are all different kinds of horses still identifiably horses, and how do we know the sound of a lyre? His answer was the Forms. He proposed that there exist in our minds ideal, perfect ideas of all things—and using those references, we can always identify the imperfect, approximate things around us. Maybe that's why each of us knows what an orchestra should sound like; there exists a perfect idea of an orchestra which we strive for when we record. Or perhaps all of you smart recording engineers out there have better ideas. In that case, send to me, care of **db** magazine, your answers, recorded, written or otherwise, to the question—What does sound *really* sound like anyway? I'll award two sleeping tablets to whomever loses the most sleep over it. ■

LOW LEVEL INPUT TRANSFORMERS

For Microphones/Transducers



Control and Instrument Amplifier Applications
Excellent magnetic ESS shielding
Response 30-20 KHz +1db
Turns Ratio 1:1 thru 1:20

Single Threaded Stud Mounting

MICROTRAN S101-SP

Equivalent to Imported European Studio Grade Transformers



COMPLETE SPECIFICATIONS AND PRICE SHEET AVAILABLE

Complete Catalog line of

AUDIO-POWER COMMERCIAL-MIL TRANSFORMERS



IMMEDIATE DELIVERY FROM DISTRIBUTORS

IMMEDIATE DELIVERY FROM DISTRIBUTORS



MICROTRAN COMPANY, INC.

145 E. Mineola Ave., Box 236, Valley Stream, N.Y. 11582

Circle 27 on Reader Service Card

That Ubiquitous Chip

HOME AGAIN! We've just gotten back from the Audio Engineering and Microprocessor Society Convention in Anaheim, California. Well, that's not *exactly* what they called it, but that's the way it looked to us. Even the damned hotel is run by a chip, as we found out while looking for our room, which was number 2847.

Due no doubt to a logic fault in our cerebral processor-based system, we assumed we would be on the 28th floor. However, this did not compute, since the hotel had less than half that number of floors. The bellman was amused by our naivete. "It's simple—just add the first two digits to find your floor." We quickly reached for our microprocessor-based programmable calculator, and entered 2, 8, +. Aha! The room was on the 10th floor.

Sure enough, there it was, right between 2846 and 2848, on the tenth floor. Just where the computer would expect to find it. What could be simpler?

Well how about calling it 1047? The bellman was beginning to get impatient. "Of course, that's quite impossible Sir. The computer needs a four-digit number, and with your system, rooms on the first nine floors could not be handled properly."

Of course. We should have known better, and made a mental note to never again trust a hotel room with only three digits. After all, this is a world of microprocessors, and we may as well get used to it right now. (Still, 1047 would have been rather comfy, especially after visiting some of those hospitality suites, when it took a bit of effort to remember the code.)

Fortunately, the audio industry seems to have a better handle on using the chip than does the hotel industry. Most of the microprocessor-based hardware seen here appears to require *less*, rather than more, effort to operate, once the operator has done a minimal amount of homework in chip-think.

For instance, there's really no need to have a field of knobs and switches stretching off into the horizon, when you're probably only going to be operating on one or two at a time. With a little clever programming (all right, with a *lot* of clever programming), a handful of knobs can be trained to do the work of many. If you want to raise the high end, just turn the knob. If you want to

change to compression ratio, the same knob will do it. All you have to do is tell the machine what you want. No, don't talk to it, but do look for a readout that says "Equalizer." There's probably a button nearby that may be unmarked. Oh go ahead—push it. Does the readout now say "Compressor"? (See? You're learning, and *without* an instruction manual.)

OK, OK—so we didn't really see a black box with an equalizer/compressor switch on it. Not yet. But we will soon. After all, it's just a matter of programming.

What we did see was impressive enough, and doubly so when we consider the generally pessimistic things we read about the economy. But can the industry really afford all this fancy stuff? In many cases, the answer is YES. In the first place, it's not all that expensive. (Yes, we know about 24-track digital price tags, but there's a lot of other stuff out there that's more within reach.)

Also working on behalf of the microprocessor is the fact that it has a delightful habit of taking over lots of the very-dull-and-tedious chores, freeing the user for more interesting things. Why, even the drudgery of writing profound editorials has been relieved a bit by the chip. This little message is being brought to you (if you're still with us) via an IBM personal computer, just like the one that we saw running an automation storage system at the show. How did we get by for so many years without it?

Apparently, similar thoughts must have been running through quite a few minds at the convention. As noted in our Convention Report, the mood was optimistic, and the exhibitors were complaining mostly about the lack of fast-food service, instead of about everything else, as is the usual custom.

Feeling sorry for one of our exhibitor friends, we invited him to join us for a leisurely lunch at a nearby restaurant. To which he cordially responded, "What are you, crazy? You want me to miss something?"

We beat a hasty retreat, to let our friend get back to business. As we parted, we couldn't help noting the look of inner peace on his face. It's a look that comes from fasting, and from knowing you're going to have to call the office for more order forms. We grabbed a candy bar. Lunch can wait till we get home. JMW

MICROPHONES!

At long last, all the questions you ever asked...all the problems you ever grappled with...are answered clearly and definitively!

The Microphone Handbook

In 256 fact-filled pages, liberally sprinkled with over 500 illuminating photographs, drawings and diagrams, John Eargle covers virtually every practical aspect of microphone design and usage.

Completely up to date, this vital new handbook is a must for any professional whose work involves microphones. Here are just a few of the topics that are thoroughly covered:

- Directional characteristics—the basic patterns.
- Using patterns effectively.
- Microphone sensitivity ratings.
- Remote powering of capacitors.
- Proximity and distance effects.
- Multi-microphone interference problems.
- Stereo microphone techniques.
- Speech and music reinforcement.
- Studio microphone techniques.
- Microphone accessories.
- And much, much more!

THE MICROPHONE HANDBOOK. You'll find yourself reaching for it every time a new or unusual problem crops up. Order your copy now!

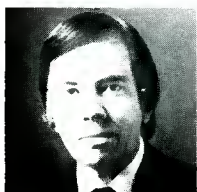

JOHN EARGLE,

noted author, lecturer and audio expert, is vice-president, market planning for James B. Lansing Sound. He has also served as chief engineer with Mercury Records, and is a member of SMPTE, IEEE and AES, for which he served as president in 1974-75. Listed in *Engineers of Distinction*, he has over 30 published articles and record reviews to his credit, and is the author of another important book, *Sound Recording*.

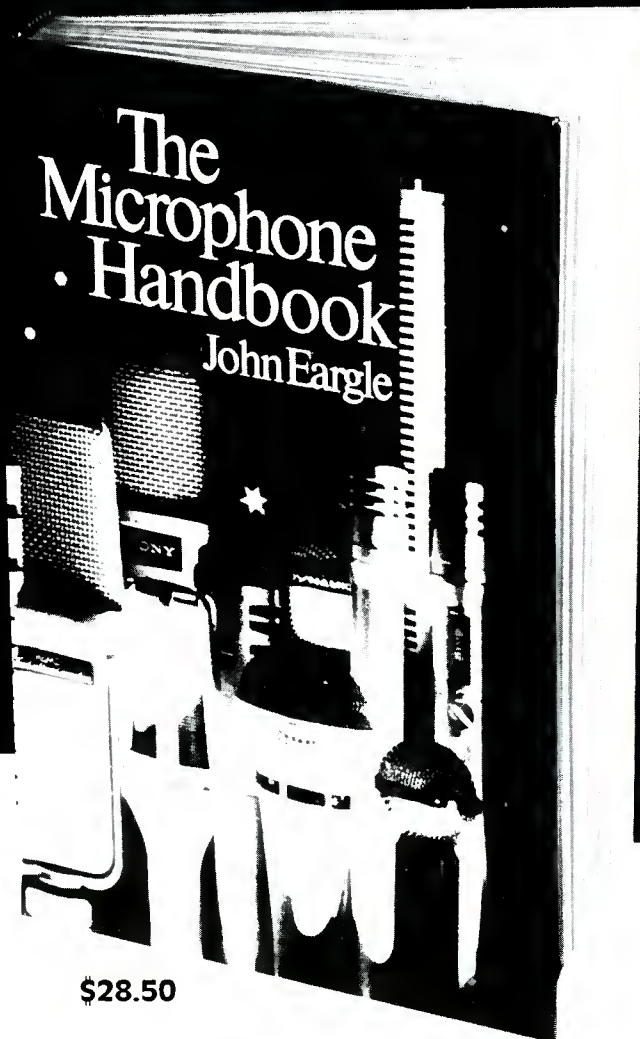

\$28.50

ELAR PUBLISHING CO., INC.

1120 Old Country Road, Plainview, NY 11803

Yes! Please send copies of **The Microphone Handbook** (\$28.50 per copy. (New York State residents add appropriate sales tax.)

Payment enclosed.

Or charge my MasterCard Visa

Acct. # _____ Exp. Date _____

Name _____
(please print)

Address _____

City _____

State/Zip _____

Signature _____

Outside U.S.A. add \$2.00 for postage. Checks must be in U.S. funds drawn on a U.S. bank.

If you aren't completely satisfied, you may return your copy in good condition within 15 days for full refund or credit.

Studio Powering and Grounding Techniques

Possibly the least understood problem encountered during the construction of a studio is the powering and grounding of the equipment.

WHILE THE ARTS of acoustics, monitoring, and equipment design have been studied extensively, it seems that studio powering and grounding has been left to the "Black Arts" category.

The technological advances in equipment interconnect design that have been made during the past few years suggest that it's about time to remove grounding lore from the magical mystery regions and bring it out into the daylight. To this end, the following covers some basic powering and grounding practices, which have been applied with success in every instance. No degree in mathematics or electrical engineering will be required to follow the guidelines and procedures outlined here.

THE AC LINE

Hum, buzz, and many of the RF problems in a studio installation start with the AC mains and their relation to ground. The AC power wiring, light fixtures, power cords, and virtually every piece of equipment in the studio projects an electrostatic and an electromagnetic field which may be picked up by every audio wire and circuit in the studio. Additionally, the AC mains are a carrier of many forms of radio-frequency interference (RFI) generated by electric motors, SCR dimmers, medical equipment, computers, and a host of other appliances in day-to-day use. To minimize the effect of these fields on the

audio installation, careful, thoughtful design, implemented with extensive quality control of the actual electrical work, is essential.

The first step to proper AC power is: Isolate the studio from the power company, and from all general-purpose electrical wiring in the building. The simplest way to accomplish this isolation is to ask the power company to provide a separate power transformer and electrical service from their service pole.

The smaller studio in its own building will probably not have any problem with this request. However, in some areas and in large buildings, it may not be possible. If the power company cannot provide a separate power entry, then you must obtain an isolation transformer. The isolation transformer must be equipped with a wire-mesh Faraday shield which connects to the ground side.

In the United States, power lines are available in many formats. The most prevalent are: 110-VAC single phase, 240-VAC single phase, 240-VAC single phase center-ground (actually, two 120-VAC lines of opposite phase), and three-phase. (See FIGURE 1.)

Three-phase power entries are found in larger buildings where more than 50 kw of service is required. Use of a three-phase entry for audio power should be avoided, as it is usually used for air conditioning and other heavy power equipment.

Under 50 kw, 240-VAC single phase with center ground is usually used. All equipment should be connected to one side of this type of AC power. Use the other side for lighting, office equipment, etc. Alternatively, the best method is to obtain a 240-VAC primary/120-VAC secondary transformer.

Always use a Single Phase of Power for the Control Room.

A piece of electronic equipment with a power transformer will still have a small capacitive coupling between the case and the AC line. If connected to another piece of equipment running on a different phase of the power line, an electric current will flow through the ground between the two pieces of equipment. (See FIGURE 2.)

When wiring the control room, be sure that all outlets are wired to the same phase of the AC line. The best way to be sure of this is to order a single-phase output winding on the isolation transformer. By having all equipment connected to the same phase, you will minimize the amount of 60 Hz leakage current flowing between pieces of equipment.

Keep those "clean" circuits clean.

Do not use the studio mains power for any purpose other than powering audio equipment. Never power fluorescent lights, fans, SCR dimmers, or Coke machines on the studio power.

If requirements to run refreshment equipment or game-room equipment exist, run a separate circuit on a different service entrance, or at least use a different phase of the mains than the control room is using.

Shield all AC Power Wires in Conduit and Isolate them from the Audio Wiring.

Locate your master power panel and the entrance power circuit at least 30 feet from the console and other electronics, particularly tape machines. Avoid running conduit or AC power in troughs with audio wiring, under the console, etc. Remember, AC wires radiate magnetic fields which decrease in intensity with the square of the distance from the equipment. This means that if you double the distance, you will have one-fourth the AC hum problem.

Always Use a Separate Ground Wire for Third-pin Ground.

Many studio installations have the third pin of all the power cords cut off. This is unsafe and unnecessary. Always run a separate insulated #14 or #16 ground wire to each outlet's third pin. Use receptacles having an isolated third pin, such as Hubble IG5362 or General Electric GE8300-IG (for 110 VAC, U.S.).

If you use Wiremold strips, purchase the type which use a separate third-pin ground wire and not a grounding prong to case on the back of each socket. Or, clip the case grounding prong off the back of each socket, and then run the third wire (green) of the strip to your system ground plate, and tie the outer metal case to the conduit. The Plugmold

POWER LINE PHASES

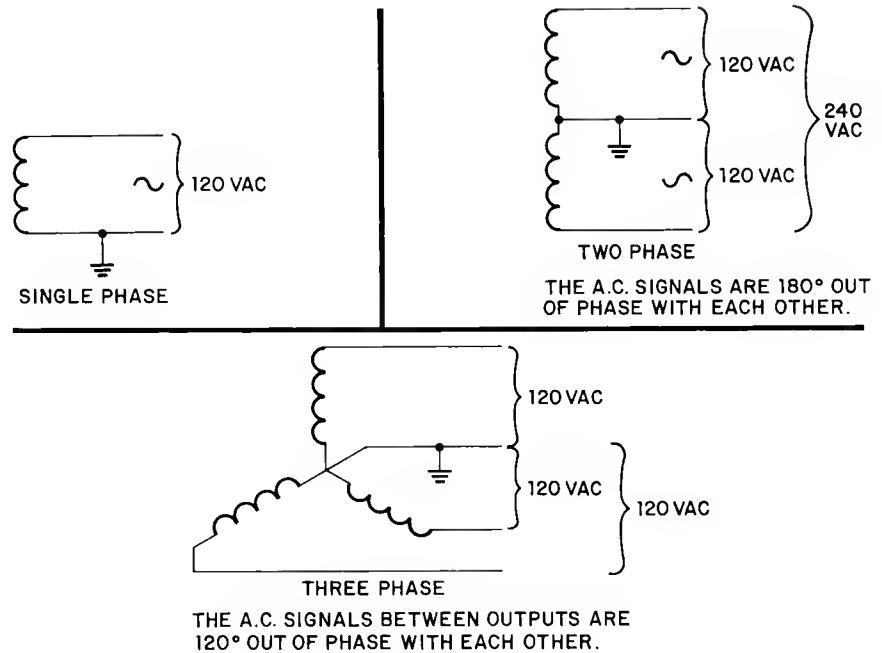

FIGURE 1

A.C. LEAKAGE

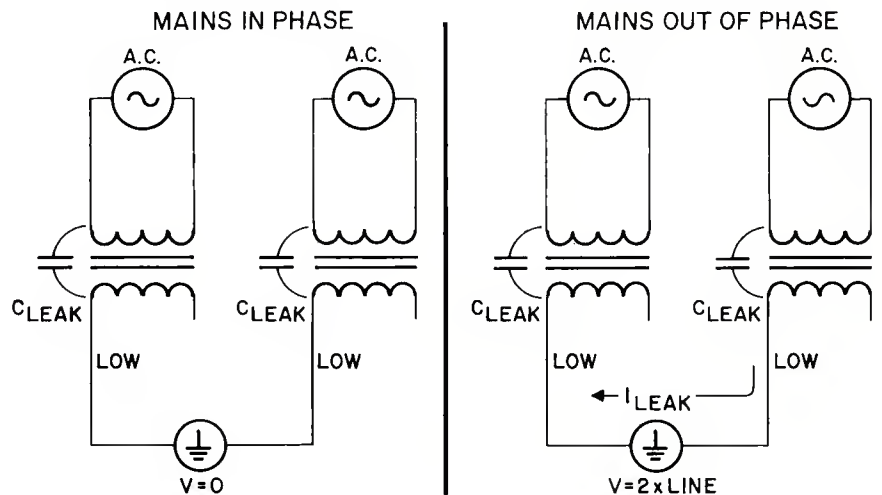
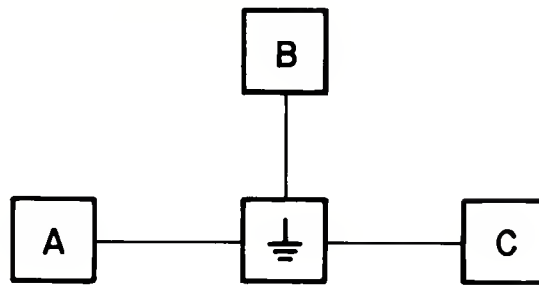
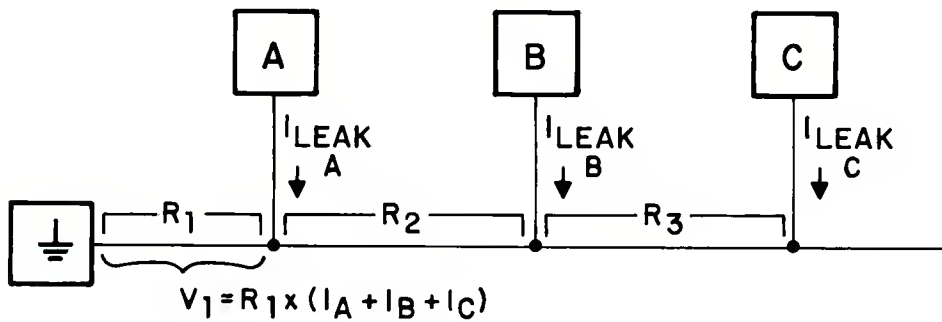

FIGURE 2

STAR VS. SERIES GROUNDING



GOOD - STAR GROUND



BAD - SERIES GROUND

FIGURE 3

SYSTEM GROUND

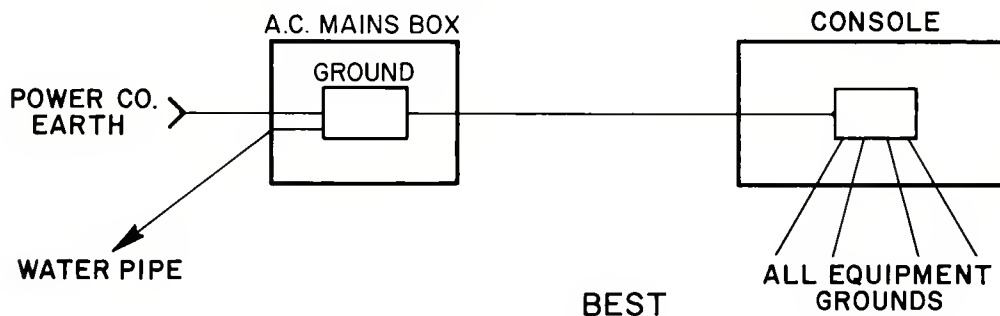
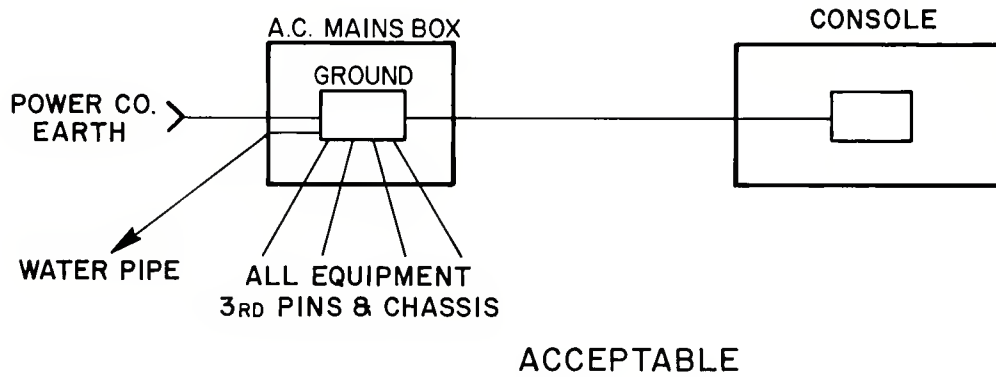

FIGURE 4

"Untwisting all the chains that tie the hidden soul of harmony."

Milton, 1608-1674.

Knowledge is the key to unequalled audio equalisation — and Klark-Teknik's DN60 Audio Spectrum Analyser is a rack-mounted, laboratory standard instrument that provides instantly usable information for an enormous range of applications. With continuous measurement and display of signal levels at 30 points across a broad audio spectrum from 25Hz to 20KHz, this cost-effective microprocessor-based analyser adds new standards of accuracy to the audio professional's vocabulary.

For easy equalisation, the 30 measurement frequencies of the DN60 exactly match the control frequencies of our latest two-channel DN30/30 equaliser. Add the inexpensive RT60 Reverberation Analyser to untangle structural reflections. Result: exact knowledge permits exact adjustment of response levels for total control of sound consistency. DN60 has got the features you need, because it is:

The most powerful audio-analyser on the market today — and because it is microprocessor-based, not only accurately monitoring the full audio band from 25Hz to 20KHz but also offering three memories plus a peak hold memory.

Options include X/Y plotter, dot matrix printer, the matched RT60 Reverberation Decay Analyser and a calibrated measuring microphone.

It is a tough but compact rack-mounted instrument with easy operation and superb 'lights-out' readability, and it is tested rigorously to Klark-Teknik's usual high standards, with a long burn-in period to ensure maximum reliability on the road and in the studio.

ALL THESE USES!

- Tape recorder alignment
- Room acoustical analysis
- Microphone/loudspeaker design and testing
- Reverberation checks
- Continuous system quality control
- Audio components research and development
- Fast semi-automatic production testing
- Selective noise level checks and environmental analysis
- Quality assurance for VTR audio channels
- Broadcast programme quality monitoring
- Music content analysis and level monitoring
- Level optimisation in disc cutting

For technical details ask for: Our DN60/RT60 Data Sheet. Our DN30/30 Data Sheet.



KLARK TEKNIK
sound science

Klark-Teknik Electronics Inc.

262a Eastern Parkway, Farmingdale, NY 11735, USA.
Telephone: (516) 249-3660

Omnimedia Corporation Limited

9653 Côte de Liesse/Dorval, Quebec H9P 1A3, Canada.
Telephone: (514) 636 9971

Manufactured by Klark-Teknik Research Limited, England.
Circle 28 on Reader Service Card

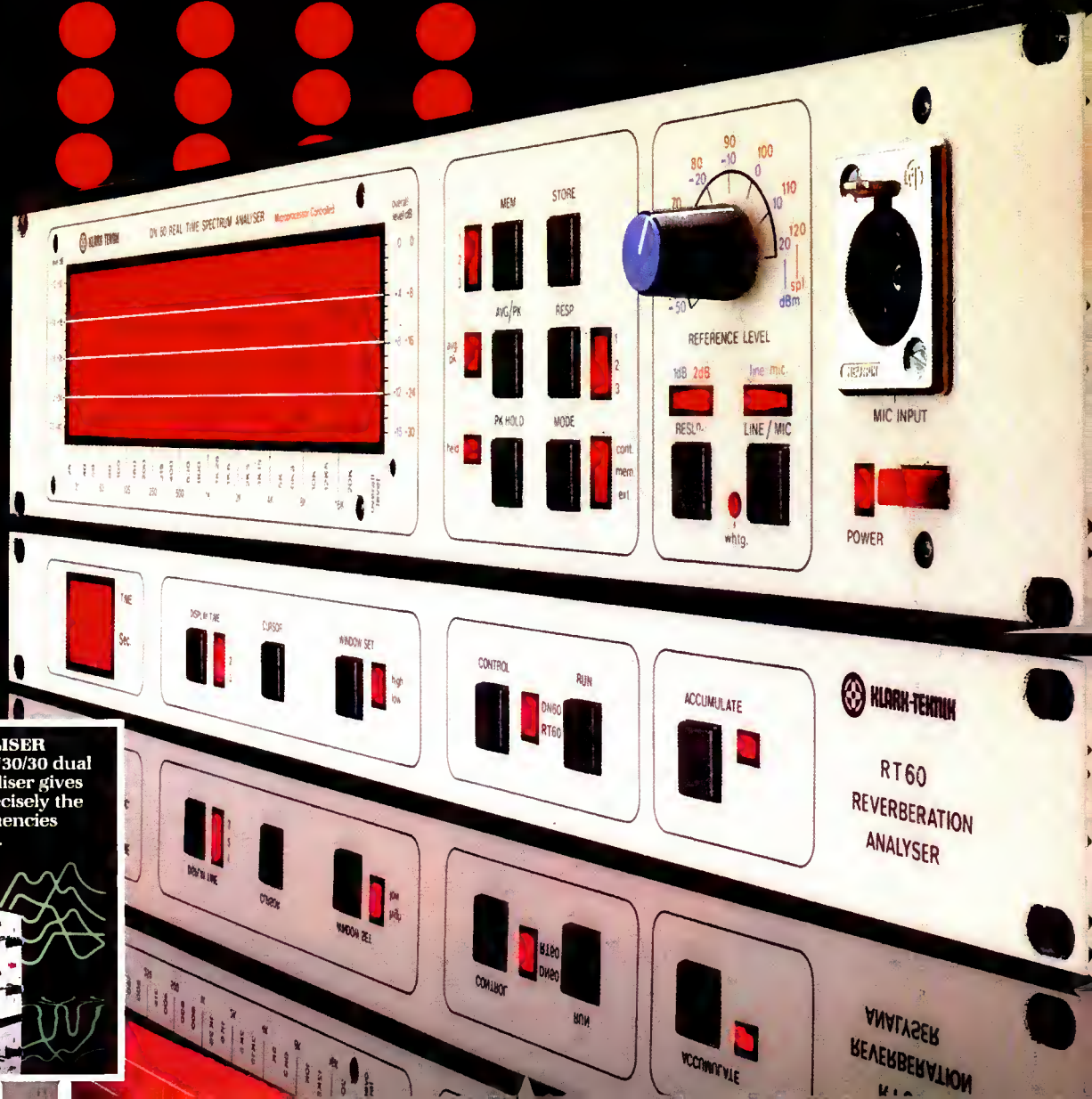

THE PERFECT EQUALISER
Klark-Teknik's new DN30/30 dual channel Graphic Equaliser gives fingertip control at precisely the 30 measurement frequencies displayed on the DN60.

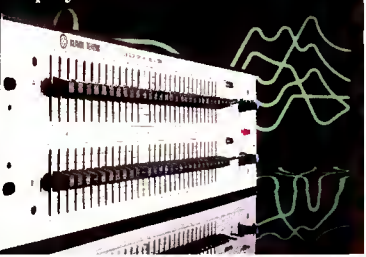

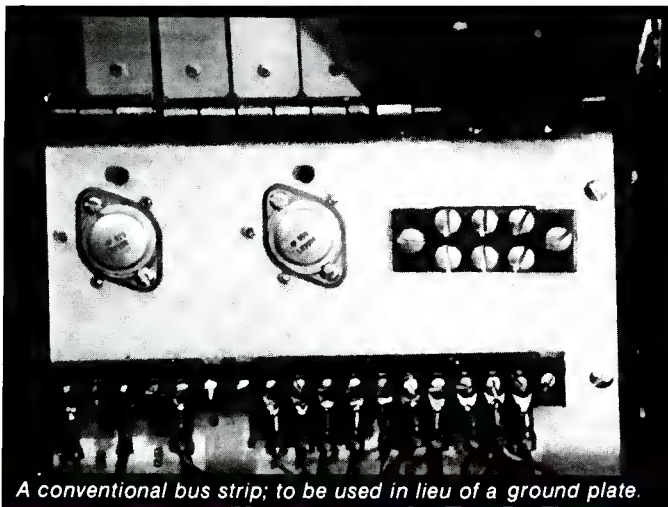

A conventional bus strip; to be used in lieu of a ground plate.



With an API totally modular console by Datatronix, you have unlimited flexibility in size and function. Each console is custom designed . . . each component individually selected by you. After all, the choice is yours . . . you design the console to fit your needs today and tomorrow. □ For

With an API modular console, the choice is yours.

example, you can choose from five different, interchangeable, plug-in EQ modules and an array of input and auxiliary modules—all assembled into a mainframe designed to your requirements. As your needs change, so can the modular components. Plus . . . each console may be prewired for expansion, so that you can easily expand your capability at minimum cost! □ The API console by Datatronix offers you the quality of sound, performance, and flexibility you demand as a professional recording engineer. So call us today . . . and remember the choice is yours.

Performance you can count on

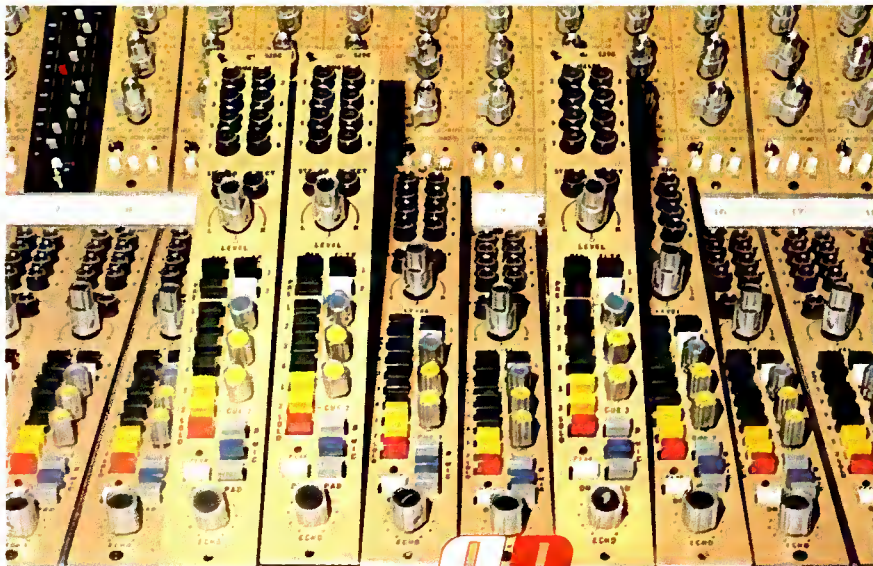

DATATRONIX INC

A subsidiary of ATLANTIC RESEARCH CORPORATION

2100 Reston Ave., Reston, VA 22091 (703) 620-5300 TWX 710 833 0365

product line features an insulated/isolated "pure ground" series which have the key letters "IG" in their part number. These are designed to reduce electromagnetic interference in sensitive equipment.

Always use "Star" Grounding.

Each third-pin ground should return directly back to the ground plate, discussed later in this article. Always use "Star" wiring, wherein each outlet has its own wire back to the ground plate, rather than daisy-chain wiring. In the ideal ground system, no piece of equipment will share a reference wire with any other piece of equipment. (See FIGURE 3.)

Never let the third-pin ground short to the conduit as this will always produce a ground loop. Electricians allow conduits to touch each other, touch water pipes and interconnect; conduit is not a useable ground for audio work.

When the studio wiring is being installed, have all third-pin grounds left unconnected at the ground plate. Then, after the wiring is run, each receptacle can have its third pin checked with an ohmmeter to verify isolation from the conduit. Then, connect the third pins and check again—this time to verify a good ground.

GROUNDING

On the subject of grounds, several key points must be understood.

What is Earth? Earth is correctly used to describe the power company ground. The heavy ground wire brought into the breaker box and grounded to its ground plate is "Earth." This should be the only interconnect to the world outside the studio. Frequently, a ground rod and/or water-pipe ground is tied at this same point. In most communities, the water-pipe ground is a legal requirement.

What is Ground? Ground is a relative term; it's the name we give to the point we want to call the zero-signal reference. But it is the zero-signal reference only if every piece of equipment ties in at this point, and there is no voltage drop (that is, no current flow) in the wire tying the equipment to the reference. There must be one, and only one, ground point in the entire studio complex. It is to this point that all third-pin grounds, case grounds, etc. should tie—like the spokes of a bicycle wheel.

Ground should tie to Earth by one interconnect from the zero-signal reference node to the power company ground. This should be a heavy stranded wire, #2 or larger.

The best point in the control room to make the zero-signal reference is a ground lug on the mixing console. MCI/Sony recording consoles, as well as many others, have such a ground plate. If such a ground plate is not available or inadequate, use a conventional bus strip available at any electrical supply house. (See FIGURE 5.)

Alternatively, the ground plate in the fuse box can be used and a single heavy



SONEX

FOR CLEAN SOUND

After WLEE installed SONEX, people called about the "clean, new sound!" Was it new equipment?

No. The answer is simple and inexpensive:

SONEX kills all the stray reflections, so the mike processes a clean signal of the announcer's voice. The announcer hears himself in a warm environment, and there's

less clutter to waste watts. The result is a noiseless, clear signal and greater market penetration.

Get the facts today. SONEX is available in five colors, in three thicknesses, and in standard four-ft. square panels. Use it in broadcasting, recording, videotaping or performing areas for really pure, clean sound.

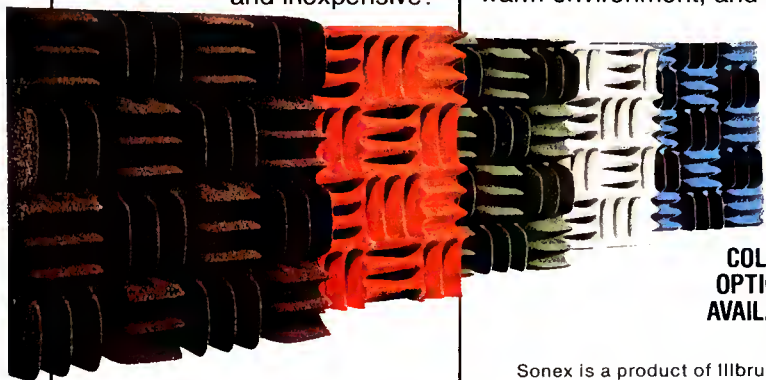

**COLOR
OPTIONS
AVAILABLE**

Sonex is a product of Illbruck/USA

**Alpha
Audio**

2049 West Broad Street
Richmond, Virginia 23220 (804) 358-3852
Acoustic Products for the Audio Industry

Circle 29 on Reader Service Card



Only technology this advanced can achieve music reproduction this pure. The Technics Digital Cassette Recorder.

No tape hiss. No wow and flutter. Not even head contact distortion. With the digital technology in the Technics SV-P100 Cassette Recorder, they no longer exist.

Utilizing the Pulse Code Modulation (PCM) digital process, the SV-P100 instantaneously translates musical notes into an exact numerical code, stores them on any standard VHS cassette, then "translates" them back into music on playback. Duplicate tapes are exactly the same as the original. Thus, every recording and every copy is a "master."

The revolutionary size of the Technics SV-P100 Cassette Recorder (17" x 11" x 10") is the result of state-of-the-art semiconductor technology. The built-in videotape transport mechanism brings the convenience normally associated with conventional front-loading cassette decks to a digital application. Tape loading is

completely automatic. And, frequently used controls are conveniently grouped on a slanted panel with LED's to confirm operating status.

Despite its compact size, the SV-P100 Recorder offers performance beyond even professional open-reel decks. Since the digital signal is recorded on the video track, the space usually available for audio can therefore be used for editing "jump" and "search" marks. The unit employs the EIAJ standard for PCM recording. And, in addition, editing and purely digital dubbing are easily accomplished with any videotape deck employing the NTSC format.

The Technics SV-P100 Digital Cassette Recorder is currently available at selected audio dealers. To say that it must be heard to be appreciated is an incredible understatement.

Technics
The science of sound.

Circle 32 on Reader Service Card

PROPER EQUIPMENT GROUNDING

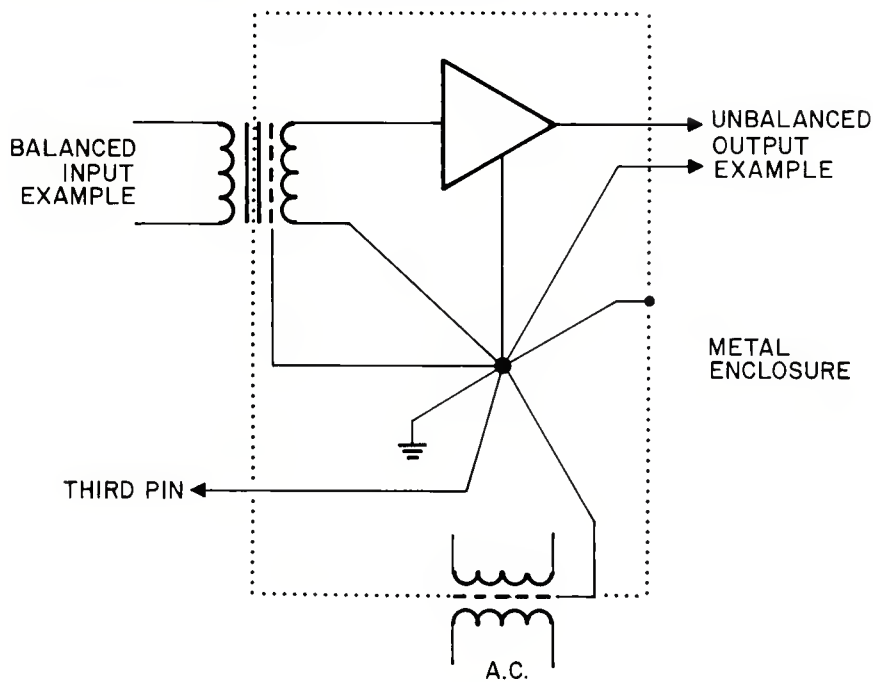

FIGURE 6

wire run to the mixing console ground. While this is a much easier system to implement, it will not be as good as having all grounds at the console where signal amplification occurs. The closer these amplifiers reference to Ground, the less they will amplify ground noise. (See FIGURE 4.)

For example, a wire having 0.01-ohm resistance and carrying 1 milliamp of current will generate a voltage of 10 microvolts, or a signal that is 100 dB below line level. If this signal is applied to eight microphone preamplifiers with 40 dB of gain, it will be -42 dBv, or 23 dB above the tape noise.

GROUNDING THE EQUIPMENT RACK

Acceptable performance can usually be achieved from the typical equipment rack if a single heavy ground is brought back from each power receptacle in the rack to the ground point. When doing this, the following four precautions should be observed:

1. Be sure that the power-line input of each piece of equipment mounted in the rack is transformer-isolated. If not, connect to power through an isolation transformer.

2. Any piece of equipment which is not balanced in and out should be isolated from the rack, and a separate ground wire taken back to the ground plate. (If done correctly, the third pin will usually be adequate.)

UNCOMPROMISING WIRELESS MICROPHONES

Finally, you can choose a wireless mic to fit the application. The Telex WHM-300, the electret wireless transmitter mic for uncompromising speech clarity. Or a Telex WHM-400 dynamic wireless transmitting mic for vocal entertainment with rich, full bodied audio quality. Both elegantly tapered and without trailing antenna wires. Or select the miniature electret WLM-100 lavalier mic (or any standard dynamic mic) with our belt-pack transmitter.

Combined with the superb Telex dual diversity* FM receiver, you'll have a wireless system that is as good as any hard wired mic, and at a reasonable price. Write us today for full details.

Quality products for the Audio Professional



TELEX

TELEX COMMUNICATIONS, INC.

9600 Aldrich Ave. So., Minneapolis, MN 55420 U.S.A.
Europe: Le Bonaparte - Office 711, Centre Affaires Paris-Nord, 93153 Le Blanc-Mesnil, France

*U.S. Patent No. 4293955. Other patents applied for.

3. Each piece of equipment installed in the rack should follow correct grounding and shielding design. To properly ground and shield a piece of electronic equipment, tie the case, the third-pin Earth (or Ground reference), and the electronics ground together at only one point. The point on the electronics ground should be the zero potential point, which is that point from which all current flows to the circuits. (See FIGURE 6.) If you find a piece of rack equipment which does not follow this grounding format, be cautious when wiring it into the system. You may find that electrical isolation from the rack or modification of the unit is necessary.

4. Unbalanced equipment should all be located in the same rack(s) with all ground reference and signal wires routed together.

A violation of Rule 1 can cause a power/ground loop if the low side of the AC line is tied to chassis. (See FIGURE 7.) If the equipment is also unbalanced in and, or out, then the low side of the line is linked back through the entire audio signal system and the AC power can actually be fed through the entire audio signal system, and AC power can actually be fed through the console circuits to ground, causing line-frequency modulation of the console ground. Always remember that the low side of the AC line has current from each device flowing through it. Thus, there is usually a voltage drop of 1 volt or more between ground and the low side of the AC line.

A violation of Rule 2 can cause AC leakage current from every piece of equipment in the rack to be superimposed on the audio low side as an AC voltage or hum.

Rule 4 is very difficult to achieve practically. However, the more rigidly this rule is applied, the less problems will be encountered with low-level hum when patching. Consider two pieces of unbalanced equipment, electrically connected by cables following different routes through the studio. A large loop is formed by the wiring. Hum current induced into this loop by lighting and other AC mains-powered circuits will cause voltage drops across the resistance of wires and circuits in the loop. This hum voltage will be present in the audio signals.

WHAT ABOUT CARRY-IN EQUIPMENT?

Frequently, engineers or groups will bring in their own electronic devices, and want to connect them into the house system. Since much of this carry-in equipment will be unbalanced, and may not have a power transformer either, the console patch bay should have several 1:1 line transformers available. Usually, isolating the inputs and outputs of the carry-in gear will solve most hum and RF problems if the control room power circuits are properly done.

UNBALANCED A.C. INPUT

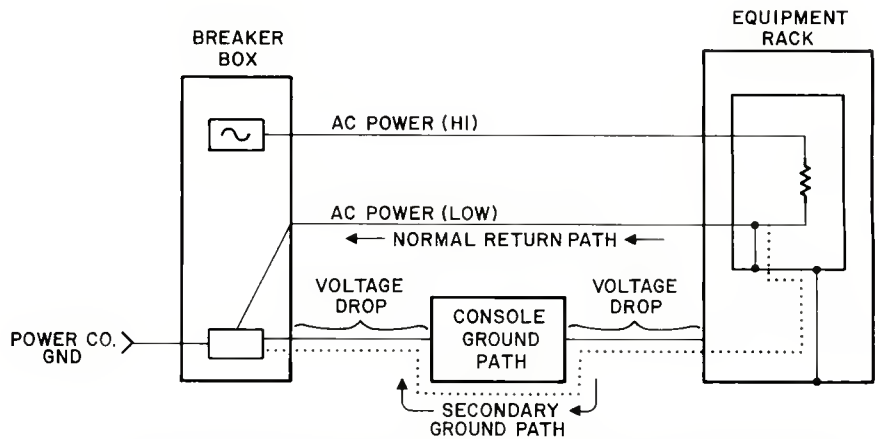

THE SECONDARY RETURN CURRENT PATH CAUSES VOLTAGE DROPS IN THE GROUND REFERENCE WIRES SUCH THAT THE EQUIPMENT RACK DOES NOT "SEE" GROUND REFERENCE BUT RATHER SOME A.C. VOLTAGE.

SHIELDING AND THE AUDIO INTERCONNECTS

Once we have all the equipment connected to power and to the ground reference, we must interconnect the signal lines. The best installation procedure to follow when interconnecting the studio equipment is:

FIGURE 7

1. Connect the control room monitor system to the console. Apply power and, with all faders closed, monitor the two mixdown buses with the master fader and monitors at full level. Listen for hum, buzz, and RF. Only when you are satisfied with the noise character should you proceed to the next step.

SHIELD CURRENT PATHS

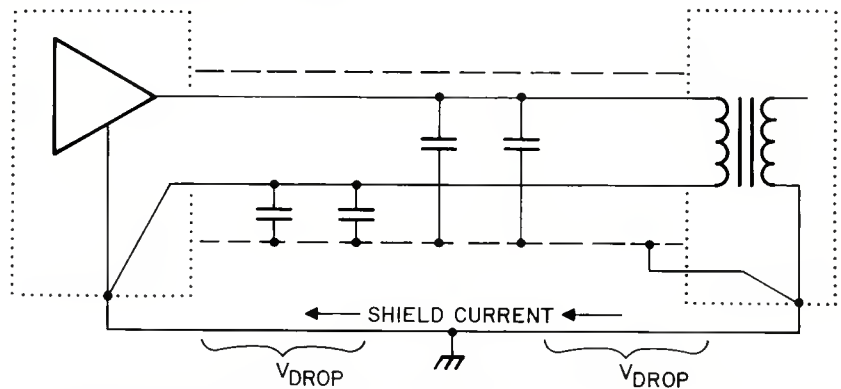

IF THE SHIELD IS TIED AT THE RECEIVING END THEN CAPACITIVE COUPLING TO THE SIGNAL LINES CAUSE CURRENT THRU SYSTEM REFERENCE GROUND RESULTING IN A VOLTAGE DROP.

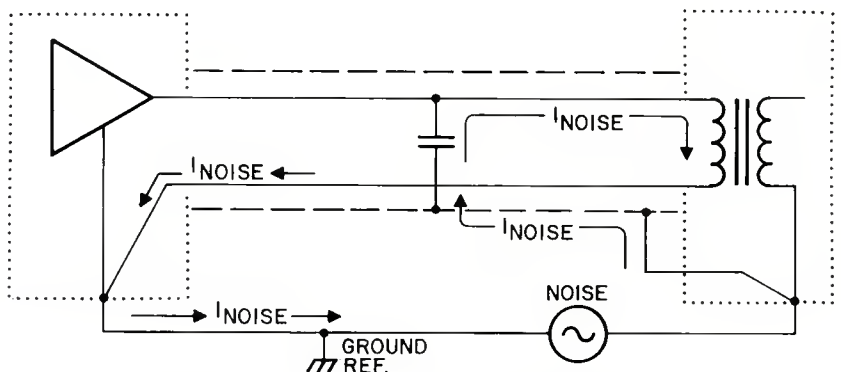

IF THE SHIELD IS TIED TO THE RECEIVING END, NOISE OR REFERENCE ERROR IS CAPACITIVELY COUPLED TO THE SIGNAL LINES.

FIGURE 8

2. Connect noise reduction units and multi-track tape recorders to the console, one at a time. Apply power, and with the appropriate channel faders at nominal level and the machines in the Input mode, again check for hum, buzz and RF.

3. Connect one piece of peripheral equipment at a time to the console. As above, verify proper equipment operation, and listen for hum, buzz and RF.

By following these three steps, you will be able to pinpoint problem connections as they are made, saving much work and time.

Careful adherence to the following shielding and signal interconnect rules will prevent most of the noise and crosstalk problems usually encountered when wiring a new studio.

1. Shields should connect to signal ground at the earth tie point on the signal-source end.

This is important because of three critical current paths which need to be optimized. (See FIGURE 8.) Three sources of signal being impressed on the shield of a cable are: the capacitive coupling between the signal wires inside the shield and the shield itself, the extraneous electrostatic and electromagnetic fields cutting the shield, and the point to which the shield is tied.

Any signal within the shield is capacitively coupled to the shield and causes a current to flow in the shield. This current must ultimately return to the source of the signal, either through a direct connection to that source's ground or via the entire ground system, if tied to the receiving end. Since the capacitive coupling impedance goes down as frequency goes up, an incorrectly-grounded shield will cause excessive high-frequency crosstalk in the system by generating a voltage drop in the ground system.

The shield is also carrying a current radiated into the shield from AC and RF fields near the shield. These currents need to be returned to earth by the shortest route and through the fewest signal grounds as they will cause a voltage drop on a signal ground. This voltage drop will appear on the signal output of the electronics referenced to the signal ground.

Lastly, the shield must be at the zero potential of the signal within the shield, or the shield itself will become a source of radiation onto the signal lines within.

2. Every signal line should have its own shield. If signal lines are put within a common shield, they will capacitively couple to each other. If shields are shorted together other than at the signal reference point, they will share coupled signal currents and will both be a true shield to the signal line within, since the finite resistance of the shield will cause a voltage drop, lifting the shield above the signal reference. (See FIGURE 9.)

In high RF areas, the receiving end of a shielded wire (that end not tied directly

THE RESULT OF SHORTED SHIELDS

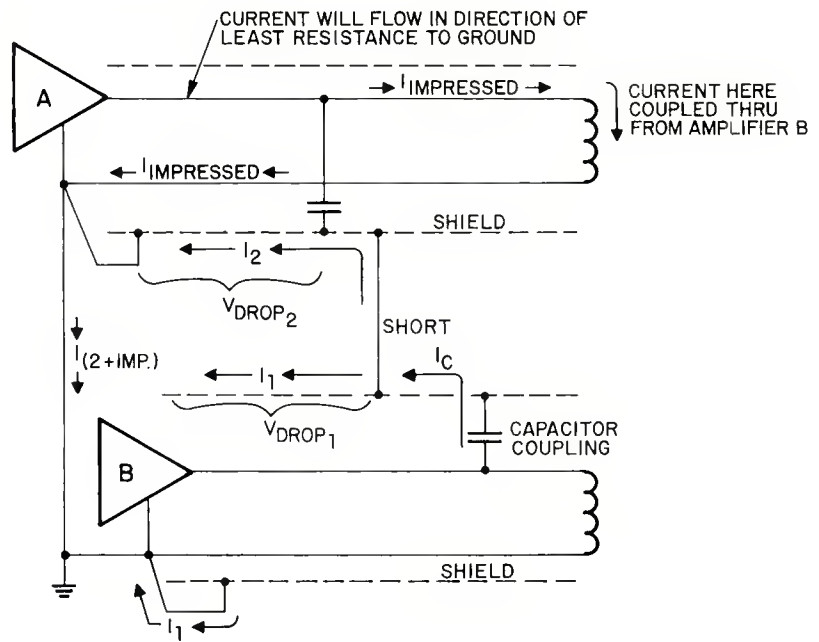
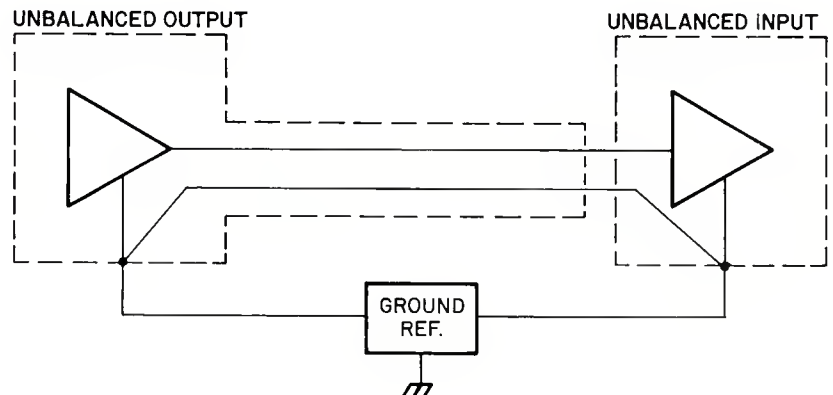

FIGURE 9

UNBALANCED OUTPUT TO UNBALANCED INPUT



THIS IS A VERY POOR INTERCONNECT METHOD. EXPECT GROUND LOOP PROBLEMS, BEST WAY TO AVOID - BE SURE A.C. IS THRU TRANSFORMER AND GROUND REFERENCE CONNECTION IS EXCELLENT. AVOID SHARING GROUND REF. WIRE WITH OTHER EQUIPMENT.

FIGURE 10

to signal ground) should be tied through a $0.0 \mu\text{f}$ capacitor to signal earth/ground.

At radio frequencies, this $0.01 \mu\text{f}$ capacitor will appear as a short circuit, lowering the effective shield impedance to ground. A 24-track tape recorder connected thusly will have $0.5 \mu\text{f}$ of the capacitance between the two systems, which is about 530 ohms at 60 Hz; not a significant ground-loop problem.

In summary, when interconnecting individual pieces of studio equipment, there are three possible input/output

circuit configurations: unbalanced, balanced, and differential. These can be connected in nine different ways.

FIGURE 10 illustrates one of the nine possible interconnect schemes. Care should be taken when reviewing each type of interconnect. The ground points indicated need to be connected as shown in the figure. When interconnecting several inputs or outputs from the same unit, only one ground reference wire should be needed for that unit. ■

ZAP—Zero Acoustic Phase Cancellation

IN RECENT MONTHS, the PZM microphone has achieved outstanding success due to the clarity of pickup and extra acoustic gain. Ken Wahrenbrock's development of the pressure principle has provided us with an outstanding new microphone. Dr. Clay Barclay documented the principle and developmental work in the June, 1981 issue of *db*.

We feel that many readers who are involved in less-demanding audio roles than recording studio work might like to make use of the Zero Audio Phase cancellation techniques involved without the present high cost. The following application note describes how you can construct a good quality, moderately priced unit. First, though, we should go back to the early findings behind the present day developments.

BACK TO THE BEGINNING

Ever since Lou Burroughs described ways to reduce phase cancellation, audio engineers have been looking for ways to reduce phase cancellation (within the audio spectrum) to zero. The technique, of course, is to place the diaphragm very close to

Mr. Graham and Mr. Churchill are both involved in freelance audio work.

a reflective surface and eliminate reflection paths. The problems have been the size of windscreens used and the size of the diaphragm itself. If the windscreen is too large, the diaphragm remains some distance from the reflective surface and some cancellation remains at high frequencies. Even if you could place the diaphragm close to a surface, some cancellation would take place across the diameter of the diaphragm due to its size. The modern electret microphone has eliminated both of these problems, and in this paper we propose to show you how you can modify an inexpensive, readily available, electret to produce the "ZAP."

Our ZAP may not meet the rigid specifications of some recording quality units on the market that make use of Mr. Burroughs findings, but we have found that the ZAP is excellent for P.A. work and CCTV pickup. Roger Anderson and Robert Schulein described in 1971 how a special stand can hold a microphone close to a wall or floor and obtain a broad pattern and an extra 6 dB of acoustic gain. Our experiments have also achieved this as well as excellent freedom from mechanical pickup noise. Sound pickup has been had on video sets that could not have been obtained with any other type of microphone.

PRODUCING THE ZAP

The foundation for our modifications started with a Sony ECM-16 tie-clasp microphone. The element (do not remove the paper windscreen) and FET were removed from the housing and installed in a machined aluminum case shown in **FIGURE 1**. The case is simply rod stock with one side flattened and two holes drilled into it.

One hole holds the element and the other the FET amplifier. Another hole was drilled from one end to connect the two larger holes and provide a path for wiring. **FIGURE 1** shows the amplifier hole covered by a 3/32-in. shim which was tapped to

ACCURATE TAPE TENSION MAKES BETTER RECORDINGS

If something SOUNDS FISHY it may be your fish scale approach to measuring tension.



The Tentele Tape Tension Gage is designed to diagnose problems in your magnetic tape equipment. Virtually all recorder manufacturers use and recommend the TENTELOMETER® for use with their equipment.

The TENTELOMETER® measures tape tension while your transport is in operation, so you can "see" how your transport is handling your tape; high tension causing premature head and tape wear, low tension causing loss of high frequencies, or oscillations causing wow and flutter. Send for the Tentele "Tape Tips Guide". The T2-H20-ML sells for \$279 - complete.

1506 Dell Avenue
Campbell, CA 95008
(408) 379-1881
Toll Free 800 538-6894 (ex. CA)

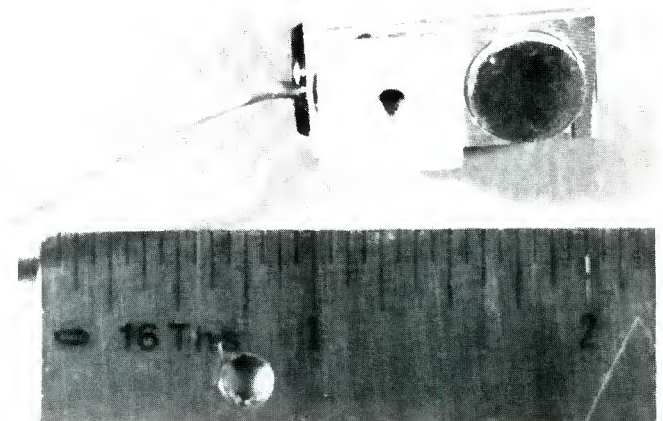

Figure 1. Machined aluminum case with one side flattened, and two holes drilled into it. One hole holds the element and the other the FET amplifier.

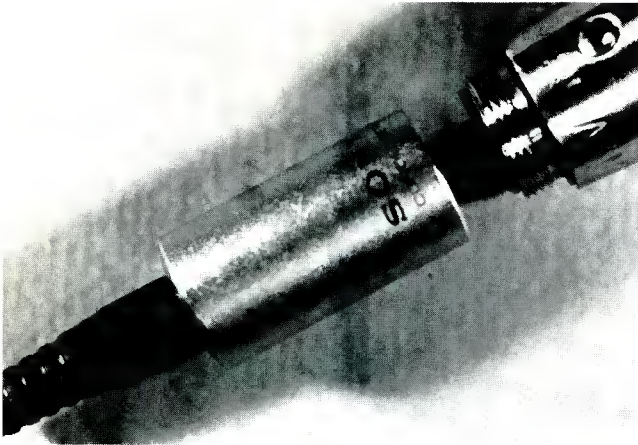

Figure 2. An A3M connector reamed out to accept the original cable end of the mike.

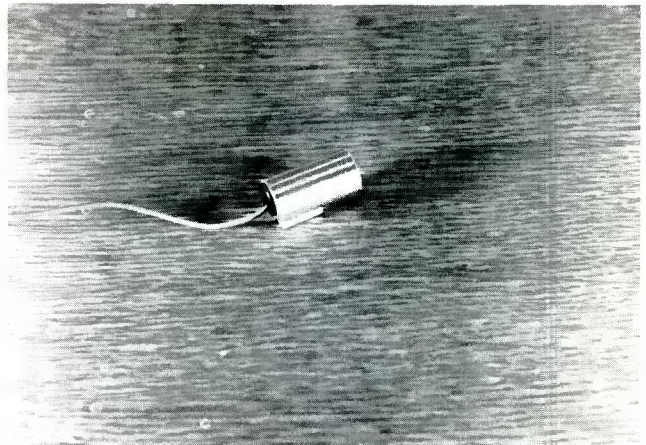

Figure 4. The ZAP fastened to a desk.

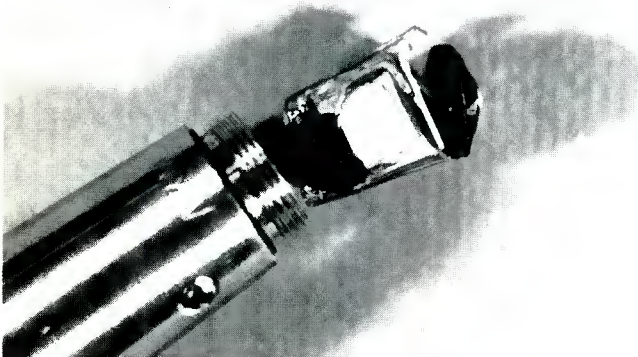

Figure 3. The original cable end installed in the A3M and the transformer exposed for final wiring.

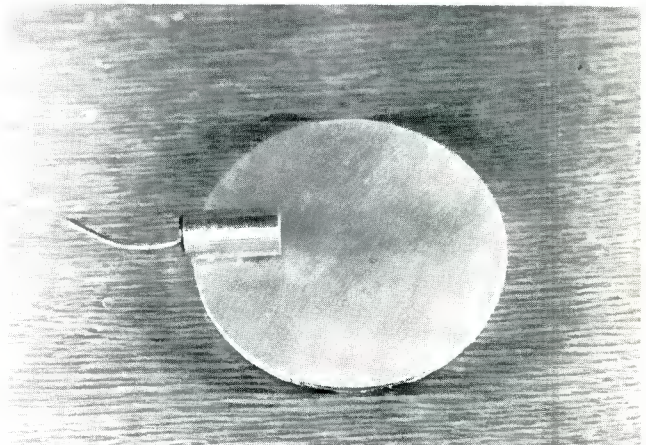

Figure 5. The ZAP attached to a 3 1/2-in. diameter circle of 1/8-in. aluminum.

allow mounting the case to a base. The shim provides shielding for the amplifier and raises the element from the reflective surface. It was epoxied in place.

The second step was to modify the original housing. First, a hole was drilled through the original windscreen to accept a strain relief and a light-weight shielded wire was connected from the FET amplifier with the shield connected to the case at each end and the center conductor connecting the FET amplifier to the original battery spring contact.

Next, the cable end of an A3M connector was reamed out to accept the small black original cable end of the mike. This detail is shown in FIGURE 2. The cable end of the ECM-16 holds a transformer which makes it possible to turn the ZAP into a balanced output device.

FIGURE 3 shows the original cable end installed in the A3M and the transformer exposed for final wiring to the A3M pins.

Although we often use the ZAP fastened to a desk with a small piece of thin double sided tape (FIGURE 4), we felt it should have a base in the event the surface was not suitably reflective. Some experimentation was needed because if the reflective surface is too small there is a serious effect on the bass response. By the way, we found that the ZAP is very bright in the high end and you may wish to roll this off in some applications. FIGURE 5 shows the final choice of a 3 1/2-in. diameter circle of 1/8-in. aluminum. It has a hole drilled in it to accept a counter sunk head bolt to hold the ZAP to the base. The bottom was covered with double sided foam based tape and felt, with a small opening for the mounting bolt. This completes the construction.

The most critical measurement is the thickness of the shim. If it is too thick, the element is high enough for some cancellation, too thin and the pickup is reduced. The math works out to 330 mils for zero phase cancellation at a frequency of 20 kHz, but tests showed 3/32-in. to give the best results. Perhaps we missed a factor in the math—as we all know there is often a difference between theory and practice; practical testing is always required.

A very thin foam tape on the base will keep the profile low, and greatly reduces mechanical pickup noises.

To wrap up the story, one outstanding success with the ZAP was at a conference where the wooden stage vibrated with every step. Rubber mats under the conventional floor stands made the microphones too wobbly. The speakers were nervous enough without extra shock mounts and wobbly stands. In fact, they wanted a minimum of gadgets. A mike fastened to the lecturn was no better. It did reduce footsteps, but in rehearsal, the results were very “breathy” and there was pickup on paper noise etc. The ZAP was still under test, but in desperation it was tried. The results were fantastic. No stage noise, no lecturn noise, no paper noise and we were able to almost double the performer-to-mike distance before feedback, so there was no breath noise. Afterward, the big comment was, “I didn’t have to put up with a mike in front of my face.” The group wanted to buy “one of these gadgets” and we had to say “They’re not for sale.”

We hope this may be of some use to those who can put the proximity principle to work, but don’t need a truly high caliber recording/broadcast type of microphone. ■

db Convention Report

The 72nd AES Convention: Technical Sessions and Workshops

IN ITS OWN INIMITABLE style, which combines elements of the running of the New York Marathon, the anticipating of next year's automobiles, and the sensibilities of a bazaar in Constantinople, the Audio Engineering Society meets yearly for its U.S. convention. Amid a phantasmagoric scenario in which new studios are hurriedly designed on cocktail napkins, there remains an ulterior, subdued, but no less exciting reason for convening. The technical sessions and workshops which are presented permit a concentrated exchange of information between manufacturers, researchers, and academicians. In the same way that the AES Journal serves as a forum for the scientific audio community, these sessions offer the opportunity for presentations, dialogue and interaction. The latter purpose was better served this year by a new precis/poster format for the papers. Following delivery of the paper, which typically leaves little time for questions, the speaker appears at a station for follow-up discussion. The non-appearance of many speakers and the unfamiliarity of the new scheme for many attendees limited the success of the precis/poster, but it is a step forward in the information-sharing process.

Nine technical sessions and eight workshops were presented in which some 114 authors and 52 workshop participants were represented. Topics ranging from shielding and grounding, and studio troubleshooting, to education and psychoacoustic illusions provided a wide ranging look at state-of-the-art audio. Because of the simultaneity of many excellent sessions, the question of choosing was often non-trivial and agonizing. For those of you who missed something you wanted to see, and for those of you who stayed home, I would like to offer a review of

some of the most (or least) interesting technical events. Because I was usually only in one place at a time, and I selfishly demanded to sleep, and eat at least once a day, my review must necessarily be incomplete—besides, I do not wish to usurp the Journal's contents for the coming year. For those of you who crave completeness (almost), I refer you to the preprint set available for \$50 from the AES, 60 East 42nd Street, New York, NY 10165.

ACOUSTIC AND REINFORCEMENT TECHNIQUES

The modified Hopkins-Stryker equation was the subject of a paper by Don Davis¹. Since its introduction in 1948, the Hopkins-Stryker equation has been used to determine an expected sound pressure level at some distance from the source. The two terms of the equation account for the direct sound field, and the reverberant sound field in a homogeneous acoustic space. The equation has proved useful for a wide variety of cases in which the ratio of direct-to-reverberant sound has been altered by multiple sources, semi-reverberant conditions, and critical distance changes. Prediction accuracy relative to measurement validity can be improved by the addition of parameters which control the sound fields. For example, the directivity factor Q can be accounted for in several ways to better describe its effect. A series of Q point measurements permits the use of an average of Q s within an area. Q may be measured both on or off-axis, and at various frequencies, and for single source and multiple sources (increasing the Q of the first device proportionally).

A paper by David Moore, Herb Chaudiere, and Bernie Cahill² presented a comparison between real-time analysis (RTA) and time-energy-frequency (TEF) techniques such as time-delay spectrometry (TDS). Problems such as near- and far-field analysis, horn coverage, interference zones, and

Ken Pohlmann is the assistant director of the Music Engineering Program at the University of Miami and a db columnist.

frequency response of clusters at seating positions were documented in two studies. Because of the ability of TDS to selectively examine direct sound or reflections, phenomena previously obscured by the time smear of RTA were revealed. Some TDS frequency responses bore little resemblance to the RTA curves and pointed out many cancellations due to early reflections. In other cases, coverage inadequacies were shown only in the TDS response. More extensive use of TDS in sound reinforcement could influence horn design, placement, and aiming. As later presentations showed, the authors' call for a dedicated instrument for use in the field has not fallen on deaf or non time-aligned ears.

Distributed sound systems for sloped floors and ceilings was the topic presented by Rex Sinclair³. In very live or very dead rooms, or where clusters are not feasible, distributed sound systems must be used. When a sloped or non-planar ceiling or floor is encountered, placement determination involves more deliberate design techniques. Given the approximation of SPL contours on an inclined plane by concentric circles displaced up the plane, the author presents two design methods: one which yields equal loudspeaker density per coverage area in the listening plane, and another simpler approach in which loudspeaker unit cell size is constant at the ceiling. Articulation losses of consonants for distributed systems is analyzed, and a flow chart for a design program is given.

Thomas Bouliane⁴ presented new methods for intelligibility mapping through array perspective analysis. Coverage patterns have been predicted using techniques ranging from light projections on scale models to mathematical modelling. A recently proposed technique uses seating area mapping as viewed from the loudspeaker perspective which permits computation of direct sound levels. Bouliane's electroacoustic technique produces a set of equations identifying seating area matrix points which are referenced to the room dimensions. Intersections of the loudspeaker's aiming axes can be derived from these equations and used to calculate articulation loss from the direct-to-reverberant ratios. The predictive power of the three-dimensional model provides useful information for the designer. Even more comprehensive results could be obtained from the inclusion of other intelligibility factors, and more standardized agreement between loudspeaker manufacturers and acoustical designers on the interpretation of the mathematical variables employed.

John Prohs and David Harris⁵ presented a different method of modelling loudspeaker array coverage based on the loudspeaker perspective two-dimensional mapping technique. The authors point out that due to cartography axioms, distortion must occur when a spherical waveform segment wavefront is transformed to rectangular coordinates for mapping on room plots. They argue that the only true map is a globe, and they attempt to relate the loudspeaker and the room to the sphere. The conceptually-interesting procedure utilizes a "small plastic sphere comprised of two separable hemispheres which fit into a standard attache case."

A presentation of a computer-aided room acoustics modelling and simulation system known as the Godot system was given by John Walsh and Marcel Rivard⁶. The system is an analysis and synthesis tool which uses several methods to process audio source material to create the audible effect of a space prior to realization. Godot is a sound beam tracing system which is fully compatible with the Computer-Aided Architectural Design (CAAD) programs already in existence; the room model is polyhedral, using the Baumgart winged edge representation. The beam striking list is stored as linked lists for later processing for the audible simulation. Each list node stores a sequence of reflection nodes originating at one of 384 beams; the power transfer function of the path is computed and time delay, arrival direction, broadband attenuation, and frequency response can be determined for use in the simulation. The authors conclude with a summary of the economic necessity of predicting the perception of sound in rooms, both for architectural and sound system design. The Godot system does not fit into an attache case.

An interesting report on subjective measurements of loudspeaker sound quality was given by Floyd Toole⁷. Speaking out against audio uncertainty, where it has always been most firmly entrenched, the author argues for defining the nature of subjective measurements of loudspeakers; he argues against advice and opinion and instead opts for underlying order. From the complexity of acoustics, physical to physiological, electronic and experimental psychology, he attempts to distill trustworthy subjective data. He describes his testing procedure and the resulting experimental data in order to evaluate the test method itself. A salient question is the control of variables—ranging from the listening room, loudspeaker positioning, loudness, and program material, to familiarity of the product and the room, and effect of sequence and memory, and experimenter bias. In general, the experimental method must be controlled in three ways: technical and environmental variables, listener variables, and experimental variables. The complexity of the undertaking is suggested by some interesting results of the testing. For example, listeners with the lowest hearing levels (below 20 dB SPL) at frequencies below 1 kHz exhibited the best repeatability of judgment of fidelity. Listeners with increased levels exhibited more variability and showed strong biases in their ratings of particular loudspeakers. Clearly more study is needed, but a well-calibrated method may be feasible.

A combinative microphone technique using contact and air transducers was presented by Frank Opolko and Wieslaw Woszczyk⁸. In an effort to enhance transient response and timbral definition of acoustic instruments as recorded by close microphone techniques, the authors have explored the additional use of contact microphones. A categorization of recorded sound board timbres was accomplished based on existing basic vowel types. Experiments showed that the resulting timbres could be successfully combined with reverberant integrated harmonic information. The authors suggest that contact pick-ups provide an easier and more natural means of timbral shaping, and that several contacts on an instrument may be combined to achieve the required tonal characteristic without resorting to equalization. While many recording engineers have been plagued by selective radiation patterns from instruments, the authors suggest that the selectivity isn't enough, and that the variations in the sounding boards themselves must be employed. Practical applications are available to the recording engineer who believes that it is more "naturally effective" to use multiple contact pick-ups rather than electronic equalization. Rather than fix it in the mix, such engineers would thus fix it in the F.R.A.P.

A new type of listening room with controlled response was proposed by Shinichiro Ishii and Toshiyuki Mizutani⁹. They pointed out that the advantages of high-fidelity equipment are often negated by distinctly low-fidelity listening rooms. Following an outline of conventional deficiencies in conventional rooms, the authors proposed a design with rather reflective wall segments of concrete faced with marble and rather absorptive wall segments of 1.7 m thick glass fiber. Other innovations included non-parallel surfaces.

Chips Davis and Glenn Meeks¹⁰ authored a paper on the history and development of the LEDE control room in an attempt to illuminate some of the underlying TDS/TEF data and applied design techniques. Don Davis first raised the possibility of an acoustically-soft front wall in a control room in an effort to avoid cancellations between the direct and early reflected sound, and a hard rear wall to provide multiple comb response dispersion for smoothing effects, arriving at the mixing position within the Haas zone. Chips Davis built such a room in 1978, and subsequently fine-tuned the design with new energy/time-curve (ETC) measurements which further defined the parameters for the LEDE room concept: an anechoic response of the loudspeaker for the first 15 ms, rear wall reflections within 15 ms, and even-energy decay following the Haas zone.

SIGNAL PROCESSING AND AMPLIFICATION

Resolution below the least significant bit in digital systems using dither was the topic of a paper by John Vanderkooy and Stanley Lipshitz¹¹. When a wideband noise dither equal in amplitude to the quantizing step size is added to a digital signal, information at the level of the step size may be retained. By linearizing the staircase function as perceived by the ear, signal distortion is changed to benign wide-band noise. Whereas sampling theoretically introduces no degradation for a bandlimited signal (except for a frequency response error called aperture error), quantizing must always introduce degradation which may be perceived as harmonic or intermodulation distortion, or even worse, misrepresentation. The inevitable coarseness of amplitude quantization leads to waveform error, commonly perceived as a granulation noise. Dither in the form of Gaussian or rectangular probability density noise may be added to remove this quantization structure from the waveform, to reduce it to structureless white noise. The result is a slight sacrifice in signal to noise ratio, and the elimination of any granulation effects in the digital signal.

A portable digital audio processor for use with home VCRs was the subject of a paper authored by a team of Matsushita engineers and delivered by Almon Clegg¹². The paper describes an extremely compact PCM processor utilizing newly developed LSI circuits and simplified circuit flow. Quantization of linear 14 bits is accomplished at a sampling rate of 44.056 kHz. A combined AD/DA converter was developed in a single 24-pin package and operates in conjunction with three new N-channel MOS chips to complete the signal processing circuitry. Also, a new microprocessor was developed to adjust data slice level thirty times per second in the video playback signal to minimize errors. In an effort to solve the problem of recording level indication in a digital recorder, this unit displays input levels above the clipping range to permit more useful correction and reference; a level of +6 dB, a 15-bit swing, was chosen. The unit weighs 3.1 Kg, and may be used with a portable VCR weighing 3 Kg.

CALCULATOR AND COMPUTER APPLICATIONS IN AUDIO

Three papers by John Lanphere¹³, Ted Uzzle¹⁴, and Mark Laffin¹⁵ explored the role of calculators in sound system and acoustic design; the HP-41 programmable calculator and its HP-IL loop served as a common example. Calculator-assisted design permits use of a sophisticated and portable tool by the designer who might lack access to a larger system. Complex and repetitive calculations which assist the design process may be rapidly accomplished in real time, and stored for further analysis. Applications software was discussed, with examples such as the RMGMTRY program which calculates the volume, surface area, and coverage angles for any size or shape room, and the T60MEAS program which facilitates T_{60} measurements and plots the resulting values. Also discussed was the utility of manufacturer support via calculators with published keystroke sequences and programs, through which product performance data and applications techniques may be passed along to the users of sound products.

A highlight of the convention occurred with the presentation of a paper authored by Deane Jensen and Rob Robinett¹⁶ concerning their use of an ac circuit analysis and optimization program, COMTRAN, in synthesizing active filters. Given a schematic with up to 35 nodes, consisting of the three types of passive elements and current-controlled sources characterizing transistors or op amps, their program plots gain, phase, phase delay, group delay, square-wave response, impulse response, step response, and output waveform for any input signal. Designs may be optimized by varying component values to improve response of transfer functions and impedances. A measurement program may be used to examine magnitude and phase response of analog or digital tape recorders through FFT and deconvolution calculations. New circuit topologies are made possible with COMTRAN; the complexity of many unusual configurations sometimes prohibits efficient

component determination by designers, and standard response characteristics or extra stages are often substituted. In a presented example, a single op amp topology dictated nine circuit components, but only four simultaneous equations may be derived from the desired four-pole transfer function. COMTRAN solved for values to form a Butterworth four-pole low-pass response for the single op amp filter whereas typically a cascaded design would have to be employed. The program is further used to fully analyze the design performance, and optimize component values to standard values.

Gerald Stanley¹⁴ unveiled a microprocessor-based TEF analyzer developed by Crown to respond to the contemporary need to measure frequency response as a function of time, and thus finally acknowledge the existence of the propagation time of signals in all physical systems—a condition “discovered” by Richard Heyser fifteen years ago. Using a Z-80 as a main processor, as well as multiple Z-80s as programmable oscillators, the TEF analyzer employs the CP/M operating system to permit ready use of high-level languages, text editors and word processors, assemblers, and linking loaders to enhance its capability to that of a full microprocessor system, and drastically reduce software development problems. A one megabyte mini-floppy is used for storage, and data may be copied from disk to disk with the PIP command. User interaction takes place through an ASCII keyboard. Present software could show a magnitude response plane as a series of TDS sweeps, then post-process the data to show the reverse side of the figure. Also, a single TDS sweep taken at the first arrival time, a polar (Nyquist) display of the same data, as well as a phase versus frequency figure, could all be displayed.

NEW DIRECTIONS IN AUDIO

Peter Schreiner¹⁸ presented a paper discussing the implementation of digital audio radio network satellite distribution systems. C-band satellite links with frequency response from 40 Hz to 15 kHz, an 80 dB dynamic range, and THD of less than 0.3 percent will soon replace leased telephone lines for the delivery of audio signals. A broadband time-division-multiplexed carrier allows the use of a single satellite transponder with many broadcast channels, thus yielding greatly reduced cost. Each satellite transponder could support the data rate of twenty digitized 15 kHz audio channels at 384 bps each. However, care must be taken in designing the source encoding techniques, and processing hardware to take advantage of interference immunity and lossless regeneration. Source-encoded 15 bit linear PCM, with algorithmic compression to 11 bits has been suggested as being a cost-effective method.

John Meyer¹⁹ authored a paper on the subject of the time correction of anti-aliasing filters. The brick wall characteristic required of anti-aliasing filters produces significant high-frequency delay. The author proposes that the nature of these phase distortions differs from those produced in loudspeakers and analog tape recorders and is responsible for the subjective criticisms of digital systems. While non frequency-dependent delay may not be audible, frequency-dependent distortion must only point to the question of where the threshold of its audibility lies. Using a goal of phase minimization, the author has developed a time correction system, a tunable analog filter, which may be employed for correction before or after digital processing. To cancel the non-linear delay component, a reference signal is delayed with an analog bucket brigade to isolate the non-linear component, which is subjected to FFT analysis. Complementary group delay characteristics are derived, and implemented on traditional all-pass topologies. The corrected system behaves as a pure delay line.

MAGNETIC AND DISK MEDIA

The audio side of the laser videodisc was the topic for the presentation by Greg Badger and Richard Allen²⁰. The laserdisc player uses a laser beam which is directed on a track and reflected back onto photosensitive diodes. There is no physical head contact, and the beam is focused on the reflective layer

beneath the top surface so abrasions and fingerprints are obviously out of focus. The signal from the head is converted to RF signals, and audio signals are retrieved from low-pass filtering of the composite signal. Quadrature frequency detector states derive two channels, drop-outs are detected by the FM detector and the previous sample is held, audio signals are passed through a de-emphasis circuit, and applied to a CX noise reduction decoder. The decoder outputs are buffered and appear at line level or via an NTSC RF modulator. A 58 dB signal-to-noise ratio is obtained at the output. Time base errors due to disc eccentricities are corrected, wow and flutter is typically below 0.1 percent. Manufacturing clean rooms have helped to eliminate the drop-outs which occurred on earlier discs.

Random-access editing of digital audio, as exemplified by the Soundstream system, was the topic of discussion by authors Robert Ingebretsen and Thomas Stockham²¹. Splices may be created or modified, auditioned, then sequenced through the use of large capacity rotating magnetic media and a time-base smoothing buffer. In addition, familiar functions such as fading, mixing and equalization may be accomplished. The takes to be edited are stored in random-access memory, and splice-point transitions of contoured cross-fades, or smears, are also placed in RAM. The time-base smoothing buffer creates continuous output between the takes and the transitions, thus eliminating copying of data. Using a splice menu, a digital controller is used to interact with the system to create playback auditions of the splice. The console with its graphics package is finally employed to audition, specify and modify splice parameters, and save splices; graphics may be used to visually inspect a splice. Several such splice tables may be prepared for auditioning, and randomly manipulated. The current Soundstream system uses a DEC PDP 11/60 minicomputer with 256K of RAM and dedicated fast floating point hardware as the controller; software is contained on a 28 megabyte hard disk. The random-access memory consists of two 300 megabyte removable media disk drives for a total capacity of 42 minutes of stereo program on line.

James Moorer²² presented a report on a project to develop an audio signal processing station, a digital system capable of performing all of the signal processing functions of mixing, editing, processing, and synthesis which would be required for film sound production. The first prototype has been completed as an eight-channel unit operating at a 48 kHz sampling rate, and is easily expandable in groups of eight channels. A distributed processing system is comprised of model 68000 microprocessors. Mass storage is provided by 300-megabyte disks and up to four disk drives may be appended to each eight-channel unit. Current plans call for the construction of two additional eight-channel stations, and one sixteen-channel model.

AUDIO TESTS AND MEASUREMENTS

William Elder²³ was the author of a paper describing the development of a Fast Fourier Transform (FFT) analyzer for use with the Apple II computer. Using the architectural advantages of the 6502 microprocessor which qualifies it for effective FFT processing, and the low cost and wide availability of the Apple computer, the author has designed a circuit card and software package which transforms the Apple into a signal analysis package by providing test signal generation, waveform digitization and recording, waveform editing, FFT spectral analysis, high resolution graphics, and image plotting. A programmable gain preamplifier is used to scale/optimize the data for use with the 8-bit microprocessor, and anti-aliasing filters are used. A DMA circuit stores data to be analyzed in the computer. A programmable DAC is used to generate test signals. For example, an impulse of 13 ms may be applied to a loudspeaker for determination of the frequency spectrum; averaging filters may be used for smoothing. A 512-point FFT power spectrum, as well as a phase response, may be displayed. All commands are single keystrokes.

Computer-based signal processing for audio electronic performance measurements was the topic presented by Robert

Finger²⁴. A minicomputer system using off-the-shelf hardware has been implemented which is comprised of a signal synthesis unit to generate test signals, and a signal analysis unit to process the signals. A DEC MINC mobile computer and DEC LSI 11 are used as processors, and other system hardware is standard issue, with the exception of three boards: a digital-to-analog output board, a programmable low-pass filter, and a special purpose analysis board. The flexibility of the system is such that many quality control operations consisting of varied measurements may be carried out. All of the hardware is programmable. Thus many users with individual applications may develop customized software around the general purpose measurement system. Once in memory, all processing is accomplished with software-implemented filters such as windows and modified FFTs. Tests which are difficult to perform algorithmically, such as frequency modulation, may be delegated to hardware boards. A typical application might test tape recorder performance: reference level, distortion, amplitude modulation and inter-channel time delay, ten frequency responses, speed, wow and flutter, amplitude modulation at high frequency, noise testing, stereo separation and crosstalk are all tested in thirty seconds.

These and other topics carefully chosen by the AES constitute a hitchhiker's guide to the state of the audio community. Even a cursory examination of the paper subjects shows startling juxtaposition of contemporary thought on such topics such as TEF, digital processing, and computer applications. Such unexpected coincidences of scientific thought have historically proved to signal the birth of definitive contributions to our way of utilizing and furthering our technological and scientific understanding. Judging by the controversy and consensus emerging at this latest AES convention, and elsewhere in the audio community, we can expect more of the unexpected as the state of audio continues its rapid advance. ■

Bibliography of AES Preprints (Preprint number in parentheses)

1. (1888) The Modified Hopkins-Stryker Equation.
2. (1919) Comparison of Real-Time Analysis and Time-Delay Spectrometry at Two Sound-Reinforcement Projects.
3. (1892) Distributed Sound Systems for Sloped Floors and Ceilings.
4. (1927) Intelligibility Mapping Through Array Perspective Analysis.
5. (1941) An Accurate and Easily-Implemented Method of Modelling Loudspeaker Array Coverage.
6. (1910) Signal-Processing Aspects of Godot: A System for Computer-Aided Room-Acoustics Modeling and Simulation.
7. (1900) Subjective Measurements of Loudspeaker Sound Quality.
8. (1948) A Combinative Microphone Technique Using Contact and Air Transducers.
9. (1887) A New Type of Listening Room and Its Characteristics.
10. (1954) History and Development of the LEDE Control Room Concept.
11. (1930) Resolution Below the Least-Significant Bit in Digital Systems with Dither.
12. (1899) Portable Digital Audio Processor with Home-Use VCR.
13. (1944) CAD (Calculator-Assisted Design) of Sound Systems, Recording Studios and Architectural Acoustics Using the Programmable Scientific Calculator.
14. (1943) A Manufacturer's Field Support Via the Programmable Scientific Calculator.
15. (1945) Applications Software for the Sound System Designer and an Audio Application of the HP-IL Loop.
16. (1947) Circuit Analysis/Optimization Program Speeds Synthesis of Active Filters.
17. (1946) A Portable Computer-Based TEF Analyzer.
18. (1936) Digital Audio for Radio Network Satellite Distribution Systems.
19. (1911) Time Correction of Anti-Aliasing Filters Used in Digital Audio Systems.
20. (1935) The Audio Side of the Laser Disc.
21. (1925) Random-Access Editing of Digital Audio.
22. (none) An Audio Signal Processing Station.
23. (none) Development of a Fast-Fourier-Transform (FFT) Spectrum Analyzer for Use with a Personal Computer.
24. (1895) Computer-Based Signal Processing for Audio Electronic Performance Measurements.

db Convention Report

The 72nd AES Convention: The Exhibits

DISNEYLAND (OCTOBER, 1982)—The recent convention of the Audio Engineering Society demonstrated once and for all that there can be life without Conrad Hilton. For the first time in a very long time, the Society assembled its 72nd Technical Meeting and Professional Exhibits at a new (for it) venue—the Disneyland Hotel in beautiful Anaheim, California. Once celebrated as the terminus of a mysterious railway that stretched all the way to far-off Cucamonga (via Azusa), Anaheim is perhaps now better known as the home of Mickey, Donald, and all the gang. This month, the Mousketeer ranks were swelled by thousands of AES members and friends, who convened here to have a look at the latest in audio technology and hardware.

For this reporter at least, the convention got off to an ominous start, with the drive down to Anaheim from LAX airport. The first trick is to get out of the airport, which is no mean feat these days. It seems the Olympics will be visiting Los Angeles in 1984, and the airport terminal area is being readied for the hordes that will be descending there. The split-level access roads will surely be a wonder once finished, but for now, allow an hour or so to get out of (or back into) the place. You might want to bring along a little oxygen to help you on the drive down to Anaheim, just in case the atmosphere gets a little "close," as it did on the day I arrived. In fact, it was *so* close you could reach out and touch it. Now that I think of it, you didn't really have to reach out at all; it came in through the car's air vents to grab you by the throat. The Olympic athletes are going to *love* breathing this stuff!

But by and by, Disneyland appeared off in the distance (that is, about 50 feet away), and I quickly went indoors to get a breath of air. The next day brought better visibility, and disillusionment—for we were not in the magic kingdom at all. The hotel was actually located across the street, separated from all the fun by a busy highway. Sneaking away would take a deliberate effort, although a monorail system did conveniently travel back and forth from just outside the hotel. But what if the AES (or possibly, the IRS) had spies on the platform? Oh well, back to business.

The Exhibits

As we all know, the economy stinks. No one is buying. Studios are dying. We'd all be better off staying home, and putting our money (our *what?*) in a bank, or possibly in a mattress. But what's this?? Some of the exhibitors are actually smiling! Their booths are crowded, and the visitors seem to be asking the right kind of questions. Here inside, the air is clean, and the mood is optimistic. But could this be another one of Uncle Walt's illusions? No, it seems to be real. Well it's about time! But let's take a closer look.

MICROPHONES

Bruel & Kjaer have long been famous for their instrumentation microphones, which were not really intended for music recording applications. But sooner or later, someone tried them in the studio, and apparently liked the sound. Although at least some "experts" proclaimed the foolishness of all this, the idea

didn't die, and at least a few records are out there in which B & K instrumentation mikes were used. For example, Max Wilcox has tried them on the Boehm Woodwind Quartet (Orion), as well as on some Artur Rubenstein releases. No doubt there are others as well.

At the show, Bruel & Kjaer introduced both a low-noise and a high-intensity microphone, both of which are specifically intended for studio applications. Each microphone is available in either a line-level, or a phantom-powered mic-level, version.

Carl Countryman Associates was on hand with its Isomax series of directional lavalier microphones, including a bi-directional microphone (Isomax Pro-B), which should be the delight of anyone still working on their drum sound. It's unlikely that the drummer will accidentally launch the control room monitors into orbit by hitting one of these. In fact, it's unlikely the drummer will even be able to find the mic, since it's quite small. Cardioid and super-cardioid versions are also available.

The PZM microphone should certainly need no introduction here. Enough has been written about it (both sense and nonsense) in recent years to fill an encyclopedia, or better yet, a circular file. About the only thing that has not been claimed yet is that using it will cure the common cold. One of these days, all the silliness will die away (maybe), and the microphone will take its proper place as one more valuable tool in the mic closet.

Like most good ideas, it's not new. Both Shure Brothers and Electro-Voice have long marketed various kinds of brackets that enable a conventional microphone to be placed quite close to a boundary surface. However, larger microphones have a tendency to get in their own way, and may produce various undesirable "baffle effects" when used close to a barrier.

For use with many smaller-size microphones, Electro-Voice showed its new model 370 Barrier Adapter Plate, which allows the user to place the mic in close proximity to a barrier.



Figure 1. The Bruel & Kjaer 4000 series of Studio Microphones.



Figure 2. The Countryman Isomax Pro-B bi-directional microphone.

However, the E-V spec sheet reminds us that even their plate is not the answer to every prayer. To quote: "While there are many situations in which the use of an omni-directional microphone, surface-mounted on a large reflecting barrier, can produce superior results, it is not always the best option. If, for example, a close-to-source microphone position is possible in which the direct sound is increased to a value approximately three times the level of the strongest reflected sound, the problems that are 'cured' by the use of barrier mounting will not exist in the first place. The closer position will provide higher output with less pick-up of room ambience. Such a position also allows the freedom to select microphones on the basis of other performance characteristics, such as directionality, transducer type, etc." 'nuff said?

For wireless applications, HME showed its new second-generation System 85, which uses a Shure SM85 condenser element. A mike-mute switch allows the performer to turn off the audio while maintaining the RF carrier link with the transmitter. The System 85 uses a 9-volt alkaline battery, and is said to be the smallest such hand-held microphone currently available.



Figure 4. HME's System 85 Hand-held Wireless Microphone System.

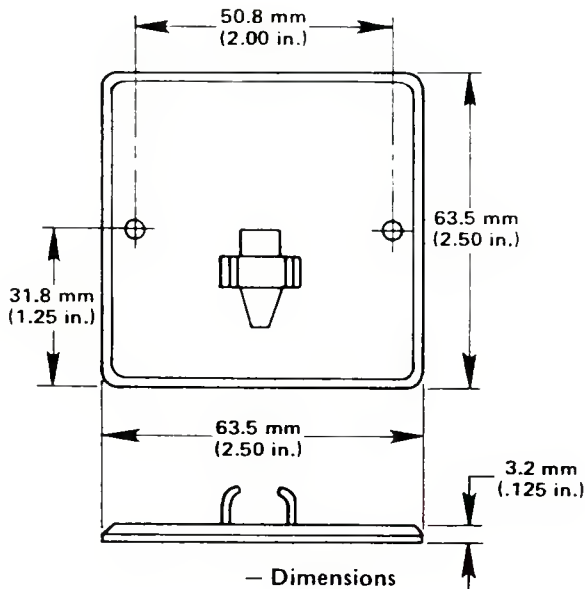

Figure 3. The Electro-Voice model 370 Barrier Adapter Plate.

CONSOLES

Automated Processes is (are?) back, and it looks like it's here to stay, which should delight all those API fans who wouldn't sell their 550 equalizers for any amount of money. The company—now known as API Dataronix—is a subsidiary of Atlantic Research Corporation. Seen at the show was the series 4024 Gold Seal recording console, which looks and feels like a new version of an old friend. Bucking the trend towards one-piece I/O modules, the 4024 uses all-discrete components, housed in several removable modules, which of course include the API 550A equalizer.

Sound Workshop demonstrated its Diskmix Automation Storage/Editing System, which is not an automation system. But you just said it's... No, I didn't. I said it's an automation *storage/editing* system, and as any fool (who has the literature spread out in front of him) can tell, there's a difference. An automation system is... well, an automation system. (Remember, you read it here first.) The first-generation systems—for example, MCI JH-50, Allison (now Valley People) 65K, Sound Workshop ARMS—all used the multi-track tape itself to store the automation data. Needless to say, this tied up a couple of tracks—or more, if you wanted to keep several versions.

Meanwhile, the state-of-the-art has moved towards the disk-based storage system, which is where Diskmix comes in. Its dual-drive floppy-disk system quickly interfaces with the above tape-based (formerly) systems, allowing the user to enjoy the convenience and flexibility of disk-based automation, without having to buy an entirely new automation package. In short, you use the automation system you already have, and then use Diskmix for storage/editing purposes.

The Diskmix system includes an IBM PC (Personal Computer, for those who have been in Albania for the last year). Simple, huh?

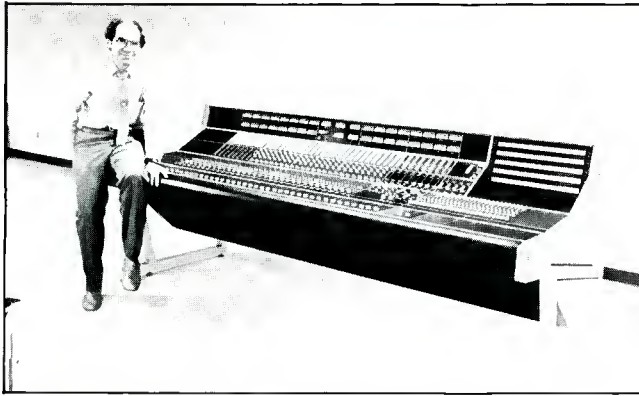

Figure 5. The new API/Datatronix Gold Seal series 4024 Recording Console.

Almost in production at Audiotronics is a new programmable equalizer, demonstrated at the convention in an advanced photo-type package. Each equalizer will have three bands with variable Q in ten programmable steps, and 12 programmable frequency steps. There will be 15 dB of boost or cut available, in 17 programmable steps, and 16 memories will provide on-board storage, with a built-in battery for power-off memory. An RS-232 interface will be included for interface with an external computer. It's all yours in early 1983.

Also of interest is the Audiotronics 201-PEQ "Personality" Equalizer, which is available as an accessory for the 200 series On-air Broadcast Console. This is a five-band graphic equalizer, whose settings are made, and stored, on a removable plug-in card. The cards may be purchased in quantities, with a different one assigned to each broadcast personality, allowing such notables to carry their own equalization with them at all times.

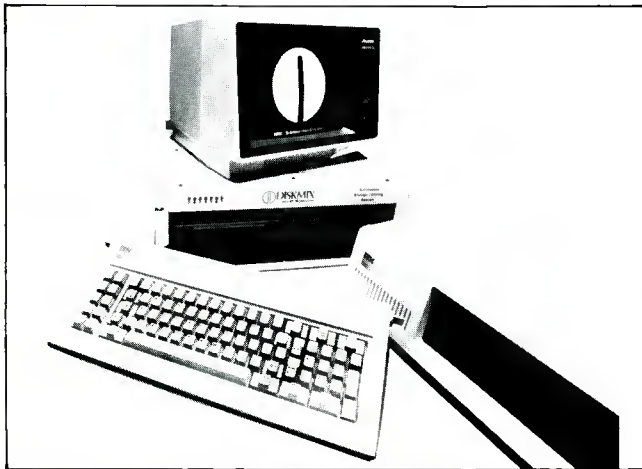

Figure 6. The Diskmix Automation Storage/Editing System.

By the way, Audiotronics has recently been appointed as the North American distributor for RTW peak program meters.

A convention highlight was the drawing at the Yamaha booth for six of their much-coveted Motorcycle jackets (bike not included). Thanks to Martin Galley, publisher of RE/P Magazine, for pulling my winning ticket out of the bowl! (Maybe he'll get me the bike for Christmas.)

In addition to the jackets, Yamaha introduced the RM1608 mixer, specifically designed for recording applications. A front-panel patch bay provides a pair of insertion points for each of the 16 input channels, a feature not often found on boards of this size. At the back of the bus, each of the eight line outputs appears at both a high-level (+4 dB) quarter-inch phone jack, and a low-level (-10 dB) RCA phono jack. Phantom powering is switch selectable on each input channel.

While Yamaha expands into the recording studio market, MCI/Sony moves into the compact console market with the

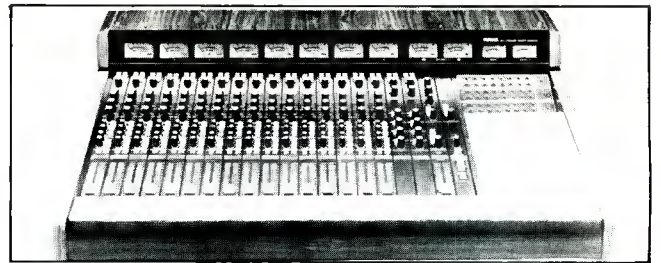

Figure 7. The Yamaha RM1608 Recording Mixer.

JH-800 portable 12-input board with dual-stereo mix buses, fluorescent bar-graph meters, balanced transformerless line and microphone inputs, and two built-in stereo compressor/limiters. According to MCI/Sony president "Jeep" Harned, the JH-800 has been designed for location recording, remote broadcasting, and video production centers.

DIGITAL AUDIO

Meanwhile, on the Sony side of the street (sorry!), there was the Sony Digital Audio Theatre (or Theater, depending on which page of the brochure you read). There, Sony engineers regaled the press—and later, the entire convention—with digital audio below the threshold of pain (but not by much).

According to some program notes by David Goggin, Sony PCM-1610 digital audio processors and BVU-800 U-matic VTRs were used for the film soundtracks on "Poltergeist" and "Star Wars," after the magnetic transfers were made. The Sony demo featured excerpts from these films, along with "Kenny Loggins Alive," which was recorded for television on 30 ips analog and mixed down through the PCM-1610. All of this was presented on four channels of JBL 4435 monitors, with ambience provided by a DDU-1520 digital delay line.

Video was handled by a BVH-2000 one-inch VTR and a ceiling-mounted color video projection system. For once, theater audio eclipsed theater video. I suspect the projection system was being pushed to its limit to cover the Sony theater, while no doubt the digital audio system was only just coasting.

The presentation (made possible by a grant from the Nick Morris Foundation) was conceived by Sony's Rick Plushner to demonstrate the complete range of technology that is available for film, television and recording industry audio.

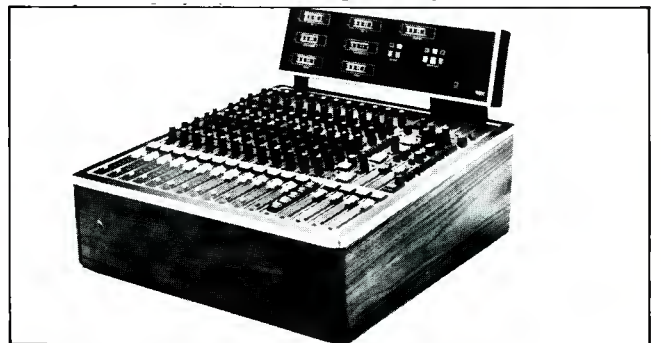

Figure 8. The MCI/Sony JH-800 Compact Console.

Just down the hall from the Sony Theater, dbx introduced its answer to the high cost of digital audio—the dbx 700 Digital Audio Processor, for use with a professional-quality VCR. The system uses a modified Delta-modulation encoding scheme, which dbx has dubbed "Companded Predictive Delta Modulation," or CPDM for short. According to dbx, CPDM begins by raising the inherent 55 dB dynamic range limit of plain-ole DM to 70 dB. This is done by a "linear prediction" circuit which estimates the signal's future amplitude by analyzing its recent past history. This is also said to help avoid audible noise modulation effects. The dynamic range is further boosted to 110+ dB (!) by a companding system.

dbx vice president Jerome Ruzicka reminded the press of some of the subjective criticisms that have been leveled against digital audio, including the speculations about the effects—if any—of anti-aliasing filters in the just-above 20 kHz region. Without passing judgement on this, Ruzicka noted that the

CPDM's sampling rate is about 700 kHz, which obviates the need for complex filtering, with its attendant phase shifts. The dbx 700 is expected to sell for just under \$5,000.

SIGNAL PROCESSING

MicMix has added the XL-404 Plate Synthesizer reverberation system to its line of signal processing devices. The XL-404 takes up 5¼ inches of rack space and, as the name suggests, was designed to synthesize the characteristics of a plate-type system. It offers two-channel processing, with a decay range from 1 to 4 seconds. Four-band equalization is provided, with 12 dB reciprocal peak/dip at 150 Hz, 600 Hz, 2 kHz and 6 kHz.



Figure 9. The dbx 700 Digital Audio Processor.

Orban's new programmable Parametric Equalizer has two channels, four bands per channel, and can store as many as 32 different settings of equalization, high- and low-pass filtering, and level in its non-volatile memory. All adjustments are made by three potentiometers, whose specific functions vary, depending on programming instructions executed by a series of key switches. First, the user decides to operate on left or right channels (or on both). Next, one of four bands is selected, and the function of each potentiometer is defined. All of this is accomplished by touching a few switches. Finally, the three potentiometers are twiddled to adjust bandwidth or high-pass

cutoff frequency, center frequency or low-pass cutoff frequency, and boost/cut or input gain. An optional IEEE-488 interface will communicate with—what else?—a host computer. For \$3,000, it's yours (in the Spring of '83).

TAPE RECORDERS

The Stellavox TD 88 is a multi-purpose tape and film recorder, which will handle quarter- and half-inch tapes, as well as 16- and 17.5-mm films, at speeds of 3¾, 7½, 15 or 30 ips, and at 24 or 25 frames-per-second. The TD 88 will accommodate cine and NAB reels up to 14 inches in diameter, as well as film DIN and NAB hubs. Switching from one format to another requires a change of three components: the head block, plus left- and right-hand idler assemblies.

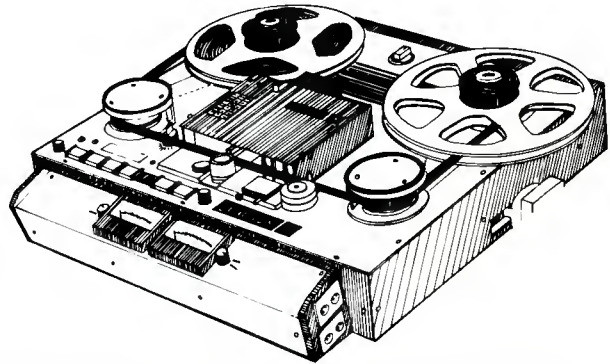

Figure 10. The Stellavox TD 88 Multi-purpose Tape and Film Recorder.

An accessory meter bridge containing input and output controls mounts onto the front of the transport, and a heavy-duty cart containing a 24-volt, 65-ampere-hour battery and charger is available. ■

Convention Report Manufacturers

API Datatronix

2100 Reston Avenue
Reston, Virginia 22091
(703) 620-5300

Auditronics, Inc.

3750 Old Getwell Road
Memphis, Tennessee 38118
(901) 362-1350

Bruel & Kjaer Instruments, Inc.

185 Forest Street
Marlborough, Massachusetts 01752
(617) 481-7000

Countryman Associates, Inc.

417 Stanford Avenue
Redwood City, California 94063
(415) 364-9988

dbx, Inc.

71 Chapel Street
Newton, Massachusetts 02195
(617) 964-3210

Electro-Voice, Inc.

600 Cecil Street
Buchanan, Michigan 49107
(616) 695-6831

HM Electronics, Inc.

6151 Fairmount Avenue
San Diego, California 92120
(714) 280-6050

MCI/Sony

1400 Commercial Boulevard
Fort Lauderdale, Florida 33309
(305) 491-0825

MicMix Audio Products, Inc.

2995 Ladybird Lane
Dallas, Texas 75220
(214) 352-3811

Orban Associates, Inc.

645 Bryant Street
San Francisco, California 94107
(415) 957-1067

Shure Brothers, Inc.

222 Hartrey Avenue
Evanston, Illinois 60204
(312) 866-2553

Sony Professional Products

Sony Drive
Park Ridge, New Jersey 07656
(201) 930-1000

Sound Workshop Professional Audio Products, Inc.

1324 Motor Parkway
Hauppauge, New York 11788
(516) 582-6210

Stellavox USA

c/o John Mosely
P.O. Box 38795
Hollywood, California 90038
(213) 273-4100

Syn-Aud-Con

P.O. Box 669
San Juan Capistrano, California 92693
(714) 496-9599

Yamaha International

Combo Products Division
P.O. Box 6600
Buena Park, California 90622
(714) 522-9134

New Products

ATTENUATOR PADS

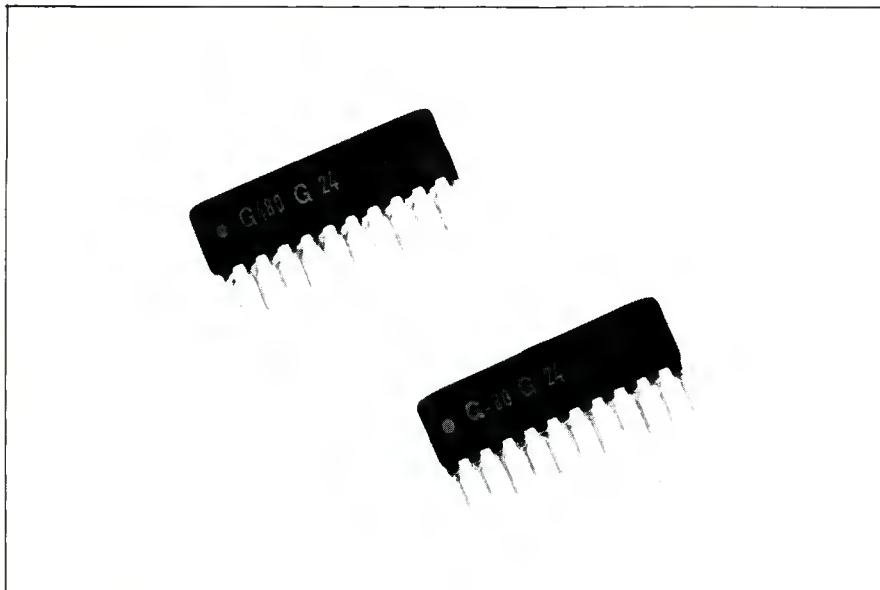

• Thick film resistive attenuator "T" pads are now available from the Electronic Components Division of Panasonic Industrial Company. Designated as "Type EXB-GM15480G," the pads come in SIP (single inline package) plastic enclosures. They are particularly suited for application in various communication circuits where signal levels must be attenuated. Attenuation levels can be set by the user between 0.5 and 15.5 dB in steps of 0.5 dB. Thus, the EXB-GM15480G attenuator provides the ability for close signal-level control

in a relatively small package. Each unit is only 29 mm long, 2.54 mm thick, and 13.2 mm high, including pins. Major specifications include input and output characteristic impedance of 600 ohms; attenuation tolerance of ± 2 percent or ± 2 dB, whichever is greater; frequency response up to 10 kHz, flat; maximum applied voltage of 1 volt, and operating temperature range of -55 to $+125$ degrees C.

Mfr: Panasonic
Price: \$1.40 in 1000 lots
Circle 36 on Reader Service Card

CONSOLE

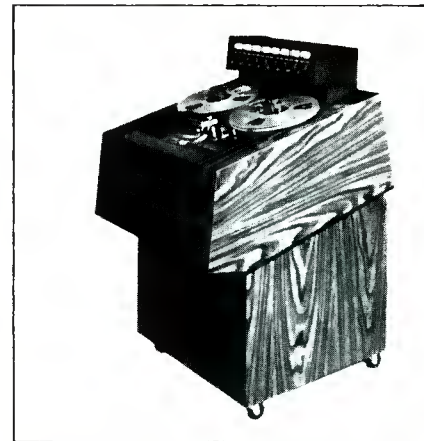

• The Ruslang Corporation has introduced an RL 400-A console which accepts the Otari 5050 Mark III/8 tape machine. The machine is simply dropped right in place, using its feet to locate the proper position and thus prevent movement. The new console features Ruslang's tilt design, enabling the operator to view all controls in either a sitting or standing position. The console measures 22 $\frac{3}{4}$ -in. wide, 33 $\frac{3}{4}$ -in. high (variable on request) and 27 $\frac{1}{2}$ -in. deep. The base has a standard 19-in. opening, where additional electronics can be mounted on optional mounting railings. A rear riser assembly, which accommodates an over-bridge for additional overhead rack space, is another option, as are rack rails for the top opening, enabling the operator to mount electronics other than the Otari unit.

Mfr: Ruslang Corp.
Circle 37 on Reader Service Card

DIGITAL PROCESSOR

• The PCM-42 Digital Processor, designed for musicians, performing artists and studios, features a delay of 2.4 seconds; 4.8 with memory option. Its crystal based delay timer accurately tracks all changes in delay times including time modulation sweeps. It has a metronome indicator and clock that can be programmed to a precise fraction of the delay period. The feature allows musicians to make creative use of long delay loops to generate tightly woven, multi-layered, rhythmic beds and completely new sound on sound effects. The PCM-42 has 16 kHz bandwidth, input overload protection, and Lexicon's proprietary digital encoding system. Its time modulation controls include an envelope follower that can be used alone or blended with either a sine or square wave sweep for enhanced doubling sounds, talking flange effects, unusual trills and pitch twisting effects. An unusual degree of control flexibility is provided for the on-stage entertainer by optional foot controls for infinite repeat, by-pass, delay sweep, recirculation and output mix functions.

Mfr: Lexicon
Circle 38 on Reader Service Card

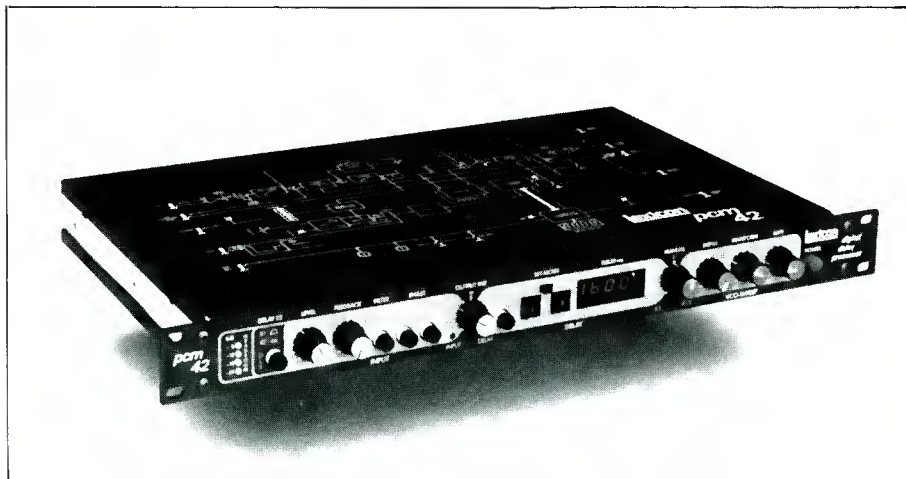

MIXING CONSOLES

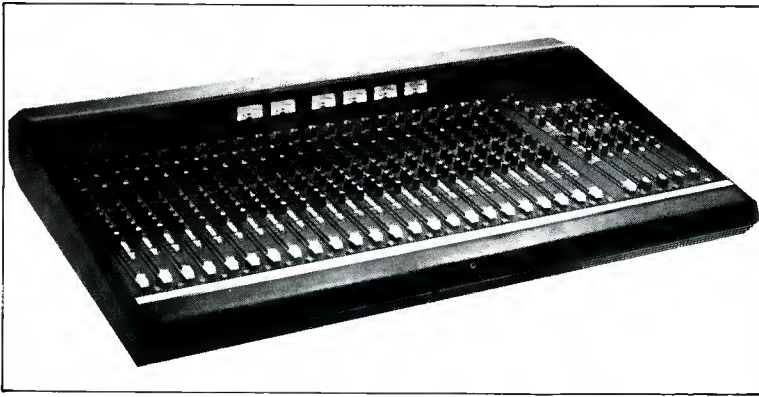

- The Series 400B general purpose mixing consoles are available in two formats and two sizes. Both formats are fully modular, include phantom power supply and feature 4-band sweep-frequency EQ. The Standard format, available with 16 or 24 inputs, features 4 auxiliary sends, 8-track monitoring, sub-grouping, a set-up oscillator and 100 mm ultra-smooth faders. The Monitor format, also available with 16 or 24 inputs, features 8 discrete mixes for on-stage monitor-mixing with a master channel level control, which can be assigned via a pan control to a stereo mix bus for side-fills or front of house mix.

Mfr: Soundcraft USA

Price: \$5,500 for 16 inputs models;

\$7,500 for 24 input version

Circle 39 on Reader Service Card

DIGITAL MULTIMETER

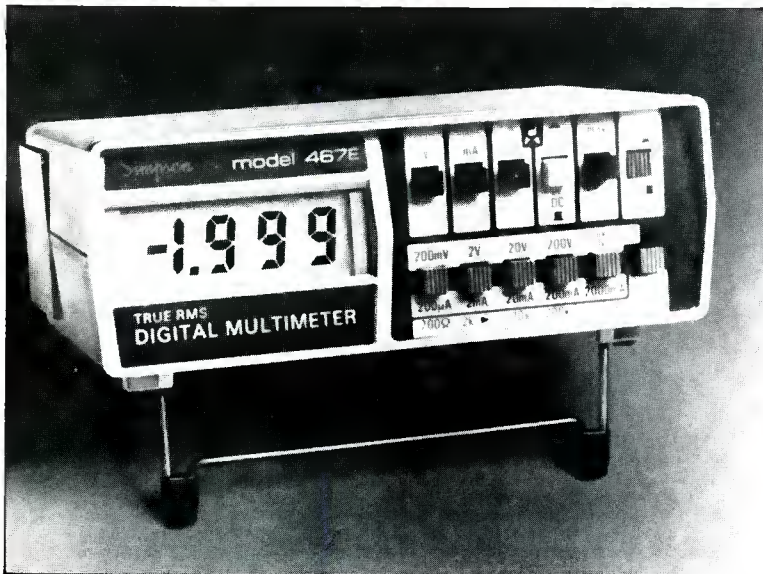

- The Model 467E is a new hand-portable LCD digital multimeter featuring peak hold to capture surge currents and voltages; a continuity mode to provide instant visual/audible checks for shorts and opens, and true RMS capability for more significant measurements of non-sinusoidal waveforms over a wide frequency range. The 467E has 26 ranges to provide full AC/DC voltage,

current resistance (including low power ohms) measurement capability. Additional features include 0.1 percent DC V accuracy, high-voltage transient protection, double fusing system and color-coded front panel graphics.

Mfr: Simpson Electric Company

Price: \$225.00

Circle 40 on Reader Service Card

TELEPHONE INTERFACE

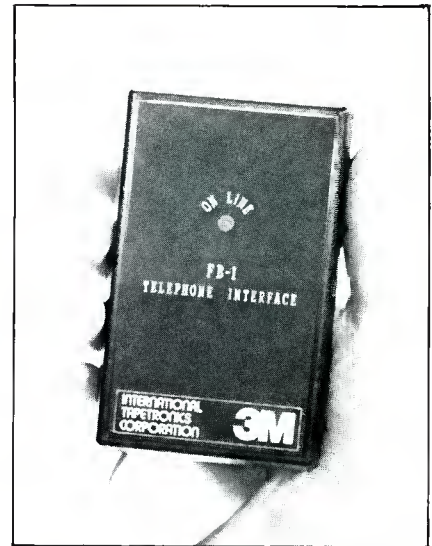

- The new FB-1 interfaces a telephone line with a cartridge machine, providing answer-only access to any taped information. The FB-1 answers by connecting callers to the cartridge machine. Then it starts the tape. When the pre-recorded message is over and the cartridge re-cues, the FB-1 hangs up and awaits another call. The FB-1 is FCC approved and ideal for selling long-term sponsorships of weatherlines, sports-phones, concert information, etc.

Mfr: International Tapetronics Corp./3M

Circle 41 on Reader Service Card



In general, spring reverbs don't have the best reputation in the world. Their bassy 'twang' is only a rough approximation of natural room acoustics. That's a pity because it means that many people will dismiss this exceptional product as "just another spring reverb". And it's not. In this extraordinary design Craig Anderton uses double springs, but much more importantly "hot rods" the transducers so that the muddy sound typical of most springs is replaced with the bright clarity associated with expensive studio plate systems.

Kit consists of circuit board, instructions, all electronic parts and two reverb spring units. User must provide power (± 9 to 15 v) and mounting. (reverb units are typically mounted away from the console).

CHARGE TO VISA OR MC TOLL-FREE

1-800-654-8657 9AM to 5PM CST MON-FRI

DIRECT INQUIRIES TO:

RAA Electronics, Inc.

Dept. ICD, 1020 W. Wilshire Bv. Oklahoma City, OK 73116 (405) 843-9626

Send the 6740 REVERB KIT \$59.95 plus shipping (\$3) enclosed or charged.

Send Free Catalog

name _____

address _____

city _____ state _____ zip _____

Circle 34 on Reader Service Card

POWER DESOLDERING SYSTEM

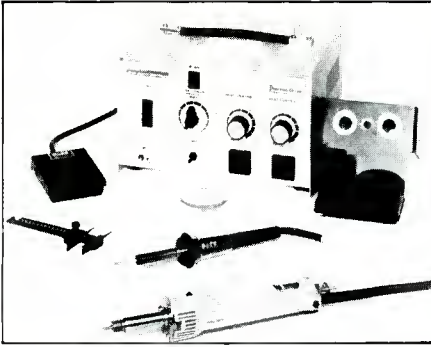

• The Model SX-301 is a self-contained, spike-free power desoldering/soldering system. The system contains two variably controlled polarized outputs for temperature level control, zero power switching for safe ESD operation, a fast-rise vacuum pump with fixed vacuum outlet, a variable pressure outlet for pressure, hot-air jet operations and easy foot pedal control switch. The unit is corrosion-proof and is shock-mounted for vibration isolation.

Mfr: Pace

Circle 44 on Reader Service Card

DISTORTION AND NOISE MEASURING SYSTEM

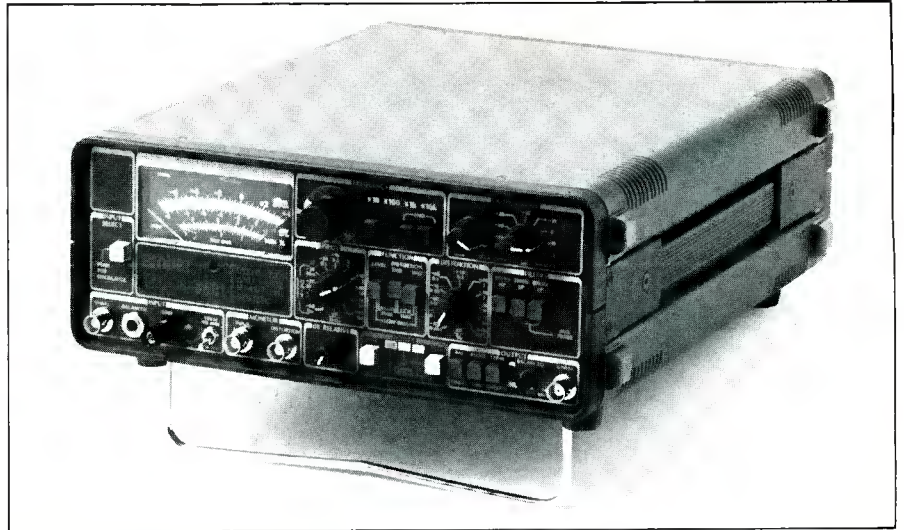

• The model 3501 is a high performance, comprehensive audio distortion and noise measuring system. Total harmonic distortion measurements can be made to below 0.0008 percent (-102 dB) and noise measurements to below -120 dBm. The built-in generator can deliver up to +30 dBm to a 600 ohm load over the instrument's frequency range of 10 Hz to 100 kHz. Offering automatic operation and fast settling time, the 3501 can be configured with a fully balanced input and output to interface to telecommunication, broadcast and professional audio equipment. Four noise weighting filters

can be selected from a wide library of weighting curves to meet various international noise measurement standards. Unique features include a frequency selective voltmeter mode for manual spectrum analysis and a variable bandwidth mode for signal-to-noise measurements. An optional Intermodulation Distortion measurement capability permits twin-tone distortion measurement to SMPTE, DIN, CCIF and IHF recommendations from 2 kHz to 100 kHz.

Mfr: Amber Electro Design Inc.

Price: From \$21,000.00

Circle 43 on Reader Service Card

CONDENSER MICROPHONE

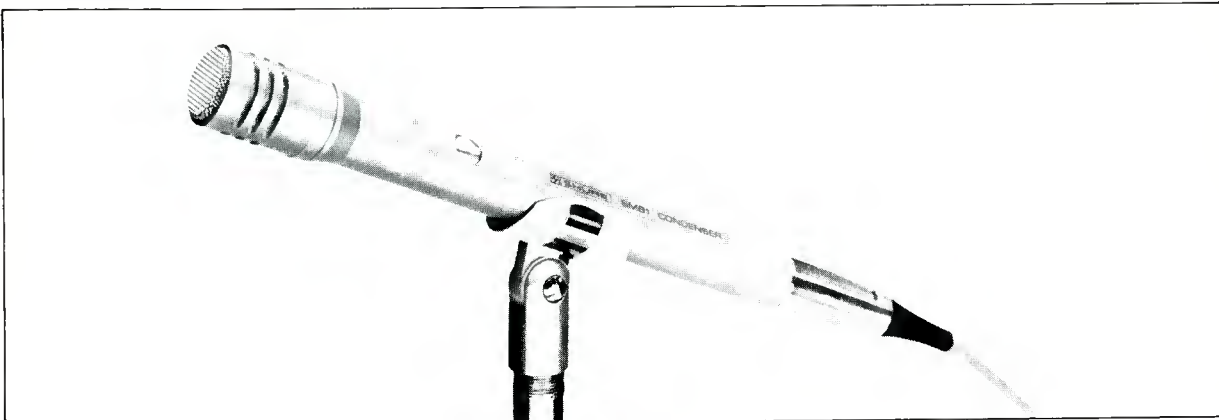

• Shure's SM81 condenser microphone is now available with a built-in omnidirectional cartridge. The new model, the SM80, has an omnidirectional pickup pattern that is sensitive to sounds from all directions. And because it's an omni, there are no problems with proximity effect. A selector switch permits any one of three low-frequency responses to be selected to match the application (broadcast, recording, sound reinforcement, etc.). The microphone also contains an adjustable 10 dB attenuator pad to allow

use with very high SPL signals. The SM80 features a unique backplate structure designed to maximize signal-to-noise ratio and insure long-term change stability and is available in two versions: SM80-LC (without cable) and SM80-CN (with cable with 3-pin professional audio connector).

Mfr: Shure Bros.

Price: \$327.00 for the SM80-LC;

\$348.00 for the SM80-CN

Circle 42 on Reader Service Card

CONSOLE ACCESSORIES

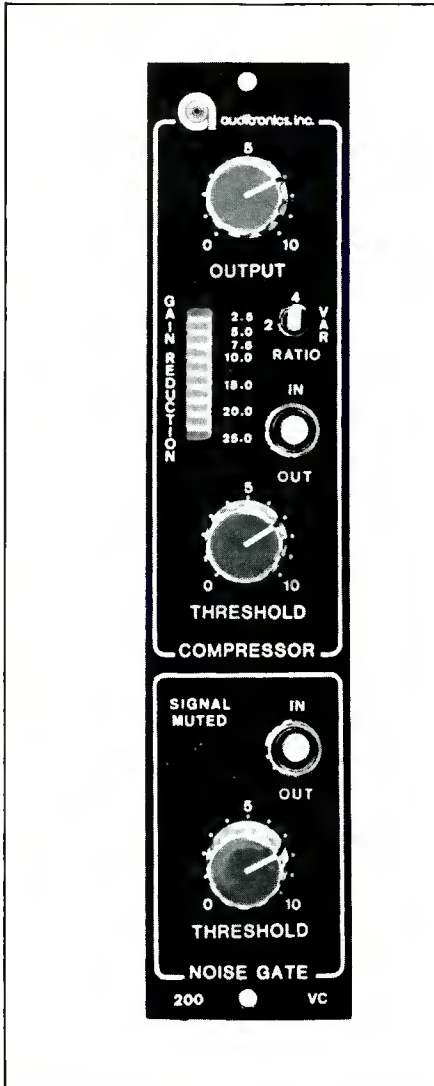

• Audiotronics has announced the availability of two new accessories for their 200 Series On-Air Broadcast Consoles: the 200-VC Voice Controller and the 200-TEL Telephone Interface Module. The 200-VC provides independently controlled Noise Gate and Compressor/Limiter functions. Capable of being used with either a monophonic microphone or a stereo line source, the Voice Controller provides user-accessible compression ratio, threshold, and output level controls as well as a built-in gain reduction indicator. Internal adjustments are provided for independent presets of attack and release times for both the Noise Gate and Compressor/Limiter sections. The 200-TEL module allows interface to telco lines via any commercially available hybrid. In addition to providing incoming bandpass filtering and level control, local announcer microphone switching, mix-minus capability, and cue and monitor feeds, the 200-TEL includes a stereo line level output for tape recorder feed.

Mfr: Audiotronics, Inc.

Price: 200-VC: \$450.00;

200-TEL: \$500.00

Circle 45 on Reader Service Card

PHANTOM POWER SUPPLY



• The Crown PH-4 system supplies 48 volts of D.C. phantom power for all types of microphones. The PH-4 system consists of a master unit (PH-4) with connections for up to four microphones, plus slave units (PH-4S), each of which adds capability for another four mics. The slaves are daisy-chained with cables supplied by Crown. A master PH-4 unit will supply up to 100 milliamps of current, enough to power up to about 12 condenser mics, or up to about 20 PZM models. Both master and slave units are contained in a light-weight aluminum chassis. All connections (in and out for four microphones per unit) are three-pin XLR. A line cord is supplied for 110/120 VAC connection. The units do not include an on/off switch, but show power-on status through a front panel LED.

Mfr: Crown

Price: \$179.00 for PH-4;

\$129.00 for PH-4S

Circle 46 on Reader Service Card

STL

PRECISION



MAGNETIC TEST TAPES

STANDARD TAPE LABORATORY, INC.

26120 EDEN LANDING ROAD #5, HAYWARD, CALIFORNIA 94545 • (415) 786-3546

RECORDING CONSOLE

• The SPECKMIX 16 is a 16 input, 8 output recording console designed for professional and semi-professional 8-track studios. The console features 16 complete input channels employing low noise transformerless mic inputs, 8 mixing buss outputs, 8 VU meters and 8-track panable assign. Equalization is provided by six 3-band equalizers. Facilities are provided for control room and studio talkback, playback and cue prompts. In addition, there is an independent stereo mixdown buss. The frequency response on the SPECKMIX 16 is 23 Hz-20 kHz (± 1 dB). The output level is +4 dBm with the maximum output level at +22 dBv. Noise ratings are -72 dB measured from mic input to buss output, and -80 dB measured from line input to program output.

Mfr: Speck Electronics

Price: \$3,975.00

Circle 47 on Reader Service Card

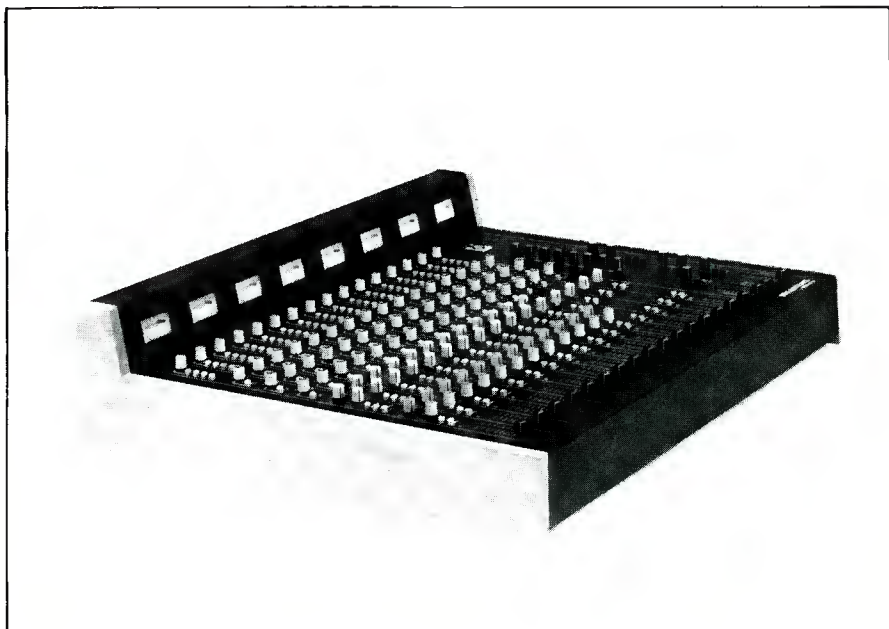

AUDIO POLLUTION CONTROL

• The Super Isolator has been designed to control electrical pollution. Heavy duty spike surge suppression is coupled with 3 individually dual balanced-Pi filtered AC sockets. The Super Isolator will control pollution for an 1875 watt load. Each socket handles a 1 KW load.

Mfr: Electronic Specialists, Inc.

Price: \$104.95

Circle 48 on Reader Service Card

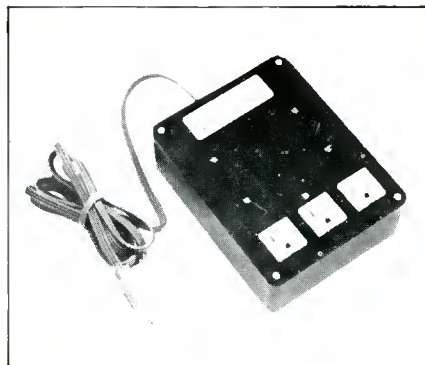

DIGITAL DELAY

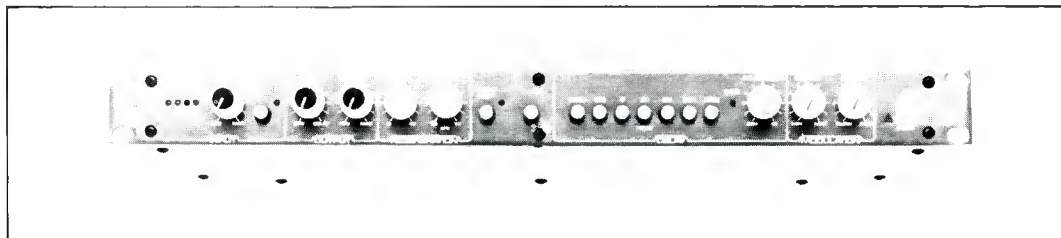

• The D1280 Digital Delay, a full functioned delay processor designed for both live performance and studio use, produces delay lines from a short 0.156 ms to a long 1280 ms, all at a full 15 kHz bandwidth. Seven Delay range push-buttons and the Delay Multiplier control allow access to any delay setting. A flashing LED slows its "blink" rate as the delay time is increased, providing a method of matching the delay time to tempo for accurate setting of echo repeat

rates during performance. For producing special effects, the D1280 has Regeneration, Modulation, and Repeat Hold features. The Regeneration Hi-Cut control reduces the high frequency content in the fed back signal for a natural decay, and is variable between 15 kHz to 1.0 kHz. The Modulation section has a Depth control which sweeps the delay time up to a 4 to 1 range while the Speed control varies the sweep rate from a smooth 25 seconds to a fast 0.1 second

for a complete sweep signal. The Repeat Hold feature allows the entertainer to lock-in up to 1280 ms musical segment and repeat it indefinitely for background rhythm effects. Options include the FS-2 Footswitch for Effect and Repeat Hold In/Out and a 240 VAC power supply.

Mfr: ADA Signal Processors

Price: \$799.95

Circle 49 on Reader Service Card

Classified

Closing date is the fifteenth of the second month preceding the date of issue.

Send copies to: Classified Ad Dept.
db THE SOUND ENGINEERING MAGAZINE
 1120 Old Country Road, Plainview, New York 11803

Minimum order accepted: \$25.00

Rates: \$1.00 a word

Boxed Ads: \$40.00 per column inch

db Box Number: \$8.50 for wording "Dept. XX," etc.

Plus \$1.50 to cover postage

Frequency Discounts: 6 times, 15%; 12 times, 30%

ALL CLASSIFIED ADS MUST BE PREPAID.

FOR SALE

REELS AND BOXES 5" and 7" large and small hubs, heavy duty white boxes. **W-M Sales, 1118 Dula Circle, Duncanville, Texas 75116 (214) 296-2773.**

EQUIPMENT FOR SALE: MCI 24 trk w/ autolocate, 2 MCI JH-110 2 trks., Dolby M-24, 361's limiters, delay lines, arcade games, misc. equipment. **Contact Al, (213) 980-5605.**

TOOGOOD 6-SLAVE, full-track high speed reel tape duplicator. Mint condition, \$2700. Music/sound effects library, 1200+ LP's, 78's, reel tapes. CBS-EZQ, capitol Hi-Q, DeWolfe, Southern, others. (312) 584-5463 early/late.

PRO AUDIO IN STOCK ready to ship. Top lines, top dollar trade-ins, clearance specials. Call or write for our prices. **Professional Audio Video Corporation, 384 Grand Street, Paterson, NJ 07505 (201) 523-3333.**

FREE 32pg Catalog & 50 Audio/Video Applic.



PWR SUPP. EQ.
PHONO, MIC.
TRANS. ACN.
TAPE, VIDEO.
LINE, OSC.

Stereo/Mono Pre Ampl.

8-in/2-out, 12-in/4-out, 16-in/4-out
Video & Audio Dist. Amps. TV Audio & Recd Prod Consoles

OPAMP LABS INC (213) 934-3566
1033 N Sycamore Av LOS ANGELES CA, 90038

ORBAN and LEXICON. All products in stock. FOR IMMEDIATE DELIVERY. **UAR Professional Systems, 8535 Fairhaven, San Antonio, TX 78229. 512-690-8888.**

USED RECORDING equipment for sale. **Dan (415) 441-8934.**

SNAKES AND CABLES, 100 ft. 16 plus 3 channels, XLR connectors, stage box, highest quality components \$330.00. Mic cables \$12.00 and up. Coax cables, multi-cables, Mic cables, any length or connectors including AMP multi-pin available. **Auburn Corp. (301) 459-1959.**

PROFESSIONAL AUDIO EQUIPMENT

Shop for pro audio from N.Y.'s leader, no matter where you live! Use the Harvey Pro Hot Line (800) 223-2642 (except N.Y., Ak. & Hi.). Expert advice, in-depth parts dept., 3/4" video systems available. Broadest selection such as Otari, Quad Eight, Soundcraft, Tascam and more. Write or call for price or product info:

Harvey Professional Products Division
 25 W. 45th Street
 New York, NY 10036
 (212) 921-5920

MCI JH24B, JH100 16 track, locator, mint \$13,500.00. Electrodyne 16x8 console, \$3,500.00. Ampex AG 440, 7.5, 1/2 tk., \$1,800.00. **(513) 258-2463.**

THE LIBRARY... Sound effects recorded in STEREO using Dolby throughout. Over 350 effects on ten discs. \$100.00. Write **The Library, P.O. Box 18145, Denver, Colo. 80218.**

CUSTOM LENGTH CASSETTE BLANKS made to order featuring AGFA, Scotch, and Magnetic Media tape, any length from C-2 through C-122. For pricelist write **M & K Recordings, Box 195d, Mt. Morris, MI 48458 or call (313) 687-7610.**

ROCKET STUDIOS—All inventory, Teac 90-16, Pioneer 4-2 track, Allen-Heath modified 16 x 8 x 16, Neumann, Ecoplate, AKG, much more, complete studio \$50,000. **(303) 567-2965, (303) 526-1881.**



ACOUSTIC TEST INSTRUMENTS
 USE TO ADJUST EQUALIZERS, OPTIMIZE SPEAKER PLACEMENT, ETC.

Complete Test Set	\$449
Calibrated Sound Level Meter	\$199
Fractional Octave Pink Noise Generator	\$339
Handbook on Acoustic Testing	\$10

Free broch: HALL ENGINEERING, Dept. E5
 P.O. Box 506, Martinsville, NJ 08836
 (201) 647-0377

— ANNOUNCING —
**“LOUDSPEAKER ARRAYS —
 A GRAPHIC METHOD OF
 DESIGNING”**

Now the design of loudspeaker arrays is as easy as the design of the rest of the sound system. Our method is easy to use, is fast and accurate!

We will design your array or do any of the steps you don't want to do in the array design process.

Either way, you end up with a description of the array, and drawings from as many views as you want.

Call
 or write: **(612) 871-6446**

*  **north star sound UMBULUS**
 1406 First Avenue South
 Minneapolis, MN 55403
Thomas McCarthy, Chief Engineer

BLANK AUDIO AND VIDEO CASSETTES direct from manufacturer, below wholesale, any length cassettes: 4 different qualities to choose from. Bulk and reel mastertape—from ¼-inch to 2-inch. Cassette duplication also available. Brochure. **Andol Audio Products, Inc., Dept. db, 42-12 14th Ave., Brooklyn, NY 11219. Toll free 1-800-221-6578, ext. 1, NY residents (212) 435-7322.**

LARGE STOCK OF CETEC/ELECTRO-DYNE 711 and 712 input modules, assignment modules, and fully loaded console mainframes. At incredibly low prices. Modu-Trend Industries (203) 872-7750.

FOR SALE AKG C-24 and other tube type condenser mics. (415) 441-8934 or 527-6167.

THE RECORDING BOOK that is rocking the music industry. "Practical Techniques for the Recording Engineer" by Sherman Keene is endorsed by major colleges, universities, recording schools, studios, musicians and our correspondence students around the world. Recommended by reviewers of the MIX, Re/P, Guitar Player and other top publications. The book—hard cover, 380 pages, 28 chapters (4 on computer assisted mixing), illustrations. \$29.75 (\$31.69 in Calif.) + \$2.50 shipping. The Correspondence Course—certificate course using two textbooks, corrected and graded homework, cassette dialog with the author via cassette. Basic, Intermediate and Advanced Levels. The Curriculum—for schools only, Teacher's Manual (lesson plans for two textbooks, charts, suggested session content), Student's Workbook, Final Exams. For information or to order contact **S.K.P. 1626 N. Wilcox No. D-677, Hollywood, CA 90028.** Order by phone using Visa or MasterCard by calling **(213) 708-2933.**

KEPEX AND GAINBRAINS: For sale, 8 Allison Kepex and 4 Gainbrains rack mounted with power supply card. **(212) 242-2100, Paul.**

FOR SALE: MCI JH-114 24 TRACK tape recorder with AL/II. Well maintained, good condition. \$19,500. Also for sale; 16-tr heads, 8-tr heads, spare parts. **Bee Jay Recording Studios, (305) 293-1781.**

FOR SALE: BX-20 REVERB with remote, mint condition, asking \$2400.00 or best offer, **call Bernie at (201) 359-5520.**

FOR SALE: YAMAHA PM-1000-16 console, w/supped-up EQ & roadcase. 4 Altec 604-HPLN spks. **Call Marty (716) 352-9597 after 5 PM.**

WANTED

WANTED: TRANSCRIPTION discs, any size, speed. Radio shows, music. **P.O. Box 724—db, Redmond, WA 98052.**

SERVICES

ACOUSTIC CONSULTATION—Specializing in studios, control rooms, discos. Qualified personnel, reasonable rates. Acoustilog, Bruel & Kjaer, HP, Tektronix, Ivie, equipment calibrated on premises. Reverberation timer and RTA rentals. **Acoustilog, 19 Mercer Street, New York, NY 10013 (212) 925-1365.**

MAGNETIC HEAD relapping—24 hour service. Replacement heads for professional recorders. **IEM, 350 N. Eric Drive, Palatine, IL 60067. (312) 358-4622.**

Copies of db

Copies of all issues of db—The Sound Engineering Magazine starting with the November 1967 issue are now available on 35 mm. microfilm. For further information or to place your order please write directly to:

**University Microfilm, Inc.
 300 North Zeeb Road
 Ann Arbor, Michigan 48106**



Have you misplaced your **db** again? Our high quality, royal blue vinyl binders keep 12 copies of **db** neat and handy for ready reference.

Just \$9.95, available in North America only. (Payable in U.S. currency drawn on U.S. banks.) **ORDER YOURS NOW!!**

Sagamore Publishing Co., Inc.
 1120 Old Country Road
 Plainview, NY 11803

YES! Please send **db** binders @ \$9.95 each, plus applicable sales tax. Total amount enclosed \$

Name
 Company
 Address
 City
 State Zip

People..Places..

- **WVAH-TV** (Channel 23), serving Charleston-Huntington, W. Va., has begun broadcasting, following installation of a new **RCA** transmitter and antenna. The station, owned and operated by **West Virginia Telecasting Inc.**, is the first commercial independent station in the Charleston-Huntington market. WVAH-TV also initiated service with studio equipment and cameras purchased from RCA's Commercial Communications Systems Division. Valued at \$2.5 million, the equipment purchased by West Virginia Telecasting, included: an RCA TTU-110C 110-kilowatt transmitter, a TFU-28DAS antenna, a **Grass Valley** 1600-4S switcher, two TK-44 color television cameras, a TK-28A telecine camera, two TP-66, 16-mm telecine projectors, a TP-7, 35-mm slide projector, two TR-600 quadruplex video tape recorders, and a TCR-100 video tape cartridge machine.

- The Professional Digital Audio Division of **Mitsubishi Electric** has relocated to newer quarters in Piscataway, New Jersey. The move is expected to bring the firm's recording studio equipment in closer proximity to their New York area clients. Digital Audio joins the firm's Robotics and Consumer Electronics Divisions, where the firm also maintains regional sales and warehousing operations. All sales and service for the digital audio line will be headquartered here as of October 1, 1982. The new address for Mitsubishi's Digital Audio Division is: 110 New England Avenue West, Piscataway, New Jersey 08854.

- **Guy Spellman** has joined **Reeves Sound Shop** as marketing director. In this capacity he will have overall responsibility for all sales efforts, advertising and promotion for the sound facility. Spellman comes to The Sound Shop with a multi-faceted entertainment background. He served as a marketing consultant with **Inner City Broadcasting's** Apollo Theater Network and worked nine years with **CBS, Inc.** At **CBS' Columbia Records** he was a product marketing manager for two years and, prior to that, a business development planning analyst. Spellman also worked extensively with film and videotape production as an assistant program executive in CBS-TV's Feature Film area and as an associate producer and production manager for **Varied Directions, Inc.** production company in New York.

- **Norio Ohga**, the newly named president and chief operating officer of **Sony Corporation**, Tokyo, was elected Chairman of the Board of Sony Corporation of America following a special meeting of the Board of Directors, it was announced by **Akio Morita**, Sony Chairman and CEO. Mr. Ohga joined Sony in April, 1953 and was named general manager, Tape Recorder Division and Product Planning Division in October, 1969. He was named managing director in 1972 and was promoted to Senior managing director in 1974. He was named deputy president in January, 1976. Mr. Ohga also serves as a Representative Director and Chairman of the Board of **CBS/Sony** in Japan.

In other Sony news, former White House communications specialist **Merrill Sheldon** has joined the Sony Professional Audio engineering staff. The announcement was made by **Nick Morris**, general manager of the Sony division. Mr. Sheldon's talents will be utilized by Sony in a unique way. He has been specially trained to service wireless mics and conference set-ups for the Sony Communications System. Sheldon travels on-site wherever necessary to make repairs; otherwise, servicing takes place at Sony's Compton, CA facility.

- The appointment of **Thomas W. Zoss** to the position of advertising manager has been announced by **Robert D. Pabst**, president of **Electro-Voice, Inc.** Zoss will be responsible for advertising and sales promotion activities for Electro-Voice and **EV/TAPCO** products.

- **Hans Batschelet** has been appointed vice president for Marketing at **Studer Revox America**, according to an announcement by the company's president, **Bruno Hochstrasser**. Batschelet will be primarily responsible for the marketing of Studer professional recording and broadcast audio products in the United States. A Swiss native, Batschelet previously served as Sales and Marketing Director for the **Videlec** division of **Brown Boveri**, a highly diversified Swiss manufacturer and distributor of electric and electronic equipment. Videlec specializes in manufacture of electronic display systems utilizing LCD's.

- **The National Association of Broadcasters** has filed comments on a petition for rule making that would allow a low power wireless video system to operate in the frequency spectrum allocated to UHF television channels 14-20. NAB strongly opposed the petition on the grounds that the proposal "creates a very real potential for radio-frequency interference with television reception." NAB stated that the proposal by **RF Power Labs, Inc.** "could cause interference not just to the channel on which the device is operating, but to many other UHF channels as well." Citing the pending approval of hundreds of low power television stations, NAB said that the proposed system "could result in the creation of interference to the public's reception of a potentially large number of operating television stations in order to provide a wireless security system for a relatively small number of users."

- **Charles W. Gushwa** has been appointed marketing manager for **Crown International**, according to **Max W. Scholfield**, president of the Elkhart, Indiana manufacturer of electronic audio-range components. Gushwa will be responsible for the selling, marketing and promotional activities of the home audio, professional and industrial divisions of the company.

- **Harrison Systems, Inc.**, the Nashville-based audio console manufacturer, has announced that **Dave Purple**, former sales manager at Harrison, has rejoined the organization as its sales and marketing manager for broadcast products. Dave Purple will work out of Nashville, in support of Harrison's group of manufacturer's sales representatives located throughout North America. In addition, he will directly represent Harrison in the teleproduction and broadcast markets in the southeastern and southwestern United States.

.. & Happenings

The French Connection



A look at the control room of the Ofredia audio production company.

• **Ofredia** is a small audio production company located in the center of Paris, France. They offer personalized news coverage and features that can be had on tape, cassettes, or special high-quality phone lines.

Among their clients is **National Public Radio** with its 270 member stations. News spots, stories, features and documentaries on all aspects of life in France (social, cultural, political) are sent or fed to NPR by cassette, tape, or phone. As of January, 1983, **WQXR**, **WNCN** and **WEVD**, all based in New York, will be added to Ofredia's roster of clients and will air programs produced by Ofredia in Paris. In addition, most of the music which can be heard aboard **Air France** jets is produced by Ofredia.

Ofredia's technical facilities include a small recording studio equipped with a 16/4 **Hudson** console, two **MCI/Sony**

JH-110 stereo recorders, an **Otari 5050** stereo recorder, limiters, compressors, Echo chamber, **Neumann** and **AKG** mics and headphones, and a **Nagra IV** which is used for remote interviews.

Ofredia's engineer is **Charles B. Raucher**, who started with **A.F.N. France** in Germany while in the U.S. armed forces. Mr. Raucher has also worked for many years in recording studios in New York City.

On Location

• The **Artisan Recorders** Mobile Unit was recently on location in Montego Bay, Jamaica to record the Fifth Annual **Reggae Sunsplash** for **Synergy Productions, Ltd.** and **The KSR Group**. The **MCI/Sony** equipped **GMC** Motorhome was transported from Miami, Florida in a **Hercules L-100** aircraft.

The **Artisan Mobile** provided simultaneous live mix audio feeds to **Trilion**, the London-based video crew, and the **Jamaica Information Service** (radio). Over 25 miles of **Ampex** Grandmaster two-inch tape was used to record the four-day music festival. In addition to a double live album, plans call for eight one-hour television specials and numerous radio programs to be marketed worldwide.

Peter Yianilos and **Jim Fox** engineered with **Stan Johnson**, **Richard Hilton**, **Steve Beverly**, **Scott Strawbridge** and **Rey Monzon**.



The Artisan Mobile Unit on its way to the Fifth Annual Reggae Sunsplash in Montego Bay, Jamaica.

AST Sound on the Move

• **AST Sound**, New York's Professional Sound Store, is moving into larger quarters. The new address will be 250 West Broadway, New York, N.Y., 10013, which is just around the corner from their Avenue of the Americas sales store. According to sales manager **Rich Grobarcik**, "this move will allow AST to put our sales and service under one roof, with much more space to demonstrate products and expand the service facilities." **AST Sound** is the largest speaker re-coning and electronics service center on the East Coast, offering **Altec**, **Electro-Voice**, **Fostex**, **Cetec Gauss**, **JBI**, and **Sunn** authorized service. They stock replacement diaphragm assemblies for all drivers, and offer 24-hour turn-around time to studios and other sound professionals.

.. & More Happenings

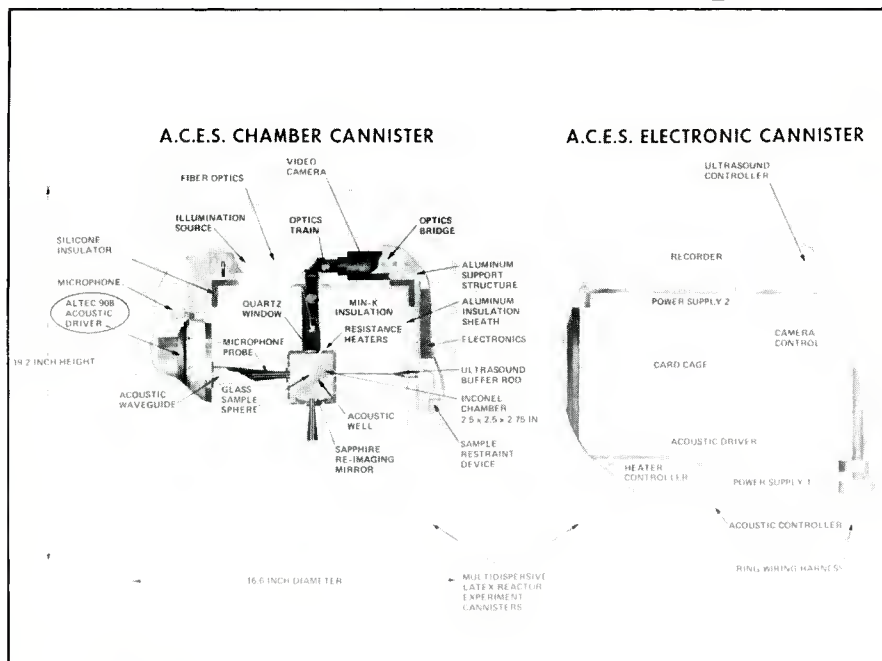

Altec in Space

Altec Lansing is providing loudspeaker compression drivers as part of an upcoming NASA space shuttle mission, according to Altec's **Bob Davis**, Professional Market Development vp for the Anaheim-based sound products manufacturer. The Altec loudspeakers are part of an experiment being conducted by researchers at the **Jet Propulsion Laboratory** in Pasadena.

JPL acoustics engineer **Jim Stoneburner** explained that three Altec 908-8A high frequency compression drivers will be used in an acoustic containerless processing experiment involving the melting and recooling of experimental glass under zero-gravity conditions on board the shuttle.

The three 30-watt, 7/8-inch throat Altec loudspeaker drivers are mounted to specially designed sound waveguides attached to the sides of a small, rectangular heating chamber. Once the shuttle is in orbit, the glass to be melted will be "levitated," or suspended, at the center of the chamber by the sound waves generated by the drivers. As the chamber and glass sample are heated to over 600 degrees Centigrade, a video camera will record the behavior of the sample throughout the two-hour experiment. In later shuttle flights, the temperature will be raised to 900 degrees C. The 2.5 to 5.5 kHz tones generated by each Altec driver will produce a sound pressure level of 140 dB within the chamber.

This experiment, which will fly for the first time in late 1983, is also scheduled for repeated flights on subsequent shuttle missions.

West Coast Entertainment Production Center

• **Lakeside Associates, Inc.** of Mission Viejo, California, has been selected by the **Timilon Entertainment Group** of

California for the design and construction of a unique entertainment production center. Over five years of planning and research have culminated in the selection of a West Coast site for the production center which encompasses some 20,000 acres. The property is comprised of mountain ranges, canyons, meadows, and is forested with redwoods, pine and oak groves, and has several reservoirs and recreational lakes.

Timilon's Chairman of the Board and Chief Executive Officer, **Glenn Epple**, states that long term leases are currently being negotiated with several major film and television producers, with a substantial percentage of the facility already committed. At present, twenty film and video soundstages along with six audio dubbing studios are being engineered for the first phase of construction which begins this fall.

Also included in the initial construction, scheduled for completion within 18 months, are an office and support complex, satellite transmission and reception facility, special effects department, film processing lab, screening rooms, post production rooms and editing suites, complete living accommodations and recreation facilities such as tennis courts, racquet ball courts, swimming pools, spas, and horseback riding.

There are limitless on-site filming locations with an extensive back lot. Also available on the property will be a private airport and helipad with a Citation II Jet aircraft and Bell long-range helicopter.

As the nucleus of a planned entertainment community, the production center will utilize many new developments in building technology. A major portion of the facility will be earth-sheltered to limit energy consumption, as well as enhance acoustical isolation and minimize the

aesthetic impact of large structures on the terrain. Both solid and liquid waste recycling will be employed, as well as extensive utilization of solar energy both for power and environmental control. A portion of the property has been set aside for a research and development park. Facilities will be available to evaluate the latest developments in digital audio and video recording, high-definition television, and advanced film technologies.

Round One to the CEO

• Due to the efforts of the **California Entertainment Organization** over the past nine months, Governor **Edmund G. Brown, Jr.** has signed into law AB 2871, the bill that rescinds the retroactive sales tax on all master recording productions. Sponsored by Assemblywoman **Gwen Moore**, AB 2871 overwhelmingly passed both the Assembly and State Senate with votes of 53/17 and 40/3, respectively. **Marz Garcia** had carried the bill in the Senate.

The passage of AB 2871 brought to a close the first chapter of the battle between the CEO and the State Board of Equalization. Due to an interpretation of a law passed by the legislature in 1975, the SBE had been assessing and collecting a retroactive 6 percent (6½ percent as of July 1) sales tax on all fabricating costs, or any expenses incurred, on personal services rendered in the producing of a master recording.

"They taxed us for the money we had to spend on studio costs, AFTRA scale, hotels, rental cars and take-out food," said **David Rubinson**, president of the CEO. "And on top of the tax, they tagged a 10 percent penalty for failure to file and a 20 percent per month interest charge."

The pertinent portions of AB 2871 now read as follows:

SECTION 1

Section 6362.5 of the Revenue and Taxation Code is amended to read: 2) "Amounts paid for the furnishing of the tangible elements" shall not include any amounts paid for the copyrightable, artistic or intangible elements of such master tapes or master records, whether designated as royalties or otherwise; (including, but not limited to, services rendered in producing, fabricating, processing, or imprinting tangible personal property or any other services or production expenses in connection therewith which may otherwise be construed as constituting "sale" under Section 6006.)

SECTION 3

The legislature finds and declares that Section 1 of this act is declaratory of, and not in change in, existing law. It is the intent of the legislature in enacting this act to clarify the existing law and to affect all applicable pending proceedings.

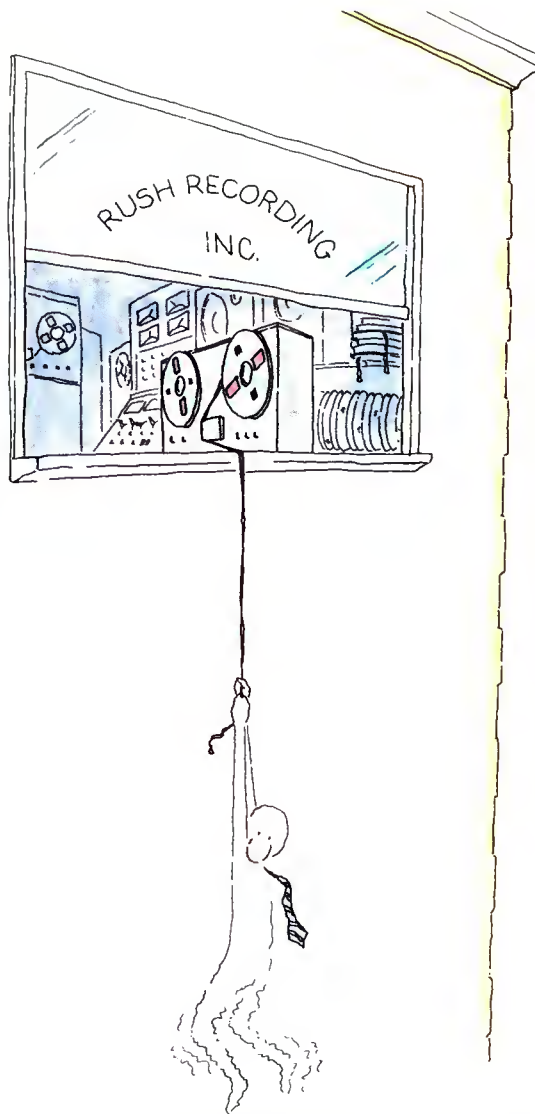

Audio engineers who try Maxell won't let go.

Maxell quality saves a lot of recording situations. Maxell meets your 1/4" open reel and audio cassette needs, no matter how demanding you are. Because we're more demanding. We've developed a name that means unique quality all around the world. For example, Maxell cassettes give you a productivity boosting four-function leader with A/B side indications, directional arrows, non-abrasive head cleaner and five-second cue to set timing and level.

You can see Maxell excellence in the cassette construction and on the 'scope or meter. The physical construction is strong enough to meet all professional requirements. Maxell open reel tape and cassettes give you quality you can hear. And your clients can hear as well.

We'll give you all the technical information you need to form your own opinions. But if you're like just about every audio professional that tries Maxell, you won't let go. Remember, we warned you!



maxell®

PROFESSIONAL/INDUSTRIAL DIVISION

Our success is magnetic.

Take Us For Granted

With 24 tracks going, you don't have time to reach over and adjust for tape-induced level variation. You want to be able to forget about the tape.

Which is why we test every reel of our 2" Grand Master® 456 Studio Mastering Tape end-to-end and edge-to-edge. To make certain you get a rock-solid readout with virtually no tape-induced level variation from one reel of 456 to

another or within a single reel.

No other brand of tape undergoes such rigorous testing. As a result, no other brand offers the consistency of Ampex Tape. The consistency that lets you forget our tape and concentrate on the job.

AMPEX

Ampex Corporation • One of The Signal Companies 

Ampex Corporation, Magnetic Tape Division
401 Broadway, Redwood City, CA 94063
(415) 367-4463

**4 out of 5 Professionals Master
on Ampex Tape.***



*1981-1982 Billboard Magazine
Brand Usage Survey