

SEATTLE WA 98105
325 COMMUNICATIONS BLDG
C S 50 UNIV OF WASH
KUOW RADIO
A9105KJUMV325COM11 0483 1983



The performance is
all you hear.



ENTIRELY
NEW

Introducing the Cetec Vega R-41 and R-42 PRO PLUS wireless-microphone receivers.

PRO PLUS is a new standard of performance in wireless microphone systems, exemplified by the R-42 diversity receiver with "infinite gain" technology and ultralow noise, and DYNEX II, an advanced new audio processing technique. **PRO PLUS** gives you every feature you should want in a wireless system, including:

- **DYNEX II, a new standard in audio processing.**
Can be switched in or out of the **PRO PLUS** system, to accommodate all requirements.
- **Measurably the highest signal-to-noise ratio and widest dynamic range.**
Quiet as a wire. 101 dB (108 dB, A-weighted) with DYNEX II. Even with DYNEX II switched out, the ULNR (ultralow-noise receiver) has an 85-dB SNR (92 dB, A-weighted). So good you may have difficulty measuring it, but you can definitely hear the difference.
- **"Infinite gain" receiver technology for highest performance.**
Developed for the demanding aerospace telemetry industry, "infinite gain" provides improved performance in the critical threshold region, superior accommodation of multipath conditions, better signal-to-noise ratio, and constant receiver audio level output.
- **Lowest distortion.**
0.25% maximum, 0.15% typical.
- **Professional audio circuits.**
Output is adjustable from +20 dBm to -60 dBm in four ranges. Also featured are selectable phasing, user-calibratable metering, and 0.2-watt independent headphone amplifier.
- **Diversity or single-channel models.**
The R-42 provides true dual-receiver diversity, and the R-41 nondiversity receiver has all of the other features of the R-42.

- **High-performance helical-filter front end.**
Plus all of the other standard features expected in Cetec Vega's professional wireless equipment, famous for quality and reliability.

PRO PLUS wireless microphone systems achieve the highest performance possible with today's advanced technology. Write or call for further information and location of your nearest dealer: Cetec Vega, P.O. Box 5348, El Monte, CA 91734. (213) 442-0782. TWX: 910-587-3539.

In Canada: A.C. Simmonds & Sons Ltd.

 **Cetec Vega**
Division of Cetec Corporation



APRIL 1983 VOLUME 17, NO. 4

Publisher
Larry Zide

Editor
John M. Woram

European Editor
John Borwick

Associate Editor
Mark B. Waldstein

Production & Layout
Kathi Lippe

Advertising Coordinator
Karen Cohn

Classified Advertising
Carol Vitelli

Book Sales
Lydia Calogrides

Circulation Manager
Eloise Beach

Graphics
K & S Graphics

Typography
Spartan Phototype Co.

sales offices

Roy McDonald Associates, Inc.
Dallas, Texas 75207

First Continental Bank Bldg.
5801 Marvin D. Love Freeway
Suite 303
(214) 941-4461

Denver, Colorado Area
Englewood, Colorado 80112

14 Inverness Dr. East
Bldg. 1—Penthouse
(303) 771-8181

Houston, Texas 77036
6901 Corporate Drive

Suite 210
(713) 988-5005

Los Angeles Area
Glendale, California 91204

424 West Colorado Street
Suite 201
(213) 244-8176

Portland Area
Hillsboro, Oregon 97123

510 South First
P.O. Box 696
(503) 640-2011

San Francisco Area
Emeryville, California 94608

265 Baybridge Office Plaza
5801 Christie Avenue
(415) 653-2122

Sagamore Publishing Co.
New York

Plainview, NY 11803
1120 Old Country Rd.
(516) 433-6530

FEATURES

LANDESSTUDIO STEIERMARK Christopher Landmann
26

SUPERJAM '82 David L. McLaughlin
30 and Robert F. Bolles

ACOUSTIC DESIGN IN NATATORIUMS Richard L. Hughes
34 and Milton F. Johnson

db APPLICATION NOTE: A POSTSCRIPT Thomas Hay
ON GROUNDING 37

db BOOK REVIEWS:

ORION REFERENCE GUIDES John M. Woram
38

HALLS FOR MUSIC: TWO DECADES Ken Pohlmann
OF EXPERIENCE 40

db CONVENTION REPORT: John Borwick
73rd AES CONVENTION: EINDHOVEN 42

DEPARTMENTS

LETTERS EDITORIAL CLASSIFIED
6 24 53

SOUND WITH IMAGES Len Feldman
8

THEORY AND PRACTICE Ken Pohlmann
12

SOUND REINFORCEMENT John Eargle
16

DIGITAL AUDIO Barry Blesser
20

NEW PRODUCTS AND SERVICES
49

PEOPLE, PLACES, HAPPENINGS
54

About
The
Cover

• This month's cover features the Cerritos Olympic Swim Center, located in Cerritos, California. For information on the acoustic environment of this beautiful natatorium see the article by Rick Hughes and Milton Johnson on page 34.

db, the Sound Engineering Magazine (ISSN 0011-7145) is published monthly by Sagamore Publishing Company, Inc. Entire contents copyright © 1983 by Sagamore Publishing Co., 1120 Old Country Road, Plainview, N.Y. 11803. Telephone (516) 433-6530. db is published for those individuals and firms in professional audio-recording, broadcast, audio-visual, sound reinforcement, consultants, video recording, film sound, etc. Application should be made on the subscription form in the rear of each issue. Subscriptions are \$15.00 per year (\$28.00 per year outside U.S. Possessions, \$16.00 per year Canada) in U.S. funds. Single copies are \$1.95 each. Editorial, Publishing and Sales Offices: 1120 Old Country Road, Plainview, New York 11803. Controlled circulation postage paid at Plainview, NY 11803 and an additional mailing office.

ONE PASS

**The Only Four-Second
Tape Erasers**

**That's Garner...
The Quality Eraser**

You're recording on a machine that costs hundreds or thousands of dollars, and you're recording on recycled tape. Can you guarantee that tape is absolutely clean? You can if you're using a Garner Audio Tape Degausser.

Garner is the standard of the industry...designed to the specifications of leading tape manufacturers. Garner is a conveyor-belt tape eraser. It can erase in less than five seconds what most degaussers take up to a minute to erase, and Garner erasers do a better job.

Time savings, ease of operation, quality of erasure, and rugged construction make Garner the most cost-effective eraser available.

Garner has established a reputation as the "Eraser People" because we manufacture a complete line of both audio and video erasers. Call and let us show you what a Garner eraser can do for you.



Dependability...Guaranteed

garner industries

4200 N. 48th Street Lincoln, NE 68504
Phone: (402) 464-5911 Telex: 438068

Letters

TO THE EDITOR:

How about doing a bit more on the moral and legal problems of copying copyrighted material? The February editorial was OK, but I was disappointed that it didn't really seem to disapprove of copying.

I would like to see a piece dealing with the problem that small studios and duplicating plants must have in dealing with customers who want a few copies of something they've borrowed. I get those requests all the time, and I'm not comfortable in dealing with them. It's pretty easy to turn away the kids who want dubs of the new rock music tape. But what do you do about the business client (perhaps a good customer for other work) who wants three copies of an expensive sales-motivation course?

The client sees no moral problems at all. He bought the course, and the copying is merely a matter of convenience, so that all of his salesmen can have the course at the same time. Occasionally we will see a similar request from a customer who has borrowed a sales course from another branch office, or from a friend in another business.

Until now, I have been making these customers sign a release form, agreeing to indemnify me if they are sued for infringement. This gives me the opportunity for a short speech on the illegality of copying. Trouble is, this is really more of a moral problem than a legal one. Worrying about legality is mostly a matter of worrying about getting caught, and there's hardly any chance of the casual copyist getting caught or sued. Stemming the wave of copying depends on generating a moral force against it.

I'd like to see what other duplicators are doing about this. I'd be curious to know if anyone has been sued for small-scale copying. And it wouldn't hurt to make some sort of poster, either in the centerfold or available by mail, that studios could put in the reception area to make a moral statement about copying.

HOWARD RUSSELL
Admix Broadcast Service

db replies:

If February's editorial rated an OK, April's should merit at least a resounding so-so. But seriously folks, there must be some of you who have an opinion on the issues raised by our editorials and reader Howard Russell. Well, we'd like to hear them.

Index of Advertisers

Alpha Audio	23
Amber	25
Brooke-Siren	39
Cetec Gauss	17
Cetec-Vega	Cover II
Crown	9
Delta Labs	11
Emilar	22
Garner	6
J. W. Davis	10
Midwest Acoustic Conference	20
PAIA	50
Polyfusion	8
Polyline	50
QSC	18-19
Shure Bros.	Cover IV, 21
Soundcraft	35
Sound Ideas	49
Standard Tape Labs	36
Studer Revox	Cover III
Telex	25, 33
UREI	13
White	12

Coming Next Month

• Next month, the focus will be on recording studios. Matt Kaplowitz of Onomatopoeia, Inc. checks in with an article on studio design and production techniques for audio-for-video, while Robert Brewster, from the Great White North, gives us the inside information on the creation of a new audio control room for Montreal Sound Studios. In addition, editor John Woram brings us a report on the recently concluded NAB Convention. All this, plus our regular departments, columnists and more, coming in May's db—The Sound Engineering Magazine.

The Bose® 402-W.

It only looks like a column.

Conventional column speakers often create more difficulties than they solve. Their "beamy" radiation patterns make it hard to get high-quality sound into all the places you want it—and keep it out of the places you don't want it.

Introducing the Bose 402-W Articulated Array™ Loudspeaker. The compact sound reinforcement speaker with the forgiving dispersion pattern it takes to cover almost any type of seating configuration.

The 402-W's unusually uniform radiation pattern will help you prevent the hot and dull spots caused by the deficiencies of conventional columns. The gradual "skirts" of its vertical pattern provide exceptionally even front-to-back



how Bose's Articulated Array™ system can smooth out the coverage of your sound system installations.

Covered by patent rights issued and/or pending.
402-W speaker design is a trademark of Bose Corporation.
© Copyright 1982 Bose Corporation.

room coverage. And the compact, flexible design of the 402-W enclosure makes it easy to install central clusters and remote units that meet the needs of a wide variety of room shapes.

Send in the coupon for complete technical data on the Bose 402-W Loudspeaker. Then listen to the 402-W, and hear

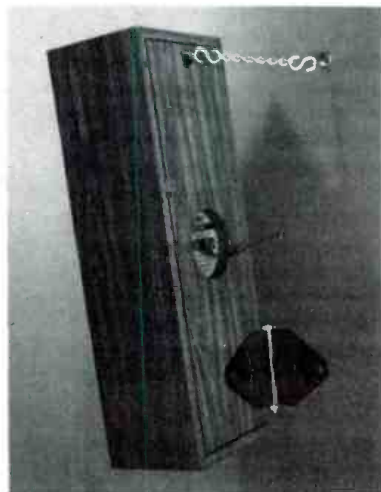

WB-2 Wall Bracket allows 3-axis adjustment.

Bose Corporation, Dept. SE
The Mountain
Framingham, Massachusetts 01701

Please send me the Bose Professional Products Catalog and your technical data.

Name _____

Firm _____

Address _____

City _____

State _____ Zip _____

Telephone () _____

BOSE
Better sound through research.

Sound With Images

Digital TV Video and Audio

• Lately, there has been talk of broadcasting TV as well as audio in digital form. Anyone with even a cursory understanding of the bandwidth requirements of digital TV will realize that neither pictures nor sound can be broadcast in digital form using present frequency allocations. For an NTSC signal, the bandwidth required for digital transmission would be enormous—far greater than can be accommodated by present TV broadcast frequency allocations. As for the audio channel, the bandwidth for its digitization would be between 2 and 4 MHz (depending upon the number of bits used to define an instantaneous amplitude of the audio signal). At the moment, while there is talk of new frequency allocations up in the 12 GHz band for satellite communication and, possibly, for high-definition TV, no thought has been given to assigning wide frequency swaths for digital TV transmission even on an experimental

basis. In any event, even if a system for digital TV transmission was available today, current technology would not be able to handle and decode such high-density digital information at a reasonable cost.

DIGITAL TV RECEIVER CIRCUITRY

Several manufacturers of consumer TV sets have, however, indicated that they intend to market digital television sets before the end of 1983. What these manufacturers mean when they use the word "digital" is that their sets will have front ends and I-F sections that are quite conventional and analog in nature. Signals demodulated by this conventional analog circuitry have a bandwidth of only 4 or 5 MHz, and it is this demodulated composite video and audio signal which will then be digitized. The rest of the signal processing, including the analog-to-digital conver-

sion, will be done by a set of eight chips that contain five VLSI (Very-Large-Scale Integrated) circuits. These chips have been designed and produced by the International Telephone and Telegraph Corp. (ITT) and are said to perform the work of about 300,000 transistors. According to ITT, digital TV sets using this technology can provide better image quality at about the same cost as today's higher priced sets. Furthermore, the kind of digital signal processing performed by these circuits will allow for the introduction of additional features over the years, such as the ability to zoom in on part of a picture, simultaneous viewing of two station signals (with one picture inset in the other) and the ability to process teletext.

As for the better picture quality, ITT claims that at least partial elimination of ghosts is possible. A digital TV set will be able to lock onto a sync signal to suppress interference from electrical appliances and even interference from passing aircraft. Once a video signal is digitized, picture storage becomes possible. Such picture storage capability will provide a number of useful features which are not possible using current analog technology. For example, it should be possible to provide a so-called pseudo high-resolution picture. The set will interpolate between scanning lines of a picture and produce additional scan lines that can be positioned between the original scan lines. This technique gives the appearance of a high-resolution picture having twice as many lines, not only making the picture seem much sharper, but greatly improving resolution or definition of pictures projected onto large screens. If, later on, digital TV circuitry should be applied to video cassette recorders, the ability to store images will allow the user to watch pictures in slow motion or freeze frame without the usual "noise bursts" that are now commonly present when such viewing is attempted with an analog type VCR.

Digital TV is expected to be of great importance in the development of DBS (Direct Broadcast Satellite) transmissions. For one thing, it overcomes incompatibility problems between our own NTSC system and European PAL and SECAM color TV transmission systems. Digital sets can be designed to handle all three types of transmis-

PRO-GRAPH PROGRAMMABLE GRAPHIC EQUALIZER



- 64 PROGRAM MEMORY CAPACITY
- 105dB GUARANTEED S/N
- REMOTE CONTROLLABLE
- 16 BANDS @ 2/3 OCTAVE SPACING
- BALANCED INPUTS & OUTPUTS
- VARIABLE INTENSITY SCREEN
- ±14dB CUT & BOOST RANGE
- MASTER/SLAVE LINKABLE

Design response curves, store them in memory, recall and display them instantly with precise repeatability--and all at the touch of a button. Free color brochure upon request.

polyfusion INC

92 Benbro Drive
Buffalo, NY 14225
(716) 681-3040

POWER. PRECISION. CHOICE.



Build yourself a stronger reputation by selecting the unique flexibility and professional performance of two new Crown power amps: the PS-400 or the PS-200.

Choose only the special, low-cost options you need: plug-in balanced input, active or passive; 70-volt transformer; dual fans. Install them easily, quickly, anytime, in any combination – thanks to the fresh, innovative design of these amps.

Built-in features make these amps the first choice of professionals: instant mono/stereo conversion, terminal strip connectors plus phone jacks, IOC™ and signal-present indicators, low-frequency protection, and much more.

Select the power level you need. For full-time, reliable performance, both amps are built in the best Crown tradition. PS-200 rated (FTC) at 135 watts per channel into

4 ohms, PS-400 at 260. Mono ratings into 8 ohms are 270 watts (PS-200) and 520 (PS-400).

Introduce yourself to the new Crown MULTI-MODE™ output circuit, a new, three-deep design that eliminates audible distortion, and introduces a degree of precision sound reproduction that will delight performers and audiences.

Complete information on specifications and prices, for the amps and the optional accessories, is now available from Crown. For quick action, simply fill in the blanks below and send this corner of the ad to Crown.

Name _____

Address _____

City _____ State _____ Zip _____



PS-200



crown®



PS-400

...WHEN YOU'RE READY FOR REAL!
1718 W. Mishawaka Rd., Elkhart, IN 46517, (219) 294-5571

Circle 15 on Reader Service Card

OUR BOTTOM LINE IS

Our bottom line of service means *your* bottom line will be more profitable.

Single Source.

The widest range of commercial sound products in the industry. Even hard-to-find items.

Fast Delivery.

Orders are shipped within 36 hours of receipt. Faster if necessary.

Sound Advice.

Personal attention, plus professional advice on any technical problems. We're your unseen partner.

50 Years' Experience.

Service and reliability that have been proven over the years. You can depend on us!

Call toll free today for new price list.

1-800-527-5705
TEXAS 1-800-442-1564

SERVICE

J. W. Davis & Company
3215 Canton Street
P.O. Box 26177
Dallas, Texas 75226



sions. In addition, digital TV would permit direct processing of satellite transmissions which are expected to include digital and multi-channel sound transmission (bilingual and/or stereo audio). Normally, in the case of conventional receivers, such digital audio signals would have to be converted into analog form for further processing by analog circuitry.

HOW DIGITAL TV SETS WORK

As mentioned earlier, a digital TV set is analog in nature until the incoming signal has been RF amplified, heterodyned to IF frequencies, amplified once again and demodulated. Digital processing only starts after the TV signals have been demodulated, at which time both the video and audio demodulated signals are converted to digital form. Experience has shown that an 8-bit code is needed for proper resolution of the video luminance (brightness) signal. Six more bits are required for the chroma (color) signal, 13 bits for the deflection signals and 14 bits for the audio signal.

The digital processing is performed by five VLSI chips, aided by a clock generator, a digital amplifier and a microcomputer that controls the process based upon the user's front panel control settings. The five chips are a video codec which consists primarily

AUDIO DIGITAL PROCESSING

While the video processing circuits are by far the more complex in this digital processing system, I suspect that readers of *db* would be more interested in how the audio signals are handled. The audio circuit design involves problems that are different from those encountered in the video VLSI chip designs, and it must provide specific audio capabilities that are expected in a high fidelity system. For example, the circuits are designed to accommodate the transmission of multi-channel audio, either for stereo or for multilingual service. Such transmissions are likely to be introduced before the end of 1983, providing that the Multi-channel Sound Committee completes its further studies on schedule and that the FCC acts promptly on the recommendations which that committee is expected to submit as a de facto standard. If the digital audio system is to serve the needs of high fidelity enthusiasts, it must be able to handle the great variety of user adjustments that are standard in high-fidelity equipment, such as bass and treble tonal compensation, stereo balance, stereo apparent separation, etc.

The audio chip has two parallel-processing channels and an arithmetic/logic unit that is shared by the two

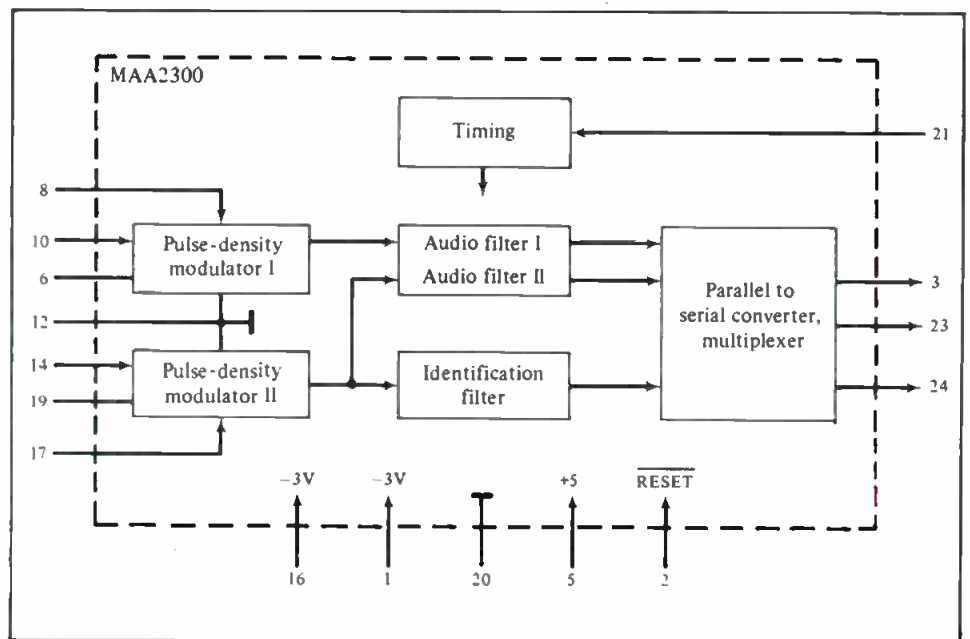

Figure 1. The audio A/D converter block diagram.

of A/D and D/A converters for the video signal, an audio codec which performs the same functions for the audio signals, a deflection control unit which deals with the sweep synchronization signals, and video and audio processor units which do the filtering and decoding of the video and audio signals.

channels to carry out the required filtering operations. A block diagram of the audio A/D converter is shown in FIGURE 1. It uses a pulse-density modulator and digital converter. The circuit samples a 4 MHz input signal and produces a 1-bit data stream which is then converted into a 16-bit resolution

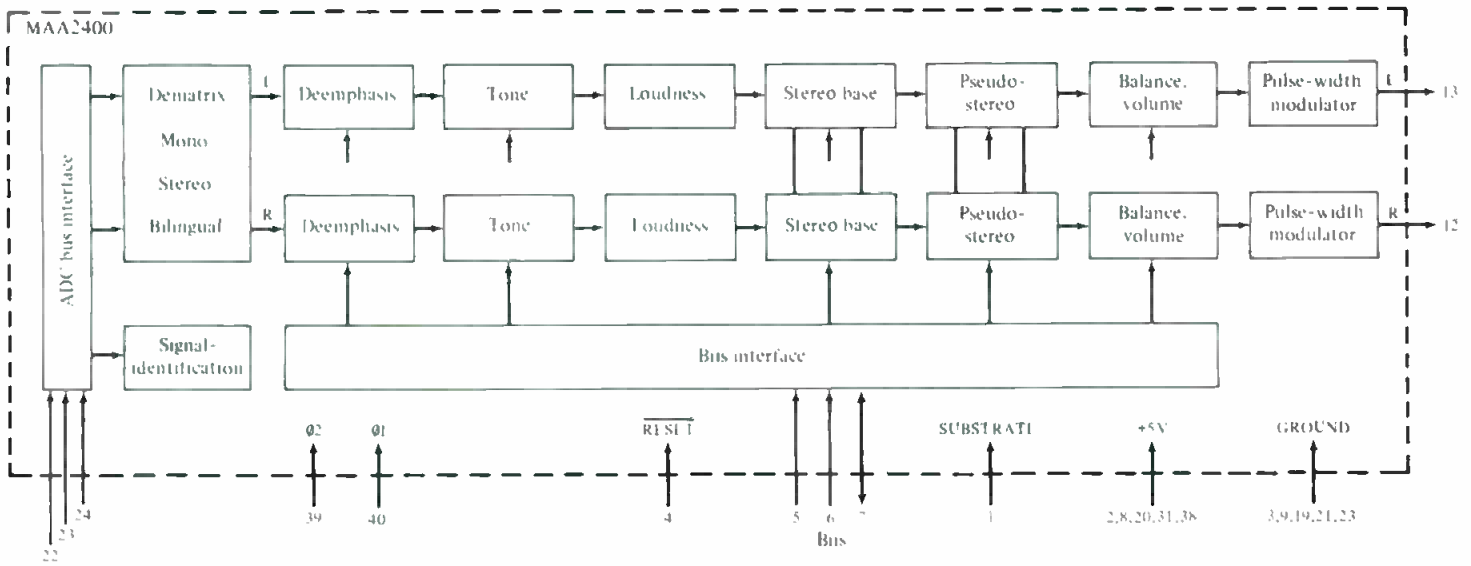

Figure 2. Block diagram for the audio processor chip developed by ITT for digital TV receivers.

stream at 35 kHz sampling rate. A digital identification filter extracts the identification signal that determines whether a broadcast is mono, stereo, or bilingual. The parallel-to-serial converter multiplies the output to the audio processor, reducing the number of pins required for the chip.

A block diagram of the audio processor section of the audio chip is shown in FIGURE 2. The audio processor takes the digital signals from the A/D converter and splits it into two channels. Each signal is then sent through a series of filters which control stereo balance, tone, loudness, etc. Filter characteristics are controlled by signals from the control computer chip and are based on user front panel control settings.

So far, ITT is the only semiconductor manufacturer to produce digital TV chips. If the chips prove reliable, and the yield makes them economical enough to use in consumer products, the company plans to follow up with two-chip and one-chip versions that should make digital color TV sets competitive in price with the least expensive color TV sets of today. ITT's own TV manufacturing division in West Germany expects to begin making digital TV sets sometime this year. The sets, to be marketed in Europe, will be able to receive signals transmitted by the PAL, SECAM and NTSC systems. In this country, Zenith Radio expects to begin production of digital TV sets using the ITT chips, but as of now exact dates or availability have not been announced. Sony Corporation, Sanyo and Sharp International, all of Japan, as well as Telefunken of West Germany have also indicated an interest in the ITT chip development, but have not yet announced specific production plans for sets incorporating the chips. ■



“Now You Can Afford to Delay . . .”

by Deltalab

The ADM 310 unit offers 310ms in 10ms increments at *full power bandwidth* (20Hz to 20KHz) with greater than 90dB dynamic range.

A true digital delay product with exceptionally natural sound quality, for applications where one or even a dozen delays, via serial and parallel coupling, are needed. Unobtrusive sound reinforcement in churches, theatres, and function rooms; pre-reverb delay in studios, and special effects such as simple doubling and echo. **SUGGESTED RETAIL \$599**

For more information, contact:



DeltaLab Research, Inc.
27 Industrial Ave.
Chelmsford, MA 01824

The Audible Difference!

Theory & Practice

The Compatibility Solution

• I don't know if this month's column will make it in time. If it arrives under the April deadline, it will only happen by the grace of Federal Express. My microprocessor was in pieces, undergoing renovation, so I was unable to power-up the word processor to write this column.

What? A pencil? Are you kidding? Am I some kind of *savage*? Frankly, I would have made the deadline with no sweat if I could have used a modem to telephonically and instantaneously send the text to the illustrious editor. With the high cost of crayons, even he has switched to word processing, and with a pair of modems—ah, I forgot, our computers are incompatible. But don't despair editor, read on... (Forget it, your style is incompatible—ed.)

Last month I vented some of my spleen regarding the incompatibility crisis affecting today's advanced technology. As a computer and audio entre-

preneur, I have fought the battle of incompatibility countless times, and usually lost. Except through extreme perseverance or outright cleverness, Z-80 software will *not* run on an 8088 system, and a quarter-inch phone plug will *not* mate with a female XLR jack. Similarly, countless things will not work with countless other things. It's the same old story—our prolific and progressive society must always deal with rampant incompatibility; apparently, it's an essential ingredient of the process of progression.

THE CONUNDRUM

Just as the nature of technology's advance seems to be exponential, incompatibility's curve sometimes seems to be the exponent of an exponent. It has been suggested that incompatibility might ultimately log-jam and wreck the entire process, as was, at least partly, the case with the ill-fated intro-

duction of quadraphonic audio a decade ago. Another disturbing aspect of incompatibility is its ability to thrive in digital cultures. In the analog days, things were more comfortable and roomy. In the event of a mismatch, a good seat-of-the-pants engineer could perform a friendly kluge, usually in a matter of minutes. With digital, the seat-of-the-pants philosophy itself has been rendered obsolete. Incompatibility in a digital system is often stubbornly immutable. Which of us hasn't experienced the infuriation of watching a blinking, non-responding video cursor, the exasperation of fighting a program listing with a typographical error somewhere, or the fury of trying to deal with bad automation data?

With the precision and punctuality of digital there is no room for error, and close-enough just isn't close enough. Attempts at kluges quickly become nightmares. Digital demands an absolute absence of incompatibility, yet creates an almost infinite number of opportunities for it to occur. Did we push our luck too far with the explosion of digital technology? Only future civilizations will be able to answer with certainty. Meanwhile, we must merely do our best to deflect hasty decisions with questionable long-range consequences and carefully monitor where our technology is taking us.

The Compact Disc, as we determined last month, is a prime example of a piece of new technology with long-range impact. Its innovation necessitates its incompatibility and we were left to wonder if its advantages truly outweighed its tremendous incompatibility. We reflected that as far as recorded music goes, the consumer would have to start all over again. The cost of conversion would be tremendous, yet the essential superiority of the system was clear. Ultimately, when all the grooves of vinyl records are worn out, and diamond styli blunted, we would be left with a better product.

But there is another problem. We noted that the Compact Disc is incompatible with old technology and *new* technology as well. Specifically, while the Compact Disc prepares for a future world of 44.1 kHz sampled music, the rest of the industry is preparing for a 48 kHz future. While the Compact Disc's incompatibility with grooved records will slowly dwindle as grooved records fall by the wayside, the Com-



2 Channel Octave Band Graphic Equalizer L-C ACTIVE 4100A

The model 4100A features Active, Inductor-Capacitor (L-C) Tuned Filters. The resonant frequency of each filter is derived PASSIVELY by a Tuned L-C Pair. This drastically reduces the number of active devices necessary to build a Ten Band Graphic Equalizer. Only seven operational amplifiers are in each channel's signal path: THREE in the differential amplifier input; TWO for filter summation; ONE for input level control; ONE for the output buffer. The result . . . the LOWEST "Worst Case" NOISE of any graphic equalizer in the industry . . . -90dBv, or better.



Compact Disc's incompatibility with the industry's professional sampling standard will remain for perpetuity. Imagine, for all of the years of the Compact Disc's (probably) long lifespan, playback of a Compact Disc will require interfacing its 44.1 kHz sampling rate to the studio's 48 kHz equipment in every broadcast studio. And, in every recording studio, all 48 kHz master recordings will have to be transferred to 44.1 kHz. It's the old double standard again, this time a replay of the familiar consumer-versus-pro format. Will the aggravation reflected in the ITT (Incompatibility Theory) triumph?

HELP ARRIVES

Fortunately, the remarkable technology which creates the problem has also created the means for the remarkable solution. Consider the idea of a box which can accept any arbitrary digital format and sampling frequency and convert it to any other scheme. Such a device would constitute a universal digital matching transformer and thus make compatible all of the various streams of data. It's probably silly to hope for agreement among all audio equipment manufacturers, and even if that could be achieved, it would be unreasonable to think that advancing technology wouldn't soon dictate different formats and rates. Consider that the box hypothesized above could reconcile all present schemes, and make them compatible with future schemes. What more could we ask for?

Consider the Studer SFC 16. It is the first digital sampling frequency converter, covering the whole range of sampling frequencies in use today, and potentially, any sampling frequencies. Conflicting sampling frequencies from 30 kHz to 52 kHz, word lengths from 14 to 18 bits, any arbitrary formats, and phase-locked and unsynchronized systems can all be transferred one to the other. Want to transfer from the professional 48 kHz to the satellite 32 kHz?—the simple ratio of 3 to 2 will do it. How about 44.1 kHz to 48 kHz?—a ratio of 147 to 160 will make it easy. How about two compatible but differing formats, such as two unsynchronized systems?—no problem. The SFC 16 automatically adapts itself according to the clock frequencies present, and performs the correct match with or without a matching ratio. Its front panel illustrates the ultimate in compatibility—one on/off switch.

As with all elegant solutions, the SFC 16 is simplicity itself (relatively speaking). Audio data passes through an input interface, two digital filters connected in cascade, a buffer, two more digital filters, and an output interface. Clock processing and filter control circuitry, being driven by the sampling clocks of both the input and output devices, control the filter

operation. The stereo unit consists of eight digital circuit boards—one for interfacing and filter self-testing, one for clock generation and processing and processing circuitry self-testing, and three boards for each channel of digital filters.

The digital filter scheme in the SFC 16 is quite ingenious. The first two filters are synchronous with the input sampling frequency and the last two are synchronous with the output sampling frequency. The difference in bit rates between the two is soaked up with the intermediate buffer. The first filter is a linear-phase FIR filter of 63 length. It performs a conversion from

$f_i(\text{in})$ to $f_i \times 2(\text{in})$ in the UP mode, and $f_i \times 2(\text{out})$ to $f_i(\text{out})$ in the DOWN mode. It has a relative bandwidth of $\frac{3}{4}$ of the Nyquist frequency (0 to 21 kHz at 48 kHz sampling frequency, and 0 to 19.3 kHz at 44.1 sampling frequency). The second filter is a linear-phase FIR filter of 15 length. It performs a conversion from $f_i \times 2(\text{in})$ to $f_i \times 4(\text{in})$ or $f_i \times 4(\text{out})$ to $f_i \times 2(\text{out})$ with no bandwidth change. Filter three is an FIR of 255 length and incorporates a synchronous buffer for conversion from $f_i \times 4(\text{in})$ to $32,768 \times f_i(\text{in})$ and thence to $f_i(\text{out})$, or from $f_i(\text{in})$ to $32,768 \times f_i(\text{out})$ and thence to $4 \times f_i(\text{out})$. The fourth filter is an FIR filter of 255 length which performs a linear interpo-

The Most Imitated Compressor/Limiter in the World: The UREI LA-4

For over 20 years, UREI electro-optical limiters have set the standard for automatic gain reduction. From the original LA-1 and the LA-2 vacuum tube "leveling amplifiers" to today's LA-4, these UREI compressor/limiters have given thousands of users the most musical and natural sounding results around.

The "soft-knee" compression curve, which eases the signal into control, is only one of the "LA" Series' features which have become models for the industry. The LA-4, like its illustrious predecessors, employs gain reduction circuits which respond much like your ears do.

These features, coupled with traditional UREI quality, make an unbeatable combination.

Insure the quality of your signal with the LA-4. It's the original, not an imitation. For more information on the LA-4 and other UREI signal processing equipment, see your authorized UREI dealer or contact:

UREI

From One Pro to Another

United Recording Electronics Industries
a URC Company
8460 San Fernando Road
Sun Valley, California 91352
(213) 767-1000 Telex: 65-1289 UREI SNVY
Canada: E. S. Gould Marketing, Montreal



© UREI 1983

lation at the input or output sampling frequency. The four-filter cascade is the mathematical equivalent of a fixed linear-phase FIR filter of 1.18 million length, performing conversion at approximately 1.57 GHz. The first filter has a ripple of ± 0.15 dB, and the other three cumulatively add an additional ± 0.05 dB ripple. The overall phase response is perfectly linear.

In the case of unity matching, the clock processing circuitry derives sampling clocks from the input signal and thus controls phase-locked loops used for timing and counting. For unequal sampling frequencies, the clock processor measures the asynchronous clocks of the input and output and calculates the ratio needed to match the two conflicting sampling frequencies with an accuracy of ± 300 picoseconds. The proper ratio is selected by controlling the digital filters, with 16-bit accuracy; the error in the sampling frequency ratio is less than ± 0.25 percent. In addition, relative position of the two clocks is monitored, and jitter is suppressed. Filter bandwidths are varied to prevent aliasing in the frequency conversion. To prevent possible switching at a unity conversion ratio, an UP mode is imposed.

While the device itself is a universal converter, its particular application is determined by the choice of interfaces. Thus, the digital interface format supported by Studer, Sony, the EBU, and others can be ordered, as well as custom interfaces for specific interfacing applications.

The SFC 16 is the first digital audio processing device with self-diagnostics: in the self-test mode, both channels are fed with a digital noise source and error patterns detected. For example, for errors common to both channels, the clock processing circuitry is checked, and for errors on one channel only, that channel is tested against the functioning channel. An error code is displayed via LEDs to help locate malfunctioning ICs. In any case, its conversion resolution of better than one nanosecond is achieved with non-esoteric digital chips such as low-power Schottky TTL—a piece of cake for a good technician.

The issue of signal degradation in digital sampling frequency conversion is still up for debate. Conversion amplitude and phase response of the SFC 16 are unquestionably excellent. Filter noise is present, but at typical audio signal conditions it occurs at levels close to the quantization noise of 96 dB below clipping, using the 16-bit format, and 108 dB below clipping with the 18-bit format. Signal-to-noise losses can occur in several cases: jitter-induced noise introduced into audio signals of high audio frequency and high level, a round-off error from the digital filters independent of signal

amplitude, filter foldback noise which increases with signal level, and quantization noise loss. The noise level of the SFC 16 is quite good; in the case of a pure sinewave, an output noise floor of 112 microvolts could be expected, whereas the theoretical level for 16 bits would be 88 microvolts. By way of comparison, a good A/D converter might account for 200 microvolts of noise. The overall effect of standards conversion must remain a concern: even theoretically a signal-to-noise ratio loss of 3 dB will occur and, in practical devices such as the SFC 16, the loss will be greater, especially under the worst-case condition of a clipping signal at the upper bandwidth frequency of 21 kHz. The tremendous

victory, but a victory it is. The point is that our modern day complexity does not prohibit compatibility, it merely calls for more complex solutions. In my mind, there is no excuse—the audio industry must rise to the challenge of developing ever-more sophisticated products to satisfy the needs of our ever-more sophisticated society. No one ever said hi-fi was going to be easy—and no one ever said it was going to be cheap. As far as industry compatibility goes, it might happen—but someone will have to pay for it.

Now, John, about this modem project. A couple of companies are making microprocessor-translator boards such that any microprocessor can be compatible with any other microprocessor.

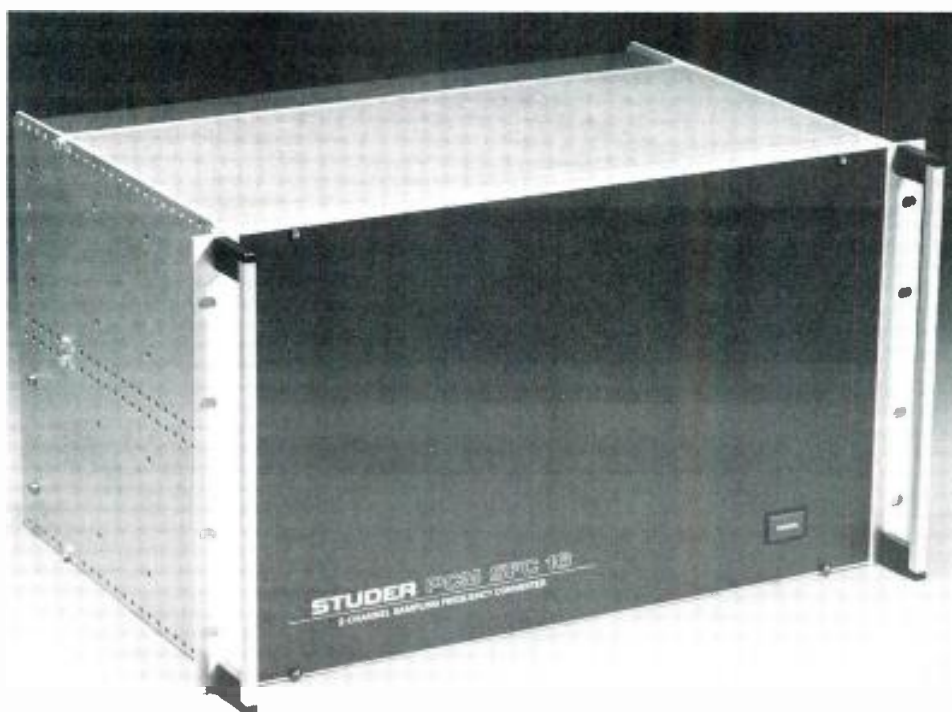

The Studer SFC 16, with a front panel so simple even an editor can figure out how to turn it on....

dynamic range of digital recording minimizes the effect of the loss, but the analog terror of losing even a little S/N is sure to fuel the double-standard controversy. Even a remarkable solution to an incompatibility problem begets more problems.

IN CONCLUSION

The Studer SFC 16 is thus the first digital sampling frequency converter to hit the market. Whereas a transformer used to be sufficient to match incompatible audio lines, now a cascade of quadruple digital filters is needed. That might seem like a hard-won

All that you have to do is unplug your microprocessor chip, plug the adapter board into the DIP socket, and re-plug your microprocessor chip on the adapter board. It's great. Depending on the adapter you get, you can run anybody's software on your microprocessor. To get these columns to you on time, all that we have to do is put an adapter on your 8088 so it will talk with my Z-80, or vice versa—the appropriate adapter could go on either computer. Of course, if you want to pay for it, it should be installed in your machine. If the magazine pays for it, I'll put it in my machine. [Let's compromise: you buy it, I'll install it—Ed.] ■

Updated Recording Studio Handbook

A must for every working professional... student... audio enthusiast

Features latest state-of-the-art technology of creative sound recording.

21 Fact-Filled Chapters

- I. The Basics
 1. The Decibel
 2. Sound
- II. Transducers: Microphones and Loudspeakers
 3. Microphone Design
 4. Microphone Technique
 5. Loudspeakers
- III. Signal Processing Devices
 6. Echo and Reverberation
 7. Equalizers
 8. Compressors, Limiters and Expanders
 9. Flanging and Phasing
- IV. Magnetic Recording
 10. Tape and Tape Recorder Fundamentals
 11. Magnetic Recording Tape
 12. The Tape Recorder
- V. Noise and Noise Reduction
 13. Tape Recorder Alignment
 14. Noise and Noise Reduction Principles
15. Studio Noise Reduction Systems
- VI. Recording Consoles
 16. The Modern Recording Studio Console
- VII. Recording Techniques
 17. The Recording Session
 18. The Mixdown Session
- Three all-new Chapters
 19. The In-Line Recording Studio Console (The I/O Module, The Basic In-line Recording Console, Signal flow details)
 20. An Introduction to Digital Audio (Digital Design Basics, Digital Recording and Playback, Error Detection and Correction, Editing Digital Tapes)
 21. Time Code Implementation (The SMPTE Time Code, Time-Code Structure, Time-Code Hardware)



\$39.50

The *Recording Studio Handbook* is an indispensable guide with something in it for everybody. It covers the basics beautifully. It provides in-depth insight into common situations and problems encountered by the professional engineer. It offers clear, practical explanations on a proliferation of new devices. **And now it has been expanded with three all-new chapters... chapters on the in-line recording studio console, digital audio and time code implementation.**

Sixth printing of industry's "first" complete handbook

The *Recording Studio Handbook* has been so widely read that we've had to go into a sixth printing to keep up with demand (over 30,000 copies now in print). Because it contains a wealth of data on every major facet of recording technology, it is invaluable for anyone interested in the current state of the recording art. (It has been selected as a textbook by several universities for their audio training program.)

Highly Acclaimed

Naturally, we love our book. But don't take our word for it. Here's what others have to say:

"John Woram has filled a gaping hole in the audio literature. This is a very fine book... I recommend it highly." *High Fidelity*

"A very useful guide for anyone seriously concerned with the magnetic recording of sound." *Journal of the Audio Engineering Society*

15-Day Money-Back Guarantee

When you order *The Recording Studio Handbook* there's absolutely no risk involved. Check it out for 15 days. If you decide it doesn't measure up to your expectations, simply send it back and we'll gladly refund your money.

Easy to Order

You can enclose a check with your order or charge it to Master Charge or BankAmericard/Visa. Use the coupon below to order your copies of the new updated *Recording Studio Handbook* (\$39.50).

ELAR PUBLISHING COMPANY, INC.

1120 Old Country Road, Plainview, N.Y. 11803

Yes! Please send _____ copies of THE RECORDING STUDIO HANDBOOK. \$39.50. On 15-day approval.

Name _____

Address _____

City/State/Zip _____

Total payment enclosed \$ _____
(In N.Y.S. add appropriate sales tax)

Please charge my Master Charge
 BankAmericard/Visa

Account # _____ Exp. date _____

Signature _____
(changes not valid unless signed)

Outside U.S.A. add \$2.00 for postage.

Checks must be in U.S. funds drawn on a U.S. bank.

Sound Reinforcement

Environmental Effects In Sound Reinforcement

• In this month's column we will examine the effects of temperature gradients, wind velocity and velocity gradients, and humidity on the propagation of sound. While these effects are most often observed in outdoor situations, the effects of humidity can often be observed indoors.

THE EFFECTS OF TEMPERATURE AND TEMPERATURE GRADIENTS

In SI units, the velocity of sound is given approximately by the equation:

$$c = 331.4 + 0.607C \text{ m/s,}$$

where C is the temperature in degrees Celsius. In English units, the corresponding equation is

$$c = 1052 + 1.106F \text{ ft/s,}$$

where F is the temperature in degrees Fahrenheit.

While the effect of temperature is usually small enough to be ignored, there can be some unusual effects noted, especially over large distances. In FIGURE 1A, we show an effect often observed just after sundown, when the ground, due to thermal inertia, may be appreciably warmer than the night air above it. Since the velocity of sound is greater close to the ground, the general direction of propagation will be curved upward.

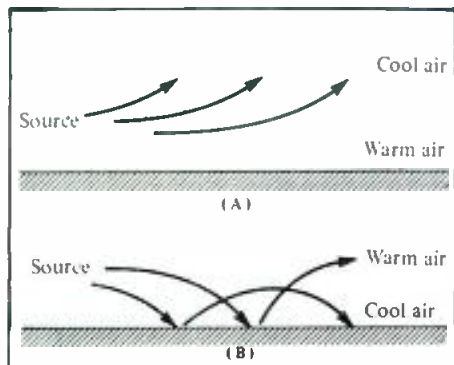

Figure 1. The effects of temperature gradients on sound propagation.

In the morning, the opposite effect may be noticed, as shown in 1B, and sound propagation will be observed to skip repeatedly over the ground, producing dead spots.

THE EFFECTS OF WIND AND WIND VELOCITY GRADIENTS

The effects of wind velocity gradients are similar to those of temperature

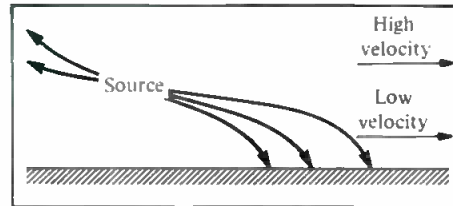

Figure 2. The effect of wind velocity gradients on sound propagation.

gradients. Specifically, the velocity of sound is the sum of its velocity in still air plus the velocity of the air itself. Where gradients in velocity exist between air close to the ground and air above it, we may note the effect shown in FIGURE 2.

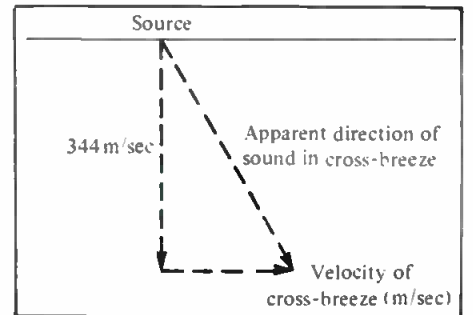

Figure 3. The effect of a cross-breeze on the apparent direction of sound.

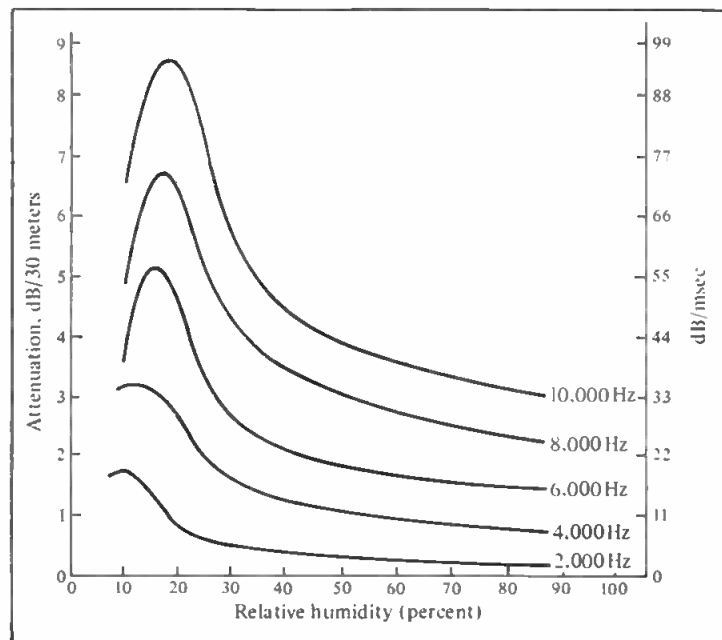

Figure 4. The absorption of sound in air versus relative humidity.

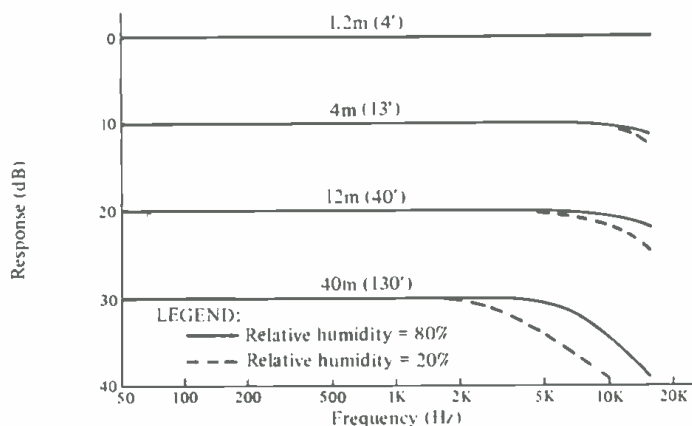

Figure 5. Losses due to both inverse square fall-off and atmospheric absorption at high frequencies ($T = 20^{\circ} \text{C}$).

Where there is a cross breeze, as shown in FIGURE 3, the apparent orientation of a loudspeaker system can change. In the figure, the loudspeaker is aimed directly ahead. In a strong cross breeze, the loudspeaker would effectively have its major axis reoriented as shown, and a listener seated along the main axis of the loudspeaker would probably hear a swishing in and out of the high frequencies as the wind velocity varied. This happens because most loudspeakers are fairly directional at high frequencies, and those frequencies would be the first ones to be affected by the shift in the apparent orientation of the loudspeaker.

THE EFFECTS OF HUMIDITY

FIGURES 4 and 5 show the excess attenuation of sound over and above inverse square losses as a function of frequency and relative humidity (RH). Most people are under the impression that rooms sound "deader" when the humidity is high, but actually the reverse is true. Note that when the air is quite dry, in the 10-20 percent RH range, the attenuation is maximum and that it is greatest at high frequencies.

Indoors, the effect of humidity can be as shown in FIGURE 6. Here, we show the fall-off in high-frequency reverberation time at 50 percent RH.

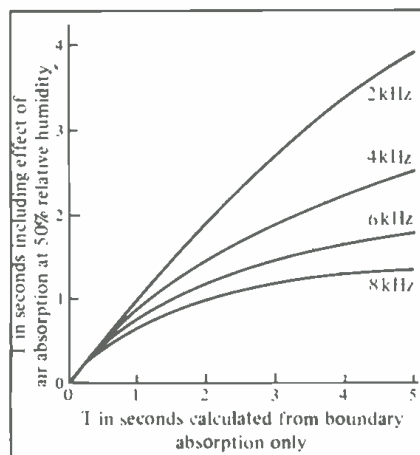

Figure 6. The effect of air absorption on calculated reverberation time.

ation time at 50 percent RH. Above 4 kHz, the effect is quite noticeable. In a large cathedral, for example, where the mid-band reverberation could easily be in the 5-second range, the absorption due to 50 percent RH would effectively reduce the reverberation time at 8 kHz to just a little over one second. If we had made our reverberation-time calculations considering only boundary absorption, our numbers would have told us that the reverberation times at 6 and 8 kHz would have been not too different from that at 1 kHz.

In this example, an increase in RH would lengthen the high-frequency reverberation time, and a decrease in RH would shorten it. ■

great gauss good price

Introducing 8 new affordable musicians' instrument speaker systems — from Gauss.

High quality Gauss at an affordable price? Right! Through creative engineering design, the 4 systems here are actually 8. This innovative math makes it possible for us to price all these cost effectively. The product hasn't changed. Each still has the same superior power handling, efficiency, and 5-year speaker warranty. Plus, all 8 have parallel phone jacks and 8 Ohm nominal impedance.

Hearing the product and the price will make you a believer in our math. Hear Gauss at your nearest dealer — the price is right.



5120

1&2 5120 12" Rhythm or Lead Guitar with open back. 150 Watts RMS. **OR:** Mid-high element to use with Bass. Infinite baffle closed back.

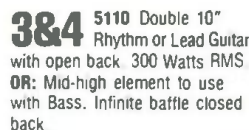

3&4 5110 Double 10" Rhythm or Lead Guitar with open back 300 Watts RMS

OR: Mid-high element to use with Bass. Infinite baffle closed back



5180

7 5180 18" Bass reflex Bass Guitar Bottom 200 Watts RMS



5110

5 5181 18" Slot-loaded horn Bass Guitar Bottom 400 Watts RMS

6 5110/5181 Low/Mid-high Bass Guitar System

8 5110/5180 Low/Mid-high Bass Guitar System

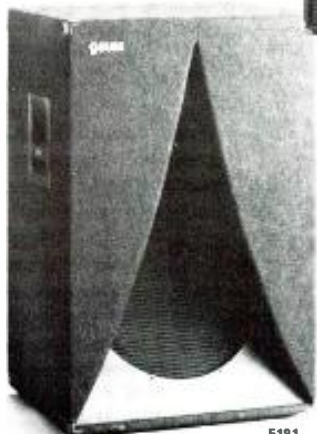

5181

C Cetec Gauss

9130 Glenoaks Boulevard
Sun Valley, CA 91352
(213) 875-1900
Telex: 194989

In Canada:
Omnimedia
9653 Cote De Liesse
Dorval, Quebec H9P 1A3
(514) 636-9971

Albert just bought eighty-eight of our best amps and thought he got a deal.

Albert Leccese is the Chief Sound Engineer and partner with the Paré brothers at Audio Analysts, Inc. The company is a prominent supplier of sound reinforcement systems to major national and international touring groups.

Albert has no room for error or failure. He doesn't put his stamp of approval on any piece of audio support equipment unless it meets a rigid set of standards.

QSC Series Three amplifiers exceeded all of Albert's tough requirements. In fact, he spent the better part of a week trying to default one of the units in a test of reliability under stress.

Albert failed, QSC didn't. Series Three stood up to whatever abuse he could dish out.*

So Albert and the Paré brothers were impressed enough to add 88 units to their stable.

But it wasn't just the bulletproof reliability that overwhelmed them. The true dual-mono configuration with front-panel access modules and comprehensive input/output interface also supported their decision. And Series Three puts more power into less rack space,

a big plus for sound systems on the road.

So take a look at Series Three from QSC. Explore all the features and benefits that these truly revolutionary amplifiers have to offer.

Whether you purchase 1 or 88, you'll realize what a deal Series Three is.

Just ask Albert.

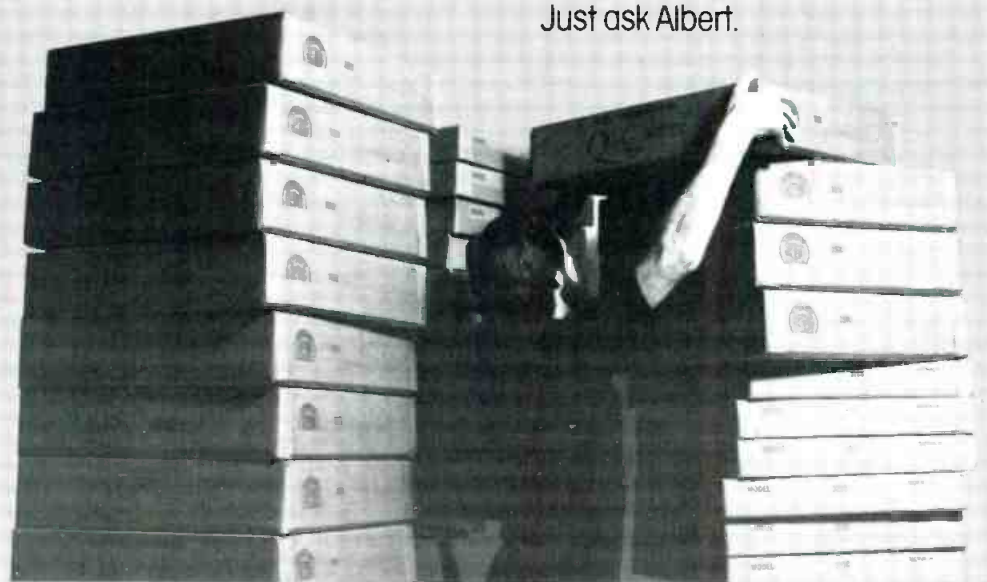

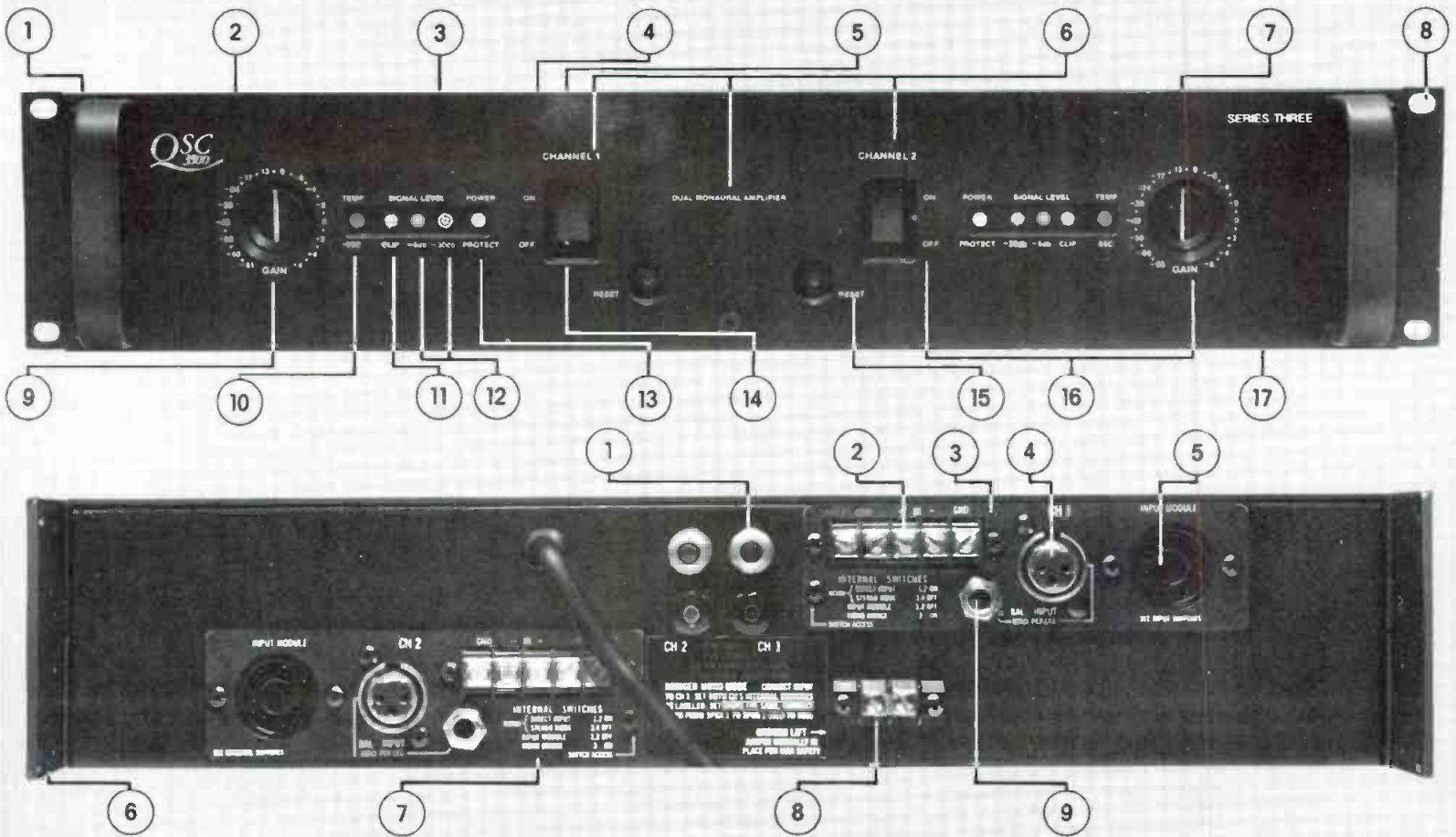

FRONT VIEW

1. PASSIVE COOLING
No fan noises. No internal dust build-up.
2. FRONT REMOVABLE CHANNEL MODULES
All electronics for each channel can be exchanged while amp is in rack.
3. HIGH POWER/LOW PROFILE DESIGN
Using high efficiency output circuits for cool, high reliability operation.
4. FLOATING INTERNAL CONNECTOR SYSTEM
Prevents contact damage from road vibration. All gold contacts in signal level path.
5. CENTRAL WELDED STEEL AC AND TRANSFORMER BAY
For maximum strength and shielding.
6. TRUE DUAL MONO CONFIGURATION
Two completely separate amps sharing common AC cord for maximum reliability and flexibility. All protection separate for each channel.
7. HIGH DYNAMIC HEADROOM AND MULTIPLE PARALLEL, LOW ESR FILTER CAPACITORS
Provides exceptionally tight, high-impact bass performance.
8. REINFORCED FRONT AND REAR RACK MOUNTS
9. PRECISION 31-STEP DETENTED GAIN CONTROL
Gold plated wiper and sealed body design assures accuracy and freedom from sonic degradation.

10. OVER-TEMP WARNING LIGHT
Begins flashing 10°C before thermal protect.
11. CLIP INDICATOR
Flashes during all types of amp distortion.
12. LEVEL INDICATORS
To monitor output.
13. POWER/PROTECT INDICATORS
Monitor status of Load Grounding™ protection relays. Relays provide delayed turn-on, instant turn-off, DC, sub-audio, power interrupt, and over-temp protection.
14. SEPARATE AC SWITCHES
Enable single channel to be powered up or down. Useful for emergency speaker changes during performance.
15. FRONT MOUNTED CIRCUIT BREAKERS
No fumbling around in the back of the rack.
16. RECESSED CONTROLS
Prevent damage and accidental movement.
17. MASSIVE OUTPUT SEMI-CONDUCTOR SECTION
Assures long-term reliability under abusive conditions.

BACK VIEW

1. 5-WAY BINDING POSTS FOR SPEAKERS
3/4 inch spacing for stereo or bridged mono.
2. BARRIER STRIP INPUTS AND SPEAKER TERMINALS
For gas tight permanent connections.
3. MULTI-COLOR INPUT/OUTPUT LABELS
For clear separation of functions.
4. BALANCED XLR INPUT JACK
5. OCTAL SOCKET
Accepts active and passive input accessories.
6. REAR SUPPORTS PROTECTS JACKS
And Octal Modules. Supports rear when rack mounted.
7. GOLD CONTACT INPUT SWITCHES-UNDER ACCESS COVER
Bypasses Octal Socket instead of external jumpers. Engages Bridge Mono. mode, and combines both channels for bi-amping, etc.
8. GROUND LIFT STRAP
Permits circuit and chassis grounds to be joined or separated for control of ground loops.
9. BALANCED 1/4-INCH INPUT JACK

QSC
AUDIO

QSC AUDIO PRODUCTS, 1926 Placentia Ave., Costa Mesa, CA 92627

CANADA: SF MARKETING, INC., 312 Benjamin Hudon, Montreal, Quebec, Canada H4N1J4

INTERNATIONAL: E AND E INSTRUMENTS INTERNATIONAL, INC., 23011 Moulton Parkway, Building F7, Laguna Hills, CA 92653

Write for details and specifications on these and other products.

Circle 19 on Reader Service Card

Digital Audio

Modulation Codes Continued

• Last month we developed the idea of using serial data communications as a way of simplifying the wiring of digital equipment. We also introduced the notion of a modulation code to represent the 1s and 0s of digital notation. These codes come in many varieties and they have many different properties. The property which we explored extensively was the spectral content or required bandwidth for a given bit rate. There are several other interesting properties which we also need to consider.

DC FREE CODES

Many codes, including the classical NRZ (Non-Return to Zero) baseband code, contain a significant amount of DC content. Consider 10 binary 1s followed by 6 binary 0s. If this signal is repeated, there will be a large amount of DC present. In certain applications, it is difficult or impossible to transmit this DC information. On a straight wire, DC transmission is easy. However, a tape recorder or RF broadcast link does not transmit DC very well—or at all.

FIGURE 1 shows the effect of having no DC gain on an ordinary bit stream. The effective threshold moves depending on the particular bit sequence. Because the received data must be used to regenerate a perfect bit representation, any change in the offsets will degrade the ability to create the regenerated bits. Since the received bits are already corrupted by bandwidth limits and added noise, we do not wish to add an additional corruption due to a variable DC threshold.

The Miller² (read this as "Miller



*Saturday, April 23, 1983
Hermann Hall
Illinois Institute of Technology
Chicago, Illinois*

- ⌘ *Recording – Playback*
- ⌘ *Measurement – Instrumentation*
- ⌘ *Speech Generation – Recognition*
- ⌘ *Telecommunications*
- ⌘ *Hearing Improvement*
- ⌘ *Music – Sound Generation*

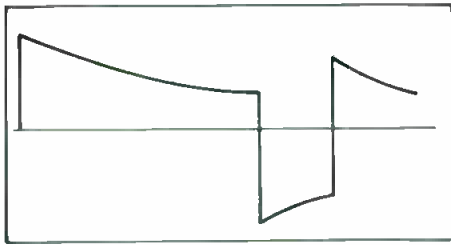

Figure 1. The effect of no DC gain.

squared") code is a modification of the MFM code discussed last month. (Although one of the names for MFM is Miller code, this is a different Miller from Miller².) If one follows the rules of MFM, as previously described, we observe that a sequence of all 0s is a square wave; hence, it is DC free. (DC-free does not mean no DC; only that the DC is fixed and not a function of the bit sequence.) Similarly, a sequence of all 1s is the same square wave shifted by half a bit cell; hence, it is also DC free. An odd number of 1s between 0s is DC free; but an even number of 1s between 0s is not DC free. Miller² modifies this latter condition by omitting the last transition in this case.

At this point we can begin to understand that the generation of a code can

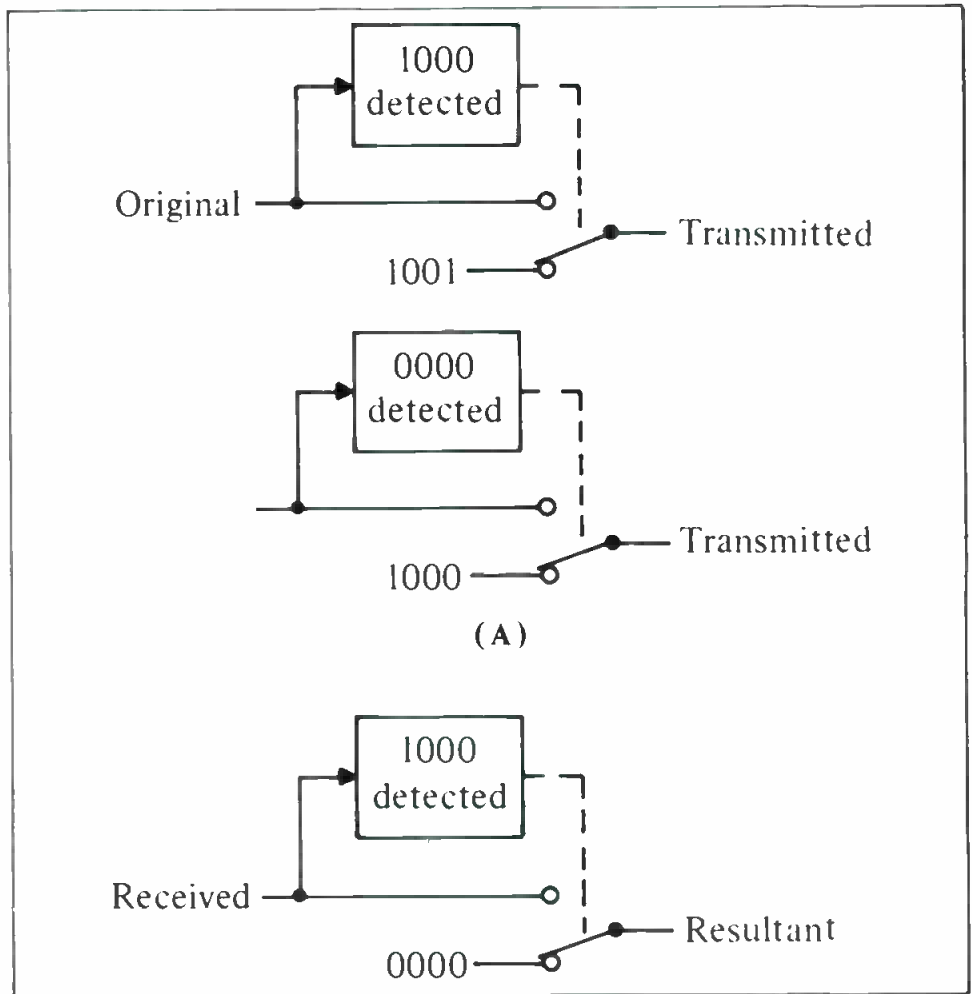

Figure 2. Creating an illegal code.



Success means having the right connections.

If your microphone goes dead during a performance, you'll never hear the end of it. That's why Shure designs and builds microphone cables to insure optimum audio performance under the worst possible conditions.

This design superiority is most apparent in the critical area where the cable and connector meet—the cable connector interface. Here, special design attention insures long-life durability and flexibility. On Shure's "Triple-Flex" cables, for example, a unique flex relief allows you to use this thin cable without it breaking or kinking.

Shure cables are also subjected to the most rigorous tests in the industry for appearance, strength and durability. For example, they must undergo a variety of environmental torture tests, including temperature extremes of -20° to $+165^{\circ}$ F and humidity of 95 to 99%. In addition, they are subjected to a series of stress tests including rocking, pulling and twisting to insure strength and long-life flexibility.

And, to guard against on-stage signal loss and external noise interference, Shure cables are designed to pass rigid capacitance, leakage, and shielding requirements.

It's no wonder Shure "Audio Connection" cables are the industry standard. Shure Brothers Inc., 222 Hartrey Ave., Evanston, IL 60204. (312) 866-2553.

SHURE[®]

THE SOUND OF THE PROFESSIONALS[®]...WORLDWIDE

DO YOU OFTEN WISH THAT THE SMITH COMPANY WAS THE SMITH & SMITH & SMITH & SMITH COMPANY?

Business people often find themselves doing so many things that just one of them isn't enough. So hire some of the needy and disadvantaged young people of America this summer to help you. Hiring them can also help you in another very important way. Because a business that hires economically disadvantaged youth during the summer may get as much as an 85% tax credit on the first \$1,000 of wages you pay them. Write the National Alliance of Business at P.O. Box 7207, Washington D.C. 20044. And support your local summer-jobs-for-youth programs. You'll be doing something for yourself, for your business, for your community, and for the needy youth of America, too.

LET'S GET ALL OF AMERICA WORKING AGAIN.

Ad A PUBLIC SERVICE OF THIS PUBLICATION & THE ADVERTISING COUNCIL



EL-15 Woofer

- 25-5000 Hz
- 200 Watts
- 100 dB M/W
- 4" Voice Coil

EMILAR

For complete information:

(714) 632-8500
(800) 854-7181

EMILAR CORPORATION
1365 N. McCan St.,
Anaheim, CA 92806

be made much more arbitrary to optimize any set of parameters. One such code is EFM. (Eight-to-Fourteen Modulation), which takes 8 data bits and looks them up in a table to acquire 14 channel bits. In addition, there are 3 bits added for merging. By carefully constructing the table according to specified rules, the resulting codes can be made to be self-clocking, DC free, maximum bit-rate, and noise robust. Of course, we cannot have everything, and these parameters will trade-off against each other. Once we understand the issues, codes can easily be modified and changed to suit the issues. Most of the current work on codes is directed toward the tape recording medium for digital audio tape recorders. That environment is particularly harsh in many respects. A serial system of interconnection of digital equipment in a studio is a much more benign problem in which many different codes will work quite well.

For a more comprehensive treatment of this subject, we suggest that the reader refer to the AES preprint 1856, "Channel Coding for Digital Audio Recordings" by Toshi Doi. It is available from the headquarters of the Audio Engineering Society for a nominal charge.

FORMATS

Let us now assume that we have selected a modulation code which is able to regenerate a local clock which can then be used in the demodulation of the code. This gives us our normal bit stream where a logical 1 is again the High level of TTL and the logical 0 is the Low level of TTL. If we look at such a bit stream, we see bit after bit but there is no way of knowing which bit belongs to which channel, assuming multiple channels on the wire; and we have no idea which bit is the MSB or which the LSB.

Formatting is the process of structuring the data to apply labels. Let us create a format for defining our wire as containing 10 audio channels of 16 bits each, running at a 50 kHz sampling rate. This gives us 160 bits every 20 μ sec. We might define such a group as a block. The concept of a block is a specified group of bits which form a natural unit. Because this definition of block results in a block repetition every 20 μ sec, it would appear to be a natural definition. Within this block we need to define a microstructure. We may create such as definition. At the beginning of the block there will be a "header" (to be defined), followed by the 16 bits of channel 1, followed by the 16 bits of channel 2, etc. After the last bit of channel 10, we may define a group of 16 bits for error correction or detection. The process of formatting is thus the process of defining the names of the bits in the block; this includes the

original data bits, additional control bits, error correction bits, synchronization bits, etc. Except for the data bits, all of the remaining bits are created only for the purpose of communications, control, identification, or error correction. This is a kind of overhead or tax on the transmission. Because the channel has a fixed bit rate, the more overhead bits, the less that data bits can be used.

Nevertheless, we will need these extra bits. The robustness of the format is usually proportional to the extra overhead bits. The first task is to create the header. This is a sequence of bits which serves the function of identifying the beginning of this block. In a simple example, we will add the restriction that the header must be unique.

Let us start by making the header a sequence of 32 consecutive 0s. Is this unique? The answer is no because if any two neighboring channels have zero value, then they will put out 16 0s followed by 16 0s. Even if this is unlikely, we still have not created a situation of uniqueness. To fix this situation we create the idea of an illegal sequence. The normal 2s complement data format for audio actually has one more negative word than positive word and we might wish to make the extra negative word illegal. Thus, whenever the formater sees the most-negative word 1000.0000.0000.0000, it changes it by 1 LSB to 1000.0000.0000.0001. We now have a free code which the formater can use to its advantage. The formater can now take the all-0s case of 0000.0000, 0000.0000 and substitute the illegal code of 1000.0000.0000.0000 on transmission and the reverse on the reception. What have we achieved by this? We have prevented the audio data word from ever creating 16 successive 0s, but we have not removed the audio data word of 16 0s. It has been moved to a new temporary location. Now the 32-bit header of 0s is truly unique. Whenever the receiver sees this sequence, it knows that it is at the beginning of the block.

The process is illustrated in FIGURE 2 (numbers are in octal, not binary). The original 16 bits from each channel is examined for the most negative word 1000/8. If present, a substitute replaces it. This substitution is never undone but is basically irrelevant. Having freed up one data word, we now detect the word 0000/8. If present, we substitute 1000/8. At the receiving end this is reversed. This rather complex task is not particularly clever, although it does illustrate one way to create illegal codes which make the header unique.

A more common way of making a unique header is through the use of an error correction or parity bits. For example, if we had added a 17th bit to each data word such that the number of 1s was odd, then there could never be 17 0s in one channel. Again, this is a

way of creating illegal code sequences which can then be incorporated into the definition of the header.

SOURCE INDEX

The header can be used for other functions. Even though we have defined 10 audio channels on the cable, there might be 30 pieces of equipment which could be on the channel. The header might thus contain a mapping table of contents that indicates which piece of equipment is on which channel. Each of the 30 pieces of equipment would be assigned a unique 5-bit number. In the header, after the start-identifier (32 0s), we would place 50 bits of labeling in 10 groups of 5 bits. It might identify a tape recorder from studio 4 as being on channel 1, a mixing console output from studio 3 as being on channel 2, etc. Anybody wishing to receive a piece of equipment would have its interface box examine the header for the particular 5-bit code. Once having found it, it would know which channel contains that source. Since the interface box would also know the format, it would be able to determine which of the data bits was that channel.

If you have followed the sense of the above discussion, your imagination should begin to start working. Suppose we allocate a mode bit in the header which specifies either normal mode or special mode. In special mode, all of the remaining bits could be made to be control bits for communicating the format to the interface boxes instead of audio data. At power-up time, the master interface then tells all the other interface boxes that the format for today will not be 10 channels with 1 bit of parity but 9 channels with 2 bits of parity. The structure of the format is thus stored in RAM rather than being frozen for all time in ROM. Mode bits could also be used to indicate that channel 10 is being used for electronic mail during the hours of 6 to 7 PM; and that communications to a main computer will be in those bits which had been channel 9.

Thus, our single audio cable now becomes part of a computer system, a teletype system, and maybe the central telephone. The channel capacity of the cable can be reassigned at will by the central processor which controls everybody.

What we are seeing in this discussion is that digital audio is just a subset of generalized digital communications. Once the data is in the digital format, the communications system does not care what the nature of the data is.

The telephone companies of the world are rapidly trying to completely convert all of their communications to a digitally-based format because of the inherent flexibility of digital bit manipulations. One can mix computer, teletype, telephone, broadcast audio,

etc. as long as the total bit rate does not exceed the channel capacity. The cost for transmission thus reduces to the number of bits per second which one wants to transmit. The cost of speech versus a letter is directly comparable. A 100-word letter contains about 4000 bits, which is about 2μsec of stereo audio.

Digital audio is not unique in the digital world and we should be tracking other technologies, since they offer us a large number of real advantages. The problems of interconnection in a digital studio will be the same as the interconnections of multiple personal computers and multiple telephones.

When we strive for such flexibility,

the tasks of the formater and blockers become very important. This is why the issues of standards are so difficult. On the one hand, we cannot enter this class of flexibility without a universal standard; on the other, an inadequate standard will destroy a lot of the features of this kind of system. Unfortunately, we are not always smart enough to know when we know enough to create the standard. Historically, industry tries to create standards a bit too early, and government tries to keep the standards unmade until it is too late. The dynamic tension is a good one but not one that makes us comfortable during the creation phase. We are in that phase now. ■

SONEX

FOR KILLING BACKGROUND NOISE

SONEX is a special sound-absorbing acoustical foam with a sculptured anechoic design that absorbs noise four times better than acoustical tile or carpeting. It emulates the sound quality of a professional recording studio at a low cost, so your voice-over sounds rich and clean. Or use it when mixing to hear the real sound on tape. Or use it on location to trap the sound you want and to kill the noise you don't want.

Get the facts today. SONEX is manufactured by Illbruck/usa and distributed exclusively to the pro sound and A/V Industries by Alpha Audio, 2049 W. Broad Street, Richmond, VA 23220.

Alpha Audio
804/358-3852
Acoustic Products for the Audio Industry

Questions With No Easy Answers

FORTUNATELY, Sam the mailman did not throw his back out as he carried in the response to our February editorial. (We had warned him it was going to be heavy.)

"Heavy? You call one letter heavy? What's heavy is—where are the rest of your readers. You send out 20,000, you get back 1.... Heavy it's not." (It's wonderful to get philosophy and mail all in one delivery.)

For the benefit of the 19,999, the one-and-only letter is reprinted in our Letters column. And it proves we were right all the time. When we said the response was going to be heavy, what we really meant was *content*, not quantity. Sam should have known that, but he left unconvinced. "Lucky for me I don't get paid piecework," was his parting shot.

And now, on to the heaviness. Like Sam, most of us are in the business of providing a service. So, what do we do when a client walks in and asks us to help him rip off another client? Of course, we refuse.

But what if that other client isn't ours? In fact, we've never even heard of them. It's just some outfit that makes cassette sales-motivation courses. Or maybe foreign-language tapes. Our own valued client wants an extra half-dozen copies to pass out to his associates, but he doesn't want to spend \$139.50-times-six, so he'll xerox the manual and we'll give him the tape copies, right?

It's probably a sign of early senility when we start remembering "the old days" when every client was expected to pay for services rendered. Well, maybe not everyone, but at least petty larceny was not yet on its way to becoming a national pastime. Today, with stealing being so easy, it's almost dumb to be honest. Why not makes those copies—who's going to find out? At least, that seems to be the current logic. Or, why buy when it's easier to "borrow"? (Maybe that's the

answer—it just wasn't so easy years ago.)

As noted in February, we think that a "Borrowing Tax" is a dumb idea. It's a too-light solution to our heavy problem. Actually it's no solution at all—it's just another crime.

Compounding the problem are the software manufacturers whose products don't deserve to be bought—at least not at the prices charged. We've got two recent examples. One is a Spanish language cassette series. The sibilant distortion is enough to rip out the speaker cones (well, almost). And we paid \$100 for this sonic disaster? And then there's our \$500 word processing software that doesn't come close to living up to its own advertising promises. It comes complete with all sorts of warnings about the dire consequences of making copies. But there's no word about getting it to work as promised, and the company doesn't respond to customer complaints. It would serve both of them right if we....

It's no big deal to rationalize how it's OK to steal from these crooks (or, if not crooks, then at least shoddy businesses). But what about that mostly honest software producer who's just trying to stay in business? And what about your client who just wants those six copies run off? And what about the kid down the block who's copying the latest chart-busters?

Well, we all know those damn kids are going to put the industry out of business. But what about ourselves? What can a tape duplicator do when confronted by the kind of client mentioned in Mr. Russell's letter? For that matter, how many owners of duplicating hardware have confronted the problem? And of those, how many have worked out a solution? Is there anything studio owners should be doing? Is there anything we can do?

Or is this just "someone else's" problem? JMW

TELEX

AUDIOCOM

For Communications Behind The Scene

AUDIOCOM. The closed circuit intercom for small, large, portable or fixed installations at concerts, stage productions, film or TV studios, stadiums or race tracks, industrial or public safety applications. AUDIOCOM belt packs or wall mount stations can be "daisy-chained" by the dozens over five miles without degradation in signal quality or strength. AUDIOCOM interfaces with other sound systems and telephone circuits. AUDIOCOM includes headsets, mics, cables, switchboards, signalling kits, even battery packs for remote locations; the complete intercom system for communications behind the scene.

Quality products for the audio professional.

**TELEX**

TELEX COMMUNICATIONS, INC.

9600 Aldrich Ave So Minneapolis, MN 55420 U.S.A.

Europe: Le Bonaparte—Office 711, Centre Affaires Paris-Nord, 93153 Le Blanc-Mesnil, France.

Circle 25 on Reader Service Card

Looking for a Distortion Measurement System?

The Amber model 3501 is quite simply the highest performance, most featured, yet lowest cost audio distortion and noise measurement system available.

It offers state-of-the-art performance with THD measurements to below 0.0008% (-102dB), maximum output level to +30dBm and noise measurements to below -120dBm.

It has features like automatic operation, optional balanced input/output and powerful IMD measurement capability. It includes comprehensive noise weighting with four user changeable filters. Unique features like manual spectrum analysis and selectable bandwidth signal-to-noise measurements.

The 3501 is fast, easy to use and its light weight and small size make it very portable. It can even be battery powered.

And the best part is that it is 20% to 50% below what you would pay elsewhere for less performance. The Amber 3501 starts at \$2100. Send for full technical details.



Amber Electro Design Inc.
4810 Jean Talon West
Montreal Canada H4P 2N5
Telephone (514) 735 4105

amber

Circle 27 on Reader Service Card

Landesstudio Steiermark

The following is a detailed look at the Steiermark Studio in Graz, Austria—the newest regional broadcast studio of the Austrian National Broadcast System.

THE EARLY DAYS

IN THE AUSTRIAN PROVINCE of Steiermark, the history of radio began on June 15, 1904. On that day, Otto Nussbaumer succeeded in transmitting wireless music down the corridors of the Graz Physics Institute. On hearing the guttural voices of Professor Nussbaumer intoning the Steiermark State anthem, the judgement of his students and peers was spontaneous—"His box works, but the sound is terrible!"

The government turned down a request for subsidizing additional tests. With typical bureaucratic logic, there was "no money for such hobbies." Eventually, Professor Nussbaumer lost interest in his transmitter and receiver and went on to pursue other interests. Some twenty years later—after other inventors had become famous—Austria reconsidered Nussbaumer's hobby, and the *Radio Verkehrs—A. G.* (Austrian Radio Transmission Corporation) was formed in Vienna. Broadcasting began shortly thereafter.

Soon, a relay station was conceived, and Graz was chosen for the first experiment. Franz Huber was appointed station manager, and in the still of the night, he cut down enough trees on the *Schlosberg* (Castle Hill) to make room for his transmitter mast. Broadcast service began on March 30,

Christopher Landmann is an engineer and freelance audio journalist.



Figure 1. Scale model of the Steiermark Studio in Graz, Austria.

1925 in a studio sublet in a nearby police headquarters.

A few years later, a plan to put up a studio building in the St. Peter section of Graz was greeted by a stormy protest movement (some things never change). The local citizenry feared that lightning might be drawn to their homes. But after long negotiations, this first Austrian Broadcasting Center was eventually built, opening its doors on June 17, 1929 and continuing in service until 1981.

Service deteriorated with the Nazi annexation and World War II. Radio under the Third Reich served centralized propaganda purposes, and no room was left for local interests. However, the energetic Franz Huber was able to persuade the then Minister of Posts (responsible for broadcasting service in most European countries) that Graz would be a suitable location for a high-powered transmitter for broadcasts to southeast Europe. In 1940, Graz-Dobl started sending out 100-kW multi-language propaganda messages. To house the required staff, Huber bought the Ferry Palace, and this remained the central studio building until 1981.

After the war, normalcy did not return quickly. First it was the Russians, and later the British Occupation Forces who were in charge. In either case, radio was an important medium for the victors, who wanted to redress the effects of Nazi propaganda, and generally exercise control over local development. Accordingly, Graz became the reporting center for an extensive network of foreign correspondents, and offered a daily fare of Red Cross missing person announcements, biographies of concentration camp survivors, and instructions to the citizens.

In time, some cultural activities were added: old radio hands returned, and new talent was found. In this respect, the British were open-minded, even going so far as to promote study tours to the BBC. In addition, they organized the Alpland Chain of stations with anchor points at Graz and Klagenfurt as a counterforce to the Russians, whose network was centered in Vienna.

With the end of the occupation, the new Austrian government embarked on the difficult task of reorganizing four separate regional structures into one national network. At first, regional interests gave way to centralism, with the purse strings under the control of the federal government. But the people demanded their own radio back, and the Austrian Broadcasting Act of 1967 brought about a parity in regional and federal programming.

GRAZ—THE FIFTH OF THE NEW ORF STUDIOS

With the opening of the Steiermark Studio, Graz at last ends decades of makeshift operations. The new facility combines engineering proficiency with the natural environment, in a building that is fashionable without being either luxurious or "over-built."

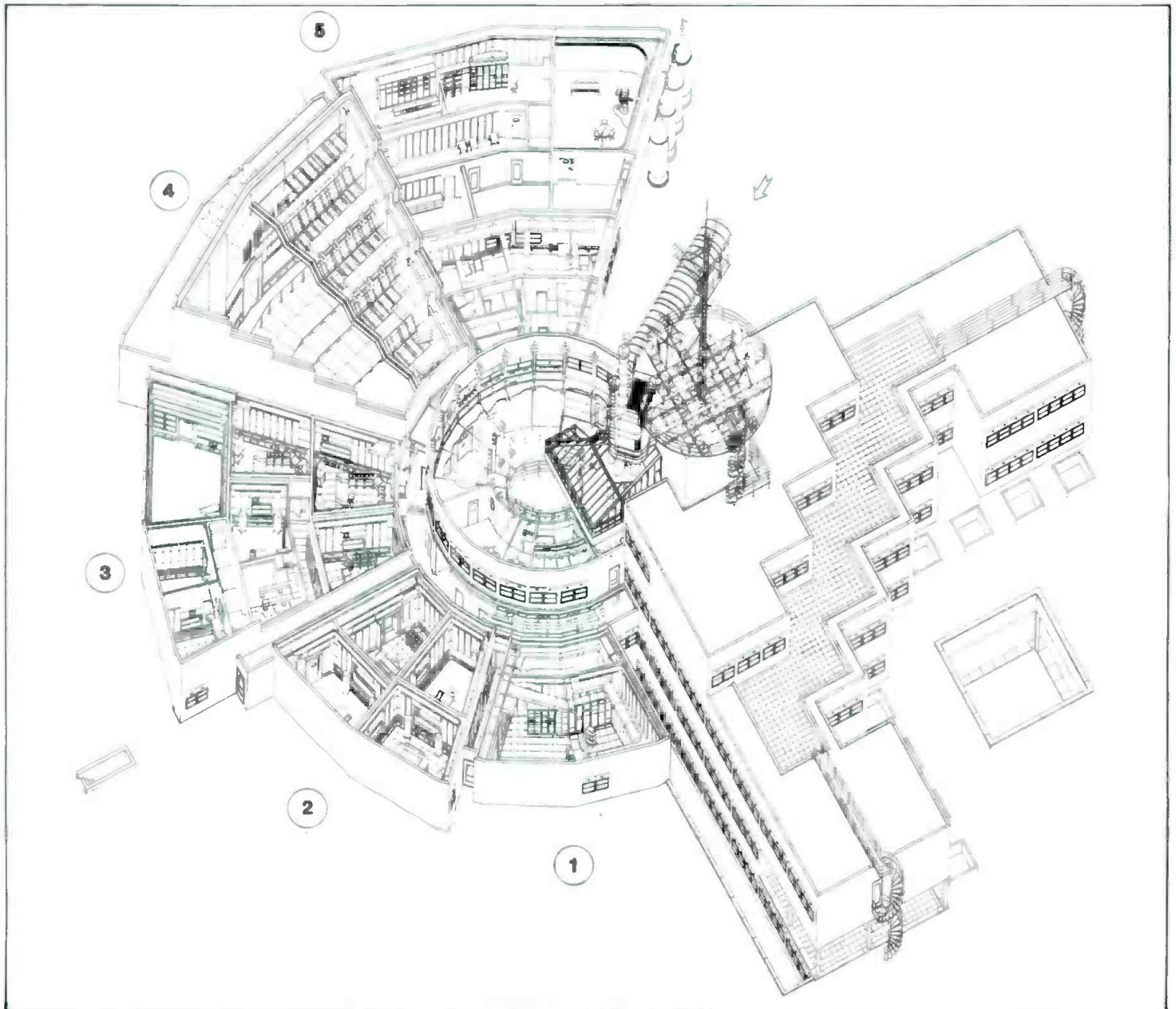

Figure 2. The Steiermark Studio. Sector one houses the control center and relay room; Sector two houses control rooms 1 and 2 and studios 1 and 2; Sector three houses studios 3a, 4, 5 and 7 and control rooms 3, 4, 5 and 7; Sector four houses the auditorium and studio 3, and Sector five houses the TV studio, library, rehearsal and lounge rooms, and the dressing rooms.

Landesstudio Steiermark is the newest regional broadcast studio of the ORF (*Osterreichischen Rundfunk*—Austrian National Broadcasting System). Located in the St. Peter section of the town, the Steiermark studio complex fits within an architectural concept developed a decade ago for the ORF's "western chain," which comprises Linz, Salzburg, Innsbruck, and Dornbirn. With the Graz addition—and later on, Eisenstadt—there will be six identical studio buildings dedicated to meeting a three-way challenge: to architecturally reflect the organization's spirit, to plan and build a cost-effective structure, and to convert a production concept into a three-dimensional reality.

THE STUDIO BUILDINGS

Professor Gustav Peichl's architectural design for the ORF buildings permits maximum planning flexibility, and signals a new direction for European Broadcast buildings. The radially-oriented floor plan permits both horizontal and vertical changes in the office structure. There is no absolute final form, yet the architectural concept assures that the total impression will not be affected by relocations or structural additions.

All the studio complexes have three main levels and a penthouse supporting an antenna platform. The floor plan is divided into two sections, with operational spaces in the center, along with offices for administration, engineering and programming staff.

Surrounding the functional center section are five adjacent sectors containing a control center, control and relay rooms, radio and TV studios, monitor rooms, an auditorium, library, lounge and rehearsal rooms.

The architecture fits in well with the open zoning of Graz-St. Peter. The building's relatively low silhouette has a landscaped roof terrace and subterranean garages under a lawn-covered courtyard. The large space in which the

facility is located has been laid out as a recreational park area.

THE ENGINEERING LAYOUT

Applying the operating lessons learned at the four earlier "Western Chain" studios, the ORF planning commission provided the following areas:

Multi-purpose Studios Studios No. 1 and 2 are for announcers and talk shows, and are 300 and 330 square feet in area. For optimum utilization, these spaces are equipped for recording as well as for live transmission, and both may handle more complex productions as required.

The Auditorium and Other Studios Studio No. 3 is a 2750 square-foot auditorium, suitable for recording orchestras and radio plays. It may also be used for TV productions and public functions.

Studio No. 4 comprises a sound-deadened 800 square-foot area, while Studio No. 5 is a 250 square-foot Announcer's studio. These studios may be combined and, in conjunction with the auditorium, offer three adjacent areas with widely varying acoustics.

The TV Production Area The Television control room contains all video and audio engineering equipment used for TV productions in the auditorium or in the central TV studio.

THE CONTROL CENTER

This area carries out all operational functions, such as the switching of incoming and outgoing signals, coordinating studios with the appropriate control rooms, switching of reporting and producer commands from mobile and outside relay units to the appropriate control rooms to provide real-time communication between the program director and on-location teams.

The control center also monitors the equipment in all the studios and within the central communications system.



Figure 3. City Hall of Graz, capital of the Austrian province of Styria.

The centrally located control desk incorporates 64 audio input monitor lines, 32 transmission monitor lines, and 15 transmission documentation (i.e., record) points. In addition, there is one input to the engineering control intercom, with 20 individual and four matrix circuits. Controls are provided for four radio contacts to the mobile units, which may be monitored and/or supplied with cueing information.

Most signal switching required by each control room is handled by remote control. Connections are available for outside lines, studio voice feeds, echo and reverberation, and signal monitoring with delay for editing, etc.

Power and battery voltage regulators are provided for central distribution of 24 volts to all consoles and equipment racks, via a voltage-monitor array system. Amplifiers are on eight separate 24-volt, 4-amp power supplies.

An output level monitor and documentation rack contain 18 check points, independent of those on the control desk. These permit monitoring all signal lines for audio quality and level. A documentation recorder records all locally produced programs.

Two program processor racks handle 14 outside sources and 8 console outputs, correcting, if necessary, levels and handling redistribution to the consoles and/or other racks in the Control Center. A somewhat similar audio monitoring routing rack can distribute 18 possible programs to consoles, and the offices to the chief engineer, chief producer, engineering supervisor and the monitor room.

An in-house program distribution rack routes each of the three ORF programs to the editorial desk and to the administrative offices in the building. A fourth channel relays the medium-wave (AM) broadcasts.

Within the mobile radio rack, four independent communications lines can be maintained to the mobile units via 13 logic boards, which also contain the necessary interlocks and routing functions to the consoles and transmitting outputs.

A similar design is used for the intercom for 24 individual terminals and 4 pre-selected matrix circuits (conference-call circuits). Another 12 terminals can be added within the present board capacity.

A master clock controls the timing of all slave clocks within the building.

A transmitter line rack raises signal levels to the +15 dB standard level prescribed by the Austrian Post-Office Authority for transmission.

THE PAUSE AND STATION IDENTIFICATION RACK

So-called Pause Signals are an important part of broadcasting in Europe, where air time is not thought of in terms of money earned for the networks. In place of paid commercials, the listener pays a monthly radio and/or television fee. This means that at the end of a program, the transmission may go dead until the next program begins. Split-second timing is rarely necessary, and announcers are not trained to bridge unexpected gaps. By regulation, commercial filler spots are not permitted. Instead, a pause signal—usually a musical chord or sequence—is supposed to keep the listener from re-tuning. Or, if he's just tuning in for the next program, the pause signal will be there to identify the station. Actually, it's all relative anyway, since the pause between pause signals is usually too long.

COMMUNICATION

Intercom equipment is provided for fast information transmission. In addition, there is an automatic centrex telephone system with 16 outside and 120 inside lines, and a microprocessor controlled internal phone system with 18

lines and 35 terminals. There are also dedicated communication lines between production and processing areas, telex, APA (Austrian Press Association) telex, telefax, and telepix fixed-image transmission to ORF Vienna.

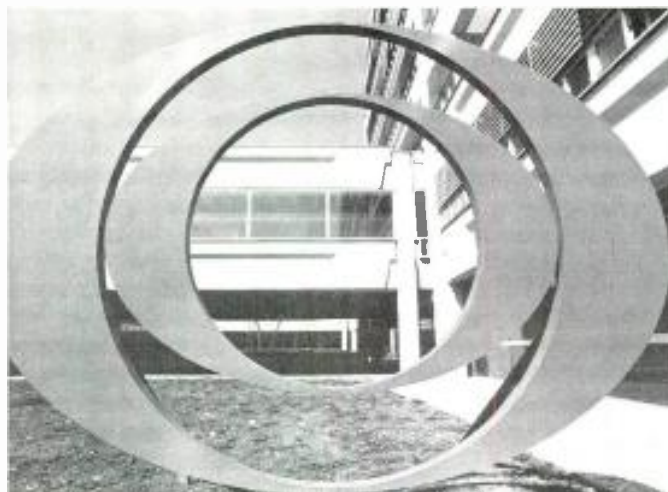

Figure 4. The symbol of the ORF (Osterreichischen Rundfunk—Austrian National Broadcast System).

TV AUDIO EQUIPMENT

For TV production, the consoles are equipped with both video and audio controls, permitting one-person operation on less-demanding projects. The audio section comprises a 10 × 2 mixer, plus the necessary support functions.

The TV control room also has two audio tape recorders, as well as connections for record players. Amplifiers, power supplies, switching controls and peripheral equipment are mounted in a separate audio rack. Signal processing equipment is remotely located.

The TV Interview studio is equipped with desk, microphones, monitoring, intercom and telephone systems. For larger productions, the interview desk can be tied into the auditorium network.

BROADCAST AUDIO EQUIPMENT

The audio equipment for radio broadcasting is similar in all studios of the "Western Chain," but these are modifications in Steiermark to take advantage of the latest state-of-the-art hardware.

Analog equipment is used for mixing and recording, while remote controls and signalling are mostly digital. In this respect, Graz differs from the rest of the Chain, which is still mostly analog.

The audio consoles in the smaller rooms are equipped with nine stereo line input modules, three mono microphone inputs, one stereo microphone input, one reverberation module and two stereo summing buses.

The consoles used for orchestral productions and radio plays contain 16 mono inputs, 7 stereo inputs, two reverberation modules, and 8 output buses.

One may look in vain throughout Europe for other regions as small as the Austrian provinces which are served by such efficient, well-equipped facilities. The unusually high technical level of the Steiermark studio facility makes it well equipped to meet all the demands of local radio and regional television production. Austria's German language literature and new musical idioms would be much poorer if it were not for the enthusiastic—and sometimes daring—experimentation and pioneering now going on at *Landesstudio Steiermark*. ■

Superjam '82

The use of dual monitor systems at this Labor Day concert helped keep things running smoothly—and on time.

"SUPERJAM '82," a rock concert held in the Liberty Bowl, Memphis, Tennessee, on Labor Day weekend, created a super opportunity for the management and staff of dB Sound, a Chicago-based supplier of traveling sound systems.

GETTING IT ALL TOGETHER

Bruce Gordon, vice-president of dB Sound: "Around July, 1982, we realized that all of the bands scheduled for the Memphis concert were touring with dB Sound systems and that they would all be coming together on September 4th. That presented a few problems in logistics, but it also presented an opportunity for us to accomplish some unique staging with the systems."

Superjam '82, a promotion of Mid-South Concerts of Memphis, would include R.E.O. Speedwagon, Kansas, and Joan Jett with Survivors as the opening act. R.E.O. and Survivor were performing on the same tour with one sound system, and had a performance scheduled in Hampton, Virginia, on September 2nd. Joan Jett was to play in Allentown, Pennsylvania, on the 2nd, and Kansas' last date before Memphis was to be Chattanooga, on the 3rd.

Gordon commented, "Besides these systems, dB Sound systems was also touring with 'Beatlemania' and with the O'Jays. Because Joan Jett could use the system set up for Memphis, we diverted her regular system to St. Louis, where we supplied sound for Molly Hatchet at Six Flags on the 4th."

Superjam '82 also presented the special problem of a stage call set for 9:00 p.m. Friday night, partly to allow sufficient travel time for all concerned, and partly to save expenses for set-up crews. Normally the stage call would be for noon of the day before the concert. Harry Witz, president and chief sound engineer for dB Sound: "The pressure going in to

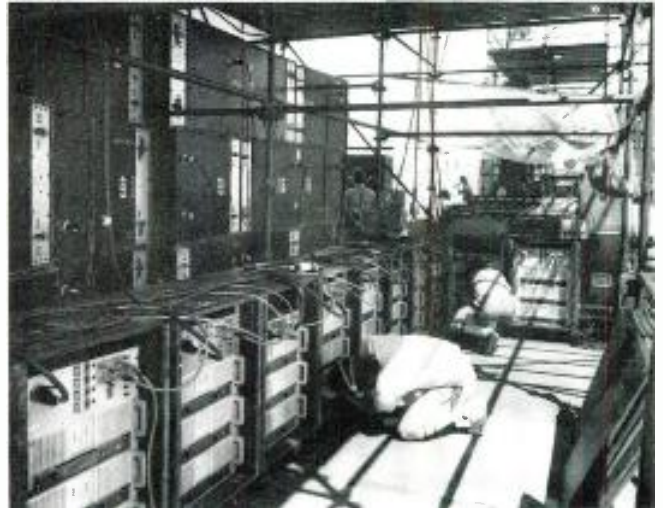

Figure 2. dB Sound personnel check operation of the amps as Survivor (on stage) swings into action.

Memphis was unbelievable, but by now we have a certain standard configuration for outdoor concert sound systems; and our people can put it all together pretty fast." By 3 a.m. on Saturday it was all together, ready to start sound checks.

One reason for the speedy assembly is the speaker cabinet design which dB Sound has developed. All the hardware is integral to the cabinets, which makes it easy to fly or stack them quickly. The design is facilitated by the fact that dB Sound is part of an audio conglomerate which includes R & R Cases, a builder of cabinets and cases for touring groups.

According to Gordon, R & R has achieved a good reputation for building some of the most rugged cases around. And that one feature has sometimes meant the difference between adequate and good.

Witz also believes that the idea of using a scissors lift to get lots of speaker cabinets to the second and third level quickly is one of the contributing factors in dB Sound's efficiency, although he is quick to point out that "things move so fast in this game that it's sometimes hard to sort out who did something like this first."

Memphis was, however, certainly unusual in that two monitor systems were available with which both performers and sound crews were familiar. Said Witz, "Once we had everything in place and turned on, all we had to do was run the mike checks. Mike and speaker placement, mixer and equalization settings were already known, so we didn't have to run sound checks between groups. And that one fact, which could only have happened because all of the systems were ours, was responsible for the show ending ten minutes ahead of schedule, with a full performance from everybody. Needless to say, the promoter was delighted." So was Walter Dawson, reporter for the Memphis *Commercial Appeal*.



Figure 1. One of two on-stage monitor mixers gets set up by the crew of dB Sound as the audience begins to fill the stands.

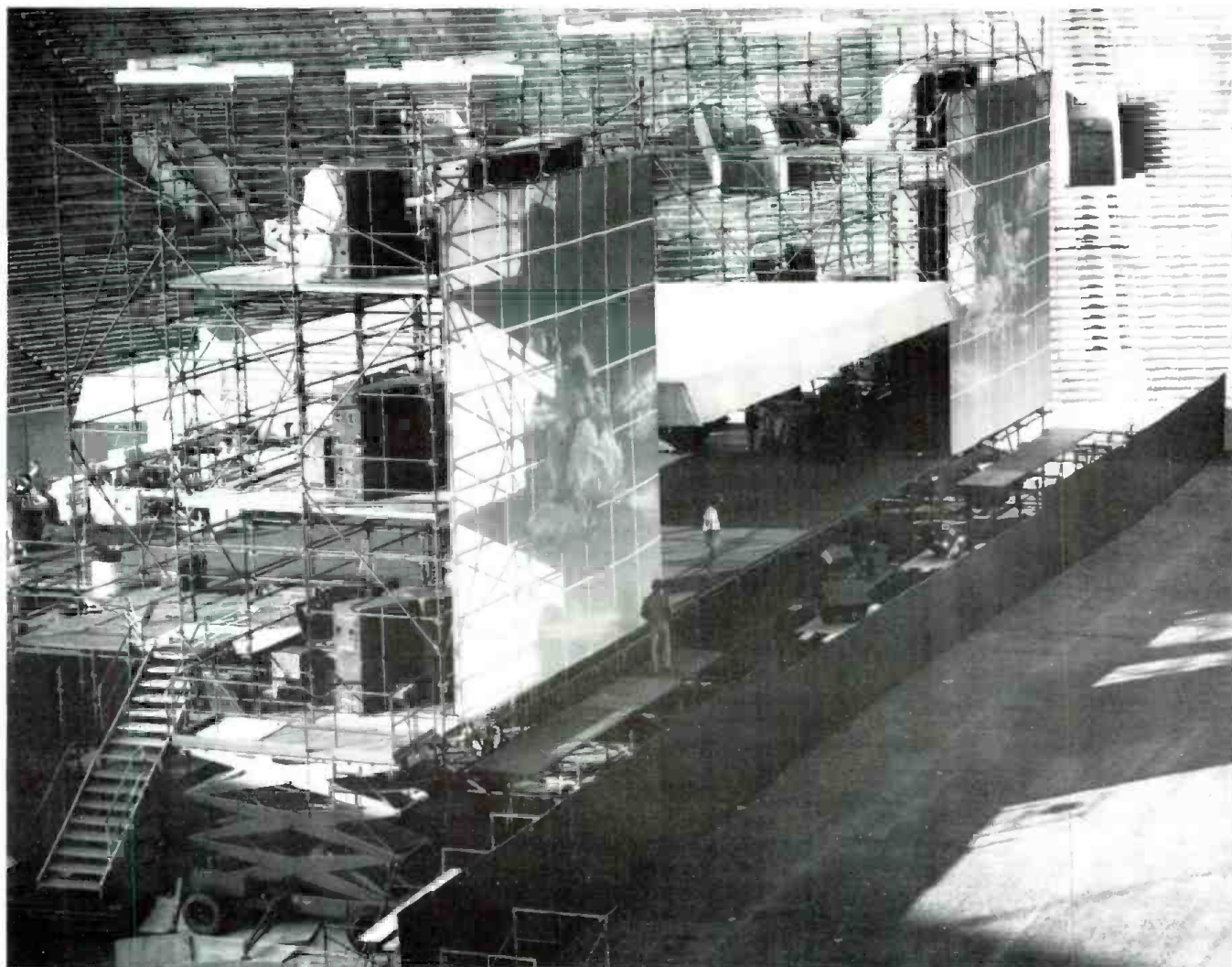

Figure 3. The morning of the concert. A bare stage, with the basic equipment all in place. A scissors-lift, whose use in such concert set-ups was pioneered by dB Sound, is visible at lower left.

Writing in Sunday's paper, Dawson said: "It was perhaps the smoothest-running outdoor show of its magnitude ever done in Memphis....The day began right on time and stayed there."

THE MONITOR SYSTEMS

The two monitor systems were set up and connected prior to the show, with one mixer on stage right and the other on stage left. Stage right was the unit touring with Kansas, a 30 x 10 Pro 4M Monitor Midas with SAE 2700B graphic equalizers. All monitors were biamped with Crown 150 or DC300A amps for the top end, and DC300A or PSA-2 amps for bass. The stage left monitor mixer was the R.E.O. Speedwagon/Survivor unit, which is a similar set-up. Bruce "Slim" Judd, a senior dB Sound employee assigned to R.E.O., and Rob "Cubby" Colby, traveling with Kansas, manned the monitor mixers.

Witz remarked, "This unique monitor arrangement was the most interesting aspect of Memphis to me. We'd never before had two monitor systems, operating on an alternating schedule, at such an event. Moving speakers and cables between groups didn't present half the problems we thought it would, and the ability to have systems in place, all tweaked up and ready to go when the performers came on, did a lot to maintain a real show-business tempo for the entire event."

SYSTEM LOGISTICS

The staff of dB Sound, during the Labor Day weekend, was guiding the movements of four separate systems, each with its own trucks and crew. On stage at Memphis was the system on tour with R.E.O. Speedwagon complete with speakers.

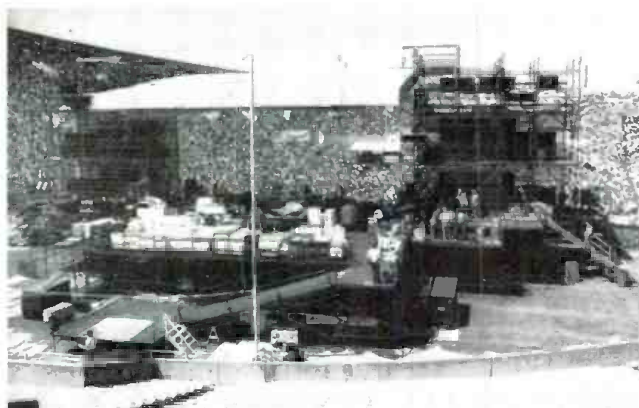

Figure 4. The view from behind the stage. A beautiful day, warm breezes, bright sunshine—and smashing sound.

amps, house mixer and monitor system.

The Kansas system was also in Memphis, but most of it stayed in the trucks, with only the monitor system on stage. The Joan Jett system went to St. Louis for use by Molly Hatchett. The fourth was a stand-by system, containing twelve blocks of amps and speakers, assigned to Superjam '82 for back-up and support with dB Sound's Kevin Trock in charge.

The three-deck system used at Memphis is rated (full power) at 100,800 watts, according to Witz. The system is modular, containing 24 blocks, each block consisting of two bass cabinets and two three-way cabinets plus an amp rack.

Each deck of the array contained four main columns and two sides of speakers. From center stage out, these columns were 8-high 3-ways, 8-high bass, 8-high bass, 8-high 3 ways, 6-high bass and 6-high 3-ways. Witz said, "The 6-high side columns are a little unusual, but the promoter expected the crowd at the extreme sides to be a little thin, so we didn't want to be out at full power on the sides. Like all football stadiums, the Liberty Bowl can provide some pretty screwy sounds if you don't have bodies filling up those benches." Fortunately, the weather and the crowds cooperated to fill the stadium, with a paid attendance of 33,000 in the stadium. (The Liberty Bowl normally seats about 50,000, but the south end of the stadium was not used for Superjam '82.)

Both Gordon and Witz believe that the systems provided by dB Sound are special, that they provide a more powerful sound with less distortion. They also believe that the reason for that is the cabinet design which dB Sound has developed.

THE CABINET DESIGN

Witz remarked, "There's no reason why anyone can't duplicate what we've done, except for the cabinet design. That's ours, and I don't care to discuss those dimensions with anyone but Bruce and the guys who build them."

Witz will only describe the bass cabinet as multi-cell, multi-flare front loaded 15-inch horns which use JBL 2225s as the drivers. He feels the horn/driver combination offers a more "rounded" vocal sound due to the multi-cell, multi-flare design. According to Witz, folded-horn or reflex designs don't allow higher frequency projection. Without the addition of a 12-inch horn, they don't respond well over 250 Hz. The design also uses a higher crossover point for the bass cabinet than is usual for such systems.

"That gives us an extended range on the bass end," Witz said, "which we can only do because of the front loading, allowing a shorter excursion of the driver. IM distortion is reduced and gain is increased. It is a more efficient speaker, a little less flat than some others, but easy to equalize."

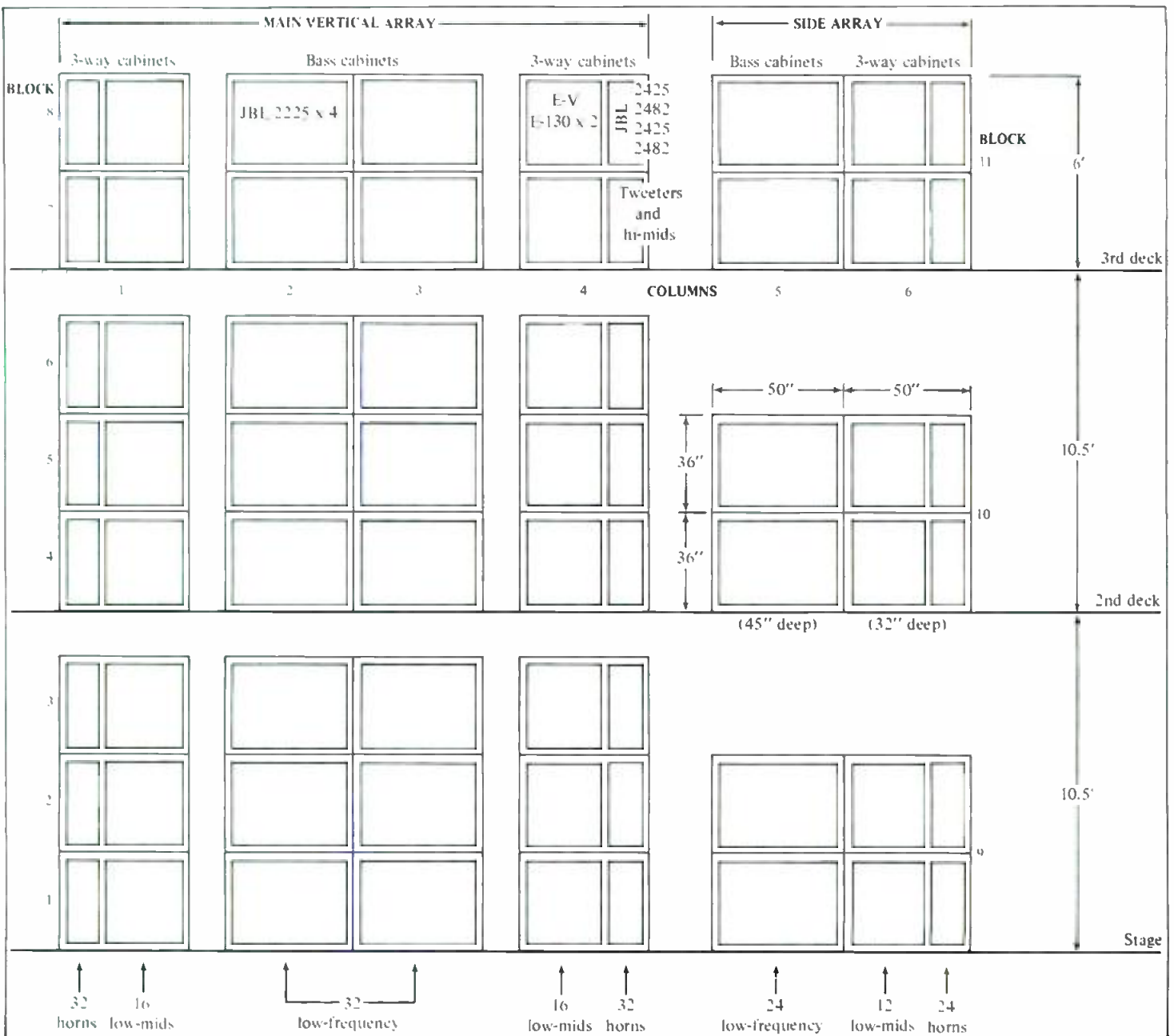

Diagram of the three-speaker system employed by dB Sound at Superjam '82.

The other advantage stemming from the high crossover point used by dB Sound for its woofers is that the mid-range speakers need to handle a shorter range of frequencies, again leading to fewer distortion problems and cleaner sound.

The three-way cabinets used by dB Sound include two JBL 2425 high-frequency tweeters driving 60° radial horns, two JBL 2482 high-mids driving 60° elliptical horns and two JBL E-130 low-mids in front-loading horns. All cabinets are designed by dB Sound and built by R & R Cases.

Design of the speaker-cabinets is further complicated by the need to keep all exterior dimensions to even fractions ($\frac{1}{2}$, $\frac{1}{4}$) of truck body width for efficient loading. "It's all part of the fact that the entertainment business is a business, and we have to be good at that, too," Gordon said.

Amp racks in systems supplied by dB Sound include three Crown PSA-2s running in the dual-channel mode. One amp powers eight bass speakers (four per side), another powers four low-mids, while the third powers four high-mids on one channel, and four tweeters on the other. Each amp rack includes a dB Sound-designed connection control module which makes assembly and maintenance simpler. "Even if we lose an amp," Witz said, "all we need to do is set a replacement on top of the rack, and change a couple of cables on the back side."

For Superjam '82, the house mixer platform was built roughly on the fifty yard line, where Witz figures the sound probably reached 122 dB peaks. It was a "shopping center" of audio equipment, with three separate systems set up and operating.

"My one heart-stopping problem," Witz smiled, "was to walk in on Friday night and find that the carpenters had set the 24' x 16' mixing stage six feet too high. I can't get a good mix if my ears are too far above the crowd's, so they had to reset it, which they did in good time, about four feet above ground level."

For Survivor and Joan Jett, Witz used a Midas 32 x 8 x 2 board, with Lexicon Prime Time, Ursa Major Space Station and Roland Space Echo as effects.

Kansas' performance was mixed by their own Davey Moire, using a Soundcraft 3B 38 x 8 x 2. Outboard effects included an Ursa Major Space Station, Lexicon Prime Time, Eventide 910 Harmonizer, two UREI 1178s, two Klark-Teknik DN-27s and a Lexicon PCM-41.

Both of the systems were slaved with the R.E.O. Speedwagon board, which is a custom unit, designed and built by dB Sound in 1977. The "Mother-Ship," as it is called by the crew, is manned by Robert "Bub" Phillippe for R.E.O., with Witz assisting. Witz describes the board as a 32 x 16 x 2 x 2 with a 14 x 2 wing that is independently assignable to any of the 16 subs on the main board.

Effects on the Mother-Ship include Lexicon Super Prime Time with extended time and 40 effects memories, Eventide Harmonizer 949, Lexicon Delta-T, and Ursa Major Space Station. The board's drive system also includes two Klark-Teknik DN-27s, two Soundcraft crossovers, and 8 dbx 160s for drive and limiting.

Revox and Technics cassette decks are used to obtain "for-the-record" tapes. Witz aims two stage mics at the audience and blends them into the tape send through the fader section of lines 33 and 34 on the Mother-Ship wing. Performance signal is direct out of the board through the EQ section of channels 33 and 34 of the wing. "When they review the tapes, the bands like to hear how the whole performance sounded, including crowd reaction, and this is a simple way to get it," said Witz.

Harry Witz, with characteristic modesty, claims that set-up, operation and load-out (4½ hours, almost a new record for the crew) of the sound systems for Superjam '82 were "very routine; no real problems." Spoken like a true showbiz veteran. ■



UNCOMPROMISING WIRELESS MICROPHONES

Finally, you can choose a wireless mic to fit the application. The Telex WHM-300, the electret wireless transmitter mic for uncompromising speech clarity. Or a Telex WHM-400 dynamic wireless transmitting mic for vocal entertainment with rich, full bodied audio quality. Both elegantly tapered and without trailing antenna wires. Or select the miniature electret WLM-100 lavalier mic (or any standard dynamic mic) with our belt-pack transmitter.

Combined with the superb Telex dual diversity* FM receiver, you'll have a wireless system that is as good as any hard wired mic, and at a reasonable price. Write us today for full details.

Quality products for the Audio Professional

TELEX

TELEX COMMUNICATIONS, INC.
9600 Aldrich Ave. So. Minneapolis, MN 55420 U.S.A.
Europe: Le Bonaparte - Office 711 Centre Affaires Paris-Nord 93153 Le Blanc-Mesnil, France

*U.S. Patent No. 4293955. Other patents applied for.

Acoustic Design in Natatoriums

And you thought all you had to do was fill it with water and jump in.

FOR DECADES, INDOOR natatoriums (or swimming pools) have been noted for their generally poor acoustic properties. At swimming pools around the country, swimmers and spectators alike have often run the risk of drowning in a sea of excessive noise levels and high reverberation times.

Most natatoriums are built with concrete, ceramic tile, metal and, in recent years, glass—to utilize solar energy. While these materials meet the criterion for moisture resistance, they have very poor sound absorption properties, resulting in echoes and reverberation that linger in the enclosure, creating an annoying din. As a result, distracting noise levels and a generally unpleasant acoustic environment have come to be tolerated as part of the price of enjoying year-round aquatic sports. The sonic smorgasbord is not only annoying, but is potentially dangerous, since it could prevent lifeguards from hearing cries of help.

Fortunately, architects and mechanical engineers are becoming more aware of the importance of considering the acoustic environment early-on in the design stage. More emphasis is now being placed on the creation of an acoustic environment in which the noise level is as soothing as the water itself.

Needless to say, this has not always been the case, and early attempts to correct the acoustic environment of natatoriums were haphazard at best. Often as an after-thought, various materials and acoustical systems were retrofitted to the structure, in an attempt to correct an adverse condition. Rarely was consideration given either to the overall acoustic response of the space or to such interacting variables as noise generated by HVAC systems, reverberation time, general ambient noise, and the relative humidity of the enclosure. Meanwhile, the public has long since accepted the fact that indoor swimming pools are extremely noisy places.

The recently opened \$7 million Cerritos Olympic Swim Center encloses nearly ¼ million cubic feet of space, with bleacher seating for up to 15,000 noisy spectators, and a pool area 52 meters long and approximately 23 meters wide. In approaching the acoustic/electronic design of such a facility today, it is important for the acoustician to coordinate with the architect and the mechanical engineer in order to establish acoustic design criteria. Overall reverberation time, noise criteria (NC), and types of construction materials must be considered.

By defining the end-design criteria early, and coordinating the efforts of the entire design team, it is possible to

Richard L. Hughes is an acoustic/electronic consultant with the AE Design Group in Mountain View, California. Mr. Hughes wrote the computer software programs utilized in the acoustic design of the Cerritos natatorium.

Milton F. Johnson, A.I.A., is a principal in the Mountain View firm of Johnson/Anderson Architects, A.I.A.

accomplish the task of integrating architectural acoustics, noise and vibration controls, and electronic systems into a compatible, aesthetically pleasing—and maximally effective—environment.

A recent development is the use of the computer to assist the acoustical consultant in the analysis of the acoustic properties of the space, while the proposed structure is still in the early design stage.

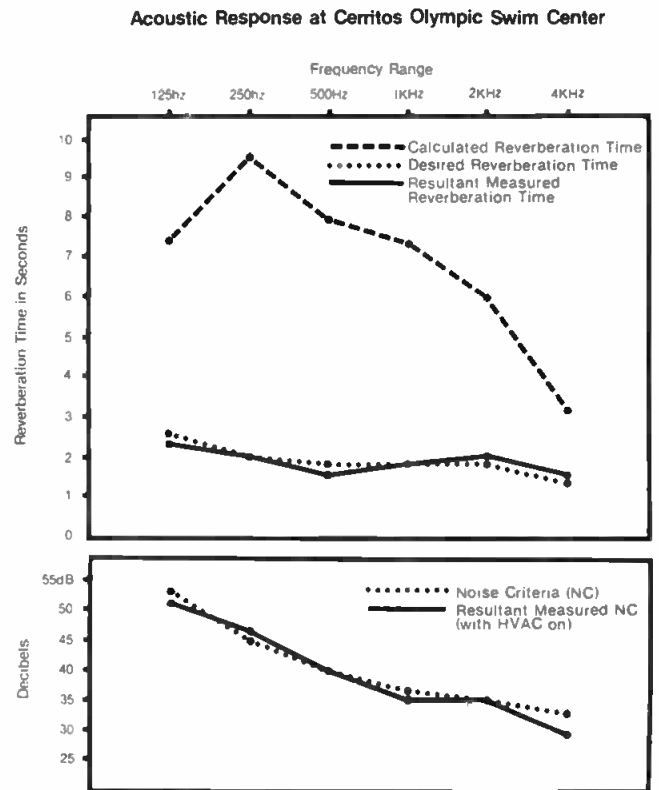

Figure 1. The acoustic response at the Cerritos Olympic Swim Center.

DETERMINING DESIGN CRITERIA

In the initial design phase, the following analysis should be made:

1. Volume/surface analysis.
2. One-third octave band analysis.
3. Determination of expected, and desired, reverberation times.
4. Establishment of desired noise criterion, and preliminary review of mechanical design.

These steps may now be accomplished through computer programs that allow analysis of the proposed space on a three-dimensional configuration, instead of the inaccurate and outdated two-dimensional method.

The three-dimensional analysis, based on the Fitzroy equation, provides detailed and accurate information

relative to the individual dimensions and geometric planes. The space is initially divided into the three planes—floor/ceiling, east/west walls, and north/south walls. Individual acoustic properties are then calculated, and the direct interaction of each plane and surface area is determined. The consultant can then change the spatial shape, material specifications, and placement of acoustic elements to bring the design within acceptable acoustic tolerances.

This design approach has proven to be very reliable, since the type, amount, and placement of materials can be determined with ease and accuracy. With the use of computer models, numerous design considerations can be considered in a relatively short time. The greatest advantage of this type of design is the accuracy of the projected-versus-actual measured results (see FIGURE 1).

Computer analysis revealed that sound at some frequencies could linger in the proposed structure for as long as

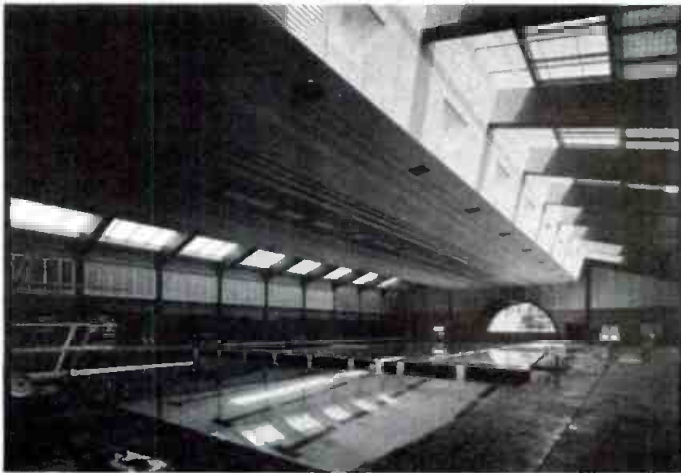

The Cerritos Olympic Swim Center.

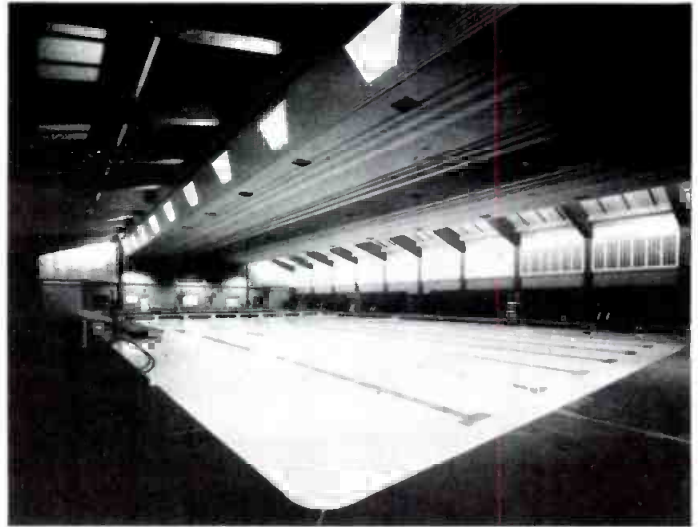

9.6 seconds, with lower-frequency sounds reverberating for 7.4 seconds, and shrill high frequencies taking 3 to 6 seconds to decay. The goal was to reduce this reverberation time to 2.5 seconds at the lower frequencies, and 1.4 seconds in the upper frequency range—well within acceptable and comfortable levels.

THE ACOUSTICAL CEILING SYSTEM

Initial computer calculations showed that the floor/ceiling plane has the highest reverberation time and would require the greatest amount of acoustical treatment. For obvious reasons, all of the acoustical treatment would have to be concentrated in the ceiling area. The decision to conceal the large HVAC ducts worked to the architect's advantage, since it increased the overall ceiling surface area.

Data on several types and configurations of acoustical

10,500 REASONS\$



to buy a Soundcraft 800B

10,500 reasons to buy or spec this Soundcraft? You bet! You save \$10,500 over Yamaha's comparable PM2000 listed at \$33,000*... with Soundcraft's 800B affordably priced at only \$22,500.* It's the most cost-effective and versatile live performance mixing system on the market. But keep adding reasons! You even get these distinct advantages:

- 3 frame sizes
- 8 bus with stereo re-mix output
- 8x8 matrix output with EQ
- Effects return output option
- Full power supply status indication
- Compact: 5½-ft long, under 200-lbs

Call your nearest Soundcraft Dealer today or mail coupon for complete information.

*Manufacturer's Suggested Retail Price, 1/13/83.

Soundcraft Electronics, Inc.
1517 20th Street
Santa Monica, CA 90404 (213) 328-2595
 Please have nearest Soundcraft Dealer call me.
 Please send me 800B brochure.

Name _____ Tel. (____) _____

Company _____

Address _____

City _____ State/Zip _____

ceiling materials were entered into the computer, which then calculated the resultant reverberation time. Almost instantly, the analysis gave the architects the information that was needed to lower the reverberation time to within acceptable limits.

Based on an evaluation of performance and cost, the Alcan Planar perforated aluminum ceiling system was selected. The Planar system consists of long linear panels manufactured by Alcan Building Products, and these are available in many colors, finishes and profiles. The panels are snapped onto lightweight carriers suspended from the ceiling or mounted on a wall area. Depending on acoustic and/or aesthetic consideration, the carriers may be installed in a wide variety of configurations.

To achieve the desired acoustic/aesthetic results at the Cerritos pool, 24,000 square feet of ceiling area was covered. It was also determined that low-frequency absorption would be increased, and flutter echoes reduced, by mounting the Planar system on the end walls. In a modified configuration, four-foot metal units were mounted vertically and tapered outward on two-foot centers.

To increase the acoustic absorption properties of the perforated Planar system, a two-inch thick, 1.55 pound density blanket of Fiberglass with a polyethylene cover was placed behind the ceiling system. For other installations, the thickness, density and amount of absorptive material could, of course, be varied to suit the requirements of the site.

The Planar ceiling system has also been utilized by Johnson/Anderson in other natatoriums, including the Barstow, California, Community Swim Center. In addition to meeting most acoustic design criteria, the Planar system is moisture-resistant and durable. Once in place, it requires little or no maintenance.

THE PUBLIC ADDRESS SYSTEM

With reverberation problems largely solved in the ceiling system, attention was now directed to acoustic problems

associated with the public address system. Adequate sound levels are not difficult to achieve. But unless architectural acoustics are considered, the overall intelligibility of the sound system may prove to be inadequate, and the end result becomes just one more irritating noise source. Simply hearing amplified audio is no guarantee of intelligibility.

For the spoken word to be heard and understood, the overhead sound system must maintain a volume level 5 to 10 dB above the ambient noise level, and the overall reverberation time should not exceed 2.5 seconds. At the Cerritos pool, the volume of the public address system is automatically adjusted by means of a noise-sensing amplifier. This unit constantly monitors the noise created by swimmers and spectators, and provides automatic adjustment of the p.a. system's volume level. The system has been equalized and balanced by using one-third octave and narrow-band notch filters to match the acoustic response of the space. The process matches the overall frequency response of the sound system to the acoustic environment, and provides natural sound and adequate gain before feedback. An Industrial Research Automatic Mixer is used in the system, while all other major hardware (automatic noise control, time delay, equalizers, amplifiers, compressors, etc.) is from Ivie Electronics.

Sound systems are generally of three types: point source, distributive, or a combination of both. A distributive speaker system for both the overhead and underwater speaker system was selected. The underwater system is an inverted format similar to the overhead speaker system.

The underwater speaker system is mounted on the bottom of the pool, instead of in the conventional sidewall installation. This reduces acoustic distortion toward the center of the pool. And, because swimmers may be hearing both underwater and overhead speaker systems, the pool-bottom speaker system is equipped with a time-delay set at about 40 milliseconds. This helps to minimize the acoustic distortion created by the sound travelling faster through the water than through the air.

Electro Voice PRO 12B speakers were selected for the overhead distributive speaker system. University UW-30 underwater speakers, modified for depths greater than eight feet, were used in the pool itself.

THE HVAC SYSTEM

In evaluating the HVAC system, consideration was given to the air-handling requirements, location and mounting configurations of the return/supply fan units, duct noise, and pressure drop. Needless to say, such a large facility requires a large HVAC system and numerous complete air changes per hour.

The main HVAC units are located outside the main space, thus providing isolation from vibration and noise. It was found that the combined use of in-line duct silencers and duct lining provided the needed noise reduction at the various frequencies. In large HVAC systems, the use of in-line duct silencers has proven to be quite effective, but the self-noise generated is often too high within the mid- and high-frequencies, whereas the use of duct liner alone does not always provide the needed attenuation because of the lack of sufficient duct length.

In late July, acoustic tests were conducted at the completed Cerritos Olympic Swim Center, and the results are proof of the benefits of acoustic planning in the early design stages. The overall design of the natatorium and the Planar ceiling system brought the reverberation time well within the desired limits. Noise from the HVAC system is at an absolute minimum and the public address system provides clear, undistorted sound throughout the structure.

Optimum acoustic design in natatoriums can be successful when acoustics are taken into consideration during the very earliest design stages. It is possible to provide good natural sound at adequate levels in an environment typically known for poor acoustic properties. ■

STL Offers The Most Complete Selection

Of Test Tapes

Available Anywhere

STL can serve all your needs with precision test tapes for frequency alignment, level set, azimuth set, flutter & speed tests, sweep frequency tests and pink noise analysis. Also available is the Standard Tape Manual & the Magnetic Tape Reproducer Calibrator.

Phone for fast delivery or free catalog



STANDARD TAPE LABORATORY, INC.

26120 EDEN LANDING ROAD #5 HAYWARD, CALIFORNIA 94545 • (415) 786-3546

THOMAS HAY

A Postscript on Grounding

A GROUND LOOP within an equipment rack is a typical problem when devices—usually in metal cases—are mounted in a meter enclosure, as seen in FIGURE 1. Even if each piece of equipment is balanced and has an acceptable internal ground reference, there may still be a problem. Small currents may be induced

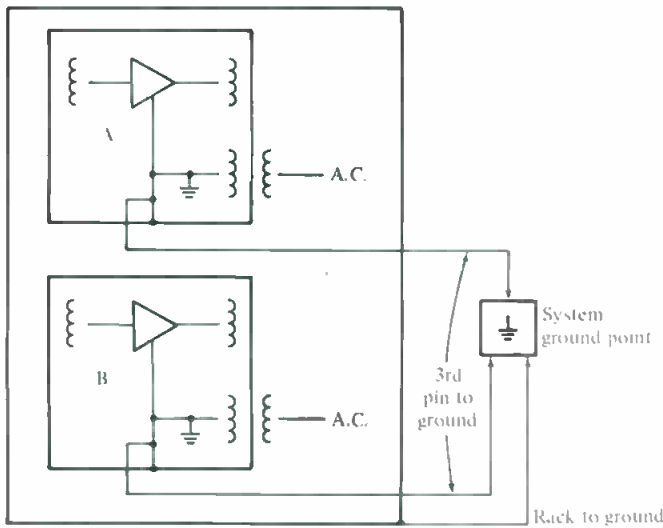

Figure 1. In many equipment rack installations, each device is separately connected to ground via the third pin on the power cord plug.

into the loops created by the ground wires run from the ground plate to each piece of equipment in the rack. The ground wires, tied at both ends, create loops which pick up the 50/60 Hz fields which are found in most rooms. As a result, the ground reference at the rack is modulated, relative to the system ground, at 50 or 60 Hz. As seen in

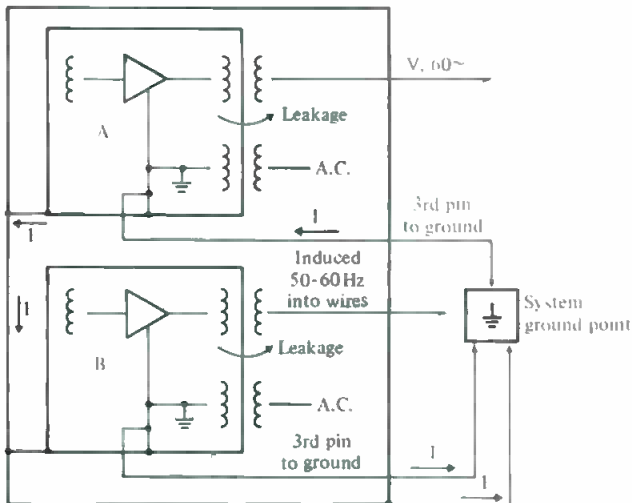

Figure 2. With two paths to ground for each piece of equipment, an AC ground loop may be induced, with resultant leakage into the signal outputs.

Thomas Hay is vice president, Engineering at the MCI division of Sony Corp. of America.

FIGURE 2, some of this will ultimately leak through the system and appear at the signal outputs.

A possible solution is to consider the rack itself as a sub-system. As shown in FIGURE 3, the third-pin grounds from each piece of equipment in the rack are tied to a common ground point in the rack. From this common ground point, a single heavy-gauge ground wire is run out to the ground plate. This eliminates the ground-loop problems resulting from line-frequency pickup.

This grounding technique may cause another problem, that of small ground currents from each device sharing a common ground path. However, this is usually not significant if heavy ground wires have been used, with perhaps some special handling in the case of particularly hum-sensitive equipment in the rack.

If problems persist, equipment may be electrically isolated within the rack using nylon washers and nylon screws. Use the washers to physically isolate the device from the rack's

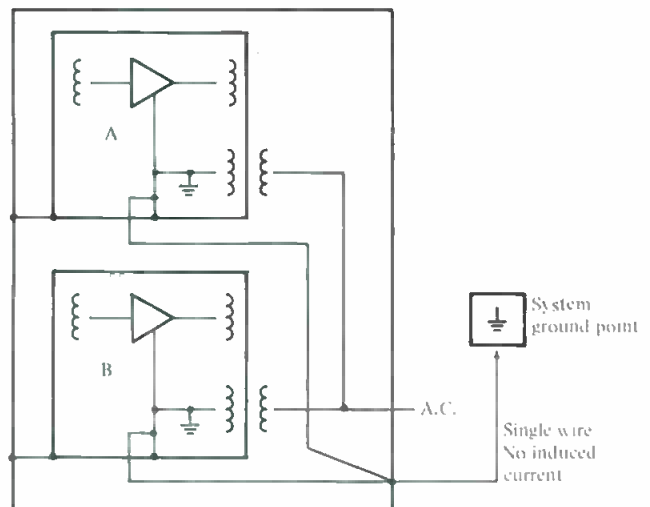

Figure 3. By tying all ground wires to a common point within the rack, most ground loop problems may be eliminated.

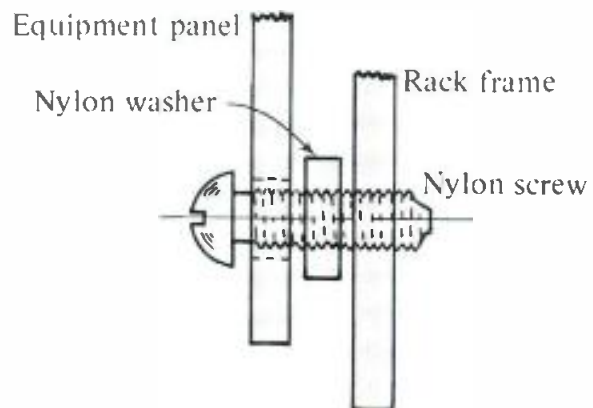

Figure 4. In the case of particularly hum-sensitive gear, nylon washers and screws may be used for better isolation.

mounting rails; the nylon screws will make sure there is no electrical connection to the rack. Once this is done, the device can have its own ground wire run back to the ground plate, with no looping or shared-ground problems. ■

JOHN M. WORAM

Orion Reference Guides

REMEMBER THAT MONITOR system you bought back in '78? And what about that 16-track board in Studio C that needs to be replaced? And then, there's those Mac' tube jobs that should be worth a fortune if you could only find the right buyer.

But before you place that classified ad (in db, of course), you need to figure out what you paid for all that stuff and, more importantly, what's it all worth today.

When it comes to dumping the family jalopy, there's always the old "blue book" that tells the snake-oil salesman down at the car lot what your wreck is worth these days. Now if only there was an audio blue book....

There is. Or rather there are. Orion Publishing Corp. puts out a series of four Reference Guides, at least two of which are of direct interest to db readers.

Orion's 1983 *Sound Reference Guide* is a 339-page compendium of some 17,000 products from A (AB Systems) to Z (Zildjian). Within each manufacturer's listing, products are tabulated by type and model number. List, Used, Mint and Average prices are given. For example, the MCI listing starts out as

Type	Mfg	Model Number	List
MIXBRD	MCI	JH-428B-8LM	19610
MIXBRD	MCI	JH-428B-8VU	17960

and finishes up some 136 listings later with

Type	Mfg	Model Number	List
REEL	MCI	JH-583D-32-LM	107863

	Used	Mint	Avg.
	16684	10845	8973
	15278	9931	8197
	86400	56160	41500.

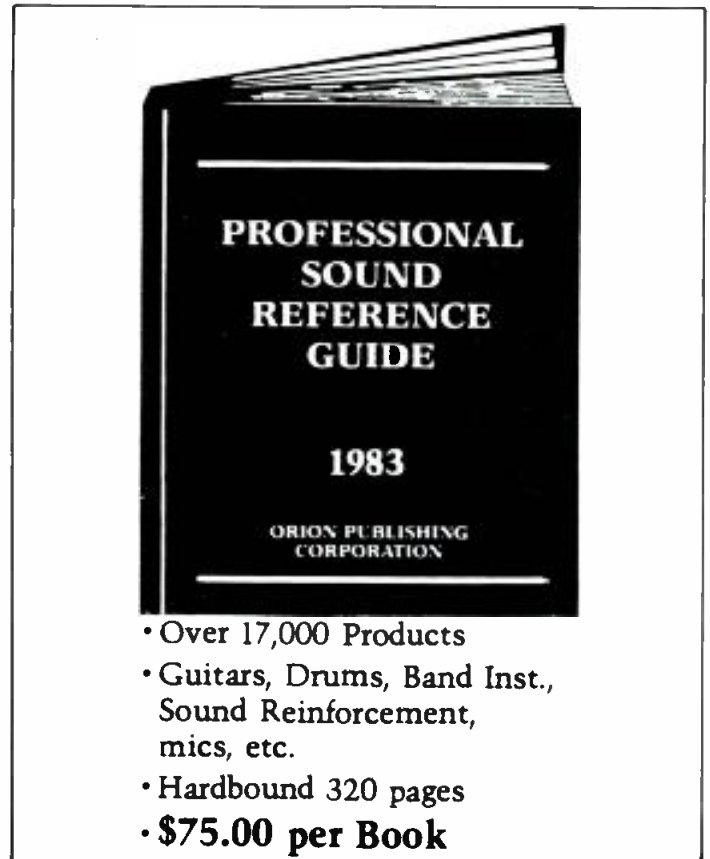

- Over 17,000 Products
- Guitars, Drums, Band Inst., Sound Reinforcement, mics, etc.
- Hardbound 320 pages
- \$75.00 per Book

SAMPLE PAGE

AUDIO REFERENCE GUIDE 1983										354
PIO	Type	Yr	Mfg	Power	Model Number	List	Used	Mint	Avg.	
PIONEER US ELECTRONICS (continued)										
	RCV	74	PIO	70	SX-939.....	600	191	114	66	
	RCV	77	PIO	85	SX-950.....	650	152	99	61	
	RCV	79	PIO	80	SX-980.....	650	182	100	62	
	RCV	71	PIO	28	SX-990.....	300	108	60	37	
	REL	71	PIO		QT-6600 QUAD.....	599	175	104	64	
	REL	77	PIO		RT-1010/L.....	650	194	111	69	
	REL	77	PIO		RT-1011.....	600	205	133	82	
	REL	74	PIO		RT-1011/L.....	795	239	155	96	
	REL	73	PIO		RT-1020/H/L QUAD.....	895	385	250	120	
	REL	74	PIO		RT-1050.....	995	411	251	156	
	REL	77	PIO		RT-11-2T.....	1295	536	328	203	
	REL	77	PIO		RT-2022.....	1590	467	304	188	
	REL	80	PIO		RT-2044.....	2010	930	592	367	
	REL		PIO		RT.....	595	234	140		

According to Orion, the List price is the latest manufacturer suggested retail price. Used is the resale price within a 30-day period, and Mint and Avg. are the high and average wholesale prices that a dealer would (might?) pay to a customer on trade.

At the front of the Guide a directory of 1,100 manufacturers is given, and this includes name, address and phone numbers. The directory is quite complete and even lists companies whose products are not found within the main section of the guide. The directory listings are a mixed bag of musical instrument manufacturers (Steinway, but not Baldwin), services (Bonneville Productions, but not Muzak), hardware suppliers (California Switch and Signal, but not Belden), hi-fi and pro-audio. These names are examples of companies/services not found in the main section.

Companies whose products are tabulated include most of the familiar names. For example, a quick look for microphones turned up AKG, Audio-Technica, Beyer, Calrec, Countryman, Crown, Electro-Voice, Neumann, Schoeps and Shure.

Curiously, at each product listing the manufacturer's name is repeated, and there is always a column labelled Power, as shown in the MCI sample listing above.

The 1983 *Audio Reference Guide* is a 524-page book listing 32,000 products, oriented a little more towards consumer

audio. For example, the Electro-Voice listing does not include microphones, but does list the Interface series of speakers, which are not found in the *Sound Reference Guide*. In fact, none of the microphones listed above are found in this guide. However, it's not completely "hi-fi" either: Otari tape recorders show up in both books, as does dbx (though Dolby is found in neither!). A welcome addition is a column marked Yr., listing the year in which the product was first introduced.

Orion's 1983 *Video Reference Guide* is a smaller (151 pages) listing of 3,200 products, including cameras, VHS, Beta and U-matic recorders, satellite dishes, tripods, etc. Completing the set is a 223-page *Camera Reference Guide*, listing 12,000 35mm and larger format cameras and other photo supplies, including some 3,000 lenses.

The Guides sell for \$85 (Audio), \$75 (Professional Sound), \$75 (Camera) and \$35 (Video). In other words, they're not cheap. However, a quick look in the appropriate guide might help settle an insurance claim, or get you a few extra thou' on a console sale. It's also a great way to settle an argument about that priceless whatchamacallit you picked up last year, now that you want to dump it.

The Orion Guides are all available from Orion Publishing Corp., 1012 Pacific Street, San Luis Obispo, California 93401. ■

Brooke Siren Systems

For years our MCS200 series crossovers have been used by major touring companies worldwide. The same high technology is available in our FDS300 series crossovers. Our products include some very unique features, highlighted below, but perhaps our best feature is the way we'll sound with you. Available now through professional audio distributors and music stores nationwide.

- 24dB/Octave Slope
- Subsonic/Ultrasonic Filters
- Section Mute Control
- Limiters on Each Section
- ± 6 dB Level Control
- Sealed Potentiometers



Brooke Siren Systems, 262A Eastern Parkway, Farmingdale, New York 11735 (516) 249-3660
Gerraudio Inc., 363 Adelaide Street East, Toronto, Ontario M5A 1N3 (416) 361-1667



Frequency Dividing Systems

- FDS320 2-Way Stereo
- FDS340 3 or 4-Way Mono
- AR116 Active Direct Box
- AR125 Cable Tester
- MCS200 Modular Series 3, 4, or 5-Way Stereo

Halls for Music Performance: Two Decades of Experience 1962-1982

THIS ISN'T really a book, at least not in the typical sense. Rather, it is a collection of poster papers presented at the 103rd meeting of the Acoustical Society of America in Chicago, April 26-30, 1982. But this volume's presentations shouldn't be confused with the familiar convention paper material—confused verbiage and undecipherable slides. Instead, true to the architectural profession from which it springs, this book contains tersely worded descriptions and clean technical drawings from the field of architectural acoustics. Specifically, the collection is comprised of descriptions, drawings, photographs, response curves, and physical data on eighty-seven music halls around the world which have been completed or renovated during the past two decades. Each hall is given two pages—a fact sheet with a short prose description of the acoustic and architectural nature of the project, and a page devoted to technical information, presented visually. To facilitate comparison of the halls, all building plans and sectional drawings in the book are at uniform scale.

The eighty-seven music halls included in the collection span the range of hall capabilities, and vary in size from under 500 to over 5,000 seats. Designs are similarly varied—from traditional European to strictly innovative. Part of the diversity stems from the cost-effective trend toward renovation of existing space previously intended for a purpose different than music performance. Of special note is the hall in Scheveningen, Netherlands, where an old cylindrically shaped circus theatre has been transformed into an opera house with reportedly excellent acoustics. Other examples in the book range from the orchestra-in-the-middle Berlin Philharmonie to the Orpheum vaudeville house in Victoria, British Columbia, from the Louise M. Davies Symphony Hall in San Francisco to the 5,500 seat ice ring/concert hall in Bordeaux, France. There are fifty-three halls from the United States, thirteen from Japan, and representatives from Australia, Canada, France, Germany, Mexico, the Netherlands, New Zealand, Spain, and Sweden. The Netherlands surely wins the architectural gold medal for completing seven halls within a twenty year period.

Confronted by a smorgasbord of concert halls, one reflexively looks for a personal choice. One of my favorite halls (favored more for its principle performers than for its acoustics) is Orchestra Hall in Chicago. Fortunately for me, it is included in the collection. As a representative example of the collection's style of presentation I would like to reprint the fact sheet on Orchestra Hall, and describe its visual material:

Orchestra Hall has been the home of the Chicago Symphony Orchestra since 1904. Designed by architect Daniel Burnham under the direction of Music Director Theodore Thomas, the hall has had a mixed and colorful history. Serious acoustical deficiencies were apparent from shortly after its opening. Responding to these deficiencies produced a number of changes over the years, primarily within the stage area and "shell" over the stage.

These changes culminated in 1966 when, under Bolt Beranek and Newman's direction, much of the plaster ceiling was replaced with perforated aluminum screen to allow sound to access the volume beyond in an attempt to increase reverberation time during performances. The volume that was added to the hall unfortunately included extensive areas of porous plaster and clay tile masonry and became impeded with ductwork. To stabilize reverberation during rehearsals, upholstery was added to balcony and gallery. The net effects of the 1966 remodelling were essentially no increase in occupied reverberation time, major reduction in unoccupied reverberation time (eliminating the hall's use for recording purposes), and a general perception among musicians that "all the sound that passed through the perforated ceiling was lost from the room."

The 1981 acoustics remodelling explored a number of reconfigurations of stage and "sending end" of the hall, including expansions over the alley, raising the roof over the gallery, consolidating the chorus seating and centralizing the organ. The actual remodelling followed a much reduced scope. It consisted of reducing absorption of main floor seating; hardening all "upper hall" surfaces; relocating ductwork to open the upper hall volume; adding sound-diffusing plaster shaping to rear wall surfaces; providing tandem sound doors to control exterior noise; eliminating excess absorption within boxes, organ chambers, and surfaces surrounding the orchestra and the draperies at the rear of the orchestra level seating.

The visual material for Orchestra Hall features two interior photographs, a sectional and main floor plan, reverberation time characteristics showing pre- and post-1981 renovation, graph of sound absorption per seat (occupied and unoccupied pre- and post-renovation), and octave band SPL pre- and post-renovation. Also, a table of dimensions and volumes is included.

From this example it should be apparent that a concise amount of information is presented in these posters, and the editors are to be commended for assembling a world-wide sampling of contemporary thought on hall design. Music halls have always represented a cultural high point—a kind of synthesis of art and technology in which the idea of functional beauty is put to its most critical test. It is a fascinating pursuit to page through this collection like an armchair traveller and look into the current achievements of architects and the results of their efforts to fit function with form. Ironically, the extent of that tour constitutes a weakness in this collection. The description of each hall is necessarily so brief that one is left with the feeling that the presentation was really only a preface, and that there is no place to go (apart

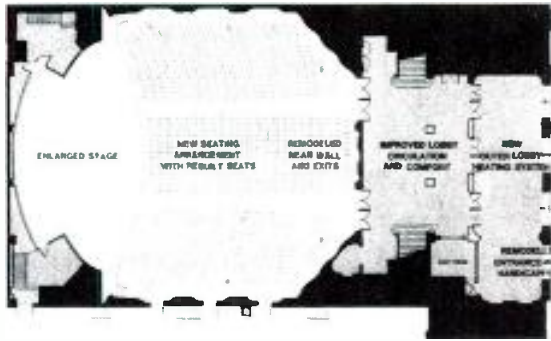

ORCHESTRA HALL IMPROVEMENT PROGRAM

MAIN FLOOR PLAN

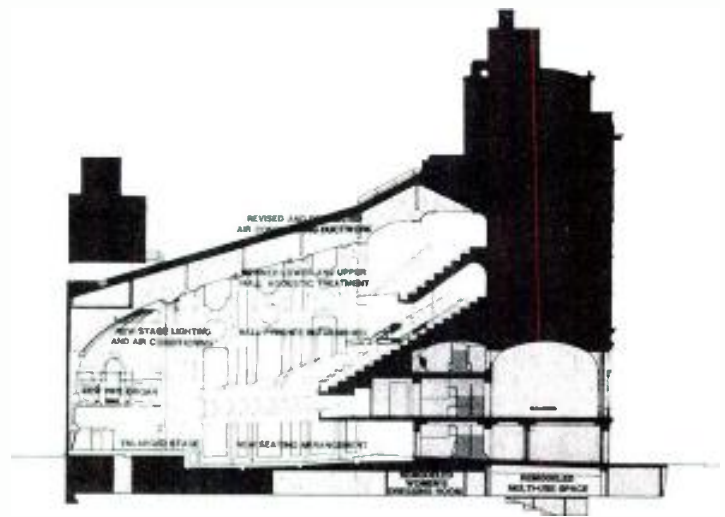

ORCHESTRA HALL IMPROVEMENT PROGRAM

SECTION LOOKING NORTH

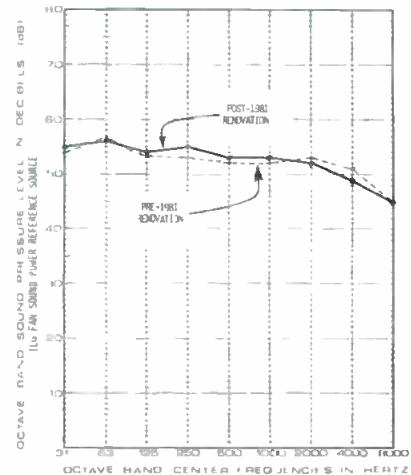
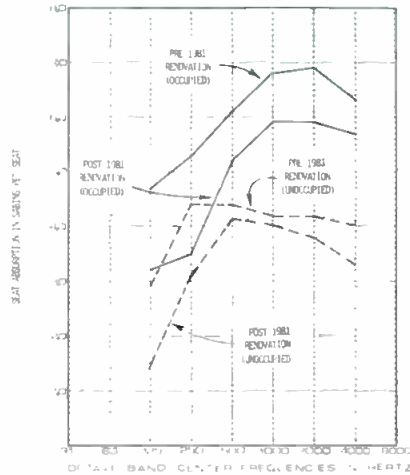
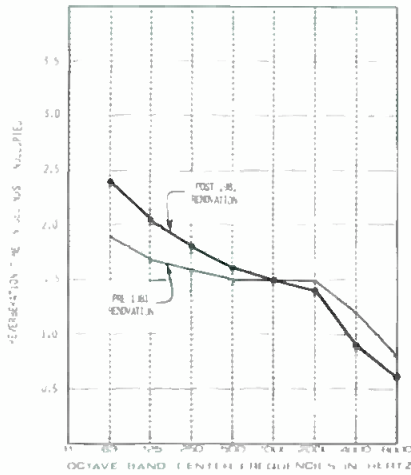

Orchestra Hall, Chicago, Illinois. Renovation completed 1981.

from the hall itself) for more in-depth information. Beranek's book, *Music, Acoustics, and Architecture*, which covers fewer halls in more pages, is more satisfactory in that respect, but where is the grand volume detailing the entire story of a concert hall, from conception to ribbon-cutting? Purportedly, one of the big publishing houses is poised to release a major book on the design and construction of a New York skyscraper—why not the story of a great concert hall? Surely, the drama of such a project would itself be a story of considerable interest.

The price of diversity must be paid, and the lack of in-depth information constitutes this collection's major drawback. It is a fascinating glimpse into architectural acoustics, but it offers limited opportunity for real study and instead merely invites casual page-turning. Thus this volume's weakness lies in the uneasy limbo it must occupy between professional treatise and coffee table curiosity. Nevertheless, it is a thoroughly useful and interesting volume with a great resource of information. For architects engaged in hall design, and for those who aspire to it, the collection stands as a ready reference of examples. And for anyone who has that bug about architecture, who has a minor compulsion for section drawings, and who, from reading the descriptions and contemplating the drawings, can imagine the listening experiences in music halls one will probably never really hear, this collection is highly recommended.

Finally, I would like to call attention to two philosophical matters raised in this collection. In their preface, the editors defend the idea of multi-purpose halls and describe the availability of "instant push-button control of acoustic characteristics" to shift a hall's response "from Romantic to Baroque during a brief intermission and, three or four hours later, to have the stage fully rigged for drama or opera." I strongly disagree on this matter: while some acoustic variability is

possible and sometimes necessary, I question the feasibility of a push-button solution to this serious utility problem as applied to hall design.

Also in their preface, the editors note their growing awareness that the acoustician's old role of technical assistant to the building designer is coming to an end. Instead, the false sole criteria of visual space and design is being tempered with the acoustician's concern for physical and auditory considerations. The editors hypothesize that this has created an opportunity to re-think architectural expression in terms of contemporary acoustical advances. For this conjecture, I have my fingers sincerely crossed. ■

Book at a Glance

title:	<i>Halls for Music Performance: Two Decades of Experience 1962-1982.</i>
editors:	Richard H. Talaske Ewart A. Wetherill William J. Cavanaugh
publishing date:	November 1982
publisher:	American Institute for the Acoustical Society of America
vital statistics:	192 pages, paperback, price, \$15.00
ordering address:	Acoustical Society of America 335 East 45 Street N.Y., N.Y. 10017

db Convention Report

JOHN BORWICK

The 73rd AES Convention: Eindhoven

THE CHOICE OF Eindhoven in The Netherlands for this year's European AES Convention gave rise to some before-the-event misgivings. This relatively small and hard-to-reach industrial town was compared unfavourably with Paris for culture, London for sight-seeing, etc. Nor did prospective exhibitors fail to observe that Eindhoven is dominated by Philips, one of the world's biggest multi-national companies, and wondered in advance if there might be some bias in exhibition space allocations.

During the event, March 15th to 18th, all these misgivings seemed to melt away. The Eindhoven Congress Centre is so stylish and well-equipped that the exhibition area and demonstration rooms were soon being praised to the sky. The large lecture theatre had excellent audio-visual facilities which worked impeccably—it was so comfortable and commodious that it also made a fine auditorium for a Concert on the 16th by the 60-strong Promenade Orchestra of Netherlands Broadcasting. The concert began with a fanfare played with and without the hall's multi-channel electro-acoustical reverberation system in use, as a mini 'tutorial' for the technically-minded. The evening ended with Sousa's "Stars and Stripes Forever," as a gesture towards the US delegates.

Convention attendance was Europe's highest yet, in excess of 3,000, which put such a strain on Eindhoven's hotels that many visitors were located some miles from the centre. The lack of cultural facilities (Philips' "Evoluon" Museum of Technology does not quite equal the Louvre or the British Museum) was hardly noticed in the scramble to keep up with 46 technical papers, 125 exhibitors, 9 technical tours, 8 social tours, 6 poster presentations and frequent audio-visual programmes on the Compact Disc.

The forthcoming launches of CD added a distinct spice to the gathering (October 1982 in Japan; March 1983 in the UK, West Germany, France and The Netherlands; to be followed by April in Belgium, Switzerland and Sweden; May in Austria, Denmark, Finland, Italy and Spain; and the US launch reputedly brought forward to June). Philips and Sony, the co-developers of the system, were naturally majoring on exhibits showing studios how to prepare digital masters with the appropriate subcode TOC (Table of Contents) data for CD disc transfer, and spelling out for

prospective pressing-plant investors just what is needed to process and duplicate the new shiny discs. But everyone involved in digital recording or processing had found the CD emergence as a fillip (sorry about the pun, Philips) to sales; and even the people busy with professional analogue audio were pointing to CD as a further reason why everyone should be upgrading their analogue, too.

Digital topics occupied two of the seven lecture sessions, with engineers from Philips, Sony, Studer, JVC (Victor Co. of Japan) and Matsushita (National Panasonic) all presenting important papers. The first Philips paper on "Compact Disc Subcode Origination and Processing" was helpful to people like me—keen to learn all about CD, but occasionally dropping out on sentences like the following, which I have extracted verbatim from the Sony/Philips Specification of the CD Master Tape. "A Midamble or string of Midambles shall always be preceded by a Preamble and concluded by a Postamble in the data stream." The second Philips paper caused a flurry of mild panic amongst record company delegates. It was entitled "Experiments Towards an Erasable Compact Disc Audio System." An erasable disc will surely be re-recordable, so wide open to home-copying and worse! As it turned out, the erasable CD is still a laboratory experiment and at least five years from commercial viability. It would look like a standard Compact Disc but have a layer of magneto-optic material in pre-cut grooves. The recorder would use a laser to record tiny magnetized dots corresponding to the digital pulse-stream. On playback, these dots would cause a small shift in the polarization of the laser beam (about 0.7 degrees peak-to-peak), and this could be decoded into audio by a polarization-sensitive device. For playing normal CD records, the special laser source and lens assembly could be simply changed to the standard CD type.

Coincidentally, both Dolby and dbx, whom we think of mainly as noise-reduction specialists, presented papers on their work on Delta Modulation as a less costly technique than PCM for digital recording. A down-market, but very technology-packed, approach to domestic digital was described in a Matsushita paper on home digital recorders using the conventional compact cassette format, and even the humble micro-cassette. Special "Digital Angrom" evaporated metal tape is needed, plus new 12-track heads to give the high-density recording demanded for digital signals. (I

John Borwick is db's European editor.

visited Japan in November and was given demonstrations of the digital cassette and micro-cassette recorders by Matsushita. The electronics were still on professional outboard racks, and sound quality was inconsistent, yet the signs are clear enough that domestic digital is just around the corner.)

In this necessarily selective round-up of the papers and exhibits, let me walk you through the product categories and point out some highlights on the way.

MICROPHONES

Perhaps because of digital demands for even quieter microphones, there was more activity in this category than in previous years. Bruel & Kjaer measuring microphones have lately been used for a number of audiophile recordings so, not surprisingly, this celebrated Danish company have now designed new microphones specially for recording. They are all omni-directional condenser types, the 4003 and 4006 being low-noise (15 dB SPL) models suitable for close-miking of vocals, while the 4004 and 4007 have a smaller capsule and are described as high intensity models suitable for percussion, brass, etc., handling peak levels up to 168 dB. Of



The AKG Tube, a new valve-type microphone.

these two pairs, the higher numbered 4006 and 4007 are powered from a normal P48 phantom supply via 3-pin XLR connectors. The 4003 and 4004 work from a Type 2812 two-channel transformerless unit giving line-level electrically balanced outputs.

AKG seemed to have put the clock back by introducing a new valve-type microphone called "The AKG Tube." This is based on the same 6072 Valve used in the old C12 microphone, whose sound quality still has its strong advocates. But if tube nostalgia is not for you, AKG were also showing a new C460B preamplifier for their CMS modular system having new state-of-the-art specifications, and an H-30 universal microphone suspension unit taking any 0.6 to 1.3 inch microphone.

Amcron (Crown) were, of course, showing their range of PZM® pressure zone microphones, now comprising seven models, but they no longer have the pressure zone to themselves. Beyer introduced a 200 mm square MPC50 model, and another high-quality manufacturer, Schoeps, added the BLM3 200 mm square "Boundary Layer" microphone to their range. This is a condenser type using the standard Schoeps CMC preamplifier to give flexibility of choice to existing Schoeps users. Neumann engineers presented a paper on their new TLM170 transformerless microphone, claiming 3 dB less thermal noise yet with 6 dB



The Beyer MPC50 microphone.

higher output. (Though it is only fair to point out that AKG were distributing a paper in praise of transformers!) News on the Sennheiser stand was of a UHF multi-channel wireless microphone system using the EM1036 TV receiver, a new SK 2012 TV pocket transmitter measuring only 92 x 52 x 17 mm and a choice of soloist microphones.

Calrec revamped their 4-capsule Soundfield microphone

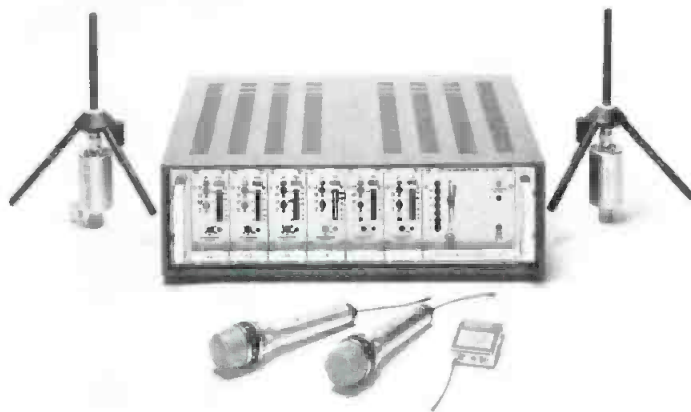

The Sennheiser EM 1036 wireless microphone system.

giving user-convenient control of polar patterns, azimuth, elevation, angle and front/back dominance. Shure's AMS (Automatic Microphone System) comprises an 8-channel mixer with logic circuitry to turn each microphone on clicklessly only when it is addressed within a 120-degree acceptance window. I was given an impressive demonstration with speech at different angles into a new Shure AMS26 Probe microphone and their AMS22 Low-Profile microphone (which looks a bit like a PZM but is actually a hemi-cardioid). Sony, too, following penetration of Japanese and US TV stations with their wireless microphone system, were making a strong bid for the European market.

LOUDSPEAKERS

Philips used a live pop group for regular demonstrations of the effectiveness of novel Bessel panels of multi-array loudspeakers. After the group had played live, a recording was replayed with the Bessel weighting circuits switched out an in—to contrast the normal beaming of speaker arrays with the radial distribution produced by the Bessel functions. Studer made an interesting entry into the loudspeaker market with a compact monitor. The Studer 2706 measures only 24 × 15.1 × 13.5 inches, but can produce up to 104 dB SPL at 1 metre and handle up to 170 watts peak.

Tannoy told me that their USA distribution through BGW would cease at the end of March, and that they were beginning a joint venture with their Canadian representatives. Their newest speaker at the Convention was a reasonably compact two-way BM8 broadcast monitor. This had Tannoy's patented SyncSource crossover to give phase coherence by passive means: It certainly sounded pretty good driven by Tresham amplifiers. (Tannoy recently acquired the Tresham company.) Other British firms at Eindhoven included KEF, Quad and Red Acoustics. The last-named company specializes in active loudspeakers and had developed an amazingly compact A-4 model of only 19-inch rack width capable of up to 112 dB SPL at 1 metre. Turnkey Two, also British, were demonstrating biamped monitors with power handling all the way up to 1,200 watts. Genelec of Finland also concentrated on active loudspeakers and their biggest control-room monitor, the Genelec 1025A, incorporated four power amplifiers (750 watts), could produce 122 dB SPL per pair, and cost \$7,960 per pair.

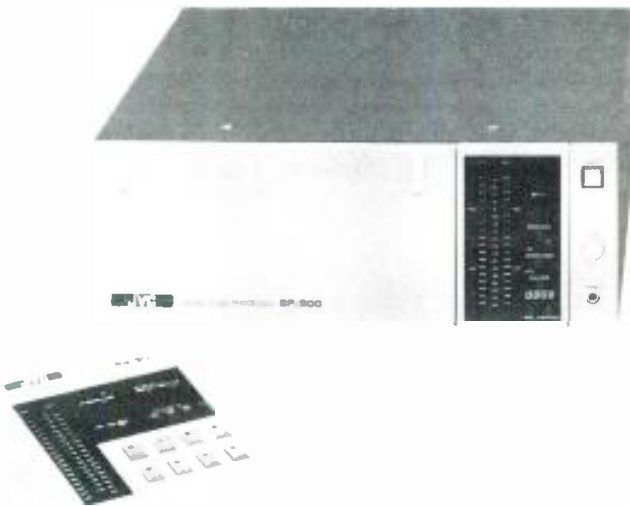

JVC's BP-900 digital audio processor.

ANALOGUE DISC

A centre of attraction on the Neumann stand was their latest VMS82 disc-cutting lathe. This has a number of refinements such as microprocessor-controlled depth-of-cut and TV-monitored microscope groove inspection. As an added interest feature, this was set up for DMM (Direct Metal Mastering) on copper blanks instead of lacquer. This is the technique developed by Teldec and is already used successfully for many of their own discs and custom processing for various audiophile labels. EMI Records have recently signed a licensing agreement to use the technique.

I was given a demonstration by Teldec representatives and they were enthusiastic that the benefits of DMM would surely help the analogue LP to withstand the competition from CD for some years to come. Apart from the annoyingly

restricted supplies of lacquer blanks and their notorious instability, cutting directly into copper produces a positive-image "Mother" which bypasses the old lacquer stripping, silvering and first electro-forming stages. Stampers then produced can be free of ticks and pops, with background noise reduced by as much as 10 dB. Absence of lacquer spring-back avoids pre- and post-echo, and allows better pitch control. There are also cost and time savings.

EMT-Franz showed the latest version of their EMT 950 studio turntable. This had automated cueing, by optical detection of modulated and unmodulated grooves, sequence programming and a zero locator button to return the tonearm to the lead-in groove after pre-fade listening to the desired music cue. The need for broadcasters and libraries to renovate LPs was met by the range of Keith Monks record cleaning machines, including the most recent CR502 semi-professional model.

COMPACT DISC

Separate from the 100-seat demonstration room where they ran educational audio-visual programmes and demonstrations of Compact Discs (in A/B tests with the digital master tapes), Philips had set up some of the special new equipment needed for transferring studio masters to CD-ready form. This included the LHH 0401 Compact Disc Encoder for translating digital audio and subcode information into CD format, the LHH 0425 Subcode Processor/Editor for generating and editing cue code data and the LHH 0426 CD Inspection Player for automatic quality control checking.

Sony also unveiled two new products designed for CD manufacture, broadcasting and testing. Their CDP-5000 Professional CD player uses a stationary laser source, with the disc itself moving horizontally as it rotates as controlled by a central processing unit. Advanced cueing and pre-monitoring are possible, even for faulty discs which will not play on ordinary players. Required cues can be accessed to one-frame accuracy using 10 keys or a two-speed search dial (with audible sound throughout). The CDA-5000 CD Analyzer comprises a keyboard and a 9-inch CRT on which every bit of the subcode data can be displayed, with an optional printer for making hard copies. The whole TOC (Table of Contents) data can be displayed for the given disc, and then error check, fault and noise analysis modes can be selected in turn.

Though not giving up development work on their own rival AHD digital disc system, JVC (Victor Co. of Japan) were demonstrating that their latest DAS Series 900 digital mastering system was also compatible for CD disc cutting, and were even showing a CD player. The Series 900 system consists of a BP-900 processor and AE-900 electronic editor, being updated versions of the Series 90 units already used in many studios—and compatible with them. New LSIs have cut down size and weight. Professional ½-inch VHS recorders can be used as well as ¾-inch U-format machines. The design was outlined in a paper presented by JVC's Toshinori Mori.

MAGNETIC TAPE

Digital and analogue tape recorders could be seen side by side on the Studer stand. The Studer A808PCM is a ¼-inch digital recorder featuring 8 channels at sampling frequencies of 48 and 44.1 kHz, plus 2 analogue channels for cueing and SMPTE code. (A 4-channel version is also available.) The interface format is that agreed by Studer, Sony/MCI and the EBU, and gives more than 60 minutes recording on a 14-inch reel. Both electronic and tapecut editing are possible and there are remote controls for transport, audio, level metering and auto-locate. The transport is essentially that of the familiar A800 analogue recorder, of which a new A800 Mk III was displayed. This has transformerless balanced-line inputs and outputs, interfaces for Solid-State Logic, Neve/Necam mixing systems and for the Audio Kinetics Q-



Studer's A810 1/4-inch master recorder.

Lock synchronizing system. The Studer microcomputer-controlled A810 1/4-inch master recorder on show introduced the idea of a new time code system placing SMPTE code data on a 0.35 mm centre track between the stereo audio tracks. Separate heads are used for the time track, with digital delay used to restore synchronism, and 90 dB code/audio separation is claimed.

Sony drew the crowds with their PCM-3324 24-track digital recorder—actually 28-track if you include the time code, control and 2 analogue tracks intended for recording memos and editing information. The PCM-3324 uses only 1/2-inch tape, yet gives individual noise-free punch-in of all 24 tracks through a 10 msec automatic crossfade technique. Controls are extremely versatile, with memory store of up to four grouping selections and instant recall of complete keyboard configurations. Shuttle speed is variable from 1/15th up to X15. On pressing EDIT STOP, the machine stops after 5 seconds and returns to the stop point, having recorded these 5 seconds on to the analogue tracks for normal hand-wind edit-point searching. The edit can then be rehearsed and auditioned without losing any of the recorded material. Of course, I joined other visitors in hands-on experiments of this, as well as Sony's DAE-1100 digital audio editor. Shown publicly for the first time on the MCI stand (now a division of Sony) was the MCI/Sony JH-110B-3-LB Audio Layback system, a new 1-inch audio transport deck designed to produce better sound quality for video productions than can be obtained on the usual 1-inch C-format video tape.

The AEG-Telefunken Magnetophon 21 1/4-inch analogue recorder is a versatile, and smartly compact, design, but it had to take second place in most people's attention to their new digital machine employing the Mitsubishi format on 1/4-inch tape at 15 ips. Console and transportable versions are available (MX-80A and MX-80), giving up to one hour on a standard 10-inch reel. Editing is by the usual cut-and-splice method. Enertec-Schlumberger introduced a new F500 compact analogue recorder with microprocessor control. They also showed a 1/2-inch super-stereo 2-track version of their F462 master recorder, as well as an SMPTE 4-track

version with the time code on one track and three audio tracks for synchronized use with VTR machines.

Two Swiss manufacturers, Nagra-Kudelski and Stellavox, are famous as specialists in miniaturized tape recorders with top-flight specifications and facilities of special appeal to the film and TV industries. Nagra's T-Audio four-speed recorder was shown with a prototype add-on time code device for synchronization with all pilot-tone systems and 80-bit SMPTE code. Stellavox introduced the SU8, an update on their established SP8 model, having a new SHD MSP headblock with switched selection of Mono Neopilot, Mono or Stereo Synchronone recording modes. Switchable built-in limiters and an optional SMPTE module were also featured.

PROCESSORS AND ADD-ONS

Dolby's latest product is the Model 372 battery-operated portable, giving two channels of A-type noise reduction. Applications suggested were mobile recording, outside broadcasts, and with video tape recorders. They were also

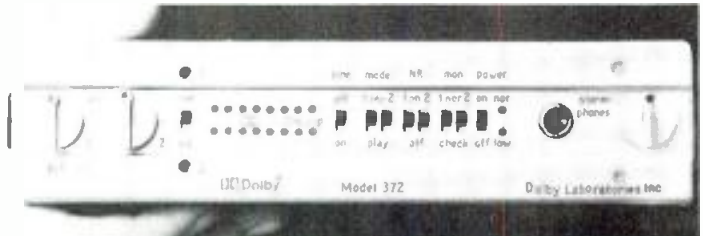

The Dolby Model 372 battery-operated portable noise reduction unit.

promoting the use of Dolby HX Professional for high-speed cassette duplication. Audio & Design showed their full range of compressor/limiters and equalizers, including the Express Limiter for TV and video production. The Propak is the newest item, a two-channel interface unit giving up to +24 dBm output and designed to interconnect professional analogue and semi-professional digital units where level-matching and skew-correction for time-coincident digital tracks is needed.

Audio Kinetics has extended the operational versatility of their Q.Lock synchronizer units with a series of Q.Soft controllers. They had hooked up a 1-inch VTR with a Sepmax



Audio & Design's Propak, a two-channel interface unit.

film machine and multi-track audio to demonstrate new VAPP (Video Post Production), ADR (Automatic Dialogue Replacement—looping) and SFX (Sound Effects Assembly) control units. The Klark-Teknik DN 30/30 graphic equalizer neatly packs two channels of equalization into a single unit covering over 30 ISO center frequencies. It was demonstrated in conjunction with their DN60 spectrum analyzer to give visual display of all conditions.

EMT-Franz, long-standing leaders in the echo plate and reverberation simulator market, brought reverb a quantum-leap forwards by developing a new rack-mounted digital system with remote control. The EMT 252 gives nine individual reflections, and each is time- and amplitude-controlled, with four-band equalization, sound-effects, delay, chorus, etc. A 32 kHz sampling frequency extends response to 15 kHz, and the EMT 352S remote control unit needs only a single two-conductor audio cable for all functions. It has a 128-combination memory, and a single rotary switch can be selected to each parameter for easy up/down adjustment with full visual display. Another interesting EMT-Franz device is the ECS-6000 Event Controller. This comprises a rack-mounted processor and a computer terminal with keyboard and screen. It can control up to 24 tape machines or other units, triggering them in any pre-programmed sequence, and up to 1520 events (760 takes) can be stored.

MIXING CONSOLES

While analogue mixers in every size and configuration, with or without computer-assist, continue to provide the main console market, the all-digital fully-assignable desk is getting nearer—though it will surely be more expensive than the analogue equivalent. Calrec demonstrated a versatile 16-track 6014M series console in a video postprocessing set-up—but they enthusiastically unfolded for me a blueprint of their next assignable deck, to follow later this year. This will put

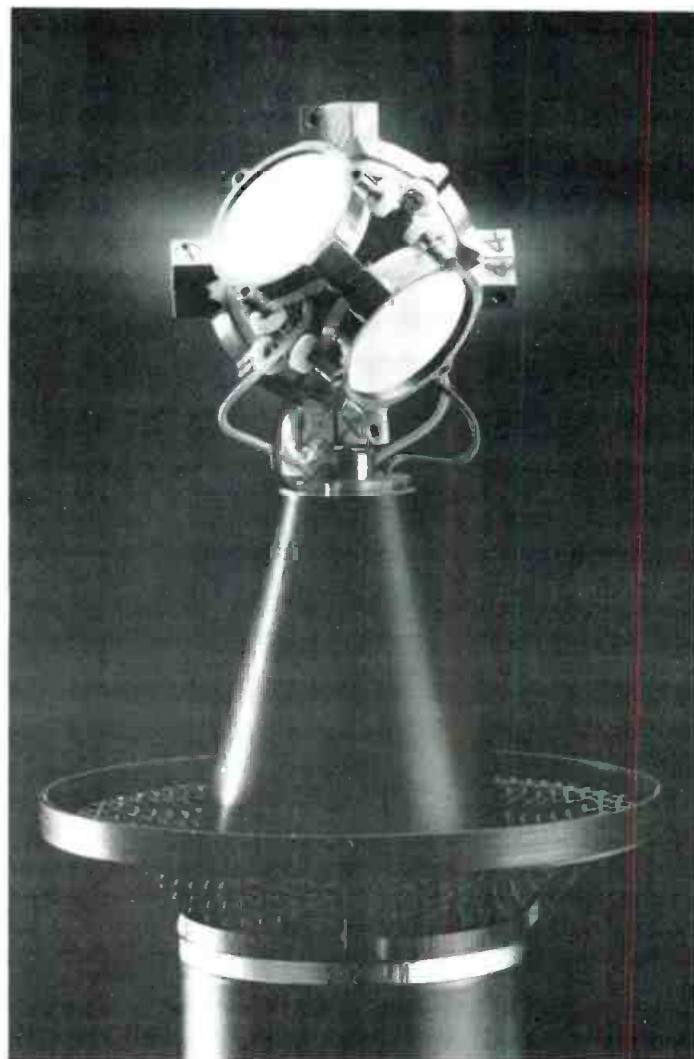

The Calrec Soundfield capsule.

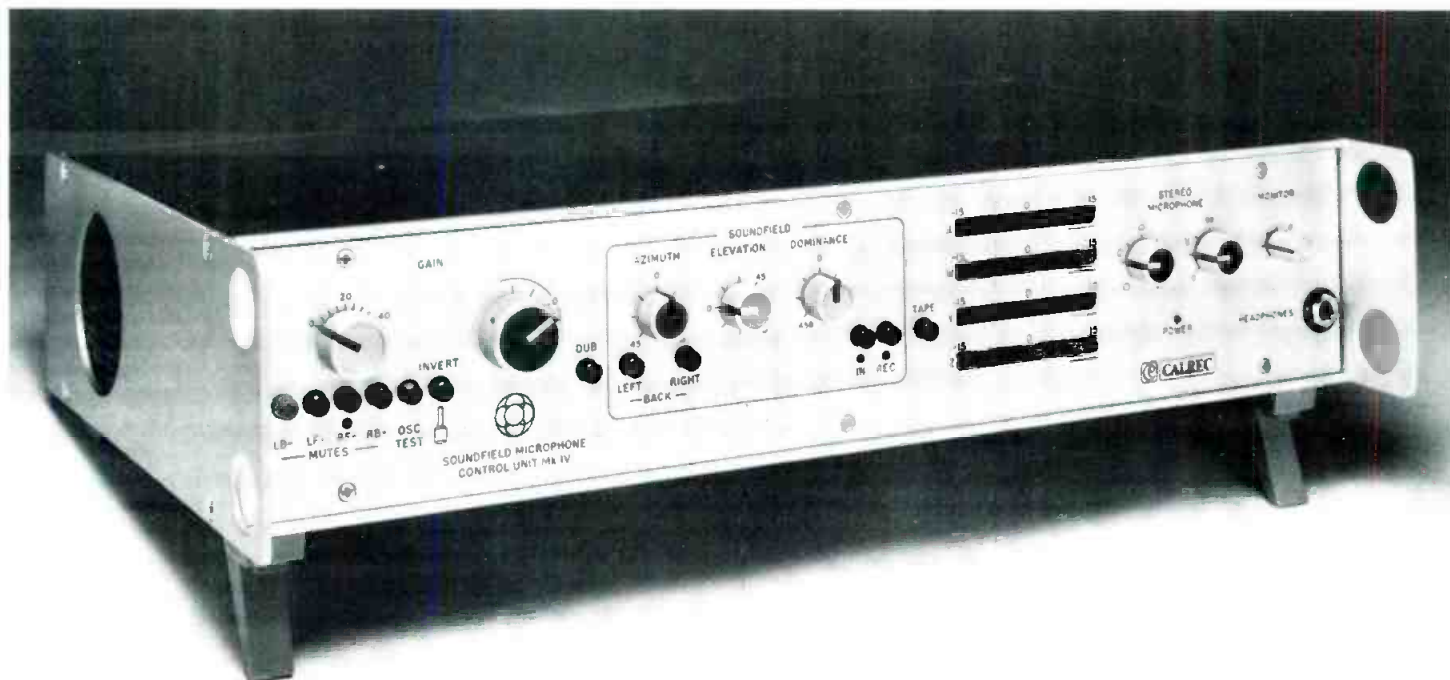

The Calrec Soundfield microphone control unit.

more than 100 channels in easy reach of one operator and yet be no bigger than a present-day 16-channel mixer. The Calrec variable controls were particularly neat. For channel preset sensitivity, for example, one button would change gain in 10 dB steps, while another flipped up 1 dB at a time—and

when it reached 10, the 10 dB display similarly clicked up one decade.

Soundcraft had a large area to show a selection of their multi-channel consoles from a new Series 200 baby right up to the Series 2400 incorporating 8-bit automation with

priority encoding, auto-nulling of the fader point-of-entry and designation of any channel as a VCA sub-group. A disc-based memory is planned to replace the present tape-track storage. Solid-State Logic, of course, offer total recall of the complete console status on their SL-4000, and SMPTE time-code entry of the times and durations of presets. Along with many other visitors, I was impressed, as usual, by the amount of detail as to programme and console contents and conditions which the SSL system can display on its TV monitor screen.

Turning from these British console manufacturers, I found neat Series 5000 and 6000 desks on the stand of Enertec-Schlumberger from France, while Sonosax of Switzerland launched a new SX-S 8-channel portable weighing only 5 kg. Tore Seem of Norway showed their Seemix system designed to be equally suited to multi-track and broadcast use, and having optional floppy-disc recording of matrix and fader settings. Sony seemed intent on catching up with professional audio equipment in all categories and showed a particularly clever miniature mixer for ENG (Electronic News Gathering) and other field applications. The Sony MX-P42 has four inputs with independent auto compressor/expander level control to keep signals within set upper and lower levels—and up to four MX-P42 mixers can be hooked together.

Neve had taken a suite about the size of a tennis court so that visitors could enjoy hands-on trials of their full range of analogue consoles, including the 51 Series of broadcasting mixers with 24-track recording facilities and the 8128 multitrack music consoles for 24, 32 or 48 track recording or

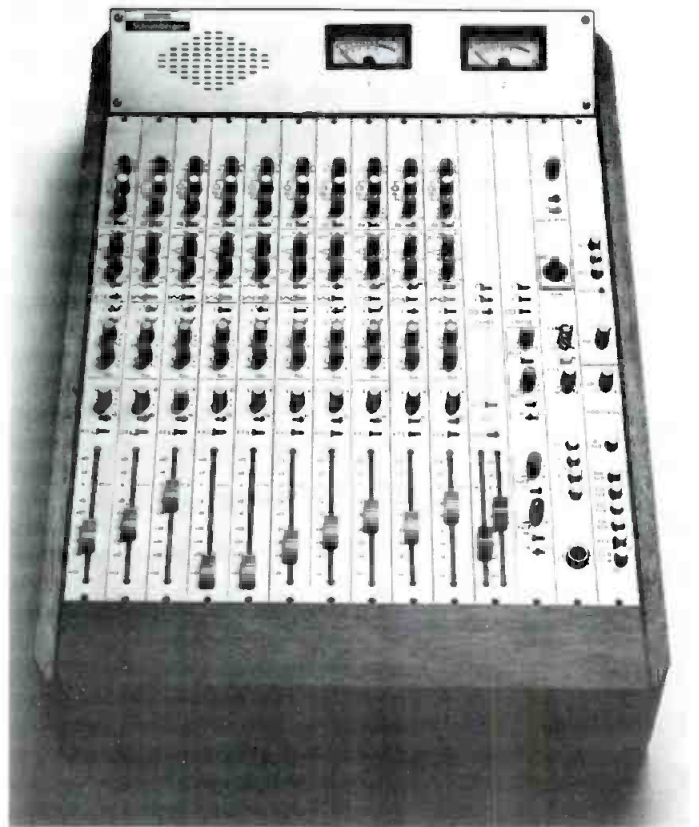

The Enertec-Schlumberger Series 6000 console.

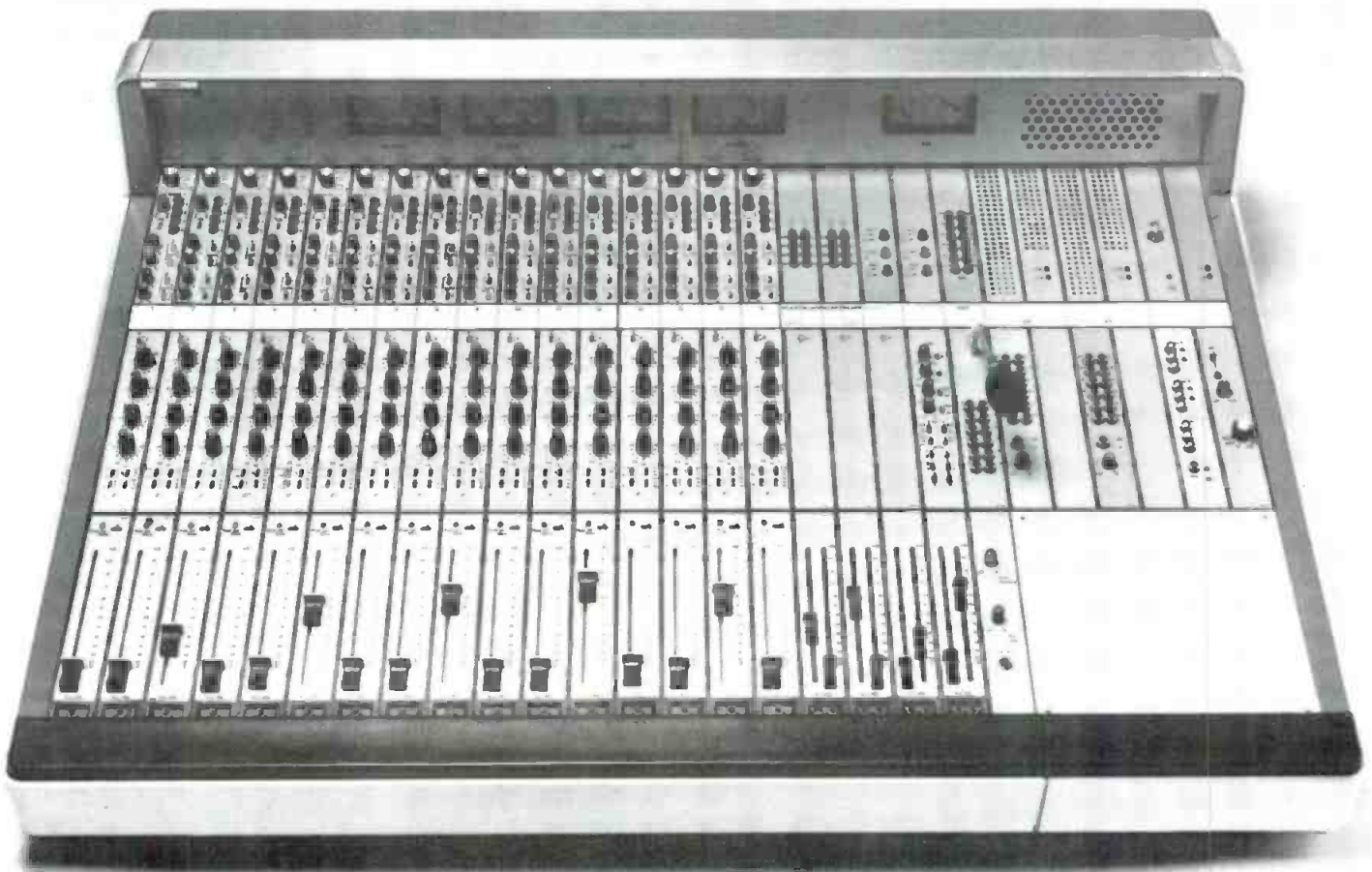

The Enertec-Schlumberger Series 5000 console.



The Sonosax SX-S portable mixing console.



The Neve 51 Series broadcast mixer with 24-track recording facilities.

mixdown, with digitally controlled routing and displays. However, I quizzed them about their all-digital console design, the DSP (Digital Signal Processing) system, which I knew was in an advanced stage of development. It is soon to be installed in CTS Studios in London, making this the first comprehensive all-digital studio in the world, and also in a BBC radio outside broadcast vehicle—another world first. Neve had not brought a digital desk to Eindhoven, but I was invited to try out a demonstration set-up back at their factory in England. I have already done so, and will report on this important development in a future issue.

To end on an off-beat note, the AES Convention saw the first public demonstrations of a new surround-sound recording technique. Holophonic International of Italy have been attracting the attention of the media with their Holophonia system, apparently based on the theory that the ear emits signals to form interference patterns with incident sound waves. I don't understand the theory, but listening on headphones to their special tapes replaced on a Nagra IVS, I heard most impressive all-round and with-height reproduction of speech and sound effects. As a nice touch, they included a barber's snipping scissors and hair-drier—very natural, but will it catch on? ■

New Products

DISTRIBUTION AMPLIFIER

• The one in, ten out Model 7111 Distribution Amplifier is self-contained, internally powered and has an additional front panel output jack that can be used for monitoring or metering purposes. Input and output lines are transformer isolated, and proprietary BTI Model OA 400 operational amplifier modules are used as the active elements. Parallel male and female 3 pin XLR input connectors provide a rapid way of interconnecting additional 7111's or other equipment. The unit will operate on 115 volts or 230 volts AC, 50-60 Hz.

Mfr: Broadcast Technology, Inc.

Price: \$650.00

Circle 35 on Reader Service Card



AUDIO FADER

• The new Whisper Glide audio fader combines the company's Mystr conductive plastic elements with a new, smoother action designed to meet the needs of the recording and broadcasting industries. The Whisper Glide fader uses a stable, glass-hard resistance element with a compatible precious-metal contact. Waters' curve-shaping technique reduces unit-to-unit

variations to assure proper tracking in stereo and multi-channel mono applications. The Whisper Glide fader is equipped with industry standard gold-plated multi-pin connectors for quick installation or replacement without the use of a solder, and is available in 100 and 65 millimeter sizes.

Mfr: Waters Manufacturing, Inc.

Circle 37 on Reader Service Card

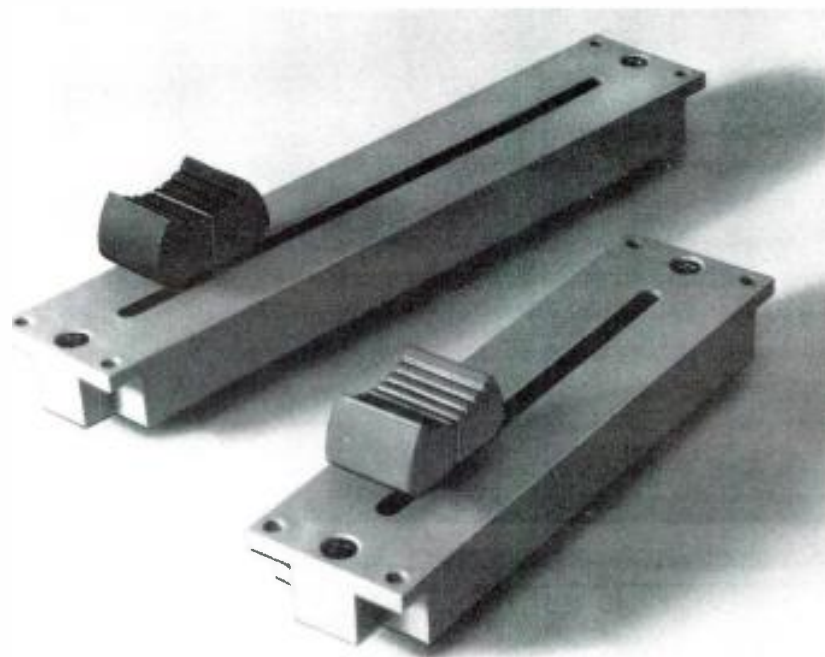

Introducing
**THE SOUND EFFECTS
LIBRARY FOR
PROFESSIONALS**

- 3000 STEREO EFFECTS
- 300 PAGE CATALOGUE
- 30 HOURS OF SOUNDS
- 125 TAPES at 7 1/2 or 15ips
- PRICED FROM \$1500.00

"Some of our Clients."

- * ABC
- * NBC
- * Walt Disney Prod.
- * Universal Recording



86 McGill Street,
Toronto, Ontario
Canada M5B 1H2
(416) 977-0512

Circle 30 on Reader Service Card



In general, spring reverbs don't have the best reputation in the world. Their bassy "twang" is only a rough approximation of natural room acoustics. That's a pity because it means that many people will dismiss this exceptional product as "just another spring reverb". And it's not. In this extraordinary design Craig Anderton uses double springs, but much more importantly "hot rod's" the transducers so that the muddy sound typical of most springs is replaced with the bright clarity associated with expensive studio plate systems.

Kit consists of circuit board, instructions, all electronic parts and two reverb spring units. User must provide power (± 9 to 15 v) and mounting (reverb units are typically mounted away from the console).

CHARGE TO VISA OR MC TOLL-FREE

1-800-654-8657 9AM to 5PM CST MON-FRI

DIRECT INQUIRIES TO:

PMA Electronics, Inc.

Dept. 3d, 1020 W. Wilshire Bv. Oklahoma City, OK 73116 (405) 843-9626

Send the 6740 REVERB KIT \$59.95 plus shipping (\$3) enclosed or charged.

Send Free Catalog

name _____

address _____

city _____ state _____ zip _____

Circle 31 on Reader Service Card

Audio Tape for professionals



REEL TO REEL TAPE
Ampex, 3M. All grades.
On reels or hubs.

CASSETTES, C-10—C-90
With Agfa, TDK tape.

LEADER & SPLICING TAPE

EMPTY REELS & BOXES
All widths, sizes.

**Competitive!
Shipped from Stock!**

Ask for our recording supplies catalog.

Polyline Corp. 312/298-5300
1233 Rand Rd. • Des Plaines, IL 60016

15

VOCAL MICROPHONE

• The M 300 is a cardioid unidirectional moving coil mic designed for the demands of musicians, vocalists and entertainers. Featuring a tapered frequency response with a high frequency rise and mid-range presence boost, the M 300 retains the sound of a ribbon microphone. Other features include a frequency response of 50 to 15,000 Hz, a built-in pop filter, field-replaceable element and 25 foot cable with Neutrik XLR connector.

Mfr: *Beyer Dynamic, Inc.*

Circle 38 on Reader Service Card



REEL MASTER TRANSPORT OPTION

• Telex Communications, Inc. has added a new 10½-in. reel master transport option for use with existing 300 series duplicating systems. The new option allows 300 system owners the opportunity to increase their system's speed and gain the convenience of 10½-in. reels with no modification to the rest of the system. In the past, only 7-in. reel transports were available, requiring the user to rethread tape onto a smaller reel if the original was only available on a 10½-in. reel. The new model 6300 master transport uses

either 7- or 10½-in. NAB reels, and the proper reel tension and torque for each size is selected easily with a convenient switch. The system runs at an 8 to 1 speed ratio that doubles the reel-to-cassette production available when duplicating from 7½ ips masters. A tape speed switch is conveniently located and is used to select either 30 or 60 ips running speeds with equalization set automatically.

Mfr: *Telex Communications, Inc.*

Price: starts at \$2,800.00

Circle 39 on Reader Service Card



STEREO AUDIO MIXER

• The Model 4000 Stereo Audio Mixer, which replaces the Model 4000 Disco Mixer, is designed to deliver clean, distortion-free sound for a wide variety of small PA applications. The new version incorporates low-noise circuitry, with improved IC's, filtering caps and connectors. The Model 4000 features four input channels—two phono and two tape. Instant visual

monitoring is provided by two externally placed 10-segment LED displays, assignable for comparing cue and program or left and right program outputs. The cueing system can be programmed to monitor all phases of the signal path, while lock-out switches assure faster, more positive cue mode selection. With the cue blend control, the announcer can blend the program and the pre-selected cue. A "beat sync" circuit and associated LED indicate

when beats from up to three different sources are perfectly matched. There are two separate 3-band equalizers on the program output, with an additional equalizer on the announcer microphone. Other features include variable attenuation on talkover, monitor output with level control, high level audio-to-light output, and console or rack-mount option.

Mfr: Biamp Systems

Circle 40 on Reader Service Card



REVERBERATION SYSTEM

• The Master-Room XL-404 professional reverberation system is called the "Plate Synthesizer" because it duplicates the reverberation qualities and properties of a plate type reverberator. The XL-404 is a fully self-contained, 5¼ inch rack-mount unit that is designed to be used in recording or broadcast applications. It can also be used in sound reinforcement systems, providing the sound of a plate in a highly portable package. The Plate Synthesizer provides the user with the ability to adjust the Decay Time on each channel without damping; the decay time is adjustable from one to four seconds. Another feature of the XL-404 is a four-band equalization setting that allows the user to tailor the sound of the reverb from a warm-sounding plate to one with an abundance of high frequency content. A Mix control is provided that combines the Direct and Reverberated signals, along with a switch to select between Stereo or Mono

operation. In the Stereo mode, the XL-404 operates in true stereo. In the Mono mode, the echo density is effectively doubled due to the summing of both reverb channels. The XL-404 also provides effective signal monitoring through a 5-LED display for each channel. Signal connections are made

via XLR connectors on the rear panel and ¼ inch connectors on the front panel. Either 115 or 230 volt operation can be selected via a rear panel voltage selector switch.

Mfr: MicMix Audio Products, Inc.

Circle 41 on Reader Service Card



AUTOMATIC MICROPHONE SYSTEM

• The Shure Automatic Microphone System consists of five basic component models: the AMS22 microphone (low profile); the AMS26 microphone (probe type); the AMS8000 mixer (eight-channel), and the AMS880 video switcher interface. Multiple AMS mixers can be patched together to effectively control more than 200 microphones. Each AMS microphone is activated only by sound that originates within a 120-degree window of acceptance. Sound sources outside this window will not make the microphone turn on, regardless of their loudness. Microphones designed to work with the AMS are capable of individually adjusting their sensitivity in relation to the amount of background noise. As background noise increases, each microphone becomes less sensitive and vice versa. Two AMS mixers are available: the AMS4000 (four-channel) and the AMS8000 (eight-channel). The mixers have a full complement of controls, indicators, inputs and outputs, including: individual channel volume controls, direct output jacks, channel LED indicators, hold time switch, normal and overload LEDs, headphone output, and link jacks. In addition, the mixers feature logic terminals that make a wide variety of special functions



possible, including chairman-controlled muting, loudspeaker muting, remote channel-on indicator, and remote microprocessor control. Through the use of the microcomputer-based AMS880 Video Switcher Interface, the Automatic Microphone System can be

connected to commercially available video switchers. After connection, the AMS will automatically provide user-programmable, voice-activated camera switching, with video following audio.

Mfr: Shure Bros., Inc.

Circle 42 on Reader Service Card

I/O BOARD REPLACEMENT

• The ATR-100 Transformerless I/O Board Replacement features simple set-up and alignment. A supermatched transistor pair with .01 percent resistors maintains very low noise with maximum common mode rejection ratio. The output uses the new OP-37 precision op-amps in conjunction with VMOS and ring emitter transistors for minimum distortion. Features include transformerless coupling with correct absolute polarity, unbalanced line output capability without level change, balanced voltage supply shutdown, power on/off mute protect circuit and easy PCB replacement. Improved specifications include variable input sensitivity from -10 dBm to +40 dBm, frequency response of ± 1 dB 10 Hz-20 kHz, a wide bandwidth of ± 1 dB 5 Hz-100 kHz, output noise better than 90 dB below operating level (A weighted), and an input to output system slew rate better than 20 V/microsec.

Mfr: Strategic Sound Inc.

Price: \$1,450.00 a pair

Circle 43 on Reader Service Card



Classified

Closing date is the fifteenth of the second month preceding the date of issue.
Send copies to: Classified Ad Dept.
db THE SOUND ENGINEERING MAGAZINE
1120 Old Country Road, Plainview, New York 11803

Minimum order accepted: \$25.00
Rates: \$1.00 a word
Boxed Ads: \$40.00 per column inch
db Box Number: \$8.50 for wording "Dept. XX," etc.
Plus \$1.50 to cover postage

Frequency Discounts: 6 times, 15%; 12 times, 30%

ALL CLASSIFIED ADS MUST BE PREPAID.

FOR SALE

WANTED: MCI, Neve console; MCI, Ampex tape machine; Neumann, E-V mics; McIntosh amps. (204) 885-2922.

PRO AUDIO IN STOCK—ready to ship. Top lines, top dollar trade-ins, clearance specials. Call or write for our prices. Professional Audio Video Corporation, 384 Grand Street, Paterson, NJ 07575 (201) 523-3333.

TEAC Model 10B 16 x 8 Console, 116-8 Channel monitor, 120 cue/solo, 104 talkback, 2-105A tape remotes, 2 model one's, 2 MB 20's, little use, excellent condition. (218) 281-6450.

STUDER RECORDING CONSOLE 12 EQ'D Inputs, 2 Out, Peak Metered/Good Condition. Ochoa Recording Studios \$4,200. (809) 754-6363/Jack Sherdel.

MCI JH24B, JH100 16 track, locator, mint \$13,500.00. Electrodyne 16 x 8 console, \$3,500.00. Ampex AG 440, 7.5, 1/2 tk., \$1,800.00. (513) 258-2463.

FREE 32pg Catalog & 50 Audio/Video Applic.



PHONO, MIC, TRANS, AC, TAPE, VIDEO, LINE, OSC

Stereo/Mono Pre Ampl. PWR SUPP. EQ.

Video & Audio Dist. Amplis. TV Audio & Recd Prod Consoles

OPAMP LABS INC (213) 934-3566
1033 N Sycamore Av LOS ANGELES CA. 90038

BLANK AUDIO AND VIDEO CASSETTES direct from manufacturer, below wholesale, any length cassettes: 4 different qualities to choose from. Ampex and Agfa mastertape—from 1/2-inch to 2-inch. Cassette duplication also available. Brochure. Andol Audio Products, Inc., Dept. db, 42-12 14th Ave., Brooklyn, NY 11219. Toll free 1-800-221-6578, ext. 1, NY residents (212) 435-7322.

DIRECT FROM BROADWAY

USED SOUND EQUIPMENT SALE

PETER PAN • FIDDLER • CAMELOT KING & I • CHORUS LINE • DOLLY
Wireless Microphones
Used By The Stars
AMPS • MIXERS • RECORDERS
all guaranteed

 **SOUND ASSOCIATES, INC.**
424 WEST 45 ST. • N.Y., N.Y. 10036
TELEPHONE 212-757-5679

Would you believe REAL-TIME cassette copies for \$1.03 each? Exquisite sound, modest cost. Denon DR-F8 Recorders, AGFA Tape. Full-color printing and assembly available. America's most experienced Real-Time Duplicators. Contact GRD (602) 252-0077, P.O. Box 13054, Phoenix, AZ 85002.

THE LIBRARY... Sound effects recorded in STEREO using Dolby throughout. Over 350 effects on ten discs. \$100.00. Write The Library, P.O. Box 18145, Denver, CO 80218.

USED RECORDING equipment for sale. Dan (415) 441-8934.

FOR SALE—AKG C-24 and other tube type condenser mics. (415) 441-8934 or 527-6167.

INSTRUCTION

LEARN MULTI-TRACK RECORDING from set-up to mix-down. Intensive studio engineering course equal to or better than most. Limited enrollment, policy of four students per one month course. New 16-track gear, registered trade school. Mid-Ocean Recording, 1578 Erin St., Winnipeg, Manitoba, Canada R3E 2T1. (204) 774-3715.

WANTED

WANTED: TRANSCRIPTION discs, any size, speed. Radio shows, music. P.O. Box 724-db, Redmond, WA 98052.

SERVICES

MAGNETIC HEAD relapping—24 hour service. Replacement heads for professional recorders. IEM, 350 N. Eric Drive, Palatine, IL 60067. (312) 358-4622.

ACOUSTIC CONSULTATION—Specializing in studios, control rooms, discos. Qualified personnel, reasonable rates. Acoustilog, Bruel & Kjaer, HP, Tektronix, Ivie equipment calibrated on premises. Reverberation timer and RTA rentals. Acoustilog, 19 Mercer Street, New York, NY 10013. (212) 925-1365.

VIF INTERNATIONAL will remanufacture your Ampex or Scully (Ashland/Bodine) direct drive capstan motor for \$200. Average turn around time 2-3 weeks. For details write: P.O. Box 1555, Mountain View, CA 94042, or phone (408) 739-9740.

AMPEX FACTORY SERVICE: Complete service and parts for Ampex equipment: professional audio, helical-scan video systems and professional audio motor and head assembly rebuilding. AMPEX SERVICE CENTER, 719 W. Algonquin Rd., Arlington Heights, IL 60005, 1-800-323-0692 or (312) 358-4622.

People, Places

• **Vincent T. Wasilewski**, a partner with **Dow, Lohnes & Albertson**, Washington, D.C., and former **National Association of Broadcasters'** president, has been named recipient of NAB's 1983 Distinguished Service Award—the industry's highest honor. Presentation of the award will be made April 10 at the opening session of the Association's 61st annual convention at the Las Vegas Convention Center.

The award, established in 1953, is presented to a person who has made "a significant and lasting contribution to the American system of broadcasting by virtue of a singular achievement or continuing service for or on behalf of the industry."

The selection was made by NAB's 1983 Convention Committee during the Association's semi-annual Board of Directors meeting.

Wasilewski, who retired from the NAB presidency last October, joined the Association's legal staff directly from the University of Illinois law school in October, 1949.

Three years later, in February, 1953, he was named Chief Counsel of the Association. He became manager of Government Relations in August, 1955; vice president of Government Affairs in June, 1960, and executive vice president in August, 1961 when the post was created.

He is a member of the American Bar Association and the Federal Communications Bar Association. He is also chairman of the Religious Educators Foundation and a Trustee of the **Museum of Broadcasting**.

The NAB serves a membership of over 4,500 radio and 690 television stations, including all the major networks.

• **BGW Systems, Inc.** has announced the appointment of **Roger Ponto Associates** as independent manufacturer's representative serving Oregon, Washington, Montana, Idaho and Alaska. To better serve BGW's expanding network of dealers in the Pacific Northwest, Roger Ponto Associates will handle their entire line of professional and commercial power amplifiers, including the newly introduced series of **PROLINE™** audio products. Roger Ponto Associates are located at 8611 N.E. 26th Place, (P.O. Box 3365) Bellevue, WA 98009 (Tel: 206-453-8487).

• **Donald V. Kleffman**, vice president and general manager of **Ampex Corporation's Audio-Video Systems Division (AVSD)**, has been assigned to the

International Division to assume worldwide responsibilities for the company's video business segment. According to **Arthur H. Hausman**, Ampex chairman, president and chief executive officer, Kleffman is responsible for worldwide video business development and continues as a corporate vice president reporting to **Charles A. Steinberg**, executive vice president and chief operating officer. In addition, Kleffman has been appointed executive vice president of Ampex International responsible for video marketing, and also has been appointed general manager of the Americas, Far East (AMFE) area of Ampex International. Concurrent with Kleffman's new duties, **Mark L. Sanders**, general manager of the video recorder group in AVSD, succeeds Kleffman as division general manager, and **Cliff Moggs**, AMFE general manager, is appointed area manager of the Europe/Africa/Middle East (EAME) area, succeeding **Gerhard K. Wick**, who will be transferred to another position within the company.

• **Randy's Roost**, one of Music Row's busiest record mastering facilities, will change its name to **Disc Mastering Inc.** effective March 1, 1983. Located in the RCA-Nashville building at 30 Music Square West, Randy's Roost has enjoyed a prominent place in the Nashville music community since its 1977 opening. The facility has hosted such notables as **Alabama**, **John Denver**, **Elvis**, **Waylon Jennings**, **Cristy Lane**, **Loretta Lynn**, **Barbara Mandrell**, **Dolly Parton**, **Charley Pride**, **Jerry Reed**, **George Strait**, and **Jimmy Swaggart**. In addition to a vast country and gospel output, the mastering studio is involved in other markets. The facility is equipped with Studer tape machines, a Neumann VMS 70 lathe with SX-74 head, and a Neumann SP75 console with Neve 2087 custom equalizers. **Randy Kling**, owner/operator of the studio, stresses that the name change is just that. "With so much going on here, I felt it appropriate to give the studio a more professional-sounding name," he explained. "In respect to all other aspects of operation—ownership, personnel, and equipment—Randy's Roost will remain the same after its name changes."

• **Soundcraft Electronics, England**, has announced the move of its U.S. Sales Office to a new facility in Santa Monica, California. The new address is Soundcraft Electronics, 1517 20th Street, Santa Monica, CA 90404.

• **Mack Emerman**, president of **Criteria Recording Studios** in Miami, has announced the appointment of **Richard Lee** to the position of general manager. Mr. Lee has extensive technical and managerial experience in the audio-video field, and under his direction Criteria will seek diversification into the areas of audio-video-film post production.

• **Cramer Audio/Video** in Needham, Massachusetts is proud to have been appointed the first Studer dealer in the United States. Studer heretofore has sold all of its products directly from the factory. Cramer has already provided a Studer A80 24-track recorder to **Sound Design Recording** in Burlington, Massachusetts, and an A810 2-track recorder with time-code head to Harvard University. For information about any Studer products, contact **Mark Parsons** at Cramer: (800) 343-5800 or (617) 449-2100 (inside Massachusetts).

• **Quad Eight Electronics** has announced the appointment of **Tracy Battle** to the position of director of marketing. Formerly with **Quantum Audio Labs**, Mr. Battle comes to Quad/Eight with over six years experience with professional audio systems.

• **National Video Center/Recording Studios** has acquired a **Lexicon 1200B Time Compressor/Expander/Controller**. In addition to enabling clients to speed up (tighten) overlong programming or to slow down (expand) material to fit specific time frames (without loss of definition or bandwidth), the Lexicon 1200B can be used as a stand alone unit with audio or in conjunction with video. The Lexicon is adaptable to both stereo and mono recording and mixing projects.

• **Michael O. Felix**, general manager of the Advanced Technology Division, (ATD), has been elected a vice president of the corporation by **Ampex Corporation's** board of directors. Felix was named general manager of ATD in December 1981, and has directed the company's research and advanced technology programs since then. He has specialized in the design and development of magnetic recording systems since joining Ampex in 1960, and has been involved in the development of many important products in previous assignments as chief engineer of several Ampex product divisions. Felix was recognized for his work in 1981 with presentation of the **Alexander M. Poniatoff Award**, the company's highest honor for technical achievement.

.. & Happenings

Ampex Opens Museum Of Magnetic Recording

• The most comprehensive exhibit of magnetic recording technology in the world today has been assembled at Ampex Corporation's Museum of Magnetic Recording, located at Ampex's corporate headquarters in Redwood City, California.

Equipment on display at the museum covers the technological spectrum from a rare 1911 Telegraphone Model C wire recorder to today's sophisticated audio and video tape recorders.

The museum, developed over a two-year period under the direction of curator Peter Hammar, represents an investment of over \$1 million.

The museum has been designed for both lay and expert visitors, and accommodates people who are interested in a quick tour who have a deep interest in the technology.

"Our concept from the beginning was to tell the whole story," remarked Hammar. "If an Ampex competitor was part of the story, we gave them full credit, making the museum as complete and credible as possible."

Working as a consultant to Ampex, Hammar obtained assistance from

such industry pioneers as the 3M Company, BASF, AEG-Telefunken, Agfa-Gevaert, Studer, Sony Corporation, as well as CBS, ABC and NBC in gathering information and locating equipment for the museum.

Hammar was also able to utilize the expertise available at Ampex. He worked closely with the late Harold W. Lindsay, who designed America's first professional audio recorder, the Ampex Model 200. (Lindsay died in April, 1982, shortly before the museum was opened for a preview showing.)

Hammar also received valuable assistance from Heinz Thiele, a German pioneer in magnetic recording technology, whose support gave Hammar's work added credibility in the European technical community.

Hammar's extensive research in the U.S. and Europe turned up rare pieces of equipment for the Ampex Museum, including a 1911 Telegraphone Model C wire recorder, developed as an automatic telephone answering device and one of the oldest magnetic recorders on display in the U.S.; a 1936 AEG Magnetophon FT-2, the oldest tape recorder on exhibit in the U.S., and the proto-

type for the modern audio tape recorder; an Ampex Model 200 audio tape recorder, first marketed in the U.S. in 1948, and an Ampex VRX-1000, America's first successful video tape recorder, introduced in 1956.

Also on display is an array of magnetic recording media—wire, steel band and tape—produced from 1898 to 1965. The display will change periodically.

The museum is arranged in a series of 28 stations, each with its own television monitor. The traditional photos and text that accompany each piece of historic hardware are augmented by information on the TV screens. Beginning in 1983, visitors will be able to "call up" on the TV screens computer-generated graphic information according to individual interest.

The Ampex Museum of Magnetic Recording is opened to interested groups by appointment only. For information on museum visiting hours or assistance in arranging tours, contact the Ampex Public Relations Department at (415) 367-4151, weekdays from 8 a.m. to 12 p.m. and 1 p.m. to 5 p.m.



The Ampex Museum of Magnetic Recording recounts the history of the technology's development in 28 separate displays. Pictured here are examples of magnetic recording media—including wire steel band and tape—covering the period 1898 to 1965. Also pictured are four examples of early portable and home audio tape recorders



Peter Hammar, curator of the Ampex Museum of Magnetic Recording, shows off one of the centrepieces of the museum, an Ampex VRX-1000 video tape recorder. This one was the fourth one produced by Ampex and the first delivered to a customer, the CBS Television Network, in 1956.

MAJOR EQUIPMENT ADDITIONS AT THE AUTOMATT

• Automatt studio manager Michelle Zarin is pleased to announce the completion of major upgrading of Studios A and C at the Automatt. Two Studer

24-track recorders have been added, with the result that Studio A is now a complete Trident/Studer/Meyer studio. Additional equipment includes two new Lexicon PCM 42 Digital Delays and two Studer two-track recorders with half inch capabilities.



Too Much Noise? Try Adding a Little Noise

• An experiment by Niagara Mohawk Power Corp. using noise to fight offending noise—an environmental problem at some electric installations—is moving from the research lab to future field testing, NM disclosed.

The objective of the utility research project, based on a recent theory of a French physicist, is to “cancel out” unwanted humming from substation transformers situated near residential dwellings, explained **Howard D. Philipp**, NM research director.

“Quite simply, we’re combatting noise with noise,” Philipp remarked. “Called ‘acoustical cancellation,’ this is accomplished by receiving the errant noise with an array of microphones, electronically processing the noise in a small computer and amplifier and projecting the ‘anti-noise’ back into the unwanted sound waves to absorb the transformer hum.”

A French acoustical physicist, **M.J.M. Jessel**, originated the cancellation theory in 1964, applying highly sophisticated mathematical formulas to the science of sound. “In fact, the ultimate theoretical conclusion is that any sound—from transformer humming to excessively loud music—can be used to literally cancel itself in all directions,” Philipp pointed out.

“This approach to noise suppression is a pioneering step,” NM’s research director said. “Here, active rather than passive means are applied to reduce—by sound-wave absorption—any hum frequencies emitted by transformers. This project is the first successful attempt at cancelling a complex noise source in all directions simultaneously. With acoustical cancellation, we can absorb noise on all sides of a transformer or a selected area without physical contact with the unit.”

Acoustical cancellation may be applied on a practical scale at NM substations in a few years.

• The West Coast Sales Office of **Gotham Audio Corporation** and its subsidiary **Gotham Export Corporation** are now located on the premises of **Quantum Audio Labs, Inc.**, a company recently acquired by Gotham. The new address is: 1909 Riverside Drive, Glendale, CA 91201. Phone: (213) 841-1111. **Hugh S. Allen, Jr.**, executive V.P. of Gotham Audio Corporation, has moved to the Glendale address and is acting as general manager of Quantum while continuing his duties for Gotham.

Studer Re-States the Art



With the new A810, Studer makes a quantum leap forward in audio recorder technology. Quite simply, it re-states the art of analog audio recording.

By combining traditional Swiss craftsmanship with the latest microprocessor control systems, Studer has engineered an audio recorder with unprecedented capabilities. All transport functions are totally microprocessor controlled, and all *four* tape speeds (3.75 to 30 ips) are front-panel selectable. The digital readout gives real time indication (+ or - in hrs, min, and sec) at all speeds, including vari-speed. A zero locate and one autolocate position are always at hand.

That's only the beginning. The A810 also provides three "soft keys" which may be user programmed for a variety of operating features. It's your choice. Three more locate positions. Start locate. Pause. Fader start. Tape dump. Remote ready. Time code enable. You can program your A810 for one specialized application, then re-program it later for another use.

There's more. Electronic alignment of audio parameters (bias, level, EQ) is accomplished via digital pad networks. (Trimpots have been eliminated.) After programming alignments into the A810's memory, you simply push a button to re-align when switching tape formulations.

The A810 also introduces a new generation of audio electronics, with your choice of either transformerless or transformer-balanced in/out cards. Both offer advanced phase compensation circuits for unprecedented phase linearity. The new transport control servo system responds quickly, runs cool, and offers four spooling speeds.

Everything so far is standard. As an option, the A810 offers time-coincident SMPTE code on a center track between stereo audio channels. Separate time code heads ensure audio/code crosstalk rejection of better than 90 dB, while an internal digital delay automatically compensates for the time offset at all speeds. Code and audio always come out together, just like on your 4-track. Except you only pay for 1/4" tape.

If you'd like computer control of all these functions simply order the optional serial interface. It's compatible with RS232, RS422, and RS422-modified busses.

More features, standard and optional, are available. We suggest you contact your Studer representative for details. Granted, we've packed a lot into one small package, but ultimately you'll find that the Studer A810 is the most versatile, most practical, most *useable* audio recorder you can buy.

The Swiss wouldn't have it any other way.



STUDER REVOX
PRECISION FROM SWITZERLAND

Studer Revox America, Inc. • 1425 Elm Street • Nashville, TN 37210 (615) 254-5651
Offices: Los Angeles (213) 780-4234 • New York (212) 255-1111 • Dallas (214) 760-8647 • Canada: Studer Revox Canada, Ltd.

Circle 11 on Reader Service Card

INTRODUCING THE SMART MIC* SYSTEM

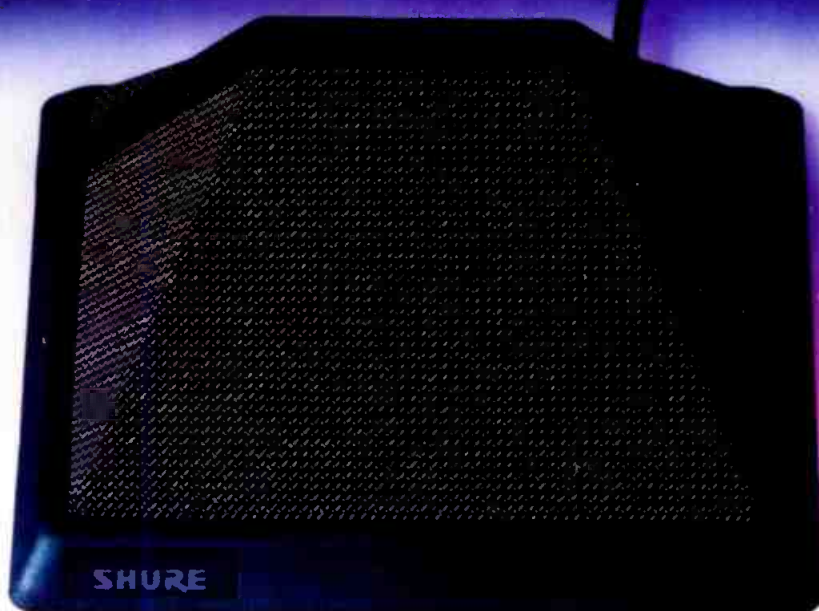

Actual Size

The most troublesome audio conditions can only be solved by today's most trouble free microphone system. The Shure Automatic Microphone System.

Total integration is the key.

For the first time ever, Shure has combined microphone, mixer and logic technology in a dedicated, totally integrated system—so advanced, its conception marks the beginning of a sound revolution in conference rooms, teleconferencing, churches, legislative chambers, courtrooms—anywhere speech related multi-microphone systems are employed.



At the heart of Shure's Automatic Microphone System (AMS) are revolutionary, angle-sensitive microphones that turn on automatically *only* when addressed within their own 120° "window of acceptance." In addition, each microphone continuously samples its own local acoustic environment, and compensates for changing room audio conditions—automatically.

The Shure AMS incorporates advanced signal processing circuitry—turning on to the sound source quickly, quietly, and automatically—and turning off with a smooth whisper. From

beginning to end—no clicks, pops, noise "pumping," or missed syllables.

Logic terminals on the rear panel of every AMS mixer offer unprecedented flexibility for advancing the system's capabilities. For example, when connected with Shure's Video Switcher Interface, the AMS will control commercially available video switchers. And for large gatherings, AMS mixers (both 4 and 8 channel models available) can easily be combined to effectively control over 200 individual microphones.

Since the AMS operates as an integrated system, many adjustments and controls have been eliminated. As a result, no other unit sets up as quickly. And operation is so easy and automatic, the only adjustments necessary are individual volume controls.

For more information on the revolutionary new Automatic Microphone System, call or write Shure Brothers Inc., 222 Hartrey Ave., Evanston, IL 60204, (312) 866-2553.

*Microphones and Intelligent Circuitry

SHURE®

THE SOUND OF THE PROFESSIONALS®... WORLDWIDE

Circle 12 on Service Card



PATENTS
PENDING

SBI-1086A