

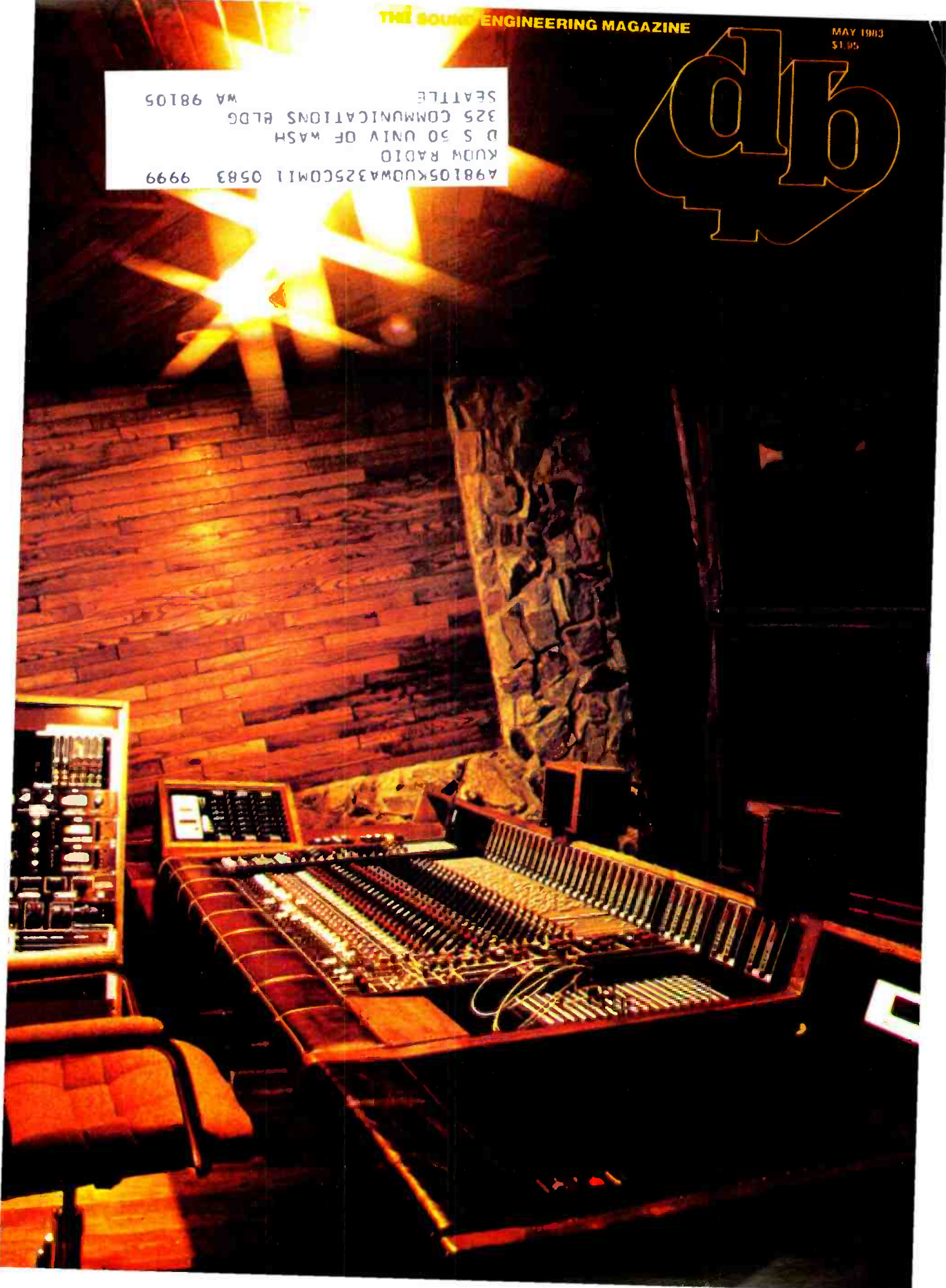

50186 WA SEATTLE  
325 COMMUNICATIONS BLDG  
D S 50 UNIV OF WASH  
KUOW RADIO  
A98105KUOWA325COM11 0583 9999

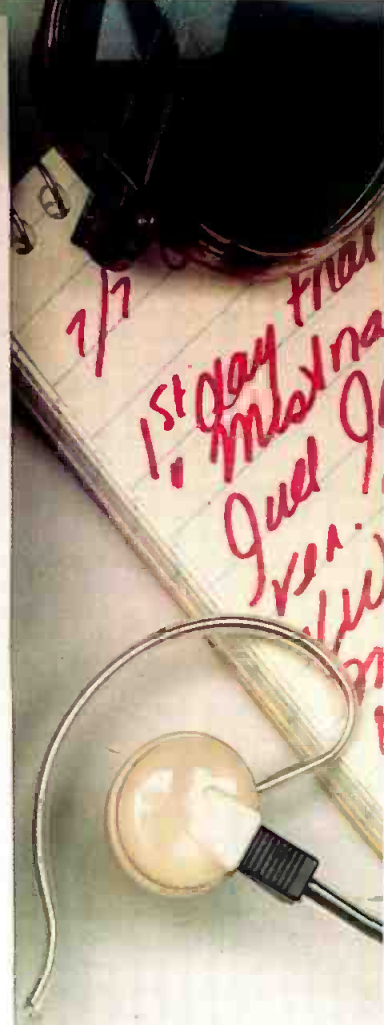



**Amid the hostility, the confusion, the competition,  
one microphone stands above the crowd.**

## The SM63.

No matter how rough things get in the field, the Shure SM63 Omnidirectional Dynamic Microphone gives your crew the whole story with a lot less handling noise than any microphone in its class. When Shure's engineers developed the SM63 and SM63L (with longer handle), their objective was to create a high-output, lightweight microphone perfect for the needs of electronic news journalists.

With the SM63's patented internal mechanical isolation system reducing undesirable handling noise, its high output and smooth extended frequency response lets your story come through crisp and clear. Its omnidirectional polar pattern prevents boominess that is often encountered during close miking situations. And its overall lightness makes continuous hand-held ENG/EFM assignments less fatiguing, without sacrificing ruggedness. Even its profile is small and elegant so it won't obscure faces on camera.

The output of the SM63 is a full 6 dB higher than comparable hand-held interview microphones.

And there are even more precision-engineered refinements. A highly effective internal humbucking coil rejects strong magnetic fields encountered around lights and other broadcast situations. And when things get really tough, the Shure-developed VERAFLEX® grille is virtually impervious to rust, moisture and dents. This system includes a highly effective internal anti-wind and -pop filter; and for more adverse conditions, a dual-density two-layer windscreen also is supplied.

The Shure SM63. The hard-working microphone for the working press.

For more information on the complete line of professional broadcast products, call or write Shure Brothers Inc., 222 Hartrey Ave., Evanston, IL 60204, (312) 866-2553.

# SHURE®

**THE SOUND OF THE PROFESSIONALS®...WORLDWIDE**

Circle 10 on Reader Service Card

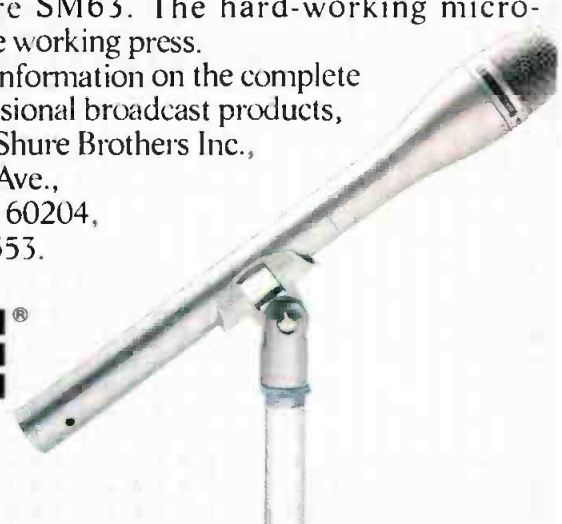

Publisher  
**Larry Zide**  
 Associate Publisher  
**Elaine Zide**  
 Editor  
**John M. Woram**  
 Managing Editor  
**Mark B. Waldstein**  
 Associate Editor  
**Ricki Zide**  
 Technical Editor  
**Linda Cortese**  
 European Editor  
**John Borwick**  
 Layout & Design  
**Kathi Lippe**  
 Advertising Coordinator  
**Karen Cohn**  
 Book Sales  
**Lydia Calogrides**  
 Circulation Manager  
**Eloise Beach**  
 Graphics  
**K & S Graphics**  
 Typography  
**Spartan Phototype Co.**



MAY 1983 VOLUME 17, NO. 5

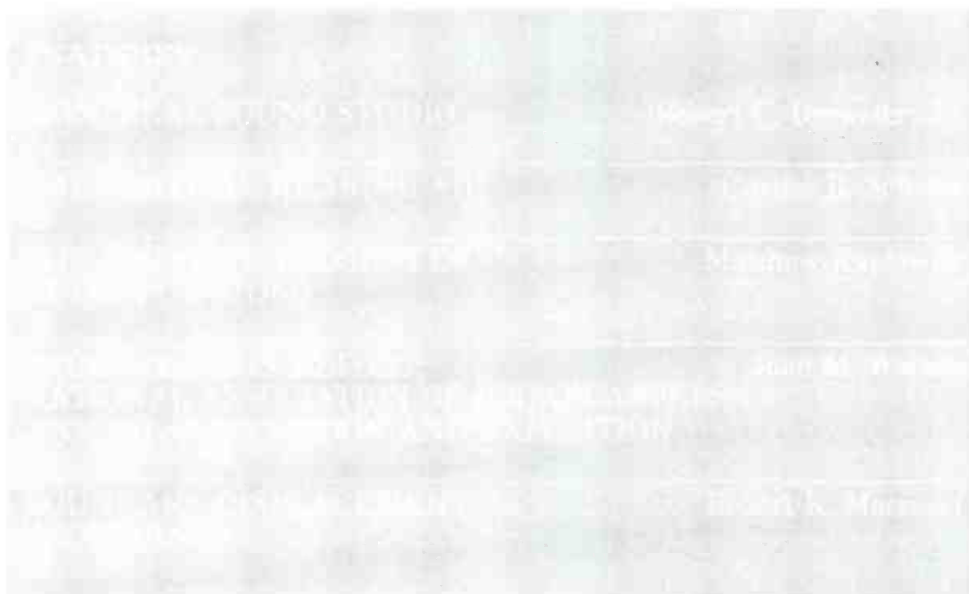

sales offices

**Roy McDonald Associates, Inc.**  
 Dallas, Texas 75207  
 First Continental Bank Bldg.  
 5801 Marvin D. Love Freeway  
 Suite 303  
 (214) 941-4461

**Denver, Colorado Area**  
**Englewood, Colorado 80112**  
 14 Inverness Dr. East  
 Bldg. 1—Penthouse  
 (303) 771-8181

**Houston, Texas 77036**  
 6901 Corporate Drive  
 Suite 210  
 (713) 988-5005

**Los Angeles Area**  
**Glendale, California 91204**  
 424 West Colorado Street  
 Suite 201  
 (213) 244-8176

**Portland Area**  
**Hillsboro, Oregon 97123**  
 510 South First  
 P.O. Box 696  
 (503) 640-2011

**San Francisco Area**  
**Emeryville, California 94608**  
 265 Baybridge Office Plaza  
 5801 Christie Avenue  
 (415) 653-2122

**Sagamore Publishing Co.**  
 New York  
**Plainview, NY 11803**  
 1120 Old Country Rd.  
 (516) 433-6530

**DEPARTMENTS**

<b>LETTERS</b>	<b>EDITORIAL</b>	<b>CLASSIFIED</b>
6	18	57
<b>SOUND WITH IMAGES</b>		Len Feldman
10		
<b>DIGITAL AUDIO</b>		Barry Blesser
14		
<b>THEORY AND PRACTICE</b>		Ken Pohlmann
22		
<b>SOUND REINFORCEMENT</b>		John Eargle
26		
<b>NEW PRODUCTS AND SERVICES</b>		
53, 54		
<b>NEW LITERATURE</b>		
56		
<b>PEOPLE, PLACES, HAPPENINGS</b>		
59		

**ABOUT THE COVER**

• This month's cover features the control room of Eleven Eleven Sound Studios. Equipment presently in use includes a Harrison MR-2 Console, a Studer 24-track recorder and 1/2-inch mixdown machine, UREI and Allison Research limiters, Dolby 2-channel and 24-channel noise reduction and Sierra monitors.

db, the Sound Engineering Magazine (ISSN 0011-7145) is published monthly by Sagamore Publishing Company, Inc. Entire contents copyright © 1983 by Sagamore Publishing Co., 1120 Old Country Road, Plainview, L.I., N.Y. 11803. Telephone (516) 433-6530. db is published for those individuals and firms in professional audio-recording, broadcast, audio-visual, sound reinforcement, consultants, video recording, film sound, etc. Application should be made on the subscription form in the rear of each issue. Subscriptions are \$15.00 per year (\$28.00 per year outside U.S. Possessions; \$16.00 per year Canada) in U.S. funds. Single copies are \$1.95 each. Editorial, Publishing and Sales Offices, 1120 Old Country Road, Plainview, New York 11803. Controlled circulation postage paid at Plainview, NY 11803 and an additional mailing office.

# 50 Years of more . . .

Since 1933, J. W. Davis has helped sound contractors to be more professional, more productive and more profitable. We're celebrating our 50th anniversary this year because we provide

## More Inventory

The widest range of professional sound products available from a single source. Everything. From speakers to amplifiers to intercom systems. Even hard-to-find accessory items.

## More Service

Your orders will be shipped within 36 hours of receipt. Faster if necessary.

## More Personal Attention

We're your unseen helper. With knowledgeable and experienced customer service people who really care. We get your job done!

## More Profits

Faster delivery, larger inventory and competitive pricing all add up to greater profits for you.

We're not getting older; we're getting better. Try us to see the difference 50 years of experience can make to your company.

Call toll free today for new price list 1-800-527-5705, TEXAS 1-800-442-1564.

J. W. Davis & Company  
3215 Canton Street  
P.O. Box 26177  
Dallas, Texas 75226



## Letters

### MORE ON CORTICAL HEARING AIDS

I am very much interested in the "Cortical Hearing Aid" mentioned in Curtiss Schafer's letter in the January, 1983 issue of db...it sounds like a fascinating development, and may even be useful for high-fidelity reproduction....it sounds too good to be true, so if it can be substantiated, much R & D money could probably be found....how do I find out more about the Cortical Hearing Aid?...please, more information!

VARIOUS READERS

### db replies:

*Sometimes we wonder how db Magazine finds its way into so many out-of-the-way (for us, that is) places. Mr. Schafer's short letter in our January letters column has drawn more response than just about anything that has ever appeared there in the last several years. We're heard from medical centers, government agencies, private parties, and overseas laboratories. Everyone wants to know more.*

*We're got mixed emotions about all of this. We're having a hard enough time keeping track of digital audio, video, automation and all the other technological developments with which we are supposed to be familiar. When it comes to helping the hearing impaired, we're a little out of our element.*

*Yet the interest is certainly there, and so we're asked Mr. Schafer to supply a few more details, which you'll find in this issue of db. A word of caution though: Mr. Schafer's article is not the last word on the subject. The medical establishment is famous (and sometimes, notorious) for requiring exhaustive research before approving anything—especially anything that might disturb the status quo. Although some of this caution prevents widespread disaster (remember Thalidomide?), sometimes it keeps a worthwhile medicine or treatment from reaching the public for years.*

*In the case of the Cortical Hearing Aid, db is clearly not qualified to pass on its merits. More research is surely needed. But if nothing is printed at this time, that research may not happen for years. And so we publish Mr. Schafer's piece in the hope that it will be an*

## Index of Advertisers

Agfa Gevaert .....	15
Alpha Audio .....	12
Ampex .....	Cover III
Audio-Technica .....	11
Bruel & Kjaer .....	13
Crown .....	8
Electro-Voice .....	19
Emilar .....	24
Garner .....	37
GRD Recording .....	20
JBL .....	7
J. W. Davis .....	11
ITT Cannon .....	17
Kimball .....	8
Klark-Teknik .....	16
Microtran .....	27
Orban .....	9
PAIA .....	55
Polyline .....	55
Pro-Tech Audio .....	14
Renkus Heinz .....	20
Shure Bros. ....	Cover II
Soundcraft .....	25
Sound Ideas .....	24
Standard Tape Labs .....	31
Studer .....	Cover IV
Telex .....	18
UREI .....	23



### COMING NEXT MONTH

• Next month, the featured topic is Microphones. J. Mark Goode will be reviewing the Shure Automatic Microphone System, while John C. Hansen and Philip S. White of Bruel & Kjaer fill us in on that company's latest studio microphone. In addition, R. H. Coddington checks in with some "Noise on Noise," a look at noise levels in speech reproduction. Also, we'll be featuring a special New Products section devoted entirely to microphones. Of course, our regular departments and columnists will also be on hand. All this—and more—coming in June's db—The Sound Engineering Magazine.

# High Technology. JBL.



Until now, buying advanced technology high frequency components could be both a pleasure and a problem. A pleasure because of the improved performance these devices can provide. A problem because exotic designs can often be less than reliable. Or easy to use. Or cost effective.

At JBL, we don't think you should have to give up practicality to get the performance you need. And to prove it we're introducing a new generation of high frequency components that combine unsurpassed frequency response, high reliability, and surprisingly affordable prices.

The secret behind this rare blend of features lies in the use of new engineering technologies that not only improve performance, but actually reduce manufacturing costs.

Our latest 1- and 2-inch throat diameter compression drivers, for example, utilize a pure titanium diaphragm with JBL's patented diamond-pattern

surround. The exceptionally high stress limit of titanium together with the stronger surround allows this design to match the reliability of phenolic and composite type diaphragms. At the same time, the design's improved



JBL's titanium-diamond diaphragm combines performance with reliability.

flexibility and light weight provide the extended frequency response of more expensive, fragile, exotic metal diaphragms. Finally, the drivers feature a newly developed, high-flux ferrite magnetic structure for maximum efficiency and extended response.

And the drivers are only part of the story. Because JBL engineers have also developed a complete new line of compact,

Bi-Radial™ constant coverage horns. Designed for flush cabinet mounting or compact cluster applications, the horns provide precise pattern control. The horn's highly consistent horizontal dispersion eliminates the problems of midrange narrowing and high frequency beaming associated with conventional horn designs.

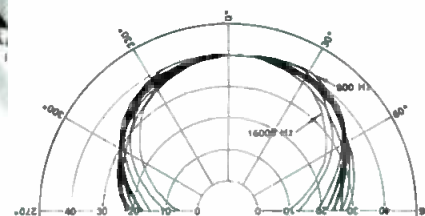

Composite 1/2-octave polar responses of a 2380 horn from 800 Hz-16 kHz in the horizontal plane.

So if you're looking for advanced high frequency components that combine real world practicality with unmatched performance, ask your local dealer about the new generation of high technology. From JBL.



Professional  
Products  
Division

JBL/harman international

JBL Incorporated,  
8500 Balboa Boulevard, P.O. Box 2200,  
Northridge, California 91329 U.S.A.

Circle 14 on Reader Service Card

**For better  
sound,  
try this**

**on your  
PZM.®**

—For more ideas on how to use PZM microphones,  
write for your free copy of PZM APPLICATION NOTES.



**CROWN**®

1718 W. Mishawaka Road, Elkhart, IN 46517.

Circle 15 on Reader Service Card

## More and more recording studios are discovering the great sound of the Kimball Professional Grand.

### Here's why:

The Kimball 6' 7" Professional Grand derives its heritage of greatness from the world's finest piano—the Bosendorfer. The scale and plate design are derived from the Bosendorfer Model 200, and the plate is extra thick to assure maximum sustain and to avoid plate noise from hammer strikes. The Bosendorfer-derived scale and non-duplexed trebles enhance tonal depth, clarity, and pitch perception. The Kimball Professional Grand is specifically designed for clear, pure tonality, free of spurious noise and false harmonics. It also offers superior durability and tuning stability. Its entire structure, including the soundboard, is of precision-laminated woods, greatly reducing differential expansion in changes of temperature and humidity.

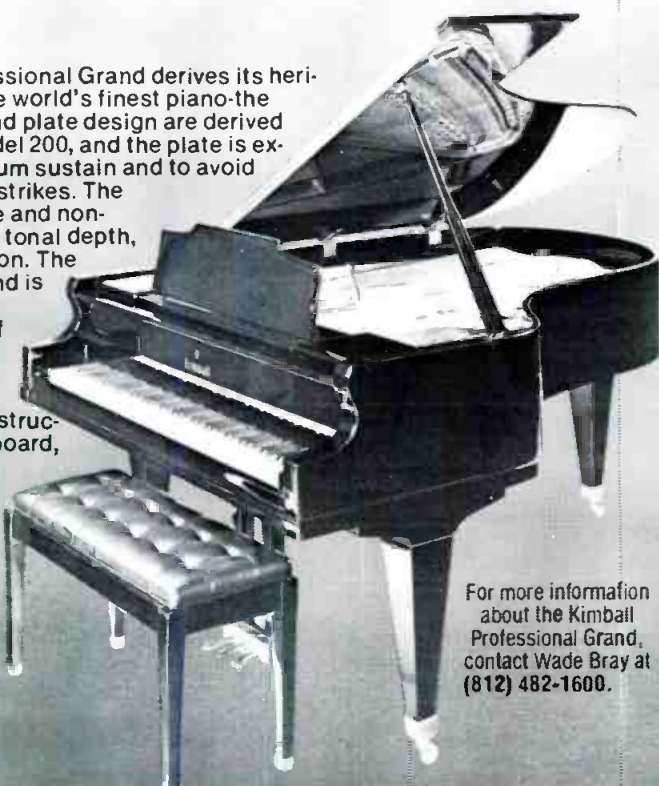

For more information  
about the Kimball  
Professional Grand,  
contact Wade Bray at  
(812) 482-1600.



**kimball**

"The key to sounding great!"  
1549 Royal St. Box 460  
Jasper, IN 47546

Circle 17 on Reader Service Card

*"opening argument" in what may  
become an extended debate. We'd like to  
hear more from others on this subject,  
and will do what we can to keep you all  
informed on future developments.*



### ERROR CORRECTION, AND BY A...PRODUCER!

Time code is something we all live with, but few of us understand the actual structure of the beast. Certainly I was interested in increasing my understanding of it. Of particular value to me was a clear explanation of drop-frame.

In the January db, your paragraphs on the subject seemed clear, and I believed that I finally understood things—that is, right up to the little illustration at the top right corner of page 42. There, I became confused again, and I hope you will be willing to offer me some further explanation.

You stated that the first two frame numbers are omitted from the start of each minute, except the minutes which start at 00, 10, 20, 30, 40 and 50. To illustrate this, you follow with two examples. I gathered that the first shows a drop of two frames because it led into minute 50, while the next example showed no drop because it led into minute 00. Well, this confuses me because I thought you had just listed the six special cases that called for no drop—and both 50 and 00 belong in this group. Wouldn't an example of a frame drop be 09:18:47:29 followed by 09:18:48:02?

ANDREW KAZDIN, producer  
New York

### db replies:

*Unfortunately, our proofreader is still trying to master the 7-times table, and hasn't gotten around to learning how to tell time. (So what? Your original manuscript is wrong anyway—PR.) Our first example should have been 09:18:59:29 followed by 09:19:00:02. The underlined portions indicate the segments that have been corrected here.*

*Your own example is on the right track, except you made the drop-frame occur after the 47th second. It should be after the 47th minute, and every other minute except the six mentioned above.*

*In addition to spotting engineering errors, Mr. Kazdin's accomplishments include a recent Grammy award as producer of the best opera recording: Wagner, Der Ring Des Nibelungen.*

# Truly superior. We'll prove it!



## The Orban 424A Gated Compressor/ Limiter/De-Esser

There are lots of production limiters out there. Old favorites. Pretenders to the throne. The competition is fierce. So, when Orban set out to design a new production limiter, we knew it had better be superior.

The result of our research is the "Studio Optimod"—a Gated Compressor/Limiter/De-Esser with versatile controls, simple set-up, and a natural, transparent sound that must be heard to be appreciated.

Try one and A/B it against your current favorite. You'll notice the **sound**—remarkably smooth and natural over a wide range of control settings—even at high compression ratios where apparent loudness and punch are significantly enhanced. It's no accident: The unit is a direct descendent of our super-popular, second-generation OPTIMOD-FM broadcast limiter. So it exploits our years of experience in making an AGC device sound natural on diverse program material without critical re-adjustments. Yet full versatility exists for special effects in production.

A bonus is a smooth, natural de-esser. It's independent of the compressor/limiter section so you can simultaneously compress and de-ess vocal material without compromise. You can even de-ess sibilant vocals which have been mixed with other program.

The icing on the cake is unique gating and "idle gain" functions which prevent unnatural noise-producing gain variations during pauses and abrupt gain changes when the unit is switched in.

Our new Model 424A (dual channel) and 422A (single channel) are destined to become the new industry standards in dynamic range control. Prove it to yourself. Contact your Orban dealer today.

## orban

Orban Associates Inc.  
645 Bryant Street  
San Francisco, CA 94107  
(415) 957-1067  
Telex: 17-1480

# Sound With Images

## Good Sound Ideas Never Die

• I'll bet you thought quadraphonic sound was dead! Well, as a four channel home audio sound reproduction system, I suppose it is. But it has left its legacy, in somewhat disguised form, in other communication disciplines. If you haven't been involved in the audio industry for more than a few years, you may need to read the following little history of quad sound (which I'll try to condense into one paragraph so that I can get to the relevant story of 4-channel sound's current impact). If your experience in audio goes back as far as the early 1970s, you can skip right over the next two paragraphs; you probably remember the events I'm going to describe as well as I do. Those were exciting times!

Around 1969 or 1970, a few audio experimenters came up with circuitry that could create a hall ambience effect, given two ordinary stereo channels of sound, by taking out-of-phase information present in the two stereo recorded tracks and feeding them to one or more speakers located behind the listener. Perhaps the simplest device created for this purpose was the totally-passive black box offered by David Hafler, then with Dynaco, Inc., a leading audio kit maker of the time. This device simply fed an L-R signal, derived right from the stereo amplifier outputs, to one or two additional speakers placed behind the listeners. Very soon thereafter, other inventors reasoned that if random out-of-phase information contained in stereo records could produce such an interesting "hall surround sound," deliberate introduction of controlled out-of-phase information *at the time a recording was made* could create an even more interesting ambient sound effect. That's how matrix four-channel sound began.

Unfortunately, every one had his/her own idea as to just how this encoding and decoding process should take place, and so, it wasn't too long before "Stereo-4" (a matrix system first offered by Electro-Voice) faced other matrix systems such as QS (by Sansui) and, ultimately, SQ, developed by CBS under the direction of the late, great Ben Bauer. All of the matrix systems suffered from lack of separation. Some had better separation between left-front and right-front, while others sacrificed left-to-right separation in

favor of front-to-back separation, and still others offered a uniform, but minimal 3 dB of separation in all directions. That's where logic circuits came in. Once you have even minimal separation in all directions, it is possible to enhance that separation electronically. One of the most outstanding logic-based encode/decode systems developed for the CBS SQ quadraphonic system was the one developed by Wesley Ruggles, Jr., co-owner of Tate Audio Ltd. That system was so good that it was able to compete with the emerging discrete four-channel record technology of the so-called CD-4 records which, by then, were being promoted by JVC, Panasonic and other Japanese and U.S. firms. As most everyone knows, quadraphonic sound, as a home audio format, began to disappear in the mid-1970s, largely because of the multiplicity of competing systems which caused utter confusion in the marketplace.

### SURROUND SOUND REBORN

All of which brings us to the present reincarnation of matrixed, logic-controlled, multi-channel sound. Tate Audio Ltd.'s proprietary technology, known (surprisingly enough) as the Tate System, was originally developed under an agreement with CBS, Inc. as a companion standard to the CBS SQ 4-2-4 channel matrix. When the SQ process is coupled to the Tate System of surround sound decoding, exceedingly high separation, like a multi-channel discrete tape, is attainable. The Tate encoding/decoding system is completely monophonic and stereo compatible, and has the inherent simplicity of requiring only two-channel software for its delivery. Therefore, encoded material, whether broadcast or recorded, behaves exactly like mono or stereo when heard on an ordinary stereo system. But the same encoded signal provides surround sound sensation when a Tate System decoder is added in the playback chain of a multi-channel audio system.

In 1978, Tate Audio Ltd. licensed its proprietary technology to Dolby Laboratories, Inc. for use in motion picture soundtracks. It is the Tate System surround-sound technology combined with other processes that forms the

motion picture surround-sound process popularly referred to as "Dolby Stereo." According to Wes Ruggles, the intent in the 1978 license to Dolby was directed at building a motion picture software library for video consumers. Today, more than 250 major motion pictures have been produced using surround-sound technology. These movies retain their surround sound encoding when reproduced on videotape or when broadcast over the air or over cable. Therefore, as Ruggles points out, an available library of encoded video software already exists for consumers.

The Tate System surround-sound technology was described in detail in a paper presented by Ruggles and a colleague, Gary Reber, at Billboard's Fourth International Video Entertainment Music Conference, held last year in New York City. Ruggles and Reber have formed a television production company to further promote the idea of surround sound for consumer video. "The future of multi-channel surround sound video production is inevitable," said Ruggles. "Inventive and knowledgeable producers and pay television services are adopting the technology, knowing that the surround sound feature will benefit their product's marketability and exposure. The 1983 slate of motion picture production shows nearly 70 percent of the output to be produced in surround sound. In addition, a number of concerts and video music programs are incorporating surround sound into their productions. There will be more and more opportunities to ignite the imaginations of the millions of home entertainment enthusiasts who are eager to experience video music three-dimensionally in their homes."

I first heard this system demonstrated at last Winter's CES, in Las Vegas, as a combined effort by Jensen Home Electronics and Tate Audio. The system I listened to consisted of a Tate System decoder used with Jensen's AVS-1500 Audio+Video Receiver, AVS-3250 Video Monitor, AVS-5250 Speaker Systems (up front as well as in the rear) and Jensen's AVS-4400 Stereo Video recorder. Jensen's interest, of course, stemmed from their introduction of a truly integrated system of audio and video components, and they were looking for a dramatic way in



1

Acoustic foam "pop" and moisture filter.

2

Three-layer mesh grille resists denting for better element protection and appearance.

3

High-output moving-coil dynamic cardioid capsule.

4

Felt dust cover protects entire element.

5

All grille screens soldered (not glued) to brass retaining rings for maximum strength.

6

Two integral shock mounts to reduce cable and handling noise.

7

Precision-machined body of materials selected for perfect balance, shaped for comfort.

Aluminum  
Zinc Alloy

8

Rear acoustic phasing chambers for shaped low-end frequency response.

9

Armorized finish\* resists chipping.

10

Professional 3-pin balanced output connector connects directly to element with no heavy transformer.

# 10 reasons why you can't buy a better vocal microphone!

\*We have six more very colorful reasons to choose an ATM41: Red, White, Blue, Green, Black, and Gold! Each custom-color ATM41 comes with matching-color 25-foot cable, complete with connectors. Look as great as you sound!

There's one other reason why you'll put the ATM41 first in vocal microphones. Listen. Our sound blows them all away! Try it today at your Audio-Technica sound specialist.

audio-technica



AUDIO-TECHNICA U.S., INC., 1221 Commerce Dr., Stow, OH 44224 216/686-2600

Going wireless? Write to Nady Systems, 1145 65th St., Oakland, CA 94608 for details on the ATM41/Nady combination.

which to demonstrate their version of the much publicized "Audio/Video Marriage." Regardless of what motivated Jensen to team up with Tate Audio for this demonstration, the fact is that several positive factors seem to be coming together which bode well for video surround sound. For one thing, stereo sound on VCRs, until now anything but high quality, is in for a dramatic improvement, what with Beta HiFi being introduced this year by just about all producers of Beta-format VCRs. (The subject of Beta HiFi was covered in this column in the March, 1983 issue of *db*.) Given better quality audio in stereo, owners of home VCRs are more likely to feed the audio

channels of their video program sources to a high-quality stereo system as opposed to the mini-quality mono audio channels incorporated in their TV receivers. And, of course, the new high-quality audio that will be possible is not going to be confined to Beta for very long. Already, VHS versions of high-quality, hi-fi stereo sound have been demonstrated, and it's only a matter of time before the VHS camp of VCR producers will play "catch up," as they have done so often in the past.

#### EXTRA AUDIO CHANNELS ON THE AIR

The greatest impact of stereo sound for video has yet to be felt. That will

occur when stereo audio for TV broadcasting finally begins at some unpredictable time in the future. What many of the people interested in multi-channel TV and its progress through the committees and the FCC have perhaps overlooked is that we are talking about *multi-channel* TV, and not just *stereo* TV. The Japanese stereo TV system, in place and on the air for more than four years, makes provision for *either* stereo audio on TV or bilingual audio. When a non-Japanese motion picture, for example, is broadcast, Japanese viewers have the option of listening to the dubbed soundtrack, in their native language, or, at the touch of a switch, they can hear the original soundtrack in whatever language was used in the original film. However, when the multi-lingual option is employed by the broadcast station, there is no simultaneous provision for stereo sound. It's stereo or bilingual—not both.

Such is *not* the case with any of the systems currently being considered for American multi-channel TV audio. All of these systems make provision for what has been called the SAP channel. (That's not a comment on the intelligence or slow progress of the multi-channel committee; it stands for Secondary or Supplementary Audio Program.) A subcarrier, placed at five times the horizontal line repetition rate frequency, is incorporated in all three of the proposed transmission systems. It is, in fact, the only element that is common to all three systems. This subcarrier can be used to carry a monophonic audio channel over and above the stereo difference (L-R) audio channel carried by the lower-frequency subcarrier. Thus, a film or program broadcast in stereo could, at the same time, have an accompanying second soundtrack in a second language. Of course, that second language audio channel would be monophonic, but it would not supplant the stereo soundtracks carried for the primary viewers.

While no one has proposed it as yet, the SAP channel could also be used for transmitting a *discrete* form of an ambience or surround sound channel. TV receivers would then have to be constructed so that they could deliver a pair of outputs for the stereo audio channels plus the audio output for the SAP channel, all at the same time. The SAP audio would then be fed to a repositioned speaker and no special matrix decoder would be required under those circumstances.

If all of this sounds like a replay of the discrete-versus-matrix quadraphonic battle, perhaps it may yet turn out that way. On the other hand, let's hope that we learned from that non-productive experience and can approach and absorb all of these new technologies in a more orderly fashion this time! ■

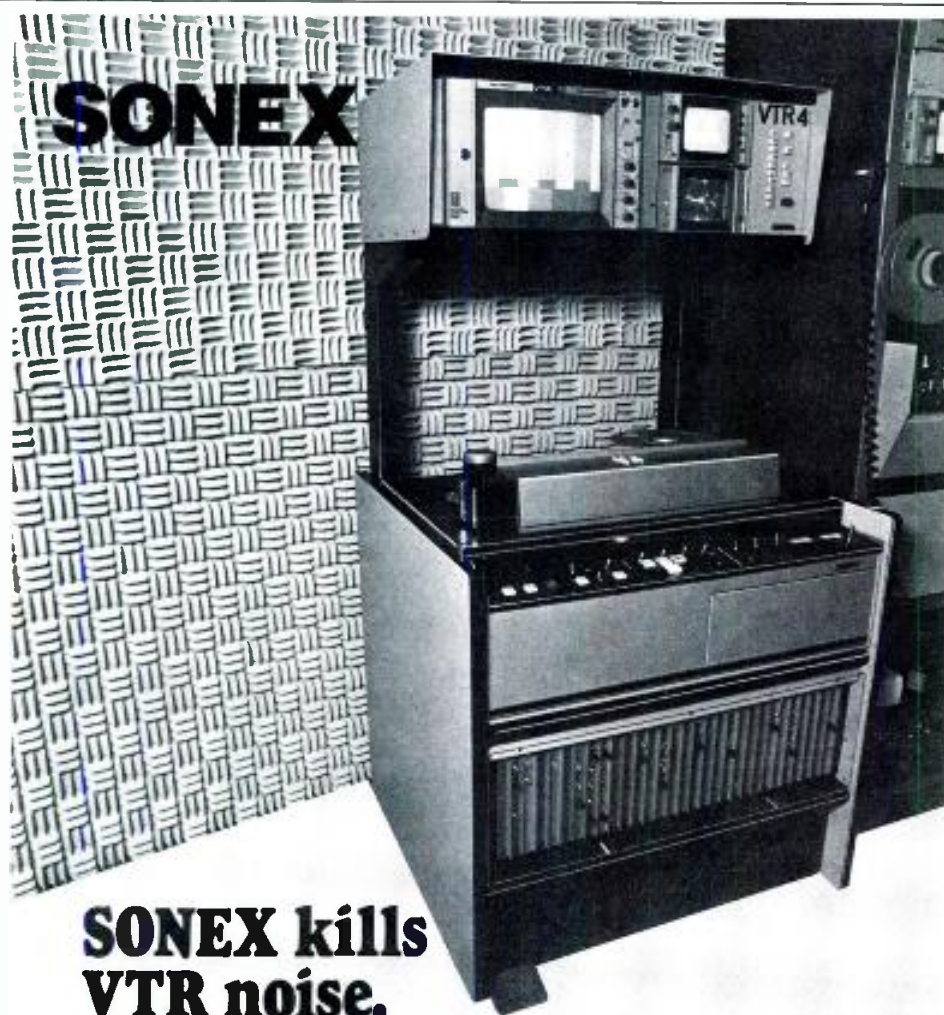

## SONEX kills VTR noise.

SONEX not only improves audio quality, inexpensively, but also quiets annoying background noise when you need to concentrate: noise from Quad VTR head blowers and head wheels; from mechanical tape transports; even from computer disk drives and fans. SONEX is the art of shaping sound...and the workhorse of killing noise.

Get the facts today. SONEX is manufactured by Illbruck/usa and distributed exclusively to the pro sound and A/V industries by Alpha Audio, 2049 W. Broad Street, Richmond, VA 23220.



**Alpha Audio**  
804/358-3852  
Acoustic Products  
for the Audio Industry

Circle 19 on Reader Service Card

# Brüel & Kjær Studio Microphones

The Next Logical Step



	Line Level Studio Microphone	High Intensity Studio Microphone
Balanced or single ended output. Line Level. No-compromise design. Powering via Type 2812. Two Channel Microphone Power Supply	Type 4003	Type 4004
Standard P 48 Phantom Power	Type 4006	Type 4007

Ask for our 16-page colour brochure for a thorough description of these new Brüel & Kjær studio products.



**Brüel & Kjær Instruments, Inc.**

185 Forest Street, Marlborough, Massachusetts 01752 · (617) 481-7000 · TWX: 498 0421

World Headquarters: Nærum, Denmark. Offices in 55 countries

Circle 20 on Reader Service Card

# Digital Audio

## Wires and Busing

• Several months ago, we discussed the issue of interconnections between digital audio devices. Now, let's extend the discussion to include interconnections between systems. Our problems are similar to those of the computer industry, and we will present the issues using examples from that field. We do this because the new problems of digital audio will be the current problems of the computer industry.

To begin our discussion, let us make a few interesting observations about engineering. Intellectually, engineering is the step-child of science. Science is concerned first with principles and inferential reasoning; engineering is only concerned about the applications of these principles. A good scientific education will provide the student with

the firm foundation that allows him to understand the basis of engineering; the general practicing engineer may find himself using rules of thumb without being able to trace the insights back to first principles.

This has very strong historic precedence. Civil and mechanical engineers almost always used handbooks as their prime source. Yet they lost sight of the basis for handbooks. This was not to say that they were good or bad engineers. If the bridge fell down, they were poor engineers, if it stayed up, they were good engineers.

With the advance of sophisticated electronics, engineering became more complex. The connection between science and engineering became stronger. The best engineering schools

no longer taught "engineering," rather, they taught science as if it were engineering. This was especially justified in the 1960s, with the introduction of semiconductor materials. This required knowledge of physics, mathematics, electromagnetic theory, etc. Moreover, the devices themselves had a short commercial life and an engineer was required to deal with new devices without new training. If engineering had remained handbook-oriented, the books would have appeared after the devices were already obsolete. In some sense, this is even more true with large-scale integration of analog devices. The engineer must deal with system issues as well as device issues. When we consider modern electronics (analog), we find that it can be traced to a large body of science that had been developed over two centuries.

### NO DIGITAL SCIENCE

Digital engineering is very different, since much of this technology has no science. All computers can be reduced to a collection of inverters and AND gates. Once having understood these

**think ambicon™**  
for a sound PA paging system



in factories,  
shopping malls, airports, lounges,  
mass transit systems, racetracks,  
you name it, you profit.

The Ambicon listens to ambient noise and automatically adjusts PA levels to compensate for variations. Ambicon, preferred in sound reinforcement by leading professionals.  
Increase profits and reliability. Call or write today for the complete story.

**ProTech™ Audio** (516) 584-5855  
Flowerfield Bldg #1  
St. James, N.Y. 11780

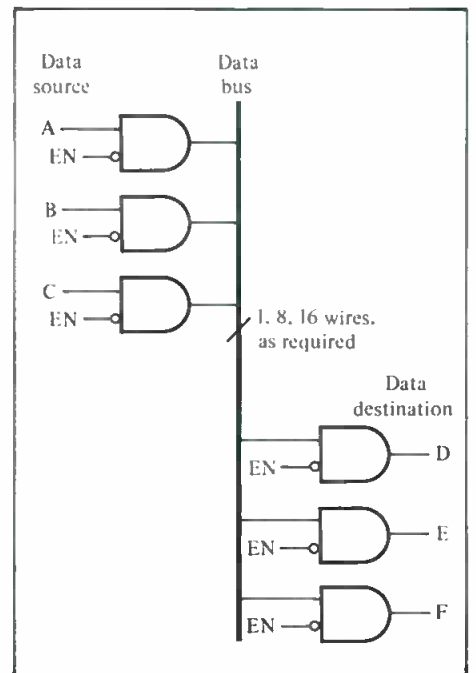

Figure 1. When one of the source ENABLE lines is low, that data source is sent to the bus. The data may be received at one or more destinations.

This Is  
Bob  
Ludwig.

He Is The  
Engineer  
Behind  
The  
Disk  
Mastering  
Of  
Over  
One Hundred  
Platinum  
And  
Gold Albums  
And A  
1981  
Grammy Award  
Winner.



Bob Ludwig Masters and Mixes Exclusively on Agfa Tape.



**MAGNETIC TAPE DIVISION**

The Mastering Choice of the Masters.

Mr. Ludwig accepts no compensation for his endorsement.

*As appearing in Billboard, db and other leading industry publications*

*Circle 22 on Reader Service Card*

two elements, one could understand a very large computer system or a computer network. On the face of the above assertion, the reader may think that I have lost my digital marbles. (See Dr. Blesser's column of July, 1980 for an explanation of digital marbles—Ed.)

The sophistication of the digital system comes not from the underlying science, which is trivial, but from the quantity of elements. We can understand 3 gates, but can we understand 1,000,000 gates? The answer is no. Digital engineering is thus limited by the human ability to hold in one's mind large networks. We can think about a digital system by mentally grouping elements and giving these groups names. This is somewhat analogous to understanding a city rather than understanding 1,000,000 individuals. Digital systems and software systems do not make errors in the same way that analog resistors change values or amplifiers add noise. All such digital systems are pure logic. The errors are in the human's limited ability to think about very large units.

Psychologists say that we can only remember seven elements at a given time. Larger collections are remembered by grouping the seven elements in a higher-level group. In some sense, this is just a naming convention.

However, we need such conventions in order to function. If an audio engineer picks up a digital computer journal or some software, it appears to be a wandering collection of abstractions and discussions without any real mathematics or structure. This observation is true because these two fields are relatively new. If the reader wishes to review the series on digital audio, he will find that there are really only a few ideas. The large quantity of words is needed because there are many ways of looking at these ideas. We can talk about gates and boolean notation; then we can talk about registers; then we can talk about signal processors; then we add the flexibility of programming; finally, multiple processors can be interconnected. This last subject needs to be discussed with its own language, even though we can trace it to the gate level.

### SYSTEM CONNECTIONS

One of the important current subjects in computer technology is that of interconnections. In audio, interconnection is a subject often reduced to the technician level of wiring a connector. In digital technology, it is the driving dilemma. At the device level, the complexity of interconnection of the gates on an integrated circuit results in 5 to 10 levels of metalization. In many

cases, it controls the design of the integrated circuit. Computers are needed just to help the designer create the IC. Once at the IC level, the drive to higher levels of integration results in the lack of enough I/O pins. The typical 14- or 16-pin TTL device is grossly inadequate for higher levels of integration. LSI multipliers and microprocessors have 40 to 60 pins. The size of the integrated circuit package is no longer controlled by the active circuit, but by the number of pins required and the heat to be radiated.

At the board level, it is no trivial task to connect many ICs with 50 pins. By spreading the design over many boards, we create the connector problems of connecting boards. This also brings difficulties with grounds and power supplies. Remember, a signal in the digital world may be on 16 or 32 individual wires. A system with 5 signals at 32 bits is over 150 wires. In high technology designs, a good engineer may actually start the design by considering the connectors! This would appear to be ridiculous. Yet these same engineers have learned the hard way that when they start with the circuits, they cannot be packaged and still function.

My earliest experience in this area was with digital reverberation. The first pre-production unit was made

# The unequaliser— from Klark-Teknik Research.



When you're engineering the sound system for a major auditorium, you need something special in fit-and-forget technology... the Klark-Teknik Research DN301. This Attenuating Graphic Equaliser has an unfair advantage over the competition: the micro-electronic reliability of active-circuit filters and thick-film technology earn it a 5-year parts warranty.

Designed for theatres, conference centres and multimedia installations, 30 precision faders give up to 15dB of cut at 1/3

octave ISO frequencies matching our DN60 Spectrum Analyser. The state-of-the-art DN301 has sweepable high and low pass filters and selectable low pass slope. 20dB overall gain restores signal gain to unity, and a built-in failsafe bypass ensures uninterrupted performances.

Specification includes:

Frequency response  $\pm 0.5$ dB  
20Hz-20kHz  
Distortion  $< 0.01\%$  @ 1kHz  
Equivalent input noise  $< -90$ dBm  
Output gain 0 to +20dB

### The Klark-Teknik promise — a bigger investment in the future with:

1. Greater R&D investment, with 12% of all company personnel directly involved in new product development.
2. Consistent attention to production economics for professional performance at 'breakthrough' prices.
3. Effective 'Reliability Control' during manufacture.



**KLARK TEKNIK**



British designed. British made

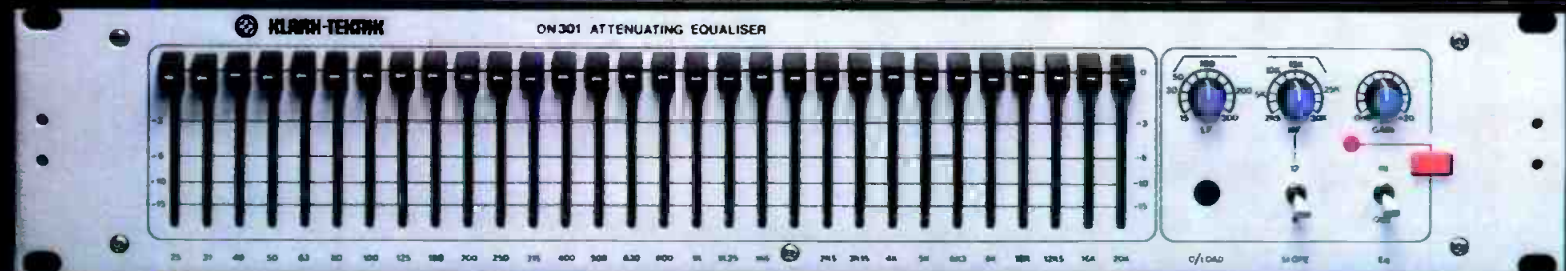

Manufactured by Klark-Teknik Research Limited  
Coppice Trading Estate, Kidderminster DY11 7UJ,  
England. Telephone: (0562) 741515 Telex: 339821

Klark-Teknik Electronics Inc.  
262a Eastern Parkway, Farmingdale,  
NY 11735, USA. Telephone: (516) 249-3660

Omnimedia Corporation Limited  
9653 Côte de Liesse/Dorval, Quebec H9P 1A3,  
Canada. Telephone: (514) 636 9971

Circle 23 on Reader Service Card

# Protect your investment with a cannon.

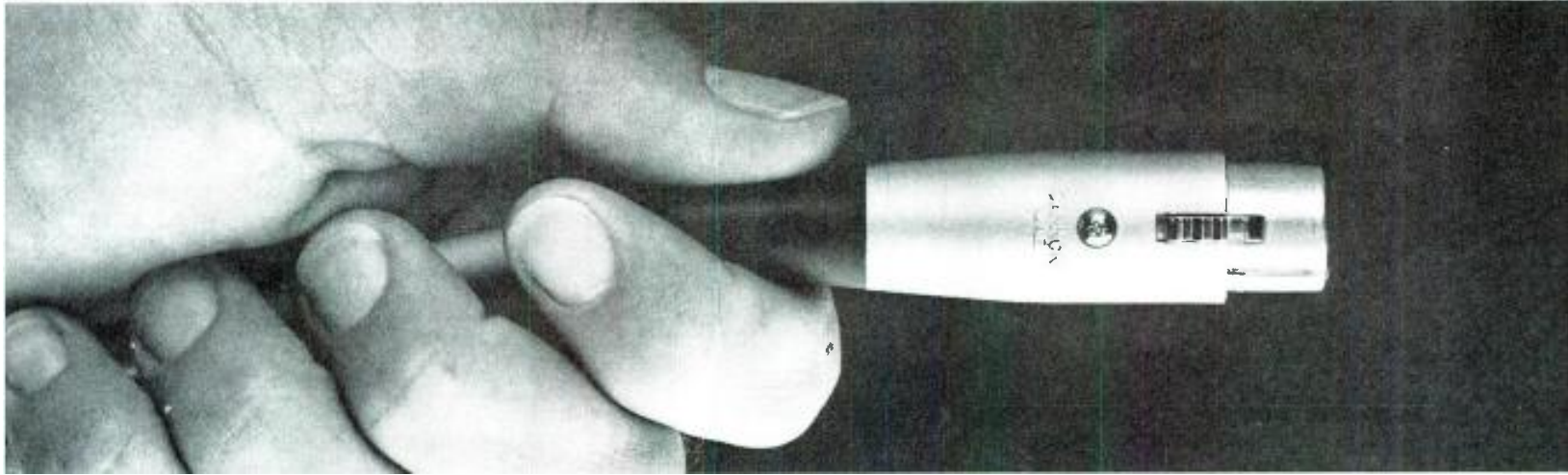

An audio connector by any other name is simply not an ITT Cannon audio connector. Which is precisely why so many audio engineers continue to specify Cannon® connectors for use with their audio equipment.

The XLR, the new XLB and XLA series are small, rugged, quick-disconnect connectors designed for use in audio/video and other low level circuit applications where reliability, quiet operation, elimination of mechanical interference and ease of use are necessary. Four different plug styles are available.

The EP connector is ideally suited to applications where extreme ruggedness and versatility are required. The new AP connector is a

## Audio Connectors from Cannon

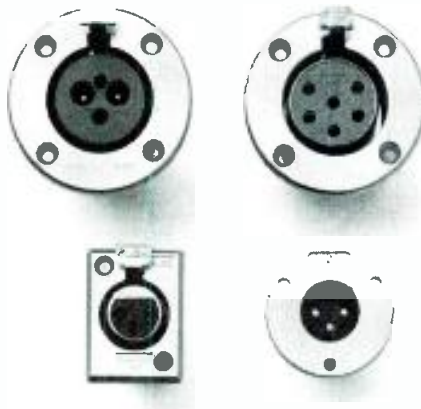

popular choice for heavy duty audio applications and is interchangeable and intermateable with the EP series. Both the EP and AP series may be used where as few as 3, or as many as 18, contacts are required.

The APLNE and AXLNE are specifically designed to handle the special needs of mains and other power supply applications.

For more information, please contact International Products Marketing Manager, ITT Cannon, a division of International Telephone and Telegraph Corporation, 10550 Talbert Avenue, Fountain Valley, CA 92708, (714) 964-7400.

## CANNON ITT

The Global Connection

with printed-circuit construction. It did not work because the design was started from an "analog" concept of what was important.

These same set of issues are driving the computer people crazy. A large bank with a large computer installation will find it pays the electrical contractor, who installs the wiring for the terminals, more than it pays the computer company for the hardware. The wiring on ships and airplanes also plays a role in terms of weight, reliability, and functionality. The largest copper deposits in the world are under the streets of NYC.

In terms of science, these issues are trivial; but in terms of large system functionality, they are central. We introduce this topic now because digital audio will go down the same path. When one had only a few digital pieces of equipment with analog interfaces, there was no issue. Now that we are talking about more than one or two types of equipment, we will begin to see the next set of issues. A studio with a patch panel for digital audio? How do we switch all those bits? Should we use serial data? Now consider a European broadcast house with multiple studios and transmitters. We will thus need to introduce new ways of thinking so that the audio industry does not box itself in the way the computer people have.

## THE BUS

To begin our discussion, let us consider a simple idea called The Bus. This has had many different meanings, but we will use it to mean an electrical wire, or wires, which allow communications between different sources (originator of the data) and different receivers (destination of the data). At the electrical level, we can describe such a system as being made up of tri-state logic. This logic family has three output states: high voltage, low voltage, and open circuit. The last mode allows us to place many different sources on the same wire as long as all but one are in the high-impedance state (open circuit). This is shown in FIGURE 1. The symbol we will use has an extra input called the ENABLE (EN).

Data is passed from the source to the bus via a tri-state buffer if the enable line is active (usually low). At a given time, only one source can be active, but one or more destinations can eat the data. Earlier, we called this time sharing. It is the same idea, but we need to think in a new set of words because the ideas become more complex.

The data bus can be either one wire or many wires. Usually we do not represent the additional wires on the diagram; this is understood. The figure could thus be an audio digital bus with 16 bits. This gives us an advantage over

point-to-point wiring since the bus can be sent throughout the system. A studio might have such a bus. If there is enough bandwidth in the bus, then the 16 bits could be sent sequentially as serial data. This reduces the wiring to a single wire. Imagine a full broadcast house with only one wire connecting every piece of equipment.

A little thought will show that the system works fine until the amount of traffic on the bus exceeds the bandwidth limit. This is the classical works-until-it-drops-dead mode of the digital system. We do not see any degradation on the bus until we exceed its limit. Then everything stops. In practical terms, a single-wire bus would require very large bandwidth. Good quality coax cable can get up to 10 Mbits/sec. Fiber optics offers still higher bandwidths. We can think of a time when 100 Mbits/sec is possible. Since 50 kHz audio at 16 bits/sample is 0.8 Mbits/sec, this system will allow upwards of 125 independent message connections simultaneously. If the bus system were 16 coaxes, one for each bit, then we could have 2000 channels on the bus. The advantages are clear-cut: the wiring is reduced in quantity and it becomes conceptually simple. However, we are left with the very difficult problem of control. Who controls when and how each piece of equipment gets

# TELEX

## AUDIOCOM

### For Communications Behind The Scene

AUDIOCOM. The closed circuit intercom for small, large, portable or fixed installations at concerts, stage productions, film or TV studios, stadiums or race tracks, industrial or public safety applications. AUDIOCOM belt packs or wall mount stations can be "daisy-chained" by the dozens over five miles

without degradation in signal quality or strength. AUDIOCOM interfaces with other sound systems and telephone circuits. AUDIOCOM includes headsets, mics, cables, switchboards, signalling kits, even battery packs for remote locations; the complete intercom system for communications behind the scene.

Quality products for the audio professional.



# TELEX

TELEX COMMUNICATIONS, INC

9600 Aldrich Ave So., Minneapolis MN 55420 U.S.A.

Europe: Le Bonaparte—Office 711, Centre Affaires Paris-Nord, 93153 Le Blanc-Mesnil, France.

Circle 25 on Reader Service Card



# EV PRO SOUND PRODUCTS

The competition in the professional sound field is pretty fierce. Ask anyone who has ever competed for a contract with EV Professional Sound Reinforcement products and they'll tell you that on a head-on, feature-for-feature, dollar-for-dollar basis, there's really no competition at all. Especially when EV's "Sound in Action" line is pitted against Altec and JBL. The truth is that many of their basic products are based on technologies that go back more than 50 years, to the first sound motion pictures. But designing sound products that are capable of filling a theater, concert hall, auditorium or stadium with high quality sound is a lot more demanding than reproducing the sound tracks of yesterday's talking pictures. In addition, the mechanical design and manufacturing processes of today and yesteryear are miles apart. (We ought to know, since EV's been making transducers since 1927).

For example, you've been hearing recently a lot about the sophisticated theories of A.N. Thiele and Dr. R. H. Small, as applied to low-frequency systems. What you probably *don't* know is that Electro-Voice applied these theories to product design ten years ago. EV *invented* the Constant Directivity™ horn. And we developed the first high-performance compression driver that can really "take it," and handle high-level inputs on a long-

term basis. In other words, EV examined what was wrong with yesterday's products and combined up-to-date design, manufacturing techniques and materials in a product line that provides better acoustic performance, as well as significant weight, size and cost advantages.

Want proof? EV Pro Sound products are making hearing as exciting as seeing in such diverse places as Disney World, the Pontiac Silverdome, Circus World, Sun City Sundome, Yankee Stadium and the E.J. Thomas Performing Arts Center at the

## FEATURE-FOR-FEATURE, IT'S TOUGH TO EQUAL EV PRO SOUND PRODUCTS. DOLLAR-FOR-DOLLAR, IT'S IMPOSSIBLE.

University of Akron, as well as countless numbers of churches, schools, theaters and clubs all over the country.

And to help you get to know more about our products and installations, there's a new catalogue that not only describes the complete

line of EV Pro Sound Reinforcement Products, but outlines EV's contributions to the field. There's also information on product performance testing and EV's standard-setting Engineering Data Sheets.

To put EV Pro Sound Action on your side, send for our new catalogue and get a good look at the EV position. Write to: Jim Long, Electro-Voice, Inc., 600 Cecil Street, Buchanan, MI 49107

a gulton company

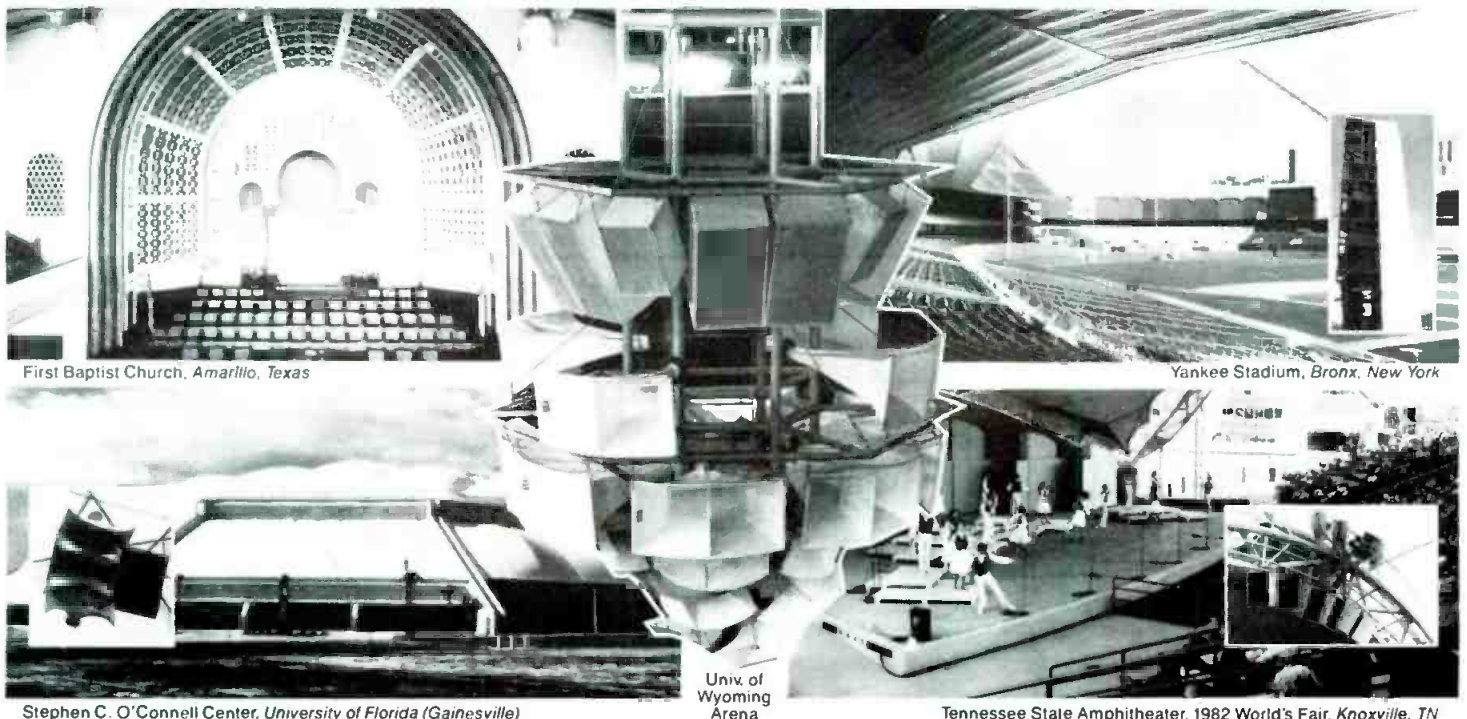

First Baptist Church, Amarillo, Texas

Yankee Stadium, Bronx, New York

Stephen C. O'Connell Center, University of Florida (Gainesville)

Univ. of Wyoming Arena

Tennessee State Amphitheater, 1982 World's Fair, Knoxville, TN

Exquisite Sound  
Modest Cost

**GRD**  
AMERICA'S MOST EXPERIENCED  
REAL TIME DUPLICATOR

HIGH QUALITY PRINTING  
AND ASSEMBLY

CUSTOM LOADED BLANK  
AGFA CASSETTES CHROME

(602) 252-0077  
P.O. BOX 13054  
PHX, AZ 85002  
Canada Division  
(403) 283-8068

THE RECORDERS Quartz-lock Auto Bias  
30-20,000 Hz, 0.25% w/rms, Dolby B -  
more than 67 dB S/N ratio

Circle 27 on Reader Service Card

on and off the bus? There is also a reliability issue in that one short on the bus kills the entire bus for everybody. This would suggest that we have an interface box so that equipment does not connect directly to the magic bus, but only through controlled electronics.

If you have drifted in the direction of becoming a computer hacker, you have heard of different kinds of buses. Digital Equipment Corporation computers will have a Q-bus or Uni-bus or Mass-bus. Motorola has a Versa-bus. The name in front of the word bus describes the specific characteristics of the bus. For example, some bus systems pass address data and signal data on the same set of wires. Others use separate wires. Each bus system has its own format. This means that the order of events will be unique to that bus.

This brings us to the subject of control and protocol. Suppose a device wishes to communicate with another device. How does that device get onto the bus? It cannot simply place data there because there may be somebody else already on the bus. It will have to wait. If the bus is free, a device could try to use it; but suppose two devices decided to try at the same time. Which one would have a higher priority? There is the issue of "handshake." If a device sends data to another device, how does it know that the other device is there to receive the data? Since some devices may take longer to accept data, should the timing cycle be based on the worst-case device, or should there be a completion signal indicating when the communications has been completed? This is the issue of synchronous or asynchronous. The former uses a fixed time cycle for all communications, the latter uses a handshake method.

All of these issues go under the category of protocol or format. Because each bus system uses a different set of definitions, they are not interchangeable. A device designed for a Uni-Bus will not work on a Q-bus without an interface system which changes the format.

These issues come from the computer world, yet they will all become relevant for digital audio as the studio becomes more complex. At this time, it is unclear how our industry will move. We are only at the very beginning and are just starting the process of definitions. It has taken us four years just to come to a nominal standard for sampling frequencies. The standards working groups are just starting the task of definitions and they have not even begun to think of a real bus system. The reader may thus think that this discussion is really irrelevant. However, we should begin to think in these terms even if the final system for digital audio is very simple. In the next article, we will begin to explore some of the issues of control and format. ■



setting new standards for excellence and value in Sound

**RENKUS-HEINZ PROFESSIONAL  
EXTENDED RANGE COMPRESSION DRIVER**



**Durable under conditions where others fail . . . designed to deliver unsurpassed sound quality . . .**

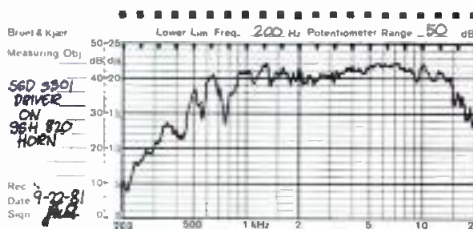

FREQUENCY RESPONSE 4' ON AXIS IN LISTENING ROOM

**ABSOLUTELY UNIQUE:** No other 2" throat driver offers such a combination of extended frequency range, power-handling capacity and natural sound clarity. Compact size and affordable price clinch the superiority of this driver—it's the ideal choice for all high-power 2-way speaker systems.

**ASK YOUR DEALER FOR A DEMO OR WRITE US**



**RENKUS-HEINZ, INC.** • DRIVERS • HORNS • SPEAKER SYSTEMS  
17851AB Sky Park Circle • Irvine CA 92714 • (714) 540-3154

Circle 29 on Reader Service Card

# Updated Recording Studio Handbook

A must for every working professional... student... audio enthusiast

Features latest state-of-the art technology of creative sound recording.

## 21 Fact-Filled Chapters

- I. The Basics
    1. The Decibel
    2. Sound
  - II. Transducers: Microphones and Loudspeakers
    3. Microphone Design
    4. Microphone Technique
    5. Loudspeakers
  - III. Signal Processing Devices
    6. Echo and Reverberation
    7. Equalizers
    8. Compressors, Limiters and Expanders
    9. Flanging and Phasing
  - IV. Magnetic Recording
    10. Tape and Tape Recorder Fundamentals
    11. Magnetic Recording Tape
    12. The Tape Recorder
  - V. Noise and Noise Reduction
    13. Tape Recorder Alignment
    14. Noise and Noise Reduction Principles
  15. Studio Noise Reduction Systems
  - VI. Recording Consoles
    16. The Modern Recording Studio Console
  - VII. Recording Techniques
    17. The Recording Session
    18. The Mixdown Session
- Three all-new Chapters**
19. The In-Line Recording Studio Console  
(The I/O Module The Basic In-line Recording Console. Signal flow details )
  20. An Introduction to Digital Audio  
(Digital Design Basics Digital Recording and Playback Error Detection and Correction Editing Digital Tapes )
  21. Time Code Implementation  
(The SMPTE Time Code Time-Code Structure Time-Code Hardware )



**\$39.50**

The *Recording Studio Handbook* is an indispensable guide with something in it for everybody. It covers the basics beautifully. It provides in-depth insight into common situations and problems encountered by the professional engineer. It offers clear, practical explanations on a proliferation of new devices. **And now it has been expanded with three all-new chapters . . . chapters on the in-line recording studio console, digital audio and time code implementation.**

### Sixth printing of industry's "first" complete handbook

The *Recording Studio Handbook* has been so widely read that we've had to go into a sixth printing to keep up with demand (over 30,000 copies now in print). Because it contains a wealth of data on every major facet of recording technology, it is invaluable for anyone interested in the current state of the recording art. (It has been selected as a textbook by several universities for their audio training program.)

### Highly Acclaimed

Naturally, we love our book. But don't take our word for it. Here's what others have to say:

"John Woram has filled a gaping hole in the audio literature. This is a very fine book. I recommend it highly." *High Fidelity*

"A very useful guide for anyone seriously concerned with the magnetic recording of sound." *Journal of the Audio Engineering Society*

### 15-Day Money-Back Guarantee

When you order *The Recording Studio Handbook* there's absolutely no risk involved. Check it out for 15 days. If you decide it doesn't measure up to your expectations, simply send it back and we'll gladly refund your money.

### Easy to Order

You can enclose a check with your order or charge it to Master Charge or BankAmericard/Visa. Use the coupon below to order your copies of the new updated *Recording Studio Handbook* (\$39.50).

### ELAR PUBLISHING COMPANY, INC.

1120 Old Country Road, Plainview, N.Y. 11803

Yes! Please send \_\_\_\_\_ copies of THE RECORDING STUDIO HANDBOOK. \$39.50. On 15-day approval.

Name \_\_\_\_\_

Address \_\_\_\_\_

City/State/Zip \_\_\_\_\_

Total payment enclosed \$ \_\_\_\_\_  
(In N.Y.S. add appropriate sales tax)

Please charge my  Master Charge  
 BankAmericard/Visa

Account # \_\_\_\_\_ Exp. date \_\_\_\_\_

Signature \_\_\_\_\_

(changes not valid unless signed)

Outside U.S.A. add \$2.00 for postage.

Checks must be in U.S. funds drawn on a U.S. bank.

# Theory & Practice

## A Floppy Tutorial

• Happily, the audio industry is borrowing more and more expertise from the computer industry. This coattail effect has brought tremendous technical sophistication to audio hardware and similarly benefitted the quality of sound recordings. Without those coattails, our industry would be becalmed in the Horse Latitudes without a paddle; with all due respect to professional audio companies, I don't think you could have afforded the R & D cost involved. Happily, the computer industry could afford it, and has made almost inconceivable advances. I'm not sure who dreams up these kinds of analogies, but it has been estimated that if the automotive industry had advanced at the same rate as the computer industry, a Rolls-Royce would cost \$2, get three million miles to the gallon, and six of them would fit into the period at the end of this sentence. I suppose, similarly, if the audio industry had kept pace, I could have the entire Sony Corporation housed in my garage, and still have room for both of my motorcycles.

Well, we haven't achieved such results, and frankly I wouldn't pay even 2 bucks for a Rolls if I needed an electron microscope to change the oil, but the coattail effect has served us well. Digital technology has irrevocably changed the course of audio. Signal transducing, mixing, processing, and storage via digital techniques are proving to be very cost-effective, and capable of yielding enhanced sound quality. The trend is clear, and in my opinion, signalled its unmistakable intent when, finally showing up in the studio, was the supreme symbol of the computer hacker—the floppy disk.

### THE FLOPPY DISK ERA

I suppose Neve was first, with its disk-based NECAM console automation system, and other automation and prototype digital mixers followed suit. Other sophisticated signal processing systems such as the Digital Music Systems processor, and signal generating systems such as the Synclavier, use floppies within the context of a studio computer. I suspect that we've just seen the beginning, and as the digital computer finds its new home in the recording studio, more and more

audio related data, perhaps even the signal data itself, will spin on floppies. Have you prepared yourself, are you ready for it, have you learned the care and feeding of floppies? Read on...

Floppy disk technology was developed by IBM in the middle 1960s as an evolved alternative to Hollerith punched cards. The need to repunch a card every time the data stored on it was changed necessitated a reusable medium that could be written into, erased, and written again. In their original application, floppies were used to store micro-code for peripheral controllers, as well

a center spindle hole 1.5 inches in diameter. For soft-sectored disks, a single 0.1 inch diameter index hole 1.5 inches from the center of the disk is used to indicate the start of a sector, and synchronize data. The recording surface is a 100 micro-inch thick layer of magnetic oxide, on which saturation recording is accomplished. A written track is 0.012 inches wide, track spacing is 48/inch, and the total number of tracks is 77. With standard code, the innermost track has a bit density of 3.268 bits/inch, the outermost track has a bit density of 1.836 bits/inch.

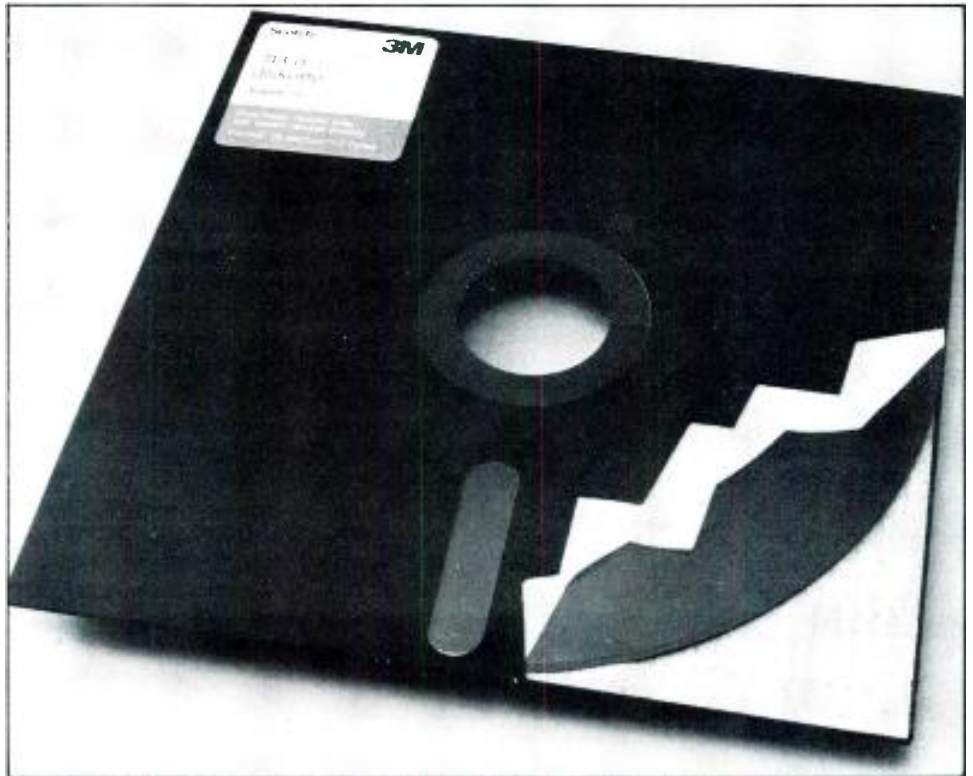

*Cutaway view of diskette, showing jacket, liner and media.*

as diagnostic and emulator programs. In 1973, IBM introduced the 3740 keypunch data entry system in which one floppy stored the equivalent of 3,000 cards; the floppy era had begun.

A standard floppy disk might be considered as a hybrid between a 45 rpm record and magnetic tape. The disk is made of a 0.003 inch thick mylar substrate 7.88 inches in diameter with

and the entire surface has a capacity of 400,000 unformatted bytes of 8 bits. A storage capacity of over 3 million bytes per surface could be attained with alternate formatting systems. With a standard rotational speed of 360 rpm, a transfer rate of 250,000 bits/second is obtained, with an average access time of 176 milliseconds.

The disk is enclosed in a protective

plastic sleeve with soft, low friction liners to wipe the surface clean and eliminate static charge. The standard sleeve has three openings to allow access for the drive spindle, index photo-sensor, and read/write head. The head access slot covers the useable width of the disk and permits the head to step across the rotating disk to access any of the 77 tracks. There is a slot in both sides of the sleeve—one for the head, and another for an oppositely placed pressure pad. On double-sided drives, the opposite head serves as a pressure pad. Generally, the head contacts the disk only during read/write operations. Track life on a disk is on the order of 3 to 5 million revolutions or a greasy fingerprint, whichever comes first. A write-protect slot can be used to disable the drive's writing electronics and thus prevent writing onto a disk. Hard-sectored disks use 32 holes in addition to the index hole to directly mark rotational position; this addressing space needed on soft-sectored disks can be used for data; the number of data sectors on a hard-sectored disk can be increased from typically 26 to 32 per track. In addition to the 8-inch format, disks are also made in 5¼ and 3½ inch sizes. Other variations include double-sided and double-density formats. Hackers on a budget have long recognized the trick of punching another index access hole in the sleeve (not the disk!), and using both sides of a disk in a single-sided drive. Maverick disk operating systems have also been written which greatly increase the data density on the disk surface to triple density and beyond.

#### ADDRESSING INFORMATION ON FLOPPY DISK

Although floppy disks and magnetic tape are both magnetic storage media, they differ fundamentally in the way the information is addressed. Tape is a serial-accessed method in which data is recorded, and must later be located and read, by winding through the entire length of the tape. A floppy disk, like a phonograph record, is a random-access medium in which any piece of information may be located and read almost immediately. A disk accomplishes this trick through a careful formatting which supplies addressing for the stored data. As previously mentioned, an 8-inch disk contains 77 circular tracks. Each track consists of a series of sectors—each sector is a fixed location on a track and is addressable. Only one physical record can be written into, or read from, a sector. The data tracks are written as a series of sectors, and each sector further contains a sequence of fields; for example, at the beginning of each sector, its unique address is written. When the host computer passes a sector address to the floppy

disk controller, the drive head is moved to the proper track, and data transfer occurs when the proper sector address passes under the head.

Specifically, each sector consists of sync fields, an ID field, ID gap, data fields, redundancy checks, and data gap. Sync field and ID mark bytes will signal the beginning of a sector. The ID field which follows completely defines the sector with a unique address defined by the sector's physical placement on the disk. The ID sector addressing scheme contains eight hexadecimal digits—two each for cylinder number, head number, record number, and record length. The cylinder number is used to find the correct track on either side of a disk. For

example, track number 7 on either side of a disk defines cylinder number 7; once the head assembly is stepped to that physical place, it is efficient to use the tracks on both sides of the disk. Thus, oppositely positioned tracks are referenced by a single cylinder number rather than as different tracks. The concept is also used for single-sided disks. Cylinder 0 is the index cylinder and is reserved for data describing the disk and its contents. Cylinders 75 and 76 are reserved for use as replacement cylinders by defective cylinders. Thus, cylinders 1 through 74 can be used for storing user data. The head number in the sector address identifies which head, on which disk side, is used to access the data. Therefore, single-sided

## 225 W per Channel In Only Three Rack Spaces. The UREI 6300.

And, 750 watts in mono! That makes the UREI 6300 the most powerful amplifier of its class. More important than its compact size is its clean sound... in fact, you could compare the sound to the most esoteric *audiophile* amplifier. But, the 6300 is built to give the same performance day after day, night after night.

The 6300 was designed for the rigors of the working sound professional. The rugged chassis and extruded front panel make the 6300 extremely roadable and the continuously variable fan helps assure reliable operation. A totally modular chassis assures fast, easy service in case of difficulty with this rugged and reliable amplifier.

Electronically, the 6300 is also built to UREI quality standards, to provide extremely clean and transparent sound. Hear the UREI 6300 at your professional sound dealer today, or contact UREI for more information.

**UREI**

From One Pro to Another

United Recording Electronics Industries  
a URC Company  
8460 San Fernando Road  
Sun Valley California 91352  
(213) 767-1000 Telex 65-1389 UREI SNVY  
Canada E S Gould Marketing, Montreal

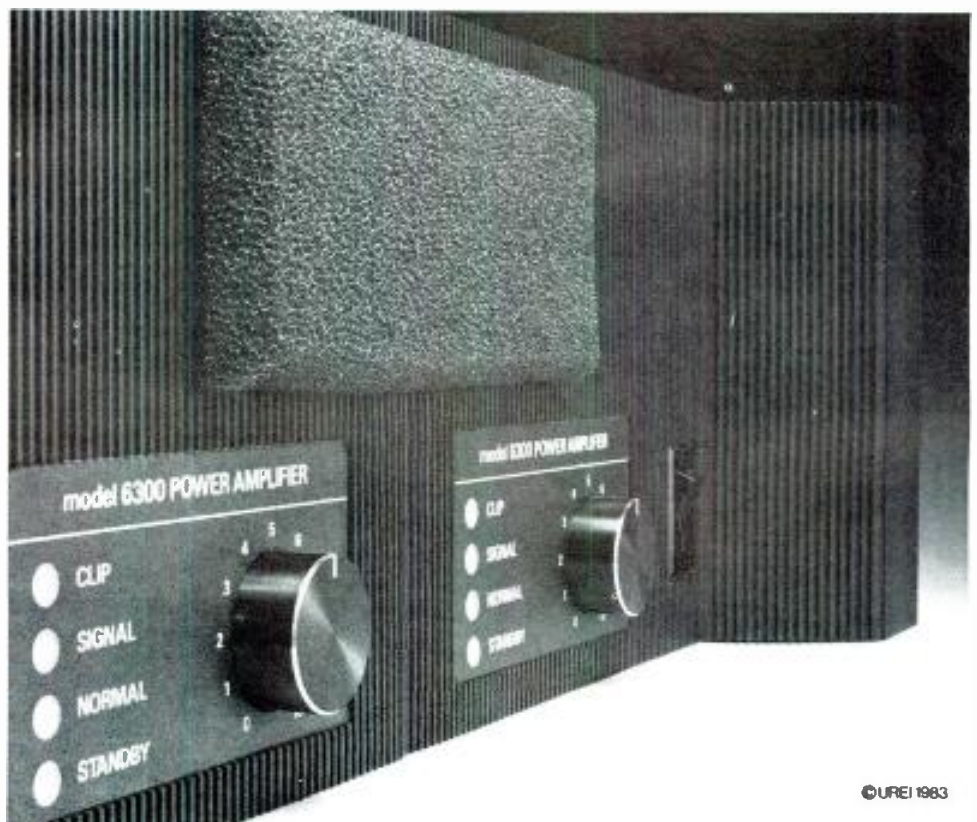

Introducing

## THE SOUND EFFECTS LIBRARY FOR PROFESSIONALS

- 3000 STEREO EFFECTS
- 300 PAGE CATALOGUE
- 30 HOURS OF SOUNDS
- 125 TAPES at 7 1/2 or 15ips
- PRICED FROM \$1500.00

"Some of our Clients."

- ABC
- NBC
- Walt Disney Prod.
- Universal Recording



86 McGill Street,  
Toronto, Ontario  
Canada M5B 1H2  
(416) 977-0512

Circle 30 on Reader Service Card



## EL-15 Woofer

- 25-5000 Hz
- 200 Watts
- 100 dB M/W
- 4" Voice Coil

# EMILAR

For complete information:

(714) 632-8500

(800) 854-7181

**EMILAR CORPORATION**

1365 N. McCan St.,  
Anaheim, CA 92806

Circle 32 on Reader Service Card

and double-sided disks are intrinsically identified. The record number identifies the numerically ordered sectors arranged around the track. The record length specifies the number of bytes per sector, and thus details the disk format. Cyclic redundancy check bytes conclude the ID record. These check bytes are generated during a write operation and are used during a read operation to verify that data is read correctly.

ever, newer IBM formats permit 256, 512, or 1024 bytes per sector; this information is duly noted in the preceding ID record. Another cyclic redundancy check word follows the data record to insure proper read operation. A 33 byte gap allows for the head's reverse write-to-read transition. The next sector's mark gap follows immediately. The index hole in the disk signals the first sector of a track, and special index gaps are placed in the

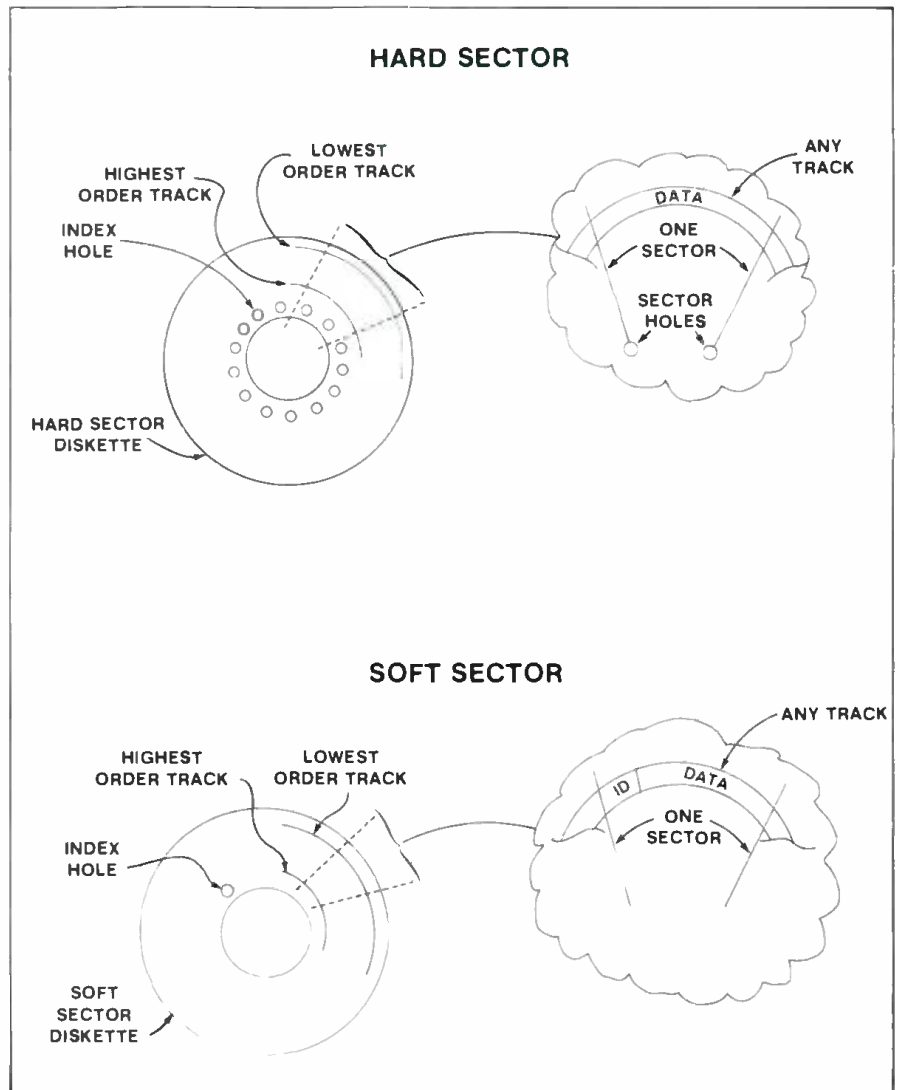

*A soft-sectored diskette is one whose sector boundaries are determined by specific bit patterns recorded on the media; the hard-sectored diskette boundaries are determined by holes punched in the media.*

An ID gap follows the ID record; this 17-byte-long space allows the head to switch from read to write without disturbing the immutable ID record. A second sync field and data-mark bytes signal the beginning of the data field record, the area where the user's data is actually stored. IBM's original format called for 128 bytes per sector. How-

track. Because of the varying track velocity, and need for constant data rate, inner tracks have a greater density; the head's write current is reduced for tracks 44 through 77 by jumpering the drive appropriately.

Most of the intelligence associated with disk operation comes from the controller electronics which supervise

formatting, drive control, and I/O between the computer. Controllers formerly consisted of very simple hardware which was limited to format decoding, leaving the rest of the disk's operation in the hands of the host computer's software subroutines. The price for such simplicity is paid as overhead: for example, if files to be stored are longer than one sector, a file management program must be called to determine how to best fit the data onto the disk, and then reassemble it later. The file manager in turn calls upon a device handler to properly actuate the drive. Meanwhile, hundreds of precious milliseconds have slipped by, and the result is slow disk access and an inefficiently operating host computer. Today the trend is toward intelligent floppy controllers, essentially dedicated high speed microprocessors, which attach to the host's Direct Memory Access bus and need only a few macroinstructions to accomplish their own execution of floppy accessing. One of my favorites is the Western Digital FD 1797-02 floppy-disk controller chip. It is IBM 3740 single density (FM) and System 34 double density (MFM) compatible, has automatic track seek with verification, selectable 128 byte or variable length

sector, double side select, DMA transfer, and mini-floppy compatibility. Chips such as this have helped accomplish the \$2 Rolls-Royce price reduction in floppy disk systems, and brought them into the small computer mainstream.

#### FLOPPY DO'S AND DON'TS

Over the past ten years, floppy disks have achieved remarkable acceptance in the industry, and proved themselves as a cost-effective method of mass storage. They face stiff competition from hard disks and forthcoming laser storage techniques, but the floppy should remain the storage mainstay for years to come. Perhaps more than any other factor, that popularity may be attributed to their reliability—perhaps no other storage medium has so compactly held so much data so dependably. However, as the floppy disk enters the ultimate hostile environment—the rock 'n roll recording studio—no discussion on floppies would be complete without a list of some of the things widely considered to be cruel to floppies

Bending, folding, or mutilating.

Using rubber bands and paper clips on them.

Touching the exposed disk sur-

face with your disgusting human fingerprints.

Smoking, eating, or drinking to excess around them.

Exposing them to unreasonable heat or sunlight.

Taunting them with magnets.

Putting them under too much weight or stuffing them into their boxes.

Leaving them in the drives when powering down.

Writing on their labels with ball point pens (the tracing pressure can blow them). If you use a pencil, don't ever erase it—the eraser residue could blow a disk. (The best bet is to use a felt tip pen.)

If these precautions are carefully observed, a disk will never fail—unless, of course, it holds a program which you've just spent all night writing. In such an emergency, when a disk fails to read properly, some users attempt to save the disk by trying all sorts of elaborate data resuscitation programs. However, you might want to try my method for dealing with a bad disk—violate the disk in all of the ways listed above and staple it to a bulletin board as a warning to the other floppies. ■

# 10,500 REASONS\$



## to buy a Soundcraft 800B

10,500 reasons to buy or spec this Soundcraft? You bet! You save \$10,500 over Yamaha's comparable PM2000 listed at \$33,000\*... with Soundcraft's 800B affordably priced at only \$22,500.\* It's the most cost-effective and versatile live performance mixing system on the market. But keep adding reasons! You even get these distinct advantages:

- 3 frame sizes
- 8 bus with stereo re-mix output
- 8x8 matrix output with EQ
- Effects return output option
- Full power supply status indication
- Compact: 5½-ft long, under 200-lbs

Call your nearest Soundcraft Dealer today or mail coupon for complete information.

\*Manufacturer's Suggested Retail Price, 1/13/83.

Soundcraft Electronics, Inc.  
1517 20th Street  
Santa Monica, CA 90404 (213) 328-2595

Please have nearest Soundcraft Dealer call me.  
 Please send me 800B brochure.

Name \_\_\_\_\_ Tel. (\_\_\_\_) \_\_\_\_\_  
Company \_\_\_\_\_  
Address \_\_\_\_\_  
City \_\_\_\_\_ State/Zip \_\_\_\_\_

# Sound Reinforcement

## Equalization in Sound Reinforcement Systems, Part I

• Current practice in sound reinforcement system equalization had its beginning in the work of Paul Boner (1, 2) during the early sixties. While his work is closely associated with the use of narrow-band filters for feedback control, he was the first to make use of broadband shaping of the system's response prior to applying the narrow-band devices. Under the name "Acoustavoice," Altec pursued the notion of

maximum acoustical gain. We will discuss both of these functions.

### BROADBAND EQUALIZATION

Normal equalization of a sound system is done as shown in FIGURE 1. A pink noise generator (PNG) is placed at the system's input, and a test microphone (RTA), is located midway in the house. Some practitioners take readings at

system. In the test microphone's usual position, it is responding to direct as well as reflected sound, and the readings on the RTA pretty much represent the integration of all sound in the room. If the loudspeaker array is of the constant-coverage type, as is popular today, then smoothing of the power response will also result in smooth direct-field response. This is shown in FIGURE 3A.

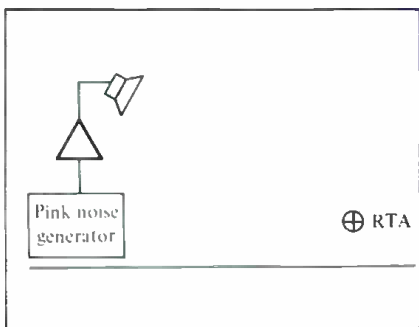

Figure 1. Equalizing a Sound Reinforcement System.

combining-type, one-third octave dip filters, combining both broadband response shaping and control of feed-

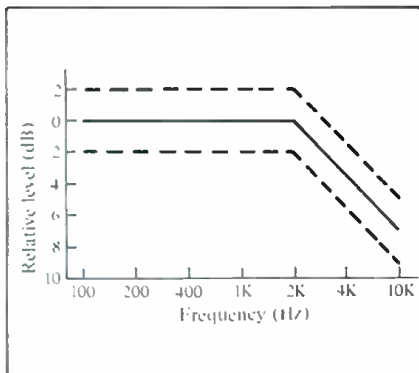

Figure 2. Boner's Preferred Curve for Equalizing Sound Reinforcement Systems.

back in a single set of filters.

It is best to view the functions of broadbanding the system's response and the control of feedback as two separate functions, realizing that both of them profoundly affect the system's

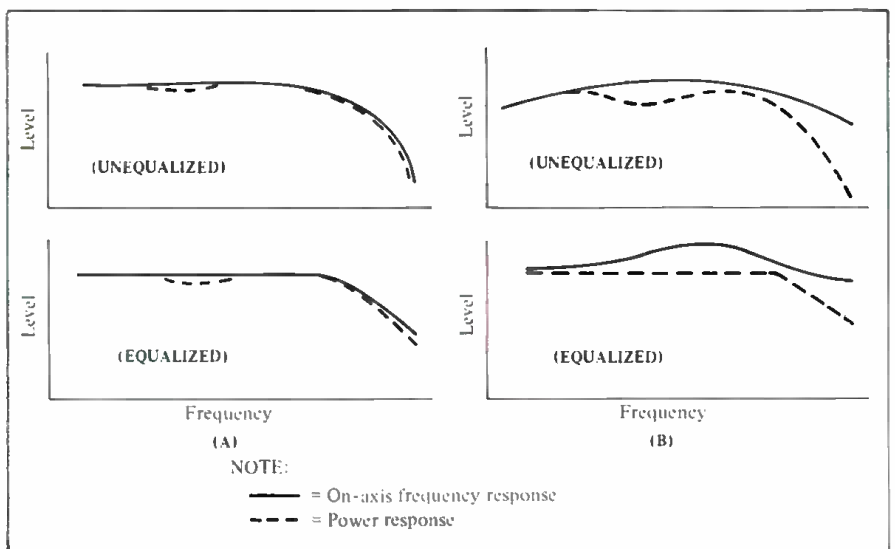

Figure 3. Equalization of a Constant-coverage System (A) and of an Older type System (B).

several positions in the house and average them for best response. Early in the development of system equalization, Boner established the curve shown in FIGURE 2 as the ideal for speech reinforcement.

What we are actually equalizing is the power response of the loudspeaker

Now, let's see what happens when we equalize an older type system, as shown at FIGURE 3B. Here, the high-frequency horn has a polar pattern which narrows with rising frequency. When the power response is shaped according to the preferred Boner curve, then the on-axis direct field will be nearly flat.

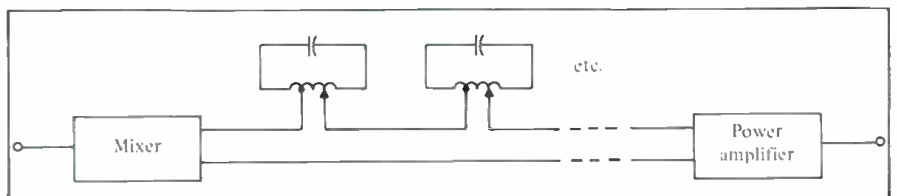

Figure 4. Implementation of Narrow-band Passive Filters.



While this may not be a bad thing, it is obviously quite different from the situation shown in 3A.

Which is correct? Current equalization practice developed using the old-style componentry, and it is possible that the Boner curve is a roundabout way of arriving at flat on-axis response out in the house. If this is so, then the curve shown in FIGURE 1 is due for re-examination. On the other hand, if the Boner criterion is subjectively related to overall sound coloration, which is normally provided by the integrated reverberant field, then current practice is equally applicable to both the old and the new hardware. This is probably the case in most sound reinforcement installations; however, there are indications that it may not be so in the recording studio. But that is the subject of next month's column.

### NARROW BAND EQUALIZATION

After the system has been broadbanded, narrow-band filters may be placed in the link between mixer and amplifier, as shown in FIGURE 4. The characteristics of the White 3900 series narrow-band filters are shown on an expanded frequency scale in FIGURE 5. The 800 Hz filter shown here is typical of a set of 168 different filters covering the range from 100 to 1200 Hz.

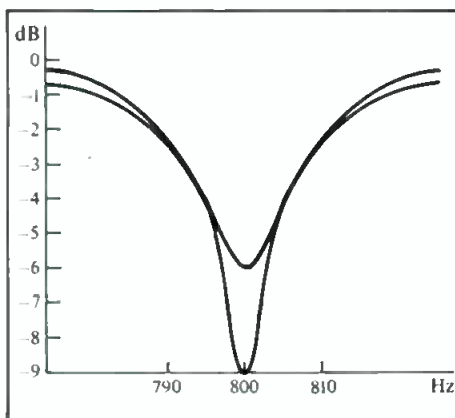

Figure 5. Characteristics of the White 3900 series Narrow-band Filters.

The procedure is to use only the main podium microphone and raise the gain slowly until the system begins to feed back. The feedback frequency is measured, and the closest filter from the set of 168 is plugged in, using the 6- or 9-dB setting as required to stop the oscillation. Then the gain is increased again, and the appropriate filter plugged in when feedback is encountered.

This process cannot go on indefinitely. As a rule, most systems are best left with no more than four or five system "ring modes" notched out, and the gain increase under these conditions will usually be about 4 or 5 dB. It should be obvious that the equalization procedure just outlined may be good only for one particular microphone in one particular

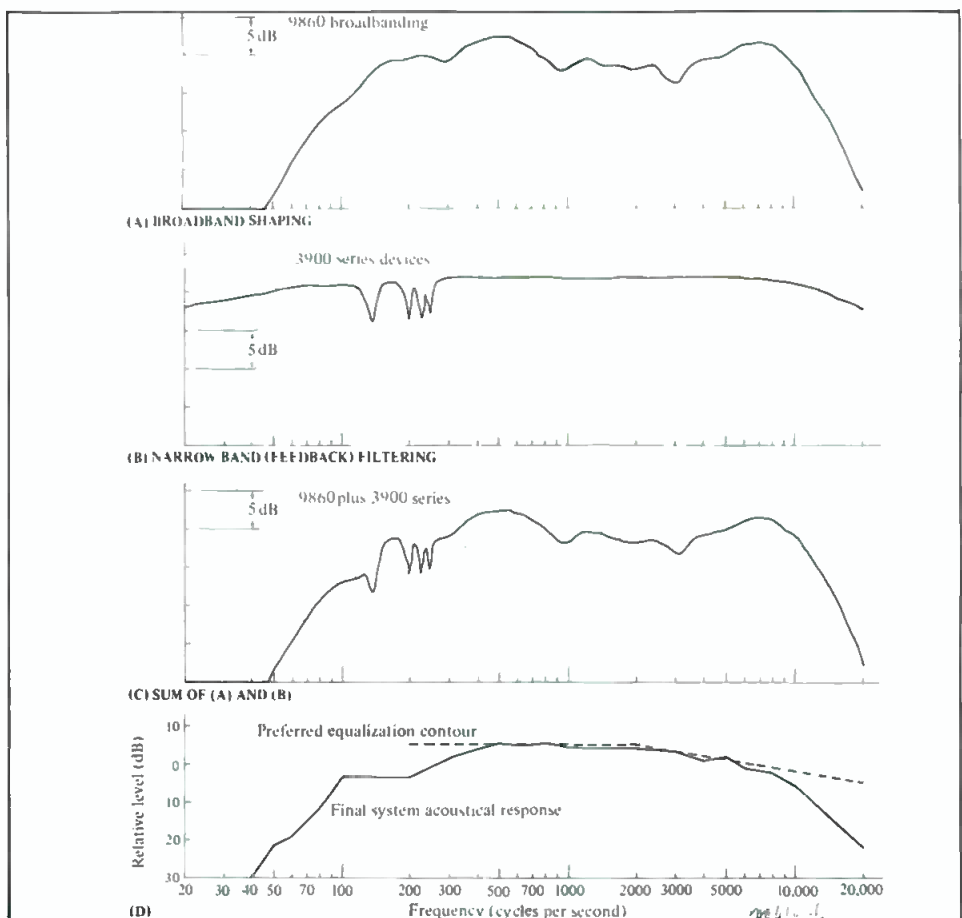

Figure 6. Combining Broad and Narrow-band Filters. (A) Broadband shaping, (B) Narrow-band (feedback) filtering, (C) the sum of (A) and (B), and (D) the final system acoustical response (solid line). The preferred equalization contour is shown by the dashed line.

location. While the microphone can probably be changed without problems, the location of the microphone is critical to the particular feedback pattern observed.

Herein lies the difficulty and complexity of narrow-band equalization, and it is easy to see why it should be left to those who are skilled in its use.

FIGURE 6 shows how both kinds of equalization work together. In this case, an Altec 9860 third-octave equalizer was used in conjunction with a set of the White 3900 series. The system was broadbanded with pink noise, and then the first four ring modes were notched out. In most sound reinforcement systems, ring modes will be observed in the range between 100 and 1250 Hz. The farther the microphone is from the loudspeaker system, the lower in frequency these will usually be. This system, a fairly large two-way theater system, was located in a good-size ballroom, and the use of four narrow-band filters resulted in about 4 dB additional gain.

The overall system response was shaped as shown in FIGURE 6D. The low end roll-off represents additional response shaping with the one-third octave set to minimize feedback further and to arrive at a desired subjective response for its speech-only use. ■

## LOW LEVEL INPUT TRANSFORMERS

### For Microphones/Transducers

Control and Instrument Amplifier Applications  
Excellent magnetic ESS shielding  
Response 30-20 KHz +1db  
Turns Ratio 1:1 thru 1:20



Single Threaded Stud Mounting

Equivalent to Imported European Studio Grade Transformers

MICROTRAN S101-SP



COMPLETE SPECIFICATIONS AND PRICE SHEET AVAILABLE

Complete Catalog line of

**AUDIO-POWER COMMERCIAL-MIL TRANSFORMERS**

IMMEDIATE DELIVERY FROM DISTRIBUTORS

F2



IMMEDIATE DELIVERY FROM DISTRIBUTORS

**MICROTRAN COMPANY, INC.**

145 E. Mineola Ave., Box 236, Valley Stream, N.Y. 11582

Circle 33 on Reader Service Card

## Convention Speculation

**A**S MOST convention-watchers know, this is the year in which the Audio Engineering Society cut back to a single convention in the US, alternating between New York and California. When the decision to do so was announced last year, it played to mixed reviews. Some thought the move was just about the greatest technological breakthrough since the lp, while others were not so sure. Needless to say, there was lots of before-the-fact speculation about what would be the impact of a single gathering per year.

Well, it's now after-the-fact. May has come and gone, without the traditional Los Angeles convention. Of course, convention freaks had plenty of other fare from which to choose. What with AES Europe, CES, NAB, NAMM, NRB, NRBA, SMPTE, and a computer convention going on just about everywhere you could look, people who love to get lost in a crowd had an alphabet soup of opportunities to do so, and one less AES hardly made a difference.

Or did it? For we've recently heard reports that the AES may be going back to its old ways. At the 1983 convention in Eindhoven, the board of governors voted almost unanimously (8-2) to return to three conventions a year—two here in the colonies and one in Europe.

As before, opinions are divided. Some are delighted, others aren't. The delighted ones include many non-exhibitors who don't get to travel across the country much, and depend on going to a local show to see what's new. Among the not-so-delighted are some who do get to travel across the country a lot, and look forward to not going to another show, if only to save a little shoe leather, and possibly get some business done.

On the other hand, conventions are business too. It's just not true that the word convention is a synonym for party-time. In fact, it's not even close. (Well, not all the time.) Especially for the smaller company, convention attendance is an important part of staying in business. It's a top-notch way of showing off your product to a lot of people in a comparatively short time. For some, it can be almost a religious experience—you know, like Christmas time at F. A. O. Schwartz. (Just look at all those happy kids drooling over your latest digital doohickey.)

For some, the lack of a May show hurt sales. Some compensated by expanding their exhibit at the Las Vegas NAB, or possibly by attending for the first time. And some found it a refreshingly rewarding experience (especially those with order pads).

As a matter of fact, the broadcasters' increasing interest in quality sound is making the NAB convention more and more important to the audio industry. With recording sales still a little soft, at least a few manufacturers are turning their attention towards the broadcaster, who seems to have money to spend. In fact, next year it will be interesting to see if the AES can regain some lost momentum with a reintroduced May convention coming almost on the heels of the NAB's April spectacular.

Of course, a different crowd shows up at NAB (not counting the regulars, who show up for everything). There's a lot more corporate support wandering around the aisles, whereas at AES it's more apt to be the guy from the studio downtown who took the afternoon off. The NAB'er may have flown in on the company credit card, while at AES the crowd showed up in a car pool.

So, who will show up at the next few AES conventions? Will all the manufacturers return? What about the attendees? And what about four AES conventions in 1985?

It could happen. At last, there is to be a Japanese convention (May, 1985 is the tentative date). Of course, Europe expects to have its own 1985 convention. And now there will be two US shows again. Does that add up to four or doesn't it? Or, will the Society go back to one US show that year?

If so, that will make it two overseas shows and one here. Will that become the norm for 1986 and beyond? We shall have the answers to these and other questions later (just as soon as someone tells us what they are).

In the meantime, the schedule is beginning to look like this: September, 1983 in New York; March, 1984 in Paris; May, 1984 in Los Angeles, and so on. And there's also talk of a regional show for Melbourne, Australia, to be held in September of 1984. Presumably, this would be a "mini-convention" on the order of the Digital Seminar held in Rye, New York, last year.

This may be a good time to buy airline stocks. JMW

# Montreal Sound Studio

*The following three act saga recounts the building of a new audio control room in 'The Great White North.' Take off, aeh!*

**C**ANADA IS BEST KNOWN in America for our exports of toothless hockey players, strong beer and spacearms for the N.A.S.A. Shuttlecraft. With any luck, this list will soon include low cost acoustically designed and constructed audio control rooms.

Due to a gut feeling, and with a Vegas craps shooter's savvy, a project was undertaken by Montreal Sound Studio owner and Head Engineer Bill Hill that, to a logical eye, would appear foolhardy at best. The tough economic times having already forced a few of the better known and higher priced studios in Montreal to close their doors, there was no doubt about the demand and the need for Montreal Sound to have a perfectly designed and constructed audio control room. Shouldn't every studio have one? We all thought so, and were thoroughly convinced, until we found out that the basic going rate for such a room was \$35,000 and up. I mean, the last twelve months had been a banner year for Montreal Sound. We'd recorded two movie soundtracks, a disco album by a well-known major European star, and a dozen or more Canadian twelve-inch releases, not to mention all the jingles, commercials and audio visual presentation work generated from our two in-house companies, Hill/L'Espérance and Wavelength Productions. But there was still last year's purchase of a Harrison 4032 console to pay for. So the acoustically designed control room would have to wait...or would it?

## ACT ONE, SCENE ONE

June 15th, 1982

Enter into the scenario "The Seed Sower," twenty-five year old technical engineer Daniel Séguin, whose dreams and expectations went far beyond his current job of teaching studio sound engineering for a local institution. Seguin had rented time from Montreal Sound on June 15. Bill and Daniel innocently started talking about the weather that morning, and how nice it would be for the studio to have a perfectly designed and constructed audio control room. Four hours later, after learning that Daniel was the creator of the Dan Systems D.C. Power Amplifier, and had also designed two local four and eight track studios and was just itching to tackle a full-fledged twenty-four track room, the VU meters in Bill's head started peaking for the first time. Daniel was so eager to design the new "Montreal Sound" control room that he was willing to donate his design and manual labor for future considerations (many hours of late night studio time once the job was completed). Daniel also had access to some kiln-dried and aged two-inch Quebec White Pine that could be hand picked from a large order that was being prepared for export to Europe. In fact, his lumber contact was so good that he could buy the 3,200 board feet necessary to do the control room for only \$1,500.00. These meters in Bill's head were now nearing distortion level. Once Daniel revealed that he had just recently installed the brand new video projection system aboard Air Canada's L-1011-500's, and just happened to be part of the technical team that worked on the

*Robert Brewster, Jr. is a freelance creative writer, specializing in radio and television commercial jingles.*

Canadian-made spacearm for the Shuttlecraft. Bill's heart couldn't handle the excitement anymore and he told Daniel to go ahead with the design.

## ACT ONE, SCENE TWO

July 6th, 1982

Michel L'Espérance, Paul Zakaib and Bob Brewster are trying to enjoy their morning coffee. Bill Hill is making it extremely difficult as he spews forth this insane idea about putting together his dream control room for only \$6,000.00 (that's only \$5,000.00 American, aeh!). Needless to say, we found it quite hard to laugh and drink coffee at the same time.

**Paul:** I think the boy needs some new batteries for his adding machine.

**Michel:** Let's hope it's only that.

**Bob:** You mean?...

**Michel:** It's highly probable.

**Paul:** You mean the dude has finally gone one disco mix



*Some of the cast: (left to right) Bill Hill, Daniel Séguin and Bob Brewster.*

over the line and has harmonized and flangerized himself to the point of mummifying his brain?

**Michel:** All the evidence is pointing that way.

**Bob:** Who's going to break the bad news to his wife and kids?

**Paul:** (with a young child's excitement) I'll do it! I'll do it! Please, please. Can I? Can I?

**Bill:** (very seriously) Really guys, if we all pitch in a few hours of labor a day and can find a master carpenter who will work for nothing, we can pull it off for about six grand. The best part of this whole plan of mine is the estimated downtime of only three weeks.

*Everyone in the room shared a warm hearty round of laughter: all, that is, except Bill. He had a look in his eye that reminded me of a young child lost in his dreams of anticipation, waiting for his new toy to arrive.*

**Paul:** So Michel, shall I call the cookie wagon for Bill, or what?

*Michel just smiles and shrugs his shoulders.*



*Daniel Séguin hard at work reading his favorite magazine. (Isn't it everybody's?)*

**Bob:** What I mean, wait. I know the perfect carpenter for the job, but he sure as hell won't work for nothing.

**Bill:** (dead serious) Call him. Now.

## **ACT TWO, SCENE ONE**

**July 30th, 1982**

Enter into the scenario the final key character, twenty-eight year old self-taught master carpenter, Robert Maher. If this insane project had any hope of being completed in the allotted three-week time period, it would be due solely to the magician-like wizardry that would have to be displayed by Maher and his large entourage of fine woodworking tools.

Little did Maher realize when he walked into Bill's office that morning just how much of that self-taught know-how he was going to have to rely on. Maher had just finished three of his biggest and most satisfying projects. The first was an interior cosmetic renovation of one of Montreal's hottest



*The brand new audio control room at Montreal Sound Studio.*

night spots. This was followed by a total interior renovation and restoration of a mansion in Montreal's extremely wealthy suburb of Westmount.

**Maher:** The house is owned by this man who has a lumber importing business. I got the chance to work with some of the most exotic woods in the world. Stuff like Brazilian Pine, Burmese Teak, Burl Rosewood. Hey, some of that wood cost ten bucks a board foot.

Maher's last job was designing and rebuilding the interior of recently released Montreal Expos' pitcher Bill Lee's new home. There was no doubt in anyone's mind that Maher was capable of handling the job. But, could he handle the totally inept crew of Paul Zakaib, voice-over dialect specialist and impersonator. He's usually a very pleasant guy unless the coffee's cold or someone has stolen his precious "brown

bagged lunch"; Dino Bartolini, Montreal Sound's apprentice engineer. He is overly polite, extremely patient, young, strong, and willing to do any job; Bill Hill, owner and chief engineer of Montreal Sound; he is not to be counted on for too much on-site labor as he'll be too busy pulling out his hair and his wallet; Michel L'Espérance, musical composer and arranger. Generally, he's your basic sweet guy (you got to watch those sweet guys), and Bob Brewster, without a doubt one of the world's leading excuse-makers, who can back it up with an uncanny natural ability of being totally incompetent when it comes to handling any task that even slightly resembles manual labor?

Before Robert Maher would have the honor of working with this unique ensemble of "tundra monkeys" (we've been led to believe that this is a popular American term for Canadians; we like it a lot better than hosers, aeh!), he would have to come to terms with the legendary financial negotiator, Bill "it costs too much" Hill. Good luck, Robert!

## **ACT TWO, SCENE TWO**

**Same day**

Bill was sweating bullets as Maher walked into his office. He had just gotten off the phone with Daniel who had informed him that the wood had to be purchased immediately or there would be a 25 percent price increase and maybe even a chance of losing the wood altogether to another buyer. Daniel could bring the selected pine and cedar to the mill for planing in the afternoon and deliver it himself to the studio sometime during the evening. Bill had hoped that he could have slowly eased into the project... like, sometime next year. Messrs. Maher and Hill held very intense negotiations behind closed doors that lasted for over an hour. Every few minutes during that memorable hour, Maher could be heard yelling clear down to my desk at the front door, "Bill, you can't be f\*&?%+\* serious!"

Against all logic known to modern man, Robert Maher actually came out of the office that morning with a smile on his face and a challenge in his heart.

**Maher:** Okay, you lazy bunch of +&?%\$%! Get off your butts and tear this control room apart. The new one starts going in Monday morning.

**Paul, Michel, Dino, Bob:** What?!!

**Maher:** Rule Number One, and the only Rule. I never repeat myself, or tear things down. I just build them up. I like lots of hot coffee and I never work weekends. Any questions? No. Good. See you all Monday morning, 7:30 sharp.

While the boys started scurrying around wondering what to gently rip out first, I ran after Maher to find out why he accepted the job of constructing the "fancy perfectly acoustically designed control room." If you notice a slight bit of sarcasm in my words, it's because I was the only one who was perfectly happy with the old control room. It sounded great to me and the grease stains on the walls gave it that homey touch. But what the hell do I know? I'm tone deaf.

**Bob:** Hey, Maher. What's the hurry?

**Maher:** I have to get back to my shop and sharpen all my tools. Then, I have to disassemble my saws, pack them in the truck, double check all the plans for extra tools and material that might be needed....

**Bob:** Okay, I believe you. So tell me, how come you took the job?

**Maher:** Not for the money; that's for sure. I'm lucky if I get paid at all. You musician types have a bad reputation. I'm doing this strictly for the challenge and the experience of tackling something totally foreign to me. Actually, I'm approaching this control room as one big piece of fine furniture.

**Bob:** Very interesting.

**Maher:** I don't know how this room is going to sound, but you can bet your ass it's going to be constructed perfectly and look even better. See ya later, Bob. I got work to do.

**Bob:** Yeah, later.

## ACT THREE, SCENE ONE (Week One)

August 2nd, 1982

The whole studio complex looked like a quickly thrown together lumber yard as I sauntered in that morning. Thanks to some spontaneity and thoughtful maneuvering by Bill, we had use of the empty office next door to store and cut the wood. To get this space, Bill had promised the building superintendents that he would let them sing on our next jingle. As I carefully tiptoed my way to the now empty control room, I could hear Maher's gruff voice barking out orders. He drove home the point about power tool safety and proper maintenance procedures to the crew of novice laborers at his disposal. Maher later told me in private that if he had realized the crew was disposable, he would have dumped the whole lot.

Most of the first day was spent unpacking and setting up Maher's makeshift portable work shop. We also separated and selected the wood that was to be used in the framing of the cushioned footings that the whole structure would sit on. Daniel Séguin didn't arrive on the scene until late afternoon, as he spent most of the day double checking the data on the computer readout. Daniel once told me that if it's possible for any variable or group of variables to be computed, they should be, and then programmed, to be considered in the design. Daniel had assured me that everything from the total weight of the completed structure, down to the uniform absorption coefficient patterns of the two-inch white pine versus the half-inch cedar, had been considered. Daniel was convinced he had thought of everything. I'm glad he was, because I wasn't. He'd forgot to compute the piece of

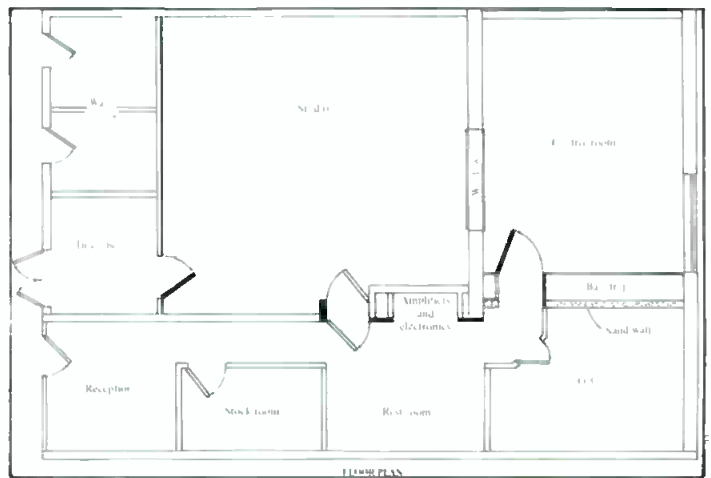
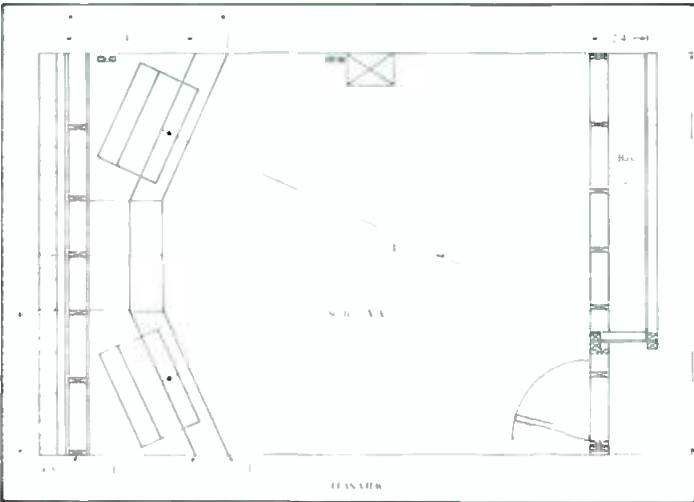

of pointing out to Maher the similarities between writing a complicated melody line and coordinating an on-site working crew. Whatever the system, it appeared, on the surface at least, to be working. Daniel could be seen every once in a while running around with his slide rule and tape measure.

August 6th, 1982

While Maher was cutting and fastening the inner pine shell to the frame, Michel was trying to force Maher into signing over the publishing and performing rights of their newly discovered idea. "The musical method of manual labor." Daniel and Paul spent most of the day building the cavity that would hold the Westlake studio monitors. Dino was stuffing insulation all over the place and silicone caulking everything in sight. No one saw too much of Bill that day as Maher kept him and his wallet very busy driving all over Montreal to purchase a few unforeseen supplies.

bubblegum I'd left stuck under the Harrison console before they built the box around it.

August 3rd, 1982

Disassembly of truss in the workshop and the setting of it into place in the control room was painstaking work, as the self-contained box structure was to be floated on pads and remain independent of any adjacent walls. This would achieve an air space around the whole box and would free the control room of all structural sound transmissions and vibrations. The many compound angles and lab joints were mathematically scribed together. Each one was glued, then bolted together with two one-eighth inch steel plates. This was done to prevent the wood cracking at any joints.

August 4th and 5th, 1982

Work that was started on August 3rd was completed. Amazingly, after only one day of intense training, Maher had the boys working as a unit. Tools were being plugged in, passed, used, and unplugged without a word being spoken. Michel was claiming that this harmonious working relationship was being achieved by him having the foresight

## Get Aligned Stay Aligned with STL precision magnetic test tapes

These dependable tapes are used by broadcasters, recording studios, equipment manufacturers, governments and educators throughout the world. Widest variety...Alignment, Sweep, Pink Noise, Level Set, Azimuth and Flutter/Speed. Available on reels, in cartridges and in cassettes. Also, the Standard Tape Manual & the Magnetic Tape Reproducer Calibrator.

Phone for fast delivery or free catalog.

**STL**

**STANDARD TAPE LABORATORY, INC.**

26120 EDEN LANDING ROAD #5 HAYWARD CALIFORNIA 94545 • (415) 786-3546

### Week One Summary

After five non-stop sixteen-hour work days, interrupted only by hundreds of threatening phone calls from our wives and periodical visits from the local Greek pizza delivery man, we decided to call it a week.

It was two a.m. Saturday morning and the whole crew was beat, not to mention Bill who was a total nervous wreck as he watched his carefully planned budget slowly get up and casually fly out the window. Down to the last man, the now finely tuned crack work team was ready to come in the next morning and continue the impossible dream... It should be duly noted at this time that I was personally banished from the work site at three p.m. that day for being a threat to worker safety and a public nuisance, so, I don't believe them when they say they were ready to come into work the next morning only a few hours later. It's no secret how long and cold Montreal winters are and just exactly how lonely they can be without wives... say no more!

### August 7th and 8th, 1982

And somewhere, some wise old man said, "Let the poor boys rest a couple of days, they is all plum beat, and besides, the carpenter don't work weekends."

### ACT THREE, SCENE TWO (Week Two)

#### August 9th, 1982

Robert "we're going to need more" Maher was driving Bill crazy with his outrageous demands for inconsequential items like screws and nails. Way back on August 2nd, Bill had bought a brand new note pad. This rather thick pad was quickly being filled up with a list of "don't worry Bill, it's only ten dollars" items. The office wall was demolished to allow an extra two feet to the control room for a base trap and sand-filled baffle wall. Since I had once sat through a Bruce Lee Kung Fu Festival, I was awarded the honor of running through the old gyprock wall. Both of the new walls began fabrication that day.

#### August 10th and 11th, 1982

Everyone was feeling the pressure as the ten-day construction deadline was rapidly approaching. The always polite Dino was now snapping at everyone with some of the finest mixture of street Italian and French heard this side of New Jersey. The clear-red B.C. cedar was cut and put into place on the control room walls. Sixty bags of sand were painfully lifted and poured into the baffle wall by Paul and Dino.

### August 12th, 1982

The two new door frames that would separate the control room from the rest of the studio complex were set into place. The suspension system for the 630 cubic feet of bass trap was fastened into the ceiling. Daniel was busy measuring and cutting the many sound absorbing panels of various lengths and dimensions that would make up this suspended bass trap. This, he said, would achieve the transfer of acoustic energy into kinetic energy, thus reducing the sound pressure level at low frequencies.

### August 13th, 1982

Maher was busily putting the finishing touches on his latest woodworking masterpiece. Dino and Daniel were passing A.C. wires through the ceiling of his clothes closet in the hallway. This, I was told, had become the new home of the power amp rack. Paul was trying his best to put Bill's office wall back together while Michel was on the phone trying to hustle up some new business to pay for the over expenditures of the new control room. Bill was keeping a low profile, as we all knew he still had some money left in his wallet.

### Week Two Summary

We called it Week Two around nine o'clock on Friday, August 13th. It might have been an unlucky day for some people, but this unsightly bunch of bumbling bafos was right on schedule and damn happy about it. Bill was so overcome by the absurdity of it all that he took the whole crew to MacDonald's for burgers and fries. (Actually, we went to the local striptease club for a round of cold beer and a "look-see," but MacDonald's sounded better to the wives.) Everyone was a little saddened that night as we helped our spiritual leader pack up all his magical woodworking tools and place them carefully into his van. His job completed, Robert Maher would now be leaving us, but he vowed to return.

**Maher:** You guys just know I'm going to drop by at the end of next week to watch you all crawl as your deadline passes you by... Bye!

*As Maher's truck slowly pulled away into the city streets, the boys all stood there and waved until the last glimmer of his taillights dissolved into the night. I think Bill even had a tear of joy in his eye as he thought about how good it would feel to have a few dollars left in his pocket at the end of a day.*

**Michel:** Who was that man?

**Paul:** I don't know but the sucker drove a six-inch silver nail through my skull before he rode off.

**Bob:** See, Dino, I told you he liked Paul best.

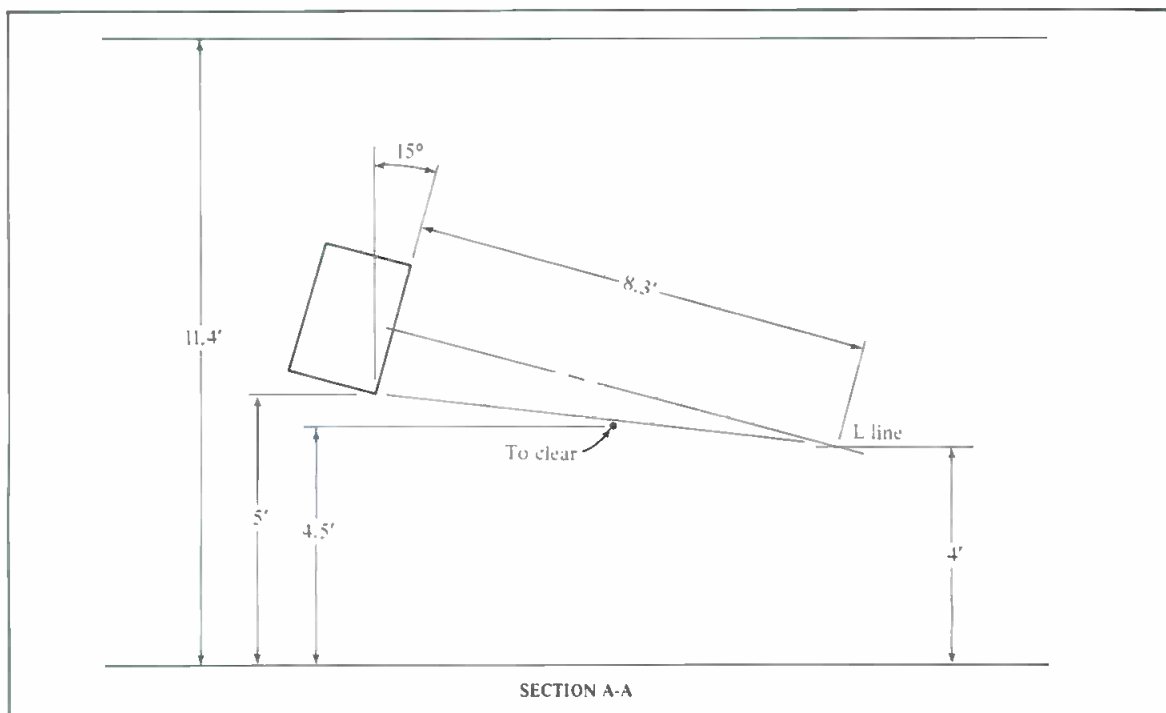

# Montreal Sound Studio Equipment List

## CONSOLE

Harrison 4032 with Allison Automation

## TAPE RECORDERS

1 24-track MCI with Autolocator III

2 Studer 2-track with Dolby noise reduction

## SIGNAL PROCESSING DEVICES

1 Eventide Harmonizer

1 Eventide Flanger

1 Eventide Phaser

1 Lexicon DDL

2 UREI LA3A Limiters

4 Kepex

1 EMT 240

6 Custom Compressors

## AMPS

1 Crown DC300

2 Ward-Beck

## SPEAKERS

Westlake, bi-amped

Auratone and JBL 4311s

Bryston 4Bs

## MISCELLANEOUS

10 Beyer Headsets

20 various Microphones: Neumann, AKG, Electro-Voice, Shure, Milab

Yamaha 6-foot Grand Piano

Fender Rhodes Piano

Clavinet

Fender Twin Reverb

Hammond and Leslie Organs

Daniel: Thank God, he's gone. Now I can get some work done.

### August 15th and 16th, 1982

Like August 7th and 8th, these were both used for well deserved rest. Somewhere, though, in the inner bowels of a sleeping city, Daniel Séguin was tossing and turning in his sleep as technicolor visions of acoustically designed studio control rooms were dancing the Charleston on his ceiling. The weight of this insane, or maybe not so insane, project was now clearly resting on Daniel's shoulders. He himself admitted that Maher had constructed the room to his exact specifications.

Daniel: Really, guys, all kidding aside. This Maher, he's not just a carpenter, he's a great artist.

Daniel had been a big thorn in Maher's side at times, as he was constantly in the way double checking every move of the construction. He did this because no one knew better than himself that the brunt of the workload for the remaining days was his alone; the worry load he could share with Bill.

### ACT THREE, SCENE THREE (Week Three)

#### August 16th and 17th, 1982

Paul spent most of the two days vacuuming the whole studio complex from top to bottom. Michel followed Paul around with a feather duster and a damp cloth—what a team! Dino tackled the overwhelming task of cleaning up the empty office next door that was used as a workshop and for lumber

storage. Daniel was zooming around spraying all the components with contact cleaner before setting them into their proper place in the new scheme of things. The decision to totally rewire everything where at all possible was made by Bill. I mention this only because I spent the better part of two days running around Montreal trying to find some one fool enough to give us the wire we needed on credit.

#### August 18th and 19th, 1982

The color in Bill's face that had been missing the last few days slowly returned as everything miraculously was falling into place. Dino spent most of his time in the now airtight ceiling as Daniel skillfully maneuvered bunches of wire through a tiny crevice in the closet. These wires led to a pre-constructed wood tunnel that somehow came out in the airtight ceiling. I'm informed that most of these wires were then passed down another channel on the other side of the room that came out near the Harrison console. Some of these wires were pushed through yet another tunnel—in the floor, this time—that came out in back of the MCI 24-track. A few of these wires were then filtered over to the Studer 2-track and still more wires managed to find their way over to a rack that held the Dolby units, Revox tape deck, Harrison power supply and the Dolby remote unit. Michel was not around at all on the 18th and 19th. He was busy working on the video end of an A.V. project that was to begin audio recording at ten a.m. on Friday morning in our new studio. Bill spent most of his time on the phone speaking with important people.

#### August 20th and 21st, 1982

Now that all the wires that had to be passed anywhere were finally there, Michel could put up the dark brown cloth that would cover the base trap ceiling and wall.

Michel: I tell you, darlings, this fabric is going to bring out the true flesh tones of our music.

Dino spent a good deal of time in the power amp closet installing wires and a cooling fan. Daniel was permanently riveted to the back of the console with his soldering gun and his V.O.M. Every once in a while, Daniel could be heard muttering, "Tabernae! This is getting serious." Bill, as usual, was on the phone. I spent most of my time trying to dodge Paul, who was running around with a can of furniture polish, spraying and cleaning everything in sight.

Well, folks, believe it or not, this task that once seemed impossible at best came to a victorious conclusion at 12:04 a.m., Friday, August 20th. The result wasn't official until two a.m., when Daniel emerged from the control room with a big smile on his face and an armful of graphs to back it up. He couldn't resist tossing a dirty look my way as he held up a slightly used piece of bubblegum that he had allegedly found stuck under the console. It had taken fourteen 16-hour work days to attain victory, but it was finally ours. The victory did have its casualties, though. The hardest hit was Bill's wallet and the joint bank account he shared with his wife. Wait till she finds out! The final tab on the new control room was \$8,500.00 Canadian—still an outright steal. Paul, Michel, Dino and Daniel were both mentally and physically exhausted. For sure, they wouldn't be much good at anything for at least the next few days...sorry, girls. What, you're all asking, was Bill Hill doing at this ungodly hour of two-thirty in the morning? Well, Bill was frantically searching for a 24-track tape that he could remix. As Bill sat down behind the console of his new "perfectly acoustically designed and constructed control room," that child-like gaze I had seen way back when this project was conceived returned to his eyes once more. As the anticipation of seeing and hearing his "impossible dream" for the first time became too much to hold in, the ever-widening grim on his face broke into a naughty laugh as Bill said, "Okay, kiddies, now it's time to play."

THE END.

# MODERN RECORDING & MUSIC

**The magazine for people  
who create music**



**MODERN  
RECORDING  
& MUSIC**

1120 Old Country Road  
Plainview, NY 11803

- \$26.00 for 24 issues—save \$20.80  
 \$15 for 12 issues—save \$8.40  
 (\$1.95 to subscribers)

Charge to my  Mastercharge  Visa acct  
 My account number is \_\_\_\_\_ Exp Date \_\_\_\_/\_\_\_\_/\_\_\_\_

Signature \_\_\_\_\_

## Subscribe Now!

Payment enclosed (Put form in envelope)

Signature \_\_\_\_\_

Name \_\_\_\_\_

Address \_\_\_\_\_

City \_\_\_\_\_

State \_\_\_\_\_ Zip \_\_\_\_\_

Outside U.S. add \$3.00: U.S. funds ONLY. 207C



# The Cortical Hearing Aid

*Due to the overwhelming response of our readers, we present the following article on the Cortical Hearing Aid, an instrument that, according to the author, enables the stone deaf to understand speech and enjoy music.*

## DESCRIPTION AND OPERATION

**T**HE CORTICAL HEARING AID (CHA) is an instrument that produces the sensation of hearing by electrical stimulation of neurons in the auditory cortex in either temporal lobe of the brain. No earphones, loudspeakers, bone conduction units, or surgically-implanted electrodes are used; instead, a small insulated metal disc is lightly held against the appropriate spot on the head.

FIGURE 1 shows the CHA "black box" diagnostic console used in tests on the profoundly deaf (those with hearing losses in excess of 90 dB or with no measurable hearing at all). The electronics circuitry consists of a microphone preamplifier and a waveform generator that produces an electrical current that scans the neurons in the auditory cortex at the rate of 40,000 times per second. This is the equivalent of implanting several thousand electrodes in the cortex, which is not feasible. Input switching is provided for a microphone, tape deck, radio or TV, an external audio oscillator, and an internal audio oscillator producing tones of 125, 250, 500 and 750 Hz, and 1, 1.5, 2, 3, 4, 6, and 10 kHz. A second microphone channel (not switched) and loudspeaker are provided for communication to the console operator from the audiologist or otologist in attendance on the patient. The metal disc, in its experimental Lucite holder, is shown lifesize in FIGURE 2.

FIGURE 3 shows a diagnostic model that has been built for patients whose hearing loss is only moderate (30 to 60 dB) or severe (60 to 90 dB). This model uses a scanning rate of 200,000 Hz, and provides mostly electrophonic rather than cortical hearing. Electrophonic hearing is produced by vibrations of the tympanum or facial skin near the ear, and the metal disc produces these vibrations by acting as a condenser loudspeaker; one electrode is the metal disc, the other the skin.

The small consoles may also serve as home hearing centers for deaf patients. Switched inputs are provided for a microphone, TV or radio, telephone line, and an internal oscillator, in case the patient wishes to check his hearing at various frequencies.

As in many other engineering designs, certain parameters represent a compromise. Blood and lymph fluid have about

the same electrical conductivity as sea water, which means that the lower the scanning frequency, the better the penetration into the brain. So for best results as a cortical



Figure 1. The CHA Diagnostic Console.

hearing aid, we select a frequency as low as possible, without too adversely affecting the fidelity of speech and music reproduction. (Bone in the skull has a dielectric constant of about 10, so the skull presents no obstacle to the passage of biphasic currents.) For electrophonic hearing, which is essentially a surface phenomenon, we can go to a higher scanning frequency and thus get better fidelity.

The stimulus-response relationship of the CHA is linear, so we use a linear meter to measure the intensity of the stimulus, as seen in FIGURE 1. However, in electrophonic hearing the signal-to-noise relationship is logarithmic, as in normal hearing, so we use a dB meter to measure signal strength.

The stimulus electrode (the electrode applied to the head) is a thin disc of Elgiloy (a high-nickel alloy developed by the Elgin Watch Co.) coated on one side (the side placed against the head) with a layer of Teflon tape. Both of these materials are completely non-reactive with body chemicals and with each other. Gold, platinum, or iridium could be used in place of Elgiloy, but at a far greater cost. The ground electrode is bare Elgiloy.



Figure 2. Lifesize photograph of the stimulus electrode.

### TEST PROCEDURES

All measurements were taken in a custom double-walled suite of two rooms at the Easter Seal Rehabilitation Center in Bridgeport, Connecticut. Either an audiologist or the author operated the CHA diagnostic console in the control room while an otologist or another audiologist worked with the patient in the test room.

Every patient tested had recently undergone an otological evaluation, an audiological and hearing aid evaluation (if the patient used a hearing aid), and received medical clearance and referral to the tests.

The patient's forearms were cleaned with alcohol to remove skin oils, and a ground electrode was strapped to each forearm. The stimulus electrode was lightly held against the pinna of the right ear by the audiologist. The intensity of a 1000 Hz tone was increased until the patient signalled that he heard it. The electrode was then moved to various areas of the temporal region until the patient indicated the specific spot at which the sound was the loudest. (This is the "point of entry," and for some patients it is critical: moving the electrode a quarter of an inch or so can make a big difference.) When the best spot was found, the electrode was held there and testing commenced.

The audio test frequencies used were 125, 250, 500, 750, 1000, 2000, 3000, 4000, 6000, 8000, and 10,000 Hz. The patient raised a finger when he heard the tone<sup>1</sup>. This procedure was then repeated on the left side of the head.

Speech discrimination (word discrimination) tests were

next. Using live voice from a microphone at the console, and counting from one to ten, optimal electrode placement was reestablished. In accordance with the patient's linguistic abilities and education before the onset of deafness, one of three audiolgically acceptable test procedures was used: multiple choice CID spondaic words (Central Institute for the Deaf test involving two-syllable words, i.e. baseball, football); word intelligibility by picture identification<sup>2</sup>; or CID W-22 monosyllabic words (a test procedure involving monosyllables)<sup>3</sup>.

### TEST RESULTS

The CHA console shown in FIGURE 1 was used to test 207 children and adults, with hearing losses ranging from mild to no measurable hearing at all. The group was comprised of 117 males and 90 females, with ages ranging from 7 to 79 years. The etiologies of the group are shown in FIGURE 4A. Of this group of 207 patients, 129 have hearing losses ranging



Figure 3. The Electrophonic Console, housed in a Western Electric remote preamplifier, circa 1936.

Patients Tested		Category	Word Discrimination of Profoundly Deaf Patients	
No. of Males	No. of Females		Discriminated Speech	Did Not Disc. Speech
6	0	Acoustic Trauma	0	0
0	3	Birth Trauma	3	3
3	0	CVA	0	3
12	6	Genetic	6	0
3	0	Hyperoxia	0	0
3	0	Hypoxia	2	0
0	3	Mastoiditis	1	0
3	6	Menieres Disease	3	0
9	0	Meningitis	5	0
9	12	Otosclerosis	3	1
12	0	Ototoxicity	3	2
9	6	Premature Birth	4	0
9	6	Presbycusis	0	0
12	18	Rubella	12	0
18	21	Unknown	9	8
9	9	Viral	8	2
<u>117</u>	<u>90</u>		<u>59</u>	<u>19</u>

Figure 4. Etiologies and test results of patients using the CHA console.

from mild to severe; 121 of these discriminated and understood speech due to electrophonic hearing.

Of the remaining group of 78 patients who are profoundly deaf or have no measurable hearing, 59 (76 percent) were able to discriminate and understand speech due to cortical hearing, and we taught many of them small vocabularies of from 4 to 12 words in an hour's time. The etiologies and word discrimination of the cortical hearing group are shown in FIGURE 4B. In this group, the best results were obtained with patients classified under rubella, 100 percent (12 patients); genetic, 100 percent (6); meningitis, 100 percent (5); viral, 80 percent (8). At this time, we do not know why we could not "get through" to 24 percent of this profoundly deaf group.

#### SAFETY CONSIDERATIONS

Five design factors insure the safety of the patient when using either the cortical or electrophonic models:

1. The scanning current used is biphasic (approximately AC) at a frequency of either 40 or 200 kHz. These frequencies are high enough so that there is no possibility of interference with "brain waves" (alpha, 8 to 13 Hz; beta, 14 to 30 Hz; theta, 4 to 7 Hz; delta, 0.5 to 3.5 Hz) or heart pacemaker pulses. At the same time, 40 and 200 kHz are entirely out of the range of those frequencies producing heating of internal body organs (150 to 1250 MHz) or cataracts in the eyes (100 to 10,000 MHz).
2. The scanning current intensity ranges from 5 to 25 milliamperes RMS, depending on the desired loudness of the speech or music.
3. The stimulus electrode is insulated from the patient by a layer of Teflon film.
4. Since all currents are biphasic, there is no cumulative electrochemical action which might result in skin irritation, dermatitis, or nerve depolarization.
5. Each power supply incorporates an isolation transformer

so that neither the patient nor the audiologist can get a shock from the 115-volt 60 Hz power line.

Two devices using currents of comparable or greater intensity have been in clinical use on human patients for eight years. The first uses transdermal stimulation for reactivation of the auditory nerve<sup>4</sup>. The second is used for the relief of pain<sup>5</sup>. No adverse effects on neural tissue have been found. In our own tests of the CHA, no patient reported even so much as a headache.

#### ADVANTAGES OF THE CHA

1. The greatest advantage of the CHA is that, at present, it is the only hearing instrument that enables the "stone deaf" to understand speech and enjoy music.
2. No electrode implantation or other surgery is required.
3. Electrode pressure is very light, and causes no discomfort to the patient. (Bone conduction units require a pressure of 1 to 5 pounds against the mastoid bone.)
4. The audio frequency range is from 125 to 10,000 Hz. It is essentially flat over this range, as the portical neurons are equally responsive to all frequencies within this range.

#### ADVANTAGES OF THE ELECTROPHONIC MODEL

1. The audio frequency range (125 to 20,000 Hz) is much greater than that of any air conduction units commercially available today, and is free from the peaks and valleys found in air conduction units. The response curves may be just a straight line, or smoothly tailored to provide any frequency emphasis desired.

Most of the patients tested preferred electrophonic hearing rather than their own conventional hearing aids; they said that speech and music sounded more natural.

2. The electrophonic model is entirely free from the phenomenon known as recruitment (a phenomenon where a great deal of noise builds up, similar to regeneration) which is very annoying to many hearing aid users.

In times like these  
it's good to know

**The first  
duplicator  
Garner sold  
is still at  
work...20  
years later.**

**garner industries**

4200 N. 48th Street Lincoln, NE 68504  
Phone: (402) 464-5911 Telex: 438068

#### And It Looks Like It's Going to Work Another 20

Twenty years ago, Garner Industries manufactured their first high-speed professional dubbing machine. Twenty years later, that machine is still at work making hundreds of dubs a day.

In times like these when every dollar counts, it's nice to know that Garner is still building duplicators to last, and we've made some improvements along the way. The Garner 3056 and Garner 4056 cost much less, take up less space, use less power and require far less maintenance than other duplicating machines on the market today. And the new Garner duplicators offer advantages that our first duplicator didn't have:

- Fast 60 ips speed
- No wow/flutter added because of a common capstan drive
- Simplified tape loading
- Long-life modular electronics
- Solid-state modular electronics
- Smooth, quiet operation
- Three-year mechanical warranty.

When you consider the cost of a duplicator, consider what you'll be getting for your dollar. If you want all of the state-of-the-art features in a product that's practically indestructible, then Garner has your machine. The only problem is, if you buy one of our duplicators, you may never need another duplicator.

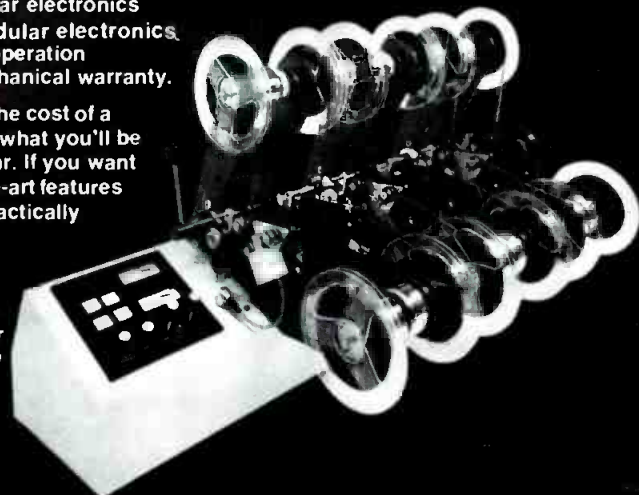

**Dependability... Guaranteed**

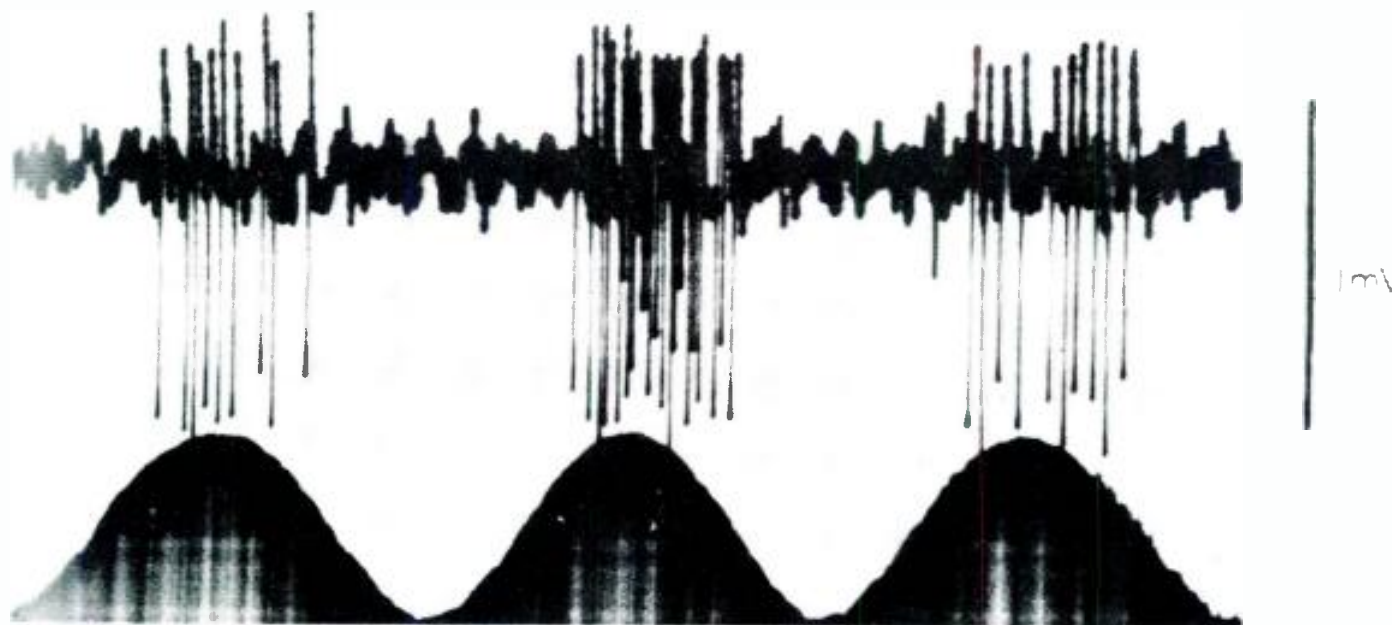

Figure 5. A 27.5 kHz waveform recorded in the auditory cortex.

As in the case of CHA, electrophonic hearing requires no surgery and only very light electrode pressure.

#### THE DISADVANTAGES

The one disadvantage of both models is that they require many times the electrical power required by air conduction aids. Because of this power requirement, a CHA that fits inside the ear canal will never be possible. By careful design and the use of a rechargeable battery, a CHA of the "ear hook" type should be possible.

A lavalier model, about the size of a camera case (3" by 5" by 7") that would hang around the neck, could be made available within a matter of months. The diagnostic model of FIGURE 1 could be produced within a short time, and would be used for teaching classes of hearing-impaired children.

#### THEORIES OF HEARING

It is an unusual situation, in view of the recent exponential increase in our knowledge of neurological and biological systems, that we don't know exactly how we hear. There are two theories of hearing: the telephone theory and the place theory<sup>6</sup>. Neither offers a complete explanation of the human hearing process. It is generally conceded that the auditory nerve (8th cranial nerve) is not able to transmit frequencies above 3000 Hz. Yet neurologists have observed and photographed the response of a neuron in the anesthetized auditory cortex to acoustic frequencies as high as 27.5 kHz (FIGURE 5). And Frey found that the auditory cortex was stimulated by radar and other pulse-modulated high frequency transmissions. These effects were perceived as being a buzz, hiss, clicking, or series of knocks<sup>7</sup>.

In our work, we found that the neurons in the auditory cortex do not resolve phase shifts between fundamental and harmonic tones as the normal hearing channel does.

We also found very little correlation between a patient's audiogram as obtained with the conventional audiometer and earphone, and the response of the patient to cortical hearing. Conventional audiometric measurements could be taken on only the relatively few profoundly deaf patients who could still hear a few tones around 500 or 1000 Hz, but the CHA permitted these patients to hear tones up to 8000 or 10,000 Hz.

We also found that the CHA currents required to produce the sensation of loud sounds were not strong enough to activate those brain areas adjacent to the auditory cortex, such as the speech, motor, or somatic sensory areas, or the interpretive cortex investigated by Wilder Penfield<sup>8</sup>.

Cortical hearing will be a diagnostic tool of the future that may answer some of our questions as to why we hear. But further investigations will have to wait for the infusion of the venture capital that we need. ■

#### REFERENCES

1. Green, D. S., "Pure Tone Air Conduction Testing," in Katz, Ed., *Handbook of Clinical Audiology*, 2nd Ed., Williams & Wilkins, Baltimore, 1978, Chapter 9.
2. Ross, M., and Lerman, J., *Word Intelligibility by Picture Identification*, Pittsburgh, Stanwix House, 1971.
3. Hirsch, I. J., et al. "Development of Materials for Speech Audiometry," *Jour. Speech & Hearing Disorders*, 17:321-37, 1952.
4. Martin, J. E., et al. "Electro-Stimulation and Sensorineural Hearing Loss, A Preliminary Report," *Jour. of Communicative Disorders*, Vol. 6, 1973, pp. 145-150.
5. Linzer, M. and Long, D. M., "Transcutaneous Neural Stimulation for Relief of Pain," *IEEE Trans. on Biochem. Eng.*, Vol. BME-23, No. 4, 1976.
6. Von Bekesy, Georg, "Hearing Theories and Complex Sounds," *Jour. Acoustical Society of America*, Vol. 35 No. 4, April 1963, pp. 588-600.
7. Frey, A. H., "Human Auditory System Response to Modulated Electromagnetic Energy," *Jour. Applied Physiology*, Vol. 17 No. 4, 1962, pp. 689-92.
8. Penfield, Wilder, "The Interpretive Cortex," *Science*, June 26, 1959, pp. 1719-25.

#### ACKNOWLEDGMENTS

The author would like to thank John J. Leddo, Director of Audiology, The Easter Seal Rehabilitation Center of Eastern Fairfield County, 226 Mill Hill Avenue, Bridgeport, Connecticut; Edmund S. McLaughlin, Executive Director of the Easter Seal Center; Arthur W. Samuelson, M.D., otologist and medical director of the project; Donald P. Granger, M.D., neurologist and neurological consultant to the project; David S. Green, Ph.D., audiological consultant; Sherry P. Redler, M.S., project audiologist, and the Medical Advisory Board and Board of Directors of the Easter Seal Center, for their intense interest, intelligent guidance, and courteous cooperation during the entire testing program.

We wish to acknowledge with gratitude the kindness of Robert D. Russo, M.D., in providing a suite of offices for the initial phase of the testing program.

The initial phase of this project was funded by the author; the second phase by Electro-Physical Research, Inc.

# The Creative Process in Audio-for-Video

*As the need for audio-for-video grows, so too does the need for creative audio engineers with a working knowledge of video technology.*

**T**HE GROWING NEED for audio-for-video is causing a re-evaluation of recording studio design and production technology. New considerations are being paid to state-of-the-art consoles, tape machines, synchronizer and personal computer interfaces.

However, while this new direction is creating some of the most expensive and lavish recording facilities and sound mixing suites ever built, there appears to be a growing misunderstanding of the realistic requirements for audio-for-video and how a recording studio should be designed to accomplish this kind of work with the optimum efficiency and creative control.

As a music and sound production facility, Onomatopoeia has been operating for ten years in a variety of capacities—from the composition of jingles and soundtracks for films, video and audio/visual presentations, to the combination of this creative edge with the actual engineering and production of quality audio tracks for the various visual mediums.

It has always been my belief that audio and video must be integrally matched to achieve the best final product. Contemporary video producers appear to be accepting this concept more and more. While many of them appear eager and willing to invest time and money in the creation of a quality audio track, most are unaware of what it requires. Certainly they need a production facility with the technology and personnel to lay audio onto video. They also need someone to create the soundtrack for them, as well. Most of all, they need someone and someplace that can do both.

Onomatopoeia's new Studio A was designed to fill both a production and creative need in sound for video. And, before a single piece of equipment was purchased, considerable thought was paid to the needs of our clients as well as our engineers.

Soundtracks for video are mostly developed from many disparate elements. There are musical programs that demand a 48-track remote recording that must be later re-mixed in a 48-track post-production suite. This was the format used in my recent assignment as audio producer for the cable broadcast of "Sophisticated Ladies," which was beamed live from the Lunt Fontaine Theater in New York to a pay-for-TV audience, and recorded and later re-mixed for an eventual videodisc release.

However, the bulk of the sound for video work has completely different creative and equipment demands. In the majority of the cases, projects involve the integration of interviews, music, sound effects, narration, stock music, customized stock music and musical special effects, all of which must be designed directly for the picture. The sound cannot overwhelm the visuals either with its dynamics or its

mix. The final product must appear as if the sight and sound were created simultaneously, by the same individual, with the same creative sentiments.

What this means from a studio design standpoint, is a configuration of a lot of different source materials, all of which eventually has to be entered into a multi-track format. These source materials included everything from quarter-inch elements, to sound or music off of discs, to those off broadcast cartridges, loops and ambiences—all of which have to be controlled and manipulated with a synchronizer.

As a composer, musician and audio producer, I have worked in numerous recording studios throughout the country, many designed for audio-for-video work. While these rooms are frequently equipped with superlative equipment, with phenomenal specs, the rooms themselves are more suited to the needs of the record producer than today's video producer.

I have worked in rooms without a turntable and without a quarter-inch tape machine other than the one being used for the mix. If I needed twin 24-track machines, they were sitting there beside me, but if I needed a snippet of sound from an LP or cart, I would have to go into another room to do the job. Besides being creatively inconvenient, the very action of stopping a job midstream and picking it up in another location is inefficient.

The creation of an audio track for video is the result of a great deal of experimentation. If a producer wants a sound, you have to produce that sound even if it entails hopping into the voice booth and whistling a tune yourself. You need quick access to as many of the various sound ingredients as possible. You can't afford to have the recording process slowed to a snail's pace because the engineer has to stand up from the console and cross to the other side of the room to search for some music or vari-speed a piece of tape.

Many recording studios are looking at video work as the land of milk and unlimited money. Budgets are frequently large in video work, but producers are cost-conscious and expect top-dollar professional efficiency from your staff, your equipment and your room.

Let me give you an example of a typical job that Onomatopoeia handles and show why this kind of work demands a flexible room design.

## A GOOD EXAMPLE

General Foods has an orientation tape which they have been constantly updating for the past three years. It is on a one-inch video master about ten minutes long and tells you everything you need to know about their company and its products. However, General Foods is always bringing out new products, buying new companies, playing up certain products, playing others down. Now, in comes the video producer with job in hand, and he basically wants to add some material, take some out and end up with a tape a net length somewhat longer than what he had before. There are

**The staff of Onomatopoeia, featuring author/president Matt Kaplowitz (center) hard at work on the HBO special, 'Braingames.'**



immediate questions that come to mind: What is the most efficient way to take a time-coded tape, drop things out and add others? What do you do first? Do you cut the video first? Do you record the voiceover first and put the music in afterwards? Do you do the whole thing first and edit the final track? Do you do a combination? Do you keep the sync but change the time code? Where do you start?

The video producer has many questions and it is up to the audio professional to supply the answers. They need someone who understands audio but also understands video. They need more than a technician. They need individuals who can help them enhance their projects with sound.

Let's go back to the General Foods example. There were certain elements that had to be re-recorded. We could have told them to go out and have the video portion of the work done and come back to have it all pieced together. There are plenty of studios who don't want to be bothered with anything but the final assembly work. However, what we did, and what we do with all of our clients, is work their way through the entire project. The same audio engineer who is doing the post-mix is also doing the narration session. As a result, he knows that in order for the narration to work with the visuals and the rest of the score, the narrator's inflection has to match the rest of the program so that when it is edited, it will sound right. In order for audio-for-video to truly work as a creative element, it has to retain the same integrity and ambience throughout all the stages.

In audio-for-video, there may be the video producer, but there is rarely a dedicated audio-for-video producer. The video producer may have some general knowledge about the audio requirements of his project. However, he is rarely an individual who has a creative handle of both sides of the project so that he can create audio concepts and sit behind the console and make them happen. The successful audio-for-video facility must offer a spectrum of services—from creative to engineering.

Obviously, there should never be a trade-off in terms of sound quality. However, when you are dealing with audio-for-video, you are dealing with a medium that realistically has inherent limitations. Of course, audiophiles can expound about the audio potential of digital audio satellite transmission, and any audio professional enjoys tinkering with the latest audio toys, but the audio-for-video producer should never lose track of the reality of the medium he is working with. I am not suggesting that the audio quality should ever be shortchanged. However, anyone reading this magazine is already well-equipped to offer their clients quality sound and, frankly, there is no mystery to the procedure. What I maintain, though, is that the creative elements need to be given far greater consideration in the design of an audio-for-video room.

## DESIGN PHILOSOPHY

As far as Onomatopoeia's Studio A was concerned, the basic guiding principle was for it to be a room where all the essential equipment was within arm's reach. This included three quarter-inch machines, machines that carry any type of track configuration, time code generators and outboard equipment. I have worked in several leading studios, for example, where you can't even calibrate the limiters from the mixing console. If you're looking at the board, you can't see the output on the meters! So—in terms of outboard gear, the noise reduction, the equalization, the signal processing—everything had to be within eye as well as arm's reach.

There also had to be room to work. The room couldn't be so jammed with equipment that people couldn't feel comfortable working and creating there. While I designed the room to be operated with only one engineer, I wanted to make sure that if we had a project that could move faster with a second engineer, that second engineer could comfortably move around without getting in the way.

Onomatopoeia recently completed a soundtrack for a one-hour special on the holocaust for Public Broadcasting (PBS).

At times, I was juggling eight to ten different reels of sound elements as the soundtrack was being built. Most rooms I have worked in might have given you an area to lay down your materials on top of the console, or on top of the outboard equipment, or on a corner table along with your back lunch, the ashtrays and coats. In Studio A, I wanted there to be a work area for the engineer as well as the producer. I am not saying that the room had to be luxurious; it had to be a sensible working environment; it had to be comfortable.

## THE SYNCHRONIZER

The center of every sound for a video project is the synchronizer. Much has been written about synchronizer science and technology, though there is really no way to truly understand time code and its application without working with it time and time again. I selected the BTX 4600 for Studio A for several reasons, the primary one being its ability to control four machines simultaneously as opposed to other systems that can only control two or three machines without getting a lot of additional hardware. Just as important, however, was the unit's incredible reliability. There are numerous brands of synchronizers on the marketplace today and time code technology continues to improve rapidly; so any unit you buy today will be improved or updated within six months. Reliability, however, is never out of date. You simply can't deal with synchronizer downtime in an audio-for-video situation; you can't accept a fraction of time out of sync. There is no way around it, other than an avalanche of apologies to your client when the synchronizer goes.

Still the unit has limitations—the most serious of which is that it can't be easily interfaced with a personal computer. Such an interface is incredibly important in studio situations, especially in a production where there is considerable duplication of steps.

Let's say I am building a soundtrack and I spot a way to simplify the means of programming the tape controller. Without the capability of a personal computer, I have to actually move the sound effect, adjust the music cue, go back to my cue sheet or start from scratch. There is no way I can type into the computer a total list of my commands so that it can repeat them with a simple instruction. The BTX 4600 can only handle a total of 200 commands. Two hundred commands is nothing when you're working on a soundtrack for a one-hour television show. You are looking at literally thousands of commands.

The only other problem is that the 4600 locks into frames but doesn't lock into microframes. Currently, I am in sync within a fiftieth of a second, and even a fiftieth of a second is out of sync when you are locking music with music. Though I have performed this work numerous times as a producer and engineer, it was not a main concern with the design of Studio A.

It is just such considerations that have to be made when you design a room for audio-for-video. Understand who your clients are, what you want to do to make the room work, and which ingredients are essential and which are not.

## UNDERSTANDING VIDEO TECHNOLOGY

In audio-for-video work there is one ingredient that can never be left out—a clear and integral understanding of video technology and techniques. I have an engineer on staff who has been working as an audio engineer for 15 years and suddenly went to school to study video editing because it made her a better and more creative audio engineer. If a client walks in the door and has to re-edit a video track, you have to know realistically what the capabilities and limitations of that track are. You have to avoid attempting or promising the impossible.

Let's say a video producer comes in with a video tape that has a series of hard cuts. You must know if he is doing a three machine edit, if he's going to have a machine on which his original show is being played, another machine on which new elements are being done, and a machine that is recording. You have to know how this is done and what its impact will

have on your audio track. Without that type of hard knowledge of video, the unexperienced audio producer could take his client up blind alleys.

It is for this and other reasons that the audio engineer/producer must be called in on video projects in the earliest stages possible. In terms of a recent sound production for the Home Box Office (HBO) pilot "Brain Games" (see accompanying sidebar), I was called in to view a rough cut of the video and film before I even started producing the soundtrack and before they even considered finishing their work. The final cut and soundtrack were completed one against the other.

More and more I am noting that the new breed of video producer is relying on audio producers like myself in the earliest stages of production. Onomatopoeia is rarely called in at the last moment to lay down an audio track to the visuals, put it in the can and ship it off to the client. Audio is an integral part of any visual package, and it is being treated as such by many producers.

I am currently working on another project for HBO that begins with a series of very well-crafted animation dissolves. In one part of the animation, a cigarette appears. From my experience, I knew that the sound of a match striking is a fabulous effect. I knew that for the amount of production effort, if you add a match-striking to the scene, it could really

be much better. I made the suggestion and it was incorporated into the animation. Such a consideration couldn't and wouldn't be made had all the footage already been shot.

Audio-for-video is much more than strictly a post-production tool. From my work for clients like HBO, I am noting an increased sophistication about the importance audio plays in the success of the final video product. By 1984, HBO will be broadcast nationwide in stereo. All the sound they are currently ordering is in stereo. Before they approve any videotape to go on-air, it goes through a comprehensive quality control workout, not just for video, but for audio as well. The company is a pioneer in quality sound for video and their success is helping spread the importance of audio to producers for other cable networks, as well as to video producers involved in everything from a/v work to corporate communications.

Producers and executive producers are taking the time and interest in the audio process and they are looking for a facility and an audio professional that can do more than simply follow orders. They want to learn about audio and want someone to show them how audio can improve their products and help make this much talked about audio/video marriage a true give and take relationship. ■

## Braingames

The sound production and post-production of "Brain Games" for Home Box Office (HBO) offers an example of the audio-for-video needs of the contemporary video producer. The 30 minute game show pilot is the product of Eli Noyes Productions and consists of an extended opening and seven different visual and sound teasers designed for the entire family. Each segment is based on a different form of

animation for which Onomatopoeia designed and produced the appropriate score. Directors Noyes and Kit Leybourne recognized the need for an integrated audio/visual experience; they considered the audio elements in the early stages of production. What follows is a segment-by-segment breakdown of the design and recording of the soundtrack for "Brain Games."

### SPHINX (Opening)

Since this scene, depicting the mechanical inner-workings of an Egyptian Sphinx, was to be repeated throughout the program, there was a need for an identifiable and flexible composition. We designed an upbeat and contemporary synthesizer melody that was matched in terms of tempo and texture with the motions and rhythms on the screen. Only through such tight coordination could the viewer obtain an instant identification of the sound to the image. The soundtrack was originally recorded as close to the animation as possible and then vari-speeded in post-production to achieve an identical synchronization.



CAREERS  
IN AUDIO ARTS



"I MIX  
SOUND MAGIC"

NEW, HANDS-ON  
PROFESSIONAL  
CAREER PROGRAM

24 Track Studio Console  
State-of-The Art  
Equipment

Multi-Track Editing & Mixing  
Audio for Film & TV  
Individual Work Stations  
Music Recording Sessions  
Digital Technology

Audio & Recording  
Arts Division

Classes Forming Now!  
**(212) 807-6670**  
Grants and Loans  
Available for Eligible Students

Use this coupon or call

Please send me your Careers Manual and Catalog of courses in Audio and Recording Arts

Name \_\_\_\_\_

Address \_\_\_\_\_ Tel. \_\_\_\_\_

City/State/Zip \_\_\_\_\_

226 WEST 26 ST. NYC 10001 (212) 807-6670

D



## ALIENS

The animation here was done in a computer-graphic style and the attempt, with both the audio and video, was to recreate the design of a computer game. At least from the audio side, there were significant advantages here since video games have severe audio limitations. The sound effects were all synthesizer-produced and the aim in the recording process was to create a richly textured sound that could make the most of even the worst five-inch television speaker. The narration was supplied by comedian Robert Klein, though because of extensive processing through a vocoder, harmonizer and noise gates, there would be no way to identify his voice other than by the production credits at the end of the program.

## EAR PLAY

Since this game depended upon the viewer hearing an unidentified sound prior to its source being disclosed on the screen, the film producer of this segment recorded his own audio track. However, in post-production it became obvious that the sound quality was different from the rest of the soundtrack, producing a disconcerting jolt when viewing the entire reel. The goal here was to achieve continuity of sound, which we accomplished with the right combination of equalization and balancing during the final mixdown.

## FACES

This was a series of different faces which were first distorted by computer graphic techniques and then became recognizable. The goal was, via musical and narration clues, to identify the character (i.e. Deborah Harry) as soon as possible. The music for the various "faces" ranged from the "1812 Overture" to a Blondie sound-alike composition, all of which was pulled from Onomatopoeia's music library. There was some minor customizing added (especially vari-speeding), but otherwise the recording process here was relatively straightforward—though it demanded an extensive library search for both the right musical clue and melody.

## ODD CARD OUT

In this segment, a dealer deals a card-hand out of which the viewer has to pick the odd card out. There were several elements at work here: narration by Lionel Wilson, some Scott Joplin rags, which we recorded with post-record equalization to give it that turn-of-the-century sound, as well as numerous card sound effects. The director/producer himself (Eli Noyes) went into the studio and recorded every card-related sound imaginable—the sound of cards being shuffled, dealt, the sound of cutting a deck, a waterfall, snapping the card on the table, etc. By the time we finished (including all the actions performed on a variety of surfaces), we had 20 minutes of card sounds on tape, each of which I later laid-up against the picture to select the one that sounded best. A project like this would have been impossible without a synchronized system like the one we have in Studio A. By instantaneously synchronizing the audio to the picture in the production stage, as opposed to the post-production stage, I was able to get the proper effect as I went along. If this had been done on film, for example, I would have had to take the effect, dub it to mag, sit there at a flatbed machine (a noisy contraption at best) and, if the sound wasn't right, send the reel out to be processed before we could try it again. The value of working with audio-for-video in the production stage is having the ability to make value judgements as you go along. The job is considerably more creative than simply clean-up.



**MYSTERIOSOS**

This animation began with gyrating and pulsating lines for which a string ensemble was taped on a 24-track recorder and later doctored with synthesizer sound effects. The animation itself was complex in terms of moving from one image to the next, and to achieve the proper audio transitions we had to overlap the music cues. Such production can be tricky. But with the synchronizer, we were able to make each of the cuts tighter than we could have any other way.



the football itself (usually such a dull sounding object) a synthesizer "boing" which worked when paired with the animation. And, of course, there were the cheerleaders. However, our line-up was anything but teenagers with knobby-knees. We improvised our own cheerleaders by rounding up the Onomatopoeia staff, pulling clients out of the other two studios, and letting loose with a mighty "LLOOFBAT" at the top of our lungs.



**LLOOFBAT**

From a standpoint of "building" a soundtrack, the audio for this scrambled-word game was the most challenging. A total of 18 layers of sound were used to create the audio ambience of a football game in action. The sound began with sports commentator Marty Glickman giving a play-by-play from far off-mic' (to give it the on-the-scene stadium ambience). Atop that we built the crowd; there are many types of crowd noises, just as there are many different emotions in a football game: gasps, razzing cheers, hysteria, anticipation. We sent an engineer out to a New Jersey Giants game with a Nagra to supplement the crowd sound effects in our library. There were different sounds from the players: grunts, signals, helmets and shoulder pads crashing. I gave

**BETWEEN THE LINES**

The audio track for this word game was composed of an original composition (in which we buried a related clue) and the narration of former late-night disc jockey Allison Steele (noted for her smokey voice). I am extremely careful about voice recording for television and, because of the timbre of Allison's voice, I took careful precautions that the original recording was perfect. No matter what you do to voices via signal processing, the frequency limitations of the average television speaker don't give you much room to create in. As a result, I always do a lot of experimentation which gives me a healthy selection of takes to lay up against the picture. Whenever I do a voice session, I'll have at least three different microphones in the studio, everything from a U-87 to a ribbon mic'.



# db Convention Report

JOHN M. WORAM

## National Association of Broadcasters (NAB) 61st Annual Convention & International Exposition

**T**HIS REPORT COMES to you from the isle of NAB, a high-tech habitat that surfaced recently in the sea of Las Vegas. Unlike the Loch Ness Monster and Brigadoon, which appear rarely, and never on schedule, NAB's appearances are predictable and well-publicized. In fact, NAB maintains its own embassy in Washington, from which regular bulletins are issued to keep the world informed of its progress in between appearances.

NAB is smaller than Monaco, though not by much. Its tourist season is rather short—just four days, in fact—so its streets are always crowded, as some six thousand visitors descend all at once. There are no hotels or restaurants in NAB, so visitors must make their way back across the sea whenever hunger or fatigue set in.

In the surrounding Las Vegas area, there are what appear to be hotels and restaurants, though these are quite unlike anything in the rest of the world. Check-in counters, elevators, restaurants and such have all been carefully concealed, so as not to intrude on the visitors' view of the slot machines. And if all roads still lead to Rome, here in Las Vegas they all lead to—and through—the casino.

The restaurants here serve something that superficially resembles food, though it certainly doesn't taste like it. And due no doubt to the arid desert air, all traces of alcohol evaporate long before a drink reaches the table. So, if you were thoughtful enough to bring some sandwiches along, and didn't get captured by the one-armed bandits in the casino badlands, you could count on spending a safe and sober few days wandering the carpeted streets of NAB, taking in all the sights...that is, if you could find them. For unlike the United States, NAB appears to issue booth addresses from a random-number generator. Thus, 1432 is just across the street from 1633. This probably makes very good sense to a computer, but it makes finding your destination somewhat of a game of chance. Perhaps it's the Las Vegas influence?

Aside from tourism, NAB's economy is based on broadcast video, although some of its more adventurous citizens have lately gone on to discover radio. Even more recently, a third-world economy known as audio has been noted flourishing here in some unlikely corners.

*John Woram is the editor of db Magazine.*



Figure 1. Sony's prototype CDP-5000 Professional Compact Disc Player.

### SONY/MCI?

In one of these corners, Sony introduced a prototype professional compact disc player. The CDP-5000 is intended for broadcast studios, where it can access any selection on a 60-minute laser disc within two seconds. A search dial permits manual cueing once the selection has been found.



Figure 2. The Sony/MCI JH-110B-3-LB-VP Audio Layback Recorder/Reproducer.

The 5000 may be an elegant solution to a problem that does not exist. Who needs two-second access to a compact disc? Not the top-10 format stations, which only play singles from carts anyway. Here in fun city, classical music station WNCN-FM has been drawing rave reviews with its loaner compact disc system, but it's doubtful that such a station would have the need (to say nothing of the budget) for such a classy piece of hardware. We shall see.

Also in the Sony booth (actually, the MCI/Sony booth) was the JH-110B-3-LB Audio Layback System, which from across the room looked like the familiar MCI JH-110 three-track tape recorder. Three track? No, this is not a return to the old days of left-center-right recording, it's a post-production recorder for the transfer of audio to one-inch type C video tape. The JH's three tracks are for stereo audio plus SMPTE time code.

Other goodies in the MCI/Sony display included the JH-800 broadcast board (reviewed here in *db* last April), and "KMCI," a fully-equipped broadcast production center set up in a 20-foot hexagonal control room designed by Modular Perfection, Inc. of Miami.

### SONY/mci?

Lately, the Sony half of MCI/Sony has been getting the lion's share of attention, as the MCI part quickly submerges into the fine print on the company's ads and press releases. Is a similar fate in store for the product itself? Apparently not, according to industry insiders, who tell us that the MCI identity will soon re-surface. Amen.

### AUDITRONICS/SONY, TOO?

Not quite. However, Auditronics was showing its new RTW Studio Processor Set, which utilizes a modified Sony PCM-F1 Digital Audio Processor along with the RTW to enable digital audio recording on any commercially-available EIAJ video cassette recorder. The RTW incorporates balanced line-level inputs and outputs, headroom optimization, extensive status and error-correction displays, and data translation to the Sony PCM-1610 standard.

Also at the Auditronics booth was the PPEQ Program-mable Parametric Equalizer System. This snappy-looking device contains up to four mono or stereo three-band

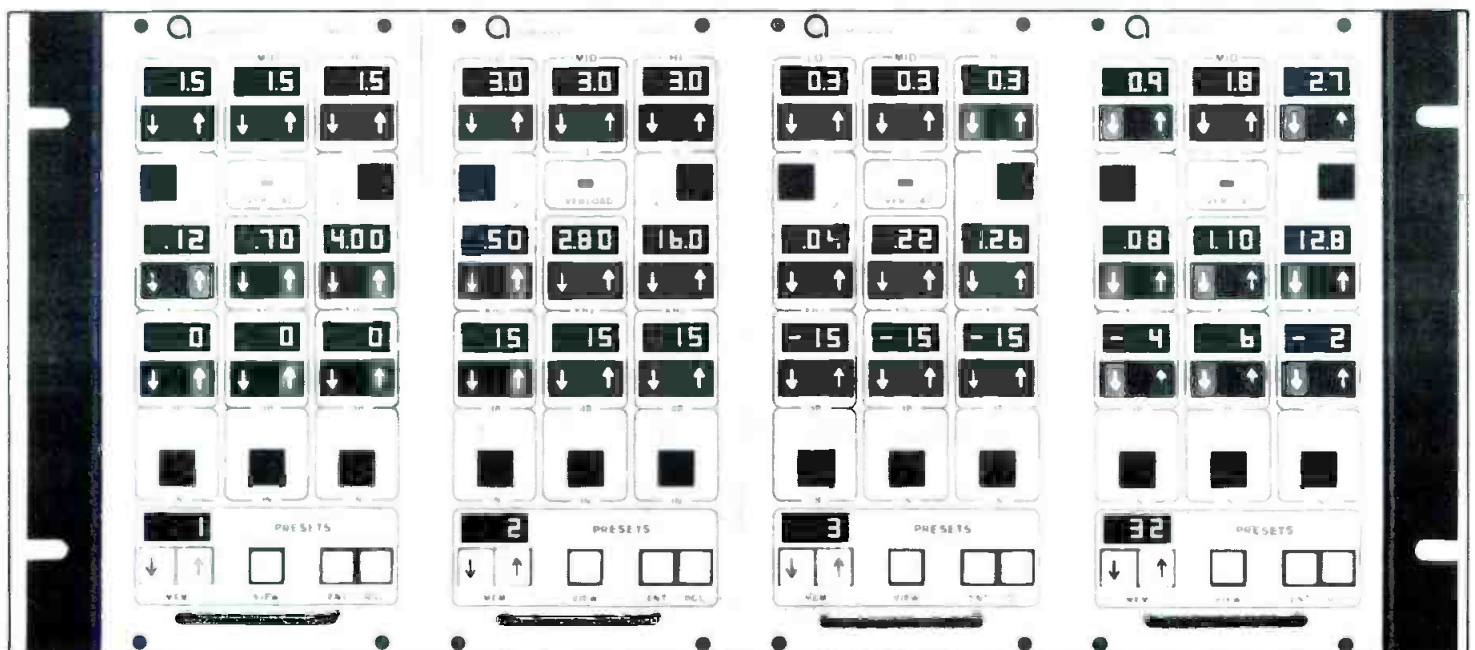

Figure 3. Four Auditronics' PPEQ-1 equalizer modules are seen here in a 19-inch rack-mount panel.

parametric equalizers, each with variable Q, frequency selection, and boost/cut. The high and low bands also include a choice of peak or shelving equalization. Each module contains 32 non-volatile memories and may be programmed and/or sequenced from an external computer or editor. Needless to say, all parameters are software-controlled, and an optional remote control is available.

#### BROADCAST TECHNOLOGY

The SP-9510 Signal Processor from Broadcast Technology, Inc. is a DC-controlled ten-band graphic equalizer offering



Figure 4. The front panel layout for Broadcast Technology's SP 9511 ten-band signal processor.

manual and dynamic equalization, as well as "parametric bounding."

The easy stuff first—manual equalization is just what you think it is. Next, in the dynamic cut or boost modes, one or more frequency bands may be reduced or increased as the level increases beyond the threshold. The parametric bounding section is controlled by a side chain that provides hard limiting within each frequency band, at a threshold which may be pre-set by the user.

#### SOUNDCRAFT

At the Soundcraft booth, the company's new Stereo On-Air broadcast board made its debut. It's still too early for a spec sheet, but the board shown here had 14 inputs in the



Figure 5. Soundcraft's new On-Air Broadcast Console.

following configuration: turntables (2), tape (2), news (1), phone (1), microphone (2), carts (6). A built-in sequencer will sequentially start any number of machines as required. Thus, a complete commercial break could be cued up and remotely started, with the last action starting a turntable. Turntable channels turn on slightly slower, to allow the turntable to get up to speed. The console is interfaced to external devices via a bi-directional, opto-isolated, universal

machine interface that will work with all type of logic.

Soundcraft's U.S. general manager Betty Bennett passed on the word that the company was about to move into a new office in Santa Monica. (See the directory at the end of this report for the details.)



Figure 6. The Seck Producer.

#### THE SECK PRODUCER

There's nothing fiddly, twee or sloppy here. Or so the spec sheet for the diminutive Seck production mixer assures us. (F, T and S are no doubt British technical terms.) The Seck Producer should appeal to anyone looking for a compact two mic/four-stereo-input mixer for small-scale production work.

#### MICROPHONES

Electro-Voice's new RE34 is a cardioid line-level condenser microphone. Actually, the output is switchable between line and mic' level, and there's a built-in limiter besides. (The RE34 is intended for remote ENG/EFP applications, and in a pinch may be used with unshielded twisted-pair cable.)



Figure 7. Electro-Voice's new RE34 Cardioid Line-Level Condenser Microphone.



Figure 8. The Neumann 81i 9-inch Shotgun Microphone.

Neumann's new KMR81i shotgun microphone, seen at the Gotham Audio booth, is also recommended for ENG applications. For more details, see our "new microphone section" in next month's *db*. The preliminary specs indicate that its pattern is close to super- or hyper-cardioid, and that the mic' is relatively insensitive to wind and popping noises.

#### OTARI

The company's new Universal Resolver is a multi-purpose speed controller which may be used with any audio tape



Figure 9. The Delta series of broadcast cartridge machines, from 3M ITC.

recorder having a DC servo motor or a motor drive amplifier. Intended for film and video interface applications, Otari's Steve Kramph bills it as the company's first step towards extending the intelligence of tape recorders for audio/video production. The system will lock the transport's speed control track over a  $\pm 30$  percent speed range, and may be referenced to the AC line, composite video, SMPTE EBU time code or other external source.

Otari also announced that their MTR-10 two channel tape recorders may be retrofitted with the appropriate heads and delay electronics for conformance to the new IEC standard for center-track SMPTE time code recording. Further details about the availability of retrofit kits will be forthcoming.

#### A FRIENDLY NON-POLITICAL LIMITER FROM UREI

The new model 1B International Broadcast Limiter has been designed for broadcasters using the international

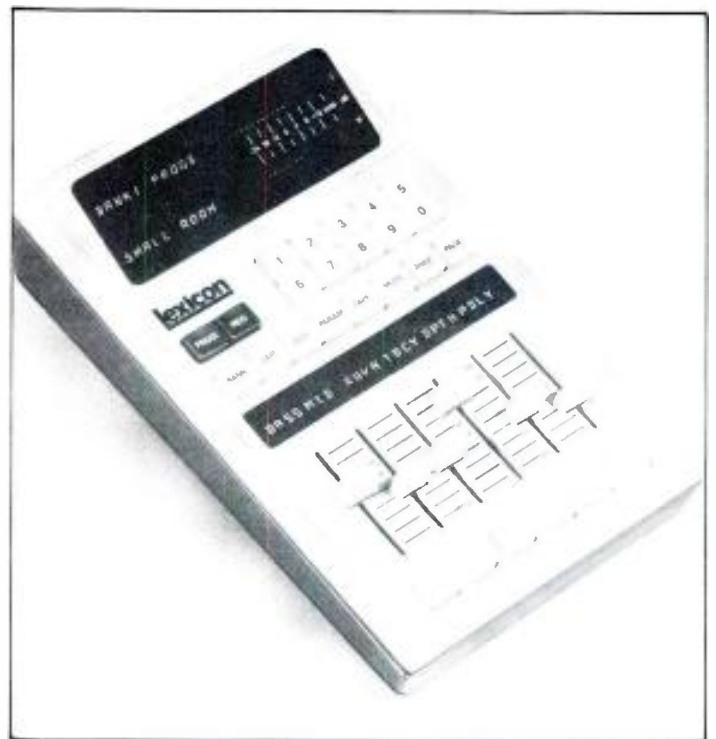

Figure 10. The Lexicon LARC remote control for the 224X Digital Reverberation System.

bands. The device is an outgrowth of a joint development project between UREI and USIA (United States Information Agency). According to a UREI preliminary spec sheet, the 1B is "...available to agencies of friendly governments and non-political organizations, to help these broadcasters to reach the largest possible portion of our planet's population." Skimming the specs, the 1B signal path begins with an input section where the low-frequency content of politically acceptable messages is filtered, and frequencies above 6 kHz are eliminated ( $-60$  dB @ 8 kHz). A high-frequency boost centered at 4.3 kHz is included to improve intelligibility and brighten the message. A fast peak-limiter section follows, after which the signal is amplified to line level, low-pass filtered, and routed through a final protection clipper.

#### ITC/3M

3M's ITC (International Tapetronics Corp.) subsidiary introduced its new line of Delta series NAB cartridge players and recorders. Due to one-third reduction in size, any three modules may be placed side-by-side within a standard 19-inch rack space. The series features crystal-referenced, DC brushless capstan motors, with ceramic capstan shafts. High-speed re-cue is standard in all models.

#### LEXICON'S FRIENDLY REVERB

Lexicon's newest bird is the LARC—the Lexicon Alphanumeric Remote Console, a remote control unit for the 224X Digital Reverberator System. Six soft keys across the

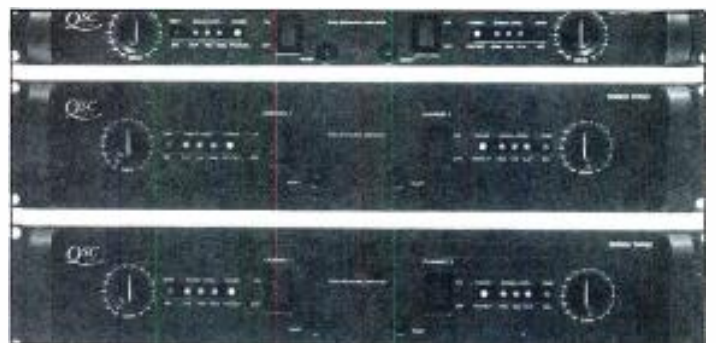

Figure 11. QSC's series Three power amplifiers.

bottom of the unit take on various assignments, depending on programming. Above each key, a companion slide fader adjusts the whatever-it-is-at-the-moment. Above each slider, a four-character display tells you what's going on. Thus, for a small room reverberation program, the display might tell you that the six faders are controlling bass, mid and crossover frequency, decay time, depth, and pre-reverb delay. Change to a different program, and the display will indicate the new assignments for the faders. The LARC is available as a retrofit, or as an option with new 224X systems.

#### QSC AMPS

The QSC series three amps look good—especially from the rear, where there are all sorts of input and output connections. Each output appears on five-way binding posts and a barrier strip. Inputs are via barrier strip, balanced quarter-inch phone jack or female XLR connector. There's also an octal input module socket for adding active or passive input accessories. As final insurance against Edsel Murphy, there's a back-panel ground lift strap (barrier strip) between circuit and chassis ground for control of ground loops.



Figure 12. The Studer A810 quarter-inch four-speed tape recorder.

#### ALL THIS, AND CHOCOLATE TOO!

When asked what was new at the Studer booth, a company spokesman nonchalantly said, "Oh, not much this time." Clearly, this was some sort of cover-up. It turns out that Studer was giving away free samples of Swiss chocolate to all broadcasters, as part of its campaign to draw attention to the company's Swiss origins. Sharing the spotlight with the chocolate, the A810 quarter-inch, two-channel recorder made its debut in a four-speed production version. The A810's microprocessor system will set and store audio alignment parameters for several tape formulations, and a set of three soft keys may be programmed by the user for various operating functions. ■

## Directory of Manufacturers

#### Auditronics, Inc.

3750 Old Getwell Road  
Memphis, Tennessee  
(901) 362-1350

#### Broadcast Technology, Inc.

33 Comac Loop  
Ronkonkoma, New York 11779  
(516) 588-6565

#### Electro-Voice, Inc.

600 Cecil Street  
Buchanan, Michigan 49107  
(616) 695-6831

#### International Tapetronics Corp.

2425 South Main Street  
Bloomington, Illinois 61701  
(800) 447-0414 & (309) 828-1381

#### Lexicon, Inc.

60 Turner Street  
Waltham, Massachusetts 02154  
(617) 891-6790

#### MCI/Sony

1400 West Commercial Boulevard  
Fort Lauderdale, Florida 33309  
(305) 491-0825

#### Neumann

c/o Gotham Audio Corp.  
741 Washington Street  
New York, New York 10014  
(212) 741-7411

#### Otari Corporation

2 Davis Drive  
Belmont, California 94002  
(415) 592-8311

#### QSC Audio Products

1926 Placentia Avenue  
Costa Mesa, California 92627  
(714) 645-2540

#### Seck Producer

c/o Connectronics  
652 Glenbrook Road  
Stamford, Connecticut 06906  
(203) 324-2889

#### Sony Communications

Sony Drive  
Park Ridge, New Jersey 07656  
(201) 930-6145

#### Soundcraft, Inc.

1517 20th Street  
Santa Monica, California 90404  
(213) 453-4591

#### Studer Revox

1425 Elm Hill Pike  
Nashville, Tennessee 37210  
(615) 254-5651

3M/ITC (see International Tapetronics Corp.)

# Boundary Displacement Recording

*Boundary Displacement Recording (AKA Variable Area Recording) is an often overlooked method of magnetic tape recording. Here, author Morrison gives an overview of this neglected practice, pointing out the pluses and minuses inherent in its usage.*

**T**HE PURPOSE OF THIS brief article is simply to print out an alternate, and for the most part, neglected method of magnetic tape recording.

There are "virtues," and, of course, "evils" inherent in the method, and we will briefly discuss them. We should say at the beginning that the basis for this discussion has been noted many years ago in the literature, along with discussions of DC recording, and it is neither a new invention nor an unknown process. We have personally experimented with it over the last twenty years, more for fun than for any legitimate reason. It is hoped that others may be stimulated to further examine possible uses.

## BACKGROUND

The magnetic sound recording process in use these past thirty years or more has commonly consisted of magnetic record heads and associated amplifiers capable of producing tape records having magnetized "bars" at right angles to the tape edge. The degree of magnetization of these bars determines the relative output, and the spacing between bars reflects the signal's wavelength.

To insure the best overall signal, equalization and AC bias are normally employed. The record head is designed in such a way as to produce the variable-density pattern on the tape as shown in FIGURE 1A. The pattern may be made visible by means of indicator fluid or a magnetic viewer, and it will appear similar to old (now obsolete) variable-density optical motion picture sound tracks. In fact, a photographic record of a variable-density magnetic tape (made visible with indicator fluid) could be played by means of an optical sound head with light source and photoelectric cell (an impractical

option, only included for comparative purpose).

We have noted that conventional variable-density magnetic recording consists of bars of oxide recorded at different degrees of magnetic strength. We call the degree of magnetization of the recording the fluxivity and express it in terms of nanoWebers/meter. It is common to record program material at a fluxivity reading providing sufficient headroom from saturation. In density recording, we avoid saturation like the plague.

By contrast, Boundary Displacement Recording operates with the tape medium at saturation at all times. This is important to remember when we consider the noise problems with DC recording, and we will want to carefully choose the level of modulation to provide the best signal-to-noise figure, with an acceptable allowance for headroom. The linearity of the system does not depend on the same characteristics of the tape as in the case of density recording, because the maximum remanence is held constant during recording. To put this another way: A tape found to be poor for variable-density recording may be the best option in variable-area recording.

## BASIC BOUNDARY RECORDING

To understand one format of boundary displacement recording (there are several), we may visualize a saturated recording where the entire surface of the tape is magnetized to the maximum by means of a record head having a permanent magnet, or battery-excited field coil energizing one entire pole piece of the record head. Since the permanent magnet or DC excited field coil will have a north-to-south polarity, the center of the tape will have a neutral zone (where north and south oppose) running exactly down its center, the length of the tape. We are considering here, for



sake of simplicity, full-track quarter-inch tape and full-track heads. Multiple-track arrangements can be accomplished with appropriate head designs.

If we view such an unmodulated tape, the neutral zone will be a "white" line as shown in FIGURE 1B—something like a bias line in area photographic recording. Now, if we have a voice coil wound about the other pole piece, and energize it in the normal manner, the AC current representing the audio will cause the neutral zone to be displaced, producing a waveform just as you would see on the face of your oscilloscope. Here we have two halves of a track saturated in opposite magnetic directions, except for the boundary or neutral zone. When audio signals are supplied to the voice coil, the area proportions are changed. This proportional change of flux will produce a signal when reproduced by means of a conventional magnetic playback head.

We have described one type of boundary displacement record head, which is simply a head with only one signal coil wound around one pole piece, and the other pole piece magnetized by means of a magnet or DC coil, with two iron bars positioned at the top and bottom of the pole piece. Other schemes can include a moving mechanism (transducer) such as used in disk cutting equipment to physically move a magnetized member as driven by audio information.

A different sort of non-mechanical record head, with which we have been experimenting, employs a "center feed" record core arrangement which produces a recorded magnetic pattern appearing somewhat like a bilateral variable-area photographic track. (The results of these attempts may be of interest when described in a future article.) The analogy between magnetic density and boundary displacement follows to a great degree the differences between the two in motion picture application. For example, photographic density recording requires extremely careful

laboratory control, while area recording is usually recognized to have greater latitude in processing. In the case of magnetic recording, the latitude of the tape characteristics is greater in the case of boundary displacement recording—as would be the case in the processing requirements for variable-area film.

In variable-density recording, the gap length of the record stack may be quite long in comparison to the playback head. This is because most of the effect-controlling short-wavelength record capability is accomplished by one side of the gap. In boundary displacement recording, the record gap must be *short*—to provide adequate top-end recording. As an example, our experimental record heads now use 80 micro-inch gaps and allow very good bandwidth capability at slow tape speed (3.75 ips and below).

The maximum record level in a boundary displacement system is determined by the allowable modulation of the boundary. It cannot, of course, be allowed to swing outside the track width being scanned by the playback head. An interesting example of this requirement occurred several years ago when the writer gave a full-track quarter-inch sample of some boundary recordings to an engineer friend. The tape contained voice and music tests. He played the tape on a two-track stereo machine, but because the tape was labeled "mono," he played only the left channel—which sounded awful. He then switched on the right channel and the combination sounded "just like a normal 15 ips recording of voice and music." The effect of playing one side of the track was much the same as pulling out one tube of a push-pull amplifier.

The overall audible quality of boundary displacement recording has been demonstrated to be quite acceptable when reproduced on a normal reproduce channel with normal NAB equalization.

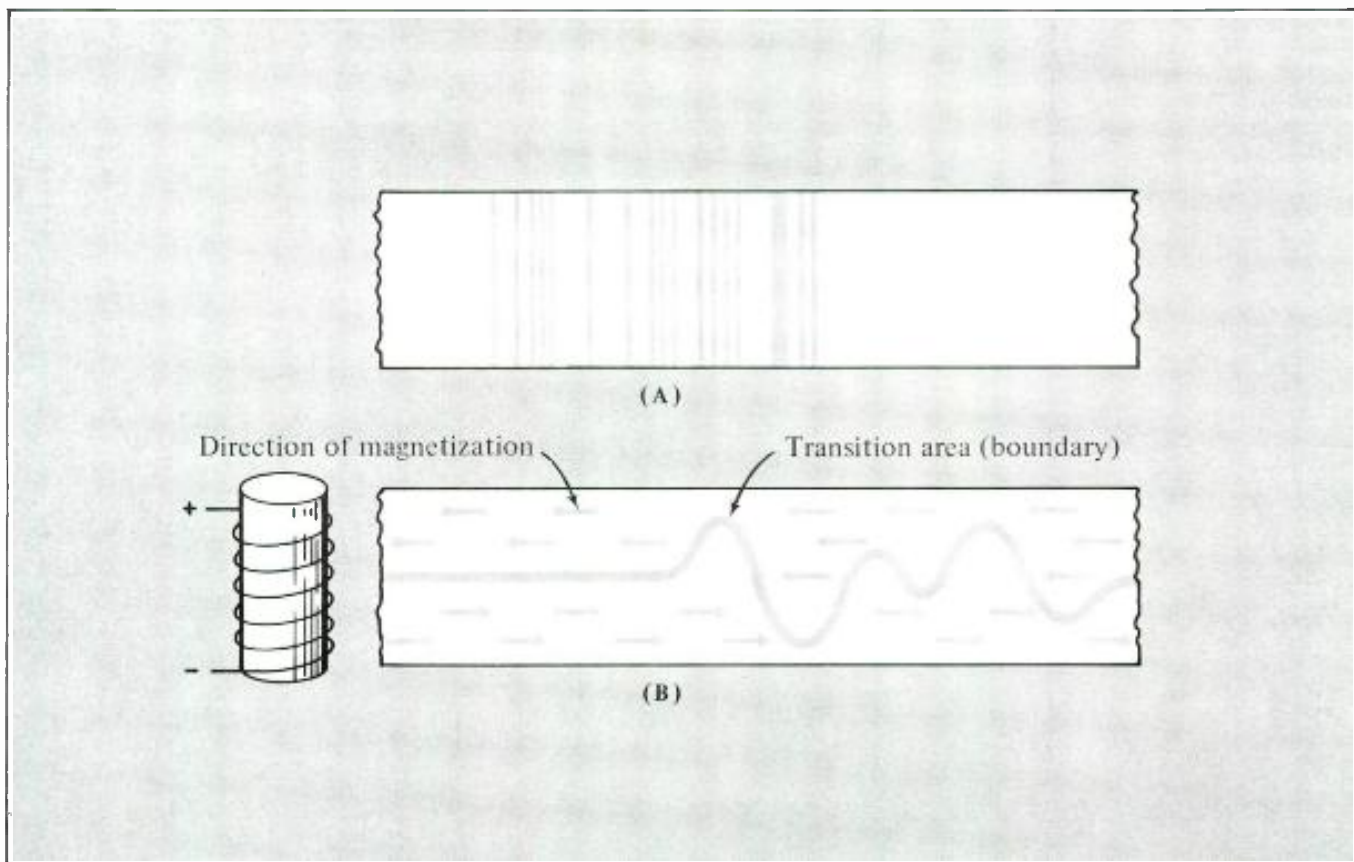

Figure 1. Conventional variable-density recording (A) and variable-area recording (B).

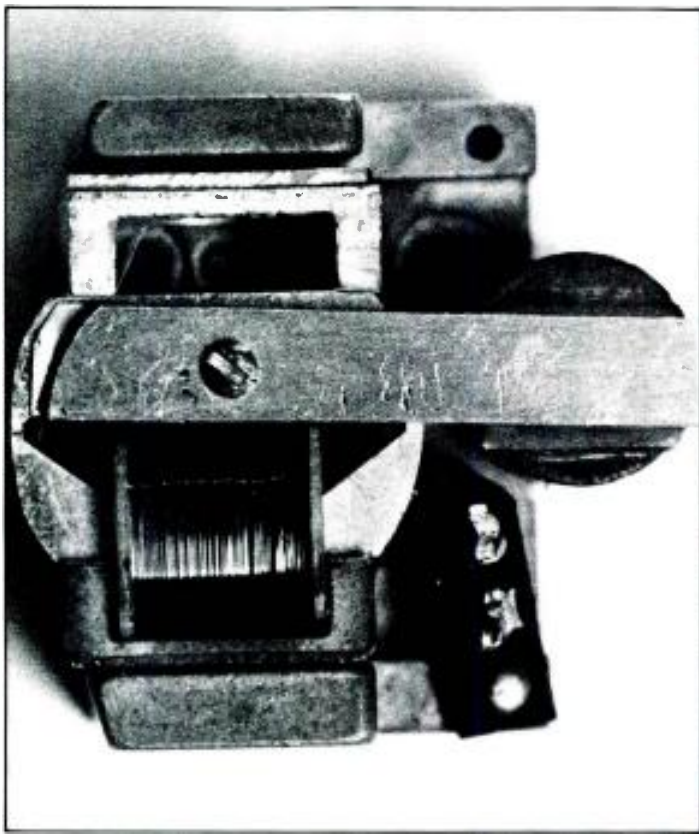

Figure 2. Close-up view of the special permanent-magnet recording head used for variable-area recording.

#### JUSTIFICATION (IF ANY) FOR BOUNDARY DISPLACEMENT RECORDING

Since no AC bias is used, simplified circuits can be used. In the simplest configuration, an almost "non-electric" system could be devised. A mechanical "wind-up" transport with a PM-excited record head could be voice-coil driven with a sound-powered microphone. Such an instrument could be useful where it is desirable to avoid detection of bias current by certain anti-recording detectors. The desirability of the above feature may depend on whether one is in the category of the "snooper" or the "snoopee."

In the case of the PM-excited head, the recorded tape must be removed from the record head tape path, thus preventing any erasure of the recorded track during subsequent reproduction.

#### SUMMARY OF THE BASICS OF BOUNDARY DISPLACEMENT RECORDING

Conventional magnetic record head pole piece assembly. Coils differ thusly:

Only one signal or voice coil is wound around *one* side of the core.

The other side of the core has iron strips top and bottom which are energized by permanent magnet or field coil (see FIGURE 2).

The permanent magnet or field coil is used to saturate the tape. When this occurs, a neutral zone, halfway between the positive and negative poles, results. When observed via magnetic indicator fluid or magnetic viewer, the tape will appear black, i.e. saturated except for a narrow white line down the middle of the tape track where the positive and negative fields oppose. During the recording process, when speech or other program material is fed to the voice coil of the record head, the neutral or "white" zone will be displaced according to frequency and amplitude. The result appears similar to an oscilloscope pattern or audio frequency material.

#### PECULIARITIES OF BOUNDARY REPLACEMENT RECORDING

- (1) No AC bias is employed, therefore no RFI radiation.
- (2) System operates at saturation.
- (3) Produces even-order as well as third-harmonic distortion.
- (4) Noise greater than variable-density recording.
- (5) Record head gap length more critical than in normal system.
- (6) The reproducer head while conventional in every respect must be of the same track width as the record head, otherwise the wave form will be clipped, with resultant distortion, just as in optical variable area systems.
- (7) As recordings are at saturation, the requirements for erasure must be considered, and may be considered an advantage or disadvantage, i.e. accidental or deliberate obliteration of recorded information. ■

## Distortion and Signal-to-Noise Measurements

#### Conditions:

1. Playback electronics set to NAB 50 microsecond curve. Playback and record speed 7.5 ips.
2. Amplifier gain first set to produce zero level from a conventional 185 nWb/m test tape of the variable density type. (1 kHz tone)
3. Overall measurements made with permanent magnet head in record and standard 100 microinch playback head. Both cores 136 mils full track.

#### Distortion at 1 kHz and 10 kHz

Level equivalent to level obtained from 185 nWb/m normal density recording.

	<i>second harmonic</i>	<i>third harmonic</i>
at 1 kHz	1.3%	0.25%
at 10 kHz	1.2%	0.30%

Level 10 dB above the reference, i.e. a level equivalent to 585 nWb/m for a normal density recording.

at 1 kHz	1.3%	0.30%
at 10 kHz	1.2%	0.30%

Note that the practical distortion remains essentially the same for the two levels employed in the tests. However, the higher level represents approximately 80 percent modulation of the track, and as headroom for a useful dynamic range must be considered for conventional analog recording of music, an adequate headroom of at least 12 or 15 dB should be maintained.

For any coded signals having near zero dynamic range requirements, a level near maximum modulation could be employed.

NOISE: When measuring from the level equivalent to the 185 nWb/m reference, unweighted noise is approximately -44 dB. This is, of course, considerably worse than in the case of normally biased recording.

#### BIBLIOGRAPHY

"Magnetic Recording Techniques." W. Earl Stewart. Pg. 25, 26, 27. McGraw-Hill, 1958.  
Stewart, W. Earl. *Magnetic Recording Techniques*. New York: McGraw-Hill, 1958.

# New Products

## 8 WATT AMPLIFIER

• The Ampak 8 is a compact, professional 8 watt (continuous) amplifier. The Ampak 8 is particularly useful on outside broadcasts where monitoring by speaker is necessary and equipment space is of prime concern. In the studio/control room, the Ampak 8 can be used as a fold back amplifier or to drive several sets of headphones. The unit can be supplied balanced or unbalanced, is AC powered and has a signal-to-noise ratio greater than 100 dB. Total distortion is less than 0.05 percent and frequency response is flat from 20 Hz to 30 kHz.

Mfr: Audio + Design Recording, Inc.

Price: \$140.00

Circle 37 on Reader Service Card

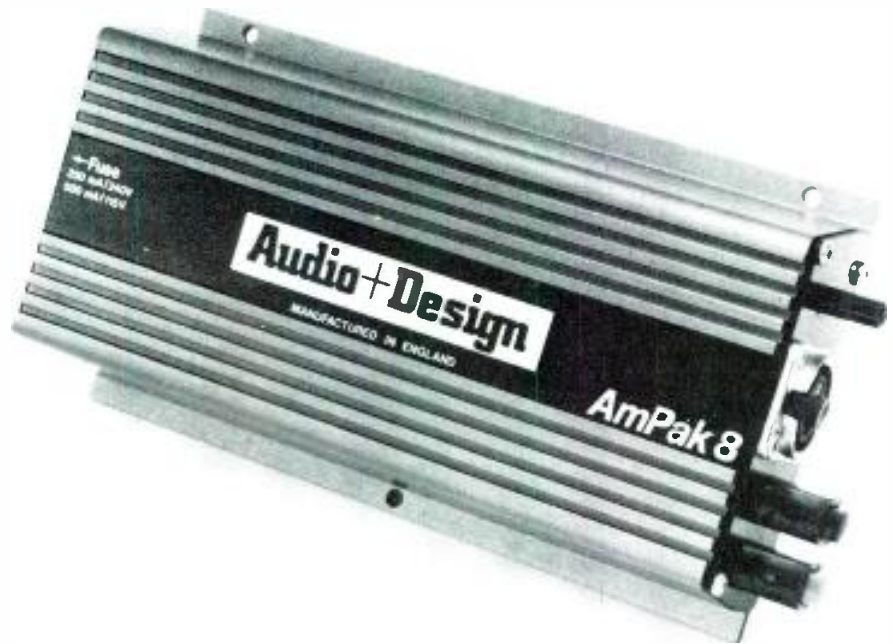

## Looking for a Distortion Analyser?

Check the little guy on the right...

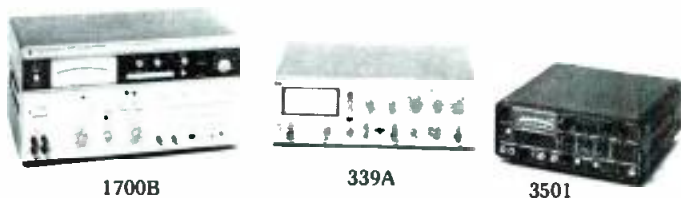

1700B

339A

3501

... the highest performance, most featured and easiest to use audio distortion and noise measurement system in the industry. (and at the lowest price)

Amber Electro Design Ltd.  
4810 Jean Talon West  
Montreal Canada H4P 2N5  
Telephone (514) 735 4105

**amber**

	Sound Technology 1700B	Hewlett Packard 339A	Amber 3501
Automatic Set Level	YES	YES	YES
Automatic Null	YES	YES	YES
IMD: SMPTE, DIN CCIF/IHF	YES* NO	NO NO	YES* YES*
Frequency Range	7kHz fixed	—	2kHz-100kHz
Quantity of Filters	2	3	4
Filters user changeable	NO	NO	YES
Differential Input	YES	NO	Option
Continuous frequency tuning	NO	NO	YES
Calibrated output attenuator	NO	YES	YES
Input Monitor	YES	NO	YES
Selective voltmeter mode	NO	NO	YES
True rms meter	NO	YES	YES
Battery operation	NO	NO	Option
Options field installable	NO	NO	YES
Residual distortion 1kHz 100kHz	<0.002% <0.1%	<0.0018% <0.032%	<0.0008% <0.006%
Residual noise (80kHz BW)	<8µV	<8µV	<2µV
Maximum output	3V	6V	12V
Minimum input THD mode	100mV	30mV	30mV
Auto-null time	<6 secs	not spec	<2 secs
Voltmeter sensitivity (F.S.) extended mode	3mV/-50dBm 30µV/-90dBm	1mV/-60dBm NONE	1mV/-60dBm 1µV/-120dBm
Size (cubic feet)	1.0	1.0	0.4
Weight (pounds)	16	18	12.5
Price with IMD (*option)	\$2650 \$3625	\$2450 —	\$2100 \$2800

Circle 60 on Reader Service Card

## DE-ESSER

- The Model 536A two-channel De-Esser features the same circuitry as the single-channel 526A. However, a lower price results from improved packaging and the elimination of the mic' level input found in the 526A. The 536A has circuitry to provide constant de-essing with input levels that vary as much as 15 dB. De-essing is adjusted with a single THRESHOLD control per channel. Dual LEDs provide accurate indication of de-essing action. A click-free in/out switch allows de-essing to be introduced at any time during the program without audible side effects. Active balanced inputs and outputs are standard, with a transformer output option available.

*Mfr: Orban Associates, Inc.*

*Price: \$539.00*

**Circle 40 on Reader Service Card**



## RECORDING AND PRODUCTION CONSOLES

- The compact 8X Series recording and production consoles are intended for 8-24 track recording studios and video editing rooms. Features of the \*X Series include 3 band sweepable equalization, HPF, stereo monitoring, 4 mixdown effects sends, phase reversal switches, phantom powering, and assignable direct outputs. An unusual feature is the Super Solo section: this

includes solo switching for pre and post fader, tape return and bus outputs to ease record and mixdown operation. In addition, all mic', line and return inputs are electronically balanced, as are all bus and direct outputs, stereo masters, effect sends, control room and studio outputs. The 8X is also capable of sub-grouping without the use of VCAs. Standard features include the M104

conductive plastic fader, a 20 Hz to 20 kHz oscillator, full control room and studio listening function, headphone jack, and talkback slate switching. The 8X is available with or without built-in patch bay and is available with 8, 16 or 24 track VU or LED metering systems.

*Mfr: Audioarts Engineering*

**Circle 41 on Reader Service Card**



**STAGE MONITOR MIXER**

• The Series 310 Stage Monitor Mixer is modular and plug-in for ease of maintenance and is built in frame sections holding six modules so that it is readily expandable from 12 to 42 inputs: it makes 8 output mixes plus a side-fill pair with send and panpots. In the 310, each send has an in/out button and a pre/post equalizer button. New features include transformerless input for cleaner sound; four equalizers (two tunable with wide/narrow switch); high- and low-frequency cutoffs; five

level LED indicators on each input, for instantaneous identification of changes; solo to operator's monitor, to permit checking each input; master solo, to check outputs; 10-segment LED level indicators on master and operator's monitor; 6 dB panic buttons on outputs; built-in mic' splitters, to permit microphones to feed another mixer at the same time, and the usual input pads, phase reserve and on/off switches.

*Mfr: Interface Electronics*  
*Price: \$7,000.00 for 18 in., 10 out*  
**Circle 42 on Reader Service Card**



**COMPRESSOR/LIMITER**

• The CL-150 Compressor/Limiter incorporates a unique signal detection system known as Fast RMS™ detection. This proprietary system exhibits the advantages of both peak and RMS detection methods. While performing attack times as fast as 120 dB per millisecond, to limit fast transients, the CL-150's Fast RMS circuitry also performs RMS detection on slower transients and low-frequency signal components. The result is low transient distortion and more natural sounding

compression. The control features on the CL-150 include variable threshold, attack, release, compression ratio, and output gain. In addition, an automatic attack/release circuit may be switched in for program controlled, automatic attack/release functions. Two CL-150s may be interconnected for master/slave stereo operation. The unit is supplied with both electronically balanced input and outputs as standard features.

*Mfr: Symetrix*  
*Price: \$329.00*  
**Circle 43 on Reader Service Card**



In general, spring reverbs don't have the best reputation in the world. Their bassy "twang" is only a rough approximation of natural room acoustics. That's a pity because it means that many people will dismiss this exceptional product as "just another spring reverb". And it's not. In this extraordinary design Craig Anderton uses double springs, but much more importantly "hot rods" the transducers so that the muddy sound typical of most springs is replaced with the bright clarity associated with expensive studio plate systems.

Kit consists of circuit board, instructions, all electronic parts and two reverb spring units. User must provide power (±9 to 15 v) and mounting (reverb units are typically mounted away from the console).

**CHARGE TO VISA OR MC TOLL-FREE**  
**1-800-654-8657 9AM to 5PM CST MON-FRI**

DIRECT INQUIRIES TO  
**PDA Electronics, Inc.**  
 Dept. 3d, 1020 W. Wilshire Bv. Oklahoma City, OK 73116 (405) 843-9626

Send the 6740 REVERB KIT \$59.95 plus shipping (\$3) enclosed or charged.  
 Send Free Catalog

name \_\_\_\_\_  
 address \_\_\_\_\_  
 city \_\_\_\_\_ state \_\_\_\_\_ zip \_\_\_\_\_

**Circle 36 on Reader Service Card**

**Audio Tape**  
 for professionals



**REEL TO REEL TAPE**  
 Ampex, 3M. All grades.  
 On reels or hubs.

**CASSETTES, C-10—C-90**  
 With Agfa, TDK tape.

**LEADER & SPLICING TAPE**  
**EMPTY REELS & BOXES**  
 All widths, sizes.

**Competitive!**  
**Shipped from Stock!**

Ask for our recording supplies catalog.  
**Polyline Corp.** 312/298-5300  
 1233 Rand Rd. • Des Plaines, IL 60016

15  
**Circle 38 on Reader Service Card**

### HEADPHONE TRANSCIVER

• The Easy Talk featherweight transceiver features a comfortable headband and adjustable boom mic' that lets two or more people communicate up to a range of ½ mile. As the user speaks, the voice automatically activates transmission and then reverts to standby mode to receive messages. The boom-mounted mic' may be adjusted for optimum placement while a foam windscreen shields out high winds or ambient noise. The power pack (about the size of a pack of cigarettes) can be easily clipped to a belt. A voice-activated sensitivity switch adjusts for all outside noise conditions, and a continuously variable volume control allows the user to fine tune the earphone volume. There is also an optional push-to-talk button that will override the VOX system, allowing the user to transmit manually.

*Mfr: Advanced Videotech Corporation*

*Price: \$89.95*

**Circle 44 on Reader Service Card**

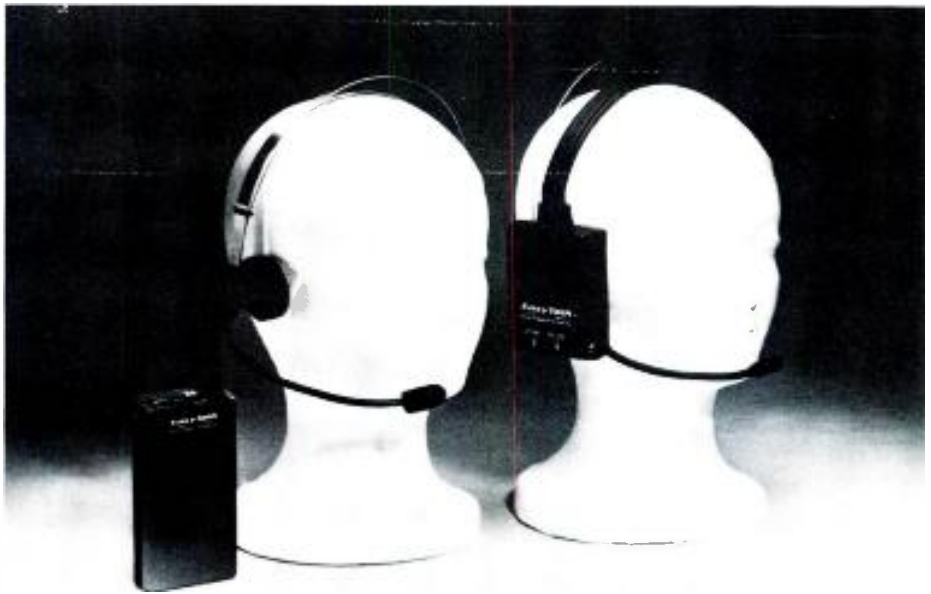

---

## New Literature

### SPEC SHEETS

• A new brochure has recently been published by JRF Magnetic Sciences. The brochure, actually a folder containing a set of eight spec sheets, explains in detail the type of recording heads and the relapping services available from JRF. The recording heads described by the spec sheets cover the firm's studio mastering series, beginning with 2- and 4-track ½ inch heads, an 8-track 1 inch head, and 16- and 24-track 2 inch heads. Also included are descriptions of high speed tape duplicating and master playback heads. A free copy of this brochure is available by contacting JRF Magnetic Sciences, 101 Landing Road, Landing, NJ 07850.

### VIDEO/FILM EQUIPMENT RENTAL CATALOG

• A free Rental Catalog listing over 1000 items essential to film and video professionals is now available from Image Devices International. Categories include 35mm, 16mm, broadcast one inch, ¾ inch and ½ inch video. High-speed and underwater film cameras, camera accessories, tripods, dollies and helicopter mounts, and sound equipment are just some of the items included in this 68-page catalog. Many of the items are also available for sale. For free copies, contact: Image Devices International, 1825 NE 149th Street, Miami, FL 33181.

### NEW BUYERS GUIDE

• The 1983 Professional Buyers Guide has recently been published by SIE Publishing. This revised and expanded edition lists a complete range of products from over 70 manufacturers of p.a. and recording equipment, represented by product photos, model numbers, features, specs, prices and a cross-referenced index. In addition to listing complete product information, the book carries each manufacturer's address, phone number and person to contact. The 1983 Pro Audio Buyers Guide is now available for \$9.95 from SIE Publishing, 31121 Via Colinas, Suite 1003, Westlake Village, CA 91362.



# Classified

Closing date is the fifteenth of the second month preceding the date of issue.

Send copies to: Classified Ad Dept.  
db THE SOUND ENGINEERING MAGAZINE  
1120 Old Country Road, Plainview, New York 11803

Minimum order accepted: \$25.00  
Rates: \$1.00 a word  
Boxed Ads: \$40.00 per column inch  
db Box Number: \$8.50 for wording "Dept. XX," etc.  
Plus \$1.50 to cover postage

Frequency Discounts: 6 times, 15%; 12 times, 30%

ALL CLASSIFIED ADS MUST BE PREPAID.

---

## FOR SALE

---

24 Channel-MCI-Multitrack Recorder, Model JH114, late Serial number, like new, with Autolocator III \$22,500 or best offer; also Synchronizer w/Time-Code-Generator/Reader to synchronize JH114 w/Video-Tape Recorders for \$6,000. Call (312) 872-1665.

THE LIBRARY... Sound effects recorded in STEREO using Dolby throughout. Over 350 effects on ten discs. \$100.00. Write The Library, P.O. Box 18145, Denver, CO 80218.

FOR SALE: SCULLY 284-B 8-TRACK little used. Make offer or \$5,200 takes it. QUANTUM 128 12 x 8 CONSOLE in producer's cabinet. \$3,200. Thelen Advertising, MN (612) 253-6510.

De Mideo Console. 24 x 8 x 2, Hi/Lo EQ. Solo. 1 EFX Send, 24 Meter/Monitor with 2 Cue Sends. \$10,000. Call: FRITZ at RECORD PLANT STUDIOS (212) 581-6712.

Ampex 300-4 multitrack recorder with audio electronics and sel-syn capabilities. Well maintained and good condition. Asking \$800. Call TIM at (612) 721-2481 aftns.

TECHNICS TURNTABLES IN STOCK! AKG, Neumann, UREI, Orban Eventide, dbx, Lexicon. Best pro-audio equipment. Lowest prices. IMMEDIATE DELIVERY. UAR Professional Systems. (512) 690-8888.

## DIRECT FROM BROADWAY

—

### USED SOUND EQUIPMENT SALE

—

**PETER PAN • FIDDLER • CAMELOT  
KING & I • CHORUS LINE • DOLLY**

**Wireless Microphones  
Used By The Stars**

**AMPS • MIXERS • RECORDERS**  
*all guaranteed*

**SOUND ASSOCIATES, INC.**  
424 WEST 45 ST. • N.Y., N.Y. 10036  
TELEPHONE 212-757-5679

MICROPHONES. Immediate delivery via UPS. All popular models in stock. Best prices you'll see in '83: PLUS we pay freight. UAR Professional Systems, 8535 Fairhaven, San Antonio, TX 78229. (512) 690-8888.

USED RECORDING equipment for sale. Dan (415) 441-8934.

FREE 32pg Catalog & 50 Audio/Video Applic.

PHONO, MIC,  
TRANS, ACN  
TAPE, VIDEO  
LINE, OSC

PWR SUPP. EQ

Stereo Mono Pwr Ampl. 8-in 2-out, 12-in 4-out, 18-in 4-out

Video & Audio Dist Ampl. TV Audio & Recd Prod Consoles

**OPAMP LABS INC (213) 934-3566**  
1033 N Sycamore Av LOS ANGELES CA, 90038

PRO AUDIO IN STOCK—ready to ship. Top lines, top dollar trade-ins, clearance specials. Call or write for our prices. Professional Audio Video Corporation, 384 Grand Street, Paterson, NJ 07575 (201) 523-3333.

BLANK AUDIO AND VIDEO CASSETTES direct from manufacturer, below wholesale, any length cassettes: 4 different qualities to choose from. Ampex and Agfa mastertape—from 1/4-inch to 2-inch. Cassette duplication also available. Brochure. Andol Audio Products, Inc., Dept. db, 42-12 14th Ave., Brooklyn, NY 11219. Toll free 1-800-221-6578, ext. 1, NY residents (212) 435-7322.

FOR SALE—AKG C-24 and other tube type condenser mics. (415) 441-8934 or 527-6167.

AGFA CHROME and normal bias BLANK CASSETTES. CUSTOM LOADING to the length you need. Your music deserves the best—your budget deserves a bargain. GRD P.O. Box 13054, Phoenix, AZ 85002. (602) 252-0077.

Soundcraft 1624 Console, Fully Loaded, Immac.. \$29,800. (805) 482-7495. P.O. Box 651, Camarillo, CA 93010.

NEUMANN U-87, U-47, four each. Used once. In warranty. \$849, \$829. Call John (512) 690-8187.

## INSTRUCTION

LEARN MULTI-TRACK RECORDING from set-up to mix-down. Intensive studio engineering course equal to or better than most. Limited enrollment, policy of four students per one month course. New 16-track gear, registered trade school. **Mid-Ocean Recording, 1578 Erin St., Winnipeg, Manitoba, Canada R3E 2T1. (204) 774-3715.**

## SERVICES

MAGNETIC HEAD relapping—24 hour service. Replacement heads for professional recorders. **IEM, 350 N. Eric Drive, Palatine, IL 60067. (312) 358-4622.**

ACOUSTIC CONSULTATION—Specializing in studios, control rooms, discos. Qualified personnel, reasonable rates. Acoustilog, Bruel & Kjaer, HP, Tektronix, Ivie equipment calibrated on premises. Reverberation timer and RTA rentals. **Acoustilog, 19 Mercer Street, New York, NY 10013. (212) 925-1365.**

AMPEX FACTORY SERVICE: Complete service and parts for Ampex equipment; professional audio, helical-scan video systems and professional audio motor and head assembly rebuilding. **AMPEX SERVICE CENTER, 719 W. Algonquin Rd., Arlington Heights, IL 60005, 1-800-323-0692 or (312) 358-4622.**

## WANTED

WANTED: TRANSCRIPTION discs, any size, speed. Radio shows, music. **P.O. Box 724-db, Redmond, WA 98052.**

WANTED: MCI, Neve console; MCI, Ampex tape machine; Neumann, E-V mics; McIntosh amps. **(204) 885-2922.**

## EMPLOYMENT

AUDIO ELECTRONICS ENGINEER/MAINTENANCE TECHNICIAN. Probable job opening. Servicing digital and analog audio equipment, design, construction, concert recording. Bachelors degree in Engineering preferred. Send resume by 6/15/83 to **Professor Darla Semegen, Music Department, SUNY Stony Brook, Stony Brook, NY 11794.** SUNY Stony Brook is an equal opportunity/affirmative action employer. AK 591B.

## SYSTEM DESIGN ENGINEERS

OVERSEAS ASSIGNMENTS IN ASIA. U.S. company with offices in San Francisco, Brunei, Singapore and the Philippines actively engaged in engineering design of electronic systems and contract installations for building complexes in Asia—specializing in the systems:

- Building Automation
- Energy Management
- Life & Asset Safety Systems
- Commercial Sound Systems

Will consider applicant for these positions with the following qualifications: • 3-5 years experience in System Design, Installation, Project Engineering, Testing/Instrumentation, Calibration and Operation of any of the above systems. • Knowledgeable in Acoustic Analysis. • College graduate. Qualified candidate must be willing to travel around Asia for Project assignments. Willing to sign a 3 year minimum contract and be available by June-July 1983.

Interested parties send resume with present and desired salary; references and professional recommendations from previous employers will be helpful in evaluation. All applications should be mailed to **P.O. Box 2244, South San Francisco, CA 94080.** Qualified applicants will be advised by phone for personal interview to be scheduled.

OTARI Corporation in California seeks a professional individual for the position of "Senior MTR, Technical Support." Five years minimum in pro audio as a Senior maintenance engineer or equal, having both 2 inch multi-track and 1/4 inch machine experience is required, micro-processor experience desirable. Salary negotiable, great working conditions and benefits. Send resume to: **Barry Ross, Otari Corporation, Box 2014, 2 Davis Drive, Belmont, CA 94002.**

## SALES ENGINEERS/MANAGERS

Join our expansion program and enjoy unlimited earning potential.

Openings exist for experienced Sales Engineers in Audio/Video Systems and Health Care Communications in Michigan, Ohio and Florida.

Positions offer an outstanding salary and bonus plan plus excellent fringe benefits including a stock ownership plan.

If you have a successful background in the Professional Sound and Communications Industry and are looking for an opportunity to gain personal and financial independence, call or send your resume to:

**Mr. Fred Shuart  
Industrial Communication Company  
21470 Coolidge Highway  
Oak Park, Michigan 48237  
Phone: (313) 399-4900**

All replies will be held in strict confidence.



Have you misplaced your db again? Our high quality, royal blue vinyl binders keep 12 copies of db neat and handy for ready reference.

Just \$9.95, available in North America only. (Payable in U.S. currency drawn on U.S. banks.) **ORDER YOURS NOW!!**

**Sagamore Publishing Co., Inc.**  
1120 Old Country Road  
Plainview, NY 11803

**YES!** Please send  db binders @ \$9.95 each, plus applicable sales tax. Total amount enclosed \$

Name   
Company   
Address   
City   
State Zip



# People, Places

- **Glenn T. Herb** has been named vice president of Engineering at **BTX Corporation**, filling a newly created position. As Engineering vice president, he will be responsible for all new product development, quality control and service. Prior to joining BTX, Herb was Research and Development engineer and most recently project manager with **Hewlett-Packard**. He is a founder of BTX and was formerly associated with the company in an engineering capacity.

- **George F. Currie** has been named vice president and general manager of **Sony Professional Audio Products**. The announcement was made by **J. Philip Stack**, executive vice president, Sony Communications Products Company. Mr. Currie, who began his career with Sony Corporation of America in 1973, most recently was central regional zone manager for the Communications Products Company. In that position, he supervised all sales, service and personnel of the Communications Products Company in the Midwest. Previously, he held regional management positions in Chicago and Detroit.

- After ten years on Santa Monica Boulevard in Hollywood, **Coast Recording Equipment Supply Inc.** is moving this spring to newer, more spacious quarters only half a block from their old location. The company is one of the largest outlets for new and used recording equipment in the industry, and their new spaces on Santa Monica Boulevard will provide over eleven thousand square feet of display area. According to owner/partner **Jerry Cabbage**, Coast has grown too big for its present store at Santa Monica near Gower, and the new building, which is being completely renovated prior to the move, will allow greater display areas as well as storage for the vast inventory Coast carries. Coast represents all the major names in sound recording, including **BGW, Crown, dbx, Electro-Voice, Neumann, Sennheiser, Shure, TDK, and UREI**. Aside from being one of the largest **Ampex** dealers in Southern California, Coast Recording carries more Ampex parts than any other supply company in the West.

- A new, independent production company has appeared on the California music scene and is offering clients and artists strong assistance in creating and marketing music products. **Hats-Off Productions** is guided by **Keith Hatschek**, a veteran of 18 years in the music industry. Keith has had a varied and successful career as an artist, arranger, recording engineer, producer, songwriter and music consultant. Since opening his own recording studio, **Bayshore Studios**, San Carlos, CA, in 1979, Keith has been recording albums, singles, demos, and audio projects for a wide variety of clients. Some of the artists currently working with Hats-Off are **Marten Ingle**, formerly of the Los Angeles-based **Innocents**; **The Guitarz**, a successful Northern California concert and club group, and **Marty Atkinson**, a Canadian born singer-songwriter.

- **Shure Brothers Inc.** has announced the appointment of **John F. Phelan** to the position of Professional Products Marketing manager. His responsibilities will include supervising the marketing of all Shure professional audio products. Phelan was previously Western Regional Sales manager for **Sony Corporation of America's Professional Audio Division**. Prior to that, he was general manager of **Filmways Audio Services, Inc.**, in North Hollywood, California.

- **Mr. Jack Soma**, president of **Otari Corporation**, has announced the formation of a new Special Products Division as of May 1. According to Mr. Soma, "...the new division will develop specialized products for new markets as part of Otari's plan for continued, strong growth. The Special Products Division, along with the Research & Development Division (started last year), reflect and support Otari's commitment to aggressive market development worldwide." Soma also announced the promotion of **Michael Bernard** to the new position of manager, Special Products Division. In a parallel development, the promotion of **John Carey** to the position of National sales manager was announced. Carey had been MTR sales manager for Otari.

- **Ron Means**, vice president of Marketing and Sales for **JBL Incorporated's Professional Products Division**, announced that JBL will begin marketing **UREI** brand name products in the United States, effective July 1. The **URC Corporation**, of which UREI is a division, was recently acquired by JBL parent **Harman International**. According to Means, JBL and UREI will share a combined sales organization, including common representatives, regional managers and national sales manager. No major changes are anticipated in the UREI dealer distribution.

- **Ampex Corporation** announced that it has sold six ATR-124 multi-track audio mastering recorders to the **Hitsville U.S.A.** recording studio, Los Angeles. Hitsville, a division of **Motown Records**, will use the 24-track systems to replace their older recorders and expand the studio's mastering capabilities, according to **Guy Costa**, vice president-managing director. "After making a creative and technical evaluation of all the major multi-track recorders, we chose the Ampex ATR-124 because it is an ideal match for us in sound and electronic design," Costa said.

- **Martin Audio and Sound Workshop** have announced the installation of New York City's first Disk Mix Automation Storage System at **Blank Tapes Studios**. Blank Tapes, located at 37 W. 20th St. in New York, originally opened seven years ago as a demo studio. Primarily a music studio, they now have three 24-track rooms and are planning to build a fourth. With the Disk Mix System connected to their automated **MCI JH 542** console, Blank Tapes can now offer their clients disk based automation with its multiple mix storage capacity and off line editing facilities. Says Blank Tapes president **Lou Vetter**, "We wanted it, and our clients needed it. The new mix storage technology being used with our existing consoles gives our automation systems what they have long needed. After a few hours with the user-friendly, menu driven system, my engineers were anxious for upcoming mix dates."

# .. & Happenings

• **Audio Rents** of Hollywood, California, now offers its complete inventory of recording and post-production equipment to professional recording and television studios across the nation. Improvement in air freight reliability means economic delivery within 24 hours to most locations in the continental United States. Audio Rents' inventory includes most models of digital delay, reverb and effects boxes plus limiters, equalizers, vocoders and noise control equipment of all types. This new service, coordinating with **Livingstone Audio** to provide remote trucks, consoles and tape machines, and **Hollywood Sound Systems** for monitor amplifiers and speakers, can bring all of Hollywood's resources to your doorstep with one telephone call. A National Rate Card is available and your inquiries are invited to Audio Rents, Inc. at 800-637-5000 (213-874-1000 in California).



• **Ampex Corporation** announced that it has reached agreements with **Wheelabrator Financial Corporation** and **Commercial Funding Inc.** to provide financing alternatives for the lease or purchase of audio and video recorders to its U.S. customers. The new term funding program became effective January 31.

"The economy has necessitated the extension of financing alternatives for the purchase of capital equipment. We believe these new agreements will be a valuable asset to our customers, enabling them to lease or purchase Ampex equipment more cost effectively," said **Michael Scott**, sales finance manager, Ampex Corporation.

The program provides customers with the opportunity to lease or purchase Ampex audio or video recorders through one of four financing alternatives: tax-oriented lease, lease purchase, conditional sale or operating lease.

• **Altec Lansing** president **William Fowler** recently announced the promotion of **Mark Ureda** to director of Acoustical Engineering for the Anaheim-based sound products manufacturing firm. Formerly Acoustics Research manager for Altec, Ureda's new responsibilities include coordination of acoustical research and development at the company's facilities in Anaheim and Oklahoma City. Joining Altec in 1976 as an associate engineer, Ureda was instrumental in initiating the Altec engineering computer system now utilized by the company. Ureda is also the holder of several patents for his earlier work on the successful Altec Mantaray® line of constant directivity loudspeaker horns, employed in both commercial and home loudspeaker systems.

• **Michael Tapes**, president of **Sound Workshop Professional Audio Products, Inc.**, has announced that **Everything Audio** (Encino, CA) has been appointed as the exclusive Southern California dealer for Sound Workshop Series 20, 30, and 40 Mixing Consoles, ARMS Automation, and the DISKMIX Automation Storage/Editing System. Negotiations were recently completed between **Emil Handke** (sales manager, Sound Workshop) and **Brian Cornfield** (president, Everything Audio). Said Handke, "This new agreement was a natural because of Everything Audio's broad market base, and their thorough knowledge of mixing consoles and console automation as applied to recording studios and video post-production facilities." Michael Tapes added, "I am extremely pleased that Everything Audio is now part of our distinguished dealer network. Marketing and selling professional audio must be a united effort between manufacturer and dealer."

• **Ron Means**, vice president of Marketing and Sales for **JBL Incorporated's Professional Products Division**,

announced that JBL will begin marketing UREI brand name products in the United States, effective July 1. The **URC Corporation**, of which UREI is a division, was recently acquired by JBL parent **Harman International**. According to Means, JBL and UREI will share a combined sales organization, including common representatives, regional managers and national sales manager. No major changes are anticipated in the UREI dealer distribution.



• An **Eastern Acoustic Works** sub-woofer system is installed and operational in theater number one at the Visitor Information Center at the Kennedy Space Center. The theater, owned and operated by **TWA Services**, enables visitors to the space center to experience the sight, sound and feel of a space shuttle launch.

The system was designed and sold by **Communitronics of Florida, Inc.** under direction from the Cape Canaveral, Fla. engineering firm of **Statler Stagg**. The design objective was to supply a system capable of reproducing the full sonic impact of a Space Shuttle Launch, complete with low frequency high output pulses.

The sub-woofer system consists of an array of two EAW BH-880-LR horn loaded bass reproducers. This type of array has been successfully used for high level dance systems, motion picture sound systems and outdoor entertainment systems. Each EAW BH-880-LR utilizes two EAW/RCF LF-443-R 18-inch (440mm) drivers coupled to a 32 Hz expansion rate bent exponential horn. The dual horn array has a mouth area of 5.782 square inches, providing flat response down to 35 Hz with usable response down to the 28 Hz region. This configuration will provide 113 dB SPL at one meter with only one watt input in the 35 Hz to 50 Hz band, which translates into a conversion efficiency of approximately 50 percent.

# AL JARREAU'S MUSIC HELPS MAKE COLORFUL READING.



ColorSounds is a unique combination of music and color that advances the reading capabilities of children.

Instead of getting turned off to school because they can't read, kids master reading in an exciting new way...while listening to popular music.

Al Jarreau contributed one thousand dollars to support this special educational technique. And the Ampex Golden Reel Award made it possible. It's more than just another award. It's a thousand dollars to a charity named by

artists receiving the honor.

For Al Jarreau, *Breakin' Away* was the album, Dawnbreaker and Garden Rake were the recording studios and the kids of ColorSounds were the winners.

So far, over a quarter of a million dollars in Golden Reel contributions have gone to designated charities. For children's diseases. The arts. Environmental associations. The needy.

Our warmest congratulations to Al Jarreau, Dawnbreaker, Garden Rake, and to

all of the other fine recording professionals who've earned the Golden Reel Award.

## AMPEX

Ampex Corporation • One of The Signal Companies 



Circle 11 on Reader Service Card

Like father,  
like son.

Free 10½" reel  
Scotch® 2  
Masterii  
Tape w  
ea  
PR

For roughly \$10,000, you can own the ultimate analog mastering deck—the Studer A80RC half-inch two-track recorder.

Beyond your budget? Well, for about 1/5 the price you can own a Revox PR99 compact professional recorder. It's made by the same company, it draws on the same wealth of engineering expertise, and it reflects the same philosophy of design and construction—a philosophy established by Willi Studer over three decades ago.

The PR99's bloodlines are evident in every detail...in the precision-machined headblock, the rugged die-cast chassis, the servo-controlled capstan motor, and the Studer-made heads. Professional design features include a flat faceplate for easy head access; edit switch to defeat tape lifters and fast wind latching; tape dump button; balanced XLR inputs and outputs switchable for calibrated or uncalibrated mode; and two-way self-sync with auto input switching. The PR99 may be ordered with 3¾-7½ or 7½-15 ips tape speeds. Vari-speed, full remote control, and monitor panel available as options.

The PR99 now comes in console, rack mount and transportation case versions. Check it out. Call or write today for the location of your nearest dealer.

The PR99. From the world's most respected name in recording.

**STUDER REVOX**

STUDER REVOX AMERICA, INC. • 1425 Elm Hill Pike • Nashville, TN 37210 • (615) 254-5651

Circle 12 on Reader Service Card