

498105KU0M4325COM11 0683 9999
 KUOM RADIO
 O S 50 UNIV OF WASH
 325 COMMUNICATIONS BLDG
 SEATTLE WA 98105



ī·krə·fōn.

1: an instrument whereby sound waves are caused to generate or modulate an electric current usu. for the purpose of transmitting or recording sound (as speech or music). **2:** a device for converting sound waves into corresponding electrical signals. Microphones can be categorized in several ways: their sensitivity patterns, the method by which they convert sound to electrical energy, or other characteristics. **3:** a subject covered in the June issue of **db** Magazine.



MORE RECORDING STUDIOS USE CROWN MONITOR AMPS THAN ANY OTHER BRAND.*

If you're going for gold, you've got to have the best – the best talent, the best writing, the best equipment. You'll leave nothing to chance.

That's why most studio professionals choose Crown monitor amplifiers.

They know they'll get the clearest highs, the most accurate mid-range, the most solid lows with Crown amps.

Sonic accuracy has always been the first goal – and the hallmark – of Crown engineering. Crown amps *are* powerful,

but never at the loss of sonic accuracy. Crown amps *are* reliable, but our first concern is sonic accuracy.

Crown amps will never get in the way of the music. With Crown, you'll know for sure when you've got a gold.



*See Billboard's International Recording Equipment & Studio Directory, 1982-1983.

1718 West Mishawaka Road, Elkhart, IN 46517 (219) 294-5571

Circle 10 on Reader Service Card



JUNE 1983 VOLUME 17 NO. 6

Publisher
Larry Zide

Associate Publisher
Elaine Zide

Editor
John M. Woram

Managing Editor
Mark B. Waldstein

Associate Editor
Ricki Zide

Technical Editor
Linda Cortese

European Editor
John Borwick

Layout & Design
Kathi Lippe

Advertising Coordinator
Karen Cohn

Book Sales
Lydia Calogrides

Circulation Manager
Eloise Beach

Graphics
K & S Graphics

Typography
Spartan Phototype Co.

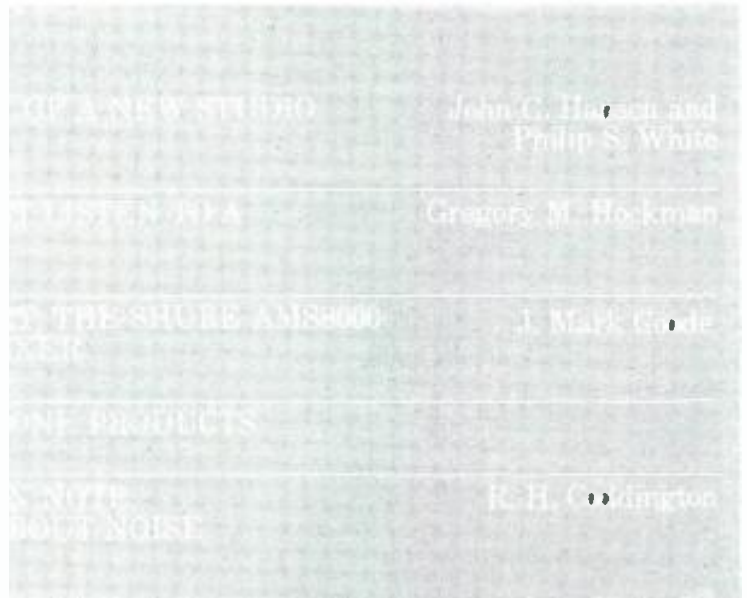

DEPARTMENTS

LETTERS	CALENDAR	EDITORIAL	CLASSIFIED
6	8	26	53
SOUND WITH IMAGES			Len Feldman
THEORY AND PRACTICE			Ken Pohlmann
SOUND REINFORCEMENT			John Eargle
DIGITAL AUDIO			Barry Blesser
NEW LITERATURE			
NEW PRODUCTS AND SERVICES			
PEOPLE, PLACES, HAPPENINGS			

ABOUT THE COVER

• Surprise! No studio graces the cover of this month's db. Instead, we've (literally) defined the microphone—with a little help from *Webster's New Collegiate Dictionary* and the *CAMEO Dictionary of Creative Audio Terms*. For a more in-depth look at the mic, mic', or mike (take your pick), see any of this month's feature articles.

db, the Sound Engineering Magazine (ISSN 0011-7145) is published monthly by Sagamore Publishing Company, Inc. Entire contents copyright © 1983 by Sagamore Publishing Co., 1120 Old Country Road, Plainview, N.Y. 11803. Telephone (516) 433-6530. db is published for those individuals and firms in professional audio-recording, broadcast, audio-visual, sound reinforcement, consultants, video recording, film sound, etc. Application should be made on the subscription form in the rear of each issue. Subscriptions are \$15.00 per year (\$28.00 per year outside U.S. Possessions, \$16.00 per year Canada) in U.S. funds. Single copies are \$1.95 each. Editorial, Publishing and Sales Offices: 1120 Old Country Road, Plainview, New York 11803. Controlled circulation postage paid at Plainview, NY 11803 and an additional mailing office.

OUR BOTTOM LINE IS

Our bottom line of service means *your* bottom line will be more profitable.

Single Source.

The widest range of commercial sound products in the industry. Even hard-to-find items.

Fast Delivery.

Orders are shipped within 36 hours of receipt. Faster if necessary.

Sound Advice.

Personal attention, plus professional advice on any technical problems. We're your unseen partner.

50 Years' Experience.

Service and reliability that have been proven over the years. You can depend on us!

Call toll free today for new price list.

1-800-527-5705
TEXAS 1-800-442-1564

SERVICE

J. W. Davis & Company
3215 Canton Street
P.O. Box 26177
Dallas, Texas 75226



Letters

ONE MAN'S OPINION

TO THE EDITOR:

Regarding Curtiss Schafer's letter concerning the Cortical Hearing Aid (May, 1983—Ed.). I have contacted Mr. Schafer and he provided me with copies of a patent plus test data. In addition, he put me in touch with Mr. Joe Codomo. Mr. Codomo is attempting to raise funds to further research and development of the device.

I have spent considerable time investigating the basic idea and have concluded that the device doesn't work. Mr. Schafer has been misled in his conclusions by not being careful in his experiments. It is easy to be in error when judging the precise degree of hearing and understanding of hard of hearing people when tests are not being carried out under scientifically controlled conditions. When they cannot be independently duplicated, it further reduces the reliability. To top it off, there seems to be no logical or scientific basis for the device working.

I would be glad to discuss this with anyone. I am most anxious to keep innocent people from investing money in this device. It holds out such great promise as to be tempting. But, like many things that sound too good to be true, this one, in fact, is.

HARRY LEVINSON
Harry Levinson Company

db replies:

We contacted John Leddo, Director of Audiology at the Easter Seal Center (where Mr. Schafer's Cortical Hearing Aid was tested), for a response to Mr. Levinson's letter. We are presently awaiting his reply.

Index of Advertisers

Agfa Gevaert.....	13
Alpha Audio.....	8
Altec.....	11
Amber.....	23
AXE.....	15
BASF.....	9
Crown.....	Cover II
Delta Labs.....	19
Electro-Voice.....	7
Emilar.....	45
Garner.....	10, 25
J. W. Davis.....	6
Klark-Teknik.....	14
Magnefax.....	16
PAIA.....	47
Pentagon.....	8
Polyfusion.....	20
Polyline.....	45
Shure Bros.....	17
Soundcraft.....	Cover III
Sound Ideas Sound Effects.....	46
Standard Tape Lab.....	43
Studer Revox.....	Cover IV
Telex.....	22
White.....	18



COMING NEXT MONTH

• Next month, db will be expanded, as we bring you a combined summer issue featuring articles on Speakers, Monitors and Signal Processing equipment. Among the many featured articles will be an historical look at compression drivers by the people at Renkus-Heinz, as well as a piece by John Eargle on JBL's Central Array Design Program. In addition, we'll take a look at an audio installation at the Ft. Worth Museum of Science and Industry, and review the Orban 424A Gated Compressor/Limiter/De-esser. All this—plus our regular columns, departments and much, much more—coming in the combined, expanded July-August issue of db—The Sound Engineering Magazine.



Introducing the New Electro-Voice RE30 omni and RE34 cardioid ENG/EFP microphones

“Sophisticated microphones that simplify field production.”

Action doesn't wait. The constant deadlines faced by news gathering and field production crews demand equipment compatibility, fast set-ups, simple operation and absolute reliability.

Electro-Voice knows.

We've designed and built the broadcast microphones that have set performance and reliability standards, and we stand behind EV Professional Microphones with a warranty and service policy that's second to none.

And EV listens.

Properly designed broadcast products are the result of pooled efforts. That's why EV devoted years to research, by working with network and local broadcasters to engineer all of the desired features into a pair of rather revolutionary new microphones for ENG and EFP.

EV confirmed that field microphones should incorporate low handling noise, resistance to humidity and moisture problems, extreme durability, and the same reliability and level of performance that the industry has become accustomed to expect from EV microphones like the phenomenal 635A and RE20.

Introducing the RE30 and RE34.

Because remotes present a variety of acoustic environments, EV engineered the RE30 with an omnidirectional pickup pattern, and the RE34 with a cardioid pattern. Except for their polar patterns, each model has the same features.

Both the RE30 and RE34 have switchable outputs—either line level or microphone level. No longer will field crews



be stuck without the right signal level. A flick of the recessed switch adjusts the output level, producing instant compatibility without the need for extra equipment or cables. The low distortion line-level amplifier allows direct interface with line-level inputs such as those common on microwave and fiber optic transmitters.

Additionally, the RE30 and RE34 will drive and hold telephone lines*.

*F.C.C. approved interconnect may be required.

Each microphone includes a low-distortion limiter which functions at either output level.

The RE30 and RE34 can be powered by either phantom power or a standard, available anywhere, 9-volt “transistor radio” battery. With both power sources present, the battery becomes a redundancy powering system that instantly and silently takes over if ever required.

An LED, mounted so as to be easily visible to the talent only, serves several important functions...it shows the presence of phantom power, monitors battery condition, and offers the world's first hand-held “tally light” to signal on-air personalities from off-camera.

Get the whole story.

No advertisement can hope to explain all of the features of these incredible new microphones. Complete engineering data sheets describing the many features and benefits of the RE30 and RE34 are available free upon request.

Many Electro-Voice Professional Microphone Dealers can arrange a hands-on trial at no cost to you. For more information please write to: Greg Silsby, Market Development Manager/Professional Markets, Electro-Voice, Inc., 600 Cecil Street, Buchanan, Michigan 49107.

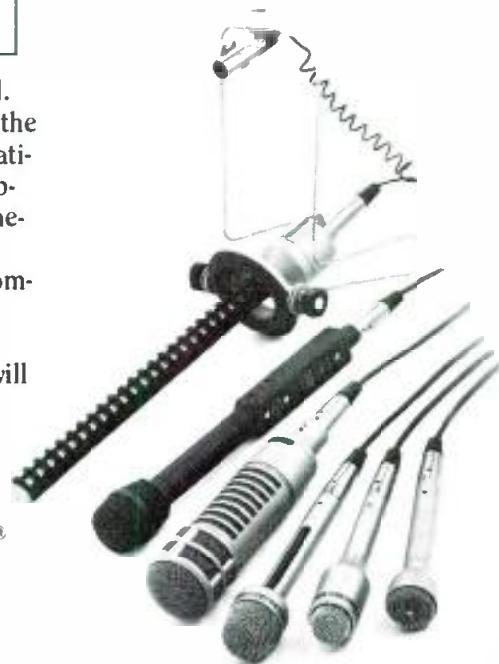

a gulton company

EV Electro-Voice®
SOUND IN ACTION™

Circle 13 on Reader Service Card

PENTAGON'S 1100 SERIES

**Cassette or
Open Reel
Duplicating
System**

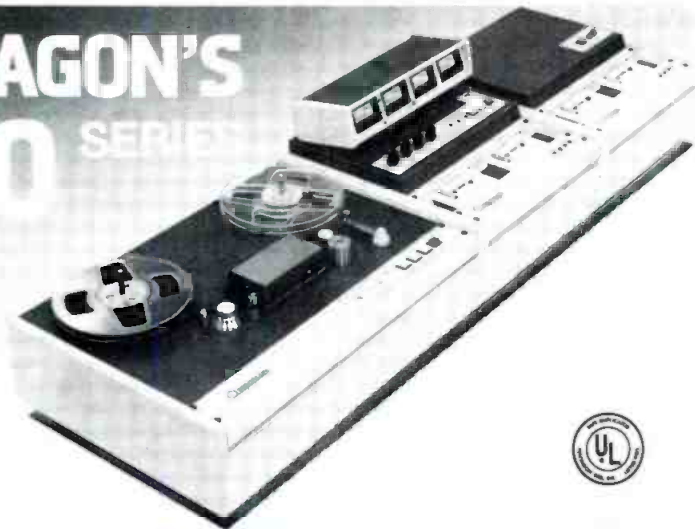

PENTAGON IS PROUD OF . . . OUR TOUGH CUSTOMERS

Careful evaluation of the capabilities and performance of the 1100 Series duplicating system has led to its acceptance for a broad range of applications. Start with a low cost cassette master/slave unit and later expand by adding an open reel master or any combination of reel or cassette slaves to produce 4500 cassette or reel copies per day. Optional 1100 systems can easily duplicate "Nagra SN Master Tapes."

Some great features: Lighted push button controls • End-of-tape sensing • Synchronous drive • Die-cast "Stabilign" head mounts • Track select • Automatic rewind on masters • Automatic cue • Accutrack metering • Exclusive patented braking system • Individual channel controls • Designed to protect master tapes.

Law enforcement agencies such as: The District Attorney's Office, Bronx, New York, Central Intelligence Agency, The F.B.I., Dade County Public Safety, Suffolk County Police Dept., New Jersey State Police.



World Headquarters

4751 North Olcott
Chicago, IL 60656
(312) 867-9200
Tlx 25-3058

Phone Toll Free 1-800-621-3867

Circle 14 on Reader Service Card

Calendar

AUGUST

- 1-3 **Digital Voice and Video Course.** Sponsored by The George Washington University, Continuing Engineering Education, Washington, D.C. 20052. For more information, contact Shirley Forlenzo at 202/676-8530.

OCTOBER

- 3-7 **Underwater Acoustics and Signal Processing Course.** Sponsored by The Pennsylvania State University, University Park, PA. For more information, contact: Alan D. Stuart, Course Chairman, Applied Research Laboratory, The Pennsylvania State University, P.O. Box 30, State College, PA 16801. Tel: 814/865-7505.
- 16-18 **Third Annual WOSU Broadcast Engineering Conference.** Co-sponsored by WOSU Stations and Broadcast Engineering Magazine in cooperation with the Office of Continuing Education, The Ohio State University, Fawcett Center for Tomorrow, 2400 Olentangy River Rd., Columbus, OH. For more information, contact: Office of Continuing Education, The Ohio State University, 2400 Olentangy Rd., Columbus, OH 43210. Tel: 614/422-8571.
- 9-12 **74th Audio Engineering Society Convention.** New York Hilton. For more information, contact: The Audio Engineering Society, 60 East 42nd Street, New York, NY 10165. Tel: 212/661-8528.
- 17-24 **Canadian Acoustical Association Annual Meeting and Symposium.** Vancouver, B.C., Canada. For more information, contact: Canadian Acoustical Association, Box No. 46256, Postal Station G, Vancouver, Canada V6R 4G6.



SONEX kills VTR noise.

SONEX not only improves audio quality, inexpensively, but also quiets annoying background noise when you need to concentrate: noise from Quad VTR head blowers and head wheels; from mechanical tape transports; even from computer disk drives and fans. SONEX is the art of shaping sound... and the workhorse of killing noise.

Get the facts today.

SONEX is manufactured by Illbruck/usa and distributed exclusively to the pro sound and A/V industries by Alpha Audio.

Alpha Audio

2049 West Broad Street
Richmond, Virginia 23220 (804) 358-3852
Acoustic Products for the Audio Industry

Circle 16 on Reader Service Card

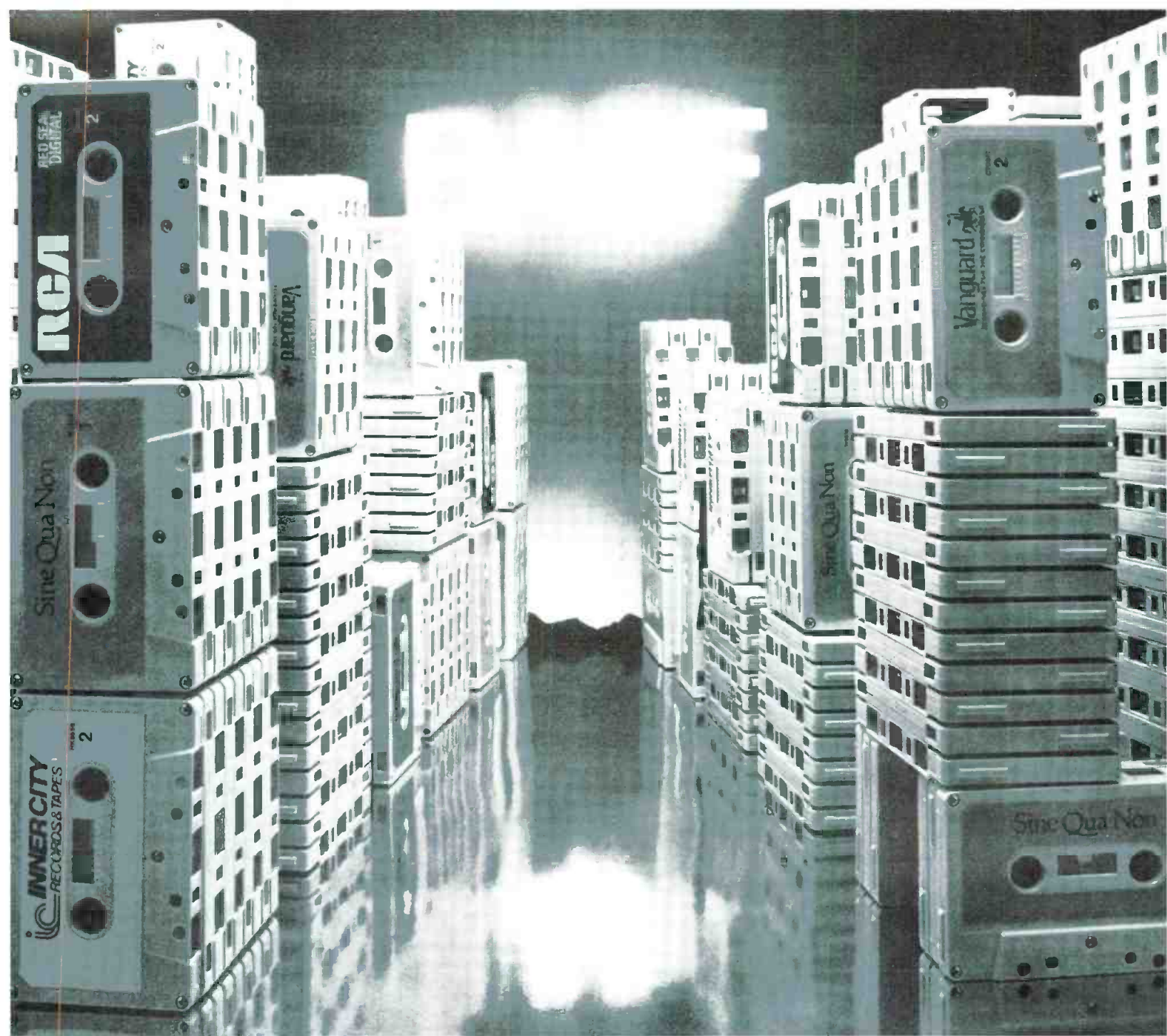

THE ROAD TO PLATINUM IS PAVED WITH BASF PURE CHROME.

The only place to be in the recording business is #1. And with cassettes taking over nearly 50% of the industry's pre-recorded sales this year, the best way to get to the top is on BASF Pure Chrome duplicating tape.

BASF Pure Chrome helps you climb the charts faster because it duplicates your sounds more perfectly than any other brand. Technically speaking, BASF Pure Chrome offers extended high frequency Maximum Output Level (MOL), plus the world's lowest background noise. And our exclusive Pure Chrome formulation is extremely clean and stable at even the highest duplicating speeds. The payoff? Audio performance that's virtually indistinguishable from a studio master recorded at 15 I.P.S.



Best of all, just about anyone can change over from ferric oxide to BASF Pure Chrome with the greatest of ease—and without any need for additional equipment or expenses.

Find out why such major names as RCA Red Seal Digital, Sine Qua Non, Vanguard and Inner City all put their trust in us. Switch to BASF Pure Chrome duplicating tape. Because when you put "CrO₂" on your label, you're not just guaranteeing the public the pure music they're paying for. You're paving your way to platinum with BASF Pure Chrome.

 **BASF**
Chrome Audio & Video Tapes

Circle 15 on Reader Service Card

ONE PASS

**The Only Four-Second
Tape Erasers**

**That's Garner...
The Quality Eraser**

You're recording on a machine that costs hundreds or thousands of dollars, and you're reording on recycled tape. Can you guarantee that tape is absolutely clean? You can if you're using a Garner Audio Tape Degausser.

Garner is the standard of the industry...designed to the specifications of leading tape manufacturers. Garner is a conveyor-belt tape eraser. It can erase in less than five seconds what most degaussers take up to a minute to erase, and Garner erasers do a better job.

Time savings, ease of operation, quality of erasure, and rugged construction make Garner the most cost-effective eraser available.

Garner has established a reputation as the "Eraser People" because we manufacture a complete line of both audio and video erasers. Call and let us show you what a Garner eraser can do for you.



Dependability...Guaranteed

garner industries

4200 N. 48th Street Lincoln, NE 68504
Phone: (402) 464-5911 Telex: 438068

LEN FELDMAN

Sound With Images

Audio and Video Standards for 8mm Video Tape

● On March 28th, the 8mm Video Standardization Conference announced that agreements had been reached on audio and video formats for 8mm video tape formats. The conference had begun its work more than a year earlier, in March, 1982, when five working groups (Video, Audio, Cassette, Tape and Tracking) and a coordination committee were formed. Their task was to examine all the technical details and problems connected with 8mm video tape and to come up with specifications that would be acceptable to all the companies and industry segments involved with the new tape format. By the time the Conference ended, there were no fewer than 122 companies from all over the world involved in the work. It is nothing short of a miracle that so many diverse interests could have gotten together and agreed to a set of standards.

In fact, the miracle is not really as great as it seems, for as you will shortly see, when we describe the new standards, not every parameter is as clearly defined as it might have been. Specifically, agreement was reached in such matters as audio recording, tracking, cassette and tape properties, the use of an FM luminance signal and the use of "color-under" conversion for NTSC and PAL video signal recording. As for standards for SECAM (the TV transmission system used in France and the Soviet Union), a new video recording technique called "Timeplex" was proposed, but could not be agreed to since further study of this system is required. According to reports emanating from the conference, this new Timeplex method could have application in NTSC and PAL video, too.

MAIN VIDEO SPECIFICATIONS

Readers of db are probably more interested in the audio recording specifications for the new 8mm video tape recording format, and I will outline

those shortly. However, in order to understand the interrelationship between the video and audio recording techniques that have been agreed to, it's important to understand the video recording system as well; let's start by examining a few of the video recording specifications.

As mentioned, a so-called "color under" system of video recording is to be used. The luminance, or brightness signal is to use FM modulation with sync tip frequency located at 4.2 MHz and "white" signal level corresponding to a frequency of 5.4 MHz. As in the case of ½-inch video recording formats, a 2-rotary-head azimuth recording system is to be used. Drum diameter for the rotary heads is specified as 40mm (about 1.57 inches). Tape cassette size is set at 95mm × 62.5mm × 15mm (3¾-in. × 2.46-in. × 0.59-in. thick). Tape speed for the NTSC system has been set at 14.345 mm/sec. (0.565 ips), while for the PAL/CCIR format, linear tape speed will be 20.051 mm/sec. (about 0.79 ips). Given the 40mm diameter of the video head drum, effective writing speed works out to be 3.8 meters per second for the NTSC system and 3.1 meters per second for the PAL system. Initially, at least, maximum recording time available in the new format will be 1.5 hours for NTSC and 1.0 hours for 625 line/50 Hz systems such as PAL. The chrominance signal "color under" frequency has been set at 47.25 times the horizontal line rate in the case of NTSC, and at 46⅞ times the horizontal line rate for PAL.

At the present time, tape thickness has been specified as 13.0 μm, although a somewhat thinner tape (10.0 μm) is under consideration and, if approved, could yield a longer record/play time in the future.

THREE AUDIO ALTERNATIVES

There must have been a great deal of controversy behind the scenes at the

ALL LOUDSPEAKER/BOX SYSTEMS ARE NOT CREATED EQUAL.

System 8227
Two 12" High Performance
Loudspeakers
3 cubic ft. internal volume
70 Hz (-3 dB)

System 8127
12" High Performance
Loudspeaker
1.5 cubic ft. internal volume
70 Hz (-3 dB)

System 8156
15" High Performance
Loudspeaker
3 cubic ft. internal volume
65 Hz (-3 dB)

System 8256
Two 15" High Performance
Loudspeakers
6 cubic ft. internal volume
65 Hz (-3 dB)

System 8182
18" Low Frequency
Loudspeaker
24 cubic ft. internal volume
23 Hz (-3 dB)

The revolutionary new 3000/8000 Series of loudspeakers and matched, optimally-tuned enclosures pictured above is a perfect example of the kind of thing Altec Lansing does better than anybody else. Designed from the ground up as totally integrated systems, the 3000/8000 Series offers the sound system designer an unprecedented choice among low frequency response, efficiency and compact size. Find out more about this versatile new line, plus Altec Lansing's new Extended Range Musical Instrument Loudspeakers, vented enclosures and more in our new

12-page Acoustic Products Brochure, available free from Altec Lansing. For your free copy, fill out the coupon and send today to:



Acoustic Products
Brochure
P.O. Box 3113
Anaheim, CA 92803

Name _____
Address _____
City, State, Zip _____
Occupation _____

DB

HAVE A RECORDING STUDIO PROBLEM?

Call DataLine*

A service provided by

SPARS

A Non-profit Organization
Dedicated To Excellence Through
Innovation · Education · Communication

* The Society of Professional Audio Recording Studios offers SPARS members, and non-members referred by a SPARS member, a national telephone 'hot-line.'

Questions regarding any area of recording studio operations including business, audio engineering and technical maintenance will be answered by SPARS-approved sources at no charge.

Want a problem solved? . . . call
SPARS — (305) 443-0686



SPARS

Board of Directors and Consultants

Murray R. Allen Universal Recording Corporation, Chicago	Lenard Pearlman Editel-Chicago
Jerry Barnes United Western Studios Los Angeles	John Rosen Fanta Professional Services, Nashville
Charles Benanty Soundworks Digital Audio/Video Studios New York	Malcolm Pierce Rosenberg Wolov & Rosenberg Philadelphia
Nick Colleran Alpha Audio Richmond	Christopher Stone Record Plant, Inc. Los Angeles
Guy Costa Motown/Hitsville USA Los Angeles	Joseph D. Tarsia Sigma Sound Studios Philadelphia
Mack Emerman Criteria Recording Miami	David Teig New York
Leroy Friedman Columbia Recording Studios, New York	John Woram Woram Audio Associates New York

standardization meetings when the question of audio recording was being resolved. As matters turned out, three different audio recording formats were incorporated into the new standards. While it can be argued that providing three widely different audio formats can hardly be described as creating a standard, I should point out that at least one of these standards is considered to be mandatory. That is, all future equipment must incorporate the mandatory standard. The remaining two audio recording methods are optional, and one or both of them may be incorporated in any equipment, over and above the mandatory one.

The mandatory audio recording technique adopted for the 8mm video system is not unlike the Beta HiFi audio recording technique described in this column a few months ago, except that no mention is made of the possibility of two-track stereo audio recording. Frequency-modulated audio, on a carrier having a frequency of 1.5 MHz, is multiplexed along with the video signal, using the rotary video head. Maximum FM deviation has been specified as ± 100 kHz, and recording current for this audio carrier is to be 13 dB below chrominance level. The use of a new form of noise reduction has been made mandatory for this system.

The second type of audio recording specified for the 8mm video standards is PCM (digital) audio, and this system does make provision for stereo. Sampling frequency is to be twice the horizontal line frequency (which would put it at roughly 31.5 kHz in the case of NTSC). Quantization will be 10 bits to 8 bits, using linear companding. Transmission rate will be at 368 times the horizontal frequency. The error correction method to be used will be cross-interleave code (8 words, 2 parities), while error detection will employ a 16-bit CRC code. The use of this type of system is optional, but if it is used, it is mandatory that the noise reduction system be used with it. This is probably because the low bit-rate would provide a maximum possible dynamic range of only 60 dB or so (48 dB in the case of an 8-bit system).

The third and last audio recording alternative for the new 8mm video recording format is called AUX Audio, and it employs a stationary head positioned near the lower edge of the tape. Provision is for a single channel only, and the use of noise reduction is made optional, as is this audio recording system itself. Given the fact that the track width allowed for this optional audio track is only 0.6mm wide and that tape speed (for the NTSC version, which we will see in this country) is only a little more than $\frac{1}{2}$ -ips, don't expect any kind of high-quality, high-fidelity audio performance from equipment offering this format.

Two basic types of tape formulation have been recognized in the newly approved standard. The first employs metal-powdered tape, while the second uses metal-evaporated tape. In the case of metal-powdered tape, reference recording level has been set at 80 nWb/m, while in the case of metal-evaporated tape, reference level has been set at a very low 16 nWb/m.

The new type of noise reduction system developed for 8mm video recording is adaptable to all three methods of audio recording: FM, PCM and conventional (AUX) stationary-head recording. When used with FM and PCM, the compression ratio is 2:1; when applied to the stationary-head (AUX) recording system, it will be 4:3.

Despite the narrow width of the tape, there is provision made for yet another track: the so-called auxiliary track for cueing. Like the AUX (conventional longitudinal) audio track located along one edge of the tape, this AUX cue track is to be located along the top edge of the tape. In addition to serving as a supporting system for the pilot tracking scheme that is also specified for the system, this extra cue track could conceivably be used for a variety of purposes, including cueing or related audio-visual devices or other electro-mechanical devices associated with the new video system. Like the AUX audio track, the cueing track is only 0.6mm in width. Guard bands between the AUX audio track and the video track and between the AUX cue track and the video track are 0.1mm in width. While simple subtraction of a pair of guard bands at 0.1mm and a pair of AUX cue and audio bands at 0.6mm would lead you to conclude that the available track width for video recording is 6.6mm, video recording, in fact, is accomplished on an effective track width that's even less than that: only 5.351mm. That's because video head-scan in the system operates over 221 degrees of rotation of the rotating head drum, of which 180 degrees is actually devoted to video recording (luminance and chrominance channels), while the remaining degrees of rotation of the head are essentially set aside for the PCM audio recording option.

When you stop to consider the available tape area that has been set aside for all of these audio and video services, you can only wonder at the amazing density of information that we are now able to cram onto a narrow magnetic tape such as this. It will, no doubt, be a while before widespread use of the 8mm video tape format will occur, but when it does, I suspect that it will find its way into professional as well as consumer audio-video applications. The possible miniaturization of hardware and software that is inherent in the system makes it too good to reserve for home entertainment products alone. ■

This Is
Bob
Ludwig.

He Is The
Engineer
Behind
The
Disk
Mastering
Of
Over
One Hundred
Platinum
And
Gold Albums
And A
1981
Grammy Award
Winner.



Bob Ludwig Masters and Mixes Exclusively on Agfa Tape.



MAGNETIC TAPE DIVISION

The Mastering Choice of the Masters.

Mr. Ludwig accepts no compensation for his endorsement.

*As appearing in Billboard, dB and other leading industry publications
Circle 19 on Reader Service Card*

KEN POHLMANN

Theory & Practice

The Case of the Resonating Restaurant

• The radio was playing the new hit single. "Subhumanoid Mutant." Its nihilistic lyrics and relentless beat appealed to my sense of aesthetics; I had always felt that the trouble with most music was that it was too upbeat. The phone rang, as it always does, just as I was getting into it. I quit the music, noted which line was hot, aimed the plastic to my ear, and gave the appropriate opener.

"Pohlmann Acoustic Consulting. (PAC-man?—Ed.) Slap echoes our speciality."

"Is this the sound consultant?"

"Himself."

"I have a big problem. All of my customers are complaining, and with the restaurant business the way it is, I don't know what I'm going to do. I've

tried talking with her, but she keeps making it louder and louder. I don't know which is worse—the music or the screaming. I mean, I'm going out of my mind."

"Calm yourself, sir."

"I mean, I work hard—my spinach souffle is the best in town—but with this music I might as well serve mud-pies. My patrons come to me and complain. How can I run a restaurant like that? Is there anything you can do to help?"

"Just give me the facts, please."

"Listen, I'm not a rich man. And with the recession, nobody's going out to eat anymore. Before we get into this, you have to tell me how much it's going to cost me."

"I come on site, check it out, and send

you a report by the end of the week. Cost you two C-notes."

"Two hundred? You're one of those guys who charges a lot."

"The best always do."

"Okay, you win. I got no choice. Either I solve this problem, or I'm out of business. Can you come over to the Ellipsoid Restaurant right away?"

"Check."

I cradled the piece and screwed in a cigar instead—they're an important part of the business. I don't light 'em, it's just that they make everything I say sound more important—the Winston Churchill Effect. That means a lot when you're charging money for your opinion. And let me tell you, it's tough working with the public. Everything's emotional for them, they don't under-

The unequaliser— from Klark-Teknik Research.

When you're engineering the sound system for a major auditorium, you need something special in fit-and-forget technology ... the Klark-Teknik Research DN301. This Attenuating Graphic Equaliser has an unfair advantage over the competition: the micro-electronic reliability of active-circuit filters and thick-film technology earn it a 5-year parts warranty.

Designed for theatres, conference centres and multi-media installations, 30 precision faders give up to 15dB of cut at 1/3

octave ISO frequencies matching our DN60 Spectrum Analyser. The state-of-the-art DN301 has sweepable high and low pass filters and selectable low pass slope. 20dB overall gain restores signal gain to unity, and a built-in failsafe bypass ensures uninterrupted performances.

Specification includes:

Frequency response ± 0.5 dB

20Hz-20kHz

Distortion $< 0.01\%$ @ 1kHz

Equivalent input noise < -90 dBm

Output gain 0 to +20dB

The Klark-Teknik promise
— a bigger investment in the future with:

1. Greater R&D investment, with 12% of all company personnel directly involved in new product development.
2. Consistent attention to production economies for professional performance at 'breakthrough' prices.
3. Effective Reliability Control during manufacture.



KLARK TEKNIK



British designed. British made



Manufactured by Klark-Teknik Research Limited
Coppice Trading Estate, Kidderminster DY11 7HJ,
England. Telephone: (0562) 741515 Telex: 339821

Klark-Teknik Electronics Inc.
262a Eastern Parkway, Farmingdale,
NY 11735, USA. Telephone: (516) 249-3660

Omnimedia Corporation Limited
6653 Côte de Liesse/Dorval, Quebec H9P 1A3,
Canada. Telephone: (514) 636 9971

Circle 20 on Reader Service Card

stand about facts. When you're a pro, things are easier. The facts decide everything real quick. A fact is something that solves the problem and lets you make a buck, too. As far as determining the facts, if you know how to handle them, opinions work just fine. That's something a lot of people don't understand about the consulting business. It's a business.

I put my mind back to the Ellipsoid Restaurant. Clearly a case of sound intrusion. Probably a rock club across the street, much to the patrons' dining discomfiture. Not the first such case I had handled. I remembered the church with the car wash next door. Sunday morning is a great time for a wash and wax. I took my feet off the desk and went over to the closet and fished out my three-piece suit. I used to do consulting in blue jeans. Then I bought a gray pinstripe and doubled my rates. Like I say, it's a business.

I parked my chopper up the street and locked the helmet to it (that's a detail I found best to suppress when I was on the job). I hiked down the sidewalk and soon encountered the problem. Through big plate glass windows I could see an exercise class of thirty energetic young women jumping to the beat of the New Wave Opera's hot single, "Let's Get Digital." Massive air conditioners mounted overhead masked most of the music to the street, and any local ordinance as well, but I suspected that the restaurant next door was having a hard time of it. I peered in, with strictly professional curiosity. The speakers were rigidly mounted on the wall adjoining the restaurant. I put my fingers to the glass—it was loud inside. Then, an especially energetic young woman danced over to the window and gave me the bit that TV football viewers see all the time—it doesn't take a lip reader to size it up. I backed away and paused outside the restaurant door to begin dictation; little did the clients know that I was writing their report on their time.

"Report on sound intrusion problem at the Ellipsoid Restaurant. Introduction to the matter investigated. I visited the Ellipsoid Restaurant for the purpose of evaluating a sound intrusion problem reported to me by the restaurant's owner. A music playback system used for dance and exercise classes in an adjoining space was producing sound levels in the restaurant which the owner felt were excessive. To investigate that claim, and quantify its circumstances, I brought measuring devices to collect data for on-site evaluation, as well as post-analysis. This report contains the data collected, and evaluation of the data."

I pushed open the glass door and walked in. The intrusion was clearly there, a little worse than I would have suspected, but nothing to have to shout

over. The manager spotted me at the door. He was wringing his hands and probably doing more to upset the patrons than the sound itself—clearly a nervous type. I would need my best bedside manner.

"Are you the consultant?"

"Yes, sir."

"Well, what can I do?"

"That depends. First let me take some measurements."

I fished my SPL meter out of my pocket.

"What is that thing?"

"This is a sound pressure level meter; I'll use it for real-time evaluation of sound levels in the restaurant. It contains a microphone, amplifier, and ballistic meter. It will allow me to

determine the background ambient noise of the restaurant, and the increase in noise level from the adjoining exercise room."

"What's that stuff say—dB? A and C?"

"The basic unit of sound measurement is the decibel. It is a unit that relates, for example, the intensity of sound to an intensity level corresponding to the human hearing mechanism. Specifically, decibels are defined in terms of the logarithm of the ratios of the measured pressure to a reference pressure. Subjectively, a 1 decibel increase in sound is barely perceptible. 3 decibels is perceptible. 5 is clearly noticeable, and a 10 decibel increase is subjectively double."

"Oh yeah? I'll bet that noise is at least

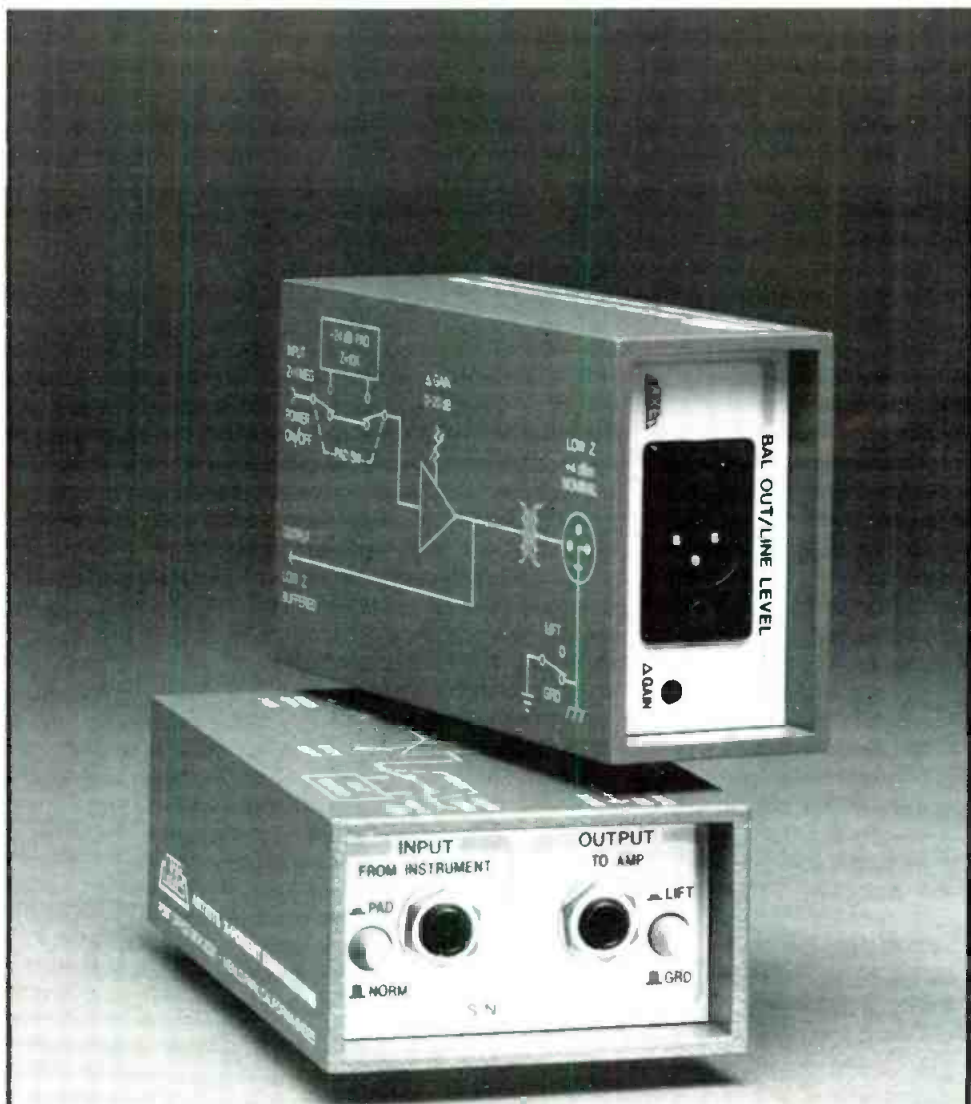

The Incomparable Direct Box



ARTISTS X-PONENT ENGINEERING

BOX 2331 DB • MENLO PARK, CA 94025 • (415) 365-5243

© 1983 AXE

Circle 21 on Reader Service Card

100 decibels higher. It's really loud."

"I doubt that, sir. The decibel permits measurements of sound pressure level from the softest to the loudest sounds. For example, a quiet countryside might have an ambient sound pressure level of 30 dB SPL, while a jet take-off might register 150 dB SPL. This restaurant might register around 70 dB SPL, and the intrusion is probably less than 5 dB SPL, peak."

"What are the A and C buttons on that thing?"

"In performing sound measurements, varying weighting filters are used to provide for a greater range of information derivable from the acoustic data. To accomplish that, the frequency response of the measurements may be altered. For example, the C scale provides a flat response measurement of sound."

"But you have the A button pushed!"

"Sir, the human hearing mechanism is not flat. Thus, to more closely approximate the way a human would perceive a sound, the A weighting curve is used to attenuate both high and low frequencies of the measurement, in the same way that our ears normally attenuate highs and lows."

"I don't understand any of this. Where did you pick this up? Say—are you some kind of student?"

"On the contrary—just call 284-2439."

"284-2439? What's that?"

"The Pohlmann School of Music Engineering."

"That's okay; I want results, not lectures."

"Then I'll proceed directly to the measurements."

I perked up my ears and got down to business. The intrusion was evident; clearly the girls next door were working up a sweat. The extreme low frequency beat of the amplified music had set the adjoining wall in motion, I could feel it with my fingertips, and air transmission leaked some mid-range as well. Using ears and meter, I worked my way through the restaurant. While I was at it, I used my tape measure to take some dimensions. A half hour later I pulled out my recorder.

"Collected data. Sound pressure measurements established the ambient noise levels in the restaurant. Levels were consistent throughout the restaurant, but slightly higher near the kitchen. When music was being played, and participants were exercising in the adjoining room, the sound pressure levels in the restaurant were increased, especially along the adjoining wall, where a long row of tables is placed. This noise increase occurs as drum

beats, shouts and cries, which most easily penetrate the wall. Also, the volume of playback in the exercise room is sufficient such that some melodic lines can be heard at the tables. Average data of sound pressure levels along the adjoining wall, measured two feet from the wall, and three feet above the floor (where a patron's ears might be), are as follows: ambient level of 64 dB SPL(A), peak readings from intrusion of 72 dB SPL(A). Thus, the exercise class contributes amplitude peaks of 8 dB SPL(A), which results in an increased noise level in the restaurant."

I pocketed the recorder and gave a sign to the anxious owner; he hurried over and sat down at a table.

"Well, what do you think?"

"The amplitude of the intrusion peaks are 8 dB SPL(A)."

"Is that bad?"

"It makes things a little noisier."

"But how noisy?"

"That's not an easy question—it's important to correctly interpret the measured data. It would be erroneous to state that the exercise class was responsible for raising the sound level in the restaurant from, for example, that of an average conversation to that of a busy street. Rather, the class punctuates a sound level of that of an average conversation with impulses comparable to the levels found in a busy street. The distinction is not slight; for example, in the former case, conversation might be difficult or impossible whereas in the latter case, conversation is accompanied by louder impulses which would contribute annoyance, but not cause unintelligibility."

"Well how much is 8 dB, anyway?"

"Judge for yourself, in terms of the numbers I gave you before. These peaks are more than noticeable, and 2 dB short of being a subjective doubling in instantaneous sound level. Of course, the psychological aspects of the disturbance should be noted. The transmitted sound is not continuous in nature, but rather occurs mainly in peaks of sound audible as drum beats, shouts and cries. In many respects, this augments the noticeability of the intrusion; for example, for a person trying to sleep, the steady drone of an air conditioner is soon ignored by the ear and may be perceived as being soothing, whereas the staccato peaks of sound from a dripping faucet may be a source of real annoyance. Furthermore, the musical nature of the intrusion has greater ear-catching ability—I don't know about you, but I find myself trying to figure out the tune."

"I'm not trying to figure out the tune. I'm trying to figure out how much money I'm losing."

"I understand, sir. A final note should be made concerning these sound level

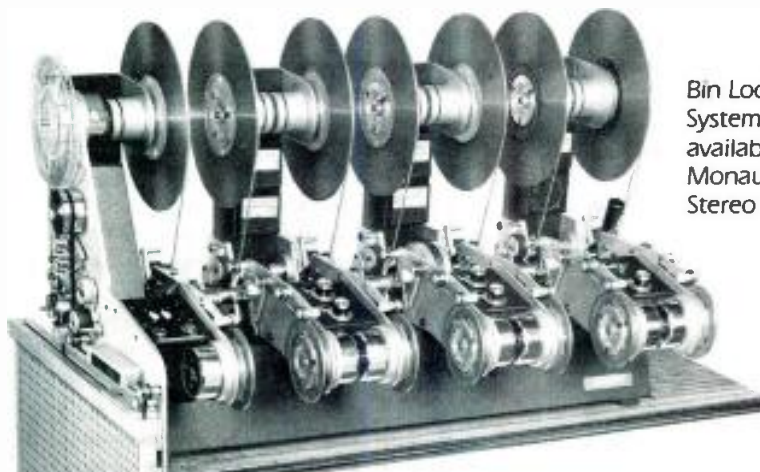

Bin Loop System available in Monaural or Stereo

DEPEND ON IT!

Magnefax works...

98% of all of our tape duplicating systems produced since 1959 are still in operation.

Crystal sharp copy after copy, up to 2400 per shift, reliable and easy to use.

Best of all...affordable. Bin Loop systems start at under \$20,000.

Professional 1/4" and cassette tape duplication systems. Unique, compact Bin Loop model shown. Available in most track configurations.

magnefax

International, Inc.

Route 1, Rogers, AR 72756
(501) 925-1818
TLX 53-6433 AIDC LRK

comparisons. These levels were measured during an exercise song, and then in between songs. After the class is over, the overall sound in the restaurant will probably decrease by several decibels."

"Why's that?"

"This is due to the 'Cocktail Party Effect,' in which in the presence of competing sound, each talker raises his individual acoustic output to be heard. On the average, this does not help intelligibility, but serves to increase the background level."

"So what's the bottom line?"

"The drum beats of the songs are clearly heard, as well as some of the melodic line, and the shouts and cries of the exercisers. Clearly the class provides audible competition."

"What do I do?"

"Talk to the lady next door. Ask her to decouple her speakers from the wall, and play the music at a lower volume."

"I've tried! But she won't listen!"

"Then frankly, I would call 284-8664."

"284-8664? What's that?"

"The Pohlmann Expert Witness Agency."

"You mean go to court?"

"Precisely."

"I don't want that—I hate lawyers, I hate them!"

"Okay. There's another solution, but it isn't cheap."

"What is it?"

"Sound isolation treatment. However, without source reduction, only costly treatments could provide sufficient transmission loss to contain the low frequency sound. Most of the intrusion occurs as structure-borne transmission. The loudspeakers in the dance space vibrate the air in the space as well as the adjoining wall; the wall acts as a diaphragm to the restaurant, transmitting the vibrations. The only way to stop this transmission is to increase the mass of the adjoining wall, or build a heavily-reinforced partition parallel to the existing wall—not cheap."

"I'll never be able to afford it!"

"Wait, there's a cheaper way—source treatment. Offer to redecorate the dance studio and modify her stereo system. First, the loudspeakers must be acoustically isolated from the structure to reduce structure-borne transmission. Second, the low frequency playback levels must be reduced by equalizing the sound system with graphic equalizers. Third, to help reduce the sound pressure levels of higher-pitched shouts, the absorption of the room must be increased by placing substances such as cork or heavy draperies on *all* the walls, not just the adjoining wall. While you're at it, the absorption of the receiving room—your restaurant—should be increased as well. Understand that absorption is not an effective alternative to isolation.

but at least you can help control the levels. Fourth, any air-borne transmission paths such as common air ducts or wall leaks between the rooms must be eliminated. For example, make sure there aren't any back-to-back AC wall outlets in the adjoining wall."

"It still doesn't sound easy, or cheap."

"It isn't. For a good estimate, call 284-6322."

"284-6322? What's that?"

"Pohlmann Contracting."

"You do that too?"

"On the side."

"Well, no thanks; my son-in-law is pretty handy. I'll get him over here. Are you sure there's no easy answer?"

"If there was, I'm sure you would have thought of it."

"You're right."

"Absolutely. I think that wraps it up. I'll send you a final report, with drawings."

"Okay, you've been a big help—I really appreciate it. Hey, would you like some spinach souffle? It's on me."

"No, thank you."

"Well, is there anything I can do for you, anything at all? My brother can give you a good price on a new suit."

"There's one thing you can do."

"Just name it!"

"Don't make me call 284-6743."

"284-6743? What's that?"

"The Pohlmann Collection Agency."



10 ways to solve your most common microphone problems.

- Input Overload** A15AS Microphone Attenuator—inserts 15, 20 or 25 dB loss to prevent overload.
- Phasing** A15PRS Switchable Phase Reverser for balanced lines.
- Low-Frequency Noise** . . . A15HP High Pass Filter—reduces low-frequency noise and proximity effect.
- High-Frequency Noise** . . . A15LP Low Pass Filter—reduces objectionable high-frequency noise.
- Lack of Presence** A15PA Presence Adapter—adds intelligibility and brilliance.
- Excessive Sibilance** A15RS Response Shaper—sibilance filtering, plus flattened response.
- Adapting Line Level to Mic Input** A15LA Line Input Adapter—converts balanced low-impedance mic input to line level input.
- Matching Bridging Isolating** A15BT Bridging Transformer—matches balanced or unbalanced devices of different impedances.
- Troubleshooting** A15TG Tone Generator—700 Hz signal helps check levels, connections, mixer inputs, and cables.
- Microphone Impedance Matching** A95 and A97 Series Line Transformers—make it possible to connect low impedance lines to mid and high impedance inputs (or vice-versa).

Shure Brothers Inc., 222 Hartrey Ave., Evanston, IL 60204. (312) 866-2555.

SHURE®

THE SOUND OF THE PROFESSIONALS® ... WORLDWIDE

Sound Reinforcement

Equalization in Sound Reinforcement Systems: Control Room Monitors

• A little history may be in order before we get into technical details. Prior to the mid fifties, there was very little concern with the layout of control rooms and the choice and placement of loudspeakers. The medium at that time was mono, and loudspeaker placement was not considered at all critical. When speakers were mounted on a side wall, many engineers literally listened out of one ear. It was not until the general acceptance of stereo in the late fifties that studio personnel began to wrestle with the problems of monitoring and the environment around it. The requirement for accurate monitoring of phantom images in stereo meant, at the very

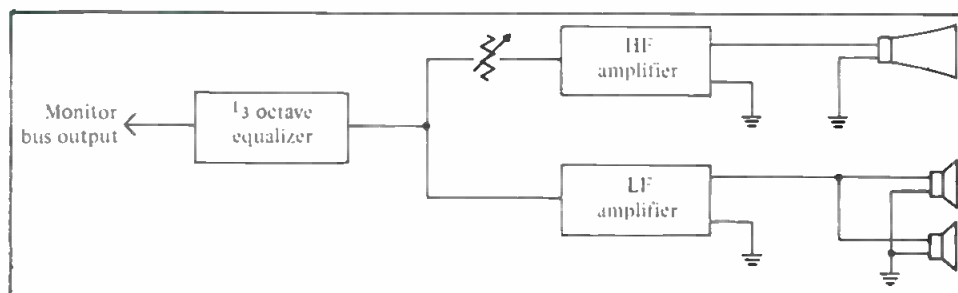

Figure 1. The position of the equalizer in the monitoring chain.

least, that the mix-down facility had to have a fairly symmetrical layout and

that the loudspeakers had to be closely matched.

It was not until the late sixties that control rooms began to lose their clinical look and take on the atmosphere of a pleasant place in which to create music. About this time, custom monitor systems began to rise in popularity, and what set them apart from most of the stock systems of the day was their attention to low-frequency headroom. Music was unquestionably getting louder, and most of the older monitors simply could not play loud enough to suit rock producers and artists.

THE NEWER CONTROL ROOMS

The acoustical boundaries of these new control rooms were quite different from what had existed before. They made use of what are called bass traps. These are structures that soak up considerable amounts of low-frequency power through acoustical and mechanical damping. In the process of doing this, the low-frequency response in the room is smoothed out, and peaks and dips due to standing waves are diminished. Considerable electrical power may be required to drive the low end of the system, and biamping became a part of general practice.

The modern control room usually has only a stereo pair of speakers placed so that the included angle of the system's high-frequency section at the mixer's position is no more than sixty degrees. A general goal is to have fairly even acoustical absorption in the room as a



2 Channel Octave Band Graphic Equalizer L-C ACTIVE 4100A

The model 4100A features Active, Inductor-Capacitor (L-C) Tuned Filters. The resonant frequency of each filter is derived PASSIVELY by a Tuned L-C Pair. This drastically reduces the number of active devices necessary to build a Ten Band Graphic Equalizer. Only seven operational amplifiers are in each channel's signal path: THREE in the differential amplifier input; TWO for filter summation; ONE for input level control; ONE for the output buffer. The result . . . the LOWEST "Worst Case" NOISE of any graphic equalizer in the industry . . . -90dBv, or better.

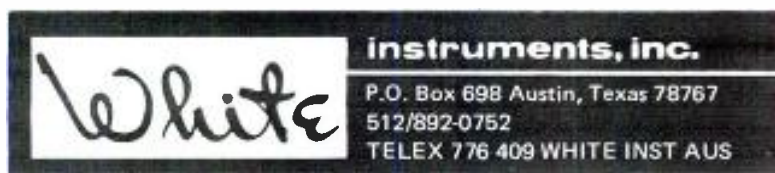

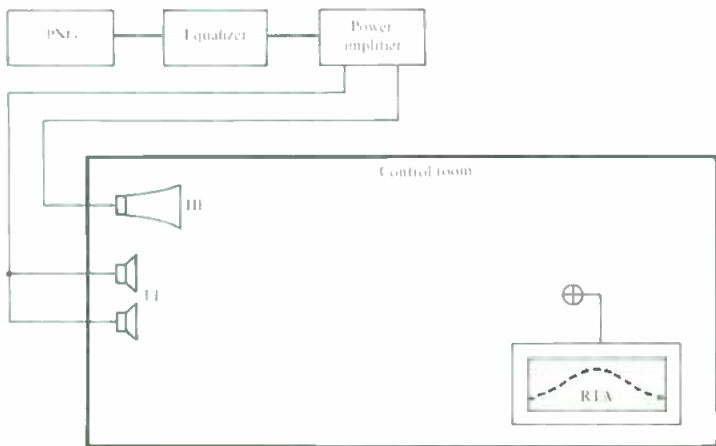

Figure 2. A method for equalizing.

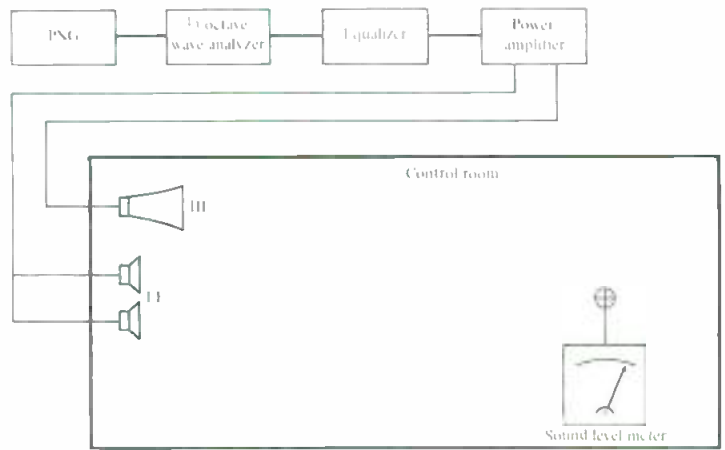

Figure 3. An alternate method for equalizing.

function of frequency. However, just how the absorption is to be arrayed in the room is the subject of many hot debates, which we will try to avoid.

The monitoring chain today almost invariably includes one-third octave filters located just ahead of the power amplifiers, as shown in FIGURE 1.

THE NEED FOR EQUALIZATION

Even if due attention has been paid to the choice of monitoring components, there will be response variations, especially at lower frequencies, due to boundary effects in the neighborhood of the low-frequency drivers themselves. If the room is structurally symmetrical, these response aberrations will track between the two channels. However, since the room may be used for critical mix-down calling for careful musical judgements on the part of producers, engineers, and artists, flat overall response is almost a necessity. Also, since many producers travel from one facility to another across the country, it is desirable that one environment be not too unlike another. At least equalizing the systems flat provides something of a starting point in this quest.

THE EQUALIZATION PROCEDURE

There is no one preferred method of equalizing a room. In FIGURE 2, we show the most common method. Here, a pink noise generator (PNG) has been inserted ahead of the equalizer, and room response is monitored on a real-time analyzer (RTA). While this method is the speediest, it is worth remembering that the process should not be hurried.

FIGURE 3 shows another method in which one-third octave bands of noise are individually measured and plotted. This method obviously takes time, but it allows the user to hear any aberrations, such as sympathetic vibrations, which might be present only at certain frequencies.

The individual noise bands also



“Now You Can Afford to Delay . . .”

by Deltalab

The ADM 310 unit offers 310ms in 10ms increments at *full power bandwidth* (20Hz to 20KHz) with greater than 90dB dynamic range.

A true digital delay product with exceptionally natural sound quality, for applications where one or even a dozen delays, via serial and parallel coupling, are needed. Unobtrusive sound reinforcement in churches, theatres, and function rooms; pre-reverb delay in studios, and special effects such as simple doubling and echo. **SUGGESTED RETAIL \$599**

For more information, contact:



DeltaLab Research, Inc.
27 Industrial Ave.
Chelmsford, MA 01824

The Audible Difference!

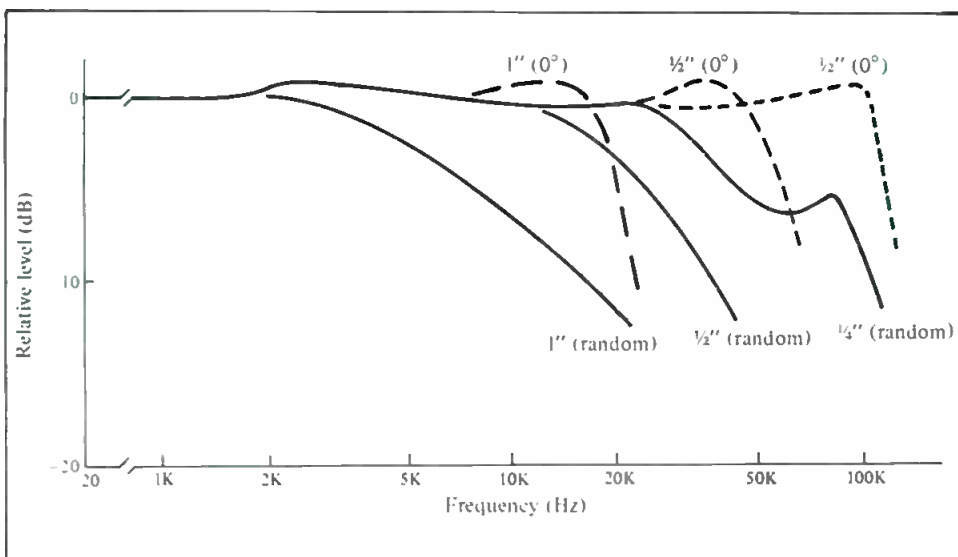

Figure 4. Characteristics of measuring microphones.

enable the user to check the balance between the stereo speakers by noting the position of center phantom images one band at a time. From about 200 Hz upwards, all bands should be locked in the middle for a listener seated on the median plane. With a wide band of noise, this test is not so precise.

TEST MICROPHONES

Anybody trying to equalize a monitor system with anything less than a high-quality 0.5 inch measurement microphone is asking for trouble. FIGURE 4 shows a comparison of the on-axis and random incidence response of 1-, 0.5-, and 0.25-in. instrumentation micro-

phones. Note that the random incidence response of the 0.5- and 0.25-in. models is smoothest, and this response is approximated by positioning the microphone so that its axis is ninety degrees to the speaker rather than pointing directly at the speaker. The instructions which come with instrumentation microphones usually point this out clearly. Obviously, some big mistakes can be made if the user is careless in positioning the microphone.

Some specialists in equalization use up to three microphones, combining their outputs to get an average over the small space occupied by the mixer. This is not the general case, and most equalization is done with a single microphone located approximately at the position of the mixer's head.

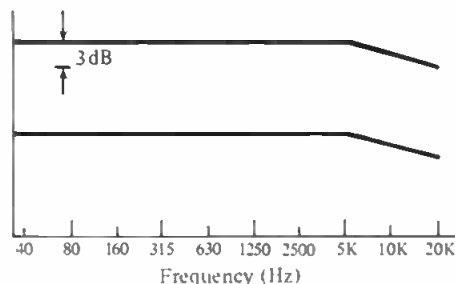

Figure 5. Typical contours and tolerances that can generally be maintained in the equalization process.



MODEL PEQ-1 PROGRAMMABLE GRAPHIC EQUALIZER

- 64 CURVE MEMORY
- REMOTELY CONTROLLABLE
- 105 dB S/N (GUARANTEED)
- MASTER/SLAVE LINKABLE
- 16 BANDS (2/3 OCTAVE)
- NON-VOLATILE MEMORY
- ±14 dB BOOST/CUT RANGE
- VARIABLE INTENSITY SCREEN
- 1.5 MS RECALL TIME
- COMPUTER INTERFACEABLE

Specify response curves, store them in memory, recall and display them instantly with precise repeatability. PRO-GRAPH is destined to become the new industry standard, request the free brochure to find out why!

polyfusion INC.

92 BENBRO DRIVE
BUFFALO, NY 14221
(716) 681-3040

PREFERRED CONTOURS: ARE THERE ANY?

The general rule is flat out to about 5 kHz with a slight roll-off above. How much roll-off depends on user preferences as well as the characteristics of the particular high-frequency components in the monitors. When we consider that the sound field at the mixer's position consists about equally of direct and reflected sound, it becomes apparent that the speaker's off-axis response can affect the measurements significantly.

For example, let us assume that a given high-frequency element narrows considerably with rising frequency, but otherwise is flat on axis. Then, maintaining flat response beyond 5 kHz may result in there being a slight rise in the on-axis response at the mixer's position. Things will probably sound too bright.

On the other hand, equalizing one of the newer constant coverage high-frequency devices flat beyond 5 kHz will maintain flat on-axis response at the mixer, and music will be better balanced. (See the discussion of power response in last month's column.)

There are no absolutes here, and many factors must be taken into account. FIGURE 5 shows typical contours and tolerances which can generally be maintained in the equalization process. ■

Updated Recording Studio Handbook

A must for every working professional... student... audio enthusiast

Features latest state-of-the art technology of creative sound recording.

21 Fact-Filled Chapters

- I. The Basics**
 1. The Decibel
 2. Sound
- II. Transducers: Microphones and Loudspeakers**
 3. Microphone Design
 4. Microphone Technique
 5. Loudspeakers
- III. Signal Processing Devices**
 6. Echo and Reverberation
 7. Equalizers
 8. Compressors, Limiters and Expanders
 9. Flanging and Phasing
- IV. Magnetic Recording**
 10. Tape and Tape Recorder Fundamentals
 11. Magnetic Recording Tape
 12. The Tape Recorder
- V. Noise and Noise Reduction**
 13. Tape Recorder Alignment
 14. Noise and Noise Reduction Principles
- 15. Studio Noise Reduction Systems**
- VI. Recording Consoles**
 16. The Modern Recording Studio Console
- VII. Recording Techniques**
 17. The Recording Session
 18. The Mixdown Session
- Three all-new Chapters**
 19. The In-Line Recording Studio Console (The I/O Module, The Basic In-Line Recording Console, Signal flow details.)
 20. An Introduction to Digital Audio (Digital Design Basics, Digital Recording and Playback, Error Detection and Correction, Editing Digital Tapes.)
 21. Time Code Implementation (The SMPTE Time Code Time-Code Structure Time-Code Hardware.)



\$39.50

Easy to Order

You can enclose a check with your order or charge it to Master Charge or BankAmericard/Visa. Use the coupon below to order your copies of the new updated *Recording Studio Handbook* (\$39.50)

ELAR PUBLISHING COMPANY, INC.

1120 Old Country Road, Plainview, N.Y. 11803

Yes! Please send _____ copies of THE RECORDING STUDIO HANDBOOK. \$39.50. On 15-day approval.

Name _____

Address _____

City/State/Zip _____

Total payment enclosed \$ _____
(In N.Y.S. add appropriate sales tax)

Please charge my Master Charge
 BankAmericard/Visa

Account # _____ Exp. date _____

Signature _____

(charges not valid unless signed)

Outside U.S.A. add \$2.00 for postage.

Checks must be in U.S. funds drawn on a U.S. bank.

The *Recording Studio Handbook* is an indispensable guide with something in it for everybody. It covers the basics beautifully. It provides in-depth insight into common situations and problems encountered by the professional engineer. It offers clear, practical explanations on a proliferation of new devices. **And now it has been expanded with three all-new chapters . . . chapters on the in-line recording studio console, digital audio and time code implementation.**

Sixth printing of industry's "first" complete handbook

The *Recording Studio Handbook* has been so widely read that we've had to go into a sixth printing to keep up with demand (over 30,000 copies now in print). Because it contains a wealth of data on every major facet of recording technology, it is invaluable for anyone interested in the current state of the recording art. (It has been selected as a textbook by several universities for their audio training program.)

Highly Acclaimed

Naturally, we love our book. But don't take our word for it. Here's what others have to say:

"John Woram has filled a gaping hole in the audio literature. This is a very fine book . . . I recommend it highly." *High Fidelity*

"A very useful guide for anyone seriously concerned with the magnetic recording of sound." *Journal of the Audio Engineering Society*

15-Day Money-Back Guarantee

When you order *The Recording Studio Handbook* there's absolutely no risk involved. Check it out for 15 days. If you decide it doesn't measure up to your expectations, simply send it back and we'll gladly refund your money.

Digital Audio

Talking to Each Other

• Last month, we discussed the use of a computer bus in digital audio applications. We described a situation in which different kinds of digital audio equipment may "talk" to each other over a common bus. This bus allows equipment interconnections without actually having point-to-point wiring. Each piece of equipment is connected to the bus, which allows the equipment to transmit to and receive from other equipment. This computer bus will become much more important as the amount of digital audio equipment increases. We can even imagine a full studio or broadcast house with hun-

dreds of interconnections. The bus idea solves the problem.

Our first order of business is to devise a means of controlling the bus. For example, when (and how) does a given piece of equipment place its data onto the bus, and when does a receiver accept the data? Time sharing can get quite complex unless some sort of protocol for format is clearly established. There are two basic forms of protocols: synchronous and asynchronous. In the former, all activities are fixed. In the latter, each activity takes place in response to a previous activity, but not at a fixed time. To illustrate

the difference, consider a memory system. It takes a certain amount of time for the memory to respond. In a fixed synchronous format, the allocated response time must be greater than the slowest memory. In the free-form asynchronous protocol, the memory can take as much time as it needs; however, control flags must now be included to allow the memory to indicate when it is finished.

Bus system hardware is usually treated as a separate discussion and we will not dwell on it here. However, the illustration in FIGURE 1 shows how any one device can signal a master system

UNCOMPROMISING WIRELESS MICROPHONES

Finally, you can choose a wireless mic to fit the application. The Telex WHM-300, the electret wireless transmitter mic for uncompromising speech clarity. Or a Telex WHM-400 dynamic wireless transmitting mic for vocal entertainment with rich, full bodied audio quality. Both elegantly tapered and without trailing antenna wires. Or select the miniature electret WLM-100 lavalier mic (or any standard dynamic mic) with our belt-pack transmitter.

Combined with the superb Telex dual diversity* FM receiver, you'll have a wireless system that is as good as any hard wired mic, and at a reasonable price. Write us today for full details.

Quality products for the Audio Professional

TELEX

TELEX COMMUNICATIONS, INC.

9600 Aldrich Ave. So. Minneapolis, MN 55420 U.S.A.
Europe: Le Bonaparte Office 711, Centre Affaires Paris Nord 93153 Le Blanc-Mesnil, France



*U.S. Patent No. 4293955. Other patents applied for.

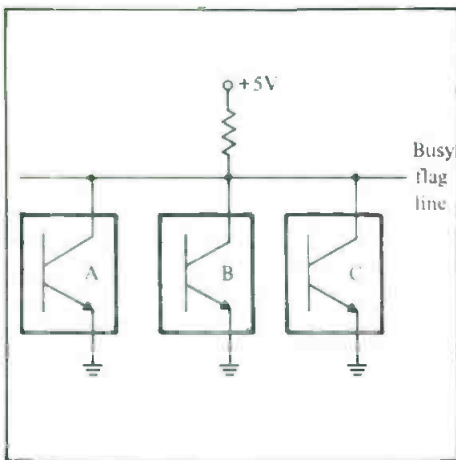

Figure 1. Party line configuration in which one device can signal a master system or other device.

or other devices in a party-line fashion. The hardware is very simple: a single wire is pulled up to +5 volts, but any attached device can ground it. Such a line might be the "busy" flag. When any device is active, it grounds the line. This allows all other devices to know that a particular bus, or part of a bus, is busy.

LANGUAGE

In both the design and analysis of a bus system, we need a language that feels natural and will separate the electronic circuits from the form. Let us begin a hypothetical bus system. A device that is to talk to another device

needs to consider the following points: How does it tell if the bus is free? We need a Bus-Free Flag. When the flag is true, then a device knows that it can use the bus. When it has begun to use the bus, it must prevent other devices from doing so. This would suggest that the active device setting the Bus-Free Flag should be false. We might thus say, Bus-Flag = busy.

Next we need a way for the transmitting device to specify the destination. This suggests the use of an auxiliary address bus. At this point, we have the following: a data bus for actually transmitting the audio data, a control bus that contains the flags indicating the status of various activities, and an address bus for selecting the receiving device. Moreover, we see that the protocol is actually a sequence of logical operations. A device which wishes to create a connection must first ask: Is the address bus free? If not, then wait. When the bus is finally free, then set its Bus-Flag to busy and transmit the address of the receiving device.

We assume that each device has a code number that is unique. Channel 1 on the tape recorder in studio C might have an address of 107 (base 8). The mixing console in studio B might have an address of 303 (base 8) for the reverb send, etc. By placing address 107 on the address bus, the interface for channel 1 of the tape recorder would recognize

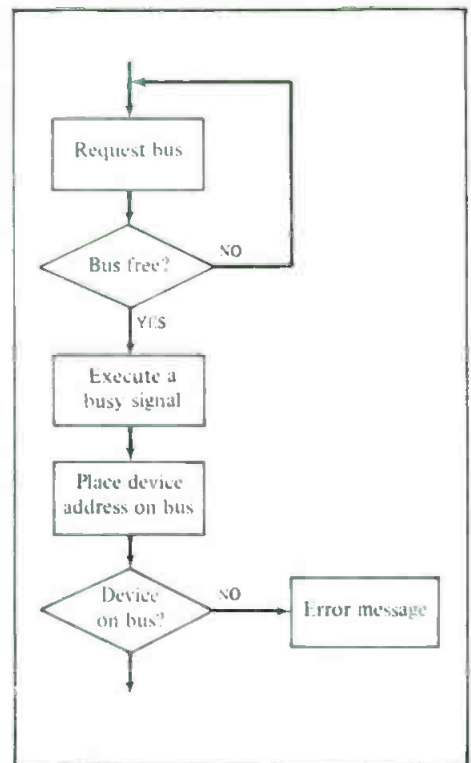

Figure 2. Flow chart of system's bus protocol.

that somebody wants to talk to it. It would, after recognizing that code, send information over another control line called "I-Am-Here." The device that initiated the request would then observe that the destination device was

Looking for a Distortion Measurement System?

The Amber model 3501 is quite simply the highest performance, most featured, yet lowest cost audio distortion and noise measurement system available.

It offers state-of-the-art performance with THD measurements to below 0.0008% (-102dB), maximum output level to +30dBm and noise measurements to below -120dBm.

It has features like automatic operation, optional balanced input/output and powerful IMD measurement capability. It includes comprehensive noise weighting with four user changeable filters. Unique features like manual spectrum analysis and selectable bandwidth signal-to-noise measurements.

The 3501 is fast, easy to use and its light weight and small size make it very portable. It can even be battery powered.

And the best part is that it is 20% to 50% below what you would pay elsewhere for less performance. The Amber 3501 starts at \$2100. Send for full technical details.



amber

Amber Electro Design Inc.
4810 Jean Talon West
Montreal Canada H4P 2N5
Telephone (514) 735 4105

present on the bus system so that communication could begin. On the other hand, if the tape recorder is missing or turned off, the requesting device would not receive an I-Am-Here message, and it would then know that communication is not possible. Other control lines could be used to indicate the reason for not responding. For example, if the tape recorder was connected to another source, it might respond on the "I-Am-Occupied" line; such information is then reported to the user or the master bus control.

This kind of interaction is called Bus Protocol. The specification of a bus includes the types of signal wires, and the format of the sequence. Notice that the data part of the bus could also have been used for address specification of devices. However, this would mean that the amount of data that could be placed on the bus would be reduced because extra time would be needed.

In our hypothetical example, we don't want to mix address specifications with audio data because of the

sample/second; we do not allow mixing of sampling rates.) This means that the sending device has to place its data on the bus during this slot and be off for the next slot. Let us define the data phase as 100 nsec and the guard interval as another 100 nsec. Although these numbers appear to be very small, they are well within today's technology, even if difficult to achieve.

Once having performed its handshake, the address bus system must now find a consistent slot number for communications. If both transmitter and receiver assume slot number 19, for example, communication is possible. However, not only must both the sending and receiving device assume the same slot number, but we must find a way of determining that this slot is free.

To deal with this issue, we introduce the concept of a bus-master control. This is the supervisor for all bus activities. It also hangs on the control bus, but it also serves to keep everybody happy. Let us introduce another control

device is finished transmitting; its slot number could be used elsewhere, but the master control does not know that. Another line may thus be used for specification of the release function. The design of such a system is extremely complex and very difficult. In the computer business, bus systems are a major issue. Not uncommonly, bus definitions become industry standards. For example, Digital Equipment Company has a Uni-bus, a Q-bus, a Mass-bus; Motorola has a VME bus and Versa bus. A given device interface can only plug into its defined bus. Two different bus systems will have different kinds of flags, different requirements, loading rules, etc.

A formal description of bus protocol is usually done in the form of a flow chart. Each rectangular block shows an action which happens when the flow reaches that point. Each diamond shaped box shows a test and a conditional result. In the example of FIGURE 2, a request for a bus starts the process. The test of bus free? results in either a

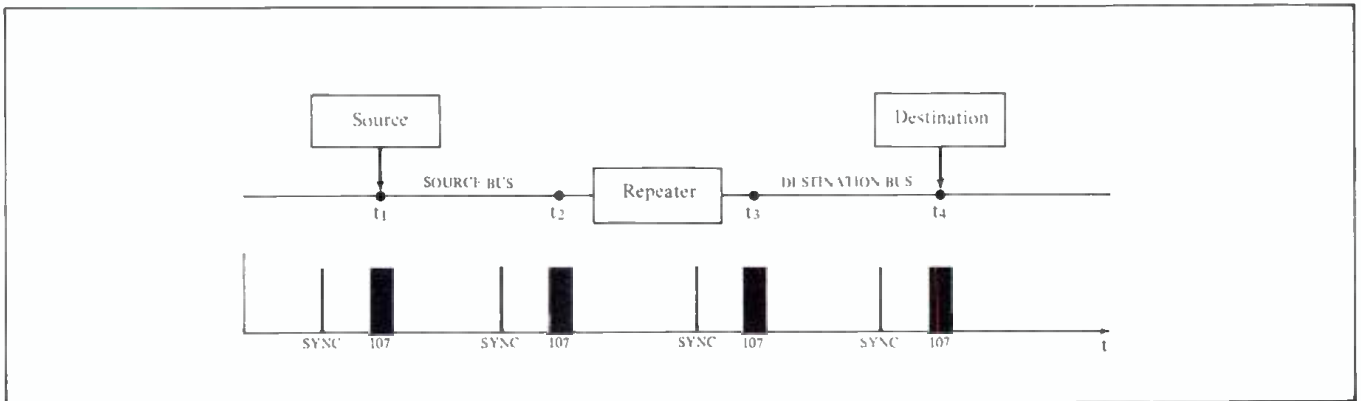

Figure 3. Source and destination buses showing the location of the sync and of slot 107.

need to have a very high bit rate on the audio channels. Therefore, let us assume that control and address communications take place on their own wires, and that audio data has its own dedicated wires. Since control is a low-speed operation, we are not particularly interested in the technical issues. It doesn't matter much if it takes 3 μ sec or 30 msec to establish a connection. After all, in a manual patch system it may take 30 seconds to establish a connection.

To continue our example, let us assume that the audio data bus is divided into some number of fixed slots. With 16 coaxial lines running at 5 Megabits/second, there would be 200 nsec for each slot, or 100 slots with 20 μ sec per sample. (The example assumes all equipment running at a standard 50 k

wire called Request For Free Slot. When this line is asserted, the master control places a slot number on the address bus. This number is accepted by both the sending and receiving device. This completes the connection.

If we step back and look at the process of creating a bus system, we notice that we must define a class of flags for communication. Everybody on the bus can either read or transmit to these flags. Typically, flags that can be asserted by the devices are made up of open-collector logic. It sits at a high level and the assertion is made by grounding it with an open-collector gate. The process must continue until all of the issues are defined.

At this point, we have not yet provided a mechanism for releasing a given slot number. Suppose that a

yes or no. If no, the flow retests the bus, looping until a yes is detected. The flow then continues on to the next action. These flow charts can become very complex.

LIFE IS HARD

Bad news: The hypothetical bus which we have begun to design for our broadcast house will not work, even if we have been very careful. We have overlooked the speed of light! Electrical information only moves at about 75 percent of the speed of light, which means that information only travels at about 0.75 nsec per foot. Our 100-nsec slot thus corresponds to 133 feet. At a given time, a device in one studio may think that it is seeing slot 120, while the device 266 feet away thinks that it is seeing slot 121. It is a major intellectual

problem to create two clocks separated by a respectable distance that show the same time. This issue is relevant at these kinds of speeds. The control bus is OK because it can run slowly; the audio bus is the problem. Computers have the same problem, except that the computer backplane is relatively small, e.g. three feet. Thus, electrical signals can get from one part of the computer to another in only 4 nsec. Nevertheless, the fastest computers have speed of light as a design issue. This is one reason why dense circuits are important, since the distance traveled is small.

The most direct solution to this problem is that of increasing the slot duration. If a slot was 1 μ sec wide instead of 200 nsec, the equivalent distance would be 1300 feet. Only the largest buildings would have this kind of distance. However, the obvious disadvantage is that we could only get 20 audio channels instead of 100.

There is a more complex alternative. Let us define two uni-directional audio buses. The first one allows any device to transmit to a master control repeater. The second one is used to communicate from the repeater to all devices. Because the clock is delayed by the same amount as the audio slot, a given device places its data in the correct location even if there is a delay. If two devices are separated by 133 feet, they would

both place the data on the bus at the same time, yet they would be in different slots. It's complex to think of time and space as being interchangeable.

Once having placed data onto the bus going to the master repeater, this data is reproduced and retransmitted onto the other bus. In effect, we have created two different time references. Destination slot 107 will see data that was placed into source slot 107 much later. By forcing communications to take place in only one direction, we can compute the time shift by the delay in the clock for synchronization.

FIGURE 3 shows the location of the sync and of slot 107 along the source and destination buses. Notice that it stays constant relative to the sync, but varies dramatically in absolute time. This means that the interface of each device must compute its local time. It does so by use of a common clock and a sync. Slot 107 might thus be defined as 107 clocks after the sync. Notice that this system does not become limited by the speed of light. Assuming that the bus cable did not have too much dispersion, the cable could be arbitrarily long.

CABLES

At the speeds that we are talking, wire is not ideal. Even RF coax is not ideal. There are several kinds of limits; the most obvious being bandwidth. For

a given type of cable, the higher frequencies become attenuated more and more as the length of the cable increases. To some extent this loss of high frequencies can be compensated by a boost in high frequencies at the receivers. This is not so easy in the proposed system, since the loss of high frequencies is a function of length.

Another difficulty is that of termination and impedance matching. A pulse placed on the cable will be reflected at the cable ends and at any mismatched terminations. The injection of digital information could, conceptually, be done with a current pulse in order to make the impedance equivalent to an open circuit. This is easier said than done.

Finally, for long cables, we are faced with the fact that high frequencies travel slower than low frequencies. This means that the digital pulses spread. If the spread is large enough, then some of the information which was in slot 107 will drift into slot 108 as it travels down the cable.

All of these issues place real-world limitations on the bus system. Fortunately, this discussion is only hypothetical and I am not obligated to present a working design. We should note, however, that these issues will need to be faced in the next decade of digital audio. ■

• • •

In times like these
it's good to know

**The first
duplicator
Garner sold
is still at
work...20
years later.**

garner industries

4200 N. 48th Street Lincoln, NE 68504
Phone: (402) 464-5911 Telex: 438068

And It Looks Like It's Going to Work Another 20

Twenty years ago, Garner Industries manufactured their first high-speed professional dubbing machine. Twenty years later, that machine is still at work making hundreds of dubs a day. In times like these when every dollar counts, it's nice to know that Garner is still building duplicators to last, and we've made some improvements along the way. The Garner 3056 and Garner 4056 cost much less, take up less space, use less power and require far less maintenance than other duplicating machines on the market today. And the new Garner duplicators offer advantages that our first duplicator didn't have:

- Fast 60 ips speed
- No wow/flutter added because of a common capstan drive
- Simplified tape loading
- Long-life modular electronics
- Solid-state modular electronics
- Smooth, quiet operation
- Three-year mechanical warranty.

When you consider the cost of a duplicator, consider what you'll be getting for your dollar. If you want all of the state-of-the-art features in a product that's practically indestructible, then Garner has your machine. The only problem is, if you buy one of our duplicators, you may never need another duplicator.

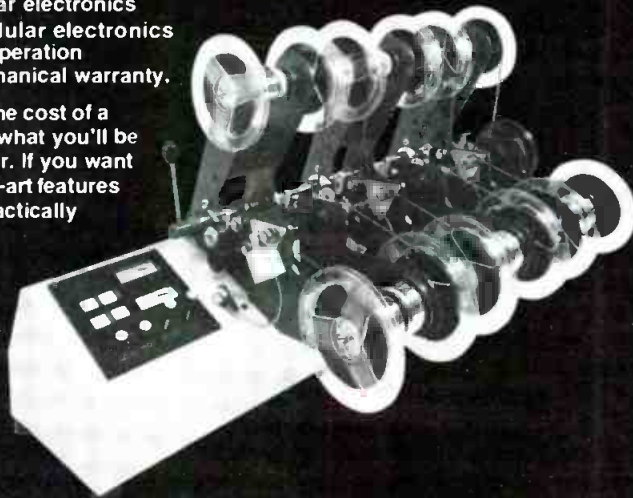

Dependability... Guaranteed

The Revolution Arrives

THE DIGITAL REVOLUTION has arrived—that is, here at *db*. It arrived via UPS, from Technics. The revolution isn't very big—in fact, it takes up less than six inches of rack space. From the outside, it really doesn't look all that revolutionary. It's just another one of those high-tech looking boxes, with enough lights and buttons to properly impress the neighbors. From a distance, it could be a new tuner. But up close, you can read "Compact Disc Player System SL-P10." It doesn't even say "digital" on it—until you turn it on.

We turned it on. Something that looked like a tuner dial appeared behind the smoked-glass panel, along with an amber display, proclaiming "DIGITAL." Well then, let's hear something. We asked Ricki the record referee to bring us some of the latest compact discs which our sister publication, *Modern Recording & Music*, gets in for review. She seemed to be having a little trouble suppressing a fit of giggles, as she asked us which ones we'd like to buy.

"BUY!? Editors never buy. Editors borrow. Editors review things. Editors make in-depth evaluations (some take longer than others). But buy? There's no such word."

"There is now." (Ricki doesn't waste words.)

And so there is, as we discovered when we called a highly-placed friend at one of the major labels. This guy is so high up that once, at our request, he arranged to have our name removed from the company's acid-bubble-gum LP review list. How's that for power?

Good, but not good enough. "Listen, don't let anyone know I told you about this, but you can pick up some CDs at King Karol."

For the moment, demand far exceeds supply, and there's no need to hand out freebies. All right, if that's the way it has to be. After all, that's what editorial expense accounts are for. (There's no such words—Publ.)

Seventy-seven bucks for three discs! Oh well, if this is to be the sound of tomorrow, we'd better hear it today. Even if it costs us cash money, it's better than reading about it second-hand in *Pro Sound News*.

After a brief listening session, we went back to re-read Ken Pohlmann's A-D Transition article, in our January, 1983, issue. All of a sudden, the SPARS digital certification program mentioned there began to make a lot more sense. For based on our newly-discovered \$77 digital expertise, we could say that digital audio was either so-so or spectacular, depending on which CD you heard first.

One of our discs is a digital re-hash of an analog master. It's better than the LP, but not by much. Of course, the usual ticks and pops are gone, but that just makes it all the easier to hear the tape hiss. Disc 2 is one of those sampler albums. Here, the anechoic pauses

between cuts are enough to knock you out of the room. Believe it or not, the intrusive silences detract from the performance. Finally, disc 3 is an all-digital production, complete with building rumble, chair squeaks, and assorted grunts and groans from a conductor who grew up in an analog world, where such indiscretions remained safely buried in the hiss.

It would be risky to judge digital audio by listening to any one of these discs. After hearing the first one, the consumer might wonder what all the fuss is about. After hearing the last one, the consumer might wonder if recording technology has just taken a giant step... backwards.

The SPARS International Digital Certification Program will be a giant step forward, if record labels can be convinced to adopt it. Perhaps some of the smaller companies will lead the way, since the biggies are not often able to focus on the long view. However, if the biggies persist on repackaging old masters without clearly identifying the analog content, they could very well destroy (or at least delay)—as SPARS puts it—the "Magic of Digital."

And then there's—as *db* puts it—the "Tragic of Digital," in which it is finally discovered that a lot of modern recordings stink. Somewhat like filming last year's sex symbol through a gauze filter, analog noise has long been used as a subliminal paint job to cover a multitude of blemishes. There are at least a few audio beauties out there that really cannot afford to be heard in public without their makeup in place.

Since the magic of multi-track mono has now been with us for quite a few years, there are people in the industry who have become masters of production, without ever learning how to record. And digital at its best shows off their technique at its worst.

It has been noted that some of these types are against digital, based on nothing more than good old-fashioned terror. Their predecessors were afraid of stereo for the same reason. It was new, and required learning to master. Some weren't up to the challenge then, and some aren't up to it now.

For more progressive minds, one of the attractions of digital is the prospect of needing to re-record almost everything. Years ago, the musicians' union wanted double-scale for recording in stereo, until Bert Whyte had a little chat with union chief James Petrillo. He pointed out that if stereo caught on, there would be lots of work for everyone for a long time to come. Petrillo apparently got the message, for the union demands were quickly dropped, and everyone made a lot of money on stereo (except Bert, of course).

Today, the classical record industry is well on its way to becoming digital-only. Do you suppose we're getting another message? JMW

The Creation of a New Studio Microphone

A look at the B & K philosophy in action.

Once upon a time, there was a happy family of measurement microphones. There were some little ones who, with their inherent agility, were capable of handling very rapidly changing signals at more than one hundred thousand cycles per second. They were a relatively noisy bunch and unless you spoke to them at sound pressure levels higher than 55 dBA, they couldn't hear you at all. But, then again, they didn't feel any serious pain unless you shouted as loud as 180 dB SPL. Because they were so little, they would cast hardly any shadow and would never dream of disturbing a sound field; they would hear absolutely everything that went on around them.

One day, one of the little microphones, his name was Eighthinch Random, said to his mother, "Can I be a studio microphone some day?" "Well, son," she replied, "the studio people will think you're too noisy and besides, your connector doesn't match theirs and they don't feed you on the right kind of electricity so you would have to bring your own." "But Mum, weren't you a studio microphone once?" The mother, who was a large quiet type, sighed. "I was never really asked, even though I make little noise. But I suppose I'm so large I cast too much shadow and can't really

hear the high frequencies from behind and the sides very well." "Oh well, I suppose we're not born to be studio mics," said Eighthinch. "True," agreed his mother, "but two of your larger brothers, Quarterinch Freefield and Halfinch Freefield, have been used for recordings quite a few times. They were reasonably quiet and the recording engineers praised their behaviour and said they'd never heard such an uncompromised, clean sound before. Your brothers thought that they were going to be very famous and visit every studio in the world, but then they remembered how awkward their connectors were and how difficult it would be to contact the mixing consoles."

"Mum, do you think that someday a microphone will be born that is acoustically as good as Halfinch Freefield but will have an XLR connector and accept Phantom powering, have a very rugged build and have the right kind of accessories and..." "Yes son, you've just got two new cousins. I would like you to meet Lownoise Mike and Highintensity Mike." Eighthinch saw right away that these were real studio microphones, with the right sort of background.

EVERYBODY INVOLVED in the manufacture of electro-acoustic transducers, be it microphone, loudspeaker or pick-up design, knows that it is a highly complex business. Many textbooks refer to the basic principle of operation and simplified construction of, say, a condenser microphone, but having seen these, one should not forget the extremely stringent requirements that production facilities must meet in order to realize the finely tuned design which originates on the engineer's drawing board.

For more than forty years the manufacture of acoustic measurement instrumentation at Bruel & Kjaer has been geared to a "theory-into-practice" approach. What this means is that, at the design stages, the theoretical goals of a proposed product are well defined and the practical design is geared to achieving these goals. Ultimately, this is the aim of any manufacturer, but developing and refining new technology takes time, is costly, and performance/price ratios must be optimized. It is here that B & K has been able to utilize many years of experience: our measurement microphones have been the acoustician's reference tool for some twenty-five years. So, at a time when the audio industry saw a need for some innovative transducer technology to keep pace with other hardware developments, it was decided at B & K to use our experience of what makes a good measurement microphone good and apply this knowledge to professional-audio microphone design.

John C. Hansen is a member of the Bruel & Kjaer Technical Information Department. Philip S. White is the leader of B & K's Electroacoustics Market Group. Both work out of the company's main research and development facility in Naerum, Denmark.



Hard at work at the Bruel & Kjaer R & D facility in Naerum, Denmark.

Straightforward enough in principle, designing a studio microphone was, of course, not as easy as simply taking a measurement microphone, adding an XLR connector and arranging for compatibility with studio electronics. A lot

of thinking needed to be done: *What did we already have in terms of technology and what did we need in order to produce a full-fledged studio microphone* (knowing that many of the prerequisites for a measurement microphone constitute only a part of the many varied requirements of a studio microphone, whose needs are dominated by ruggedness, practical usage in the studio, and, of course, the sound)?

Since an estimated twenty-five recording facilities the world over have used the B & K Type 4133 microphone for popular and classical music recording with excellent results, the 4133 seemed a natural place to begin. These users include Paul Grupp and John Boylan, recording engineer and producer for the Charlie Daniels Band, the Little River Band and others. The Mark Levinson recording system, based on a modified two-channel Studer recorder, also used B & K 1/2-in. cartridges as basic microphones. The 4133 is characterized as a laboratory-standard, half-inch free-field microphone with 0 degree incidence free-field frequency response from 20 Hz to 40 kHz ± 2 dB max. Typically, the response deviates by less than 1.5 dB over the entire range. It exhibits excellent phase linearity, is relatively quiet (26 dBA with a dynamic range greater than 130 dB, and is widely used for electroacoustic measurements, studio monitor equalization, etc.

Where does this fit in with the requirements of a studio mic? Well, we reasoned that studio microphone design can be approached from one of two philosophies: either regarding a microphone as an objective, fully-transparent recording tool, or regarding it as a "sound-creating," almost "effects," device which may include, for example, a presence hump in the frequency response.

Clearly, the 4133 falls into the first category and this approach was adopted for the new B & K studio mics. Such a philosophy allows a microphone to be used for a large number of diverse applications. The timbre of a wide variety of instruments from tuba to piccolo can be handled correctly, and when a mixed ensemble is playing together, each instrument is spectrally well-defined, stands out clearly and the sound image is stable. Less equalizing will be needed since the microphone inherently has more "presence." A clean, full signal also lends itself better to post-processing, if required. On the other hand, if a microphone is used as a "sound-processor," it may well prove all but impossible to "un-process" and subsequently reprocess the sound.

DEFINING THE GOALS

With the concept behind the new studio mics firmly established—to produce a neutral microphone, without a "sound" of its own—the B & K theory-into-practice approach was implemented. It was time to investigate the theoretical goals of the microphone and define these clearly, creating the ethereal substance from which the microphones were to be realized.

Given that the microphone should behave as an objective recording tool with a well defined, predictable performance and that it should do no more than faithfully transmit the aural image, an omni-design becomes the immediate contender. In the first place, textbooks describing mic'ing techniques invariably begin by urging the engineer to try omnis, discouraging him from complicated multi-mic'ing setups if at all possible. The recording of sound as it occurs naturally is preferable if prevailing conditions allow. In most instances, separation between instruments can be controlled by controlling the mic'ing distance, and more importantly, what leakage does occur from off-axis sources must be picked up uniformly to avoid coloration. A correctly designed, small diameter omni, with its superior on-axis/off-axis uniformity, ensures that coloration problems do not arise.

Second, inherent in the design of cardioid and other directional mics are some very serious drawbacks to realizing a microphone that will faithfully reproduce a clean, uncolored sound image. The true cardioid-design is difficult

to realize in practice, the critical problem being that of achieving uniform responses at all angles of incidence while ensuring a good cardioid polar response. Ragged responses at angles of incidence other than on-axis will severely color off-axis sound. Furthermore, a cardioid is generally more sensitive to handling noise, wind and breath. Lou Burroughs' *Microphones: Design and Application* offers some very pertinent comments regarding the choice between omnis and cardioids: "... A careful point-by-point comparison, however, will indicate that the omni-microphone should be used more often and given more consideration..."

B & K's expertise lies within the field of omni design. Our condenser measurement microphones are pressure operative and we have accumulated much experience over the years regarding the construction, stability and environmental aspects of microphone design. Both externally polarized and prepolarized designs have been developed to a precision level.

Referring, once again, to the prerequisite that the microphone should reproduce the tonal quality of a source faithfully, and in its entirety, indicates that a broad-band transducer is preferable to a band-limited device. Recording the maximum of information is intuitively preferable, and subsequent post-processing can be implemented if desired. The band-limited device, with a typical on-axis frequency range from 100 Hz to 15 kHz, may be said to give a smooth, clean sound in the presence of extraneous low and high frequency sound, but it is, as the name implies, limited. In terms of sound, this "limited" means a limited ability to separate instruments, limited time response with poorer definition of transients, and limited perception of depth. Experience has shown that the more broad-band a microphone is, the less apparent is the need for high-pass filtering.

In summary then, the design goals to be met by an acoustically transparent microphone can be listed as follows:

1. A broad, on-axis frequency response extending beyond the audio frequency range, thus avoiding fringe effects (phase problems at low and high frequencies within the audio range). The response should be free from "presence boost" and other response anomalies that would otherwise color the sound, cause consonant scrambling and sibilance, and are directly detrimental to phase response linearity. At the high frequency end the response should roll-off smoothly to ensure that phase linearity is maintained.

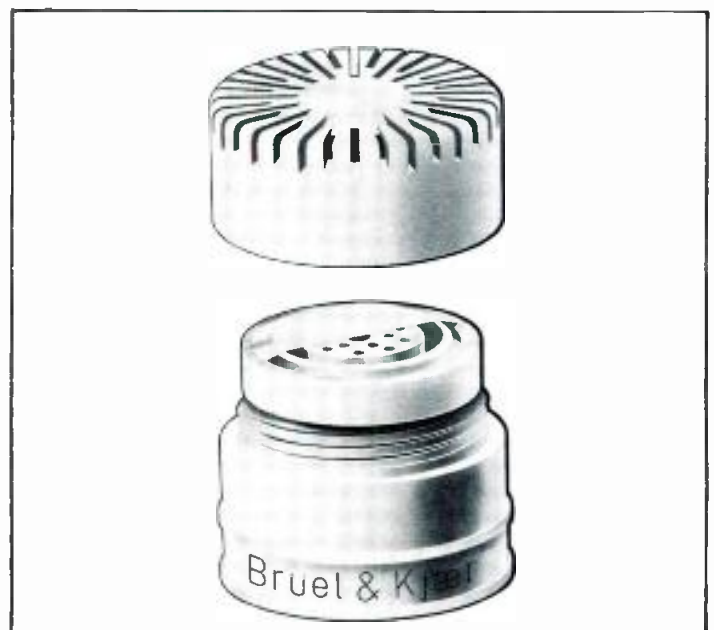

Figure 1. B & K Studio Microphone cartridge Type 4003.

2. On-axis/off-axis response uniformity. With an omni, the response curves for different angles of incidence will diverge at higher frequencies. The trick is to make them part at sufficiently high frequencies so there is virtually no audible difference in sound at different angles.
3. Adequate sensitivity and a wide dynamic range with a low self-noise floor and minimal distortion at high levels. A dynamic range from the residual noise level of a quiet studio (typically 20 dBA) to commonly encountered percussion levels of some 140 dB peak or more must be considered.
4. Low sensitivity to handling and wind/breath induced noise and rugged construction.

THEORY INTO PRACTICE

The requirements listed above are best met by an omnidirectional condenser microphone. Because the condenser microphone is based on a simple principle, we have found that it is possible to come very close to these theoretical goals in practice. However, as has already been noted, the application of the principle to a practical construction requires considerable care in both design and production.

At the design stage, it was decided to develop two basic condenser microphone constructions and utilize the prepolarized technique. "Electrets" tend, at the very mention of them, to conjure up visions of creep-susceptible plastic diaphragms, inferior performance and poor stability; but the prepolarized technique is, today, a sophisticated method of applying the fixed charge to a capacitor microphone. At B & K it has been developed to a high level and is used for precision-grade sound level meters, utilizing an electret polymer layer which is deposited on the microphone backplate. The diaphragm is still manufactured from pure metal. The advantages in space and power saving gained by dispensing with polarization-voltage circuitry are quite significant. The equivalent polarization voltage for these new studio mics is of the order of 240 V.

A good condenser microphone provides a dynamic range of some 120 dB or more. In almost all respects, the performance is uniform for all cartridge diameters, with smaller diameters giving better omnidirectivity and higher limits for frequency and dynamic ranges at the expense of a lower sensitivity and a correspondingly higher noise floor. For the two proposed constructions, cartridge diameters of 16mm and 12mm were chosen. The larger diameter provides an optimum solution for low self-noise and small cartridge diameter, while the smaller diameter gives nearly perfect omnidirectivity with a reasonable noise floor.

In most respects, the basic construction of the cartridges follows a traditional condenser microphone design: a thin, highly stretched, metal membrane is suspended over a rigid backplate; the primary resonance of the system is overdamped and the system operates in the stiffness-controlled region over the greater part of the frequency range. With the aim of an acoustically transparent microphone continually in mind however, it was necessary to pay special attention to the geometric construction of both the cartridge and the main body housing. Reflections, resonances and standing waves in and around the microphone are often a common, but overlooked, cause of degradation in performance. Our experience of stability and environmental sensitivity aspects of design were fully utilized. To ensure long-term stability, the studio microphones undergo the same artificial ageing process as measurement microphones.

In addition to traditional swept-sine methods of measurement, Time Delay Spectrometry (TDS) has been extensively used for evaluating the microphones at various stages of development. A rather unique variation in technique has provided a very convenient and accurate method for these measurements. A measurement microphone, typically the 4133, is used as the sound source. It is the excellent noise-rejection properties of TDS that enable a microphone to be used as a sound source, resulting in a source which offers

flat frequency response over a wide range, omnidirectivity, small dimensions: in fact, all the benefits normally associated with a measurement microphone in its usual receiver position in a measuring chain. In addition, the versatile editing and display facilities offered by TDS enable data to be examined in an easily comprehensible form. For example, housing resonances and reflections in and around the microphone can be easily identified on the Energy Time Curve (ETC). Measurements of amplitude and phase responses, energy-time curves and polar characteristics can be obtained.

FIGURE 2 shows the on-axis amplitude and phase responses of the larger diameter microphone. The curves are plotted on a linear frequency scale for evaluation of phase response linearity. The amplitude response is typically linear within 1.5 dB, and rolls-off smoothly. Restricting the cartridge diameter to 16mm allowed both amplitude and phase responses to extend beyond the audio frequency range. Nevertheless, a noise-floor of only 15 dBA, close to the theoretical limit of 14 dBA, could still be achieved. To further enhance the applicability of the microphone it was decided to equip it with two interchangeable protection grids. With the normal grid fitted, the on-axis amplitude response ranges from 20 Hz to 20 kHz, as can be seen in FIGURE 2. When the other grid is fitted, a linear diffuse-field response is obtained.

The Energy Time Code shows the manner in which a microphone transduces acoustic energy into electrical energy. Broad-band ETCs covering the frequency range 0 Hz to 50 kHz are shown in FIGURE 3 for the 12mm diameter microphone. The 0 to 50 kHz ETC is a very revealing test in that it focusses on impulse response anomalies throughout the entire frequency range of the microphone. The narrower and more regular the ETC (indicative of a broader-band device), the better the time response of the microphone. Reflections in and around the microphone (which make the sound harsh) show up in the ETC as discrete peaks, and resonances (these cause ringing) appear as discrete changes in the slope of the curve. These broad-band ETCs give a quick overall view of the microphone behaviour. As a further refinement, limited frequency band ETCs can be used to show the performance in more detail, as is shown in FIGURE 4 for the same microphone. Here, it can be seen how omni-

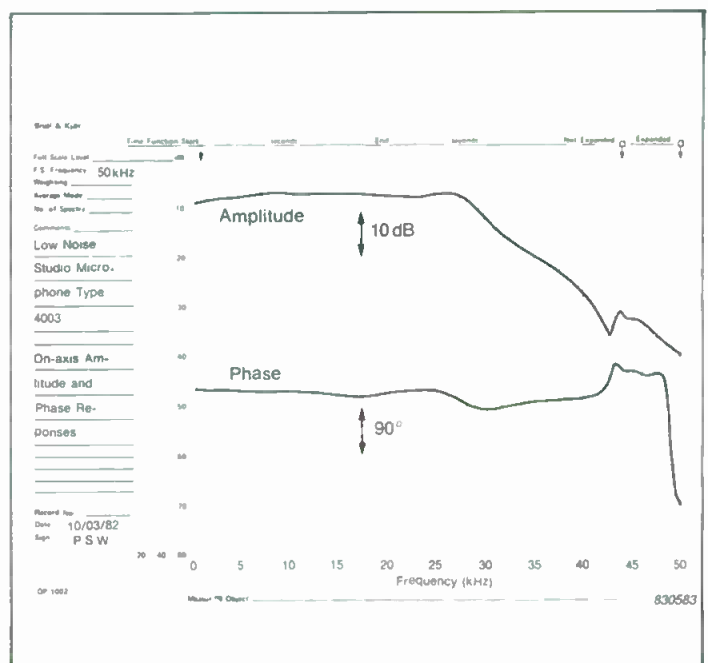

Figure 2. On-axis amplitude and phase responses of the larger diameter microphone. (A linear frequency scale is used.)

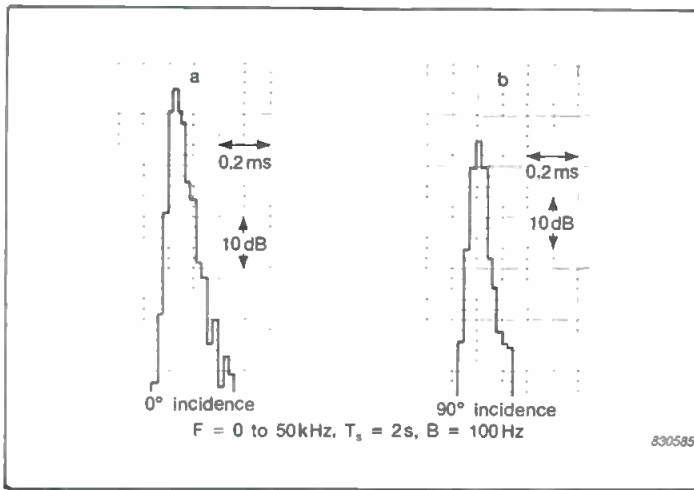

Figure 3. Wide-band Energy Time Curves for the smaller diameter microphone.

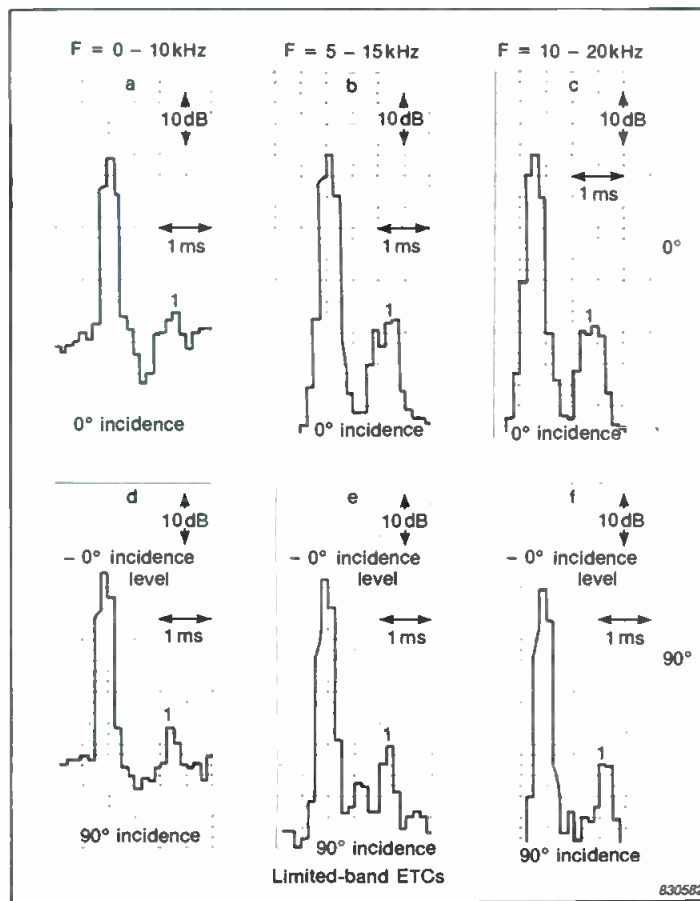

Figure 4. Looking at the ETC in limited frequency bands shows the degree of uniformity of transduction over the entire frequency range. The peak denoted by a "1" to the right of the curves indicates a reflection from the microphone stand.

directional the microphone is, with little attenuation apparent at 90 degree incidence up to frequencies of 15 kHz. Note that different time scales are used for the broad-band and limited-band ETCs. Looking at both sets of curves shows that the 12mm diameter microphone exhibits a very well defined time response which is uniform off-axis. The response is very clean and relatively free from peaks (reflections) and gradient changes (resonances). The amplitude and phase responses of this microphone are shown on a linear frequency scale in FIGURE 5.

Finally, there is the important aspect of compatibility and powering. Phantom powering was of course desirable as it is the standard technique for condenser studio microphones. However, in order to take full advantage of the excellent

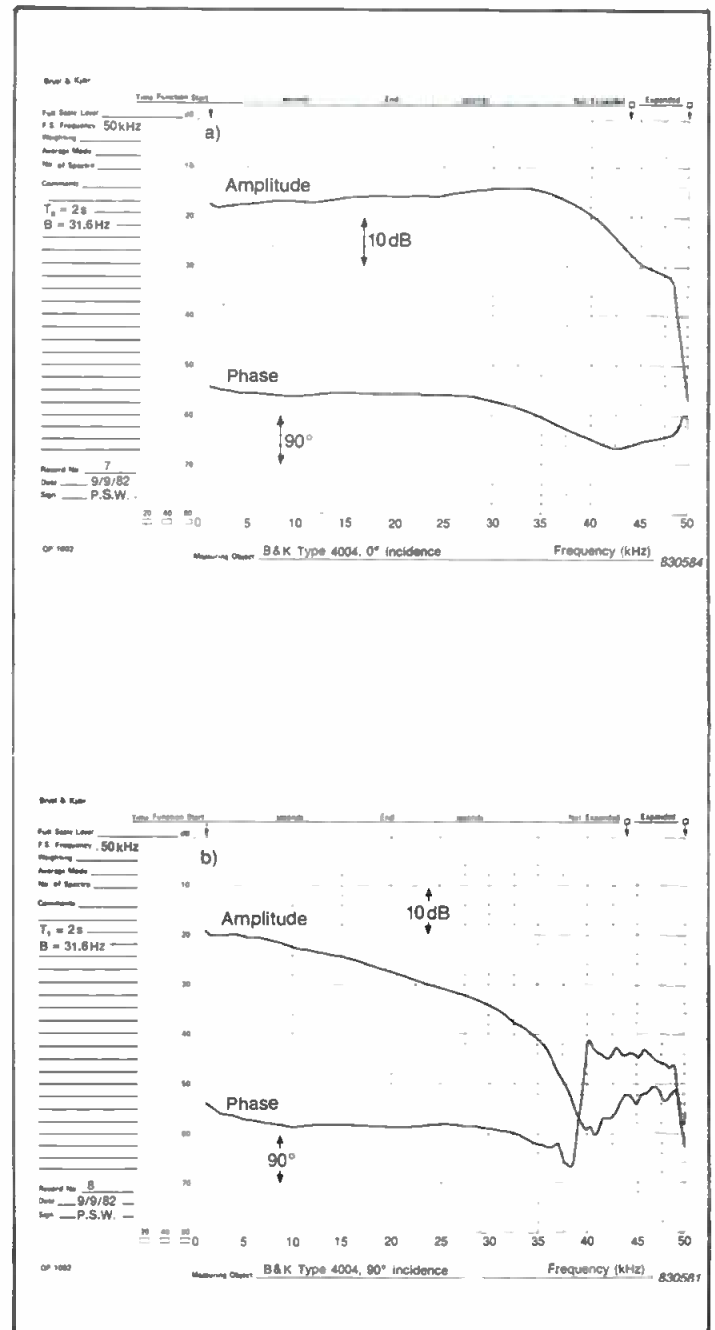

Figure 5. Amplitude and Phase Responses of the smaller diameter microphone showing the uniformity of on-axis and off-axis (90 degree incidence) responses. (A linear frequency scale is used.)

acoustic characteristics of the microphones, a transformerless line-level system was also desirable for improved low-frequency performance and direct signal routing to line inputs. So, the two basic microphone constructions became four models: each construction is available as a *Phantom* model or a *Line Level* model. Designated Types 4003 and 4004 (16mm and 12mm diameter Line Level models) and Types 4006 and 4007 (16mm and 12mm Phantom models), the microphones are shown in FIGURE 6. The dynamic ranges of the microphones are shown in FIGURE 7.

The end result is two microphone designs whose performance comes very close to the theoretical aims laid down at the start of the development programme: wide, flat amplitude responses with extended phase linearity; true omnidirectivity; wide dynamic range. All of which result in a clear, uncolored sound.

By way of acknowledgement, it is necessary to thank Eighthinch Random and the rest of the measurement microphones for laying a solid foundation for a truly innovative



Figure 6. B & K Studio Microphone Types 4003, 4004, 4006, 4007 and the Two Channel Power Supply Type 2812 for use with Types 4003 or 4004.

studio microphone. Halfinch Freefield warrants an extra mention for starting the ball rolling and subsequently providing a versatile and accurate tool for evaluating microphone behaviour. ■

BIBLIOGRAPHY

Burroughs, L., *Microphones: Design and Application*. New York: Sagamore Publishing Co., Inc., 1974.
 Eargle, J., *The Microphone Handbook*. New York: Elar Publishing Co., 1981.
 Woram, J. M., *The Recording Studio Handbook*. New York: Sagamore Publishing Co., Inc., 1976.

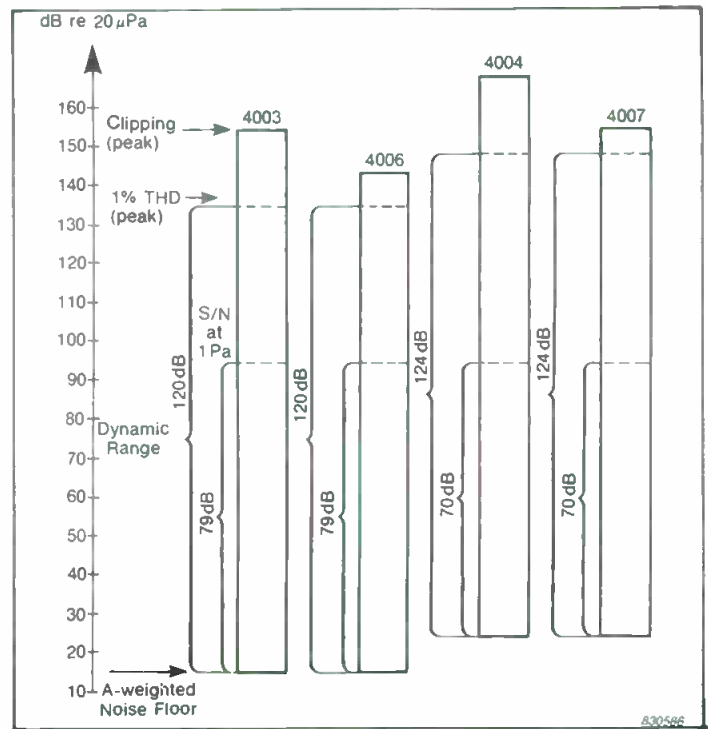
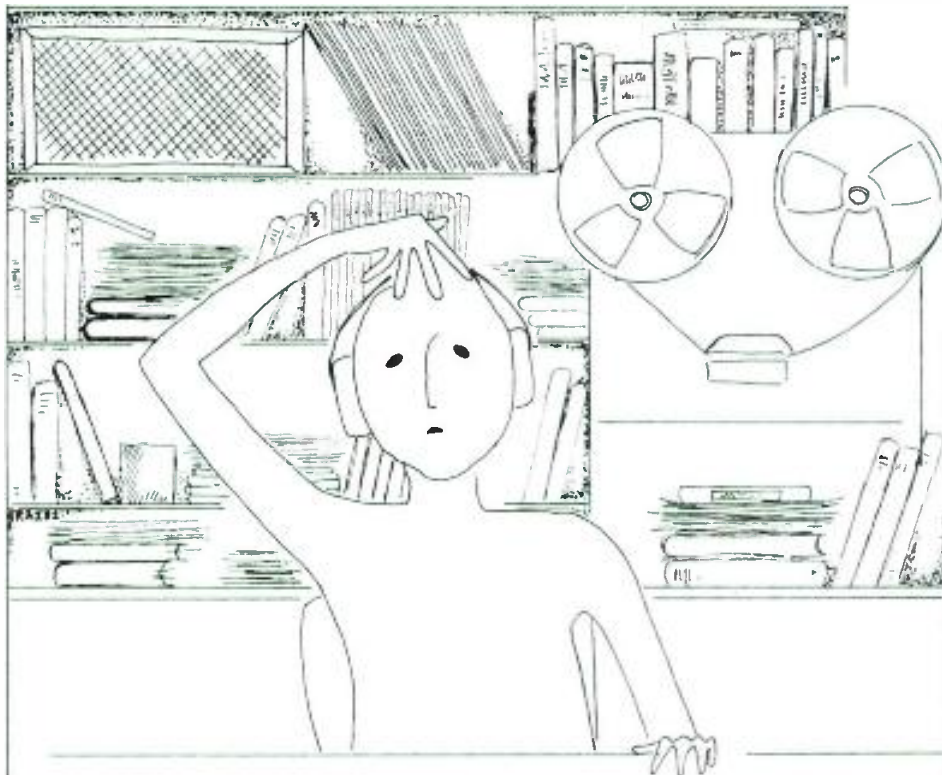

Figure 7. Dynamic ranges achieved with the microphones.

Frederiksen, E., "Condenser Microphones Used as Sound Sources." *Bruel & Kjaer Technical Review*, No. 3 (1977).
 White, P. S., *Evaluation of Studio Microphone Performance Using Time Delay Spectrometry Techniques*. Bruel & Kjaer Application Note No. BC 0075-11. Naerum: 1983.
 Perman, A., *Scale Model Measurements With Time Delay Spectrometry Using a Microphone as a Sound Source*. Bruel & Kjaer Application Note No. BC 0014-11. Naerum: 1983.

Do You Know Where?



Have you misplaced your db again? Our high quality, royal blue vinyl binders keep 12 copies of db neat and handy for ready reference.

Just \$9.95, available in North America only. (Payable in U.S. currency drawn on U.S. banks.) ORDER YOURS NOW!!

Sagamore Publishing Co., Inc.
 1120 Old Country Road
 Plainview, NY 11803

YES! Please send _____ db binders @ \$9.95 each, plus applicable sales tax. Total amount enclosed \$ _____

Name _____

Company _____

Address _____

City _____

State/Zip _____

You Can't Just Listen To a Microphone

FFT analysis brings critical analysis off the lab bench and into the real world.

WHEN A VOCALIST steps up to the microphone and begins to sing, what do we listeners actually hear? How does the loudspeaker's output reaching our ears relate to the singer's acoustic output, as heard by the microphone? What we hear are the combined effects of the microphone, the console, signal processing equipment, power amplifiers, the speaker system and, of course, room acoustics.

Since the microphone can't be evaluated free from the influence of these factors, a number of tests were developed that test only the microphone. These tests, including anechoic chamber sine wave response, provide accurate and repeatable curves of the microphone's response under laboratory conditions; but they don't indicate how the microphone will perform out there in the real world. Using these response curves as a guide, a microphone may be designed to give the desired response curve, which usually means it is either flat or identical to some other microphone that already has a good reputation for the desired application. The problem with using flat as a criterion is obvious: This isn't derived from a real need but rather from a belief that flat means "realistic" or "correct." In fact, a microphone that is flat in the chamber will quite often yield greatly altered response

in the recording environment. In many situations where rejection of unwanted background noise or maximum gain-before-feedback is required, the directional microphone is used. Since the apparent frequency response of a directional microphone varies with its distance from the source and with the source's off-axis angle, the response becomes a complex function of microphone placement and the characteristics of the microphone.

Given these problems, how does the designer of a new microphone determine what his goals should be, and how does he evaluate his progress towards meeting the established goals? Until the development of the FFT (fast-Fourier Transform) Testing System, microphone development usually began with a review of the situation of use. Then, an attempt was made to establish an anechoic response that sounded best, based on listening tests. The listening tests were made under conditions that duplicated the intended use environment. While duplicating the recording environment is usually straightforward enough, the determination of the desired response is usually a major hassle.

EVALUATING THE MICROPHONE

The first major stumbling block is, who decides what sounds correct? Depending on the use, this group can include the design engineers, the typical customer, and a few top management people thrown in to balance the mix. Since there is a desire to improve upon existing units, the product of these peoples' thoughts are often comments like "the test

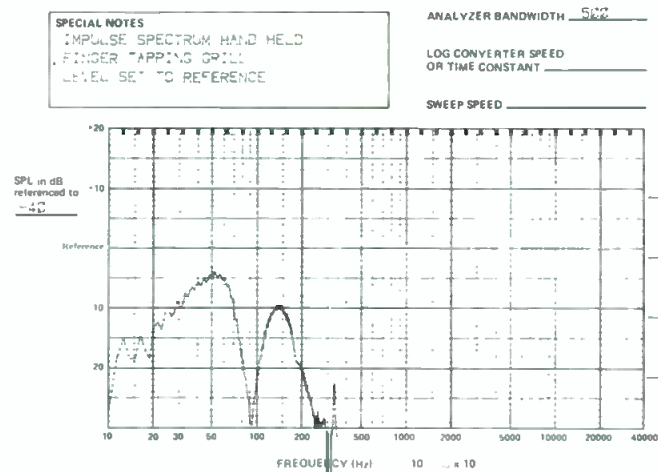
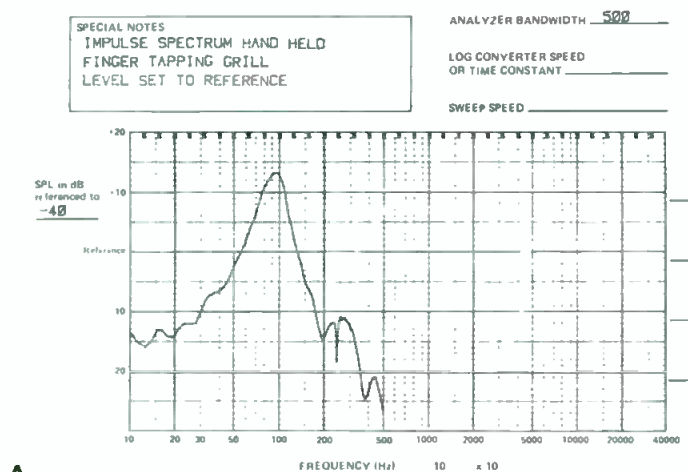

Figure 1. Typical handling noise response (A), and handling noise response where shock system employs "acoustic feedback" design (B).

unit is too muddy" or "it's too bright," etc. Since few engineering-based instruments are calibrated from muddy to bright, a translation of these inputs is necessary if they are to influence a microphone's development. This usually can't be done with much accuracy, so some target response is sought. Normally, this is closely matched to the best known unit currently available. In some cases, electronic equalization is used to adjust the sound. The resulting response—the microphone's response as altered by the equalization—becomes the target response.

Once the target response is established, the microphone development team can attempt to produce it, along with other use-related factors like size, styling, cost, signal-to-noise ratio, handling-noise rejection, etc. In many cases the end result, though meeting the desired response as measured in the anechoic chamber, doesn't sound good in actual use. Some corrective action will once again be suggested, in terms like "too brassy," or "not enough presence."

There are a number of reasons why the anechoic responses of two microphones can be identical and yet their sounds

will be markedly different. Unfortunately, the anechoic response curves don't include factors like air flow noise, proximity effect, the effects of constantly changing points of sonic radiation, and the effects of multiple source angles, to name just a few variables.

THE FAST-FOURIER TRANSFORM SYSTEM

The FFT system eliminates these problems and allows the microphone designer to extract the valuable guidance contained in statements like, "the unit is too muddy." For example, if the listener says, "this unit sounds muddy when compared to the reference microphone," he may be asked under what musical conditions he hears the difference. The conditions are then duplicated, with the FFT storing the outputs of both units. The system then calculates the difference between the two microphones' frequency responses over the entire audible range; the frequency and magnitude of any difference in response is clearly displayed. Then, in most cases, the specific difference that relates to the listener's comment can be isolated.

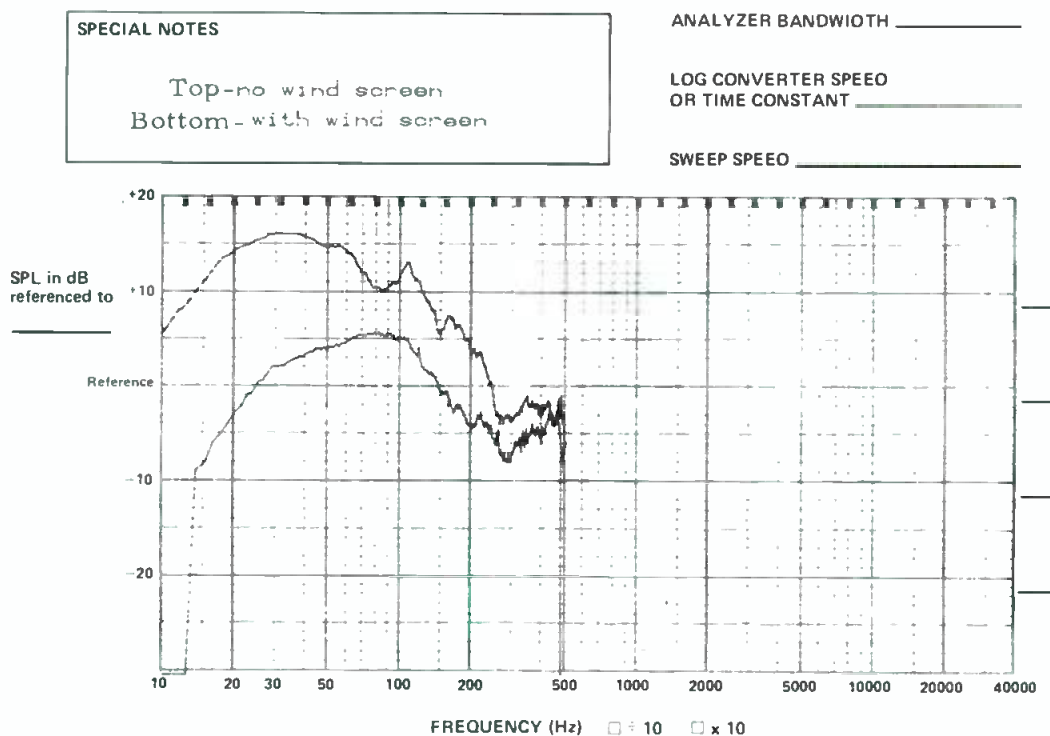

Figure 2. Hand-held response with and without external windscreen.

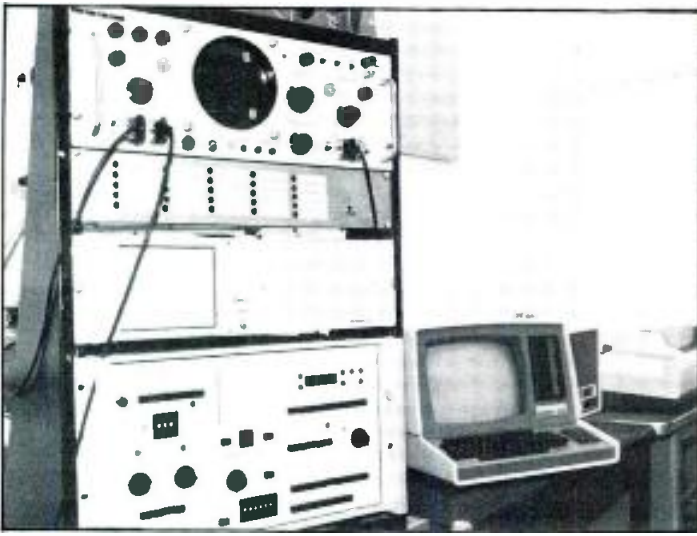

Figure 3. Dual channel FFT testing system duplicates musical environments for microphone use.

If the reference microphone is a small-diameter lab-quality condenser microphone, the difference curve is the in-use response of the tested unit. While this curve looks like an anechoic curve, it is far more valuable, since it is the real-world response of the microphone and includes all of the response-influencing factors associated with the actual environment in which the microphone will be used.

USES OF THE FFT

FFT-based tests are proving to be extremely valuable in designing vocal microphones. Designing the ideal vocal microphone is a most difficult task for a number of reasons. First, most vocalists will hand-hold a microphone, which puts an additional emphasis on shock-mount performance. Second, vocal use subjects the microphone to "pop" and third, the human voice represents the most complex and variable waveform of virtually any musical source.

In using the FFT to address the problems of handling noise, all one has to do is handle the microphone normally (or abnormally) and the analyzer will show the specific amplitude and spectral content of the handling noise. This allows us to critically examine the resonant points of the handling noise and more accurately resolve the problems. If you take two microphones and ask for an evaluation of pop and shock sensitivity, the performer will handle the units, tap them, blow into them, and then push one of them towards you and say, "I like this one." While this may answer the basic question of which is best, it doesn't establish "why." Using the FFT system, the same basic series of movements and actions is repeated with the same end result, but now, in addition to the determination of which is best, come several response curves of the various tests. The direct comparison curve usually shows the frequencies where differences exist. In FIGURE 1, FFT analysis of a typical handling noise response is compared to a shock-mount system employing acoustic feedback design.

Another application of the FFT technique involves the hand-held response of a vocal microphone with and without an external windscreen and allows the evaluation of different windscreen materials (FIGURE 2).

FFT analysis can also be used to aid in the understanding of the factors involved in mic'ing an instrument for recording or sound reinforcement. For example, a piano produces sound from a variety of places and is of a very complex nature. In order to sound "correct," the microphone must accurately reproduce that complexity. In the anechoic chamber, the speaker produces relatively simple sounds, usually single-frequency sine waves, from one relatively small point. If a piano is 8 feet long and mic'ed at 5 feet, the

incoming sounds arrive at angles that are large enough so that direction-related response changes due to the microphones' polar patterns can introduce a considerable sonic difference between two units that are identical in the chamber.

Using the FFT, it will be possible to custom fit microphones to the voice and personal needs of an artist. While the day of the custom-made microphone is still only a gleam in the designer's eye, the FFT is already providing important data on the differences between individuals and how these differences relate to microphone design requirements.

As an example of what is possible today, a female singer will normally be unable to generate very low frequencies (100 Hz is low for a female). A microphone with response extending just a little below her lowest tone wouldn't effect any usable musical information, yet it would greatly reduce pop and handling noise, which are predominately low-frequency phenomena. However, there are some male voices that extend below 50 Hz (the lowest true fundamental we have measured to date was 47 Hz). Yet there are very few directional microphones that provide true response to 60 Hz, let alone 50 Hz. From these two simple examples, it is obvious that individual differences in people determine the ideal microphone for a person and for an application. Recognizing this fact, microphone designers will eventually develop microphones to fit the application and the range of human variation, through a wide selection of truly different options.

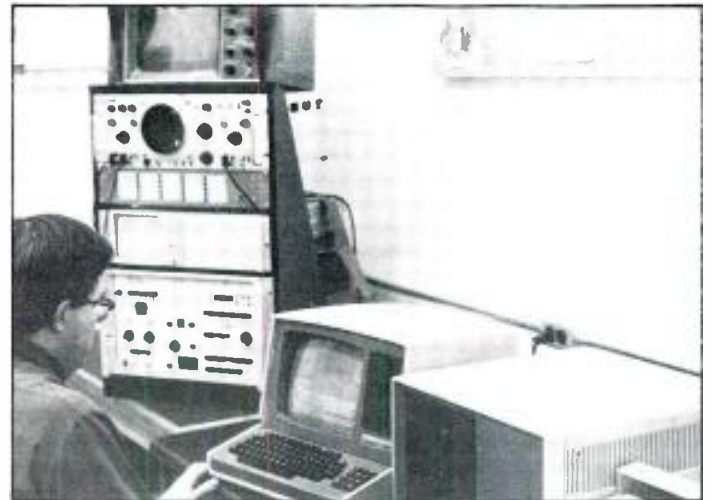

Figure 4. Outputs from the FFT system are compared to determine the difference between two microphones' frequency responses.

Individual differences notwithstanding, the FFT will permit a repeatable and accurate evaluation of universal problem areas like plosive-induced pop and handling-induced shock noise.

While the majority of the FFT work to date has been on the comparison of microphones that are judged by experienced users to have desirable performance, the really exciting thing about FFT analysis is the fundamental understanding it brings in terms of quantifying the range of human vocal characteristics and the effect of response variations on how these characteristics are perceived. This information will not only allow the development of superior microphones, but it may even advance the "mixing" art to a science, once the secret ingredients of a "sweet" sound are quantified. It is clear that FFT analysis, by its ability to bring critical analysis off the laboratory bench and out into the real world of the performing artist, opens up a new era of high-performance microphones. ■

db Test Report

The Shure AMS8000 Automatic Mixer

ENTER THE AGE of the self-mixing console. Oops... let's not go too far just yet. Only a relatively few years ago, the computer industry was making a very humble start. Within the same century, the rather simple concept of "yes"/"no" has become "maybe"/"we'll see," and "error...this can't be right...would you like to try again?"

The Shure AMS8000 Automatic Mixer is a fresh approach to a very old problem. The Mixer is a self-gating microphone system that uses dedicated mics and circuitry to make gating decisions on directional information rather than level sensitivity. Under the simpler conditions of speech reinforcement or recording, it will gate its inputs automatically, but for the really ingenious engineer, it can do much more.

THE OUTSIDE

When I was in grade school, we had a little Shure mixer in the equipment rack in the back room with six knobs for inputs and a master output knob. The power came on with the lights when there was an assembly. The principal would not let anyone touch the mixer until the shop teacher got there. The shop teacher would then turn the master up to the red line magic-markered there, deafen the students with some feedback, turn it down some, and leave.

Over the years, the outsides of the Shure mixers haven't changed much. They didn't need to: they did the job quite well. This latest version has eight microphone inputs, an auxiliary input, and a master output. The auxiliary can also be used as an output. The knobs are standard plastic with a notch to keep them calibrated. There is one for each of the inputs, the output, and the auxiliary input/output. An LED above each input fader indicates whether the input is gated on or off. Three LEDs on the right side indicate the unit is on and operating in the normal or overloaded range, whichever is appropriate. Three 1/4-inch phone jacks provide an auxiliary input and output and a stereo headphone output (but a monophonic mix). This permits the use of standard stereo headphones—a plus for adaptability. The power switch is a button on the front bottom-right corner.

The back of the mixer has changed a little more than the front. The power requirements for the mixer are 120 VAC, 50/60 Hz and 20 watts. This function is not user-changeable. A switch allows the gated-off attenuation to be a preset 15 dB or a variable 8 dB to - dB reduction. Six 1/4-inch phone jacks let multiple units be linked together to form systems of up to two hundred (!) microphones. There is an input and output for the auxiliary bus, the main mix bus, and the off-attenuation bus. More will be said about the bus configurations later. Another set of switches permit selection of a hold time of 0.5 sec or 1.0 sec once any one microphone has been gated on. The output can be set to microphone or line level and is available on a three-pin XLR connector. Each of the inputs is an XLR standard microphone connection, but must be used with the AMS microphones available since the

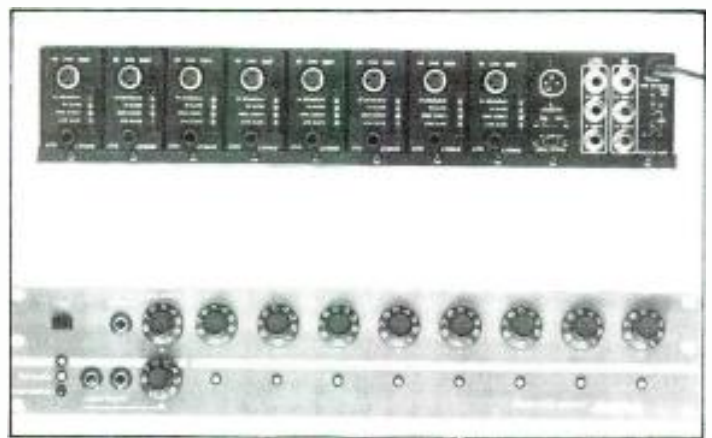

Figure 1. The Shure AMS8000 mixer.

signals the mixer expects contain both level and directional information. This point will be discussed more fully when we talk about the microphones. A direct-out 1/4-inch phone jack allows non-gated monitoring of each cardioid microphone output. Logic terminals on the back allow control of the gating functions to mute, override the mute, or track the gate on any individual channel.

The design of the unit makes set-up a rather simple task, considering the adjustments one might expect of such an automatic system. The less-used functions are out of the way, on the rear panel. Once the unit is installed, the front panel controls are simple enough to operate on a daily basis, and even my shop teacher could still handle it.

The unit is a standard rack-mount 19 inches by 3 1/2 inches tall. It comes with the screws to put it in the rack and rubber feet in case you don't own a rack. The whole exterior design is attractive and simple.

THE OTHER SIDE

As you have probably realized by now, the front-view exterior of the AMS8000 Automatic mixer is not all that unique. Except for a few logic terminals and LEDs, there is not much that has changed on the outside from mixers of years ago. The inside? Well, that's another story.

The need for a gating microphone system is obvious to anyone who has had to set up a multi-microphone, speech reproduction system in a church or other noisy environment. With even one microphone it may be difficult to get enough gain before the system starts to feed back. The more noisy or reverberant the environment, the more difficult the problem gets. As more and more microphones are added, the problem gets worse and worse until it can even become impossible to understand the person speaking. In fact, it can be shown that a system with eight microphones operating in a random ambient field has about 9 dB less headroom before feedback than a system with one microphone in the same reverberant

field. This is a significant reduction, considering that the added noise is mostly reflections and reverberation combined with room noise, decreasing the intelligibility of the useful acoustical information.

The most common form of detection in use today is the level-sensing circuit. Most of even the newer models of small mixers do not have self-gating systems, and those that do use the level sensing circuit to turn the microphones on and off. The method for determining the appropriate reference level ranges from sampling every microphone in the system and taking their average to setting up a room mic' to test the level of the room ambience. The reference level is then compared to the individual microphones and a decision is made to turn on or off that particular channel. The theory is that the useful information that the user is trying to amplify will be louder than the surrounding environment from the viewpoint of the microphone. This can be seen in two ways. First, we assume that all the microphones will not be receiving useful information at one time, so only the microphone(s) with the largest signal will be turned on. This is an all-too-often false assumption. The other idea is to set up a room microphone to represent the room norm. Any microphone louder than that reference will be gated on. That method has the obvious disadvantages inherent in any single-point sample. This again leads to large errors.



Figure 2. The Shure AMS22 low-profile microphone and the AMS 26 probe microphone.

The errors of a bad design are easily noticed. Either the system gates to loud room noises, or very soft opening consonants are missed because of late or intermittent gating. Intermittent gating is distracting, to say the least, and false gating defeats the purpose of the device. As the room becomes more reverberant, and the microphone distance

from the speaker becomes greater, the margin of error can become extremely small—if it exists at all. The problem boils down to a device that doesn't work under the conditions in which you need it the most.

The Shure AMS8000 Automatic Mixer makes its gate-on decisions on a completely different set of criteria. No matter what the level of signal, the AMS8000 assumes that any desired sound source will come from the front of the microphone. This seems to be a valid assumption. (Even my shop teacher pointed the mic at the person speaking.)

THE MICROPHONES

The special AMS microphones are the only ones that can be used with the AMS8000 mixer. The reason is that the microphone outputs to the mixer are a pair of unbalanced, high-impedance signals with a common ground, the shield. The high-impedance output of the microphone impedance-matching circuit coupled with the low input impedance of the mixer causes the mixer to see a current source instead of the conventional voltage source. This gives a much-improved noise rejection compared to the standard unbalanced line, though it is not quite as good on hum rejection as a balanced line. The manufacturer claims that one thousand feet of cable introduces a capacitance of 0.02 microfarads. This would increase the high-frequency gain of the preamp (noise gain). A 400-ohm resistor on the input limits this gain problem, introducing a high frequency roll-off of about 3 dB at 10 kHz with one thousand feet of cable. A 500-foot cable run should not degrade system performance, though.

The microphones used with the AMS8000 consist of two cardioid elements back-to-back. One element picks up the rear information and the other picks up the front information. The elements are electret condensers. The signals are then sent to the impedance-matching circuits, which present them as a current source to the low-impedance microphone inputs on the mixer. The impedance-matching circuits are powered by a 7 VDC supply that is introduced on the microphone side of a coupling capacitor in the mixer. It is present on the signal leads.

Inside the mixer, a comparison is made between the two element outputs, so it is important that they are matched in frequency response around their entire polar patterns. This is done with careful suspension of the elements and baffling of any reflective surfaces inside the mic' housing.

Two versions of the AMS microphones are now available: The AMS26 is a probe style microphone to be used as a handheld mic' or suspended at least eight inches from a reflective surface to hold down the comb filter effect of early reflections; the AMS22 is a low-profile microphone to be used as a flush-mount mic' on a desk or table or suspended from short stands, goosenecks or any other method where the microphone will be less than eight inches from a reflective surface. The impedance-matching circuits in both microphones determine the maximum sound pressure level response of about 128 dB SPL.

THE MIXER

The mixer takes the signal from the two elements and applies equalization approximating an A-weighted curve to make the unit more responsive to spoken frequencies and less responsive to room noises. The two signals are then compared. If the front signal exceeds the rear signal by 9.54 dB or more, the channel is gated on. The audio inputs are taken before the equalization. The 9.54 dB gating criteria corresponds to an off-axis response of about 60 degrees, and is designed to give effective gating to desired sounds without responding to unwanted room sounds.

The mix bus has a terminating resistor to ground, so the more microphones that are turned on, the more the bus is loaded down and the less gain it gives to individual microphones. This prevents the person speaking from getting louder as more microphones in the nearby area are activated. The gain compensation is also designed to prevent

"pumping and breathing" fluctuations in the noise floor as mic's are turned on and off. Only one terminating resistor should be present when systems are linked, so the link jacks in the back of the unit have an automatic switch to set the last unit in the chain as the terminating resistor. The off-attenuation bus is linked in a similar manner to prevent the build-up of noise from microphones that are supposed to be turned off.

The gating has a built-in, turn-on time of four milliseconds of controlled rise. Shure claims that this setting will not chop off the first consonants of the spoken words and is slow enough not to be obtrusive as the channels are activated. Once the channel has been activated, it will stay on for the preset hold time and release over a period of 300 milliseconds. This should be a gentle turn-off slope.

The level-sensing circuitry which senses the difference between the front and back channels is an exponential system to accommodate the very large dynamic ranges (40 to 110 dB SPL). Signals much larger than this range will cause the system to gate off prematurely; signals lower than this range will not activate the gate for opening consonants. Linear systems cannot respond to this wide ranges of values and can become useless in the most extreme circumstances.

THE ROAD TEST

Of course, the most important aspect of any system is its performance in a typical situation. Direction sensing looks very good on paper, but it is useless if it doesn't work well in application. The best test of any device is a critical situation. I had one of those on hand recently, when the board of directors of the Society of Professional Audio Recording Studios (SPARS) came to speak at the University of Miami. The process of setting up the AMS8000 Automatic Mixer for a morning seminar did not take very long, less than thirty minutes in this case. The microphones were easy to use—just set them up and go. Since they use standard three-conductor cable (twisted pair and shield), extension cords for the microphones were easy to find. In the opening speeches given by the SPARS directors, we had some trouble getting the microphones to trigger on opening consonants. After lunch (and reading the directions), we had the opportunity to try again. The unit worked better the second time, although the acoustical environment for the second session was much worse. Once it is set up, the system more-or-less runs itself. There are no adjustments to change the gating sensitivity, as this would change the angle of acceptance. However, an adjustment to change the required 9.54 dB would seem appropriate if for no other reason than the psychological satisfaction of being able to change the gating sensitivity. In many of the less difficult pick-up environments, a wider acceptance angle could be tolerated—even if it did produce some false gating. False gating was never a problem in using this unit, but intermittent gating was. If the gating system is to fail in any way, gating on when the moment is not right is better than missing something. In teleconferencing and recording, missing acoustical information can be devastating to the understandability of what is transpiring, whereas false gating is a less serious offense. I personally would rather have some unwanted and unexpected noise than miss part of the program.

The time required for the system to gate on and off is quite appropriate. Transients such as "T"'s in "test" were not missed when the gating triggered, and the 300 mSec release time seemed very natural indeed. The microphones produced a very pleasant spoken sound, although the gating function would rule out using the system for soft music. High or medium-level transients from the front would always trigger gating, while very large levels from the rear of the microphones would never trigger gating falsely. The addition of an adjustment on the back of the unit to change the acceptance angle and the 9.54 dB difference requirement would keep the unit simple to use from the front and still give it more versatility to changing sound environments.

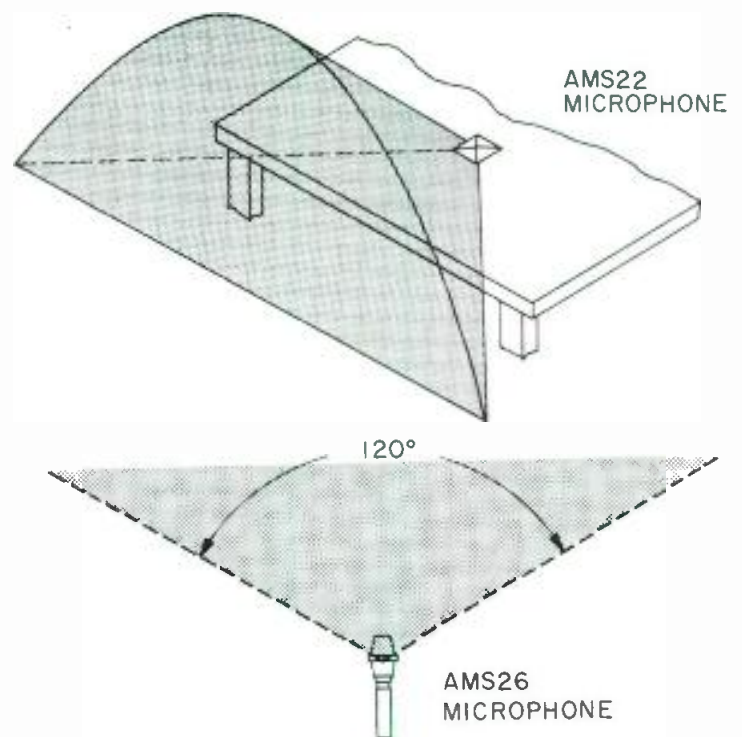

Figure 3. The AMS microphones' windows of acceptance. Sounds originating outside these windows will not make the microphones turn on, regardless of their loudness.

ADAPTABILITY

With the access to the logic terminals on the back of the unit, adaptability cannot be overrated. The Shure AMS880 interfacing system allows the gating of the mixer to control video cameras. With simple switches and imagination, many other features can be installed, such as a cough button, chairperson muting, priority mic'ing, and much, much more. With the ability of the unit to connect up to two hundred microphones, computer control and tracking can be used to produce security systems, large teleconferencing set-ups, and intercom systems. The adaptability of this unit to unusual circumstances is only limited by the imagination of the users.

THE OPTIONS

The only options now available are the microphones, (two styles), and the video interfacing unit (AMS880). Other styles of microphones are being considered, but are not available now. Because of the adaptability of the unit, most special applications of the device can fairly easily be designed by the user. The unit can be ordered to accept different power requirements, but the 110 VAC is the standard.

SUMMARY

The Shure Automatic Mixing System AMS8000 will not mix your favorite rock group by itself, play video games, or make coffee automatically. It is a more intelligent mixer than the mixers of old and uses an intelligent method of determining when to gate on and off. My shop teacher won't have to do any more than he used to, but the effort will produce a cleaner more intelligible sound. With a little fine tuning of the 9.54 dB difference criteria, the AMS8000 mixer would become an even-more versatile and usable device. The clean sound it produces means a more relaxed listening environment, which can sometimes be an important consideration. An audience won't remember much of a speech if they can't understand it. The Shure mixer, with a little extra adjustment time spent in set-up, can give a very clean sound whether it is for amplification, broadcasting, or recording. The concept of direction sensing for determination of gating is an excellent idea. ■

New Microphone Products

As a service to our readers, db presents this look at some of the recently introduced microphones, cables, mixers and capsules....

WIRELESS MICROPHONE SYSTEM

- Swintek's modular six-frequency wireless microphone system is specially designed for the TV and motion picture industry. These modular-packaged receivers are hand-built on glass-epoxy circuit boards that are shock-mounted inside all-metal cases. The systems include the MARK Q/50A/dB-S lavalier transmitter. RFSD antenna switching diversity option with the MARK Q/AC six frequency receiver. The receiver has the ability to operate on six different frequencies for on location applications. The RFSD module switches RF instead of audio, thereby eliminating transients (clicks and pops) normally found in most conventional dual diversity systems. All systems include Swintek's "dB-S" companding system, which provides an overall dynamic range of better than 100 dB, with a minimum signal-to-noise ratio of 80 dB.

Mfr: Swintek Enterprises, Inc.

Circle 35 on Reader Service Card



ELECTRET CONDENSER LINE MIC



- The Model AT835 is a wide range electret condenser microphone with a unidirectional polar pattern specifically designed for the narrow acceptance angle desirable for long distance sound pickup. This narrow acceptance angle is achieved with a combination of gradient and line interference principles. The result is useful for stage pickups where high sensitivity must be maintained over longer distances than usual. The AT835 was created for use in professional recording, broadcasting, film/TV sound, as well as for boom and hand-held use in TV and film production, ENG, and similar applications.

Mfr: Audio-Technica

Circle 36 on Reader Service Card

MICROPHONE MIXER

- The Voice-matic Microphone Mixer Model DE-4014 is an automatic four-channel microphone mixer with an auxiliary line level input. It provides the gain, stability, low background noise and reverberation pickup of a single microphone system. The DE-4014 uses the Industrial Research patented principle of Dynamic Threshold Sensing (DTS) to scan all microphones simultaneously for a signal. When it senses a signal, it gives "on" status to that microphone and commences another search. When two microphones are found with a signal, it gives "on" status to both and, because the NOM count has doubled, the master gain is automatically attenuated 3 dB to avoid feedback. Also, the fixed threshold of

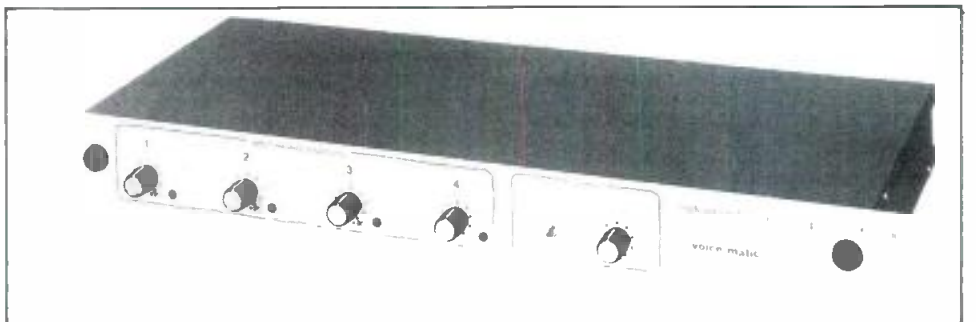

gated mixers is eliminated. Pre-recorded or off-premises material can be mixed into the system via the auxiliary input, and recording or off-premises transmission can be accomplished via the auxiliary output. Standard features include transformer balanced inputs, red LED channel

status indicators, auxiliary input with level adjust, main output, auxiliary output, individual channel sensitivity adjust, and Voice-matic/Standard mode switch. There is an optional 12VDC phantom power option.

Mfr: Industrial Research Products, Inc.

Circle 37 on Reader Service Card

PROFESSIONAL MICROPHONE CABLES

• Wireworks' professional microphone cables are designed for use in any application. They are geared for exact requirements, and are complete assemblies, ready to use with all low-impedance, XLR-compatible audio equipment. The cables are available in five different jacket types: C Series Rubber, CM Series Miniature Rubber, CH Series Hypalon, CN Series Neoprene, and CP Series PVC. PVC jacketed cables are available in fifteen colors. All series are stocked in 5-, 10-, 25-, 50-, and 100-foot lengths.

Mfr: Wireworks

Circle 38 on Reader Service Card



ENG/EFP MICROPHONE



• Electro-Voice's RE34 microphone is engineered specifically for electronic news gathering (ENG) and electronic field production (EFP). It is a cardioid microphone with an improved front-to-back noise ratio and a carefully tailored frequency response extending from 40 to 15,000 Hz. The RE34 features the provision for both line-level and mic-level transformer coupled outputs, switchable at the microphone. This feature permits the RE34 to work into audio inputs such as balanced and unbalanced microphone inputs and the line-level inputs of microwave and fiber optic transmitters. The RE34 will also drive telephone lines for remote broadcasts or field reports. An integral limiter functions at either line or microphone level and includes a low-distortion circuit that further functions to minimize "P-pops." Design considerations were combined to offer high resistance to handling noise, wind noise, and adverse effects caused by moisture or high humidity.

Power can be supplied via phantom power (minimum 12.5 volts) or with a standard 9-volt battery in the mic handle. A switch in the handle allows battery conservation and serves as a silent "mute" switch in the phantom mode. The Electro-Pulse/Phantom "Q" LED indicator in the handle indicates the type and strength of power.

Mfr: Electro-Voice

Price: \$400.00

Circle 39 on Reader Service Card

MIC CAPSULES



• The CK 1X (cardioid) and CK 2X (omni) microphone capsules have been added to AKG's Condenser Microphone Modular System line of professional products. They are used with MK46/3 cable and the C460B preamplifier, and are 0.7 x 1.6 inches. Accessories include the H48 cable hanger, ST48 miniature table stand, W32 foam windscreen, and MK46/3 extension cable.

Mfr: AKG Acoustics, Inc.

Circle 40 on Reader Service Card

STUDIO MICROPHONES



• Bruel & Kjaer's four new omnidirectional condenser microphones, types 4003, 4004, 4006, and 4007, are specifically intended for professional studio use. Types 4003 and 4006 are acoustically identical, low noise (15 dBA) microphones which differ only in the method of powering. Type 4006 is powered from the standard P48 Phantom system, while type 4003 is powered via B & K Power Supply 2812, which employs a balanced, transformerless output. Types 4004 and 4007 are also acoustically identical and are intended for applications requiring a high level handling capability of <1 percent THD at 148 dB, and extended frequency and

phase responses. Type 4007 is Phantom-powered, while type 4004 is powered via the 2812 power supply. The on-axis response of types 4003/06 range from 20 Hz to 20 kHz ± 2 dB, having a smooth high-frequency roll off. Smaller diameter types 4004/07 have an on-axis response from 20 Hz to 40 kHz ± 2 dB. Owing to the relatively small cartridge diameters, they retain omnidirectivity at high frequencies. Each microphone comes with its own calibration chart showing frequency response, self-noise, distortion, etc.

Mfr: Bruel & Kjaer Instruments, Inc.

Circle 41 on Reader Service Card

WIRELESS VHF-FM MICROPHONE SYSTEM

• The Telex FMR-1 is FCC type accepted and is intended for use in film/video productions, broadcasting, and other professional applications. The system operates as a conventional FM wireless microphone receiver when only one antenna is connected, and automatically operates as a dual diversity receiver when two antennae are used. The combined signal of the two antennae is automatically phase shifted by the receiver. The receiver operates on 120/240 VAC or 12 VDC. The microphone transmitter's circuitry logarithmically compresses the dynamic range of the audio signal for transmission, which is then expanded by the receiver: the apparent signal-to-noise ratio is thereby increased. The battery-powered belt-pack transmitter is roughly the size of a pack of cigarettes, and accepts any low impedance dynamic microphone. Two hand-held

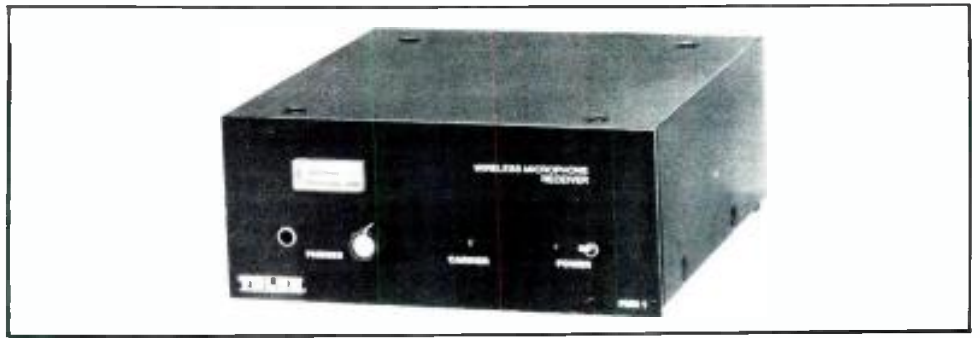

transmitter microphone models are also available. The Model WHM-300 is a cardioid electret mic with flat response suited for the speaking voice. This model has separate switchers for RF and audio so the audio can be turned off without losing control of the RF carrier. The switchless WHM-400 is a cardioid dynamic microphone with

slight emphasis in the lower audio frequencies. Both transmitter microphones work with alkaline or nicad batteries. Options include a nicad battery charger and a foam sleeve for the microphone housing to diminish handling noise.

Mfr: Telex Communications, Inc.
Circle 42 on Reader Service Card

AUDIO CONNECTORS

• Hutco's WAKA line of audio connectors consists of 11 different plugs and receptacles for pro' audio use. These connectors employ cast connector shells and high-impact plastic inserts; they are completely interchangeable with other connectors. WAKA also offers two new high-impact plastic receptacles for panel mount with printed circuit board mount pins, which eliminate the need for discrete wiring.

Mfr: Hutco, Inc.

Circle 43 on Reader Service Card

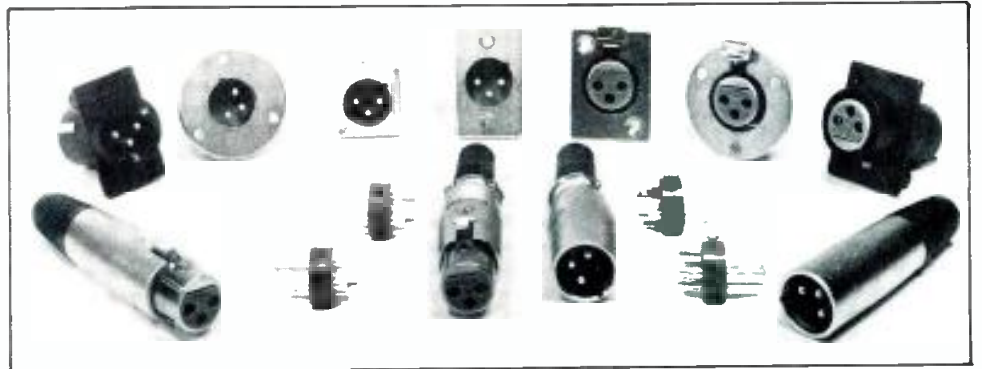

WIRELESS MICROPHONE SYSTEM

• The PB-36 Portable Base Unit is designed to expand the ENG/EFM capabilities of the Sony wireless microphone system. This system works with either the wireless hand-held WRT-57 microphone or the WRT-27A lavalier microphone and belt-pack transmitter. The PB-36 Portable Base Unit constitutes a six channel diversity tuner system when combined with WRR-37 type diversity tuners. It includes built-in antenna divider and AC power supply. Tuner units can be plugged into the main frame. The PB-36 is capable of distributing two antenna outputs to each of the six tuners for diversity reception. Used individually, each WRR-37 requires its own antenna system. The PB-36 also features front panel-mounted monitor level control and headphone jacks. It is available with optional attachment that permits 19-inch rack mounting, and is capable of supplying power to an antenna booster.

Mfr: Sony Professional Audio

Circle 44 on Reader Service Card

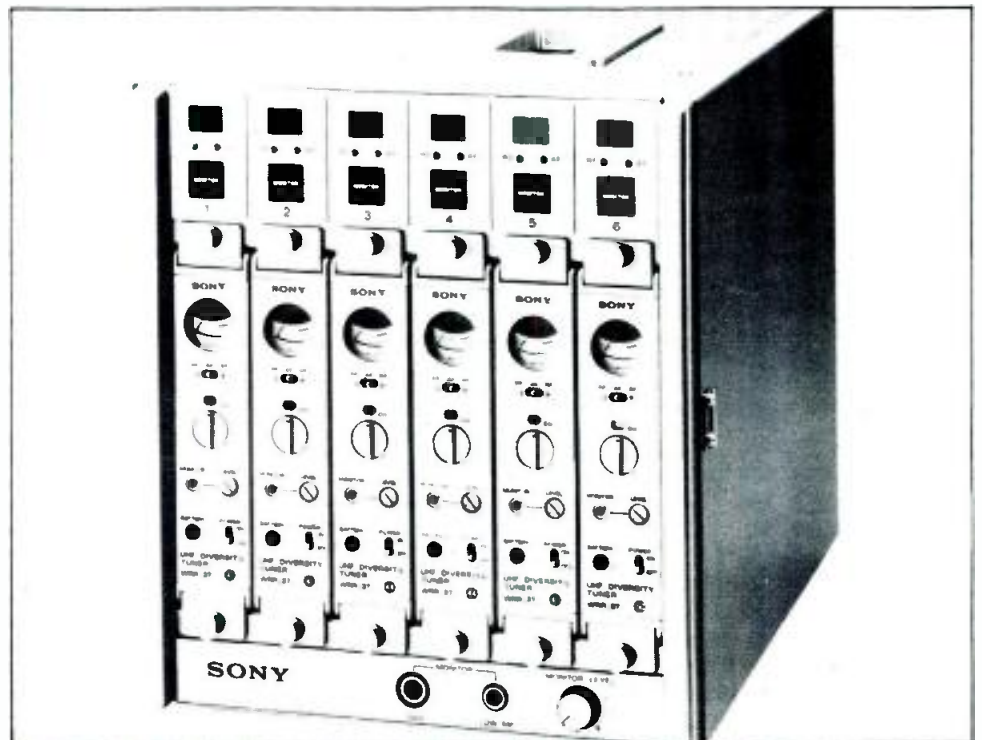

- HM Electronics' professional hand-held wireless microphone combines the Shure SM85 cardioid condenser element with a small 9-volt power transmitter. A 9-volt alkaline battery will provide eight hours of continuous life at 50 milliwatts of radiated power. The 11-oz. HME System 85 transmitter/element combination is less than nine inches in length; the transmitter/receiver link is transparent. The audio output is identical in all respects to the SM85 element. The dynamic range of the System 85 is over 115 dBA, greater than that of the element itself. A silent "mic mute" switch enables the audio to be turned off without breaking the RF link. A squelch circuit prevents audible RF "dropouts" as well as unwanted "pops" when the transmitter is turned off.

Mfr: HM Electronics

Price: \$2,535.00, including fitted flight case

Circle 45 on Reader Service Card

WIRELESS MIC



NEW MICROPHONE CABLE

- Connectronics' Musiflex cable employs a new thermo-plastic technique offering several advantages. Instead of the usual lapped or braided screen, there is a black conductive thermo-plastic tube surrounding the inner conductors. In addition to the signal carrying wires, there is a tinned, seven strand earth drain-wire which requires no stripping, and provides easy ground termination. Preparation time can be cut substantially because there is no braiding to prepare. The wires need only be cut to length and soldered onto the connector. The conductive thermo-plastic screening provides an excellent electrostatic field, being a virtual tube extending along the length of the cable. This screen also attenuates interference much better than conventional braided screens for frequencies up to 10 kHz. Capacitance is lower, minimizing signal losses on long runs. Musiflex is well-suited for professional audio installations, instrumentation, control, and data applications. It is available in various colors and sizes.

Mfr: Connectronics

Circle 47 on Reader Service Card

LAVALIER SYSTEM

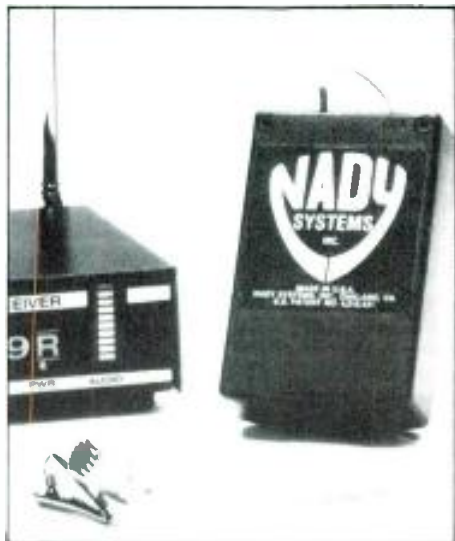

- The new Nady 49 wireless lavalier microphone system is said to be the only 49 MHz system with 3-channel capability (three units can be operated in the same location without audio degradation). The system has a 250 ft. range. The Nady 49 receiver features two multi-colored 10 LED trees that give the unit's operational status at a glance, and a new cosmetic design.

Mfr: Nady Systems

Circle 46 on Reader Service Card



MINIATURE ELECTRET LAVALIER MIC

- The MKE 2 miniature electret lavalier mic, which may be sewn in place or attached to clothing with an alligator clip, measures 0.24 inches in diameter by 0.43 inches in length. It will be available in several versions: The MKE 2-0 has a 10 foot cable terminating in stripped-and-tinned leads for connection to various wireless microphone transmitters. The MKE 2-3 has a connector for attachment to the K3U powering module. When used with the K3U, it may be phantom-powered (9 to 52 volts) or operated from the mercury battery contained in the K3U. It includes a three-position 12 dB/octave low-frequency rolloff switch, and a 10 foot cable. The MKE 2-6 has an in-line battery supply with on/off switch and a 13 foot cable terminating in a 3.5mm diameter mini-plug.

Mfr: Sennheiser

Circle 48 on Reader Service Card

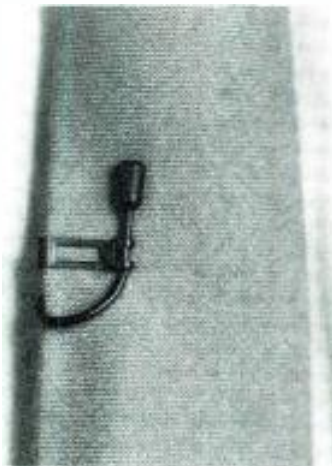

OMNIDIRECTIONAL DYNAMIC MICROPHONE

• The SM63L Omnidirectional Dynamic Microphone is an elongated version of the SM63. Like its companion model, the SM63L has an omnidirectional pickup pattern that meets the needs of broadcast journalists and announcers in all electronic media. Since the SM63L is 3½ inches longer than the SM63, it gives reporters the ability to bring the microphone itself closer to the subject in crowded, noisy interview situations. Its controlled low-frequency rolloff provides accurate, natural sound and voice pickup. Features of the SM63L include a humbucking coil that minimizes noise from electromagnetic hum fields and a built-in breath and pop filter. The SM63L is available in two versions: SM63L-LC (supplied without cable) and SM63L-CN (supplied with a 25-foot Triple Flex "Audio Connection" Cable with 3-pin connectors). Both models include an accessory windscreen and a swivel adapter for stand mounting.

Mfr: Shure Brothers Inc.
Price: SM63L-CN: \$145.25;
SM63L-LC: \$124.25

Circle 49 on Reader Service Card

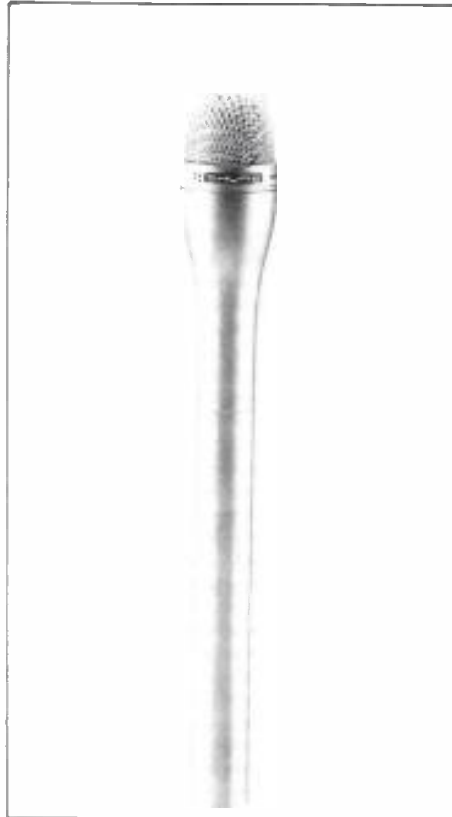

CONDENSER MICROPHONE



• The Beyer MC 734 vocal condenser microphone is designed primarily for use in on-stage and recording situations. Hissing and "popping" noises are suppressed, as is handling noise of the mic. The MC 734 features flat frequency response from 20 Hz to 18 kHz, and is equipped with a 3-step filter to compensate for the proximity effect in close mic'ing situations. Rumble and other stage noise is suppressed by a built-in stage resonance filter. The MC 734 withstands sound pressure levels of 138 dB at 1 MHz, and can be fed by any 48-volt phantom power source.

Mfr: Beyer Dynamic, Inc.

Circle 51 on Reader Service Card

PZM® MICROPHONE

• The PZM® 2.5 low-profile, minimum visibility microphone combines a precision-calibrated pressure capsule with a nearly invisible corner boundary to achieve improved directionality of coverage. It effectively captures and emphasizes sounds approaching from its front while rejecting sounds from behind. The PZM 2.5 is recommended for applications such as theatre productions, conferences and public speaking. In operation, the mic' can be placed on a surface such as a floor, table or lectern and aimed at the desired sound source. The corner boundary design increases the microphone's sensitivity and improves speech articulation through its specially tailored frequency response. The PZM 2.5 plugs directly into a 12 to 48 volt phantom power supply and includes a transformer balanced, low-impedance output and a permanently attached 15-foot multi-directional cable.

Mfr: Crown International

Circle 50 on Reader Service Card

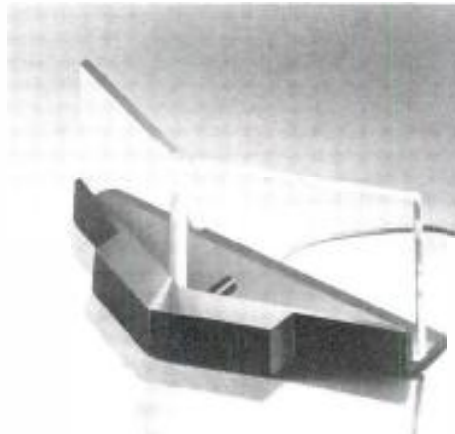

NEW CONDENSER MIC

• Milab's BM-73, an "on the road" condenser mic that replaces an older version, the DC-73, is a hand-held mic with a sturdy, easily replaceable front. The capsule is suspended in rubber to avoid mechanical and handling noise. A switchable proximity filter is incorporated for very close work. The mic is also suited for use in studios, on stage, or outdoors. It features low handling noise, low inherent noise, and a high-end rise for more crispness in sound.

Mfr: Milab

Circle 52 on Reader Service Card

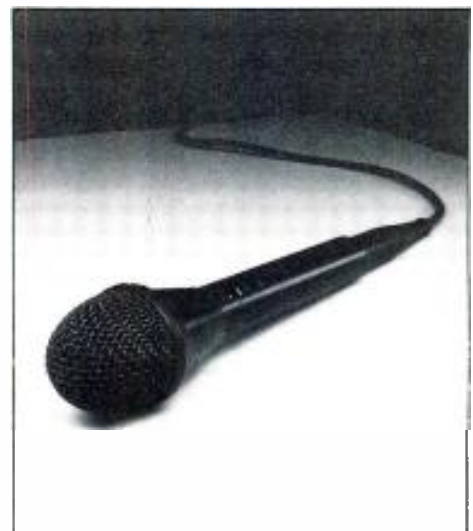

db Application Note

Some Noise About Noise

WITH EXPERIENCE REACHING back to direct-to-disc recording in the pre-tape era, I follow the evolution of audio technology with great interest. What I read of digital recording certainly is impressive. Absence of wow, flutter, tape noise, and generation losses must be welcome to any recordist. Whether these benefits are gained at the cost of purity of sound, as some critics insist, I can't tell from my vantage point. (Presently having no access to state-of-the-art equipment, I must be content with merely reading about it.) But the much-proclaimed near-100 dB dynamic range, presented as a panacea for all noise problems, brings into sharper focus an issue that is completely overlooked by the trade press in its preoccupation with music: theoretical minimum noise levels in speech reproduction.

REPRODUCTION OF SPEECH

Pure reproduction of speech is essentially as demanding of bandwidth as is music (drop in, say, a 12 kHz low-pass filter and you can hear the difference); is possibly more demanding with regard to transients; and is certainly more critical with respect to the noise floor. And there is a whole universe of speech applications—from disk jockey and news reporter, through movie and TV dialog, industrial video, and the vast instructional cassette market—which is short-changed by the industry's fascination with music recording. Recording signal-to-noise ratios of 100 dB unquestionably enhance music reproduction, but can they do as much for speech? Not if the *S/N delivered by the microphone* is substantially less—which my experience suggests is the case.

Even if we had a truly noiseless amplifier, we still have the problem of *thermal agitation* noise in the microphone itself. The magnitude of this noise voltage is given by

- $E = (4KTRB)^{1/2}$, where
- E = Thermal noise voltage (RMS).
- K = 1.38×10^{-23} , Boltzmann constant.
- T = Temperature, °Kelvin.
- R = Resistance, ohms.
- B = Bandwidth of interest, hertz.

For a microphone of 250 ohms resistive impedance, at room temperature and for a bandwidth of 20 kHz:

$$E = 2.88 \times 10^{-7} \text{ volts RMS}$$
$$= -130.8 \text{ dB re 1 volt.}$$

The thermal noise power level is

$$N_{th} = 10 \log (P/0.001)$$
$$= -124.8 \text{ dBm. (} P = E^2/R \text{)}$$

This may seem negligible but, as we shall see, it sometimes is not.

A pertinent question is, what portion of a microphone's internal impedance is resistive? One clue can be found in the effects of loading. For example, a moving-coil omnidirectional microphone produces essentially the same frequency response when terminated as when open-circuited; evidently, it is effectively a resistive generator. A ribbon microphone suffers decreased bass response when terminated, implying an effectively capacitive component of its impedance; yet we will find that it, too, is considered resistive as a thermal noise generator.

Seeking confirmation that microphone impedances are purely resistive as thermal noise generators, I searched manufacturers' literature for noise specifications. Not until I went back to the era when the 639A and 639B were manufactured by Western Electric did I find a reference to thermal noise. For the 639s, the "signal at 10 dynes per square centimeter [94 dB SPL] is 78 dB above the thermal noise generated within the microphone, and 58 dB for one dyne."

The rated nominal impedance of the W. E. 639 is 40 ohms, and performance was not specified beyond 10 kHz. Using $R = 40$ ohms and $B = 10$ kHz in the thermal noise formula yields a value that is just 78 dB below the rated 10-dyne output, a figure in agreement with the specification. Evidently it is valid to consider the impedance as purely resistive, even though one element in this microphone is a ribbon. Notice that for a modern bandwidth of 20 kHz, the noise level will be 3 dB greater, giving a S/N of 75 dB for a 10-dyne sound pressure.



PRECISION



MAGNETIC
TEST TAPES

STANDARD TAPE LABORATORY, INC.

26720 EDENLANDING ROAD #1 HAYWARD CALIFORNIA 94541 • 415/786-1546

94 dB SPL—IS IT ADEQUATE?

Is this adequate for speech work? Is the 10-dyne (94 dB SPL) reference used for rating sensitivities of most low-impedance microphones typical of conversational speech intensities at reasonable microphone working distances?

One manufacturer, in justifying the 94 dB SPL standard, asserts: "Experience indicates that the sound pressure produced at conversational level three feet from a microphone approaches 10 dynes per square centimeter." To this, I would retort that they must have been measuring conversations among deaf persons—or in stage productions, at least. My own observations with various sound-level meters show an average conversational SPL around 75 dB at one foot, dropping (in a live environment) to about 65 dB at three feet. I therefore conclude that the *alternate* microphone "standard" reference SPL of 1 dyne per square centimeter (74 dB SPL) is more typical of studio speech applications. This obviously degrades the specified signal-to-thermal-noise ratios by 20 dB. For the W. E. 639 and a 20 kHz bandwidth, thermal noise then is only 55 dB below average speech signal. Since hiss at -60 dB is audible in speech reproduction, a 55-dB ratio certainly demands attention, especially at greater-than-life SPLs.

Is this typical of self-generating microphones in general? To examine this, I calculated outputs according to manufacturers' specifications for 10 assorted professional dynamic and ribbon models to determine a "typical" signal output at 74 dB SPL. Because the best overall S/N generally is achieved with essentially unloaded microphones, I calculated open-circuit signal voltages (the problem of different rating methods used by various manufacturers is a subject unto itself). Since the calculated thermal noise also is an open-circuit voltage, this allows direct comparison.

The arithmetically averaged signal output for the 10 microphones at 74 dB SPL turned out to be about 120 microvolts. Rated impedances ranged from 150 to 600 ohms; I assume 250 ohms for the following calculation. We've already found that thermal noise for 250 ohms and 20 kHz is about $2.88 = 10^{-7}$ volts, so the S/N for this "average" microphone at 74 dB SPL is

$$20 \log_{10}(1.20 = 10^{-4}/2.88 = 10^{-7}) = 52.4 \text{ dB.}$$

and our composite microphone proves to have a poorer S/N than the ancient 639! Evidently there has been little progress in this aspect of microphones over the years. We simply cannot obtain desirably low noise levels with self-generating microphones without resorting to dynamic noise reducers or other subterfuges. What we need is greater sensitivity.

Are condenser microphones the answer? Many condensers are 10 to 20 dB more sensitive than dynamics; however, this characteristic doesn't come free. All condenser microphones employ active impedance converters, which generate noise of their own. Converter noise usually is specified in terms of equivalent acoustic noise arriving at the diaphragm: the lowest specification I've seen is 15 dB SPL equivalent, with 20 dB being more common. Thus, for conversation at 74 dB SPL, the best S/N with a condenser mic is $74 - 15 = 59$ dB, with 54 dB for more typical ones. With regard to internal noise, then, the condenser holds no edge over the dynamic, although its higher output does give it an advantage with respect to preamp noise.

How serious is internal microphone noise in comparison with background acoustic noise levels? A 15 dB SPL represents a very quiet studio, but the hiss of electronic noise is less tolerable than studio noise because the ear recognizes it to be foreign to the acoustic ambience. This is particularly so for speech, the intermittent nature of which provides less masking than does most music. More to the point, electronic noise is an artifact of technology, destroying the transparency that we all seek.

CONCLUSION

The trade press, waxing ecstatic over the impressive S/N of digital recording and highlighting the hazards of microphone and preamp overloading in this era of high-decibel entertainment, seems to have slighted those who still work with modest SPLs. Not all sounds to be reproduced are high-level; perhaps the industry needs to devote some attention to this area. ■

New Literature

PRODUCT CATALOG

• Kay Elemetrics Corp. new 20 page catalog describes its full line of attenuators, switches and R. F. Test equipment. The Attenuator product line includes Miniature Step, Standard Step, Rotary, Continuously Variable, Audio and OEM Programmable attenuators. Also described are the R. F. Mega switches, Pulsed Carrier Generators and Sweep Frequency Generator. The catalog describes complete electrical specifications, product dimensions, options and ordering information. For a free copy, contact: Kay Elemetrics Corp., 12 Maple Ave., Pine Brook, NJ 07058.



ACOUSTICAL WINDOWS BULLETIN

• Bulletin 3.1001, a two-page color-illustrated publication, features Noise-Lock windows offered in two standard configurations: single-glazed with a Sound Transmission Class or STC rating of 35 decibels and double-glazed with an STC rating of 47 dB. Also, a custom-designed triple-glazed window is available with STC ratings

of up to 90 decibels. All windows can be furnished for split- or fixed-frame construction and with bulletproof glazing as an option. Mentioned among the types of buildings these windows can serve are radio, television, and recording studios, plus places of public assembly like hotels, convention centers, concert halls and auditoriums. Typical design details are listed as are specifications including acoustic performance. Copies of Bulletin 3.1001 may be obtained by contacting: Communications Department, Industrial Acoustics Company, 1160 Commerce Avenue, Bronx, NY 10462.

New Products

DIGITAL DELAY PROCESSOR

• The Model 95 Prime Time digital delay processor retains most of the human engineering factors and control format of the original Prime Time. Like the Prime Time, it has two independently adjustable delay outputs, complete input and output mixing, and a wide array of control and interface capabilities. Additionally, Prime Time II has long delay capabilities: 1.92 seconds standard and 7.7 seconds with memory option. Complementing the unit's long delay are Lexicon's new DRC (Dynamic Recirculation Control) and metronome features. These allow Prime Time II to be used as a short term digital audio recorder to create new sound on sound layering effects.

DRC automatically controls the level of recirculating delays to provide clean phrasing with long decaying echoes at the end of phrases. The metronome feature, when used with the infinite repeat, allows creative use of captured delay loops, which may be synchronized by the metronome clock, to drive external automatic drum and synthesizer equipment. Prime Time II utilizes PCM encoding technology. It provides low distortion of 0.04 percent throughout its full power bandwidth, 90 dB dynamic range and 20 Hz to 16 kHz audio bandwidth.

Mfr: Lexicon, Inc.

Circle 53 on Reader Service Card

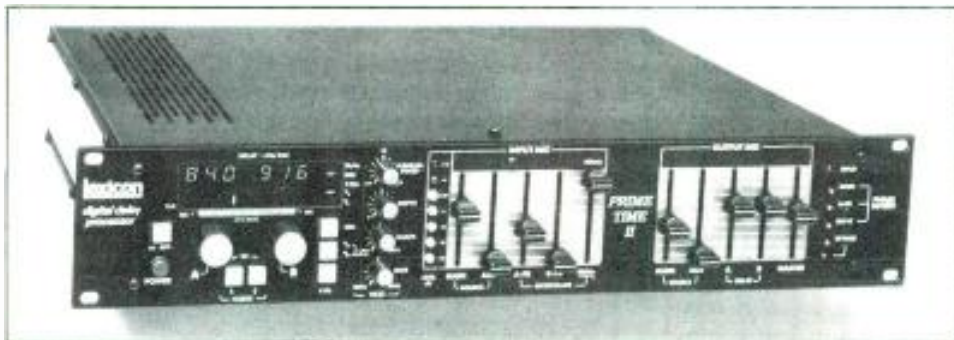

COMPUTER-CONTROLLED AUDIO PROCESSOR

• The Model 250 computer-controlled audio processor is one of the first implementations of computer control over a station's sound. The processor is statically programmable with various processing presets which may be selected remotely; alternatively, a low-cost computer interface option links the 250 with any of several inexpensive microcomputers with RS-232C serial data interface for continuous, on-line

control of program spectrum dynamics. Designed for stereo (or mono) program signal processing, the Model 250 incorporates a gain-riding A.G.C., five-band compressor and either a split-band peak limiter for FM and TV or a full-matrix AM stereo peak limiter. The 250 also features L/R correlation to preserve stereo image, flat frequency and phase response, and feedforward PWM gain control for colorless, drift-free performance.

Mfr: Inovonics, Inc.

Circle 54 on Reader Service Card

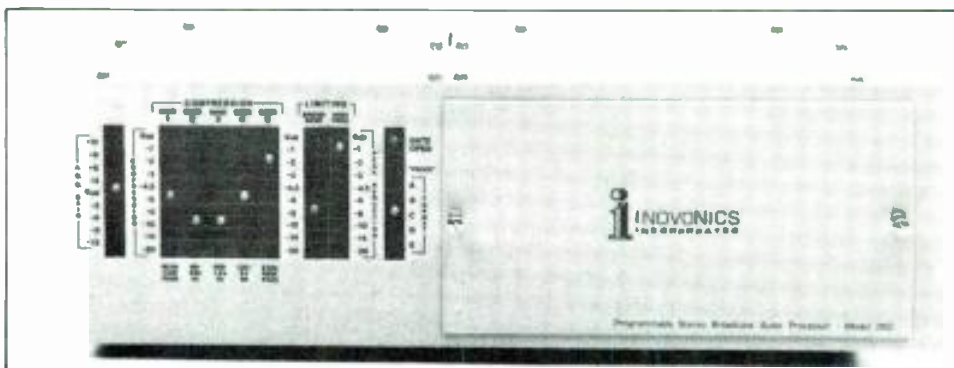

Audio Tape for professionals



REEL TO REEL TAPE

Amplex, 3M. All grades.
On reels or hubs.

CASSETTES, C-10-C-90

With Agfa, TDK tape.

LEADER & SPLICING TAPE

EMPTY REELS & BOXES

All widths, sizes.

**Competitive!
Shipped from Stock!**

Ask for our recording supplies catalog

Polyline Corp. 312/298-5300

1233 Rand Rd. • Des Plaines, IL 60016

15

Circle 29 on Reader Service Card



EL-15 Woofer

- 25-5000 Hz
- 200 Watts
- 100 dB M/W
- 4" Voice Coil



For complete information:

(714) 632-8500

(800) 854-7181

EMILAR CORPORATION

1365 N. McCan St.,
Anaheim, CA 92806

Circle 31 on Reader Service Card

POWER AMP

• The FET-500 power amplifier features MOS-FET devices in the output stage, eliminating second breakdown, thermal runaway, and storage time. Unlike MOS-FET designs which simply replace conventional power transistors in an existing design with MOS-FETs, the FET-500 has a driver circuit designed from the ground up to take advantage of a number of unique MOS-FET characteristics. A discrete, full-complementary high-speed design with moderate gain and reasonable levels of negative feedback was chosen after listening comparisons with other circuits. A total of 16 MOS-FET devices, combined with a high-energy power supply, assure the ability to deliver large amounts of power. Generous heatsink area and a carefully designed cooling system let the FET-500 operate continuously into demanding loads without overheating. Standard features include modular construction, balanced inputs, three color LED level indicators, mono and bridging switches, and quiet forced-air cooling.

Mfr: Ashly Audio, Inc.

Price: \$995.00

Circle 55 on Reader Service Card

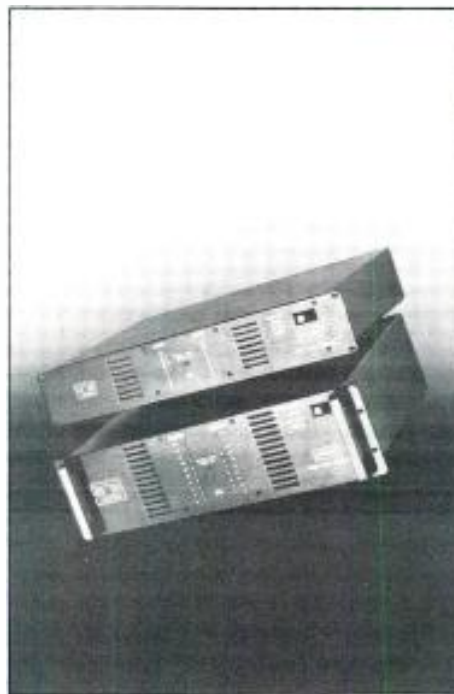

HIGH POWER AMP KIT

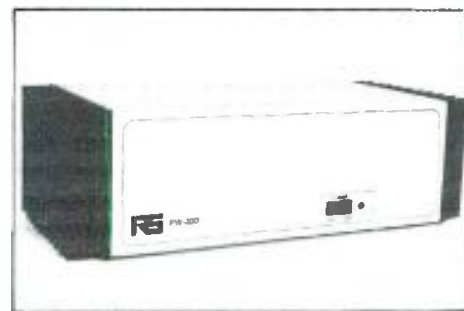

• Radio Systems' PW-200 power amplifier features state-of-the-art technology in kit form or assembled. At 100 watts per channel, 300 watts mono, THD and IM distortion are less than .03 percent. Rated for four and two ohm loads, the PW-200 features 8 120-watt ring emitter output transistors per side, FET input, and 90 joule power supply. Metal film resistors and film capacitors are used throughout.

Mfr: Radio Systems, Inc.

Price: \$375.00 in kit form with pre-tested amplifier modules;

\$475.00 fully assembled

Circle 56 on Reader Service Card

STUDIO MONITOR SPEAKER

• Electro-Voice's new studio monitor speaker, the Sentry 505, is an acoustic match for the Sentry 500 monitor, but features a smaller enclosure that is angled for ceiling/wall mounting locations. The smaller cabinet volume of the Sentry 505 has been carefully calculated to roll off the system's low frequency at a rate that compensates for the bass boost which occurs when a speaker system is mounted in a "quarter space" environment (where the speaker is mounted at the intersection of two large surfaces such as a ceiling and a wall). The model 505 produces 96 dB (1 watt, 1 meter, anechoic), and features frequency response that is essentially flat from 40 Hz to 18 kHz. While it can be powered by modestly sized amplifiers, it can handle 100 watts average long term, and short term peak loads of 400 watts. Careful attention to transducer geometry and crossover

design provides acoustic phase coherence in the crossover region. A specially designed director for the tweeter matches the dispersion angles of both transducers at the crossover point. The result is controlled vertical and horizontal dispersion of sound in the critical 250 Hz to 10 kHz range, which Electro-Voice calls "Constant Directivity." Frequency response of the system can be extended down to 28 Hz with the addition of the SEQ low frequency step-down kit. The Sentry 505 weighs 60 lbs., is supplied in a matte black vinyl-covered enclosure, and includes mounting brackets. The grille of the speaker is removable and the front panel provides easy access to a 4-position tweeter attenuator that allows adjustments from a flat setting to -9 dB in 3 dB steps.

Mfr: Electro-Voice

Circle 57 on Reader Service Card



Introducing
**THE
 SOUND EFFECTS
 LIBRARY
 FOR
 PROFESSIONALS**

- 3000 STEREO EFFECTS
- 30 HOURS OF SOUNDS
- 125 TAPES at 7½ or 15ips
- PRICED FROM \$1500.00
- NO ROYALTY PAYMENTS EVER

"Some of our Clients."

- * ABC
- * NBC
- * CBS
- * Walt Disney



86 McGill Street,
 Toronto, Ontario,
 Canada, M5B 1H2
 (416) 977-0512

Circle 30 on Reader Service Card

LOUDSPEAKER SYSTEM

• Meyer Sound's new 833 Studio Reference Monitor is a high-power, low distortion loudspeaker system designed for critical studio applications. The system consists of two vented enclosures, each housing a single proprietary 15-inch cone low-frequency driver, passive crossover, and horn-loaded high-frequency driver, along with an active stereo electronics unit containing subsonic filter, frequency and phase response correction circuitry, and Meyer Sound's Speaker Sense™ driver protection circuitry. The 833 Monitor requires a high-quality stereo power amplifier capable of delivering between 100 and 400 watts per channel continuously into 8 ohms. It offers the advantages normally associated with bi-amplified systems while utilizing a passive crossover, requiring only a single stereo amplifier. All components of the system and the finished system

itself are tested for reliable performance. The electronics unit features an LED bar display of true amplifier power and a user-settable peak limiter that acts on the signal at line level. Typical system performance characteristics with a power amplifier rated at 250 watts per channel include: frequency response, 35 Hz to 18 kHz ± 3 dB; system time delay (including electronics), ± 350 microseconds from 100 Hz to 15 kHz; high-frequency dispersion, 80 degrees horizontal, 40 degrees vertical, and maximum sound pressure levels of 120 dB continuous, 130 dB peak. The loudspeaker cabinets measure 20-in. wide by 32-in. high, by 14 $\frac{1}{4}$ -in. deep, and are fitted with mounting hardware for control room installations.

Mfr: Meyer Sound Laboratories, Inc.
Circle 58 on Reader Service Card

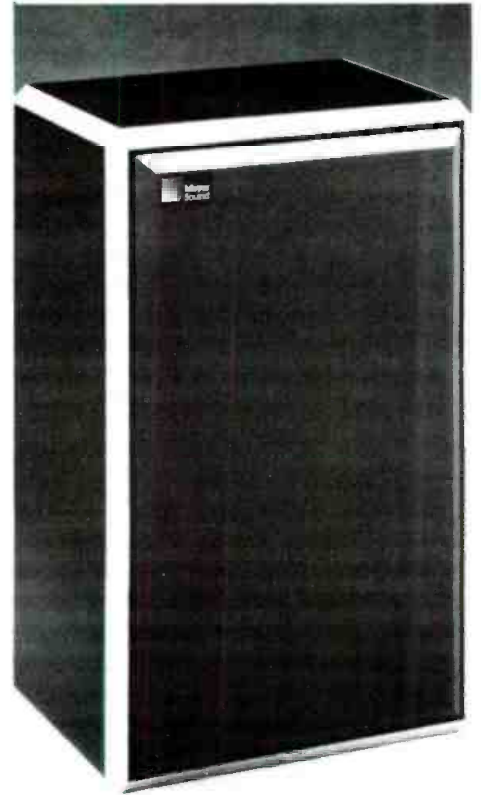

MODULAR MIXER

• Soundtracs' 80 Series is a modular mixer allowing construction of units as small as one/in. two/out. and as large as 36-12-2. Each subgroup is a stereo pair and each monitor section of the subgroup can be switched to a tape return allowing 24-track tape monitoring. Each channel has only one routing switch. By the implementation of a microprocessor in the system, the input channel can be routed to as many subgroups as there are in the mixer as well as the master. Additionally, the auxiliary returns are all assignable to the subgroups and masters via the microprocessor. There are four options

available: 1) By pressing the routing switch on each channel or the aux return, the subgroup master to which it is routed will display via an LED; 2) by pressing the subgroup (pair) or master, the input channels/auxiliary returns assigned to it will display via an LED; 3) the subgroup/input channel assignments can be displayed on a TV monitor via a UHF output; 4) the mixer can interface with a video display and keyboard via a video output. By determining the function of each input channel (1 = keyboard, 2 = tom-tom, etc.) the display will write the subgroup format.

Mfr: Soundout Laboratories Limited
Circle 59 on Reader Service Card

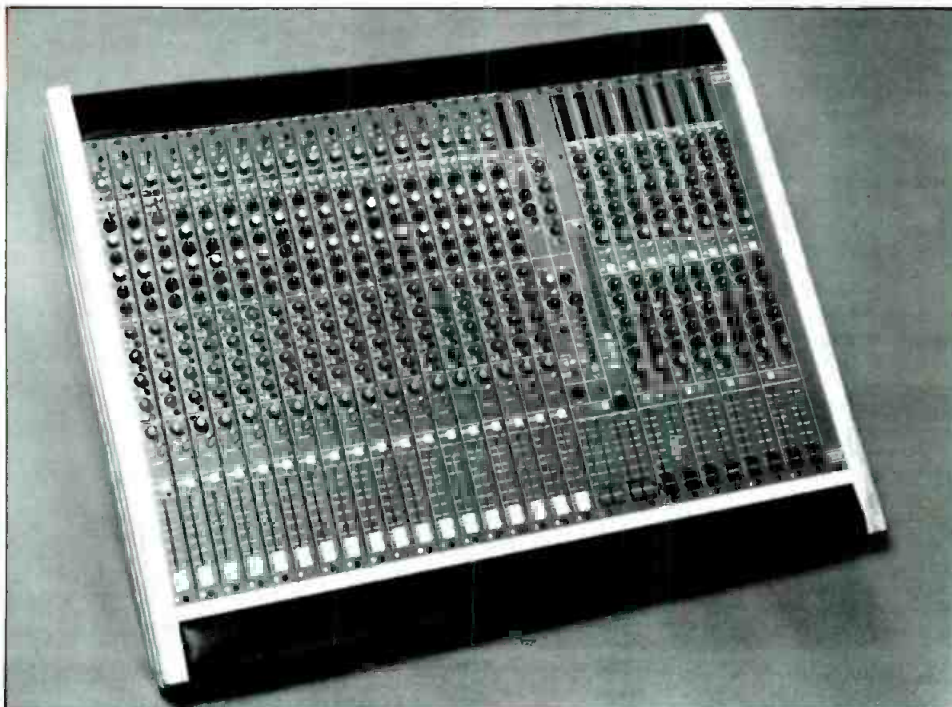

In general, spring reverbs don't have the best reputation in the world. Their bassy "twang" is only a rough approximation of natural room acoustics. That's a pity because it means that many people will dismiss this exceptional product as "just another spring reverb". And it's not. In this extraordinary design Craig Anderton uses double springs, but much more importantly "hot rod's" the transducers so that the muddy sound typical of most springs is replaced with the bright clarity associated with expensive studio plate systems.

Kit consists of circuit board, instructions, all electronic parts and two reverb spring units. User must provide power (± 9 to 15 v) and mounting (reverb units are typically mounted away from the console).

CHARGE TO VISA OR MC TOLL-FREE
1-800-654-8657 9AM to 5PM CST MON-FRI

DIRECT INQUIRIES TO:

PAA Electronics, Inc.

Dept. 3d, 1020 W. Wilshire Bv. Oklahoma City, OK 73116 (405) 843-9626

Send the 6740 REVERB KIT \$59.95 plus shipping (\$3) enclosed or charged.

Send Free Catalog

name _____

address _____

city _____ state _____ zip _____

Circle 32 on Reader Service Card

HIGH OUTPUT MONITOR

• The new KEF KM-1 is a monitor loudspeaker capable of producing high sound pressure levels without sacrificing sonic accuracy. It features an integral power amplifier with a maximum output exceeding 1200 watts. The amplifier is comprised of two power supplies and eight separate output sections to feed seven drive units. An active three-way dividing/equalizing network to be fed from a separate power supply is included. A unique hybrid floating input circuit ensures low distortion, improved isolation, and very wide bandwidth. The KM-1 features an S-type soft clipping limiter that is automatically activated under conditions of near continuous peak overloading. This permits up to 6 dB

increase in loudness without significant audible distortion. Additionally, full electronic overload protection safeguards all the drive units and integral electronic circuits against accidental overloads. An important specification of the KM-1 is the sound pressure level, which is 120 dB SPL on program peaks under typical listening conditions, having a frequency response of 30 Hz to 20 kHz ± 2 dB and a signal-to-noise ratio of over 100 dB. Although the KM-1 was intended initially for use in recording studios, it can also be used for monitoring live classical music. It is also suitable for use as an auditorium loudspeaker for theatres and concert halls.

Mfr: KEF

Circle 60 on Reader Service Card



OPTIMOD-TV

• Orban's new Optimod-TV Model 8181A is a second generation audio processor for television. It incorporates a Loudness Controller licensed from CBS Technology Center, and features an improved peak-limiting circuit to substantially improve distortion performance on low quality voice material. Optimod-TV represents a system approach to level control that is devoid of audible processing side-effects, even on difficult feeds such as 16mm optical sound tracks. The Loudness Controller can be expected to reduce viewer complaints of excessive commercial loud-



ness. On high-quality music feeds, the original fidelity is also preserved. The unit is fully equipped to drive a TV stereo generator and to interface with a TV stereo commander. It can be obtained in a split configuration allowing pre-processing to enhance STL S/N performance. Setup is easy, and no

adjustments are required during normal operation. The Loudness Controller can be remotely activated if desired.

Mfr: Orban Associates, Inc.

Price: \$4,995.00

Circle 61 on Reader Service Card

MIXER POWER AMPS

• Panasonic Industrial Company's two new 5-input mixer power amps both feature high-power output, low THD and telephone paging capability. The Model WA-750P has a 120-watt capability. The Model WA-750P has a 120-watt capability. Total harmonic distortion is 1 percent at 1 kHz; frequency response is 50 Hz to 20 kHz ± 3 dB. This unit can accept inputs from three low impedance microphones. The WA-750P has two auxiliary inputs, one of which is transformer-balanced for telephone paging input. The Model WA-750P weighs 26 lbs. and measures 16.5-in. wide by 5.7-in. high by 10.23-in. deep. The Model WA-740P has a 60-watt capability, and a THD of 1 percent at 1 kHz. Frequency response is rated at 50 Hz to 20 kHz ± 3 dB. It has five separate inputs, three which accept low impedance microphones, and two which accept auxiliary equipment. There is one microphone and one auxiliary channel with transformer balance for telephone ringing oper-



ation. The WA-740P weighs 20.9 lbs. and measures 16.5-in. wide by 4-in. high by 10.23-in. deep. Both units have a voice-activated priority circuit built-in. There are VU-type level meters to indicate sound level, and a 1 kHz tone generator is built-in to both for sound

level settings. Sound quality is controlled with master volume and independent bass and treble controls. Both models are rack-mountable with optional rack mount adaptors.

Mfr: Panasonic Industrial Corp.

Circle 62 on Reader Service Card

AUDIO MASTERING TAPE

• Agfa PEM 428 two-inch mastering tape is a one-mil. version of Agfa PEM 468 studio mastering tape. The tape offers 4800 ft. on a 12 $\frac{1}{2}$ -inch reel, which results in a full hour of recording time at 15 ips. The longer playing time available on a 12 $\frac{1}{2}$ -inch reel corresponds to a standard length video tape, making the two compatible. Agfa PEM 428 is a high output, low noise tape offering improved dynamic range. The polyester base is tensilized and therefore stronger than tapes that use a thicker but weaker conventional base. It offers improved print-through characteristics which largely reduce the effects of pre-and-post echo. The tape is produced with winding characteristics which eliminate the need for slow winding, and mechanical and electro-acoustical properties which lessen the need for machine realignment. Quality slitting assures consistent edge tracks, even transport across the head, and accurate phase relationship from edge to edge. Batch number and web position on the back coating assure permanent tape type identification.

Mfr: Agfa-Geraert Magnetic Tape Division

Circle 63 on Reader Service Card



ROTARY FADER



• Penny & Giles new rotary fader features the same smooth feel and reliability of the company's linear faders. A conductive plastic element offers infinite resolution. Available in mono or stereo option, the fully sealed rotary faders feature up to eight outputs, audio, linear, or pan pot taper, and optional detents and switches.

Mfr: Penny & Giles

Circle 64 on Reader Service Card



450 WATT/CHANNEL POWER AMP

• Carver Corporation has entered the field of professional sound reinforcement with the Carver Magnetic Field Amplifier PM-1.5, a low-feedback, high headroom amplifier. The PM-1.5 is a professional version of the Carver M-400, delivering 450 watts/channel. The amp weighs 21 lbs. and measures 19-in. wide by 3.5-in. high by 10.81-in. deep. All of the amplifiers are thoroughly road and bench tested. Special features include fully proportional fan cooling, recessed front panel controls, adjustable speaker protection circuit thresholds, remote turn-on sequencer with soft-start power-up mode. Dynamic Headroom Controller, dual modes of precision balanced inputs using 1-percent resistors, Clipping Eliminator, easy-to-see LED for power monitoring, and reinforced front and rear rack mounts.

Mfr: Carver Corporation

Circle 66 on Reader Service Card



HIGH SPEED CASSETTE DUPLICATING SYSTEM



• Sony's new high speed audio cassette duplicating system, the CCP-13B series, is a 4-track/4-channel mono/stereo cassette-to-cassette or reel-to-cassette system expandable to 43 copies. The new "B" series duplicators feature improved crosstalk specifications and plug-in circuit boards for ease of service. Furthermore, a new capstan and pinch roller design has been incorporated to improve tape-to-head contact. The system also incorporates an improved tape guide head that prevents static noise from being recorded on the tape. All the duplicators have ferrite and ferrite heads that are guaranteed against wear for two years.

Mfr: Sony, distributed by Educational Electronics Corporation

Circle 65 on Reader Service Card

MIXER PREAMP WITH EQUALIZER

• Numark's new DM1650RM is a professional mixer/preamp with built-in six-band equalizer designed to fit EIA standard 19-inch racks. The unit has two stereo inputs and four line inputs, two of which are switchable to mic inputs. All volume, equalizer, fade, and cue controls are of the slide-type. Standard features include -14 dB talk-over, equalizer defeat, easy-access headphone input with separate volume control, low cut filters on mic inputs, cue and line monitoring, dual LED meters with automatic peak hold and reset, and separate +16 and -16 V power supplies. The built-in low noise preamp can drive almost any power amplifier, or it can be connected to the auxiliary input of any receiver or integrated amplifier. It is suited for mixing sound-on-sound recordings, making video and movie sound tracks, or for PA applications.

Mfr: Singer Products Co., Inc.

Circle 71 on Reader Service Card

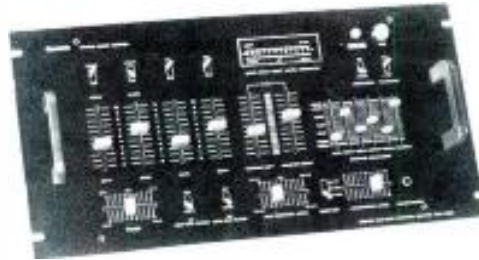

RCF COMPRESSION DRIVER



• Acoustic Works' new Model N-480 RCF one-inch-exit professional compression driver offers extended frequency response and high power handling. The principle performance feature of the driver is its extended high frequency response of -3 dB to -6 dB (depending on the horn) at 18 kHz. This high-frequency response is the result of a very high flux magnetic assembly producing 19,500 gauss-in-the-gap, and a precision phase plug. The high power handling of the N-480, achieved through the use of a 44.4mm composite diaphragm made of chemically impregnated linen and a copper wire voice coil, makes it suitable for live performance and commercial applications. Versatility in horn driver interface is provided by the use of a universal five-bolt pattern, enabling the driver to mate with all international standard one-inch entry horns, including the two-bolt "Altec Standard," the three-bolt "JBL Standard," and the four-bolt "European Standard."

Mfr: Eastern Acoustic Works

Price: \$110.00

Circle 69 on Reader Service Card

ELECTRONIC CROSSOVERS

• Renkus-Heinz' new SWG series of electronic crossovers have unique signal processing capabilities. Both crossovers (one mono, one stereo) feature state-variable filters, tunable from 500 Hz to 5000 Hz. In addition, they provide exact equalization for one-inch and two-inch drivers. Computer electronics protect the drivers against thermal and displacement overloads without audible effects. Accurate time compensation for Renkus-Heinz speaker systems is also included.

Mfr: Renkus-Heinz

Circle 68 on Reader Service Card



DIGITAL REVERB

• Lexicon's Model 200 Reverb, designed for live performance, small studio and broadcast applications, features a continuously variable pre-delay, reverb time from 0.2 to 70 seconds and acoustic ambience controls that simulate the spatial characteristics of acoustic environments. Preset effects include several plate reverbs, chamber simulations and concert hall simulations. Non-volatile memory allows any setup to be stored and recalled on demand. Controls adjust reverb frequency contour, high-frequency roll-off, echo density and early reflections. Frequency response is within ± 0.5 dB from 20 Hz to 10 kHz, with 84 dB typical dynamic range, 81 dB minimum. Noise and distortion are 0.04 percent typical, 0.07 percent maximum at 1 kHz reference level. Input level



range is -12 to +24 dBm, and outputs are capable of driving all standard lines and downstream devices. The Model 200 occupies 5 1/4 inches of rack space and weighs 18 lbs. A remote-controlled jack permits selection of preset programs by footswitch or external logic signal control. Power

consumption is 75 watts and all international line voltages are switch-selectable on the rear panel. RFI rejection meets FCC requirements for Class A devices.

Mfr: Lexicon, Inc.

Circle 70 on Reader Service Card

MULTI-FUNCTION SIGNAL PROCESSORS

• Valley People's 430 series is the new successor to their 410/420 series Dyna-Mite and Dyna-Mic multi-function signal processors. The 430 series is packaged in an aluminum and steel enclosure providing significant RFI suppression and durability for on-the-road use. The model 430 consists of two channels of the Dyna-Mite signal processor. Each channel is individually capable of performing limiting, expanding, noise-gating, keying, FM limiting, de-essing, and voice-over. The two channels may be coupled for stereo operation. Each Dyna-Mite channel includes Valley People's Linear Integration Detector. As a limiter, the Dyna-Mite also offers Threshold/Output coupling to maintain a predetermined output level, regardless of the amount of limiting. An Anticipatory Release computer on board the Dyna-Mite insures short release times without excessive pumping and modulation distortion. The model 431 is a combination of one Dyna-Mite and one Dyna-Mic channel, and the 432 is two channels of Dyna-Mic. The Dyna-Mic employs modified Trans-Amp™ transformerless preamplifier technology. Each of the two independent preamplifier sections will accept a variety of input sources including mics, musi-



cal instruments, and line levels. Mixing controls and front panel switches allow freedom of routing. Either or both inputs may be passed through the three-band equalizer section, offering ± 14 dB in each band. The single output of each Dyna-Mic provides optimum level interfacing to feed line-level gear, musical instrument amplifiers, and

audio sections of video equipment. All models may be ordered with an optional front panel jack that allows the user ready access to inputs, external inputs, outputs, patch points, and control/meter functions by use of a patch cord at the rear panel.

Mfr: Valley People, Inc.

Circle 70 on Reader Service Card

MIXER

• The Seemix is a sound mixer mainly intended for broadcast use, but it also has the possibility of simultaneous multitrack recording by means of direct output before the fader to the multitrack recorder. It has complete free groupability possibilities, and the number of input channels can vary from 24 to 48. The mixer includes eight subgroups, eight DC groups, six mono and one stereo auxiliary output, as well as a four-band channel equalizer and a bass and treble filter. The new opto-digital fader modules in each channel are computer-controlled, as is the group and output routing and signaling system. This is accomplished by means of a central assignment and routing panel. Options include a compressor/expander/gate in each channel, automatic mixdown, and a comprehensive telephone system including three 4-wire hybrids for telephone interviews.

Mfr: Tore Seem A/S

Circle 67 on Reader Service Card



COMPRESSOR/LEVELER/ PEAK LIMITER

• Aphex System's new Compellor is a versatile audio processing tool that combines the functions of audio compression, leveling, and peak limiting. The unit offers complete dynamics control, inaudible compression, increased loudness, and freedom from constant "gain riding." It is designed for broadcast pre-processing, motion picture dubbing, live concerts, audio and video tape duplicating, audio production, and microphone control.

Mfr: Aphex Systems, Ltd.

Price: \$995.00

Circle 72 on Reader Service Card

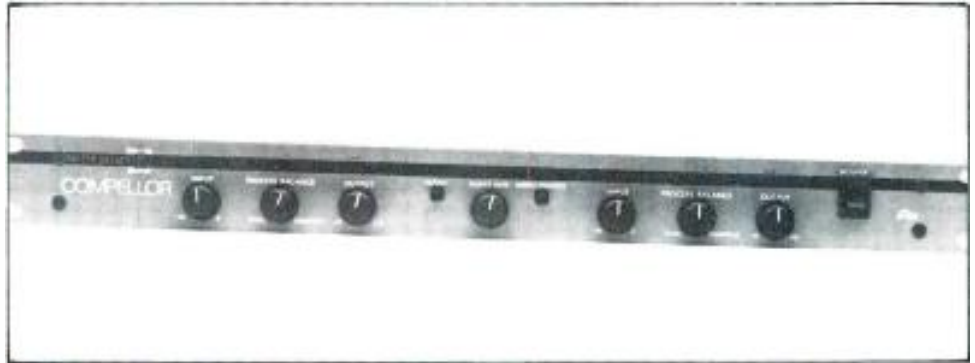

VOICE GATED AUDIO MIXERS

• Edecor's new series of Voice Gated audio mixers uses high-speed CMOS logic and ultra-low noise operational amplifiers. The AL 100 has four Voice Gated balanced or unbalanced microphone inputs and one ungated auxiliary input. The AL 200 has eight Voice Gated balanced or unbalanced inputs and one ungated auxiliary input. Both mixers have balanced microphone or line level output and an unbalanced monitor output. Frequency response is better than 0.5 percent from 20 Hz to 20 kHz, and distortion is less than 0.5 percent THD.

Mfr: Edecor

Price: \$260.00 for the AL 100

\$450.00 for the AL 200

Circle 73 on Reader Service Card



HIGH INTENSITY LAMP

• Littlite High Intensity Lamps are available in 12- (L-3/2) and 18-inch (L-3/18) lengths. Both of the sets include base and dimmer (with "off" position), 6 foot cord, wall plug-in transformer, gooseneck, high intensity hood and quartz halogen bulb. Two pieces of snap mount material are included as well as two screws (for permanent installation).

Mfr: CAE, Inc.

Price: L-3/12: \$49.95; L-3/18: \$51.60

Circle 74 on Reader Service Card



Classified

Closing date is the fifteenth of the second month preceding the date of issue.

Send copies to: Classified Ad Dept.

db THE SOUND ENGINEERING MAGAZINE

1120 Old Country Road, Plainview, New York 11803

Minimum order accepted: \$25.00

Rates: \$1.00 a word

Boxed Ads: \$40.00 per column inch

db Box Number: \$8.50 for wording "Dept. XX," etc.

Plus \$1.50 to cover postage

Frequency Discounts: 6 times, 15%; 12 times, 30%

ALL CLASSIFIED ADS MUST BE PREPAID.

FOR SALE

CASSETTE DUPLICATION IN real time from 10-10,000. Nakamichi cassette decks used for optimum quality. Best rates. labels, inserts and shrink wrap available. Fast turn around. **Audiohouse (303) 751-2268.**

TECHNICS TURNTABLES IN STOCK! AKG, Neumann, UREI, Orban Eventide, dbx, Lexicon. Best pro-audio equipment. Lowest prices. IMMEDIATE DELIVERY. **UAR Professional Systems. (512) 690-8888.**

USED RECORDING equipment for sale. **Dan (415) 441-8934.**

THE LIBRARY . . . Sound effects recorded in STEREO using Dolby throughout. Over 350 effects on ten discs. \$100.00. Write **The Library, P.O. Box 18145, Denver, CO 80218.**

MICROPHONES. Immediate delivery via UPS. All popular models in stock. Best prices you'll see in '83: PLUS we pay freight. **UAR Professional Systems, 8535 Fairhaven, San Antonio, TX 78229. (512) 690-8888.**

FOR SALE—AKG C-24 and other tube type condenser mics. **(415) 441-8934 or 527-6167.**

DIRECT FROM BROADWAY

USED SOUND EQUIPMENT SALE

PETER PAN • FIDDLER • CAMELOT
KING & I • CHORUSLINE • DOLLY
Wireless Microphones
Used By The Stars
AMPS • MIXERS • RECORDERS
all guaranteed

 **SOUND ASSOCIATES, INC.**
424 WEST 45 ST. • N.Y. N.Y. 10036
TELEPHONE 212 757 5679

PRO AUDIO IN STOCK—ready to ship. Top lines, top dollar trade-ins, clearance specials. Call or write for our prices. **Professional Audio Video Corporation, 384 Grand Street, Paterson, NJ 07575 (201) 523-3333.**

FREE 32pg Catalog & 50 Audio/Video Applic.

 **PHONO, MIC, TRANS, ACH, TAPE, VIDEO, LINE, OSC.**

 **PWR SUPP. EQ.**

Stereo Mono Per Amp.

8-in. 2-out, 12-in. 4-out, 18-in. 4-out

Video & Audio Dist. Amps **TV Audio & Recd. Prod. Consoles**

OPAMP LABS INC (213) 934-3566
1033 N Sycamore Av LOS ANGELES CA, 90036

BLANK AUDIO AND VIDEO CASSETTES direct from manufacturer, below wholesale, any length cassettes 4 different qualities to choose from. Ampex and Agfa mastertape—from 1/4-inch to 2-inch. Cassette duplication also available. Brochure. **Andol Audio Products, Inc., Dept. db, 42-12 14th Ave., Brooklyn, NY 11219. Toll free 1-800-221-6578, ext. 1, NY residents (212) 435-7322.**

EQUIPMENT FOR SALE: 5 (five) Dolby A301 N.R. Units available. Reasonably priced. **Dan (415) 441-8934.**

LIKE NEW! Console-mounted Ampex ATR-102 two-channel with new 1/4" and 1/2" two-channel metal heads. \$4300.00. **(617) 837-9196.**

AGFA CHROME and normal bias BLANK CASSETTES. CUSTOM LOADING to the length you need. Your music deserves the best—your budget deserves a bargain. **GRD P.O. Box 13054, Phoenix, AZ 85002. (602) 252-0077.**

NEUMANN U-87, U-47, four each. Used once. In warranty. \$849, \$829. Call **John (512) 690-8187.**

SERVICES

MAGNETIC HEAD relapping—24 hour service. Replacement heads for professional recorders. IEM, 350 N. Eric Drive, Palatine, IL 60067. (312) 358-4622.

ACOUSTIC CONSULTATION—Specializing in studios, control rooms, discos. Qualified personnel, reasonable rates. Acoustilog, Bruel & Kjaer, HP, Tektronix. Ivie equipment calibrated on premises. Reverberation timer and RTA rentals. Acoustilog, 19 Mercer Street, New York, NY 10013. (212) 925-1365.

AMPEX FACTORY SERVICE: Complete service and parts for Ampex equipment: professional audio, helical-scan video systems and professional audio motor and head assembly rebuilding. AMPEX SERVICE CENTER, 719 W. Algonquin Rd., Arlington Heights, IL 60005, 1-800-323-0692 or (312) 358-4622.

VIF INTERNATIONAL will remanufacture your Ampex or Scully (Ashland/Bodine) direct drive capstan motor for \$200. Average turn around time 2-3 weeks. For details write: P.O. Box 1555, Mountain View, CA 94042, or phone (408) 739-9740.

WANTED

WANTED: TRANSCRIPTION discs, any size, speed. Radio shows, music. P.O. Box 724-db, Redmond, WA 98052.

WANTED: MCI, Neve console; MCI, Ampex tape machine; Neumann, E-V mics; McIntosh amps. (204) 885-2922 or 837-8970.

EMPLOYMENT

N.J. based major Japanese manufacturer of magnetic tape looking to establish technical support staff. Thorough knowledge of video and audio essential, and experience in magnetic media and/or video camera electronics preferred. Also desire good communication skills. Send resume and salary history to: Dept. 20, db Magazine, 1120 Old Country Rd., Plainview, NY 11803.

Established sound recording studio in mid-town Manhattan needs a self starter w/experience in installation and operation of tape and sprocketed magnetic recording equipment. Send resume to Dept. 50, db Magazine, 1120 Old Country Rd., Plainview, NY 11803.



Have you misplaced your db again? Our high quality, royal blue vinyl binders keep 12 copies of db neat and handy for ready reference.

Just \$9.95, available in North America only. (Payable in U.S. currency drawn on U.S. banks.) ORDER YOURS NOW!!

Sagamore Publishing Co., Inc.
1120 Old Country Road
Plainview, NY 11803

YES! Please send db binders
@ \$9.95 each, plus applicable sales tax.
Total amount enclosed \$

Name
Company
Address
City
State Zip



People, Places

• **John P. "Jack" Jenkins**, the general manager of **International Tapetronics Corporation, Inc. (ITC)**, a subsidiary of 3M, has resigned that post to pursue other personal interests. The management change was announced by **J. B. Hanks**, manager of ITC's parent unit, the Broadcasting & Related Products Department of 3M in St. Paul, Minnesota. Hanks said key management personnel of ITC will report to him until a successor to Jenkins is appointed. Jenkins said he was making the change because the transition of ITC into the 3M organization had been completed smoothly. He also expressed his conviction that the continued success of ITC as a part of the Bloomington/Normal community is assured. Jenkins was one of the founders of ITC in 1969, and was its president when 3M purchased the firm in late 1981.



• **Arthur H. Hausman**, Chairman of the board of directors of **Ampex Corporation** announced that **Roy H. Ekrom**, 53, vice president and general manager of **The Garrett Corporation's** Pneumatic Systems Division has been named president and chief executive officer of Ampex. Garrett and Ampex are operating units of **The Signal Companies, Inc.** Hausman, who was elected president and chief executive officer in 1971, and who has been serving as chairman of the board in addition to his duties as president and chief executive officer for the past two years, said he was very pleased with the selection of Roy Ekrom. "Roy comes to us with an outstanding record from Garrett, and I am confident he will do extremely well here at Ampex." Ekrom has been vice president and general manager of the Garrett Pneumatic Systems Division, Phoenix, since January, 1981. Prior to that time he was assistant general manager of Garrett operations in Phoenix, then known as **AiResearch Manufacturing Company of Arizona**.

• **Wayne Freeman**, Marketing manager of **Soundcraft Electronics, USA**, announced that **Erika Lopez** has been appointed by Soundcraft to handle all advertising and public relations for the company. Ms Lopez was formerly with **Recording Engineer/Producer** magazine and **Neilson/Anklam** advertising agency.



• **Itam Corporation** of England has appointed **J. C. Audio Distributors** of Lancaster, MA and **Studiobuilders** of Burbank, CA as the exclusive distributor in the U.S. for its line of tape machines and mixing consoles. Itam manufactures 8- and 16-track one-inch format tape recorders as well as mixing consoles for studios, audio/visual applications and performing artists. **J. C. Audio Distributors** and **Studiobuilders** are currently in the process of developing a limited dealer network for the products.

• **Aphex Systems Ltd.**, developer and manufacturer of professional broadcast, recording studio and concert sound equipment, is expanding its production and manufacturing facilities by moving to a new plant in North Hollywood, CA. The expansion to a larger facility coincides with the company's introduction of new products, including its **Aphex Aural Exciter**, Type B sound enhancer, to the professional musician and consumer markets. Aphex is tripling its manufacturing and assembly operations in its new plant and is also doubling its research and production development capability for new sound enhancement products aimed at both the professional and consumer sound markets. The initial product to be manufactured at the new facility will be the popular **Aphex Aural Exciter**, Type B, which is similar to the previously marketed **Aphex II Aural Exciter** unit utilized on thou-

sands of music albums, by recording artists on concert tour, in motion pictures, and in many of the leading broadcast stations in the world.

• **Wayne Hetrich**, **National Public Radio's** senior engineer for Research and Development, is the 1983 recipient of NPR's **Edward E. Elson Award**. Hetrich was honored for his outstanding contributions to public radio's satellite program distribution system. Hetrich, who joined NPR in 1971, is the architect of the network's satellite system. He was responsible for the design of small satellite earth terminals capable of multi-channel high quality, high fidelity sound. NPR president **Frank Mankiewicz** presented the award to Hetrich at the 12th annual Public Radio Conference in Minneapolis, MN. Said **Mankiewicz**, "We are deeply grateful to Wayne Hetrich for creating public radio's satellite delivery system—one that is the envy of every network in the world."

Hetrich's career in the audio, broadcasting, and recording industries spans some 35 years. He has been responsible for the design, construction, and installation of several commercial radio and TV stations in major market areas, including Boston and Washington, D.C. Hetrich also holds several patents in the fields of audio level measurement and network signalling systems. He recently received a special award from the **Major E. H. Armstrong Foundation** for technical achievement in broadcasting and his significant contributions to audio art.

The **Edward E. Elson Award**, established in 1979, is presented annually to the individual who has made an outstanding contribution in the preceding year to the public radio system. Past award recipients include **Edward E. Elson**, former NPR Board chairman; **Karl Schmidt**, creator of the **EARPLAY** drama series; **Dr. Billy Taylor**, pianist/composer and former host of NPR's **JAZZ ALIVE!**; and **Lillie E. Herndon**, former Board chairman of the **Corporation for Public Broadcasting**.

- **Furman Sound, Inc. of Greenbrae, California.** is pleased to announce the appointment of **Jim Murphy** as chief engineer. His previous position was with **H H Electronic**, and prior to that he was a staff engineer for four years at **CBS Musical Instruments**. Murphy's responsibilities will be the direction of all Research and Development efforts at **Furman Sound**, as well as supervising the Quality Control Department.

- **Hauppauge Tape Manufacturing, Ltd. of Hauppauge, New York,** the sister company of **HRM**, has announced that it now has the capability to supply audio cassettes duplicated with the new **Dolby HX Professional** recording technique. According to **Roger Gouldstone**, **HTM** president, the new capability provides superior audio quality and is immediately available to all **HTM** customers. "HX Professional puts us in a leadership position in supplying top quality duplication to our customers," said Mr. Gouldstone. "The investment in HX Professional reflects our continuing commitment to offer the best duplicating services available." HX Professional is a new recording technique for improving the audio quality of cassettes. High frequency response and dynamic range are enhanced while distortion is reduced. Of importance to the consumer, it requires no special playback equipment. The HX Professional system is manufactured under license from **Dolby Licensing Corporation by Electro Sound, Inc. of Sunnyvale, California.**

- **Shure Brothers Inc., Evanston, Illinois,** has announced the appointment of **John F. Phelan** to the position of Professional Products Marketing manager. His responsibilities will include supervising the marketing of all Shure professional audio products. Phelan was previously Western Regional Sales manager for **Sony Corporation of America's Professional Audio Division**. Prior to that, he was general manager of **Filmways Audio Services, Inc., in North Hollywood, California.**

- **GLI/Integrated Sound Systems, Inc.,** designer and distributor of electronic audio systems and speakers for entertainment centers, corporate A-V departments, and clubs throughout the world, has relocated to a new 15,000 square foot facility on **Walt Whitman Road in Melville, New York.** The greatly expanded operation boasts manufacturing, assembly, receiving, shipping and computer rooms, executive suites and sophisticated support capabilities including improved customer service and quality-control departments. One of the world's largest manufacturers of preamplifier/mixers, **GLI** services over 500 international dealer-

ships from Europe and Australia to South America and the Philippines. Included among its successful family of creative controller pream/mixers are **GLI's PMX 7000, PMX 9000** and top-of-the-line 5990. **GLI's new MX-6** six channel mic mixer will be available by the end of 1983.



- **Jim Cassily**, chief executive officer of **EXR Corporation of Brighton, MI,** has reported the merger of his company with **Warren E. Avis Enterprises.** **Avis** is the founder of **Avis Rent-A-Car.** "The merger will enhance the position of the company and also allow us to continue to bring new and exciting products to the marketplace," said Cassily. "We are restructuring our dealer network and realigning our position in the pro audio field. **EXR** is dedicated to this market and this merger will allow us to show what we can do. The company recently introduced two new products: the **EX-IV,** and the **SP-III** foot pedal. The corporate headquarters will remain at 3373 Oak Knoll Dr., **Brighton, MI.** Cassily will remain as chief executive officer and **Melanie Rogers** will assume the position of president of the corporation.

- **Harman International Industries, Incorporated** announced that they have completed acquisition of the **URC** companies. The **URC** Group includes **UREI, Teletronix, and Coast Records** and **United Western,** two well-known West Coast recording studios serving individual entertainers and the motion picture, television and advertising industries. **Sidney Harman, Board Chairman of Harman International,** said that with the acquisition of the **URC** Group, the company's principal development plan has been completed. "With the recent acquisition of **Infinity Systems, Inc.** and the addition of the **URC** Group to our **JBL** and **Harman-Motive** manufacturing companies, we are now positioned to truly execute our commitment to the audio industry."

- **Veteran recording engineer/producer Fred Catero** is pleased to announce the formation of **Catero Records** and the label's first release, *Twelve Gates To The City* (**CAT-001**), by synthesizer great **Don Lewis.** **Catero** is one of the most highly respected

people in the record industry, due to his distinguished background both as a **CBS Records** staff engineer and producer. Among the numerous artists with whom **Catero** has worked are **Bob Dylan, Simon & Garfunkel, Barbra Streisand, Santana** and **Herbie Hancock.**

- **BSR (USA) LTD.** has announced a consolidation of manufacturers representatives handling its **dbx** line of state-of-the-art signal processing equipment. The consolidation follows notice extended to the reps that the **dbx** line would be handled by **BSR/ADC** reps effective April 15. According to **Charles Sweeney,** **BSR (USA)** president, the changeover does not involve any changes in retail distribution of the **dbx** line. "Distribution of **BSR, ADC** and **dbx** will be determined by the needs and unique characteristics of each brand. In the case of **dbx,** we fully recognize the need to pattern our distribution as it is presently constituted. Therefore, we will not be changing the distribution for any of the **dbx** products covered by our dealer agreements. In addition, the **dbx** professional products division will continue to be based in **Newton, Massachusetts** and there have been no changes in the specialized rep force handling professional products."

- **Sound Technology, Incorporated** has appointed **John Williamson** president. **Williamson** joined **Sound Technology, Inc.** two years ago as a vice president and has spent numerous years in management positions prior to joining the company. **Robert Andersen** has been appointed vice president of Engineering and is responsible for **Advanced Products Research.** **Andersen** directs the engineering staff and interfaces with marketing and operations in formulating product development decisions.

- **Larry Klein** has formed a new company to offer a variety of marketing-oriented communications services to companies in the consumer electronics industry. The new company, **Larry Klein Associates,** will offer technical copywriting and editing of product literature and owner manuals, objective and subjective product tests and evaluations, comparisons of product lines, studies and evaluations of distribution patterns, and market research studies. For twenty years, **Larry Klein** was technical director of **Stereo Review,** the world's largest audio magazine. **Stereo Review** has signed on as the first client of **Larry Klein Associates.** In his new company, Mr. Klein will be associated with **Joe Lesly,** a communications specialist and head of an advertising, public relations and research company in the consumer electronics and photographic industries.

At Last, A Live Board That Sounds Alive:

The Soundcraft Series 800B.

You expect flexibility in a live mixing board and you should *demand* sound that's *alive*. Unfortunately, that's where some of the more popular live boards fall apart. And, that's why we designed the Series 800B with headroom to spare... especially at the critical high end. Combine this headroom with Soundcraft's traditionally quiet electronics and you have *live sound that stays alive* through the board.

You will also find the 800B is one of the most versatile boards available, especially for its compact size. Take your choice of 16, 24 or 32 channel input mainframes with Standard or Monitor inputs... both with Soundcraft's famous 4-band EQ. Standard inputs feature eight Aux send busses, assignment to the eight sub-groups and the stereo mix, and long travel faders.

The Standard Output modules feature an Effects Return input

with semi-parametric EQ which may be assigned to the Stereo Master or into the sub-group on the same module.

Matrix Output modules can be used where several different mixes are required for multiple audio feeds.



Standard Output Module



Standard Input Module



Matrix Output Module

To find out more about the Soundcraft Series 800B and the name of your nearest dealer, send the coupon below to Soundcraft, today. Your audience will be glad you did.

Soundcraft

Soundcraft U.S.A.

1517 20th St.
Santa Monica, CA 90404
(213) 453-4591 TLX 664-923

Soundcraft Electronics

5-8 Great Sutton St.
London EC1VOBX England
(01) 251-3631 TLX 21198

Soundcraft U.S.A.
1517 20th St., Santa Monica, CA 90404
(213) 453-4591 TLX 664-923

Please send me more about the live boards that keep the sound alive.

Name

Address

City

State Zip

© Soundcraft U.S.A. 1982

Studer Re-States the Art



With the new A810, Studer makes a quantum leap forward in audio recorder technology. Quite simply, it re-states the art of analog audio recording.

By combining traditional Swiss craftsmanship with the latest microprocessor control systems, Studer has engineered an audio recorder with unprecedented capabilities. All transport functions are totally microprocessor controlled, and all *four* tape speeds (3.75 to 30 ips) are front-panel selectable. The digital readout gives real time indication (+ or - in hrs, min, and sec) at all speeds, including vari-speed. A zero locate and one autolocate position are always at hand.

That's only the beginning. The A810 also provides three "soft keys" which may be user programmed for a variety of operating features. It's your choice. Three more locate positions. Start locate. Pause. Fader start. Tape dump. Remote ready. Time code enable. You can program your A810 for one specialized application, then re-program it later for another use.

There's more. Electronic alignment of audio parameters (bias, level, EQ) is accomplished via digital pad networks. (Trimpots have been eliminated.) After programming alignments into the A810's memory, you simply push a button to re-align when switching tape formulations.

The A810 also introduces a new generation of audio electronics, with your choice of either transformerless or transformer-balanced in/out cards. Both offer advanced phase compensation circuits for unprecedented phase linearity. The new transport control servo system responds quickly, runs cool, and offers four spooling speeds.

Everything so far is standard. As an option, the A810 offers time-coincident SMPTE code on a center track between stereo audio channels. Separate time code heads ensure audio/code crosstalk rejection of better than 90 dB, while an internal digital delay automatically compensates for the time offset at all speeds. Code and audio always come out together, just like on your 4-track. Except you only pay for 1/4" tape.

If you'd like computer control of all these functions, simply order the optional serial interface. It's compatible with RS232, RS422, and RS422-modified busses.

More features, standard and optional, are available. We suggest you contact your Studer representative for details. Granted, we've packed a lot into one small package, but ultimately you'll find that the Studer A810 is the most versatile, most practical, most *useable* audio recorder you can buy.

The Swiss wouldn't have it any other way.



STUDER REVOX
PRECISION FROM SWITZERLAND

Studer Revox America, Inc. • 1425 Elm Hill Pike, Nashville, TN 37210 (615) 254-5651
Offices: Los Angeles (213) 780-4234 • New York (212) 255-4462 • Dallas (214) 760-8647 • Canada: Studer Revox Canada, Ltd.
Circle 11 on Reader Service Card