

SEPTEMBER/OCTOBER 1986

db

THE SOUND ENGINEERING MAGAZINE

serving: recording, broadcast and sound contracting fields

**Featuring 2 to 8 trk—The Smaller Recording Studio
Guides: Microphones; Compressors & Limiters**



Designed to give your studio an unfair advantage.



All top studios need an edge.
Like the revolutionary Saturn multitrack with
"Total Remote" and the TS24 console.

The Saturn is the result of over three years
of design innovation combining the latest in digital
control and analog technology. Programmable
"Total Remote" gives you precise control over all
machine functions, making this the most flexible
multitrack in existence today.

Sonic clarity, ease of operation and renowned
Soundcraft EQ make the TS24 the perfect comple-
ment to the Saturn.

Saturn and TS24. Together they offer your
studio the unfair advantage you've been looking for.
Technology created for music.

Soundcraft

STUDIO SERIES

Soundcraft USA, JBL Professional, 8500 Balboa Boulevard, Northridge, CA 91329 (818) 893 4351

See us at LA AES, booth 427





The broadcast engineer

LISTENING IN ON LIBERTY WEEKEND
Laurence Estrin 38

AUDIO AT THE LIBERTY WEEKEND CLOSING CEREMONIES
Bruce Bartlett 43

The recording engineer

CONTROL ROOM DESIGN INCORPORATING RFZ™, LFD™, AND RPG™ DIFFUSORS
Peter D'Antonio 47

PROFILE: PRODUCER/ENGINEER MICHAEL LLOYD
Drew Daniels 56

2 to 8 the smaller recording studio

RECORDING TECHNIQUES: SIMPLE STEREO MICROPHONE TECHNIQUES
Bruce Bartlett 8

EXPLORING PLANET DALLAS
Dana Lynn Joseph 18

ON TAXES: LEASING WITH AN OPTION TO ACQUIRE
Mark E. Battersby 24

LAB REPORT: CARVIN MX1688 16 X 8 AUDIO MIXER
Len Feldman 29

A NOISE PRIMER FOR THE SMALL STUDIO OWNER
Jon Gaines 34

CONDENSED GUIDE TO SI UNITS AND STANDARDS
Drew Daniels 44

LETTERS 2

EDITORIAL 36

BUYER'S GUIDE: MICROPHONES; COMPRESSORS & LIMITERS 60

NEW PRODUCTS 76

CLASSIFIED 81

PEOPLE, PLACES, & HAPPENINGS 81

Editor/Publisher
 Larry Zide

Associate Publisher
 Elaine Zide

Managing Editor
 Rita Wolcott

Technical Editor
 Sammy Caine

Contributing Editors
 Bruce Bartlett
 Mark E. Battersby
 Brian Battles
 Barry Blesser
 Drew Daniels
 Len Feldman
 Jesse Klapholz

Graphics & Layout
 Karen Cohn

db, the Sound Engineering Magazine (ISSN 0011-7145) is published Bi-monthly by Sagamore Publishing Company, Inc. Entire contents copyright © 1986 by Sagamore Publishing Co., 1120 Old Country Road, Plainview, L.I., N.Y. 11803. Telephone (516) 433 6530 db is published for those individuals and firms in professional audio-recording, broadcast, audio-visual, sound reinforcement, consultants, video recording, film sound, etc. Application should be made on the subscription form in the rear of each issue. Subscriptions are \$15.00 per year (\$28.00 per year outside U.S. Possessions; \$16.00 per year Canada) in U.S. funds. Single copies are \$2.95 each. Editorial, Publishing and Sales Offices: 1120 Old Country Road, Plainview, New York 11803. Controlled circulation postage paid at Plainview, NY 11803 and an additional mailing office.

AKIA Electronics INTRODUCING!

X-Z 100 COMPUTER

ON THE TOP OF DIGITAL
TECHNOLOGY

MIDI EXPANSION FOR MIXER

Your mixer becomes

AUTOMATED MIXER

installs in 30 minutes
syncs to tape at any point with
"TIME POINTERS"

128 noise gates
128 compressors limiters
128 channels

Special Software for LIVE PERFORMANCE

Syncs Perfectly To Any Random Tempo
Changes Of The Performers

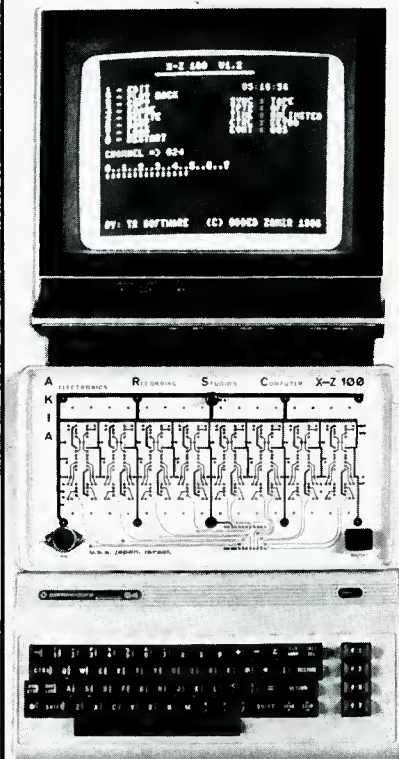

JUMP INTO THE NEW GENERATION

GET YOUR STUDIO AUTOMATED

THE XZ-100 OFFERS:
THE MOST ADVANCED DIGITAL
COMPUTERIZED TECHNOLOGY IN
AUDIO MIXING.

all for basic cost of

\$ 1499.00

for free data write to **AKIA electronics**
16740 S.W. 301 St. Homestead, Fla. 33030
or call (305) 245-2727 or toll free
1-800-225-3675

Letters

Editor's Note: The following is a reprint of one chart and one basic program which appeared in Drew Daniels' article entitled, "Vented Loudspeaker Enclosure Design Made Easy" (pages 40 to 48) from the July/August 1986 issue of db Magazine. As a way to compensate for any inconvenience the misprints may have caused, Mr. Daniels has also asked that we enclose an extra program.

MODEL	fs	Qts	Vas	Eff.	Pmax	Xmax	dia.	Qms	Qes	Re	Le
128H	20	.24	9.9	.86%	100	.31	10.2	7.0	.25	5.7	0.4
2105H	200	.53	.035	1.2%	25	.06	3.5	3.0	.65	6.1	0.6
2108	40	.17	1.2	1.2%	75	.06	6.0	4.5	.18	5.8	0.25
2110	60	.31	1.2	2.1%	25	.10	6.5	3.5	.34	6.0	0.5
2115	55	.48	1.2	1.0%	30	.22	6.0	4.0	.54	5.5	0.3
2118H	85	.35	.5	2.1%	100	.12	6.5	2.4	.40	5.5	0.3
2118J	85	.35	.5	2.1%	100	.12	6.5	2.4	.40	10.3	0.6
2120	65	.36	1.6	3.0%	75	.06	7.9	4.0	.40	6.0	0.85
2121	35	.16	3.9	2.7%	75	.06	7.9	5.5	.17	6.0	0.4
2122H	40	.23	2.3	2.4%	100	.12	8.0	1.9	.26	5.8	0.8
2123H	75	.27	0.9	3.5%	250	.10	7.9	4.0	.29	4.2	0.6
2130	50	.20	4.3	6.9%	100	.06	10.2	4.0	.21	6.3	0.4
2135	40	.25	10.5	6.7%	125	.06	13.2	4.0	.27	6.3	0.6
2145	30	.51	5.5	.76%	50	.14	9.3	12.0	.53	5.0	0.6
2150	55	.64	3.5	2.2%	50	.10	12.2	5.0	.73	5.5	0.4
2202H	50	.16	3.1	6.0%	150	.14	10.2	3.5	.17	5.5	1.0
2203H	16	.14	14.1	1.1%	100	.20	10.2	6.0	.14	6.3	1.1
2204H	45	.35	3.1	1.8%	350	.27	10.3	1.7	.44	6.2	1.4
2205H	30	.21	10.5	3.5%	150	.10	13.3	5.0	.22	5.5	0.7
2213H	25	.49	8.3	.68%	75	.31	9.8	8.5	.52	4.4	1.3
2214H	23	.24	7.9	1.1%	200	.26	10.2	10.5	.25	5.6	0.6
2215H	20	.21	26.0	2.6%	100	.16	13.3	5.5	.22	5.7	1.3
2220H	37	.17	10.5	8.7%	200	.12	13.3	5.0	.18	5.7	1.0
2220J	37	.17	10.5	8.7%	200	.12	13.3	5.0	.18	13.2	1.0
2225H	40	.28	6.0	3.5%	200	.20	13.3	2.5	.31	6.3	2.0
2225J	40	.28	6.0	3.5%	200	.20	13.3	2.5	.31	12.9	1.1
2231H	16	.21	26.0	1.4%	100	.20	13.2	5.5	.22	6.3	2.2
2234H	23	.22	16.2	2.1%	150	.33	13.3	2.0	.25	6.0	1.4
2235H	20	.25	16.2	1.3%	150	.33	13.3	2.5	.28	6.0	1.2
2240G	30	.25	17	5.0%	300	.22	16.0	2.5	.25	2.5	1.2
2240H	30	.23	17	5.0%	300	.22	16.0	2.2	.25	6.0	0.7
2245H	20	.27	29	2.1%	300	.38	16.0	2.2	.27	5.8	1.4
E110	65	.36	1.6	3.0%	75	.10	7.9	4.0	.40	6.0	1.4
E120	60	.17	2.8	8.6%	150	.12	10.2	1.8	.19	6.3	0.4
E130	40	.19	10.5	8.6%	150	.10	13.3	1.8	.21	6.3	0.4
E140	32	.17	10.5	4.9%	200	.14	13.3	5.0	.19	5.5	0.4
E145	35	.25	9.7	4.3%	150	.28	13.3	6.0	.26	5.7	1.1
E155-4	30	.20	15	4.9%	300	.20	15.0	2.2	.22	2.5	1.6
E155-8	30	.20	15	4.9%	300	.20	15.0	2.2	.22	6.0	0.7
G125-8	65	.32	2.5	5.5%	200	.10	10.2	5.5	.34	5.2	1.4
G135-8	45	.36	8.3	5.5%	200	.10	13.3	5.5	.38	5.2	0.5
K110	65	.36	1.6	3.0%	75	.12	7.9	4.0	.40	6.0	0.5
K120	50	.20	4.3	6.9%	100	.12	10.2	4.0	.21	6.3	0.4
K130	40	.25	10.5	6.7%	125	.12	13.3	4.0	.27	6.3	0.6
K140	30	.21	10.5	3.5%	150	.20	13.3	5.0	.22	5.5	0.6
K145	35	.29	8.6	3.4%	150	.20	12.5	6.0	.30	8.8	1.3
K151	30	.27	12.9	3.4%	150	.20	14.5	6.0	.28	6.0	2.2
LE8TH	45	.56	1.2	0.5%	25	.22	6.0	4.0	.65	5.5	2.0
LE10H	33	.37	2.7	0.7%	75	.24	7.9	6.9	.39	4.8	0.3
LE14H	26	.27	5.2	.89%	150	.33	11.4	2.3	.30	5.9	0.6
LE15A	20	.21	26.0	2.6%	100	.16	13.3	5.5	.22	8.8	1.3
MI-10	75	.33	1.3	3.5%	150	.12	8.2	1.8	.41	5.6	2.2
MI-12	65	.46	2.7	3.5%	150	.12	10.4	2.2	.58	5.6	0.6
MI-15	55	.62	6.0	3.5%	150	.12	13.3	2.8	.79	5.6	0.6
MI-15A	40	.42	9.6	3.5%	150	.14	13.3	4.0	.47	5.6	0.9

WHAT TO LOOK FOR WHEN YOU LISTEN TO A POWER AMPLIFIER.

When it comes to evaluating amplified sound, seeing is believing.

In fact, when engineers judge the sound quality of an amplifier, they often rely on *two* precision instruments: the human ear, and the industry-standard Transient Intermodulation Distortion Test, because when measuring sound with T.I.M. what you see is what you get.

And what you see can be eye-opening. Amplifiers that seem to square off evenly spec. for spec., often perform very differently under the scrutiny of T.I.M. Pushed to their limits, many produce brittle, edgy or distorted sound especially during high frequency passages and sharp transients.

Many manufacturers deal with distortion by using massive amounts of feedback through a single overall feedback loop, placing greater demands on the amplifier and producing an inferior sound.

When we built our new JBL/UREI Amplifiers, we committed ourselves to designing the industry's purest-

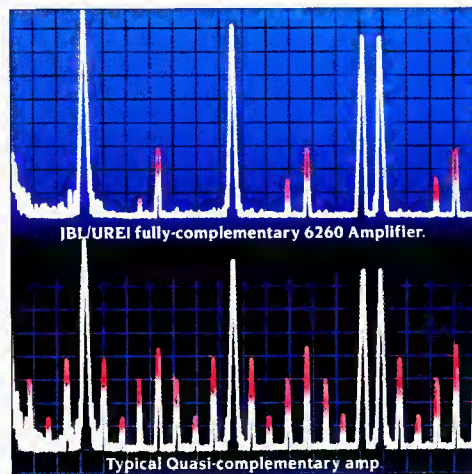

Red spikes in the TIM Spectrum reveal the dramatic differences in distortion output.

sounding amps that would not only score highest marks on the T.I.M. Test, but deliver the truest amplified sound ever heard.

Instead of sloppily force-feeding massive amounts of

output signal back into input stages, and congesting it all into one circuit loop, we've established operating points at *each* gain stage. This allows signal purity to be maintained along the entire circuit. And permits optimized use of the type and amount of feedback for each individual gain stage.

In a simple analogy, the new JBL/UREI Amplifiers do each signal track right the first time, so that you don't have to fix it in the mix. The result is sound far cleaner than typical quasi-complementary and fully-complementary output stages only. And far more pleasing to the ear.

Put JBL/UREI's remarkable new Amplifiers to the test at your local JBL/UREI dealer today. We're confident you'll think it's the finest amplified sound you've ever heard. Or seen.

For an informative Technical Paper on the unique design philosophy behind the new JBL/UREI Amplifiers, please write to:



Circle 13 on Reader Service Card

See us at LA AES, booth 326

JBL Professional
8500 Balboa Boulevard
Northridge, CA 91329



UREI
ELECTRONIC
PRODUCTS

Available through Global Marketing

1 'Loudspeaker Enclosure Venting Nomograph

Program by Drew Daniels

```
2 PI = 3.141592654# : PRINT
3 INPUT "Enclosure volume in cubic feet ";VB
4 INPUT "Enclosure tuning frequency in hertz "; FB :
GOTO 5
5 INPUT "Port area in square inches (press return to skip to
diameter)";AREA
6 IF AREA >0 THEN 9 ELSE 7
7 INPUT "Port diameter in inches ";DIAMETER
8 AREA = (DIAMETER/2)^2*PI
9 LVSV = 1728*VB*(2*PI*FB/13504)^2
10 LENGTH = AREA/LVSV - .825*SQR (AREA)
11 IF LENGTH <.75 THEN GOTO 5
12 AREA = ((LVSV*.825 + SQR((LVSV*.825)^2 + 4*LVSV
*LENGTH))/2)^2
13 DIAMETER = SQR (AREA/PI)*2
14 LENGTH = INT(LENGTH*10^2+.5)/10^2 : PRINT
15 VOLUME = (AREA*LENGTH)/1728
16 PRINT "BOX VOLUME   BOX TUNING   VENT
AREA   VENT DIAMETER   BOX TUNING   VENT
VOLUME"
17 PRINT USING "###.# cu ft   ### Hz   ###.# sq
in   ###.# in   ###.# in   ###.# cu ft";VB;FB,
AREA;DIAMETER;LENGTH;VOLUME
18 PRINT : GOTO 3
19 END
```

0 'TS.BAS PROGRAM—KEELE'S FLOW CHART by Drew Daniels

```
1 CLS : COLOR 15 : KEY OFF ' IBM functions
2 PRINT : INPUT "DRIVER Fs ";FS
3 PRINT : INPUT "DRIVER Qts ";QTS
4 PRINT : INPUT "DRIVER Vas ";VAS
5 VB = (QTS^2.87)*15*VAS
6 F3 = (QTS^-1.4)*.26*FS
7 FB = (QTS^-9)*.42*FS
8 PRINT : PRINT USING "BOX VOLUME = ###.## Ft^3,
F3 = ###.# Hz, Fb = ###.# Hz";VB,F3,FB
9 PRINT : INPUT "Is the box size acceptable ";A$ : PRINT
10 IF A$ = "Y" OR A$ = "y" THEN 2
11 IF A$ = "N" OR A$ = "n" THEN 12
12 INPUT "What box volume would you prefer "; VBX :
PRINT
13 F3X = SQR(VAS/VBX)*FS
14 FBX = ((VAS/VBX)^.32)*FS
15 PRINT USING "For a ###.# ft^3 box, F3 = ###.# Hz,
FB = ###.# Hz";VBX,F3X,FBX
16 L1 = LOG(10) : DDB = 20*LOG(((VAS/VBX) ^.35)*
QTS*2.6)/L1 : PRINT
17 IF DDB>0 THEN B$ = "+"
18 PRINT USING "The flattest alignment will have !##.#
dB of low frequency response ripple";B$,DDB
19 PRINT "with this box volume" : PRINT : GOTO 9
20 END
```

GLM™



Advancing technologies can move at such a rate a new product may blur by without offering the true explanation of why it was developed in the first place.

Quite simply the new GLM is a superior studio quality microphone that incorporates all the benefits of its larger more conventional predecessors.

Crown technology has always ignored the conventions of new product development and recognized no limits in achieving the ultimate in professional quality.

See your nearest Crown dealer. Find out how this incredibly small microphone achieves such a high level of performance.

Crown International, Inc., (219) 294-8000
1718 W. Mishawaka Rd., Elkhart, IN 46517

 **CROWN®**



Yamaha introduces microphones for every instrument we make. And the one we don't make.

Designed to reproduce both vocal and instrumental music, the MZ Series of professional microphones were a long time in the making.

For nearly 100 years, Yamaha has been building musical instruments. Everything from piccolos to grand pianos to synthesizers.

We took this musical heritage and combined it with our expertise in electronics and acoustic engineering. The result is a line of five microphones that, unlike others, go beyond mere transducers.

The diaphragms in the three MZbe models are the first to use beryllium. This rare metal's low specific gravity and exceptional rigidity permit an extended high frequency range for a sound that is both crisp and sweet at the same time.

A specially developed damping and three-point suspension system for long-term stability and durability is used throughout the line. As are gold-plated connectors.

But because of Yamaha's musical experience, the real accomplishment of our new microphones is certainly greater than the sum of the parts. You might even think of them as musical instruments in themselves.

For complete information, write Yamaha International Corporation, Professional Audio Division, P.O. Box 6600, Buena Park, CA 90622. In Canada, Yamaha Canada Music Ltd., 135 Milner Ave., Scarborough, Ont., M1S 3R1.



Circle 15 on Reader Service Card

See us at LA AES, booth 114

OPEN LETTER TO MEMBERS OF SPARS

The following was recently received from the offices of SPARS:

TO THE EDITOR:

Last month I was invited to a SPARS Board of Directors meeting, and went because they were considering me as a prospective board member. I was, at once, greatly flattered and very wary though I saw it as a chance to gain a bit of national prestige for my studio. I also saw it as a colossal and expensive pain.

My Doppler Studios has been a SPARS member since the beginning. We have a number of 24-track rooms, SSL console and God knows how many of the latest "gizmos," so we're far from "babes in the woods," but we're not Glen Glenn either. So I went to the SPARS Board just to see what was what. I was quite sure who the Board members of SPARS were. The list was in my drawer somewhere: Universal, The Record Plant, Sigma Sound, Criteria, Lucas Films, etc.

Now I know differently. After all my preconceived notions and all the unread newsletters, I had been dead wrong. I could not have been further

off the mark of the real SPARS. Last month, I found out that these SPARS guys are real, charming, approachable people. They represent a diverse cross section of the industry, and I think they are doing substantial well-directed work which can affect every legitimate studio.

I had no idea of the monumental efforts or the costs involved in developing the SPARS National Studio Exam. I was ignorant to the unbelievable complexity of even considering the accreditation program, much less pulling it off. It had occurred to me that I was the only one who had faced the Sales Tax problem, and who had spent tidy sums on lawyers and accounting advice. Interfaces with manufacturers of equipment had been limited to sales and service, without a dream of affecting design. I knew that something should be done about conventions and formats for master tape prepared for CDs.

All of these items, and scores more, were addressed by the board. For the price of a plane ticket to Chicago, I found out in one day, and in the broadest of terms, what is right with SPARS and what is wrong with SPARS.

What is right with SPARS is that everyone on the board of directors seems to be dedicated and knowledgeable, and everyone seems to possess an unselfish desire to establish and to realize lofty industry-wide goals.

What is wrong with SPARS, as far as I can tell, is that no one else knows this. This is really not the SPARS Board's fault. All the PR in the world won't produce an active, aware membership. SPARS functions better than you know without overwhelming member support. Imagine what it could do with this support.

There are a lot of ways to begin. Attend the Business Conference. I hear it is great. Encourage applicants to take the exam. Supply feedback and opinions to Gary Helmers (SPARS Director in Beverly Hills, CA.) I promise you he wants to hear from you. The most important thing is to get to know the membership. They have the same problems you have: maintenance, finance, sales, hiring and firing.

I don't want you to think that I've had a Damascus Road experience. I haven't. Nor do I want to appear to be evangelical. I'm not. I just see an opportunity here, and I'm not one to pass up opportunities. I assume you aren't either.

WILBER CALDWELL
DOPPLER STUDIOS, INC.
ATLANTA, GA

We at db Magazine fully endorse this letter. For further information on SPARS write directly to: Gary Helmers, SPARS, P.O. Box 11333, Beverly Hills, CA 90203, or pick up the phone and call Gary at (818) 999-0566.

THE VERY HEART OF YOUR TAPE MACHINE
Can you trust it to just anyone?

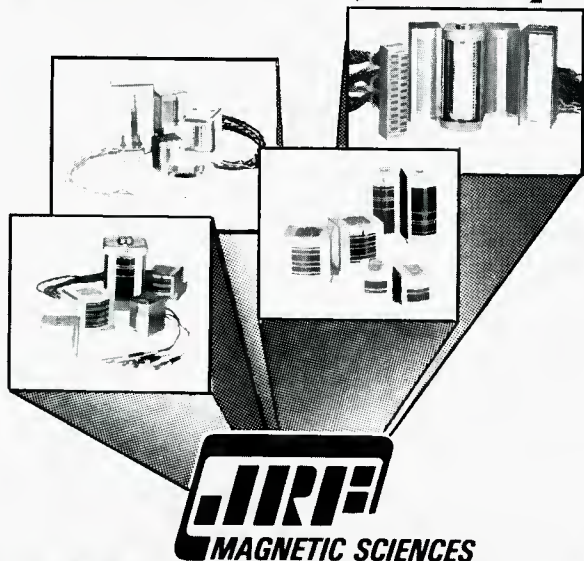

JIRI
MAGNETIC SCIENCES

The audio magnetic professionals with the track record to prove it.

Complete lab facilities • Over 20-years of in-depth experience

Specializing in restoring worn, unserviceable magnetic heads for a fraction of the replacement cost.



101 Landing Road • Landing, NJ 07850 • 201/398-7426 • Telex: 325-449

Small Business

The IRS conducts workshops to help small business owners understand their tax rights and responsibilities. Contact the IRS for information.



A PUBLIC SERVICE MESSAGE FROM THE INTERNAL REVENUE SERVICE

Everyone Says They're Better — We Prove It!



- Time Delay
- Reverberation
- Crossovers
- Tape Noise Reduction
- Compressor / Limiters
- Expanders
- Spectrum Analyzers
- Parametric EQ

Before you purchase another piece of signal processing gear for Studio or Performance use, you would be Wise to listen to our Demo Album. Instead of merely "Saying" we're Better, we Prove it in side by side comparisons with the competition. You really can pay Less and get a Better product through our factory direct sales!

We're out to set new standards for Quality and Performance as well as dollar value. We want you to choose us for our Quality more than our Prices. Our 15 day Satisfaction Guarantee and Two Year Warranty on our Crossovers, Time Delays, Reverberation, Compressor/Limiters, Expanders, Parametric EQ, and Tape Noise Reduction, allow you to purchase with Confidence.

The Demo Album is both fun and Educational. Examples are drawn from the master tapes of Top 40 Hits and show some of the most sophisticated effects ever devised. You will hear our phenomenal MICROPLATE® Reverb with over 18 KHz bandwidth in side by side comparisons with the \$7,000 EMT® Plate on percussion and vocals. No other spring reverb would dare attempt such a comparison! The cost is incredible too, under \$600 mono and \$1,200 in stereo!

Write or call for a free 24 page Brochure and Demo Album.

LT Sound, Dept. D-2 , P.O. Box 338, Stone Mountain, GA 30086
TOLL FREE: 1-800-241-3005 - Ext. 1 In Georgia: (404) 493-1258

LT Sound

We Make A Better Product

Recording Techniques

Simple Stereo Microphone Techniques

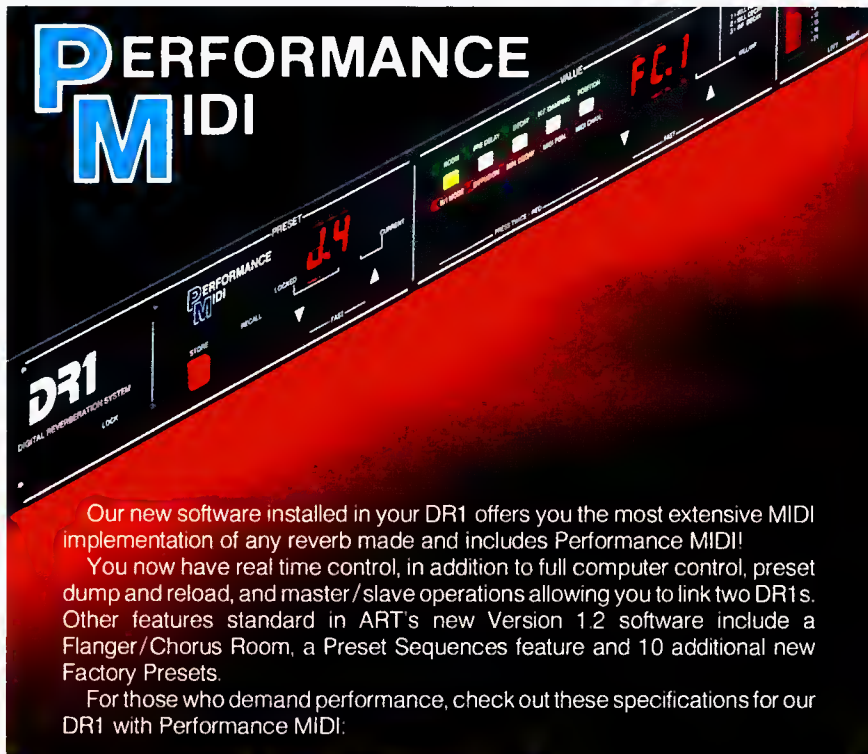

Our new software installed in your DR1 offers you the most extensive MIDI implementation of any reverb made and includes Performance MIDI!

You now have real time control, in addition to full computer control, preset dump and reload, and master/slave operations allowing you to link two DR1s. Other features standard in ART's new Version 1.2 software include a Flanger/Chorus Room, a Preset Sequences feature and 10 additional new Factory Presets.

For those who demand performance, check out these specifications for our DR1 with Performance MIDI:

PRESETS: 40 FACTORY, 100 USER PROGRAMMABLE!

D/A BANDWIDTH: 16 BIT LINEAR - 14KHz RESPONSE!

UPDATEABLE: YES! AND, WE DELIVER, VERSION 1.2 NOW AVAILABLE!

REMOTE CONTROL: YES! FULL CONTROL OF ALL REVERB AND PERFORMANCE MIDI FUNCTIONS!

MIDI: YES! THE MOST MIDI CONTROLLED REVERB AVAILABLE!

SPECIAL EFFECTS: YES! UPDATEABLE AND EXPANDABLE!

DECAY TIME: 0.1 TO 25 SECONDS AND DYNAMIC DECAY TIME CAPABILITIES!

PREDELAY: 0.0 TO 200ms. IN 1.0ms. INCREMENTS!

OTHER CONTROLS: H.F. DAMPING, POSITION AND DIFFUSION!

Simply, if you want the best sounding reverb with the fullest MIDI implementation available including the best sounding PLATES, ROOMS AND HALLS, contact us. We'll continue to impress you with unique products that deliver superior performance!

Call or write today, for more information!

- Digital Reverberation Systems
- Digital Delay Systems
- Full Line of Equalizers
- Pitch Transposer Packages
- Software Update Packages



Applied Research & Technology Inc.
215 Tremont Street
Rochester, New York 14608
(716) 436-2720

PRO-AUDIO NEVER
SOUNDED SO GOOD!

Circle 20 on Reader Service Card

See us at LA AES, booth 746

• At the seventy-ninth convention of the Audio Engineering Society in New York City, a workshop was conducted on simple stereo microphone techniques. The panelists were:

Jerry Bruck, recording engineer and workshop chairman; Marc Aubort, grammy-winning recording engineer/producer for Vox Turnabout, None-such, Vanguard, and Elite Records; Jack Renner, recording engineer for Telarc Records; Stanley Lipshitz, author of numerous AES papers and applied mathematician at the University of Waterloo, Ontario; David Hancock, independent recording engineer; David Griesenger, recording engineer, musician, physicist, and consulting engineer for Lexicon.

The panelists' comments are paraphrased for this article; there are no direct quotations.

PRIMER ON STEREO MIC TECHNIQUES (Jerry Bruck)

The three systems in common use are (1) spaced microphones (A-B), (2) coincident microphones (X-Y or MS), and (3) near-coincident microphones.

With the spaced-microphone method, two or three omnidirectional mics are spaced several feet apart in front of the musical ensemble. Often a center mic is added, (split equally to left and right channels), to stabilize the stereo imaging and fill the "hole in the middle."

The spacing between mics creates time differences between channels, because sound reaches one mic sooner than the other. These time differences vary according to the instrument location. The ear translates these time differences into corresponding image locations between loudspeakers.

With two spaced mics, the images tend to cluster at the speakers. This does not occur with coincident mic'ing.



COMPLETE 16-TRACK AUDIO POST SYSTEMS FROM \$14,600.

Here's your very best buy in the latest high-tech audio sweetening hardware, complete from input to output. It's tailor-made for film and video post production, a completely integrated system. No other manufacturer can offer you all this, all ready for on-line operation.

We even offer automated audio assembly exiting as an option. It's called F.A.M.E., for Fostex Automated Media Editing, and it lets you program edit decision lists so that all your dialog, effects, music and cues are synchronized right on the money.

Your investment in Fostex gear pays for itself. Just take a look at what you spent last year for outside audio post work, and see how much sense a Fostex system like this makes:

- **Model E-16**, 16-track recorder with integral noise reduction. No need to leave a guard band for the SMPTE stripe. **\$7000.**
- **Model E-2**, 2-track recorder with center channel SMPTE track. Full compatibility with standard half-track tapes. **\$3600.**
- **Model 4030** Synchronizer with Model 4035 Remote Controller. Allows you to control up to one master recorder and up to three slaves with chase and pre-roll; also resolves to film. **\$2000.**
- **Model 450-16** Recording Console. 16 x 4 x 2 with phantom powering, parametric EQ, solo and in-line monitoring. **\$2000.**
- Fostex also makes a complete line of microphones (including a unique M/S Stereo Mic), monitors

(point-source, phase coherent), the hot tip in headphones (Model T-20), signal processors — even the interconnecting cables and all the other Necessarys™ you need to remain on-line.

So check with your Fostex dealer today and join the fast-growing list of professionals who are producing popular records, videos, TV show themes and movie soundtracks on Fostex equipment.

Also check out our Autolocator and SMPTE generator/reader. Model 4050 lets you lock MIDI to SMPTE for even greater automation and flexibility. Trust Fostex for all of your on-line audio needs.

Fostex®

ON-LINE AUDIO
FOR OFF-LINE VIDEO

15431 Blackburn Ave., Norwalk, CA 90650 (213) 921-1112

Special cables and interface units may be required, depending on other hardware. Not all products are available at all dealers. Prices and specifications are subject to change without notice.

Circle 18 on Reader Service Card

See us at LA AES, booth 500

YOU CONFIGURE IT OUT FOR YOURSELF!

You really can! Wireworks Mix & Match Components Group gives you all the products you'll ever need to create your own perfect audio cabling system. And our Audio Cabling Design Kit shows you exactly how to put them all together.

**Call or write today for your free Design Kit.
With Wireworks you really conduit!**

wireworks

Wireworks Corporation 380 Hillside Avenue, Hillside, NJ 07205
201/686-7400 800/624-0061

Circle 19 on Reader Service Card
See us at LA AES, booth 538

Nobody gives you more sound for less than Sam Ash.

You'll find everything you need to make music at Sam Ash at consistently low prices. It's a fact that Sam Ash has been filling America's playing and recording needs for more than 60 years. So whatever your needs may be, you'll find that the helpful and expert people at Sam Ash will bring music to your ears.

YOUR SOURCE FOR MUSIC AND SOUND

**Call Toll Free: 1-800-4-SAM-ASH
OR 1-718-347-7757**

Sam Ash[®]

124 FULTON AVENUE HEMPSTEAD, N.Y. 11550

MUSIC STORES

Circle 21 on Reader Service Card

See us at LA AES, booth 1408

The spaced method provides poor image focusing—instrument locations are not clearly defined. But there is a pleasing sense of spaciousness, created artificially by the random phase relationships between channels.

Spaced techniques permit the use of omnidirectional condenser microphones, which have flatter low-frequency response than cardioids. Still, cardioids can be equalized at the console for flat low-frequency response.

The X-Y or coincident method employs two directional microphones mounted with one mic diaphragm directly over the other, and with the mics angled apart. The angling required depends on the polar pattern. Figure-eight patterns should be angled ninety degrees apart, cardioids 131 degrees, and hypercardioids 105 degrees.

Angled directional microphones produce level or intensity differences between channels. The intensity differences vary according to the instrument location. The ear translates these differences into corresponding image locations between speakers.

Because the two mics occupy approximately the same point in space, their signals are in-phase at all frequencies. This feature makes coincident mic'ing mono-compatible—the frequency response is the same in mono and stereo. Mono compatibility is important because about half of all radio listeners are listening in mono.

Although coincident mic'ing provides sharp imaging, it tends to sound "dry" or "flat," lacking spaciousness.

To improve this situation, near-coincident microphones are spaced a few inches apart horizontally to add "air" or "phasiness." The most common arrangement is the O.R.T.F. system using two cardioids angled 110 degrees apart and spaced seven inches apart horizontally.

M-S or Mid-Side stereo mic'ing uses two coincident microphones: a front-aiming directional or omnidirectional microphone and a side-aiming bidirectional microphone. Their outputs are summed and differenced to provide left and right channels.

Unlike the X-Y technique, the M-S technique lets you adjust the stereo spread after recording by adjusting the mid-to-side ratio. M-S is a popular technique for film, radio, and video productions.

M-S offers the potential of better sound than X-Y because most sound sources are on-axis to the mid microphone, but are off-axis to X-Y microphones.

STEREO LOCALIZATION (Stanley Lipshitz)

Imaging beyond the speakers is caused only by out-of-phase information between channels. Such information cannot be localized. The effect is envelopment—ambience surrounding the listener.

With coincident mic'ing, the direct sound from the musical instruments is coherent, but the hall reverberation produces random phase information between channels.

A coincident pair produces loudspeaker signals that are in phase. Not so at the ears. Intensity differences fed to loudspeakers produce pure time differences at the listener's ears below 700 Hz.

Suppose you feed time differences to loudspeakers (from spaced-microphone recordings). In some frequency ranges, the two channels are anti-phase and so do not localize. The airiness of spaced-microphone recordings is due to this phasiness. It's synthetic ambience, not natural ambience.

Imaging is so poor with spaced-pair methods that you can reverse the polarity of one channel and hear little difference in image sharpness.

Ideally, we want pin-point imaging for the direct sound, and spaciousness or envelopment for the hall reverberation.

The spaciousness of coincident recordings can be improved by increasing the L-R separation at low frequencies. Or you can decrease the high-frequency separation.

GOALS OF STEREO RECORDING

Stanley Lipshitz: With two-channel stereo, you get the impression of another acoustic space behind the speakers, as if you're listening into another room. You are not in the other room. You don't feel that "you are there."

But for classical music, we want a "you are there" perspective. We don't want to hear the speakers as sound sources. We want images between and beyond the speakers.

Real sound sources are singular. But with stereo, each ear hears two sources (two loudspeakers). The problem is, how can we localize an image laterally and in depth, given two spaced sound sources to create that image? Specifically, what signals must we feed the loudspeakers, knowing that each ear hears both loudspeakers to create the stereo images? What microphone technique will produce suitable signals to enable us to create the illusion?

Some say that the left ear should hear only the left loudspeaker, and the right ear only the right loudspeaker. This philosophy is evidenced in the Polk Dimensional Array loudspeakers and the Carver Sonic Hologram. That is not stereo, that is binaural.

Two-channel stereo is a limited medium because it does not surround the listener with ambience, as in real life. Still, two-channel stereo can provide precision lateral localization and depth. Depth is determined by each instrument's direct/reverb ratio in the recording.

Jack Renner: The engineer's job is to accurately re-create the musical experience as it took place in the concert hall. It should be a "you are there" experience.

My method (three spaced omnis) is weak in pinpoint imaging, but it does recreate the feel of what happened in the concert hall. Listening to a live concert, you cannot close your eyes and without fail pinpoint every instrument or section of instruments.

I like the spaciousness that spaced omnis deliver. It matters little if this spaciousness is an accurate represen-

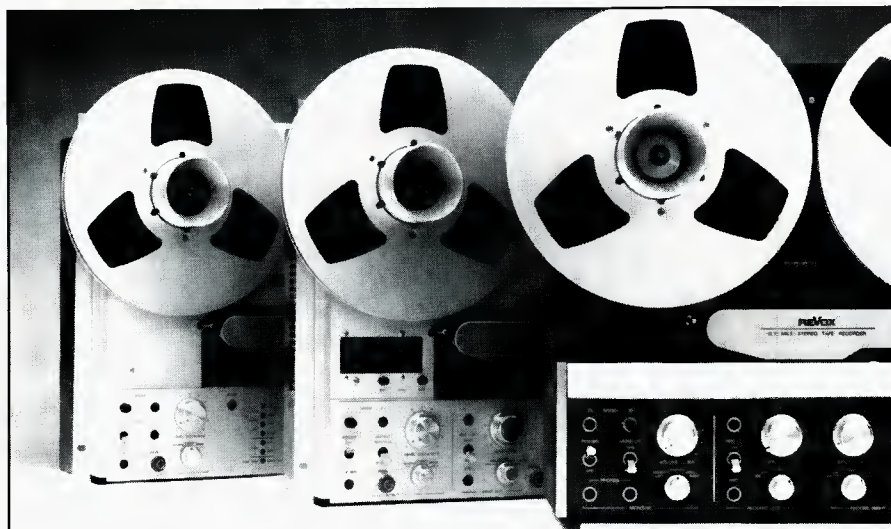

38 Revox Industrial and A/V Audio Recorders

Thirty-eight? Where are the
other thirty-five?

No need to show them. They all look pretty much the same as the three basic transports shown: PR99 MKII, PR99 Playback Only, and B77 MKII. But, with all our special versions, modifications, and options, you can order a Revox to fill virtually any application. The "menu" includes:

- Auto-reverse 4-track playback for background music
- Auto repeat for loop play
- Alternate recorder control for logging
- Voice activated start
- Any two adjacent speeds from 15 1/16 to 15 ips

Other choices include balanced or unbalanced in/out, rack mount or cabinet, consoles, transport cases, monitor panels, vari-speed—the list goes on! PR99 MKII models also feature real time counter, autolocate, zero locate, and loop functions. And all three transports offer a die-cast chassis, full logic controls, servo capstan motor, and solid Swiss-German engineering.

If you need audio recording of any kind, give us a call. If we don't have what you need, we'll get cracking on #39.

STUDER REVOX

Studer Revox America

1425 Elm Hill Pike, Nashville, TN 37210 (615) 254-5651

Circle 17 on Reader Service Card

See us at LA AES, booth 312

tation of hall acoustics, or a synthetic effect, as long as it sounds satisfying to a large number of people.

Jerry Bruck: Recordings lack visual information. We may want to replace the lack of visual information with sharper localization than is heard in the concert hall.

David Griesenger: I like to hear ambience spreading outside the loudspeakers. I like the sense of envelopment, of non-localized sound coming from all around.

Marc Aubort: Stereo to me is not so much left and right. More important than pinpoint imaging is the sense of ambience, perspective, and depth.

PREFERRED TECHNIQUES

Stanley Lipshitz: I use microphones with flat frequency response on and off-axis. A polar pattern that is uniform with frequency is necessary for coincident mic'ing. I use the Schoeps Collette MK-8 Bidirectional and the MK-41 Hypercardioid. The Calrec Soundfield microphone has very well-controlled polar patterns.

Bidirectional microphones (figure-eights) at ninety degrees provide the most accurate imaging and the most uniform spread of reverberation between and beyond the loudspeakers. Angling them eighty-five degrees apart seems to sharpen the center image.

Jack Renner: I typically use three spaced omnis. The center microphone cures "hole in the middle" and reduces vertical modulation of the record groove. I take a 'scope to check for phase.

I like single-diaphragm omnis because of their extended low-frequency response, lower noise, and greater headroom.

I've played in symphonic groups so I know what instruments sound like. The Schoepes MK-2 tells me that what I'm hearing musically is right. After getting used to a monitor system, I listen to rehearsals in the hall. These mics give an accurate representation of that live performance.

I like Monster microphone cable. It seems to provide a slightly clearer sound, a more balanced frequency

937 Best Sellers

The U.S. Government Printing Office has put together a new catalog of the Government's bestselling books. Books like *The Space Shuttle at Work*, *Cutting Energy Costs*, *Infant Care*, *National Park Guide and Map*, *Federal Benefits for Veterans and Dependents*, *The Back-Yard Mechanic*, *Merchandising Your Job Talents*, and *Starting a Business*. Find out what Government books are all about. Send for your free catalog.

New Catalog
Superintendent of Documents
Washington, D.C. 20402

MX1688 Recording Mixer

16 x 8 x 2 with control room mixing

The Carvin MX1688 recording console offers the professional quality features and signal performance you've grown to expect from Carvin! Use of the finest components and professional audio design enable the MX1688 to interface with any professional tape deck. For additional info on this console and Carvin's complete product line send \$1 to Carvin, Dept. MR62, 1155 Industrial Ave., Escondido, CA 92025. A similar 16 x 4 x 2 MX1644 mixer is available for \$1995.

Recording Features

- Eight Track Studio Control Center
- Input/Output Channel Organization
- Independent 8 Into 2 Monitor Mixer
- Four Auxiliary Busses w/ Pre/Post
- Three Band Parametric EQ w/ Defeat Switch
- Mute and Solo on all Input and Output Channels
- Two Effects Returns w/ Pan and Solo
- Talkback w/ Built-in Mic and Monitor Dimming
- Peak Warning Indicators w/ Peak Stretching
- Patch Points on all Channels
- Microphone Phantom Power
- Cue and Effects Sends from Output Channels
- Alternate Metering of Cue and Two-Track
- Quick Tape Playback Through Monitors
- Independent Mic and Line Preamps
- Studio Feed w/ Source Selection
- Totally Modular Internal Construction
- Input Noise of -127 dBv, THD less than .05%
- 20 dB headroom at All Stages

P.A. Features

- Eight Sub-Groups w/ Solo and Mute
- Channels Assignable to L & R Stereo Output
- Four Independent Monitor Mixes Available
- Headphone Monitoring of Main or Monitor
- 11 Step Gain Controls for Easy Set-up
- Talkback to Monitors

MX1688

\$2995 + 49 Frt.

Product Information
Toll Free 800-854-2235
Calif 800-542-6070

CARVIN CATALOG
 \$1 for Bulk Mail \$2 for Rush 1st Class Mail
Name _____ Street _____ City _____ State _____ Zip _____ MR

A View of

2

to

8

trk

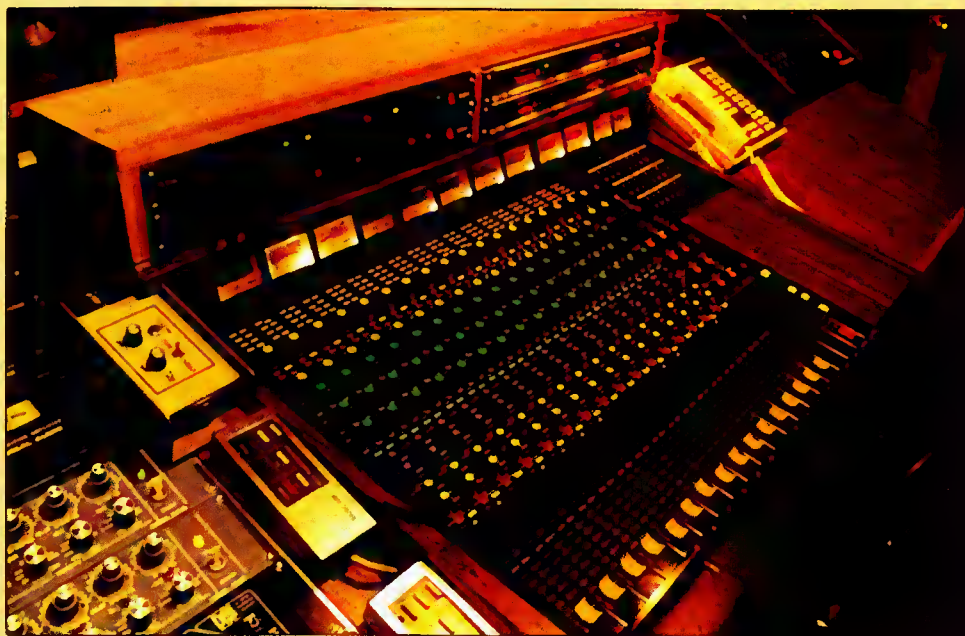

Planet Dallas

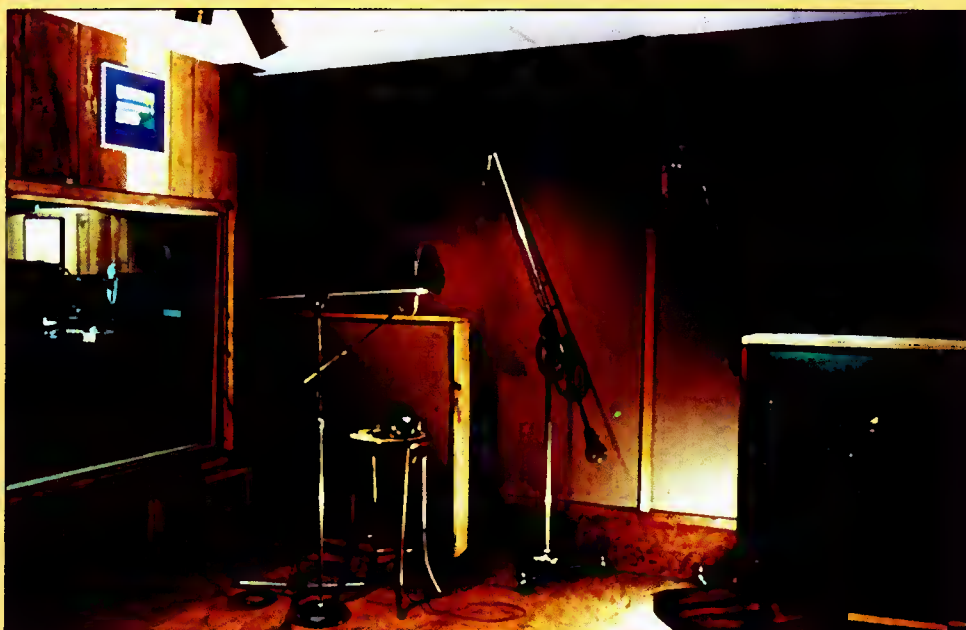

A few words on microphone accuracy

from the people who
specialize in it

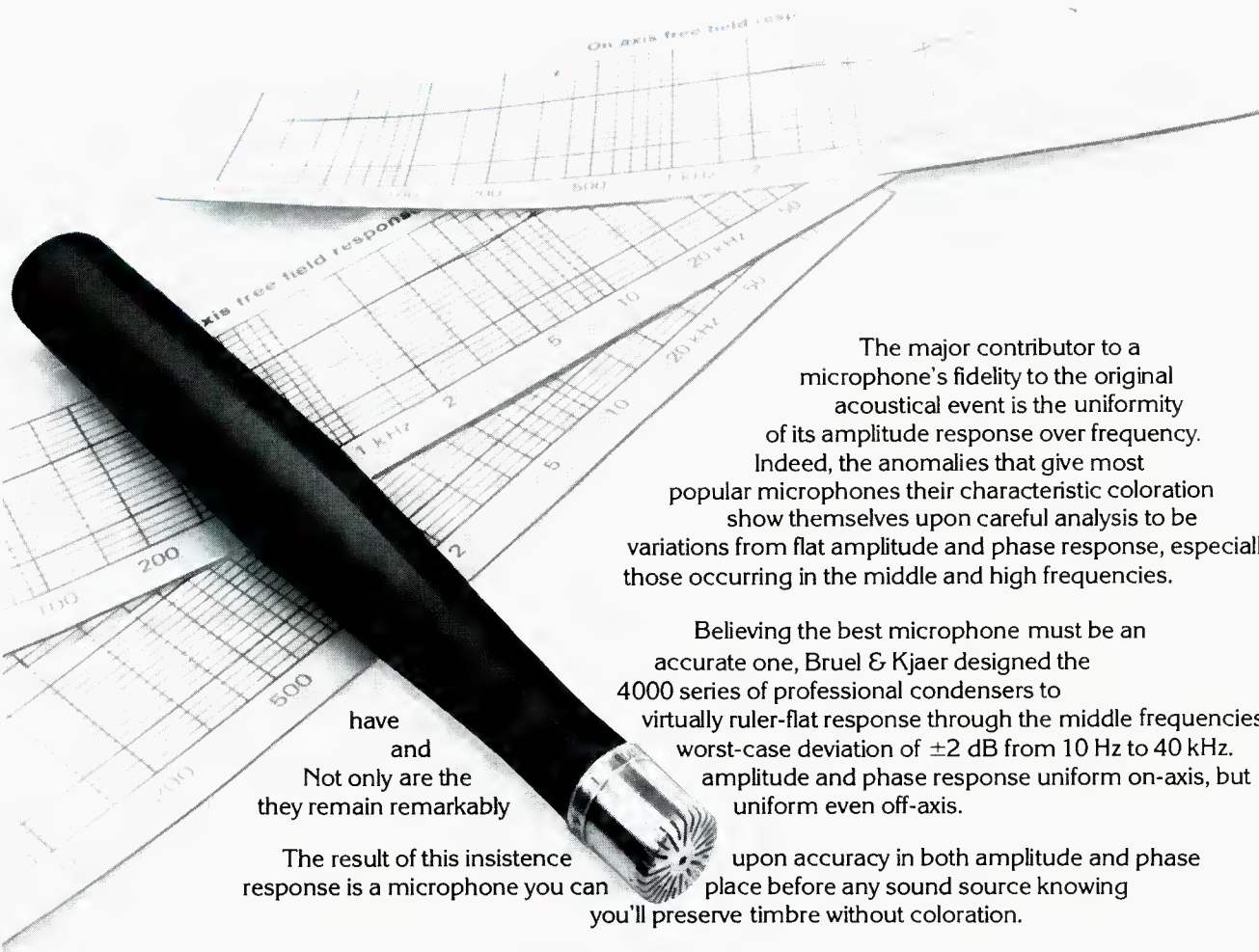

The major contributor to a microphone's fidelity to the original acoustical event is the uniformity of its amplitude response over frequency. Indeed, the anomalies that give most popular microphones their characteristic coloration show themselves upon careful analysis to be variations from flat amplitude and phase response, especially those occurring in the middle and high frequencies.

Believing the best microphone must be an accurate one, Bruel & Kjaer designed the 4000 series of professional condensers to virtually ruler-flat response through the middle frequencies, worst-case deviation of ± 2 dB from 10 Hz to 40 kHz. amplitude and phase response uniform on-axis, but uniform even off-axis.

have
and
Not only are the
they remain remarkably

The result of this insistence
response is a microphone you can

upon accuracy in both amplitude and phase
place before any sound source knowing
you'll preserve timbre without coloration.

If you like performance curves, request our literature. If you'd like a demonstration in your space, call your B&K field applications engineer or contact:



Bruel & Kjaer Instruments, Inc.

185 Forest Street, Marlborough, Massachusetts 01752 • (617) 481-7000 • TWX 710/347-1187

1842 MA-617-481-7000 Ext. 139; NJ-201-227-6100; MD-301-948-0494; GA-404-951-0115; MI-313-522-8600; IL-312-358-7582; TX-713-645-0167; CA-714-978-8066; CA 415-574-8100; WA-206-625-1112

Circle 25 on Reader Service Card

See us at LA AES, booth 240

response, and a tighter low end than standard mic cable.

I try to get a good balance between direct and reflected sound. Sometimes I have to add other mics in the rear of the hall for ambience.

David Hancock: I use two bidirectional ribbon microphones spaced six feet apart, aiming straight ahead. In my experience, the most convincing illusion occurs when the spacing between mics equals the spacing between speakers. A six-foot spacing gives an adequate stereo spread without a severe hole in the middle.

The ideal number of microphones is the smallest number that give a satisfactory musical result. Too many microphones cause unpredictable effects.

David Griesenger: I commonly use four spaced omnis across the front, plus accent microphones as needed for proper balance and spaciousness—up to eight or twelve mics.

I have used Neumann KM-84's for accents, plus one Calrec Soundfield microphone near the soloist and one distant.

I've tried delay on accent mics, but it was not too effective. Treble rolloff on the accent mics helps.

Most important to me is the direct/reverb ratio, followed by spaciousness, localization, and depth. For proper spaciousness, the ratio between L-R and L+R should be about one.

Marc Aubort: I most often use four omni microphones across the front. Extra mics are sometimes added to get slightly more "bite." Accent mics are kept low in level so as not to bring the instrument forward or flatten the sense of depth. I want the horns to sound in the back—not present.

My accent microphones usually are cardioid. I like Schoeps 221 tube mics because of their warmth. The woodwind players sometimes require a placebo microphone!

Hall acoustics are very important; they affect the placement of the microphones. The ideal acoustic for recording and performance is seldom the same. The more the musicians complain they cannot hear each other on stage (the less early reflections), the better the hall for recording.

The score greatly affects the choice of microphone techniques. You must consider whether the score was written skillfully or not. You must analyze the dynamics. Everything does not always have to be heard clearly.

With a good score and a good hall, you can cover everything with just two

microphones. It's important to use as few mics as possible if you have the freedom to re-seat the players.

MONITORING

David Hancock: In the studio I use Quad ESL-63's, six feet apart along the diagonal of the room. On location I use Spondor BC-1's with a 300-Hz crossover, close to the walls.

Stanley Lipshitz: I use Quad ESL-63s four feet from the rear wall and two feet from the side walls. Sonex® acoustic foam is on the rear and side walls to absorb early reflections. This treatment lets me hear more clearly into the acoustic of the recording.

For headphones I prefer Yamaha YH-100. They are a little warm and rolled off on the high end, but natural.

Jack Renner: I use modified ADS 1590's in the US and B & W 801s in Europe.

It's essential to spend time in the venue control room to fine tune the monitor system. I may use Soundex panels from Monster Cable or Sonex acoustic foam. I make mental corrections for room anomalies. I double check with headphones.

In a long room I put the speakers on the long wall about seven or eight feet apart. The woofer is about eighteen to twenty inches above the floor.

David Hancock: Judgements are made of the monitors and control-room acoustics as well as the microphone techniques. So if the acoustics are peculiar, we may make adjustments that degrade the recording. That's why many engineers monitor on-location with headphones. You must work out a standard for yourself that you can depend on.

Marc Aubort: I use only headphones for judging microphone placement and balance because each location sounds different—there are too many variables. I've used Beyer DT48 headphones for years. It's easier to hear buzzes and small fader movements on headphones than on loudspeakers.

CONCLUSION

Although the panelists have different approaches to recording, their common goal is to reproduce a facsimile of the musical performance in the listening room. They also differ in how they weight the priorities.

There is no right or wrong approach—the technique you use depends on the aural impression you wish to make. ■

Bruel & Kjaer microphones are available from:

- Arizona, Phoenix
EAR PROFESSIONAL AUDIO
(601) 267-0600
- California, Encino
EVERYTHING AUDIO
(818) 995-4175
- California, Los Angeles
WESTLAKE AUDIO, INC.
(213) 851-9800
- California, Oakland
LEO'S PROFESSIONAL AUDIO
(415) 652-1553
- Illinois, Chicago
BRIDGEWATER SOUND
(312) 281-8920
- Illinois, Elmhurst
AVC SYSTEMS
(312) 279-6580
- Illinois, Pekin
MILAM AUDIO COMPANY
(309) 346-3161
- Illinois, Schaumburg
STUDIO-SONICS CORP.
(312) 843-7400
- Maryland, Silver Spring
RECORDING CONSULTANTS, INC.
(301) 587-1800
- Minnesota, Minneapolis
AVC SYSTEMS
(612) 729-8305
- Michigan, Farmington Hills
HY JAMES
(313) 471-0027
- New York, New York
MARTIN AUDIO VIDEO CORP.
(212) 541-5900
- Ohio, Parma Heights
PHIL REDDISH SOUND
(216) 885-3030
- Oregon, Portland
RMS SOUND
(503) 239-0352
- Pennsylvania, Philadelphia
TEKCOM CORP.
(215) 627-6700
- Tennessee, Nashville
VALLEY AUDIO
(615) 383-4732
- Washington, Seattle
RMS SOUND
(206) 362-0491



**Bruel & Kjaer
Instruments, Inc.**



Truly great amplifiers are measured by two standards. Sonic quality and reliability. Our new RAMSA 9055, 9110 and 9220 power amplifiers achieve excellence on both counts. And their superb, well-balanced design, combined with Matsushita's manufacturing processes and rigid quality control, gives us the confidence to back them with a 5-year limited warranty.* This RAMSA warranty and UL listing assures you that we stand behind the 9000 series with everything we've got. And that's saying something. We challenge you to compare these new amps for yourself. But you better be prepared to re-evaluate your standards.

Circle 23 on Reader Service Card

See us at LA AES, Room 209

RAMSA

Panasonic
Industrial Company

GET ON TRACK!



The New System 8 Mk.3

Offers you high level Comfort in Layout, Performance and Reliability. Features built through Experience to provide Flexibility and Endurance for the Long Run.

The MK.3 is available in 16 and 24 input configurations, that let you find your stride during those long distance 8/16 track recording sessions. Or demanding sound reinforcement applications.

System 8 MK.3

For more detailed information on how the System 8 MK.3 Mixers can help you... Break A Track Record. Contact your local authorized AHB dealer today.

Run With The Best

AHB

Allen & Heath Brenell (USA) Ltd.
Five Connair Road
Orange, Ct. 06477 / (203)795-3594

Mixing **ART** With **SCIENCE**
Circle 26 on Reader Service Card
See us at LA AES, booth 819

Allen & Heath Brenell Ltd.
69 Ship Street, Brighton, BN1 1AE England
Telephone: (0273) 24928/ Telex 878235

Exploring Planet Dallas

Come along with us on an expedition into this 8-track facility in Dallas.

YOU CAN find Planet Dallas in a historic house on a tree lined street five minutes from downtown Dallas in the scenic area of Turtle Creek, Texas. When pulling up to this quiet and quaint ninety-six year old bungalow you would not expect to walk through the door and find a rocking, professional 8-track studio loaded with outboard gear and all the amenities of home.



An overview of the control room at Planet Dallas.

Local musicians as well as artists from as far away as New York and Nashville come to Planet Dallas for the remarkable sound engineered by Rick Rooney, and for the services of Planet Dallas Publishing, a company run by Judy Jett who is the daughter of Grand Ole Opry star Bill Walker. Rick Rooney and Judy Jett's combined expertise is the fulcrum for this one-stop fully-equipped facility with all of the comforts of home.

Planet Dallas was born as a professional 8-track studio in 1984 as a joint venture between co-owners James K. Devlin and Rick Rooney. James Devlin, a corporate executive with

a love for the music industry, and Rick Rooney, a sound engineer with years of experience, put their heads and resources together. They formed Planet Dallas with the mission of providing a professional studio and publishing company to artists who could not afford high-priced studios.

Rick Rooney left Goodnight Dallas Studios, sold his independent sound production company, and made plans to convert the then-vacant house with that mission in mind. Approximately four months, \$100,000.00, and 250,000 nails later, Planet Dallas opened its doors as a professional studio. Construction involved building subwalls, dual air conditioning systems, all new electrical, planning for office space, and putting in all the equipment. With subwalls of plywood, insulation, and sheet rock finished out in cedar Rooney constructed two main isolated recording areas of 450 square feet a piece and a control room of 350 square feet.

"Along with the equipment I brought in, we started gathering affordable quality equipment. We went with a Yamaha RM1608 board. Our monitoring system consists of a Yamaha PC2002 amp that powers our Altec 605-E monitors with the original master lab crossovers. Our reference monitors are Yamaha NS-10s and Auratones. All of the tape machines are Tascam: an 8-track Tascam 38 with DBX noise reduction, a Tascam 42 for mix-down, and our Tascam 32 for tape copies. We also have two Tascam 122 cassette decks," says Rick Rooney.

Outboard equipment at Planet Dallas consists of: four Dyna-Mite noise-gates, DBX 160Xs, 1176 Urei 1176LN limiters, assorted Orban parametric equalizers, two Lexicon PCM digital reverbs, a Yamaha SPX 90, two Yamaha REV 7s, Delta Lab DL4, and a Lexicon Prime Time. Any other outboard effects can be secured if clients request them.

Planet Dallas' microphone complement includes: assorted Neumann 87s and 47s, AKG 414s, AKG D-12E, AKG 461s, Sennheiser 441s and 421s, Shure SM 57s, EV DS 35s, RE 20,

GAUSS. NO OTHER SPEAKER CAN COMPARE.

If you've ever used speakers for high levels, odds are you've blown one. A Gauss speaker would have saved money in the long run... because it probably wouldn't have blown. Gauss speakers are built to be almost blow-out proof, and torture tested to prove it.

Most companies wind their voice coils on a form, then slip it on a "tube." At Gauss, we wind our coils directly on an aluminum former which is the tube. This prevents coil separation and allows the tube to act as a heat sink, cooling the coil and allowing greater efficiency, which translates to more sound per watt.

At Gauss, we use *two* spiders to support the voice coil tube in the magnetic gap, our famous "double spider" construction. This allows a more flexible spider material, adding to our efficiency, and keeps the voice coil tube centered at all times. If for some reason the coil is driven out of the gap, it will automatically recenter everytime with no damage to the coil. All other speakers use a single

spider... which leads to a lot of recone jobs!

Other manufacturers dress the voice coil wire leads to the cone, where terminal leads are then attached. This can create cone distortion and lead failure. At Gauss, we attach flexible silver braided lead wire directly from the coil to the terminals using gold plated eyelets. This eliminates lead breaks, the most common cause of speaker failure.

Isn't it time for you to switch to Gauss reliability? For the name of your nearest dealer and information on the complete line of Gauss loudspeakers, call or write.



gauss
by Cetec

Sound Ideas for Tomorrow... Today!

Cetec Gauss
9130 Glenoaks Boulevard, Sun Valley, CA 91352
213/875-1900 Telex: 194 989

Circle 27 on Reader Service Card
See us at LA AES, booth 340

They build a

And we've built a great reputation in professional audio. So if you're in the market for a digital multi-track recorder, the only logical choice is Sony.

You can be confident of our experience in professional electronics. And you can be confident of working with an established



great truck.

industry format. With over 200 Sony systems in use, compatibility isn't a problem, it's a plus.

But best of all, Sony equipment is famous for working right out of the box. So the quicker we get the box off the truck, the quicker you can be in business.

SONY[®]
PRO AUDIO

SONY[®]

Digital Audio Recorder
PCM-3324

Sony Professional Audio Department, Sony Broadcast Products Company, 1600 Queen Anne Rd., Teaneck NJ 07666.
© 1986 Sony Corporation of America. Sony is a registered trademark of Sony Corporation.

MITSUBISHI

Circle 28 on Reader Service Card
See us at LA AES, booth 410



Views around the studio.

and Beyer 500s. The studio has a complete eight piece Yamaha recording series drum kit with cymbals, an Oberheim DMX drum machine, Simmons SDS7 electronic drums, and an assortment of other instruments.

"As far as equipment and tape materials go, we concentrate on quality and affordability. We deal primarily with Carver Sound and Sound Productions for equipment and with W.M. Sales for tape. The manufacturers and vendors have all stood behind their guarantees, and they've been great in terms of support," says Rick Rooney.

With the studio functioning for almost two years, Rick Rooney reflects, "I really like the idea of serving emerging artists and writers with both a professional studio they can actually afford and with a publishing outlet. We want to beat the 8-track stereotype of no space and inadequate instrumentation. Eight-track is often thought of as "limited," but every day we prove that if you maximize the 8-track creatively, you can put out a phenomenal product."

Planet Dallas' history of albums, singles, demos and jingles attests to the great potential of an 8-track facility. Their diverse clientele includes: the Mitchell Fox Agency of New York who represents Tom Chess and James Lewis, two artists who are doing a major album project at the Planet; Jim "You Know What I Mean, Vern" Varney who came in from Nashville with Larry Henley ("Wind Beneath My Wings") to cut "Kids Are People, Too" a benefit song for abused children; Bill Nash, rising country singer/writer from Houston who recently released "Seven New Stars" on the Planet Dallas label; Dallas rockers, The Tribe, whose album *My Highway* was recorded at Planet Dallas; Southwest Experience Records producer Winston Flood who brings his soul/funk hits to the Planet; and several national commercial projects.

Regarding the publishing aspect of Planet Dallas, Judy Jett says, "Planet Dallas Publishing is a sister to the studio. Our writers have a studio home under the same roof in which to record their songs. In addition to promoting the growing catalog of songs by Planet Dallas talents, we're focusing on albums and singles. We handle the mastering, plating, pressing, promotion and distribution as the client desires. The music industry is really taking off in Dallas, and this facet of Planet Dallas becomes more and more important."

Judy Jett draws on her years of experience in the Nashville music scene to help develop Planet Dallas' broad base of clients. At thirty dollars per hour including the services of an engineer, Planet Dallas appeals to a wide

market of professional and amateur musicians as well as the advertising market.

They reach their market in a variety of ways. "Word of mouth and referrals bring in a lot of people. When you put out high quality at these prices, word gets around," says Rick Rooney.

In addition to the studio's reputation, Judy Jett's publicity efforts bring in clients. "We showcase our writers and others who record here at local clubs. We work closely with KZEW radio and George Gimarc whose show is now syndicated in Europe doing trade outs of time in the studio for airplay. We do in-house PR—put out press releases and hold press receptions. Good will and a good product develop rapport with the press. Our press activity has really increased, and has brought in local and out-of-state business. We also enjoy going out to clubs together and getting to know our musical community personally," says Judy Jett.

She has also organized a songwriters' seminar to benefit abused children. A record-breaking 150 songwriters collaborated on the song, "Kids Are People, Too." Larry Henley and Larry Keith came in from Nashville to help with the seminar and Jim Varney joined Henley to record "Kids" with a chorus of youngsters at Planet Dallas. Negotiations are now under way to include the song in an upcoming Disney movie starring Varney.



With major projects like this one in the making and with the daily business of cultivating new talent, Planet Dallas is looking to the future. Plans are in the works to go to 24-track in the fall. The studio is working with Kent Duncan of Sierra Audio Acoustics on a complete acoustic design. They will enlarge and rebuild the control room. An assistant engineer will then join the staff to handle a round-the-clock workload.

"The demands and sophistication of our music community make expanding to 24-track essential. Our goal is to do the 24-track recording projects affordably. Our experience at 8-track is a great foundation," states Rick Rooney. And he remains committed to the mission of giving musicians at every stage of their development the best product for the best price.

Every day at Planet Dallas is dedicated to enlightening people about what can be achieved with a good 8-track facility. As long as creativity flows, it will have an outlet on The Planet.

If you are interested in contacting Planet Dallas you can do so at (214) 521-2216. ■

We challenge you to hear the \$775 difference!

There's nothing better than a \$1,000-plus condenser microphone to capture every performance detail. If you can afford it. But what if you can't?

Listen to some very talented musicians and mixers who recently tested the new ATM33R condenser cardioid from Audio-Technica. They told us the sound was almost identical to their big-bucks favorites. They liked the wide dynamic range and

uniform off-axis response. The ability to use any standard phantom-power source from 9V to 52V, and the famed *Road Tough* construction were also definite plusses.

After comparing the ATM33R, several testers suggested they could now duplicate their studio sound on the road, where studio condensers were too expensive to risk. Others could see the advantage of four or

more ATM33R microphones in a demo studio, at no more investment than one expensive condenser.

Compare the new ATM33R with any other condenser cardioid on the market. At ANY price. Check it for sound quality, ruggedness, and affordability. Whether you are MIDI sampling, cutting demos, or on stage every night, the ATM33R can make a big difference...for far less!

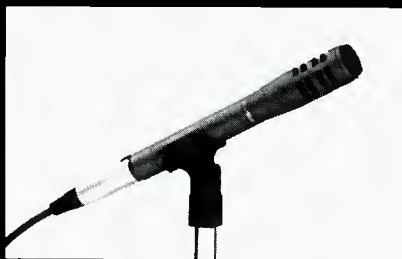

ATM33R Condenser Cardioid Microphone

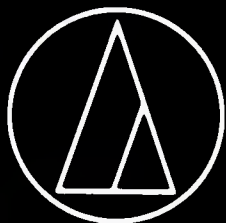

audio-technica®

1221 Commerce Drive, Stow, Ohio 44224
(216) 686-2600

Circle 29 on Reader Service Card
See us at LA AES, booth 233

TUBE•TRAPS

CONTROL BASS ACOUSTICS



THE ONLY ACOUSTICAL TREATMENT SYSTEM

- Broadband, Effective 400 Hz. Thru 40 Hz
- Corrects Low End Phase Distortion
- Damps Standing Wave Room Resonances
- Reduces Room Resonance "Q" Response By 4
- EQ's Low End RT-60 Decay Constants
- Packs 15 Sabines Absorption Into Each 3' Tube
- Midrange, Adjustable Diffusion
- Light Weight, Sturdy and Very Portable
- Versatile, Pressure Zone Bass Trap or GOBO

1-800-ASC-TUBE

ASC ACOUSTIC SCIENCES CORPORATION

P.O. BOX 11156 EUGENE, OREGON 97440

Circle 30 on Reader Service Card

See us at LA AES, booth 1418



We're #1 on

COMPACT
disc
DIGITAL AUDIO

CALL (416) 977-0512

86 McGill Street, Toronto, Ontario
Canada M5B 1H2

Circle 32 on Reader Service Card

See us at LA AES, booth 632

Mark E. Battersby

On Taxes

Leasing With An Option To Acquire

• The age-old question of whether to lease or buy is one which the average home recording studio owner may never fully resolve. After all, just as two recording studios are not exactly alike, the financial picture of a given sound recording operation will also change from one month to the next. The *only constant* in this equation is our voluminous tax laws.

Under that basic tax law, the Internal Revenue Code, rental or lease expenses are tax deductible as a legitimate business expense only if:

- They are incurred as a condition to the continued use or possession of property used in a trade or business; and
- The studio owner has not taken or is not taking title to or has no equity in the property.

Since most studio owners would prefer at least the option of owning the leased property or equipment at the end of the rental period, the tax law would seem to rule out a tax deduction for lease or rental payments where an option of purchase is included. Fortunately, despite the apparent intent of our lawmakers, the question is not as cut-and-dried as it might appear at first.

A lease with an option to buy obviously offers the advantage of immediate rental deductions that can be substantially larger than depreciation allowances on the same property. The owner's right to take title to the property is retained—a business advantage that a straight lease does not offer. The problem is to keep the option price high enough, or the rental payments low enough so that, at least for tax purposes, the rent or lease payment is not treated as a payment on the purchase price.

The US Tax Court, which has decided most of the lease-with-option cases, seems to apply an "economic reality" or "intent to purchase" test to a transaction. If the option is exercisable within a period that is clearly less than the useful life of the property and the rental payments cover a substantial part of what would be the purchase price, the Tax Court is likely to rule that a sale was intended.

Fortunately, however, the US Court of Appeals for the Seventh Circuit has adapted a much more liberal attitude toward the deduction of rental payments where the amount to be paid at the time title is taken is greater than the amount that, for purposes of a business expense deduction, would be considered as "ordinary," "necessary," or "reasonable."

Although advance rulings can be sought from the IRS in determining whether given transactions purporting to be leases will actually be treated as such for Federal income tax purposes or whether they will be considered conditional sales, there are a number of guidelines that can be relied on by the studio owner entering into what he or she thinks is a leasing transaction.

For example, according to the Internal Revenue Service, an agreement is a sale, rather than a lease, if one or more of the following conditions are present:

- Portions of the periodic payments are made specifically applicable to an equity to be acquired by the studio owner in the property.
- The taxpayer will acquire title to the property upon payment of a stated amount of rentals required to be made under the contract.
- The total amount that must be

Designing The Future

EAW's New FR253B Is The Future Of High Output Nearfield Loudspeaker Systems

You're looking at what's ahead for high output loudspeaker systems. At EAW, we call it "High Definition Systems".

The FR253B offers features and performance that goes beyond any other brand's "state-of-the-art" technology. That's because EAW has led the touring sound industry in system design for years, and now we are bringing our advanced technology to the smaller nearfield market.

What only EAW gives you today others will surely have in the coming years. A demonstration will convince you of the startling difference between EAW and what you're used to. You'll hear definition and depth, not the typical one dimensional sound. All you have to do is listen and the difference is obvious.

Technology:

Poly-Laminated 170mm cone mid range driver operating in the 450 to 3,500 Hz band for seamlessly smooth vocal reproduction, and new standards of distortion-free output.

Advanced third order crossover network employing asymmetrical slopes for maximally flat power and phase response.

High technology compression driver utilizes cast reinforcing ridges in the diaphragm for extended high frequency response.



Performance:

Absolute response linearity for faithful tonal balance reproduction

+ - 2 dB 55 to 14,000 Hz
+ - 5 dB 30 to 20,000 Hz

Very high power handling 625 watts AES standard for unsurpassed reliability

More than 40 acoustic watts maximum output / 131 dB maximum sound pressure, more than enough for even the most demanding nearfield applications



Eastern Acoustic Works, Inc • 59 Fountain Street • Framingham, MA 01701 (617) 620-1478
TWX: 7103807630 • Japan: **Unicus**, Tokyo Tel: 03-662-8518 Telex: 871-29440 •
Europe: **HPS**, Amsterdam, Holland Tel: 020-233954 Telex : 844-1412 • Australia: **Audio Engineering**,
Sydney Tel: (02) 571236 • Venezuela: **AudioRama**, Caracas Telex: 395-26551

Circle 35 on Reader Service Card
See us at LA AES

Put an End to Cable Clutter!

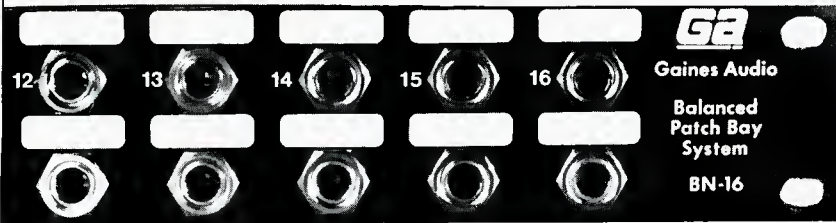

At a factory-direct price of only \$85, the Gaines Audio BN-16 Balanced Patch Bay is the most affordable system available, yet it has the features and quality you demand: 32 fully balanced and "normalised through" patch points in a single rack space, metal-bushing Switchcraft ¼" jacks, and easy solder termination on a large, rear panel printed circuit board.

Call or write to order, or for more information. Orders shipped within 24 hours. VISA, MC, COD, or money orders accepted. 30 day return privilege if not completely satisfied. Add \$3 for shipping.

Gaines Audio PO Box 17888 Rochester, NY 14617 (716) 266-0780

Circle 31 on Reader Service Card

paid for a relatively short period of use is an excessively large proportion of the total sum required to be paid to secure transfer of the title to the property.

- The agreed rental payments materially exceed the current fair rental value of the property. This may be indicative that the payments include an element other than compensation for the use of the property.

- The studio owner acquires the property under a purchase option at a price that is nominal in relation to the value of the property at the time when the option may be exercised, as determined at the time of entering into the original agreement, or that is a relatively small amount when compared with the total payments required to be made.

- Some portion of the periodic payments is specifically designated as interest or is otherwise readily recognizable as the equivalent of interest.

- The taxpayer will acquire title to the property upon payment of an aggregate amount (that is, the total of the rental payments plus the option price, if any) that approximates the price at which the studio owner could have purchased the equipment when he entered into the agreement, plus interest and carrying charges.

Thus, where a lease contains an option to purchase and the question arises as to whether the instrument should be treated for tax purposes as an installment sales contract rather than as a lease, the above guidelines issued by the IRS can provide an idea of the proper treatment. If it is regarded as a sales contract, the so-called rental payments are not deductible by the user of the property. However, if the transaction is an installment sales contract, the user is entitled to depreciation or cost recovery deductions from the time he takes possession even though he does not have title, and, in fact, may never exercise the option and acquire title.

As previously mentioned, a lease with an option to buy offers the advantage of immediate rental deductions that can be substantially larger than depreciation allowances for the same property. But, because of the wording of our tax laws—and the IRS's interpretation of those laws—the studio owner should be wary of blindly entering into any lease agreement that contains an option to eventually acquire the property or equipment.

Our graduates Work

A practical education in audio and video recording arts and sciences. For anyone who takes recording seriously.

Institute of Audio-Video Engineering

NATIONAL 1-800-551-8877
 STATE 1-800-972-1414
 LOCAL 213-666-2380

1831 Hyperion Ave., Hollywood, CA 90027
 Dept. G

Circle 33 on Reader Service Card

See us at LA AES, booth 943



THE PORTABLE VCR THAT DELIVERS AN AUDIO-DYNAMIC RANGE IN EXCESS OF 80dB.

The Panasonic® AG-1900. It's unlike any other portable VCR. Because it records audio with such precision, you'll think you're listening to digital on a standard VHS cassette.

Consider the specs and you'll find the kind of performance normally found in studio audio-mastering equipment costing thousands of dollars more. Like dynamic range of more than 80dB, a frequency

response of a flat 20-20,000 Hz and a practically nonexistent wow and flutter of 0.005%. The AG-1900 also features manual record level controls and peak reading meters.

Equally impressive is the AG-1900's video quality. Its four heads provide a picture that's crisp and clean. Even special effects like still, frame advance, and search in both forward and

reverse are virtually noise-free.

For maximum performance in the field, team up the AG-1900 with portable mixers and microphones from RAMSA Professional Audio by Panasonic. And choose from any one of our single- or three-tube professional cameras for a complete portable hi-fi video system.

The Panasonic AG-1900. Studio quality that goes anywhere.

For more information, contact your nearest Panasonic Professional/Industrial Video dealer or call your nearest regional office.
Northeast: (201) 348-7620. Midwest: (312) 981-4826. Southeast: (404) 925-6835. Southwest: (214) 257-0763.
West: (714) 895-7200. Northwest: (206) 251-5209.

Panasonic
Industrial Company

Circle 36 on Reader Service Card
See us at LA AES, Room 209

Obviously, since the option to purchase is such a valuable addition in the eyes of so many studio owners, completely eliminating that provision is impossible. But, care can be taken that the option will not negate the entire lease resulting in a loss of badly needed business expenses. And, one major factor in determining the validity of the lease is the amount of the rental payment.

According to our tax rules, the amount of rent itself can be a fixed sum or it can even be based upon a percentage of profits, a percentage of gross sales, or a combination of these. Moreover, the IRS has made it quite clear that a tax deduction will not be disallowed where the amount of rent is fixed in an arm's length transaction without tax avoidance motives.

However, where a close relationship exists between the lessor and the lessee, the question of the reasonableness of the rental amount becomes important when determining whether the amounts paid are actually rent or something else in the guise of rent. Thus, in one situation where the amount of rental payments made by a corporation to a related partnership

was based on the amount necessary to service the partnership's mortgage liability for the property, the rent payments were not tax deductible to the extent that they exceeded the fair rental value of the property.

Furthermore, where a corporation makes rental or lease payments to its principal stockholder who has purchased the assets of the corporation and leased them back to the corporation, the amount paid may be a non-deductible dividend rather than a business expense. In situations where an excessive amount is paid to a lessor by a relative, the amount may be taxable as a gift under our tax rules.

The option to acquire the equipment at the end of the lease term is not the only payment that may occasionally be labeled a capital expenditure by the ever-vigilant Internal Revenue Service. Lump-sum payments that represent consideration for the continuation of a lease may also constitute capital expenditures rather than currently deductible business expenses. Where such payments do constitute capital expenditures, they must be amortized over the unexpired term of the lease.

Similarly, expenses incurred by a home studio owner in making improvements, i.e., changes made to the leased equipment or rented premises that enhance the value of the property (in contrast to short-lived repairs or maintenance), are capital expenditures the cost of which may be recovered over the life of the improvement or the remaining term of the lease, whichever is shorter, by way of a tax deduction for amortization, depreciation or cost recovery. Remember, however, where the terms of the lease provide that a tenant is to replace worn-out property or equipment, the cost of such replacement property may be currently deductible even though the useful life of the replacement property substantially exceeds one year.

Leasing always *has* been and will continue to be an attractive alternative to outright purchases of equipment and property. Making leasing even more attractive has been the option to purchase tacked on to so many leases. With the Internal Revenue Service—and the basic tax law—looking so closely at that option, close adherence to the rules is strongly suggested. ■

Copies of articles from this publication are now available from the UMI Article Clearinghouse.

For more information about the Clearinghouse, please fill out and mail back the coupon below.

UMI Article
Clearinghouse

Yes! I would like to know more about UMI Article Clearinghouse. I am interested in electronic ordering through the following system(s):

- DIALOG/Dialorder ITT Dialcom
 OnTyme OCLC ILL Subsystem
 Other (please specify) _____
 I am interested in sending my order by mail.
 Please send me your current catalog and user instructions for the system(s) I checked above.

Name _____
Title _____
Institution/Company _____
Department _____
Address _____
City _____ State _____ Zip _____
Phone (____) _____

Mail to: University Microfilms International
300 North Zeeb Road, Box 91 Ann Arbor, MI 48106

Carvin MX1688 16x8 Audio Mixer



GENERAL INFORMATION

THE CARVIN MX1688 is a full-function audio mixing console that can serve equally well as a control center for an 8-track recording studio or for live sound reinforcement mixing. As its designation suggests, the unit has sixteen identical input channels, each of which features an "Input Gain" control for both line and

mic inputs, four auxiliary mixing busses with pre/post switching, Muting, Soloing and odd/even Pan controls for sub-group routing. Each channel's volume control is a smooth operating slider type covering a sliding distance of 100 millimeters (nearly four inches). Each input channel also features signal insertion points for just about any type of signal processing equipment you might want to add.

The MX1688's output section (there are eight identical output channels) features independent control room monitoring, made possible by a pair of Track Faders and Pan controls provided on each of the output channels. A "Tape" switch is provided at each output channel so that the tape playback signal can feed the cue and control room mixes. As a result, none of the sixteen input channels need to be given up to return tape playback signals when doing overdubs.

Our investigation of the MX1688 revealed that it is built of high quality components. Professional signal connectors (3-pin XLR and 1/4-inch phone) as well as highly reliable ITT switches are used throughout. Large VU meters are well damped and we found them easy to read during practice runs with the mixer. The long-throw faders, referred to earlier, have fifteen percent audio tapers for smooth fades and feature integral dust shields for extended noise-free operation. All rotary knobs are color coded by function and have easy to read pointers that can be seen even in dim light.

Construction of the MX1688 is modular, with individual circuit boards used for each channel and master strip. We could find very little hand wiring, thanks to the extensive use of computer type, multi-conductor ribbon cable. The heavy-duty power supply is located far enough away from signal circuits to provide ultra-low noise performance. Critical supply voltages are well regulated to reduce cross-talk and current limiting circuits protect against power

supply shorts. The chassis itself is made of precision formed steel with pem-nut fasteners and an epoxy finish. Thick oak end pieces and a padded hand rest add to the elegant appearance of the console.

The well-organized owner's manual, supplied in a handsome three-ring binder, lists the recording and live sound mixing features of this console. That section of the manual provides as good a summary of the features available as any that I could come up with, so here they are:

RECORDING FEATURES

- Eight Track studio control center.
- Complete headphone Cue mixing facilities.
- Separate input and output channels with I/O capabilities.
- Three-band parametric EQ with defeat for each channel.
- Four auxiliary busses per channel with pre/post switching.
- Solo and Mute on all input and output channels.
- Two "Effects" returns with Panning and Soloing.
- Built-in talk-back system with Slate, including monitor dimming.
- 100 mm faders on each input and output channel.

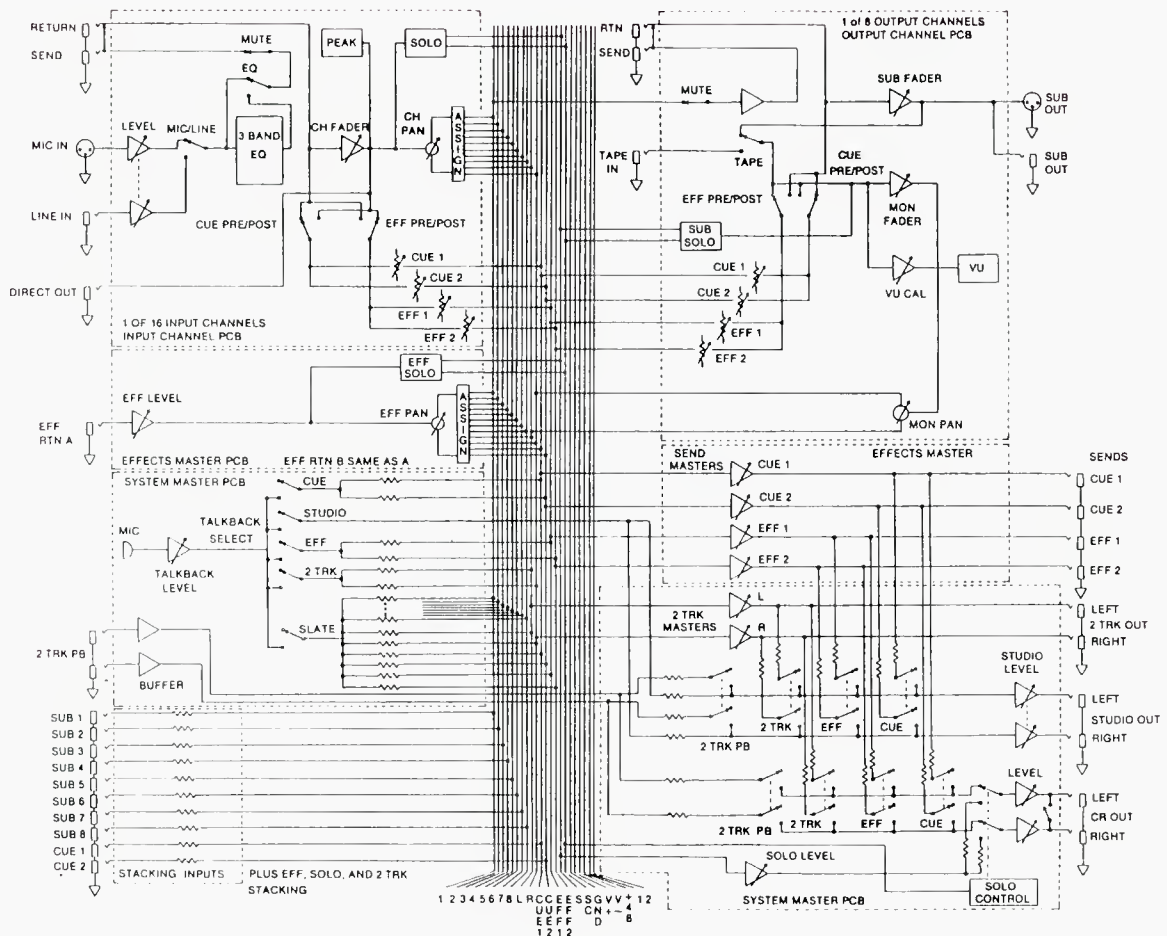

Figure 1.

- Studio mix outputs as well as control room outputs.
- Stacking inputs.
- Peak warning indicators per channel with "peak stretching."
- Send/Receive/Direct Outs/Line-in patching points on each channel.
- Phantom powering for microphones.
- Cue and Effects "sends" from output channels.
- Alternate metering of Cue and two-track.
- Quick tape playback through monitors via "Tape" switch.
- Independent Mic and Line preamps.

LIVE SOUND MIXING FEATURES

- Eight sub-groups with Solo and Mute.
- Four independent monitor mixes available.
- Headphone monitoring of Main or Monitor outputs.
- Talkback to monitors.
- Eleven-step input gain controls for faster set-up.
- Channels and Outputs are assignable to L&R stereo Output.
- Channel patching on all output channels.
- 600 ohm inputs and outputs.

CONTROL LAYOUT

The best way to appreciate the versatility of this mixer is to check out its controls and how they are arranged on the input channel, effects master, system master and output channel modules. The Input channel strips are perhaps the most elaborate of these groups. At the top of each strip is the mic/line switch and below it a rotary input gain control. Below that comes the parametric equalizer section governed by three dual-concentric knobs, by means of which center-frequencies as well as amount of boost or cut are regulated. Control range is -15 dB. The "High" control shifts center frequencies from 1kHz to 16 kHz. Range for the mid-control is from 200 Hz to 4 kHz, while the bass EQ can vary center frequency from 40 to 800 Hz. The next two controls are the "Cue" and "Effects" sends. The two cue as well as the two sends can be selected either pre or post the channel fader. A Pan control and Assign pushbuttons come next, the latter allowing input channel signals to be assigned to output channel pairs. The PAN control then pans the signal across the assigned output channels or it can be positioned to send the signal to any one output channel. A channel mute switch further towards the front of the strip removes that channel signal from the system, while a Solo switch just below interrupts the signal sent to the control room and replaces it with the signal that is being soloed. An LED indicator lights when neither the Mute or the Solo switch is depressed. When signal peaks come within 6 dB of clipping any stage in the input channel, the Peak Warning Light just above the long-throw fader for that channel illuminates. The fader calibration is in dB from +10 to -50 and "Infinity."

The Effects Master Strip, located to the right of the sixteen input channel strips, is divided into three sections. The Send Master section sets the overall output level for the cue and effects "sends" signals after they have been summed. A pair of "Effects Return" groups allows you to return the effects signals to the mixer, to set their level and

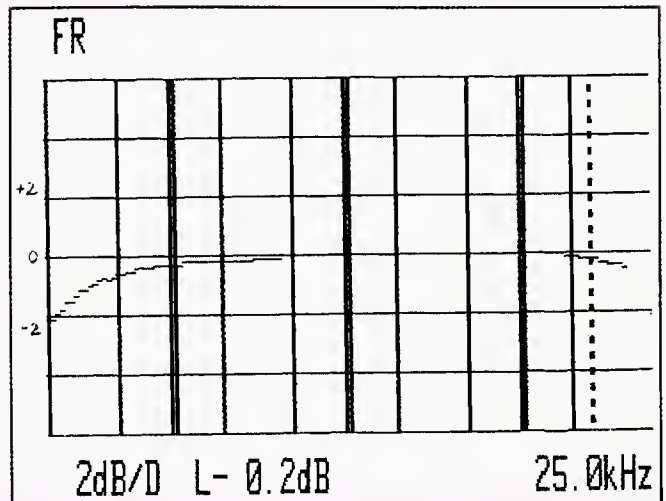

Figure 2. Frequency response, Line level into 2-trackout.

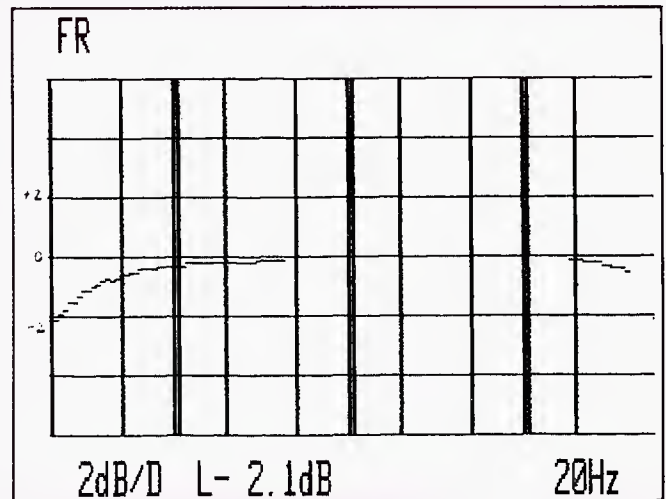

Figure 2B.

to assign these effects signals to any of the output channels, Cue 1 and 2, or to the two-track output. A pan control in this section lets you pan across the cue or output channels. The master two-track faders located below the effects master strip are a closely spaced pair of sliders that allow easy operation of both faders with one finger. They set the level of the two-track output signals.

The System Master strip located to the right of the Effects Master strip is divided into six control sections. A phantom power switch is at the top of this strip. Below that are meter function switches. The eight meters on this console normally monitor the output levels of the eight output channels. However, the meter function switches allow you to switch meters 5 and 6 so that they monitor the Cue 1 and 2 signals, and meters 7 and 8 can be switched to monitor the two-track output signals. The talk-back section incorporates a condenser microphone and, by means of appropriate switches, provides talkback audio to the cues, the studio, the effects sends. It also allows "slating" onto tapes for labeling during recording. Depressing any talk-back switch automatically "dims" (reduces the levels of) control room monitors so that feedback is prevented. The Control Room group of controls includes the Master Solo LED and level control, assign switches that select the signal to feed the control room (two-track, two-track playback, Cue 1 and 2, and Effects 1 and 2), and a stereo/mono switch

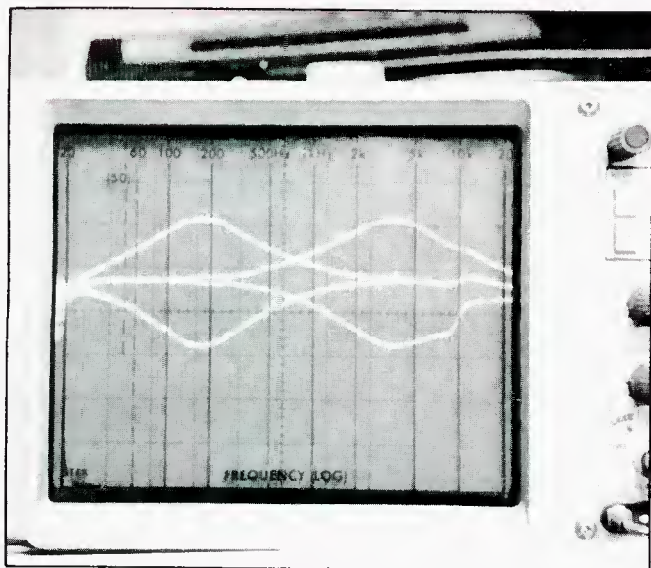

Figure 3A.

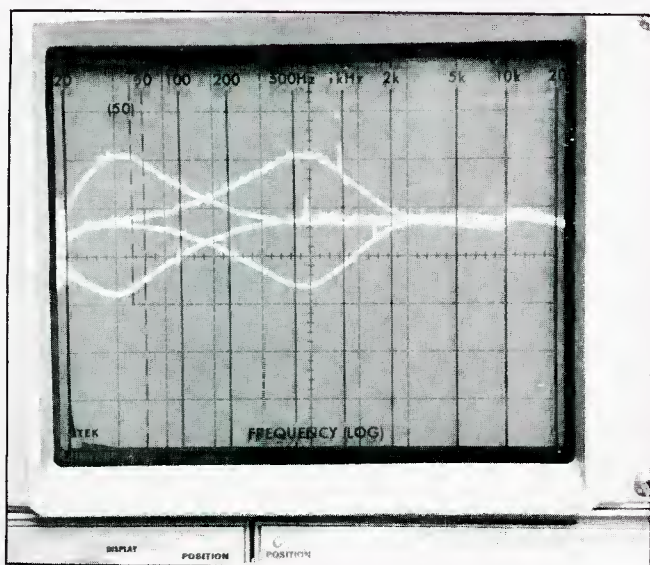

Figure 3B.

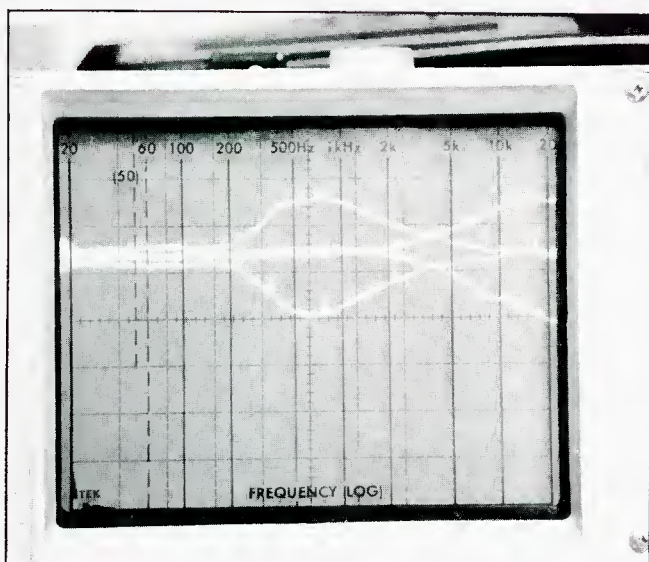

Figure 3C.

that allows for phase checks and mono monitoring in the control room. At the lower section of this strip is another close-spaced pair of faders that are used to set overall volume level in the control room itself.

Output channel strips are also divided into six main control sections. Cue and effects "sends" are at the top of the strip. Pre/post switches allow these controls to be used as either cue sends or effects sends depending upon how the mixer is being used. A Buss/Tape switch causes the two-track fader, PAN and VU meters to be fed either from the output channel fader or from the tape playback signal. The two-track pan and fader controls on each output strip make up the control room monitor sections of the mixer. These controls have no effect on the signal going to the tape deck except when doing a two-track mixdown. A sub-mute switch can be used to remove the output channel from the system, including cue and effects send. A sub Solo switch, when depressed, causes the output channel selected by the buss/tape switch to be soloed into the control room monitors. Finally, near the lower edge of the strip, the Output Channel Fader adjusts the recording level of the output channel and also feeds the two-track fader. This fader is always fed from the buss regardless of the position of the buss/tape switch.

All Line Input Jacks, Mic input Jacks, Channel Direct Output Jacks, Channel Send and Return Jacks, Sub Output Send and Return Jacks, Sub Output Jacks, Control Room Outputs, Cue Send Jacks, Effects Send Jacks, Effects Return Input Jacks, Studio Output Jacks, Two-Track Output Jacks, Two-Track Input Jacks, and Stacking Input Jacks are logically arranged on the rear apron of the mixer. Viewed from the rear, the AC power cord, On/Off switch and AC line fuse are at the left of the console, far removed from the low-level microphone and line input channel sections. A complete block diagram of the signal flow pattern within the mixer is shown in *Figure 1*.

LAB MEASUREMENTS

A complete table of VITAL STATISTICS, covering the manufacturer's published performance specifications and our own lab test results will be found at the conclusion of this report. Much of the evaluation of this equipment relates more to its versatility and its ease of use, rather than to specific audio lab measurements. Frequency response for the mixer, from any line input to the two-track output was down -2.1 db at 20 Hz but extended to well beyond 20 kHz at the treble end, as shown in the graphs of *Figures 2A* and *2B*. For the microphone inputs, adjusted for 40 dB of overall I/O gain, total harmonic distortion at mid-frequencies measured only 0.025%, while for the line inputs to the two-track outputs, adjusted for 10 dB of voltage gain, THD measured only 0.01%. SMPTE-IM distortion (not specified by the manufacturer) was also very low for a console of this type, measuring only 0.03% for the same equivalent output levels. *Figures 3A*, *3B* and *3C* illustrate the frequency range and the amplitude adjustment range of the parametric EQ sections of each input channel module. The upper 'scope display of this group (*Figure 3A*) shows the boost and cut range of the mid-range control as well as the range of frequencies to which that control can be set. *Figure 3B* illustrates the same thing for the Bass EQ control, while *Figure 3C* illustrates the same ranges of control for the Treble EQ control.

Signal-to-noise ratio with all fades down was -89 dBV, while even at nominal control settings, S/N remained a high -82 dBV. Cross talk between adjacent channels measured

VITAL STATISTICS: 16 x 8 AUDIO MIXER

MAKE & MODEL: Carvin Corp. MX1688

SPECIFICATION	MFR'S CLAIM	db MEASURED
Frequency Response Mic/Line to 2-track out	15 Hz to 25 kHz, +/-1dB	See Fig. 1
Harmonic Distortion Mic to 2-tr., 40dB gain	0.03%	0.025%
Line to 2-tr., 10dB gain	0.02%	0.01%
Output Noise Faders Minimum	-85 dBV	-89 dBV
At nominal gain	-80 dBV	-82 dBV
Crosstalk, Adj. Channels At 1 kHz	65 dB	60 dB
At 10 kHz	55 dB	52 dB
Parametric Equalizer Range (boost/cut)	-15 dB	Confirmed
Frequency Range	See Text	See Figs. 3A,B,C
Peak Warning Level	6 dB Below Clipping	Confirmed
Mic Input Range	-70 dBV to -10dBV	-70dBV to -10dBV
Max. Mic Input	+10 dBV	+12 dBV
Line Input Range	-20dBV to +10dBV	-20dBV to +12dBV
Max. Line Input	+30 dBV	+33 dBV
Max Gain Mic to sub output	74 dB	70 dB
Line to sub output	40 dB	35 dB
Power Requirements	120/240 VAC, 50/60Hz	Confirmed
Dimensions (H x W x D, inches)	8-3/4x35-1/8x29	Confirmed
Weight	80 lbs.	Confirmed
Warranty	1 yr. parts & labor	
Price	\$2995.00(+\$49.00 shipping cost)	

just slightly poorer than claimed: 60 dB at 1 kHz and 52 dB at 10 kHz.

COMMENTS

Having lived with this Carvin mixer for a couple of weeks before reluctantly sending it back to the manufacturer, I can attest to the fact that it is truly targeted at the professional recording engineer or sound reinforcement engineer. It is obvious that the people who designed this unit have spent a lot of time both in recording studios and at concerts where sound reinforcement is both critical and complex. Recording basic tracks, overdubbing sessions and final mixdowns are all handled with a great deal of ease once you become familiar with the many functions and controls found on each section of the mixer. And that familiarization won't take you as long as you might suppose when you first see the instrument. That's because a great deal of signal-flow logic has been used in laying out the front of this console.

I've seen sound reinforcement mixers that can do many of the things that this combination recording console/pa mixer can do, but usually those pa-oriented machines don't exhibit the kinds of signal-to-noise and distortion figures that I measured for this console. And, of course, there are recording studio 16-in/8-out boards that measure as well as this one, but they don't provide the flexibility and versatility that a sound reinforcement engineer needs when doing a "live" concert mix. For the audio engineer who wears more than one hat and needs mixing equipment that does well in a wide variety of environments and situations, I would think that the Carvin MX1688, at its suggested price, is an ideal solution.

Circle 24 on Reader Service Card

TWENTY SECOND STRIP



MUSIFLEX microphone cable uses a conductive thermoplastic shield (with excellent shielding properties) terminated by a pre tinned drain wire. There is no braiding to unpick and prepare, so **MUSIFLEX** can be stripped and ready for soldering in less than 20 seconds. **MUSIFLEX** is available in 11 colors.

Also Available:

- * Foil-shielded multipair cable (from 1 pair to 31 pairs)
- * Overall shielded multi-core cables
- * Microphone cables
- * Speaker cables
- * Power cables

MUSIFLEX[™]
IS A REGISTERED
TRADE MARK OF
CONNECTRONICS



UNITED KINGDOM
CONNECTRONICS LIMITED
20 Victoria Road
New Barnet Hertfordshire
EN4 9PF England
Telephone 01 449 3663
Telex 8955127 SGAL G

UNITED STATES OF AMERICA
CONNECTRONICS CORPORATION
652 Glenbrook Road
Stamford CT 06906 U.S.A.
Telephone (203) 324 2889
Telex 643678

Circle 34 on Reader Service Card

See us at LA AES, booth 730

A Noise Primer for the Small Studio Owner

“**W**HERE IS all that noise coming from?” your client asks in dismay. It’s 3 AM, you’re just finishing the final mix, and all of a sudden the hiss you’ve been trying to ignore is all too apparent. There’s no easy way to make it disappear, because the noise isn’t coming from just one source, and it didn’t get introduced all at once. It’s been building slowly and steadily with each new track and each new effect, and every piece of equipment you’ve used has made its contribution.

“Noise” is a fairly complex subject and causes considerable confusion for the average studio operator, even those with considerable technical knowledge. Noise contains many disparate components, but basically it all boils down to one thing: stuff in the final mix that isn’t supposed to be there. However, by the time you get to the final mix, it’s too late to start looking for the problem. You really need to go back to the beginning and take a systematic and logical approach to rooting out the sources.

IDENTIFYING THE SOURCES

Typically, noise can be traced to these origins:

- Improper Gain structure
- Ground loops
- RF Noise
- Tape Noise

- Excessive equalization
- Ambient noise on original tracks
- Modulation noises and spurious junk from digital synthesizers and effects.

Surprisingly, broken equipment is the least probable cause of your problems.

UNDERSTANDING THE GAIN STRUCTURE OF YOUR SYSTEM

Every audio system has a gain structure which you can illustrate as a flow chart; the system contains quiet and loud operating points, as well as intermediate stages. Generally, the flow is from quiet to loud, or mic level to speaker level. Every step along the way requires an increase in system gain, with a corresponding increase in noise. For example, the input preamp on your mixer will always add a certain noise component to the microphone’s output, no matter how good the mic preamp is. As that signal makes its way through the mixer and eventually to a pair of speakers, the audio level keeps increasing. And, as the audio level increases, so does the noise. The important point to understand is that the noise introduced early in the signal path never goes away or gets lost, it just keeps getting amplified with the audio signal. Also, other noise sources get added to it along the way as the signal goes through equalizers, pan pots, gates, etc. Which leads to the next important point: every time you

deliberately reduce the gain within the system and then need to make it up again somewhere else down the line, you aggravate the problem. The original signal (and noise) gets restored to its original level, along with a little extra noise as a bonus.

Here's a typical example: you're doing a recording that includes some special effects processing on the lead vocals. The microphone is connected to your console's input preamp, which introduces about 50 dB of gain and some noise in the form of hum and hiss. Let's say that the console's outputs are nominally +4 dBv, but you want to connect the effects send to a digital delay that is designed for -15 dBv inputs. So, to avoid clipping, you either insert a pad or else just turn down the send by 19 dB. Now the delay unit is happy, but the output level of the delay is so low that you have to boost its output level control all the way up to get enough volume. No problem, but more noise gets added to the signal. If I may be allowed to stretch the point, let's pretend that you decide to feed the same signal to a "real" reverb chamber down the hall. The output of the delay unit gets sent down the hall on a balanced mic line at mic level, amplified to a speaker in the chamber, picked up by another mic, fed to another mic preamp, and brought back into the console return at line level. Now all of this gets sent to one track on your multitrack tape machine which unfortunately operates at -10 dBv, forcing you to drop 14 dB of gain every time you go to that machine and make it up again when returning to the console. Nonetheless, you do your mixdown onto your two-track, play it back through the console, amplify it to speaker level, and listen to it with your client. This is the part where he asks you where the hiss and hum are coming from.

Plotted as a noise and signal level flow chart, the whole thing looks something like this:

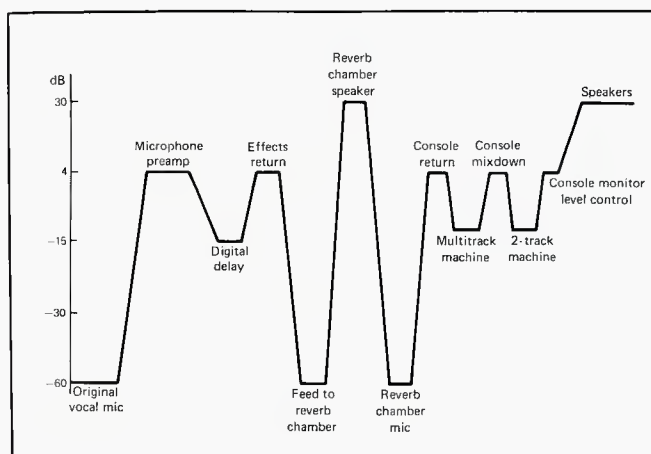

You begin to get the idea, I'm sure. But it doesn't end there. I've illustrated only one microphone source. In practice, you may be using twenty-four or so, and their noise all adds together. And, it's not just your system that has a bumpy gain structure; almost every component in the system, be it console, tape machine, or effects unit, has its own internal gain structure and manipulation which you can't even see. In well designed equipment, this kind of level shifting is kept to a minimum, but there's always some.

As a studio owner and system designer, the burden is on you to be aware of the gyrations you force a signal to go through on its way to the final mix. Obviously, the fewer "peaks and valleys" in the system, the better. One way you

can work towards an optimum signal flow is to attempt to purchase equipment that operates at compatible signal levels. Most manufacturers of pro audio equipment have settled on a standard nominal operating level of 0 dBv. When considering a console or effects unit, pay attention to the part of the spec that states the nominal operating level. Also, when you get to those points in the recording session when you find yourself reaching for a direct box or some other transformer interface device, stop and assess what the gain implications are as a result of using that device. Similarly, when you find yourself turning any gain control to an extreme setting, be aware of what that may be doing to noise levels. Stop and ask yourself where you are in your system's gain structure and how far you're deviating from the nominal gain point. This may seem a bit imposing at first, but it gets to be second nature, and there's a real payoff in quieter finished products.

IDENTIFYING OTHER NOISE SOURCES

GROUND LOOPS

It's beyond the scope of this article to thoroughly explore proper grounding techniques, but you should learn to recognize when you've created a ground loop. Your system will alert you by emitting a steady hum. Actually, almost every real-life installation has numerous ground loops but they don't present much of a problem because the voltage differentials between various ground points aren't far enough apart to wreak havoc. When you do run into a hum problem that you think may be the result of grounding, try the following procedures. First, disconnect the inputs of the unit and listen to its output again to see if the problem has disappeared. If it has, the noise source was either in the prior unit or there is a loop between the two units. If the noise is still there, try isolating the chassis of the unit from ground; this may involve momentarily disconnecting the AC power ground and/or removing the chassis from the rack. (Do not make a practice of disconnecting AC grounds as an easy fix—you could create a dangerous situation.) If the unit continues to hum even when there is only one ground connected to it—the output ground in this case—then the unit may be broken or suffer from a design flaw. Removing it to the test bench will confirm this. If you determine that a ground loop is causing your hum problem, you may need to restructure your grounding approach or implement a balanced transmission system, which will allow you to disconnect common signal shields.

RF INTERFERENCE

Another type of noise which people commonly describe as hum is actually the sync noise of television transmitters. It has a raspier buzz to it than the smooth hum of a ground loop, and you will encounter it more often if your studio is located close to a TV transmitter. Aside from good external cabling practice, there isn't a great deal you can do about this noise, since it will manifest itself most often in poorly designed equipment. If you live and work in an area that is saturated by RF signals, pick your equipment carefully.

CONCLUSION

I've touched upon a few of the noise sources that pollute your recordings; some are out of your control, and some can be minimized with good practice. Learning to differentiate between various types of noise and locate their source will serve you well in achieving that clean final mix that you're after.

Editorial

THIS ISSUE presents two articles on the audio work that went into making Liberty Weekend the spectacular success it was. Our first article is written by Larry Estrin, who was Director of Telecommunications and Sound for the Statue of Liberty/Ellis Island Foundation. And what a job he turned in. Spectacular audio is the only way to describe the twenty-six hours of live television and sound reinforcement work installed around New York this past July!

We also want to comment that in watching much of the events on TV, we were distressed to see little credit being given to the audio people, and only after the closing ceremonies, did even Larry Estrin's name rapidly scroll by. Fortunately, his article rights these wrongs, all done while giving an overview to the audio goings-on during those twenty-six hours.

Our regular columnist, Bruce Bartlett, has contributed a technical discourse on the speakers and amplifiers used for the closing ceremonies. This serves to clarify the two fine engineering drawings Larry Estrin was able to send us.

Thanks also must go to ABC, and Peter Murray of their Photo Publicity Department in New York, for the cover shot and several inside photos, all supplied at short notice.

Finally, you may be reading this page for the first time from an issue you've picked up at the Audio Engineering Society's Convention in Los Angeles. That means you've probably seen us in booth 936.

LZ

THE 81ST CONVENTION OF THE AUDIO ENGINEERING SOCIETY—

LOS ANGELES
CONVENTION CENTER &
THE LOS ANGELES HILTON



THE ONLY U.S. AUDIO
EVENT OF 1986! EXHIBITS,
WORKSHOPS, TECHNICAL
PAPERS AND TOURS, & MORE.

THE AUDIO ENGINEERING SOCIETY
60 EAST 42ND STREET—RM. 2520
NEW YORK, NY 10165 (212) 661 2355

LOS ANGELES, CA.
NOV. 12-16, 1986

Listening In On Liberty Weekend

The inside story on seventeen and a half hours of broadcasting for Liberty Weekend.

THIS PAST summer, over the long fourth of July weekend, the ABC Television Network and thirty-three other world broadcasters televised seventeen and one half hours of live spectacular entertainment produced by David L. Wolper in celebration of the rededication of the Statue of Liberty.

Liberty Weekend was a celebration which included six major show sites in New York and New Jersey and ten supplementary show sites. Each one of the shows was unique; however, they were all tied together with the Weekend theme of "Remember-Rejoice-Renew."

David Wolper selected several world class producers, each renowned for their past achievements, to line produce the six major entertainment events. These producers included: Dwight Hemion and Gary Smith—Opening Ceremonies; Walter Miller—The Americana Music Concert; Tommy Walker—The Fireworks Spectacular; David Griffiths—The International Concert in the Park; Don Olhym-

er—The Sports Spectacular, and Don Misher—The Closing Ceremonies.



Photo by Steve Fenn/ABC News.

The audio system for each of the show sites had many technology-based items in common. These elements have become standard operating procedure for the primary

suppliers of professional sound reinforcement and remote recording facilities in the United States and throughout the world.

The strict adherence to the isolated power source and single point ground principals is a pivotal key to a clean installation, whether temporary like Liberty Weekend or permanently installed in a recording or television studio.

The ability to provide independent "mixes" to television, radio, house pa, and monitors is another key. This is accomplished by "splitting" all required production microphones with a splitter transformer that does *not* color the sound produced at the output of the microphone. The transformers that we specified for Liberty Weekend were Jensen. We also specified that any sub-mix be split with a high level Jensen transformer, if an auxiliary direct output of the sub mixer was not available.

I learned from my experience as Sound Director for the Los Angeles Olympics, that David Wolper, as Executive Producer, put more emphasis on the overall *LOOK* than on the absolute need for a particular speaker at a desired location. Engineered design compromises with the art department greatly enhanced the ability of the show's engineers to operate under the constraints of the producer.

Our team worked very closely with the production art department to incorporate correct microphone and speaker locations into the set design. The planning of Liberty Weekend started seven months before showtime, yet the technicians who are mentioned in this article were at the various show sites for an average of less than ten days each.

The key element of communications for audio was addressed early in the planning stages. It was obvious that wireless communications would be necessary for the audio mixers and A-2s. It was also just as obvious that wireless microphones were going to be used in large quantities and that a coordinated effort would be required to allocate available spectrum.

I worked very closely with the FCC, SIRSA, Systems Wireless, The New York Network Coordinations Committee, and ABC Radio. With very few exceptions we were able to use, on an interference-free basis, over 100 frequencies in three different spectrum areas. The major problems with unauthorized users were controlled by over thirty FCC staff engineers supporting all of the Liberty Weekend users, including the police departments, FBI, military, and our own security.

The show production intercommunication facilities at each of the venues was primarily RTS and Clear-Com. Best audio provided the extensive systems at the Opening Ceremonies and Closing Ceremonies, which included facilities at Liberty Island, Ellis Island and Governors Island. The hardware at the other sites was provided by the video facilities vendors—Unitel, TCS, and EJ Stewart.

The need for enormous amounts of cable to interconnect the audio and communications elements was met with an absolute minimum of failures. Each of the audio and video vendors provided cable and cable systems. Any cable system augmentation beyond a vendor's capabilities was accomplished by Wireworks and Alpha Cable Corp.

All of the wireless microphones and RF Stagemanager systems were manufactured by Cetec Vega and provided by Systems Wireless. Ted Bennett, Bill Sien, Steve Barbar, Benny Vinh, and How Weinshank of Systems Wireless set up a complete RF support shop at the show sites and provided on-site engineering support to each show.

Another key element in the smooth operation of the shows was the location of the monitor mixers. In the Opening and Closing Ceremonies the mixer was included in the orchestra, as if he were a musician, thereby affording him an almost ideal mix location, not buried out of direct hearing and sight. The house mix locations were chosen with care and concern for access, security and cable route.

All sound systems were equalized with 1/3 and 1 octave graphic equalizer. Some time was allocated by the various associate producers, in the master schedules for system equalization, usually after most of the rehearsing performers and crew had left. This is an area that needs a greater significance attached to it in the future. The producers that we all work for need to understand that a properly tuned system will lead to better performances by an artist, and subsequently to a better on air product.

Functionally, the on-air program which you viewed at home was a mixture of elements switched at ABC TV's "TV-1" in New York. The Liberty Weekend producers had line responsibility for the entertainment elements of each production. Boone Arledge and Roger Goodman from ABC coordinated the actual broadcast elements with "commentary" by Peter Jennings and Barbara Walters and the other talent ABC provided for "color."

ABC Radio broadcasted mono and stereo audio of all Liberty Weekend events to various parts of the United States and also distributed the audio throughout the world.

The Opening Ceremonies were staged on the southern tip of the United States Coast Guard Station at Governors Island, New York. The entire show site was a temporary facility specifically designed, constructed, and geographically located to enhance the viewer's enjoyment of the Opening Dedication Ceremony on the night of July third.

The Audio Engineer responsible for all television broadcast was Doug Nelson. Doug was assisted by Norm Schwartz and utilized the facilities of Record Plant Studios in New York, with Kooster McAllister acting as the Chief Audio Maintenance Engineer.

The unique elements contained in this show were numerous. They included a sixty-five piece orchestra under the direction of Ian Fraser and John Williams, and the performing talents of Neil Diamond and Frank Sinatra. The event also included the performance of 120 members of the Statue of Liberty All-American Marching Band as well as remarks by President Ronald Reagan and President Françoise Mitterand. The show also included remote segments from several cities through out the United States and a "local" remote on Ellis Island. The orchestral music heard by the television audience was a combination of pre-record and live.

During the pre-production phases of the weekend, over 100 hours were spent pre-recording and mixing down the various taped musical elements of the show at the RCA Recording Studios in New York. On the other hand, all of the play-ons, play-offs, fanfares, and the Frank Sinatra performance were performed "live." In order to closely match the sound of the pre-record, each of the instruments was individually mic'ed with a dynamic microphone. All of the microphones had triple wind screens. The microphones utilized were primarily Electro-Voice RE 18s, and some experimental Electro-Voice mics as well as the old standbys, Shure SM56 and SM58 microphones.

The sound reinforcement and monitor system was provided by Burns Audio, with Bruce Burns and Steve Kibbons

mixing the house and monitors respectively. The audio assistants on the Opening Ceremonies were Klaus Land-sburg, Larry LaSota, Mark Webber, Bob Aldrich, Steve Huntley, and Greg Watkins. Scott Douglas was the representative from the White House Communications Agency. The system design was incorporated into the set design by my staff in the Telecommunications and Sound Department of Liberty Weekend. The stage was over 180 feet wide and seventy-five feet deep. The audience of 3500 was seated in a semi-circular grandstand with "deck chairs."

The following morning the same stage was utilized for the Operation Sail event, which featured a major address by President Reagan and a review of the Tall Ships. This event was engineered by David "db" Brown from ABC Television, New York. The audio from this event was fed as a pool to all broadcasters who wanted it as this was not an exclusive ABC show. The facilities utilized for the audio pool were provided by Unitel and Best Audio. The sound reinforcement and monitor mixing was by Steve Kibbons.

Early in the evening on July fourth, John Williams and the Boston Pops performed at Liberty State Park for an audience of over 35,000 plus a thousand more around the park in boats. In contrast to the Opening Ceremonies this performance by the 110 piece Pops Orchestra was all "live." The show was engineered by Bob Lifton, assisted by Scotty Schacter. The sound reinforcement system was provided by Maryland Sound and mixed by Jim Showker. The remote audio facilities were provided by Dave Hewitt and Remote Recording Services. The ABC Radio Network provided a simulcast stereo audio signal of this concert, coordinated by Kent Coughlin, Dick Martinez, and Mark Kalman of ABC Radio, New York.

Immediately after the Americana Concert in Liberty State Park, President Reagan introduced the International Fireworks Spectacular from the flight deck of the USS John F. Kennedy, in the lower harbor, south of the Statue of Liberty. The show on board the Kennedy, which included the percussion section of the Liberty Weekend Marching Band and the United States Marine Band was handled by Robert Estrin, with coordination from the White House Communications Agency by Tom Sanchez.

The actual fireworks music was recorded at the US Navy "Sail Loft" Studios in Washington, D.C., and mixed at the RCA Studios in New York by Dennis Ferrante. The musical selections were arranged by Joe Raposa, who also wrote several new pieces to bridge the music into one continuous twenty-seven minute performance, which was synchronized and choreographed with the fireworks by Tommy Walker and his chief fireworks consultant, Gene Evans. I was the technical director for this particular event which was seen and heard live by several million people in the lower Manhattan area from the Brooklyn Promenade and the east shore area of New Jersey. The television audio and stereo simulcast by WPLJ-FM, an ABC affiliate, was engineered in the Record Plant truck by Doug Nelson with Kooster McAllister assisting. The radio engineering was done by Jim McGuire. Through the Liberty Weekend Telecommunications Department, we coordinated over twenty-five sound systems, which were provided by Theatre Technology, Sound Associates, Maryland Sound, Bose Corporation, Sound by Paul and radio station WPLJ. The coordinated live broadcast of the synchronized audio and fireworks greatly enhanced the viewing pleasure of the millions of people who saw the show live. The television coverage, which was not exclusive to ABC, utilized over 150 cameras at over 100 different viewing locations.

On the morning of the fifth of July, the formal dedication ceremony took place on Liberty Island, at the Statue of Liberty courtyard. The ceremony featured live performances by the Boys Choir of Harlem, the Paris Boys Choir, and the Garfield Cadets Drum and Bugle Corps. All the performances were live and were engineered and mixed by Robert Estrin. The audio and sound system facilities were provided by Electro-Voice. The feeds were distributed to several hundred representatives of the press to be used as news inserts.

In the evening, the New York Philharmonic Orchestra, directed by Zubin Mehta, performed before the largest audience ever assembled in New York for any concert. The New York Police Department estimated the audience at over 850,000. The television air mix, which was all live, was engineered by Aaron Baron, in the Mobile Audio remote truck. The sound reinforcement was provided by Maryland Sound and mixed by Abe Jacob.

On Sunday afternoon, indoors at the Byrne Arena David Wolper staged the sports salute to the Statue. All of the music for this event was pre-recorded. The ABC Audio Engineer was Ron Cronkite, assisted by Fred LaTour. Steve Huntley mixed the sound reinforcement, utilizing the house PA system.

The final, and most industrious event was the Closing Ceremonies at the Meadowlands Giants Stadium. The complex audio engineering was directed by Ed Greene, utilizing the Greene, Crowe and Co. facilities. The sound reinforcement system was provided by Maryland Sound with the assistance of the generous loan of microphones and constant directivity horns from Electro-Voice with amplifiers provided by Crown International and digital delay by Klark Teknik. The sound system was mixed by Dave "Snake" Reynolds. Ed Greene was assisted by Keith Hall.

The forty-five piece Closing Ceremonies Orchestra played all of the play-ons and play-offs live with all other elements of the show pre-recorded. The recording and mixdown was done at Regent Sound in New York.

This show also contained the spectacular Liberty Weekend 550 piece Marching Band, directed by Dr. Art Bartner. The audio pickup of the Marching Band was accomplished with strategically placed Sennheiser shotgun microphones. The instruments for the Band were provided by Yamaha and all of the Marching Band Show elements were live.

The Closing Ceremonies were somewhat unique in that this was only the third time that an entertainment event has been staged in a stadium, that simultaneously utilized a stage in the center of the field, with a surround type speaker system and then a more conventional end zone stage with a point source sound system. The center stage was motorized and moved into its primary operating position while Patti LaBelle was performing a vocal live to a pre-recorded track. The stage included its own monitor system for the performers.

As the Director of Telecommunications and Sound for all of the Liberty Weekend events I applaud the professional manner in which each individual engineer and technician performed their individual tasks. At each show site they worked as a team to provide the live audiences and half a billion viewers throughout the world with quality audio. There are several individuals whom I would like to give special credit to: Mr. Jim Seiter, who provided all the documentation for each site; Mr. Tom Durell, who worked on the telephones and coordinated the Giant Stadium installation, and to Bob Wolf, a volunteer, who assisted us in equipment control, recording, and coordination. ■

Audio At The Liberty Weekend Closing Ceremonies

THE FOURTH of July weekend marked the celebration of the restored Statue of Liberty. Part of the festivities was the Giant Stadium Closing Ceremonies, the gala finale of the whole weekend. It was an enormous show featuring big-name singers, hundreds of dancers, a 500-piece marching band, an orchestra, and two 400-voice choirs. The event was broadcast live.

Dave Reynolds, house mixer and system designer for the Closing Ceremonies and engineer for Maryland Sound Industries, gave us this information on the sound-reinforcement system:

Design of the system was supervised by Tom Durrell. It employed sixty-five Crown Micro-Tech 1200-LX amplifiers and 65 600-LX amplifiers. Each amp was set to mono mode and drove a 4-ohm load.

The speakers were Maryland Sound NW-2's. Fifty-four speaker cabinets covered the audience. These speakers included twenty-two cabinets on the football field in separate locations, with speakers on fourteen separate delay lines. The delays were varied according to the location of the show.

The NW-2 speakers are two-way units, and had EV 40-degree radials on top aimed at the upper decks (a 240-foot throw). Sixteen JBL long-throw horns were mounted over the fifteen-yard line on a rectangular truss, 8 ft x 10 ft, 65 ft wide, and 45 ft high.

Six cabinets were built into the stage, and tensubwoofer cabinets were built into the stage perimeter.

Greene, Crowe, & Co. did the audio and video for the radio and television broadcasts. ABC network hired the company as a facility; the company leased their audio/video truck to ABC for the event. Ed Greene, a freelance audio engineer and Director of Audio Engineering for the company, described the broadcast audio system as follows:

Inside the large mobile TV production trailer, Ed mixed the audio portion of the show using an Audiotronics 750

console. Otari MX-5050 machines were used for playback. The syndicated live radio broadcast was in stereo; the TV portion was broadcast mono.

Almost all the music was pre-recorded. The live orchestra at the stadium never played. The marching band did play live, however.

Most solo singing was done live, using twelve wireless mics supplied by Systems Wireless. These microphones were Vega Dynex 2 units with large diversity receivers. Podium mics were Schoeps. Countryman microphones were used over the live choir, while Sennheiser and Schoeps shotgun mics covered the audience and field.

No artificial sweetening was added. A slight amount of reverb was mixed in as needed.

The broadcast-audio crew experienced no problems, except that rehearsal time was limited due to costs. Some elements of the show had no rehearsal except with stand-ins. Still, the show went "very smoothly" primarily because, Ed said, he had the right people and good communications among them. He pointed out that Don Mischer, producer/director, "did a wonderful job and was very well organized."

Ed had a script to go by for setting console changes. When he came up on a situation using a lot of RF mics, another person previewed the mics to make sure they were functional. There were two or three backup plans to use in the event of any failure.

Ed said he was backed up by "an excellent crew on the field." These people were Murray Siegal, Jeff Fecteau, Bart Chiate, Gene Richards, Joe Kendall, and Paul Sandweiss. Keith Hall did audio-systems maintenance, and Bob Tourkow ably handled the communication systems.

In response to the question, "How did you handle the pressure of doing this nationwide live event?", Ed replied that he worked well under pressure and enjoyed doing jobs like that. ■

Condensed Guide To SI Units And Standards

THE FOLLOWING is a highly condensed guide to SI units, standard usage and numerical notation for the benefit of people who have occasion to write specifications or technical literature of any kind.

The abominable disregard for (literary and verbal) communication standards even among engineers and highly skilled technicians makes for needless confusion, ambiguity and duplication of effort.

Let's review the world standard means and methods for expressing the terms and use them to codify our jargon and simplify our communications.

SI UNITS, STANDARDS AND NOTATION

All the way back in 1866, the Metric System of units was legalized by the US government for trade in the United States.

In 1960, the international "General Conference on Weights and Measures" met in Paris and named the metric system of units (based on the meter, kilogram, second, ampere, kelvin and candela) the "International System of Units." The conference also established the abbreviation "SI" as the official abbreviation to be used in all languages.

The SI units are used to derive units of measurement for all physical quantities and phenomena. There are only seven basic SI "base units." These are:

NAME	SYMBOL	QUANTITY
ampere	A	electric current
candela	cd	luminous intensity
meter	m	length
kelvin	K	thermodynamic temperature
kilogram	kg	mass
mole	mol	amount of substance
second	s	time

The SI derived units and supplementary units are listed here with applicable derivative equations:

NAME	SYMBOL	QUANTITY	DERIVED BY
coulomb	C	quantity of electricity	A · s
farad	F	capacitance	A · s/V
henry	H	inductance	V · s/A
hertz	Hz	frequency	s ⁻¹
joule	J	energy or work	N · m
lumen	lm	luminous flux	cd · sr
lux	lx	illuminance	lm/m ²
newton	N	force	kg · m/s ²
ohm	(upper case omega)	electric resistance	V/A
pascal	Pa	pressure	N/m ²
radian	rad	plane angle	
steradian	sr	solid angle	
tesla	T	magnetic flux density	Wb/m ²
volt	V	potential difference	W/A
watt	W	power	J/s
weber	Wb	magnetic flux	V · s

Drew Daniels is the Applications Engineer for JBL Professional, a company which manufactures loudspeaker components and speaker systems and distributes professional audio equipment under the JBL, UREI, and Soundcraft names.

NAME	SYMBOL	QUANTITY
ampere per meter	A/m	magnetic field strength
candela per square meter	cd/m ²	luminance
joule per kelvin	J/K	entropy
joule per kilogram kelvin	J/(kg·K)	specific heat capacity
kilogram per cubic meter	kg/m ³	mass density (density)
meter per second	m/s	speed, velocity
meter per second per second	m/s ²	acceleration
square meter	m ²	area
cubic meter	m ³	volume
square meter per second	m ² /s	kinematic viscosity
newton-second per square meter	N·s/m ²	dynamic viscosity
1 per second	s ⁻¹	radioactivity
radian per second	rad/s	angular velocity
radian per second per second	rad/s ²	angular acceleration
volt per meter	V/m	electric field strength
watt per meter kelvin	W/(m·K)	thermal conductivity
watt per steradian	W/sr	radiant intensity

DEFINITIONS OF SI UNITS

(The wording used by the Conference may seem a bit stilted, but it is carefully chosen for semantic clarity to make the definitions unambiguous.) The ampere is that constant current which, if maintained in two straight parallel conductors of infinite length, of negligible circular cross section, and placed one meter apart in vacuum, would produce between these conductors a force equal to 2E-7 newton per meter of length.

The candela is the luminous intensity, in the perpendicular direction, of a surface of 1/600,000 square meters of a blackbody at the temperature of freezing platinum under a pressure of 101,325 newtons per square meter.

The coulomb is the quantity of electricity transported in one second by the current of one ampere.

The farad is the capacitance of a capacitor between the plates of which there appears a difference of potential of 1 volt when it is charged by a quantity of electricity equal to one coulomb.

The henry is the inductance of a closed circuit in which an electromotive force of one volt is produced when the electric current in the circuit varies uniformly at a rate of one ampere per second.

The joule is the work done when the point of application of one newton is displaced a distance of one meter in the direction of the force.

The kelvin, the unit of thermodynamic temperature, is the fraction 1/273.16 of the thermodynamic temperature of the triple point of water.

The kilogram is the unit of mass; it is equal to the mass of the international prototype of the kilogram. (The international prototype of the kilogram is a particular cylinder of platinum-iridium alloy which is preserved in a vault at Sevres, France, by the International Bureau of Weights and Measures.)

The lumen is the luminous flux emitted in a solid angle of

one steradian by a uniform point source having an intensity of one candela.

The meter is the length equal to 1,650,763.73 wavelengths in vacuum of the radiation corresponding to the transition between the levels 2p sub 10, and 5d sub 5 of the krypton-86 atom.

The mole is the amount of substance of a system which contains as many elementary entities as there are carbon atoms in 12 grams of carbon 12. The elementary entities must be specified and may be atoms, molecules, ions, electrons, other particles or specified groups of such particles.

The newton is that force which gives to a mass of 1 kilogram an acceleration of 1 meter per second per second.

The ohm is the electric resistance between two points of a conductor when a constant difference of potential of one volt, applied between these two points, produces in this conductor a current of one ampere, this conductor not being the source of any electromotive force.

The radian is the plane angle between two radii of a circle which cut off on the circumference an arc equal in length to the radius.

The second is the duration of 9,192,631,770 periods of the radiation corresponding to the transition between the two hyperfine levels of the ground state of the cesium-133 atom.

The steradian is the solid angle which, having its vertex in the center of a sphere, cuts off an area of the surface of the sphere equal to that of a square with sides of length equal to the radius of the sphere.

The volt is the difference of electric potential between two points of a conducting wire carrying a constant current of one ampere, when the power dissipated between these points is equal to one watt.

The watt is the power which gives rise to the production of energy at the rate of one joule per second.

The weber is the magnetic flux which, linking a circuit of one turn, produces in it an electromotive force of one volt as it is reduced to zero at a uniform rate in one second.

SI PREFIXES

The names of multiples and submultiples of any SI unit are formed by application of the prefixes:

MULTIPLIER	PREFIX	SYMBOL	TIMES 1, IS EQUAL TO:
10 ¹⁸	exa	E	1 000 000 000 000 000 000
10 ¹⁵	peta	P	1 000 000 000 000 000
10 ¹²	tera	T	1 000 000 000 000
10 ⁹	giga	G	1 000 000 000
10 ⁶	mega	M	1 000 000
10 ³	kilo	k	1 000
10 ²	hecto	h	100
10	deka	da	10
0	—	—	1 (unity)
10 ⁻¹	deci	d	.1
10 ⁻²	centi	c	.01
10 ⁻³	milli	m	.001
10 ⁻⁶	micro	u	.000 001
10 ⁻⁹	nano	n	.000 000 001
10 ⁻¹²	pico	p	.000 000 000 001
10 ⁻¹⁵	femto	f	.000 000 000 000 001
10 ⁻¹⁸	atto	a	.000 000 000 000 000 001

Some examples: ten-thousand grams is written as 10 kg, 20,000 cycles per second is written as 20 kHz, 10-million hertz is written as 10 MHz, and 250 billionths of a weber per meter of magnetic flux is written as 250 nWb/m. Always use less than 1000 units with an SI prefix; "1000 MGS" is advertising hyperbole and should be written "1 g" only.

SI prefixes and units should be written together and then set off by a space (single space in print) from their numerators. For example, use the form "35 mm" instead of "35mm" and "1 kHz" instead of "1k Hz."

When writing, use standard SI formats and be consistent. You can consult National Bureau of Standards publication 330, (1977) for details on usage.

Never combine SI prefixes directly. That is, write 10^{-10} farads as 100 pF instead of 0.1 micro-microfarads (uuF). Keep in mind that whenever you write out a unit name longhand, the rule is that the name is all lower case, but when abbreviating, the first letter is upper case if the unit is named after a person, and lower case if it is not. Some examples: V equals volt for Volta, F equals farad for Faraday, T equals tesla for Tesla, and so on. Letter m equals meter, s equals second, rad equals radian, and so on. Revolutions per minute may be written only as r/min, miles per hour may be written only as mi./hr, and inches per second may be written only as in./s and so on.

In addition to the correct upper and lower case, prefixes and combinations, there is also a conventional text spacing for SI units and abbreviations. Write 20 Hz, rather than 20Hz. Write 20 kHz, rather than 20k Hz, and so on. Always separate the numerator of a unit from its prefix and/or unit name, but do not separate the prefix and name.

The International Organization for Standardization (ISO) recommends the following rules for the use of SI prefixes:

A) Prefix symbols are printed in roman (upright) type without spacing between the prefix symbol and the unit symbol.

B) An exponent affixed to a symbol containing a prefix indicates that the multiple or sub-multiple of the unit is raised to the power expressed by the exponent. For example:

$$1 \text{ cm}^3 = 10^{-6} \text{ m}^3$$

$$1 \text{ cm}^{-1} = 10^2 \text{ m}^{-1}$$

C) Compound prefixes, formed by the juxtaposition of two or more SI prefixes, are not to be used. For example:

$$1 \text{ pF} \text{ but not: } 1 \text{ uuF}$$

The International Organization for Standardization (ISO) has issued additional recommendations with the aim of securing uniformity in the use of units.

According to these recommendations:

A) The product of two or more units is preferably indicated by a dot. The dot may be dispensed with when there is no risk of confusion with another unit symbol, For example:

$$N \cdot m \text{ or } N \text{ m} \text{ but not: } mN$$

B) A solidus or oblique stroke (/), a horizontal line, or negative powers may be used to express a derived unit formed from two others by division.

For example:

$$m/s, \text{ or } m \cdot s^{-1}$$

C) The solidus must not be repeated on the same line unless ambiguity is avoided by parenthesis. In complicated cases, negative powers or parenthesis should be used.

For example:

$$m/s^2 \text{ or } m \cdot s^{-2} \text{ but not: } m/s/s$$

$$m \cdot kg/(s^3 \cdot A) \text{ or } m \cdot kg \cdot s^{-3} \cdot A^{-1}$$

$$\text{but not: } m \cdot kg/s^3/A$$

SCIENTIFIC AND ENGINEERING NOTATION

(NOTE: "E" stands for power of ten exponent.)

Scientific notation is used to make big and small numbers easy to handle.

Engineering notation is similar to scientific notation except that it uses thousands exclusively, rather than tens like scientific notation.

The number 100 could be written 1E2 ($1 \cdot 10^2$) or 10^2 in scientific notation, but would be written only as 100 in engineering notation. The number 12,000 would be written 1.2E4 ($1.2 \cdot 10^4$) in scientific, and written 12E3 ($12 \cdot 10^3$) in engineering notation. Here is a partial listing of possible Scientific and Engineering notation prefixes:

SCIENTIFIC	=	ENGINEERING	SCIENTIFIC	=	ENGINEERING
10^{-18}	=	1 a	10^1	=	10
10^{-17}	=	10 a	10^2	=	100
10^{-16}	=	100 a	10^3	=	1 k
10^{-15}	=	1 f	10^4	=	10 k
10^{-14}	=	10 f	10^5	=	100 k
10^{-13}	=	100 f	10^6	=	1 M
10^{-12}	=	1 p	10^7	=	10 M
10^{-11}	=	10 p	10^8	=	100 M
10^{-10}	=	100 p	10^9	=	1 G
10^{-9}	=	1 n	10^{10}	=	10 G
10^{-8}	=	10 n	10^{11}	=	100 G
10^{-7}	=	100 n	10^{12}	=	1 T
10^{-6}	=	1 u	10^{13}	=	10 T
10^{-5}	=	10 u	10^{14}	=	100 T
10^{-4}	=	100 u	10^{15}	=	1 P
10^{-3}	=	1 m	10^{16}	=	10 P
10^{-2}	=	10 m	10^{17}	=	100 P
10^{-1}	=	100 m	10^{18}	=	1 E
10^0	=	1	10^{19}	=	10 E
			10^{20}	=	100 E

Engineering notation is used by default when we speak because the numerical values of the spoken names of SI prefixes run in increments of thousands such as; kilohertz, microfarads, millihenrys and megohms (pronounced "megohms"). The spoken term "20 kilohertz" is already in engineering notation, and would be written on paper as 20E3 ($20 \cdot 10^3$) hertz in strict engineering notation and as 2E4 ($2 \cdot 10^4$) in scientific notation if it were not written in the more familiar form, 20 kHz.

In either case, scientific or engineering, the rule is: for numbers greater than one, the En part of the figure indicates the number of decimal places to the right that zeros will be added to the original number. For numbers smaller than one, the E-n part of the figure indicates the number of decimal places to the left of the original number that the decimal point itself should be moved. The small "n" and "-n" here stand for the digits in the exponent itself.

A definitive pamphlet describing SI units, conversions between SI units, older CGS and MKS units and units outside the SI system of units is available in the form of NASA Publication SP-7012, (1973). Inquire to the US Government Printing Office in Pueblo, Colorado or in Washington, DC for this and other publications about SI units, their use and history. ■

Control Room Design Incorporating RFZ, LFD And RPG Diffusors

Here we explore the reflection-free zone, sound diffusion, low frequency diffusion, and the advantages of a typical RFZ/RPG reference monitoring room.

INTRODUCTION

SMALL ROOMS, such as recording control rooms with a volume less than 8,000 square feet, generally lack adequate sound diffusion over an appreciable bandwidth and are affected by modal frequency resonances and spatial pressure variations. Therefore, in the design of control rooms the need for highly efficient broad-bandwidth wide-angle diffusive surfaces and modal modification is acute. The discovery (1) and development (2-29) of reflection-phase grating acoustical diffusors (RPG®) has made it possible to easily correct these problems. This article is divided into four parts:

• **The Reflection-Free Zone-RFZ®.** A brief review will be presented for the necessity of creating a reflection-

free zone surrounding the mix position, to provide accurate stereo imaging and frequency response.

• **Sound Diffusion-RPG.** A design approach using RPG diffusors to create a diffuse sound field will be described. This allows the auditory system to fuse direct sound with indirect energy from the room, without corrupting stereo imaging or frequency response, while providing a heightened spatial impression and sense of envelopment.

• **Low Frequency Diffusion-LFD®.** The application of a new low frequency RPG diffusor, LFD, will be described. The LFD is optimized to provide effective low frequency diffusion in the near-field. It is used to minimize the low frequency interference between the direct and indirect reflected sound from the rear wall and provide modal modification.

• **Advantages of a typical RFZ/RPG reference monitoring room.** Psychoacoustics research (30-38) over the past twenty years, has provided many valuable clues as to how the auditory system binaurally perceives sound in a room. It seems prudent to follow these guidelines in designing a recording control room. The objective of music production in a recording control room is to either faithfully reproduce the frequency balance and spatial textures of a recording environment or to create, in post processing, a realistic or artificial sonic image with a prescribed spectral distribution and simulated spatial cues using effects processing. New 3-D sonic image processing techniques, such as Spatial Reverberation (30) are becoming more common in contemporary music and stereo TV. It is important to be able to perceive complex spatial images over two loudspeakers. The control room, as the name implies, should be neutral so that what is auditioned is not convoluted with acoustical idiosyncrasies of the room, allowing the musical product to be transferrable to other listening environments.

What is a neutral monitoring environment? I think the general consensus is that the extremes of an anechoic or reverberation chamber are not the answer. It is also important to recognize that a "good sounding" room and an accurate room are not mutually exclusive. What we have found to be effective is a room which is initially selectively anechoic, to allow the auditory system to accurately perceive spatial textures, followed by a broad-bandwidth diffuse sound field, that increases the binaural dissimilarity and provides a spatial impression with a heightened sense of envelopment.

db Wants You!

db is interested in what's going on out there in the way of smaller studios. If YOU are building, reconstructing, or adding a small studio we want to hear about it. Write to us at:
db Magazine, 1120 Old Country Rd., Plainview, NY 11803, or phone (516) 433-6530!

Our research has focused on effective ways to optimize both LEDE® (31) and conventional designs, by implementing a reflection-free zone (8, 39) over a wide area surrounding the mix position and creating a dense diffuse sound field using RPG diffusors. The RFZ is achieved by splaying massive speaker boundary surfaces, which can contain distributed absorption, thereby minimizing boundary reflections at the mix position. The RFZ permits the accurate binaural perception of pre-encoded spatial textures over a wide area, minimizes speaker-boundary interference frequency coloration caused by very early reflections, and allows the formation of an initial time delay gap (ITD) before the onset of indirect reflected energy. The diffuse sound field is created using RPG diffusors on the rear walls. The creation of an ITD, with the RFZ, allows the indirect energy reflection pattern to be sequenced at any arrival time desired, depending on the distance to the rear wall. Efficient coupling between specular surfaces on the walls, floor, and ceiling, and diffusive surfaces is critical in providing a uniformly dense reflection pattern, with a lack of special directional information. This creates a heightened spatial impression and sense of envelopment due to the low interaural cross correlation (37), which is a measure of the dissimilarity or incoherence between what the two ears binaurally perceive. The low frequency response is optimized through the use of a new low frequency diffusion system and/or low frequency absorption.

Among the many parameters used to evaluate a control room we would like to concentrate on three: stereo imaging, frequency response, and the spatial impression or envelopment. All are affected by the interaction of the direct sound and indirect reflected sound from the boundary surfaces of the room. Despite the electronic sophistication of a control room, sound must eventually travel the complex acoustic paths from the monitor speakers to the auditory system. Consequently, controlling the interaction between the direct and reflected sound is a critical factor in the acoustic design.

THE REFLECTION-FREE ZONE-RFZ

Stereo imaging is primarily affected by the monitor speaker design, the presence of very early reflections (less than 10 ms) and late intense specular reflections. Psychoacoustics research (30-38) suggests that the auditory system demands an RFZ at the mix position, where the predominant energy is from the speakers, because reflections cause frequency domain interference notches which mimic the head-related directional transfer functions (DTF) (30, 34). Consequently, the pseudo DTFs due to very early reflections compete with the pre-encoded DTFs and cause confusion in the auditory system and corruption of stereo imaging. Stereo imagery is sensitive to frequency domain notches in the 1-18 kHz range where the DTF notches, caused by coherent reflections from the outer ear and upper body, are most pronounced. This frequency range can easily be controlled by either an absorptive, reflective or absorptive/reflective RFZ (8,39). If speaker boundaries cannot be angled away from the mix position, then absorption can be used. The absorption can be strategically placed to minimize interfering specular reflections. Positions on the speaker boundary surfaces which need to be treated can easily be determined experimentally, by locating those positions at which an observer seated at the mix position would see a reflection of either speaker, when the surface is covered with a mirror. If one can re-configure the speaker boundaries, then the RFZ is that much more effective. Very

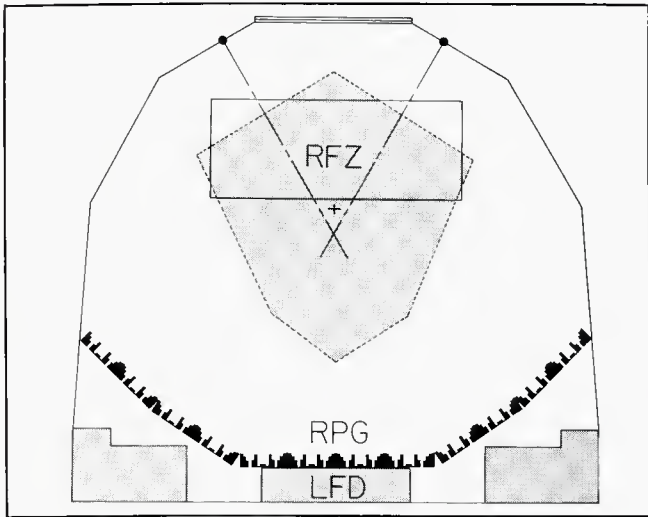

Figure 1A. Plan view of an RFZ/RPG control room with LFD. Limiting reflections from surface boundaries form a symmetrical six-sided RFZ.

early reflections can arise from the face of the speaker cabinet and the console. To minimize these problems, absorption can be placed on and around the face of the speakers, the console can be tilted and/or speaker height adjusted, and the console can be fitted with an absorptive/reflective hood. The RFZ also minimizes frequency coloration if we flush-mount the woofer as close as is physically possible to the trihedral corner formed by the splayed ceiling, front and side walls. This causes the first interference notch, which is the most difficult to control, to be raised into a frequency range where decreasing the reflection function, inclination factor and interference term described in the Kirchoff diffraction theory are optimally effective (8,40).

In *Figure 1* we show a plan and elevation of a typical control room utilizing the RFZ, RPG, and low frequency diffuser LFD which will be discussed later.

Sound Diffusion RPG: Once we have configured the front of the control room so that the predominant energy at all positions across the mixing console is the direct sound, we next turn our attention to creating a diffuse sound field using RPG diffusers on the rear walls. The RPGs reintroduce the energy passing the mix position after an ITD, temporally and spatially diffused. By varying the depth of the room the early energy reflection pattern can be sequenced at any arrival time desired and directionalized by orienting the hemidisc scattering pattern of the diffusers, *Figure 2*. The primary function of RPG diffusion is to: 1) provide a uniform high density of closely spaced reflections at the mix position, without any density gradients or discontinuities, 2) provide a dense pattern of uniformly distributed irregularly spaced frequency notches. The RPG insures that any inadvertent reflection combinations with slight time differences, which could result in broadband frequency anomalies, are minimized, 3) uniformly backscatter a broad frequency bandwidth over a wide angle, and 4) reduce the backscattered energy to minimize frequency coloration, resulting from interference with the direct sound, and image shifting.

Several researchers, most notably Haas (36), have described the ability of the auditory system to temporally fuse similar sounds within a time window (approximately 20 ms for program material) which depends on the nature of the source. It is this temporal fusion which allows us to

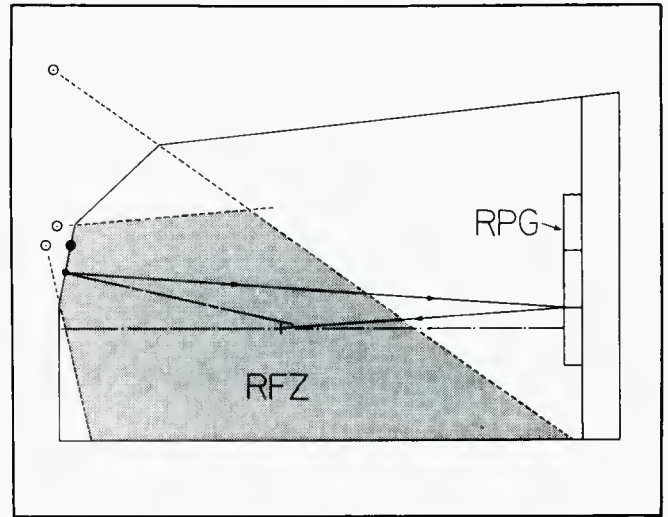

Figure 1B. Elevation for an RPG/RFG control room showing virtual sources (open circles) of woofer (large dot) from front wall, RFZ baffle and ceiling, which affect limiting RFZ reflections (dashed lines). Direction (solid line) of incident sound from the tweeter (small dot) and reflected sound from an RPG cluster is shown along with tweeter orientation (long-short dash).

blend the direct sound, early reflections, and reverberation into one louder and fuller event. Barron (32), Schroeder (1), Marshall (33), and others have observed that in addition to amplitude and temporal distribution, the directionality of early reflections is an important parameter affecting the binaural perception of music. Diffuse lateral reflections lead to greater binaural dissimilarity, an increased spatial impression and, therefore, higher listener preference.

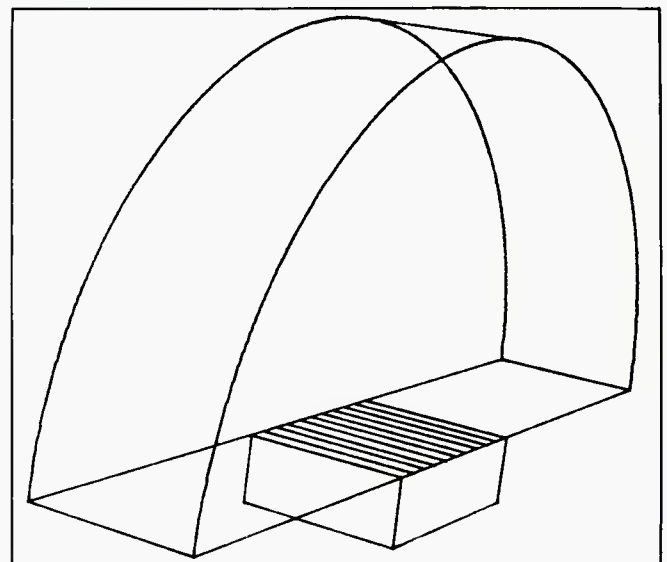

Figure 2. A diffuser and its hemidisc, which represents the backscattered energy distribution, are shown. The diffuse energy covering half space can be specularly directed by orienting the diffuser or the source.

Several criteria for establishing a spatial listening impression in concert halls using incoherent lateral early reflections have been established (37, 38). In control rooms, however, we do not want to introduce first order reflections from the front or sides of the room because we are not using the room, as in a concert hall, to create the spatial and spectral textures. These textures are generated in the recording studio, pre-encoded on tape, or created by effects processing. In addition, as we have mentioned, we do not

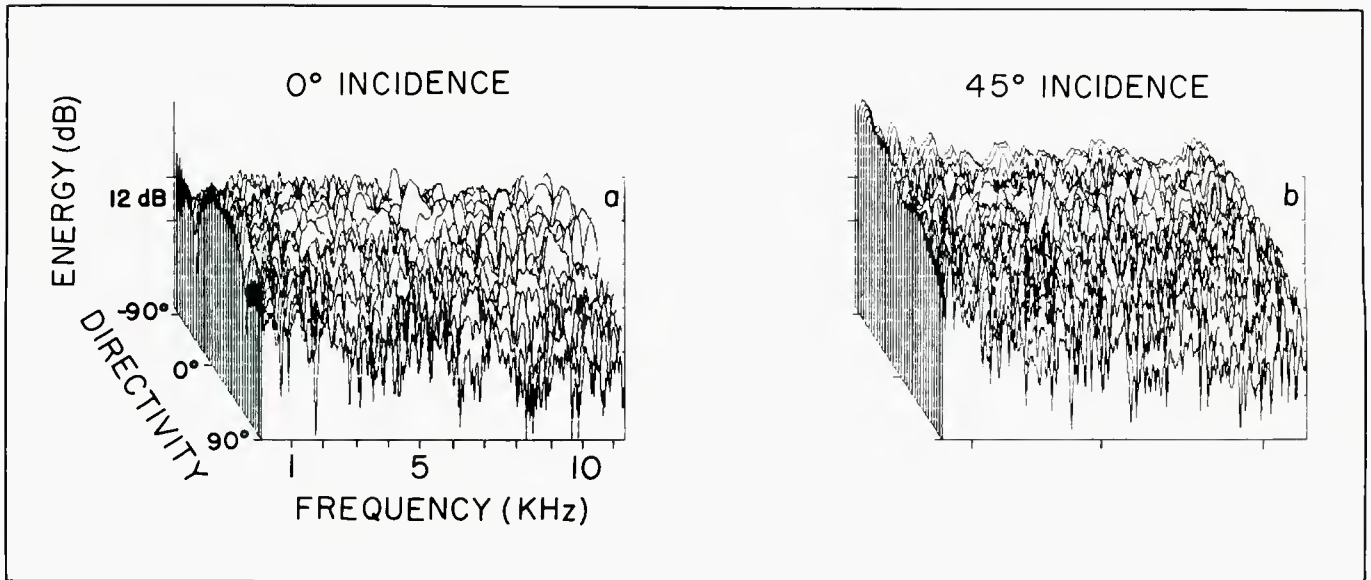

Figure 3. Left—The frequency response of a QRD[®] as a function of scattering angle (directivity) for zero degrees incidence. Right—forty-five degree incidence. Note the uniform polar sound diffusion over five musical octaves.

want the frequency coloration which accompanies delayed very early reflections. Since we are creating an RFZ surrounding the mix position we need to create a sensation of space using the delayed reflections initially from the rear and subsequently from all surfaces in the room. Since intense specular reflections create a strong directional impression by increasing the interaural correlation, we need to develop and utilize efficient sound diffusion surfaces.

ENTER THE RPG

Is there an optimum surface variation and associated phase variation which will uniformly scatter sound efficiently over a wide angular range and, just as importantly, over a broad frequency bandwidth? The answer is "yes" and the answer lays in the paradigm of pure mathematics—number theory. Number theory and modulo arithmetic are particularly applicable to sound wave interference because both involve fractions or residues. When sound waves interfere, fractional wavelengths (or the residue after dividing the path length difference by the wavelength) are important, because integral wavelength multiples are indistinguishable. Similarly, in modulo arithmetic, the remainder or residue after division by the modulus is important.

Over the past seven years we have built and tested numerous diffusors based on a wide variety of number-theoretic sequences, both one-dimensional (1-D) and two-dimensional (2-D). Figure 3 shows the 3-D time-energy-frequency (TEF) response and associated polar response for a quadratic-residue diffusor (QRD[®]) showing ideal uniform response over five musical octaves. One might think that if a 1-D diffusor is good, a 2-D diffusor, with a two-dimensional array of square wells of varying depths, is better. Let's consider the differences. In the far field the steady-state energy of a 1-D RPG is related to $1/N$, where N is the number of wells in a repeat unit and the energy is distributed into a hemidisc as shown in Figure 2. A 2-D RPG distributes energy into a hemisphere and the steady-state energy in the far-field is related to $1/N$. Both of these qualities of the 2-D RPG are potentially problematic. The

2-D surface causes appreciable attenuation, behaving as an absorber, and the hemispherical scattering is much harder to direct or orient where required. The 2-D surface is useful in noise abatement, since sound is scattered uniformly over half space with no preferred direction. We have found the most effective and reproducible way to create a useful diffuse sound field is using the 1-D RPGs.

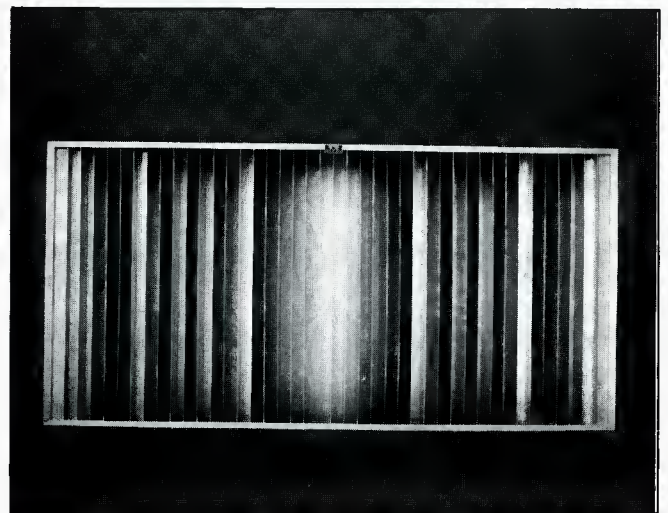

Figure 4. RPG model QRD-4311 with 43 1.1 inch wells per period. The unit is 23 7/8 " x 47 3/4 " x 15 7/8 " and weighs 60 lbs.

The RPG is the acoustical analog of a diffraction grating which has been used in the optical sciences for over one hundred years. Interestingly, nature provides us with three-dimensional gratings in the form of crystals. These 3-D periodic lattices scatter x-rays, which have a wavelength comparable to the distance between atoms, into directions and intensities related to the atomic structure of the crystal.

The 1-D RPG consists of a periodic grouping of an array of wells of equal width, but different depths, separated by thin



Figure 5A. Rear view of the control room at Tele-Image, Dallas, TX, showing upper and lower RPG clusters. Acoustical consultant Russell E. Berger-Joiner-Rose Group.

dividers (2). A QRD cluster is shown in *Figure 4*. The diffraction directions for each frequency are determined by the width of the repeat unit and the intensity in any direction is determined by the depth sequence within a period. The depths are based on mathematical number-theory sequences (1). At this time the quadratic-residue sequence appears to be the most effective.

In the latest designs we have investigated, the rear of the control room consists of reflective and 1-D RPG diffusive surfaces shown in *Figure 1*. This schematic is provided only as a guideline illustrating the concepts developed in this article. The reflective surfaces are positioned such that they do not reflect direct sound to the mix position, but rather, reflect direct sound to the diffusive surfaces. These specular surfaces act as delayed sound sources and further increase the reflection density at the mix position. If the side walls and the ceiling behind the mix position specularly feed the rear diffusors, the auditory system will perceive the first room reflections from the diffusive surfaces. Effective rooms can be designed with the rear wall approximately eight to twelve feet behind the mix position, providing the initial time delay and "open" ambiance of a much larger room. The backscattered energy is distributed into a hemidisc which is as thick as the height of the diffusive cluster. This hemidisc can be conveniently directed at the mix position by either moving the source or the RPGs. The optimum vertical position of the laterally diffusing RPG cluster (lower two tiers) on the rear wall is one which specularly directs the center of the diffuse scattered hemidisc back to the mix position. This ray is indicated with a solid line in *Figure 1B*. The upper tier of diffusors in *Figure 1B* are vertically diffusing, with wells running horizontally, and their height is not critical. A very simple installation procedure is to use a mirror to properly orient the center of the RPG cluster. While seated at the mix position, facing the diffusors, an assistant adjusts the height and/or tilt of a mirror, defining the face of the diffusors, until a reflection of the high frequency driver is visible. This assures proper orientation of the diffuse energy. Since intense specular reflections impart directional information, any portion of the rear of the room which is not treated with diffusive surfaces should either reflect or absorb energy away from the mix position. RPG diffused rear wall sections can be seen in *Figures 5A to 5D*.

The RPG was developed at Underground Sound Recording Studios in Largo, MD, and the first commercial installation was at the Oak Ridge Boy's Acorn Sound Recorders in

Hendersonville, TN. In the two years following Acorn, the RPG has been installed in numerous audio/video facilities around the world and has become a standard ingredient in architectural acoustic design. RPG diffuser users include: Shake Down Studios, NY, NY; TRC, Indianapolis, IN; Denny Jaeger Creative Services, Inc, Oakland, CA; Newbury Sound, Boston, MA; Emerald, Sound-Stage, and Masterphonics Recording Studios, Nashville, TN; Sigma Sound, NY, NY; Blue Jay Recording Studios, Carlisle, MA; 39th Street Music Production, NY, NY; Chicago Recording Company, Chicago, IL; Post Logic, Hollywood, CA; Promise Productions, Glendale, CA; Mastermix, Nashville, TN; Center City Studios, Chicago, IL; Pinetree Studios, Billerica, MA; New Age Sight & Sound, Atlanta, GA; Studio Southwest, Sunnyvale, TN; Streeterville Studios, Chicago, IL; Flite Three, Baltimore, MD; Grammie's House, Reno, NV; ARS Recording, Alsip, IL; Audio Matrix, Cambridge, MA; Chicago Trax Recording, *Figure 5C*, Chicago, IL; Megaphone, Portland, ME; On Broadway, NY, NY; Woodsend, Saratoga, NY; Premier Recording Studio, Washington DC; PMI, Pittsburg, PA; Jericho Recording Studio, Chicago, IL; Swanyard, Odyssey Studio Two, and Red Bus Studio Two, London, England; Chipping Norton Studio, Oxfordshire, England; Baby Records, Milan, Italy; Starmusik, Hamburg, Germany; E.J. Veale Associates-Lamorghini Records, Switzerland; Sounds Interchange and Deschamps Recording Studios, Toronto, Ca; Melody Recording, Rio Piedras, Puerto Rico; and White Swan, Guangzhou, China.



Figure 5B. Rear view of the control room at Master Sound Astoria in the Kaufman Astoria Film Studios, Astoria, NY, showing rear and side RPG diffusors. Acoustical consultant, Charles Bilello Associates.

In TV and post-production, NBC has incorporated the RPG into their stereo TV facilities in Burbank, New York City, and Brooklyn. Shows such as *The Cosby Show* and *Saturday Night Live* are benefiting from the technology. Arch Communications Corp. is using RPGs at WTIC-TV Hartford, CT. A six million, 32,500 square-foot facility in Dallas called Tele-Image, *Figure 5A*, has recently opened to serve this rapidly expanding market. Tele-Image employs the largest diffusive surface coverage of any control room in the world. On the west coast, the San Francisco Production Group is incorporating the RPG into their post-production facilities as is Digital Services, Houston, TX; Sheffield Audio/Video Productions in Phoenix, MD; Cameo Enterprises, NY, NY; Otis Conner Companies, Dallas, TX; Pran



Figure 5C. Rear view at Chicago Trax Recording, Acoustical consultant Doug Jones, Electro-Acoustic Systems, Inc. The LFD can be seen behind the RPG cluster.

Inc, New Braunfels, TX; Mogan Productions, Kansas City, MO; James Neel Productions, Carrollton, TX; Sound Images, Cincinnati, OH; Innervision Productions, St. Louis, MO; and the Welk Music Group, Nashville, TN; (ITFigure 5D). The RPG also forms an integral part of the design of RCA's Soundstream Digital Editing Suite in New York.

In film, Master Sound Astoria, *Figure 5B*, located in the Kaufman Astoria Film Studios, Astoria, NY, offers clients an advanced acoustical design in the control room and



Figure 5D. RPG rear wall at Welk Music Group, Nashville, TN. Acoustical consultant Bob Todrank, Valley Audio. A special corner LFD, shown in *Figure 8* is positioned behind the central RPG cluster.

studio, based around the RPG Diffusor System and the RFZ concept. Medallion Film Labs, Toronto, CA, is using the RPG in their film mix room and NFL Films has a new audio sweetening room utilizing the diffusors.

In radio, WFMT Radio, Chicago, IL, has modified its production rooms and is the first live symphonic broadcast facility to include the RPG, WBGO, Newark, NJ will employ the RPG for live jazz broadcasts. Numerous radio stations have incorporated the RPG in production control rooms and in voiceover booths to psychoacoustically increase their apparent size, such as WLLT, Cincinnati, OH; KMJQ, Houston, TX; WNKS, Columbus, GA; and the new Johns Hopkins University Public Radio facilities in Baltimore, MD.

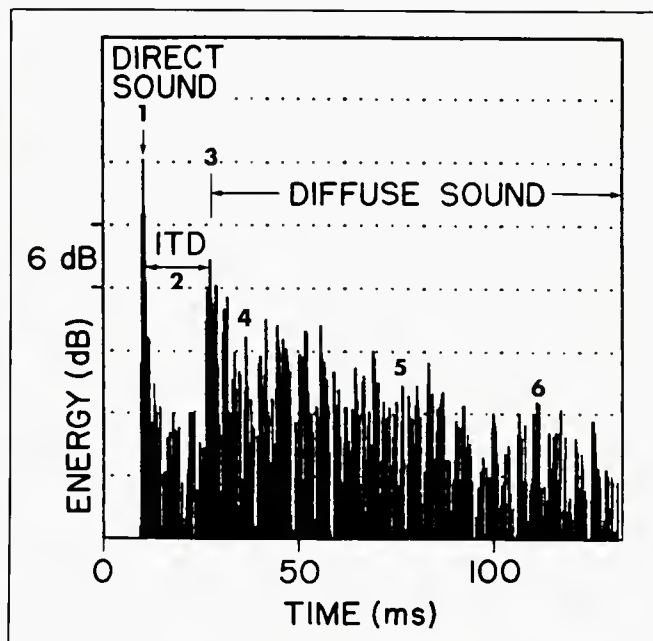

Figure 6. Experimental ETC of Master Sound Astoria with six critical temporal regions explained in the text identified. The ITD is approximately 17 ms. Time scale is from 0 to 133.08 ms, the sweep rate is 1977.45 Hz/sec. and the sweep range is from 0 to 2998.2 Hz.

The experimental energy time curve, ETC of Master Sound Astoria, an RFZ/RPG control room shown in *Figure 5B*, is illustrated in *Figure 6*. The direct sound (1) is a function of the acoustical time alignment of the speaker and any very short reflections from artifacts on the speaker face. The degree to which an RFZ is created, via absorptive or reflective/absorptive means, determines the effectiveness of the ITD (2). The initial diffuse energy from the rear RPG occurs at time (3). The RPG insures that this reflected energy arrives as a diffuse packet of energy rising abruptly after the ITD. The arrival time and time spread will depend on the distance to the rear wall and the depth and width of the RPG cluster. The intensity and time density of region (4) will depend on the amount of coupling between specular and diffusive surfaces. Region (5) will depend on second and higher order interactions with specular/diffusive surfaces and region (6) will depend primarily on how much absorption is used in the room and whether the RFZ in the front of the room is absorptive or reflective.

Providing enough space is available, diffusion over any bandwidth can be obtained by appropriate RPG design parameters. We have been using a five musical octave range for the most advanced room designs with much success.

Listening tests suggest that smaller bandwidths are also effective. To provide temporal and spatial diffusion below 300 Hz, we have developed the LFD.

LOW FREQUENCY ROOM RESPONSE-LFD

There are two phenomena which need to be considered in the low frequency part of the spectrum. One is the modal

monitor system to be driven at much lower SPL and consequently reduces distortion and ear fatigue. Relying on absorption alone is an expensive way way to heat a room! To accomplish low frequency diffusion and accompanying energy reduction, we have developed several number-theory sequences specially designed for their near-field scattering properties. Introduction of the LFD, *Figure 7B*, restores the

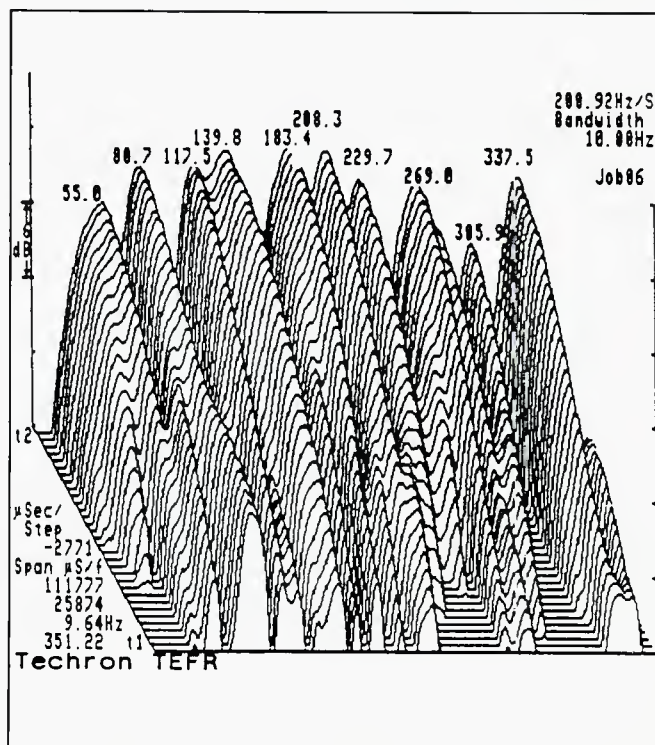
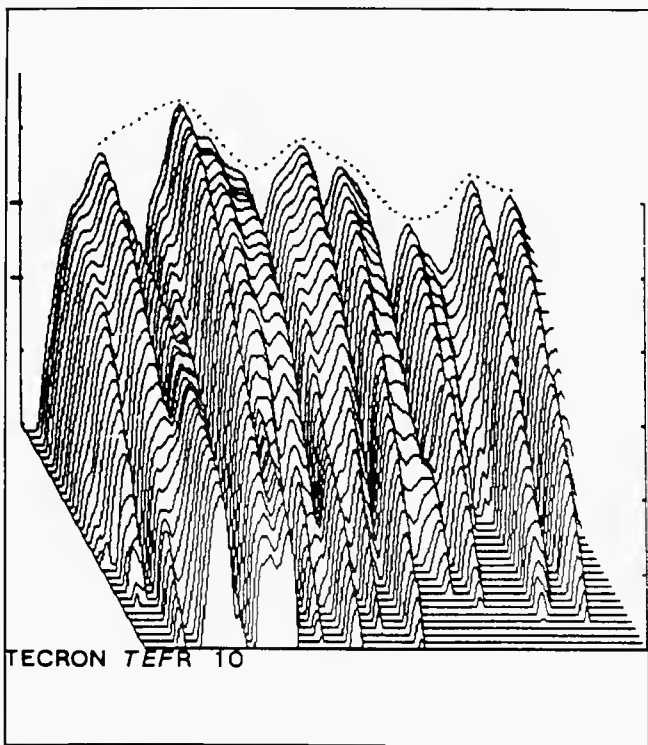

Figure 7. 3-D time energy-frequency measurement before (A) and after (B) the installation of an LFD with a maximum depth of three feet and a width of eleven feet. The LFD minimizes early time (back) low frequency interference and establishes a

uniform decay characteristic. Sweep range is 9.64 Hz to 351.22 Hz. Sweep rate and bandwidth are 200.92 Hz/sec. and 10 Hz respectively. Time range is from 25.87 ms (rear) to 111.78 ms (front) in 2.77 ms steps.

response and decay characteristics and the other is the interference between the direct and reflected sound from the rear wall. The 3-D TEF measurement provides a good illustration of both effects. *Figure 7* shows the 3-D TEF response of a control room before (A) and after (B) the installation of an experimental LFD based on a quadratic-residue sequence with eighteen inch wells and a maximum depth of thirty-six inches. The most obvious feature in *Figure 7* is the decaying modal frequency ridges. Although there is much to say about modal modification, we are primarily concerned here with the frequency anomaly which occurs at relatively early time 20-40 ms (rear of 3-D). As with reflections from the front of the room, low frequency sound reflected by the rear wall interferes with the direct sound causing the peak envelope (dotted line at the rear of *Figure 7A*) to deviate from a flat response. For example, interference notches in the frequency response caused by reflected sound from a purely reflective rear wall ten feet behind the mix position will occur at 28, 85, 141, 198, 254 Hz, etc. $[(n \times 1130 \text{ ft./sec}) / (4 \times 10 \text{ ft})]$, where n equals 1, 3, 5, 7, 9, etc.] The closer in amplitude the direct and reflected sounds are, the deeper the notches. Therefore, to minimize this interference one must attenuate low frequency energy either by absorption or diffusion.

Our design approach is to utilize as much of the energy generated by the monitor system as possible, both in using predominantly reflective RFZ and LFDs. This enables the

peak at 80.7 Hz and 269 Hz, attenuates the peak at 117.5 Hz and, in general, smooths the envelope. In addition, the decay characteristics have become more uniform. The 80.7 Hz ridge which rises with time (front of curve) is caused by a resonating structural partition. It is the "flatness" of the frequency envelope and the uniformity of the low frequency decay that is responsible for that "punchy" bass.

For anything to be effective at the low end it must consume real estate. The optimum width for an LFD is approximately a wavelength at the frequency of interest (f_0 Hz) and the optimum depth, in fact, is roughly $300/f_0$. The maximum frequency at which the LFD is operable is $c/2W$, where c is the speed of sound and W is the well width.

Consequently, for 100 Hz control a three foot maximum depth and ten foot width are required. Fortunately, nature is a little kind to us in that, as can be seen in *Figure 7B*, the units are effective below f_0 and most rooms are at least ten feet wide. Due to the massive surfaces required, we license qualified acoustical consultants to use the LFD and units are constructed on site from customized plans. Concrete, cinder block, or multiple-layer sheet rock are usually used and the LFD is constructed floor-to-ceiling on the rear wall.

One of the first LFD installations is seen in *Figure 5C* at Chicago Trax Recording. The LFD runs the width of the room and is located behind seven periods of a QRD with seven wells per second. A special corner sequence LFD



Figure 8A. Construction photo of cinder-block LFD.

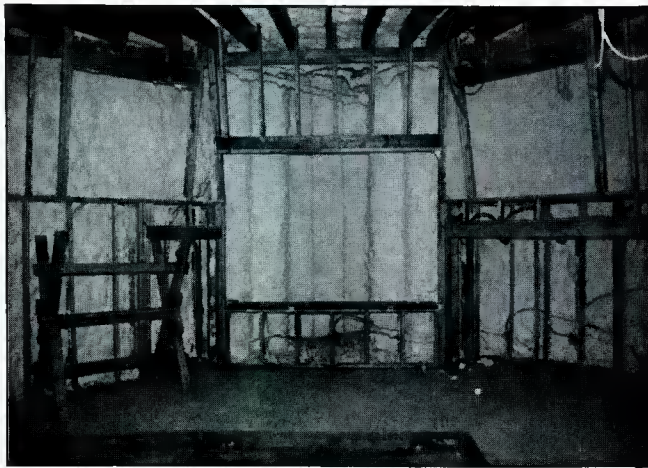

Figure 8B. Wall framing for broad-bandwidth RPG diffusors in front of LFD covered with absorbent material.

(Korner-Killer®) installed at the Welk Music Group, Nashville, TN, is shown in *Figures 8A* and *8B*. Broad bandwidth RPGs are placed in front of the LFD taking care to allow diffraction above, below and around. This can be seen in *Figure 8B*, where the framing for the broad-bandwidth RPGs is positioned in front of the LFD. The finished installation can be seen in *Figure 5D*. At these frequencies, the broad-bandwidth RPGs provide some diaphragmatic absorption, further reducing the low frequency energy from the rear wall. In situations where two or more feet of depth are not available for LFDs, diaphragmatic membrane absorption on the rear wall can be useful. If an LFD cannot be used, the low frequency response can be improved by arranging broadband RPG diffusors in a convex configuration (like the prow of a boat) or in a special licensed near-field number-theory sequency.

PRACTICAL ADVANTAGES OF AN RFZ/RPG CONTROL ROOM

- This approach allows great mobility across the entire width of the console, providing a very wide "sweet spot." Thus, engineer and producer are not elbowing for position at the console and can hear essentially the same program mix at different seating positions. A production desk behind the mix position is also effective since the producer is also in an RFZ.

- The presence of diffuse energy allows monitoring at much lower levels. In designs where the rear is essentially

an acoustic "black hole" to minimize interference, the monitor level must be raised to appreciable levels so that the mixer senses a feeling of envelopment. The RPG provides this spatial impression even at low levels. Traditional control room designs can easily be optimized by establishing a reflective RFZ and placing RPGs in front of a portion of the rear bass absorbers to provide diffuse energy. The bass absorbers will be only minimally affected because of the ability of long wavelengths to diffract around and/or transmit through the diffusors.

- These rooms allow the accurate perception of stereo images, evaluation of frequency balance, signal processing and reverberation in post-production. They simultaneously provide good definition and spaciousness.

- These rooms provide "flat" low frequency response and uniform modal decay characteristics.

- Many functions usually performed in the control room, most notably synthesizer production. Performance and critical listening can be carried out almost anywhere in the operating area of an RFZ/RPG room because of its diffuse characteristics. One can even work close to boundary surfaces in the rear of the room.

- We have now had the opportunity to measure the ETC and 3-D TEF response of many new rooms. The general consensus is that reproducibility of design and transferability of musical products are being achieved. While new rooms vary in subtle aspects, the overall quality with respect to stereo imaging, frequency response and envelopment is excellent. ■

REFERENCES

1. M.R. Schroeder, *Number Theory in Science and Communication, with Applications in Cryptography, Physics, Digital Information and Self-Similarity*, Springer, Berlin, 1986.
2. P. D'Antonio and J.H. Konnert, "The Reflection Phase Grating Diffusor: Design Theory and Application," *J. Audio Eng. Soc.*, Vol. 32, No. 4, pp. 228-238 (April, 1984).
3. *Synergetic Audio Concepts Newsletter*, Vol. 11, No. 2, pp. 14-17 (Winter, 1984).
4. *Synergetic Audio Concepts Tech Topics*, Vol. 11, No. 7 (Spring, 1984).
5. P. D'Antonio, J.H. Konnert, "The RPG Reflection Phase Grating Diffusor," *Mix Magazine*, Vol. 8, No. 8, pp. 74-76 (August, 1984).
6. P. D'Antonio, J.H. Konnert, and F. Becker, "The RPG Reflection Phase Grating Diffusor: Experimental Measurements," 76th AES Convention, NY (October, 1984), Preprint No. 2158.
7. P. D'Antonio and J.H. Konnert, "The RPG Reflection Phase Grating Acoustical Diffusor: Applications," 76th AES Convention, NY (October, 1984), Preprint No. 2156.
8. P. D'Antonio and J.H. Konnert, "The RFZ/RPG Approach To Control Room Monitoring," 76th AES Convention, NY (October, 1984), Preprint No. 2157.
9. *Synergetic Audio Concepts Tech Topics*, Vol. 12, No. 1 (Fall, 1984).

10. R. Todrank, "Incorporating Reflection Phase Grating Diffusers on the Rear Wall To Enhance Spatial Imaging and Stereo Ambiance," *Recording Engineer/Producer*, Vol. 15, No. 6, pp. 122-125 (December, 1984).
11. P. D'Antonio and J.H. Konnert, "The Role of Reflection Phase Grating Diffusers in Critical Listening and Performing Environments," 78th AES Convention, Anaheim (May, 1985), Preprint No. 2255.
12. P. D'Antonio, J. H. Konnert, and Russell E. Berger, "Control Room Design Utilizing A Reflection Free Zone and Reflection Phase Grating Diffusers: A Case Study," 78th AES Convention, Anaheim (May, 1985).
13. B. Comer, "Kaufman Astoria Studios," *Mix Magazine*, Vol. 9, No. 5, pp. 126-130 (May, 1985).
14. J. McCarthy, "Indiana Studio Used 'Stealth' Technology," *Mix Magazine*, Vol. 9, No. 8, pp. 20-25 (August, 1985).
15. C. Bilello and P. D'Antonio, "Measuring-Up Boundary Mics," *Sound & Communication*, Vol. 31, No. 9, pp. 14-18 (September, 1985).
16. P. D'Antonio, "The Reflection Phase Grating Acoustical Diffuser: Diffuse It Or Lose It," *db Magazine*, Vol. 19, No. 5, pp. 46-49 (September/October, 1985).
17. P. D'Antonio and J.H. Konnert, "The Acoustical Properties of Sound Diffusing Surfaces: The Time, Frequency and Directivity Energy Response," Invited Paper B-6, 79th AES NY (October, 1985), Preprint 2295.
18. P. D'Antonio, "The RPG Diffuser," *Pro Sound News*, Innovations In Sound, Vol. 7, No. 10, pp. 51, 61 (October, 1985).
19. B.S. Comer, "On Location," Vol. 9, No. 7, pp. 142-143 (October, 1985).
20. R.E. Berger and C. Chiles, "Dallas' Tele-Image Preparations for Stereo TV," *Mix Magazine*, Vol. 9, No. 12, pp. 80-84 (October, 1985).
21. W. Baldwin, "Technology: Applied Gozinta," *Forbes Magazine*, pp. 152-153 (October, 1985).
22. "Optimizing Stereo Imagery," *AES Daily*, p. 12 (October 15-16, 1985).
23. P. D'Antonio and J.H. Konnert, "Recording Control Room Design Incorporating a Reflection Free Zone and Reflection Phase Grating Acoustical Diffusers," Invited Paper D2, 110th Meeting: Acoustical Society of America, J. Acoust. Soc. Am. Suppl. 1, Vol. 78, p. 59 (November, 1985).
24. I. Peterson, "Acoustic Residues," *Science News*, Vol. 129, No. 1, pp. 12-13 (1986).
25. M. Amato, "Tele-Image: Thinking Big In Dallas," *Millimeter Magazine*, Vol. 14, No. 4, pp.43-44 (March, 1986).
26. R. Shaw, "Facility Spotlight: Word of Faith's New Audio Production Studio," *Recording Engineer/Producer*, Vol. 17, No. 2, pp. 86-97 (April, 1986).
27. P. D'Antonio and John H. Konnert, "Advanced Acoustic Design of Broadcast and Recording Facilities," NAB Engineering Conference Proceedings, TV Multichannel Sound Session, pp. 215-224 (April, 1986).
28. T. Carr, "Blue Jay Recording—High Tech Underground," *Mix Magazine*, Vol. 10, No. 5, pp. 134-138 (May, 1986).
29. P. D'Antonio and J.H. Konnert, "The Reflection Phase Grating Acoustical Diffuser: Application in Critical Listening and Performing Environments," 12th ICA, Toronto (July, 1986).
30. G.S. Kendall and W.L. Martens, "Simulating The Cues of Spatial Hearing In Natural Environments," Proceedings of the 1984 Computer Music Conference, IRCAM, Paris (1984).
31. D. Davis and C. Davis, "The LEDE Concept for the Control of Acoustic and Psychoacoustic Parameters in Recording Control Rooms," *J. Audio Eng. Soc.*, Vol. 28, No. 9, pp. 585-595 (1980).
32. M.F.R. Barron, "The Effects of Early Reflections on Subjective Acoustic Quality in Concert Halls," *J. Sound Vib.* 15, 475-494 (1971) and Ph.D. Thesis, University of Southampton (1974).
33. J.R. Hyde and A.H. Marshall, "Requirements for Successful Concert Hall Design: Need For Lateral and Ensemble Reflections," IEEE International Conference On Acoustics, Speech, and Signal Processing, Paper A2.4, (April, 1980).
34. C.A.P. Rodgers, "Pinna Transformations and Sound Reproduction," *J. Audio Eng. Soc.*, Vol. 29, pp. 226-234 (1981).
35. L.L. Beranek, *Music Acoustics and Architecture*, Wiley, NY (1961).
36. H. Haas, "The Influence of a Single Echo On the Audibility of Speech," *J. Audio Eng. Soc.*, Vol. 20, pp. 145-159 (March, 1972).
37. Y. Ando, *Concert Hall Acoustics*, Springer Series In Electrophysics 17, Springer-Verlag, Berlin Heidelberg (1985).
38. H. Kuttruff, *Room Acoustics*, Applied Science Publishers, Ltd., Second Edition, London, 1979.
39. N.A. Muncy, "Applying The Reflection-Free Zone RFZ® Concept in Control Room Design," *db Magazine*, (July/August, 1986).
40. M. Born and E. Wolf, *Principles of Optics*, Sixth Edition, Pergamon Press, Great Britain (1984).
- © RPG, QRD, RFZ, LFD and Korner-Killer are trademarks of RPG Diffuser Systems, Inc.; LEDE is a trademark of Synergetic Audio Concepts.

Profile: Producer/Engineer Michael Lloyd

Michael Lloyd shares what he feels to be the secret to success in the business.

ISANG for two Presidents, on national TV, and sang the National Anthem at a World Series game in 1974. When I was performing, I got to meet the who's who of the movie, TV, and music industries—Bob Hope, John Wayne, Leonard Bernstein, Sammy Davis Jr., Edgar Bergen, Roy Acuff, Wayne Newton, Harry Belafonte, etc. I could go on, but the point is that I discovered one interesting fact—the top people in the business are “nice folks.” If you get a chance to talk with them, you discover that they all share this trait, and that's probably why they work all the time—because they are easy to work with. Michael Lloyd is no exception. Of course, being in the right place at the right time helps, as you'll see, but lots of hard work and years of experience are what it takes to rise to the top of your profession. Michael Lloyd's credits (Lou Rawls, Belinda Carlisle, The Monkees, Shaun Cassidy, Leif Garrett, The Burrito Brothers, The Bellamy Brothers, Maureen McGovern, Coven, Brush Arbor and others) and his stature in the business are proof enough, but sitting down with him for a Saturday afternoon chat, I felt as though I had known him for years.

Michael Lloyd: I did a thing for JBL fourteen or fifteen years ago with Lou Rawls in the studio, and they had a slide presentation...it was kind of walking through a session with Lou—I forget exactly what it was—and they gave me four 4310s. I still have those speakers, I've used them for recording for fifteen years. I use them as primary monitors. About 225 watts per box, I bi-amp them—gosh, I have almost 200 watts going into that 12-inch speaker, and its held up amazingly well. I've since located several other 4310s to use for replacement parts so I can keep the sound of the monitors the same. I've tried some of the newer style woofers in my monitors, but they have a different sound, hard to get used to. That's a problem—once you have a certain reference and then you try to change it...

db: The ear does have to learn the monitor you're using.

ML: I'm just getting on now to those Yamaha NS10s, you know, that everyone uses.

db: Did you enjoy the *REP* article about the tissue paper tests done on the NS10s?

ML: The tissue paper...the different types of tissue paper? Yeah, I don't have any tissue paper on them, and it is a little bright—probably a little too bright—because once I listen to those and go back, the 4310s sound like 604s. You

Drew Daniels is the Applications Engineer for JBL Professional, a company which manufactures loudspeaker components and speaker systems and distributes professional audio equipment under the JBL, UREI, and Soundcraft names.

know it's unbelievable, but I'm getting on to them—I've had them for about two years or so, and I just resisted using them, but you know I go back and forth now between the two (types of monitors). I'm driving the NS10s now with a D150, which is okay, it's an old D150 and I'm thinking that maybe I'm not driving them quite right, but that's a minor point. It used to be there were so many studios that had Westlake monitors, you could go here and go there, but now there's a million different guys that have their own concept of what small monitors should be. I was out in Bearsville doing the Monkees about a month ago, and they played it on their big speakers and it sounded fabulous. I mean it sounded great, huge and all that kind of stuff. Didn't have any relation to reality, but it sounded great. They had the little Yamahas, and that's kind of become a standard it seems. You know, things come in and out of fashion. I'm really interested in the technical side of this stuff because I've been doing this for so long. I mean, I started recording when I was thirteen, and I had a studio when I was sixteen, when it was mono and 2-track and much easier to understand.

db: How did you actually start recording; how did you get into it?

ML: I was in a band, and I met a couple of guys...it seems like it was yesterday. They were producer types, entrepreneurial 1964 record business types like, “Hey, let's sell some records out of the back of our car.” It was that kind of thing. But it was a high school band. I was about thirteen, and we recorded a bunch of stuff, you know, these guys had ideas. It was all instrumentals. I remember going down to this place in downtown Los Angeles or Inglewood or somewhere, and there was a black postman who had put a studio in his garage. It literally was a garage, and it wasn't anything special, but it looked special to me. He had a great EMT as I recall, a great EMT plate. And some little jury-rigged console or God knows what, and a couple of tape machines, mono, stereo, and we sat there.... We recorded there a couple of times and then we got involved with Hite and Derinda Morgan who owned a company called Stereo Masters. That was one of the few independent cutting facilities around. Hite and Derinda had discovered the Beach Boys, and they were part owners of some of those (Beach Boys) copyrights. And so they had a little studio they had put together next door. They had a little console, very rudimentary EQ. It was more like a cut and boost kind of thing, tone controls, like two knobs—“cut something, boost something,” at two frequencies and that was it, but it was a big step up from the garage. So we ended up recording on the weekends, just an astonishing amount with these people. They'd write a song—they were people who reacted instantly to something that happened, like teen fads.

db: Tell me a little about how you started at MGM.

ML: That leads us to the end of 1969 then. Mike had been doing some work with Jim Aubrey, he got a call from Mr. Aubrey saying that he was going to become president of MGM Corporate, and would Mike Curb like to become president of MGM Records? And then Mike brought me to MGM as head of A&R. Now, I was nineteen and Mike was twenty-three. I had never had a successful record, so you can imagine the feeling of going to a place like that. We walked into the MGM building back in New York, and the MGM Records floor was like an airplane hangar, I mean it was huge and there were people everywhere. I'd never seen so many people before, it was like walking into an insurance company where everyone is around like desks in the middle, offices around the whole big area of the floor and the windows. It was incredible. They had come through several presidents in a short time there and Mike had to whip this all into shape. Quite a task, and he did. They had lost a lot of money the year before, but in a short while he ended up pulling ahead with the Osmonds and Lou Rawls and all these acts that he and I recorded. It gave me a chance to actually record fine artists with great promotion.

db: What was your function then?

ML: Actually I would do whatever looked like it needed to be done. Sometimes I'd arrange the song, sometimes I'd produce them, sometimes I'd engineer them. We had a studio I built with a fellow named Val Valentin—a legendary figure in the recording studio business—it's Cherokee now, on Fairfax, and boy, it was a great studio then. For the type of records we were making it was great because we used a lot of orchestras and Don Costa was doing arrangements. It wasn't great for rock 'n' roll, but was it great for orchestral things! It gave me an opportunity to be more involved in business, to have to learn more about that, which was a very positive thing for me.

We left MGM about 1973 and worked independently for a while. I need to back up one step real quick; before I started having hits, when I first started to work for Mike I was scoring motion pictures for him, and television shows, that's how I was making a living. I was about sixteen or seventeen. That only becomes important about now, because of all the stuff that's happening with film. We've been doing that for years and years and I've had great luck with film work, and so during that period when we left MGM I did some more television and some more films. We tried to get more records going and Mike was setting up a company at Warner Brothers called Warner-Curb that ended up becoming very successful. I had some great artists there—all different kinds, actually MOR artists like Maureen McGovern, and, of course, we had Shaun (Cassidy) and Leif Garrett and some country acts like the Bellamy Brothers, Burrito Brothers, Susie Allenson, all kinds of different people that I was cutting—a great time for me. There were a couple of teen acts, and there were a couple of country acts, and a couple of MOR acts and it was great fun. I still hadn't stumbled across the perfect AOR or rock 'n' roll act or whatever, so as a result a lot of people thought of me in terms of teen acts because of the Osmonds and Shaun—they were so visible, it's easy to get pigeon-holed by an artist's visibility, and they were just unbelievably visible. But I'm very proud of those acts—it was what I was doing and they were successful; it was terrific.

db: There seems to be a pretty good supply of well loved forty year-old rock 'n' rollers today, don't you think? They influence or *have* influenced the newer acts.

ML: Absolutely. They don't want to give up what they have, and there's no reason they should. All this makes it

tougher for you to break a type casting of teen music. It makes it hard for an artist like Charlie Sexton to make it; it's tough, it's very tough. If I was thirteen now, I'd be forced out of it; there wouldn't be any room for me, which is depressing because we're missing out on those influences—the influences of the very young talent around the country today. I think when new wave was new and all of that was happening, it was a terrific influence because it was youngish people who hadn't had a chance to be involved and as a result those influences were fresh and alive and exciting and I miss a lot of that.

It's not that I don't think some of the acts that we're talking about that are older shouldn't be doing it—they should be. It's just that it would be nice to somehow figure some way to include the young ones too, but we have a huge baby-boom audience of middle-aged people now who grew up with rock 'n' roll. This is the first time in our history when a generation of people has held on to its music and kept it contemporary, you know what I mean? When I was making records, my mother's music wasn't on the radio. Yet I hear the Rolling Stones. My kids—I have a nineteen year-old daughter—she's hearing the Rolling Stones on the radio, and I have their first album! You know what I mean? That's weird.

db: How do you feel about synthesizers and drum machines?

ML: I like some of it and I hate a lot of it.

db: Do you miss the sound and human feel of musicians playing together?

ML: Yes, I miss it. Disco never died, it just changed its name to dance music. I love the consistency of the beat (of drum machines) for dance music. There is a certain hypnotic quality about all that and that's great, and I like some of the little novelty things they can do with triggering and sampling and all that kind of stuff, but the reality of it is that I love to hear great musicians, *not* great programmers, and that's not to take anything away from the people who are programming, but it would be wonderful to have great guitar players like Lee Ritenour, Jay Graydon, Larry Carlton. It's a real problem, I don't know what the answer is to that. Right now I guess, the answer is to be a keyboard player.

db: People used to get into the pop music business obliquely, but now...

ML: Think of the string players, I mean, you don't hear many real strings on records any more. Whitney Houston's records I think are attractive because they sound modern and yet have a sense of realism about them in terms of the musician quality, but Michael Masser has always been old school, with good songs and good musicians. Clive Davis also is brilliant at putting songs together with people, and he demands a certain level of musicianship whether it's synthesized or real. The quality just kinda comes up a notch. To put it succinctly, I like a lot of the sounds you can get out of these things, whether they be oranges, strings or keyboards or whatever. But...I like real musicians playing them. On Belinda Carlisle's record, for instance, on the single, it's a fellow by the name of Paul Leim playing drums—real drums—he may be hitting things that are triggered, but he's *playing* them. The only thing that's programmed is the bass drum. Actually that probably wouldn't have happened except that track was the demo track we used for that song, and we liked four or five elements. We kept the bass drum, the bass, one of the synths, one acoustic guitar, and then he played the drums on

top of that, Andy Taylor played more guitars, I put a couple more synthesizers on. I've done things like that where I've used combinations of instruments.

I've worked with Paul on an awful lot of records recently, and he has a wonderful sense about coordinating programmed things and triggered things with acoustic real playing. He's got a rack that sits behind him the size of Arkansas, and he's got an SP-12 and a Linn and Simmons pads and octa-pads. A drummer used to show up with a drum set and some cymbals and that was that. This is a big scene, he's got an Rev-7 and he's got the Roland echo thing and a mixer and a this and a that—a lot of stuff, a *lot* of stuff. Paul integrates them perfectly. He's a fine drummer. I like to have all of those sounds available and I like to have great musicians playing them.

DB: Through my experience with some good drummers like Lee Spath and Bill Severance in my own studio, I've come to believe that only a drummer can program a drum machine. There's such a world of difference when the programmer's not a drummer.

ML: A good drummer doing that gives you all kinds of little things that make it sound more real or more imaginative—maybe real is the wrong word, it just has—it has talent to it, and I think that's really important. I miss that in some records—even records that are hits.

db: How do you handle acoustic recording, mic'ing, EQ, and so on?

ML: Since I've been using Paul so much, we've kind of approached it in a similar manner for about five records, but because of the way we do it, it seems to be flexible enough so that it doesn't sound the same from one record to the next. I have a drum set that I use all the time—that sometimes is common—and I have, of course, a grouping of microphones that I use basically all the time. Whenever I have strayed away from that, in the last year or so, I have been disappointed, partly because we have worked on what we have to get it to a certain point. Sometimes it's taken us a day or so to set up what we *know*, and then if we branch out and try to get something else, we don't spend enough time on it to really understand what we're doing. When I was back at Bearsville, they were recording the Pretenders, and they were mic'ing from above and below all the toms and it was a very acoustical looking setup. I mean it looked like I'd walked back fifteen years. There wasn't a synthesizer in the place, there was a B-3, a Wurlitzer—it was astonishing, and that was kind of interesting to see.

But I've recorded a lot like that, putting mics on the top and the bottom. It kind of depends on what you're doing. Now we're trying to get a more aggressive sound rather than so much of the tone of the drum, because there's so much gated echoes and room sounds and AMSs and all this kind of thing, so we've been top mic'ing mostly. Depending upon the song, sometimes it's condenser, sometimes it's dynamics. The drums happen to be rim mounted which changes the way they ring. (We use) a couple of mics on the kick, a couple of mics on the snare, sometimes we put a little mic inside the snare, and that's also triggering electronic snares as well, a couple of overhead mics, and then generally two or three different room mics. Now that setup is for recording at my studio, which isn't huge, but it's a real live room, and it gets "X"-sound, whatever that is, that is the sound. By changing some of that stuff, we'll change the sound somewhat, of course, and by changing drums, it changes a lot, but as I said, our current setup seems fairly flexible and I don't think that anyone would think the drums were similar from one record to another, at least they haven't so far, even though it's been

the same drummer, actually. The room mics are generally old tube mics—49s, 269s, stuff like that. I've tried those on the toms, and on a couple of particular songs it sounded real good—old Beatle kind of "ptoom, ptoom." I just have a horror of the mic exploding when the guy hits it with the stick and stuff like that, 'cause they're so hard to fix. But anyway, that was interesting, we had four 269s on drums and it sounded incredible, but not as aggressive, warmer, broader sounding, more tone, more depth, all those things that I was familiar with having heard on records for so long, but a couple of the artists, quite frankly, thought it was too tame—maybe we need to EQ them sharper or something. We tried it, worked on it for like a couple of days, ended up using it on a ballad and didn't use it on anything else. I run 'em through some API equalizers that have been coming in and out of fashion, right now they happen to be in fashion again—I've had 'em for years as a lot of people have. I've liked them for a long time—and we gate some of the toms because they ring an unbelievable amount sometimes with this rim system and all depending on the mic you're using. It's kind of a straight ahead thing. Over a period of time, we found the drums that sounded good in that room and the mics that sounded good on those drums, and once that and the variations on that were established, it became rather pedestrian. It wasn't, "Let's spend three or four days to get this to sound good." It generally sounds pretty good to start off with.

Then it's a question of how we're going to change it, how it's best going to suit the artist, the song, who's playing the drums; is it a studio guy like Paul or is it one of the guys in a group? Every guy playing the thing—I mean I had the whole thing perfectly set up for Paul, sounding incredible, someone else came in and played the same setup and it sounded out of whack and bad and was almost a nightmare because you had no way to correct, you didn't know what to correct. It would have been better if we'd been setting up for that guy special. I primarily do that with nothing else in the studio, it's just that, just the drums. Sometimes I record just drums to a click track.

db: You must hear the finished mix in your mind when you're setting up the drums.

ML: Yes, absolutely yes.

db: Do you go back after the project is on tape and solo the drum tracks for remix or re-balancing and EQ?

ML: We always re-EQ it. Sometimes it's been just the drums and maybe a bass or maybe a guitar and a guide vocal. On the Monkees record, we happened to have a full complement of guys, I mean it was like the old days! We had a drummer, a bass player, two guitar players, and a keyboard player all at the same time. It was really amazing. I hadn't seen so many great players at once in a long time! It was Dennis Belfield on bass, Paul on drums, Lawrence Juber from Paul McCartney's band on guitar, Dean Parks on guitar, and a new young guy playing keyboards—good player. Boy it sounded great, it really sounded great. Then we overdubbed a little guitar that Lawrence played, and a little synth that I played, and that was really about it. Maybe a tambourine, but it wasn't like a cast of thousands kind of thing. It was just kind of unusual since there were so many guys there playing their actual parts right then. And the great part about that is that these guys can interact and be influenced by what they're doing, assuming you have good players who respond one to another.

That is another element that's lost in synthesizer work because everything is layered. Even if you've got a sequencer and you're doing four or five keyboards at once to kind of

hear all these parts happen at once, generally it's one or two guys doing all of that and influencing that. When you have five or six really talented guys sitting there playing, they get off on what's happening and it's fun. There are microscopic changes happening from moment to moment. I mean there was a certain thing to a Sinatra standing out in the middle of a room with Don Costa conducting a forty-piece orchestra of great musicians and they're listening to Sinatra sing, and they're breathing and creating with him. You don't hear that too much now. The first hit record I had, Lou Rawls' *Natural Man*, was recorded that way with six or seven guys and background vocals. There wasn't much on the record, just background vocals, and Lou singing live—on a C12—in the middle of the MGM studio. There was leakage, and we couldn't re-do a note because of the leakage, but it didn't matter.

db: We're purposely changing the way we make records?

ML: Oh, absolutely, and conceive them and everything, and not always for the better.

db: And the changes are reflected in music education and in young people's musical aspirations.

ML: Yeah, music education is a real problem. In some ways, there's more education available to young people or people in general, with the alternative types of schools, with some of the extension courses available at places like UCLA and USC, it's been contemporized in terms of what's available, but it's much more difficult to get involved in the business. It's very frustrating.

db: It's certainly more intimidating, with the costs of keyboards and computers and sequencers and samplers and

drum machines that a lot of players think they must have or actually must have to be competitive or get into the music job market. Thanks to the electronic instrument makers, playing music has become an endeavor for the rich.

ML: Certainly more intimidating. You can get involved you can learn about it, but to actually make the record and to get the deal is very, very difficult. There's only a handful of labels compared to what there used to be, they all are faced with expensive promotion costs, marketing costs, all that kind of thing. It's very tough.

db: It was a bit bizzare for me to watch a recent TV special on which Paul McCartney sang for Prince Charles. He's the Andy Williams of our generation now, it's strange.

ML: It's frightening. The only group I liked everything from was the Beatles, I was a Beatle nut, and they are still, to me, the greatest pop music song writers and recording artists ever. They did stuff that had never been done before. There wasn't anything for them to copy. Once they started to really write, and record from perhaps *Rubber Soul* on, they were doing things that nobody ever dreamed of doing. They were like an encyclopedia of pop music. Nobody gets those sounds, and there weren't synthesizers then.

db: So what do you think is the secret to success in the business?

ML: A great tune, a great artist, put together the best you can, then marketed and promoted perfectly. You have to have such a good team of people working together. The record company, the management side, everything. There are the rare records that just happen on their own, but you sure can't depend on that. It takes everyone involved to have and share in a hit record. ■

Do You Know Where?

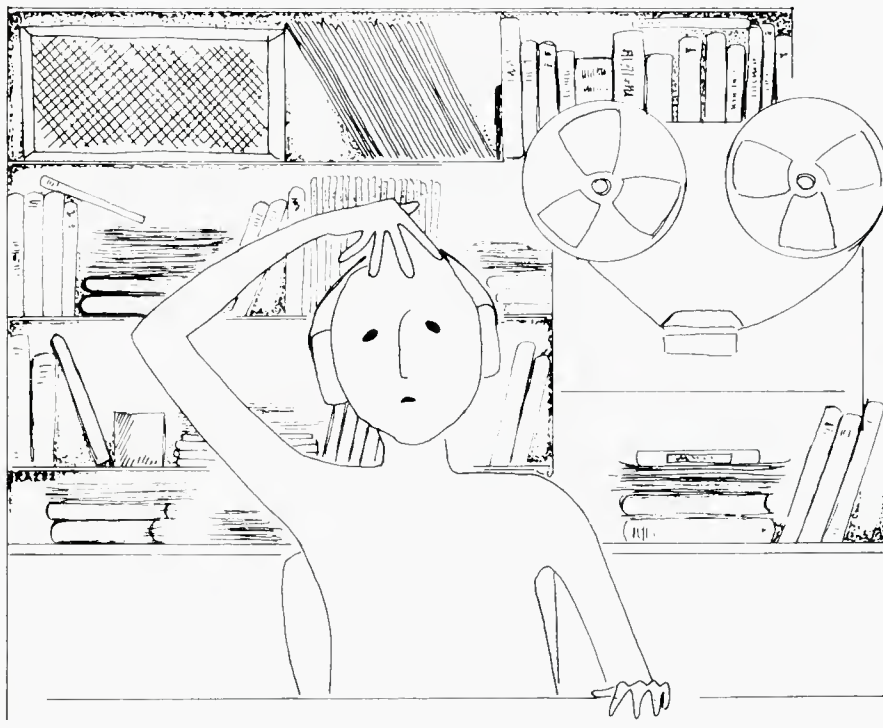

Have you misplaced your **db** again? Our high quality, royal blue vinyl binders keep 12 copies of **db** neat and handy for ready reference.

Just \$9.95, available in North America only. (Payable in U.S. currency drawn on U.S. banks.) ORDER YOURS NOW!!

Sagamore Publishing Co., Inc.
1120 Old Country Road
Plainview, NY 11803

YES! Please send _____ **db** binders @ \$9.95 each, plus applicable sales tax. Total amount enclosed \$ _____

Name _____

Company _____

Address _____

City _____

State/Zip _____

db Buyer's Guide

Compressors

& Limiters

APHEX SYSTEMS

The Compellor Model 300 is a compressor/limiter/peak limiter with program dependent circuits to provide all three functions simultaneously, with no control changes necessary as program varies.

Prices: \$1,195.00, for stereo unit; \$795.00 for mono unit.

AUDIO + DESIGN/CALREC

The Express Limiter is a stereo compressor/limiter/expander.

Price: \$875.00.

The SCAMP S31 is a compressor/limiter with a compression ratio of up to 20:1, attack range of 300 microseconds to 25 ms, 60 dB control range and a computer control logic input.

Price: \$395.00.

The Compex 2 is a compressor/limiter/expander/gate that is a combination of the SCAMP S30 expander/gate and the S31 compressor/limiter modules in one self powered unit.

Price: \$890.00.

The F601 Superdynamic Limiter is a dual mono/stereo limiter with 100 dB dynamic range (threshold to noise), variable attack, release and threshold controls.

Price: \$1,320.00.

ALTEC LANSING CORP

The 1612B is a limiter amplifier with dual microphone or line inputs, adjustable attack/release time, and VU meter. It is suitable for loudspeaker protection in live installations.

Price: \$1,260.00.

AUDIO LOGIC

The MT 66 is a stereo compressor/limiter capable of "soft knee" dynamic range compression, or hard or soft limiting from 1:1 to infinity:1, with up to 25 dB of gain reduction.

Price: \$299.95.

BIAMP SYSTEMS

The Quad Limit/Gate allows each channel to be independently switched from compression to noise gate. It has mic/line switch, and electronic floating and balanced/unbalanced connections.

Price: \$499.00.

The Stereo Limit/Gate is a two-channel version of the quad, above. It has external trigger inputs, stereo strapping switch, and ground lift strap.
Price: \$349.00.

BROOKE SIREN SYSTEMS

The DPK402 is a stereo compressor/limiter/de-esser that includes controls for threshold, attack and release times, ratio, output gain, and peak limit threshold. Unit can be configured for multiband limiting, expansion, and other frequency sensitive processing.
Price: \$1,185.00.

CONNECTRONICS

The Accessit Compressor features both mic and line inputs with mic and line outputs also. It has a "soft knee" compression curve to a ratio of 6:1, and dynamic range reduction meter.
Price: \$149.00.

dbx

The 160X is a compressor/limiter that gives the user the choice of Over Easy or Hard Knee operation, regardless of compression ratio. It has active balanced inputs.
Price: \$429.00.

The 163X Compressor/Limiter/Preamp provides Over Easy compression controlled by a single slider, 3-step setup with front panel level set, and front panel high impedance input.
Price: \$149.00.

The 165A Compressor/Limiter gives the user complete control of the compression and limiting characteristics. Compression ratio is continually variable from 1:1 to infinity:1.
Price: \$699.00.

The 166 is a compressor/limiter/noise gate with Over Easy compression, noise gate with switchable release time, and LED indicator for gate operation.
Price: \$549.00.

DOD

The R-825 is a single-channel compressor/limiter featuring a de-essing circuit. It can be linked to another unit for stereo operation and allows access to the signal processing side chain.
Price: \$249.95.

FOSTEX

The 3070 is a stereo compressor/limiter/noise gate that can be operated as two independent units or with stereo link. Each has input and output control, variable attack, release, compression ratio and gate threshold.
Price: \$400.00.

FURMAN SOUND

The LC-X combines a compressor/limiter/de-esser, an expander/gate, and a peak limiter, each with threshold control. Has attack and release controls, side-chain connections, and line guitar/inputs.
Price: \$349.00.

The LC-3A Limiter/Compressor features attack, release, ratio, input level and output level controls. Side chain and de-ess modes are available. Ten-segment meter displays gain reduction.
Price: \$249.00.

IBANEZ

The MSP1000 Multi-Signal Processor contains a compressor with up to 60 dB compression, a 2/3-octave graphic equalizer, and a 2-band notch filter.
Price: \$299.00.

JBL PROFESSIONAL

The LA-4 is a compressor/limiter with a long-life LED optical attenuator, smooth, natural-sounding RMS action, selectable compression ratios, VU indicator, input overload indicator, and simple stereo coupling.

Price: \$496.00.

The 1176LN is a peak limiter with pushbutton selection of four compression ratios, attack time and release time are front panel adjustable, and it has high impedance, balanced, bridging inputs, and transformer balanced output.

Price: \$596.00.

The 1178 is a dual peak limiter with pushbutton selection of four compression ratios, switchable meter ballistics (VU and peak), and front panel adjustable attack time.

Price: \$896.00.

LT SOUND

The Model CLX-2 is a feed-forward compressor/limiter incorporating the Allison EGC-101 VCA, features include simultaneous operation of both compressor and limiter.

Price: \$895.00.

The Model ACC-2 is similar to the CLX-2 but has a full featured expander as well. There is also an onboard oscillator for tremolo and stereo panning.

Price: \$1,250.00.

The Model SL-2 is a stereo limiter/expander with features that include simultaneous limiting and expansion functions, de-essing, stereo or independent operation.

Price: \$395.00.

ORBAN

The 412A Compressor/Limiter has adjustable attack and release times, compression ratio, and threshold. It has front panel input and output attenuators. Also available in dual-channel stereo model.

Price: \$425.00; \$799.00 for the dual-channel unit.

The 424A is a dual-channel gated compressor/limiter/de-esser with optimized, program controlled parameters. It allows manual adjustment of compression ratio, attack and release times, gating threshold, and de-esser sensitivity.

Price: \$989.00.

ROLANDCORP

The Boss RCL-10 is a compressor/limiter, expander and noise gate with independent controls for attack and release times. It also has a key-in jack for gating.

Price: \$195.00.

The Boss CS-3 is a compressor/sustainer that features a tone control for timbre variation as well as attack and sustain controls.

Price: \$120.00.

The Boss CS-2 Compressor features a VCA to eliminate volume reduction during the initial attack of each note, as well as sustain and attack controls.

Price: \$99.50.

SYMETRIX

The 525 is a gated compressor/limiter that utilized a program controlled system that analyzes incoming signals and adjusts attack and release times accordingly.

Price: \$495.00.

The 522 is a compressor/limiter/expander/gate/ducker with selectable operating mode. It has low distortion VCA and "soft knee" transition. Dual-channel mono or stereo operation.

Price: \$595.00.

The 501 is a peak/RMS compressor/limiter with variable ratio compressor and an infinity:1 peak limiter. It has switchable automatic mode to reduce overshoot and distortion.

Price: \$425.00.

The CL-150B Fast RMS™ compressor/limiter offers "soft knee" transition and smooth overall compression. Selectable automatic or manual operation.

Price: \$349.00.

VALLEY PEOPLE

The Gain Brain II Compressor/Limiter/Ducker is designed to be housed and powered by any of the 800 Series racks. It employs Linear Integration Detection to prevent strained sounds normally associated with limiters and compressors.

Price: \$420.00.

The 610 Dual Compressor/Expander offers two independent channels, each consisting of a compressor and expander section that share a common gain control element and release time control, so they may be used interactively.

Price: \$995.00.

The 440 Limiter/Compressor/Dynamic Sibilance Processor is a single-channel device offering all sections controlled by a common VCA. The unit can simultaneously perform all functions.

Price: \$650.00.

The Leveller is a dual-channel limiter offering level control of a variety of audio signals. Once the desired input level is set, and the output gain is determined, the operator merely determines whether more or less leveling action is needed.

Price: \$620.00.

YAMAHA INTERNATIONAL

The GC2020B is a high performance 2-channel compressor/limiter that offers a wide variety of control features for precise tailoring of functions, and features an expander noise gate in each channel. Response is +1,-3 db 20-20k, THD at +4 is below 0.5%.

Price: \$355.00.

Compressors & Limiters

Altec Lansing
PO Box 76105
Oklahoma City, OK 73126

dbx
71 Chapel St Box 100
Newton, MA 02195

LT Sound
PO Box 338
Stone Mountain, GA 30086

Aphex Systems
13340 Saticoy St
North Hollywood, CA 91605

DOD Electronics Group
5639 South Riley Lane
Salt Lake City, UT 84107

Orban Associates
645 Bryant St
San Francisco, CA 94107

Audio + Design/Calrec
PO Box 786
Bremerton, WA 98310

Fostex Corp. of America
15431 Blackburn Ave
Norwalk, CA 90650

RolandCorp US
7200 Dominion Circle
Los Angeles, CA 90040

Audio Logic
see DOD

Furman Sound
30 Rich St
Greenbrae, CA 94904

Symetrix
109 Bell St
Seattle, WA 98121

Biamp Systems
PO Box 2160
Portland, OR 97208

Ibanez/Hoshino
1716 Winchester Rd
Bensalem, PA 19020

Valley People
2817 Erica Place
Nashville, TN 37204

Brooke Siren Systems
30B Banfi Pl N
Farmingdale, NY 11735

Connectronics
652 Glenbrook Rd
Stamford, CT 06906

JBL/UREI
8500 Balboa Blvd
Northridge, CA 91329

Yamaha Combo Div
PO Box 6600
Buena Park, CA 90622

Microphones

WIRELESS MICROPHONES

CETEC-VEGA

T-36 PRO is a cardioid condenser with a hand-held transmitter, using an E-V BK-1 element. It operates with any of the company's PRO or PRO PLUS receivers. Length is 10.2 inches; weight is 10.2 oz; finish is black ABS.

Price: \$875.00.

T-81 PRO PLUS is a dynamic cardioid using a Shure SM58 element, and using any of the company's transmitters. Length is 10.75 inches; weight 13.5 oz; finish is black ABS.

Price: \$1098.00.

T-82 PRO PLUS is similar to the T-36 above, but uses a Shure SM85 element. Dimensions are also similar to the T-36.

Price: \$1098.00.

T-83 PRO PLUS is also similar to the T-36, but uses an AKG C-535 element. Length is 9.85 inches, weight is 9 oz.

Price: \$999.00.

T-84 PRO PLUS uses a Beyer ribbon hypercardioid element. It is also similar to the T-36, but dimensions are 10.5 inches length; and weight is 13.5 oz.

Price: \$1248.00.

T-87 PRO PLUS has a Shure SM87 supercardioid element and is also similar in size and weight to the T-36. All units operate with any Cetec Vega receiver.

Price: \$1098.00.

Microphones

Model	Type	Pattern(s)	Frequency Response, dB, ±	Impedance, ohms	Sensitivity, 1 kHz, -dBm	Sound Pressure Level of 1% distortion	Dimensions, L x W	Weight, oz.	Finish	Connector	Price, \$	Features
AKG ACOUSTICS												
D-112	card	20-17k	210	-55	168	5.9	13		dark	xlr	\$185.00	Designed for bass instruments.
D-130NR	card	50-13k	220	-55	128	6.9	9		gray	xlr	\$125.00	Ideal for hand-held broadcast.
D-310NR	card	80-18k	270	-58	128	7.5	8.5		gray	xlr	\$140.00	Ideal for touring groups.
D-321	hyper card	40-20k	300	-57	128	7.3	12		gray	xlr	\$175.00	Special patented transducer suspension removes handling and cable noise.
D-330NR	hyper card	50-20k	370	-58	128	7.3	12		gray	xlr	\$240.00	Has bass and treble switches.
C-410	elect card	20-20k	300	-50.5	123	5.2	4.6		matte	xlr	\$195.00	
C-414EB/P48	cond	20-20k	200	-41	142	5.6	10		black	xlr	\$895.00	Bass roll-off and attenuator built-in.
C-460B/CK-61	cond card	20-20k	120	-43	134	6.8	4.9		black	xlr	\$485.00	Ideal for high quality sampling.
AUDIO DESIGN												
CAIREC												
CM4050	any	20-20k	100		140	9.5	18		black	tuchel	\$4990.00	
Sound-field		1			5	1.5						
CM2001C	omni	20-20k	200		130	3.5	4.2		black	xlr	\$350.00	
CM2050C	card	30-20k	200		130	6.3	4.2		black	xlr	\$320.00	
CM2056C	card	40-20k	200		130	7.3	4.5		black	xlr	\$470.00	
AUDIO-TECHNICA												
AT871	card	30-20k	400	-44	130	5.7	13		black	xlr	\$260.00	This unidirectional mic features high sensitivity, low mechanical noise, high signal to noise and battery or phantom power.
AT853	card	40-20k	400	-50	130	1.1	.5		black	xlr	\$195.00	This is a miniature mic with linear off-axis pickup. Battery or phantom power.
ATM5R	card	40-20k	200	-53	141	5.1	4		gray	xlr	\$250.00	This is a miniature hand-held mic that will handle high SPLs with low handling noise.
ATM33R	card	30-20k	150	-45	141	7	4.7		gray	xlr	\$225.00	This mic features high signal to noise and broad, linear on and off-axis response.

HM ELECTRONICS

System 42 is a body pak system using a full studio receiver functions and employs a soft compressor/limiter. Several mic elements can be supplied. The transmitter weighs 4.5 oz with battery.

Price: \$1,605.00.

System 420 employs the same transmitter as the system 42 above with a simple easy-to-use receiver. The receiver can be powered by external d.c. for economical portable applications.

Price: \$895.00.

System 82 is a top-of-the line body pac unit and can be supplied with various elements. Transmitter weight including battery is 4.5 oz.

Price: \$2,400.00.

System 87 is stated to be the company's best hand held system. The Shure SM87 condenser element is used. Weight of the mic including battery is 15 oz.

Price: \$2,600.00.

System 58 is similar to the System 87 above, but uses the Shure SM58 dynamic for more "proximity" effect. Dimensions are the same as the System 87.

Price: \$2,500.00.

System 85 is identical to the System 87 above, but uses the Shure SM85 element for bright, crisp sound.

Price: \$2,600.00.

NADY SYSTEMS INC.

501 VHF HT< are a system approach. The HT is a hand-held unit with no protruding antenna. It uses an AT-PR 60 dynamic element. The LT transmitter is for lavalier mics and will phantom power them.

Price: \$850.00, depending on equipment.

601/701 VHF LT & HT use two separate front end receivers for "true diversity" reception. Various microphone transmitters are available depending on application.

Prices range from \$2,100.00 to \$3,200.00.

PEAVEY ELECTRONICS

Wireless Performer is a dynamic cardioid high-band system which can be expanded to diversity by using a second receiver. The receivers are standard rack mount. Dimension of the hand-held mic are 9.75 inches by 1.75 inches.

Price: \$649.50.

SAMSON PRODUCTS

Broadcast series units use a digitally synthesized diversity rack-mount receiver. Shure SM58, SM85, and SM87 elements can be supplied. Instrument and lavalier systems come standard with the TH-1 belt-pak transmitter.

Prices range from \$1375.00 to \$1700.00.

Stage series units offer cost effective VHF operation and come with the TH-1 belt pak as well. There are other belt-paks and receiver systems as well including extremely compact units.

Prices range from \$450.00 to \$975.00.

TELEX COMMUNICATIONS

FMR-21 WHM 500 system uses a cardioid condenser element and also uses true dual antenna diversity reception. Finish is matte black. Dimensions are 12.67 inches; weight is 14 oz.

Price including receiver: \$1,585.00.

For Your Audio Library

The Recording Studio Handbook

by John Woram

\$39.50

The Recording Studio Handbook is an indispensable guide with something in it for everybody. It covers the basics beautifully. It provides in-depth insight into common situations and problems encountered by the professional engineer. It offers clear, practical explanations on a proliferation of new devices. In this updated edition, among the items covered are: Transducers, signal processing, noise reduction, recording techniques and more . . . In addition, it has been expanded to feature three all-new chapters . . . chapters on the in-line recording studio console, digital audio and time code implementation.

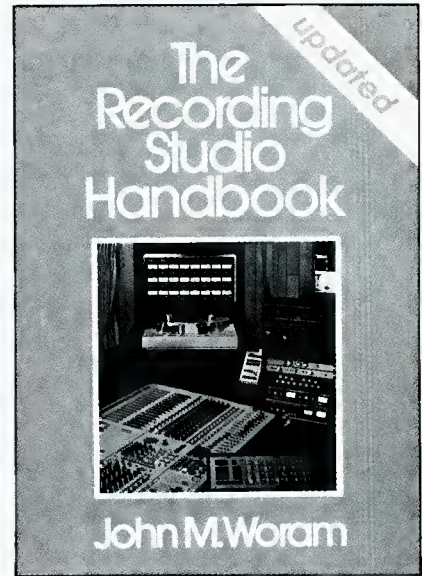

The Microphone Handbook

by John Eargle

\$31.95

Completely up to date, this vital new handbook is a must for any professional whose work involves microphones. Among the topics covered are: Directional characteristics—the basic patterns, using patterns effectively, microphone sensitivity ratings, remote powering of condensers and proximity and distance effects. Other topics include: Multi-microphone interference problems, stereo microphone techniques, speech and music reinforcement, studio microphone techniques and microphone accessories. You'll find yourself reaching for it every time a new or unusual problem crops up.

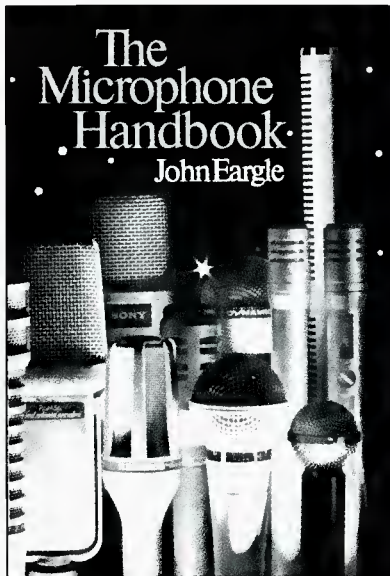

Please send the books indicated below:

_____ copy(s) of The Microphone Handbook at \$31.95 plus \$2.00 for postage and handling per book.
 _____ copy(s) of The Recording Studio Handbook at \$39.50 plus \$2.00 for postage and handling per book.
 _____ Both books at \$67.50 plus \$3.00 for postage and handling. (Over 5% savings!)

Outside the US, checks must be made in US funds drawn on a US bank.

Mastercard Visa Exp. Date / __ / __

--	--	--	--	--	--	--	--	--	--	--	--	--	--	--	--	--	--	--	--	--	--	--

Name _____

Address _____

City _____ State _____ Zip _____

Signature _____

Send to: ELAR Publishing, 1120 Old Country Rd., Plainview, NY 11803

Model	Type	Pattern(s)	Frequency Response, dB, ±, -dB	Sensitivity, mVts - dBm	Impedance, ohms	Sound Pressure Level, dBm	Dimensions, D x W x H, in.	Finish	Connector	Price, \$	Features
BRUEL & KJAER											
4003	cond	10-20k	30	-24	135	6.5	5.3	flat	xlr	\$810.00	Low noise, powered by 2812 for maximum headroom and transformerless operation.
+2812		2			1	16mm		black			
4004	cond	10-40k	30	-38	148	6.5	5.3	flat	xlr	\$810.00	High intensity mic powered by 2812 for maximum headroom and transformerless performance.
+2812		2				12mm		black			
4006	cond	20-20k	30	-36	135	6.5	5.3	flat	xlr	\$897.00	Low noise mic with standard 48V phantom powering.
		2			1	16mm		black			
4007	cond	20-40k	30	-50	148	6.5	5.3	flat	xlr	\$897.00	High intensity mic with standard 48V phantom powering.
		2			1	12mm		black			
BEYER DYNAMIC											
M260	dyn ribbon	50-18k	200	-150	7.5	7.5	11	matte black	xlr	\$230.00	Has a high energy ribbon transducer which responds instantly to transients.
M380	dyn m/c	15-20k	600		140	6.3	13	brush bronze	xlr	\$260.00	Has a durable moving coil element that withstands high SPLs with distortion or overload.
		8			5	2.6					
MC734PA	cond	20-18k	150	-138	138	7.7	9.5	matte black	xlr	\$790.00	Has improved cartridge suspension system which withstands high SPLs and shortens speech distance.
MC740	cond	40-20k	150	-133	134	8.5	14	matte black	xlr	\$1000.00	This dual membrane mic can reproduce vocals and instruments without overload at extremely high SPLs.
M69	dyn m/c	15-16k	200	-145	5	1.5	11	matte black	xlr	\$180.00	Has true hypercardioid pickup pattern.
M88	dyn m/c	30-20k	200	-145	7.1	7.1	11	matte black	xlr	\$330.00	Can handle very high SPLs.
M160	dyn ribbon	40-18k	200	-152	1	6.1	5.5	matte black	xlr	\$400.00	Has dual low mass, low inertia ribbons.
M201	dyn m/c	40-18k	200	-150	1	6.3	7.8	matte black	xlr	\$220.00	Has integral humbucking coil to reduce magnetic field interference.
CARVIN											
CM-68	dyn	45-15k	250	-77	6.4	6.4	10	black	xlr	\$99.00	Custom tailored for vocal requirements.
		3			1.5						
CM-67	dyn	40-15k	250	-77	6.5	6.5	10	black	xlr	\$99.00	This mic is slightly more directional than the CM-68.
		3			2						
CM-90E	cond	20-20k	250	-82	7.2	7.2	7	black	xlr	\$139.00	This is a high sensitivity mic suited to studio and live applications.
		3			1						

Model	Type	Patterns	Frequency Response, dB, +, -dB	Impedance, ohms	Sensitivity, 1 kHz, -dBm	Dimensions, L x W	Weight, oz.	Finish	Connector	Price, \$	Features
GROWN											
GLM-100/ENG	elect	60-20k 2	240	-72	150 3	mini	2.8	matte black	xlr	\$199.00	Battery or phantom power.
GLM-200/ENG	hyper-card	60-20k 2	100	-66	140 3	mini	3.2	matte black	xlr	\$234.00	This is a hypercardioid lavalier mic intended for broadcast use. It has user accessibility for shaping high end response.
GLM-100/D	elect	60-20k 2	240	-72	140 3	mini	5.4	matte black	xlr	\$339.00	This is a dual element lavalier mic intended for broadcast use.
GLM-200/D	hyper-card	60-20k 2	100	-66	140 3	mini	5.5	matte black	xlr	\$429.00	This is a dual element lavalier with high rejection of paper and studio noise in broadcast applications.
PZM-20RG	PZM	20-15k 2	150	-70	150 3	4.5	6.5	matte black	xlr	\$299.00	This is intended for use in conference rooms, etc.
GLM-200/G	elect	25-25k 2	100	-66	150 3	4.5	6	matte black	xlr	\$249.00	This is a wide-range mini mic mounted on the end of a flexible gooseneck.
PZM-P	elect	20-20k 2	200	-65	150 3	.75	7	black silver	xlr	\$399.00	PZM mic with circular, beveled boundary, improved quieter electronics, and wide-ranged, smooth response.
ELECTRO-VOICE											
N/D 408	dyn	30-22k card	150	-50	4.55	6.7	6.7	matte black	xlr	\$228.00	Has large-diaphragm design for extended high frequency response.
N/D 308	dyn	40-20k card	150	-53	2.85 4.55	6.7	6.7	matte black	xlr	\$186.00	Same as N/D 408.
RE20	dyn	40-18k card	150	-57	2.85	1.6	1.6	beige	xlr	\$545.00	
RE98	elect cond	80-15k card	150	-45	2.15	.67	.67	black	xlr	\$218.00	This is a miniature lavalier mic.
RE15	dyn	80-15k card	150	-56	.85 .425	6	6	beige	xlr	\$286.00	Has integral blast/pop filter.
RE16	dyn	80-15k card	150	-56	1.4 7.38	8	8	beige	xlr	\$296.00	Same as the RE15.
DS35	dyn	60-17k card	150	-60	1.75 7.25	9.2	9.2	beige	xlr	\$176.00	
CS15P	elect	40-18k card	150	-45	1.875 6.95	8	8	beige	xlr	\$292.00	Ideal for vocal and instrument recording.
FOSTEX											
M22	dyn	40-18k m/s	600	-54.8	2.8			black		\$899.00	This stereo mic is ideal for broadcasters and recording studios.
M88	ribon	40-18k bi	600	-55.8	3.6 5.5			black	xlr	\$539.00	Has deep notch 90 degree off-axis at all frequencies.
M11	ribon	40-18k card	600	-54.8	2			black	xlr	\$499.00	Has 3-position low frequency roll-off to make it suitable for kick-drum.
M77	ribon	40-18k card	250	-56	7 2.5			black	xlr	\$399.00	Has 3 position equalizer switch.
M51	ribon	80 20k card	250	58	1.8 6.8		10	black	xlr	\$179.00	

Model	Type	Pattern(s)	Frequency Response, dB, ±		Impedance, ohms	Sensitivity, 1 kHz, -dBm		Dimensions, L, D, W	Weight, oz.	Finish	Connector	Price, \$	Features
			20-20k	100-10k		1 kHz, -dBm	Distortion						
NEUMANN													
TLW 170	cond	card	40-18k	150		140	6	22	black	xlr		\$1250.00	Transformerless studio mic.
U 89	cond	card	40-18k	150		122	2.5	14	black	xlr		\$1235.00	
U 87A	cond	card	40-16k	200		117	7.75	18	black	xlr		\$1300.00	
KM 84	cond	card	40-20k	200		120	4.25	3	black	xlr		\$398.00	This mic has uniform off-axis response + / -35 degrees.
PASO													
M501	dyn	card	50-15k 3	250	-151		1.75	15	gray	cable			
M601	dyn	card	50-15k 3	250	-151		6.25	9	gray	xlr			
M701	dyn	card	40-16k 3	250	-151		6.25	11	gray	xlr			
M800	dyn	card	40-18k 3	250	-151		6.25	11	gray	xlr			
PEAVEY													
PVM-38	dyn	card	50-16k	300	-56		5.75	7	gray	xlr		\$199.50	Has dual element internal pop filter and an integral hum compensation coil.
PVM-45	dyn	hyper card	40-16k	300	-56		1.8	7	gray	xlr		\$199.50	Features probe style construction and hum compensation coil.
PV Mic	dyn	card	60-16k	600			1.45	8	gray	xlr		\$99.50	Has handle mounted on/off switch.
EC-10	elect	card	40-20k	150	-51		6.5	7.5	gray	xlr		\$140.00	
EC-11	elect	card	30-20k	150	-51		1.75	7.5	gray	xlr		\$140.00	
EC-15	elect	cond	40-20k	150	-43		1.75	7.5	gray	xlr		\$135.00	
ROSS													
RM7H/L	dyn	card	30-18k	600	-78		7		black champ	1/4-in.		\$49.00	
RM8H/L	dyn	card	30-18k	50k	-78		1.5		black	1/4-in.		\$69.95	
RM9L	dyn	card	30-18k	250	-76		1.5		black champ	xlr		\$99.95	
RM10L	dyn	card	50-15k	200	-71		1.5		black champ	xlr		\$149.95	Has AKG element.

Model	Type	Pattern(s)	Frequency Response, dB, \pm	Sensitivity, ohms	Impedance, ohms	Sound Pressure Level at 1 kHz, -dbm	Dimensions, D x W	Finish	Connector	Price, \$	Features	
												Dimensions, D x W
SENNHEISER												
MD-421	dyn	card	200			18	black	xlr	\$332.00		Has 5-position bass roll-off, and withstands high SPLs.	
MD-431	dyn	hyper-card	250			1.3	metal	xlr	\$355.00		Has lockable on/off switch, and is suitable for close talk, high feedback situations.	
MD-4410	dyn	super card	200			1.4	chrome	xlr	\$469.00		Available with 5-position bass roll-off and brilliance boost switch.	
MD-409	dyn	card	200			6.3	gold & black	xlr	\$249.00		Suited for close proximity, high SPL applications.	
MKH-40	cond	card	150		142	6.5	black	xlr	\$685.00		Well suited for digital sampling.	
MKE-42PU	elect	card	1000		5	4.5	black	xlr	\$299.00		This is a pencil thin gooseneck designed for phantom powering off mixers and mixers.	
MKE-2	elect	omni	1000				black	any	\$190.00-295.00		Available in wireless and wire formats.	
MKH-816	cond	shotgun	10			1.4	black	xlr	\$954.00		Available in a variety of formats.	
SHURE BROTHERS												
SM83	cond	omni	150	-45	131	.8	black	xlr	\$210.00		Has 730 Hz notch filter to compensate for chest resonance.	
SM89	cond	shotgun	150	-28	126	20.6	black	xlr	\$900.00		Offers uniform response up to 30 off-axis without comb filtering. Switchable low frequency cutoff.	
SM91	cond	card	150	-41.5	144	5.1	black	xlr	\$300.00		Surface mount half cardioid mic.	
SM98	cond	card	150	-53	153	1.2	black	xlr	\$250.00		Handles up to 143 db. Has pop filter.	
SM2	dyn	card	150	-66		1	black	kit	\$200.00		Lightweight headset with broadcast quality noise cancelling mic.	
SM63L	dyn	omni	150	-56.5		head-set	black	leads	\$128.00		High output mic with low handling noise.	
SM81	cond	card	150	-40.5	146	8.4	champ-agne	xlr	\$336.75		Has 3-position low frequency response switch, lockable 10 dB attenuator, and pop filter grille.	
SM82	cond	card	250	0.0	135	1.2	champ-agne	xlr	\$365.00		Balanced line level output drives phone lines directly, built-in limiter prevents overload.	
TELEX COMMUNICATIONS												
TE 10	cond	card	150	-75	140	7.4	matte black	xlr	\$150.00		Element is suspended by flexible "fingers" which isolate it from shocks.	
TD 11	dyn	card	200	-77		9.2	matte black	xlr	\$132.00		Has tight cardioid pickup pattern.	
LM-100	cond	omni	150	-74		1	matte black	xlr	\$198.00		Lapel mic system that includes LM-101 mic, 3-foot cable, and in-line power supply.	

Model	Type	Patents	Frequency Response, dB, ±	Impedance, ohms	Sensitivity, 1 kHz, -dBm	Sound Pressure Level, dBm	Dimensions, L x W	Weight, oz.	Finish	Connector	Price, \$	Features
YAMAHA INTERNATIONAL												
MZ101	dyn	40-17k	250 -76	150	6.5	9.4	metal	xlr		\$120.00		Has a two-layer laminated polyester diaphragm.
MZ104	dyn	40-18k	250 -77	150	1.87	9.9	brown metal	xlr		\$130.00		As model MZ1010 above.
MZ102Be	dyn	40-18k	250 -76	150	1.5	9.4	brown metal	xlr		\$170.00		Has 3-layer laminated beryllium film diaphragm.
MZ103Be	dyn	40-18k	250 -75.5	150	6.5	9.9	brown metal	xlr		\$210.00		As model MZ102Be above.
MZ105Be	dyn	30-17k	250 -77	150	6.2	9.7	grey metal	xlr		\$180.00		As model MZ102Be above.
YORKVILLE SOUND												
IM200	cond	20-20k	200 -66							\$99.00		
IM-400	dyn	50-15k	250 -77							\$125.00		
IM-400A	dyn	50-15k	300 -76							\$105.00		
IM-500H	dyn	20-16k	20k -57							\$69.00		

Microphones

AKG Acoustics
77 Selleck St
Stamford, CT 06902

HM Electronics
9675 Business Park Ave
San Diego, CA 92131

AMR
Route 2, Highway 503
Decatur, MS 39327

Nady Systems, Inc
1145 65th St
Oakland, CA 94608

Audio Technica US, Inc
1221 Commerce Dr
Stow, OH 44224

Neumann
see Gotham

Audio + Design/Calrec
PO Box 786
Bremerton, WA 98310

Paso Sound Products
14 First St
Pelham, NY 10803

Beyer Dynamic, Inc
5-05 Burns Ave
Hicksville, NY 11801

Peavey
711 A Street
Meridian, MS 39301

Bruel & Kjaer Instruments, Inc
185 Forest St
Marlborough, MA 01752

Ross
1316 E. Lancaster St
Ft. Worth, TX 76102

Carvin
1155 Industrial Ave
Escondido, CA 92025

Samson
124 Fulton Ave
Hempstead, NY 11550

Cetec Vega
9900 Baldwin Pl
El Monte, CA 91731

Sennheiser Electronics
48 W. 38th St
New York, NY 10018

Crown International
1718 W. Mishawaka Rd
Elkhart, IN 46517

Shure Bros
222 Hartrey Ave
Evanston, IL 60204

Electro Voice
600 Cecil St
Buchanan, MI 49107

Telex Communications
7600 Aldrich Ave South
Minneapolis, MN 55420

Fostex Corp of America
15431 Blackburn Ave
Norwalk, CA 90650

Yamaha Combo Div
PO Box 6600
Buena Park, CA 90622

Gotham Audio Corp
1790 Broadway
New York, NY 10019

Yorkville Sound Inc
56 Harvester Ave
Batavia, NY 14020

LEN FELDMAN
Sound With Images

Handling Beta and VHS Audio

It's rare that as a person involved in the professional end of audio you will witness a shift in the way that the industry handles audio. The fact that the VHS format developed by JVC arrived at the market first, and the Beta format developed by Matsushita followed, is a testament to the fact that the industry is still in a state of flux. The fact that the VHS format arrived first, and the Beta format followed, is a testament to the fact that the industry is still in a state of flux.

can expect by way of audio fidelity in each of these VCR formats. Have you even wondered why the home VCR systems which offer all the capabilities of stereo video signal are priced at well above 2 MHz have not been made? Maintaining that audio frequency response out to 10,000 Hz for in some cases, is a lot less than that. To understand this seeming contradiction you have to know a little about how the VCR works. In the accompanying diagram we see the tape path employed in both the Beta and VHS video recording systems. Video record play heads are mounted so that their gaps are in the perspective of a rotating drum that drum rotates at 1,800 rpm, which adds up to 30 revolutions per second. This speed was selected because of the 1.5" NTSC VHS standards call for 30 pictures per second. The tape is positioned on the drum so that it is moving at the same speed as the drum. In other words, the tape is moving at 1,800 rpm, which adds up to 30 revolutions per second. In just one revolution of the video head drum the system has written two video fields on one complete drum frame.

ACTUAL AUDIO TAPE SPEED IN BETA AND VHS VCRs

The original Betamax system of picture recording and playing is a 1.5" format which uses a maximum of 11 tracks which tape a video signal which moves at an average speed of 1.575 in. This is a little less than the VHS system which uses a maximum of 11 tracks which tape a video signal which moves at an average speed of 1.575 in. This is a little less than the VHS system which uses a maximum of 11 tracks which tape a video signal which moves at an average speed of 1.575 in.



T IN MANY AMERICAN universities, the study of audio is a relatively new field. The study of audio is a relatively new field. The study of audio is a relatively new field. The study of audio is a relatively new field. The study of audio is a relatively new field.

ER HAMMAR and DON OSOSKE
The Birth of the German Magnetophon Tape Recorder 1928-1945
The following article is based on research done in the archives of the German radio station in Berlin. Author Hammar is a radio station engineer and Don Ososke is a radio station engineer.

db - the most reprinted magazine in the audio industry works for you over and over again

Broadcast Applications For Activated Phones

Studio West Station 42
Here we have an inside look at one of New York's most successful and up-to-date audio/video recording studios.

Designing Audio For Video

Editel is one company that has decided to do something about changing the image of sound mixing for video. The audio for video is a relatively new field. The audio for video is a relatively new field. The audio for video is a relatively new field. The audio for video is a relatively new field.

A Review From
cancer
c-type developer, inc
P.O. Box 1069 Palatine Illinois 60078 (312) 359-9240 or 1-800-562-5872
Tels: 280-502-PROTON/PALAT

db
Sagamore Publishing Co., Inc.
New York
New York, NY 11202

New Products

INTERSONICS SUBWOOFERS

• Intersonics Inc.'s new generation of subwoofers are known as the SDL Foundation Series. The SDL-4 and SDL-5 cabinets feature new, computer-assisted designs and innovative power-cooling of the high-tech servo motor. The results are peak outputs in excess of 139 dB at 1 meter, greater efficiency, extended frequency response, and overall high fidelity performance. The cabinets are designed for light-weight, compact road use as well as easy installation. Enhancements of the original SDL Servo-Drive Design deliver high fidelity sound and greater performance from fewer cabinets. Measuring 22.5 x 45 x 45-inches, the SDL-5 in concert sound applications is best utilized operating below 100 to 125 Hz, and is quite compatible with full range systems, or for bass, kick-drum, synthesizer and special effects. Preliminary specifications include a 24 Hz-150 Hz frequency

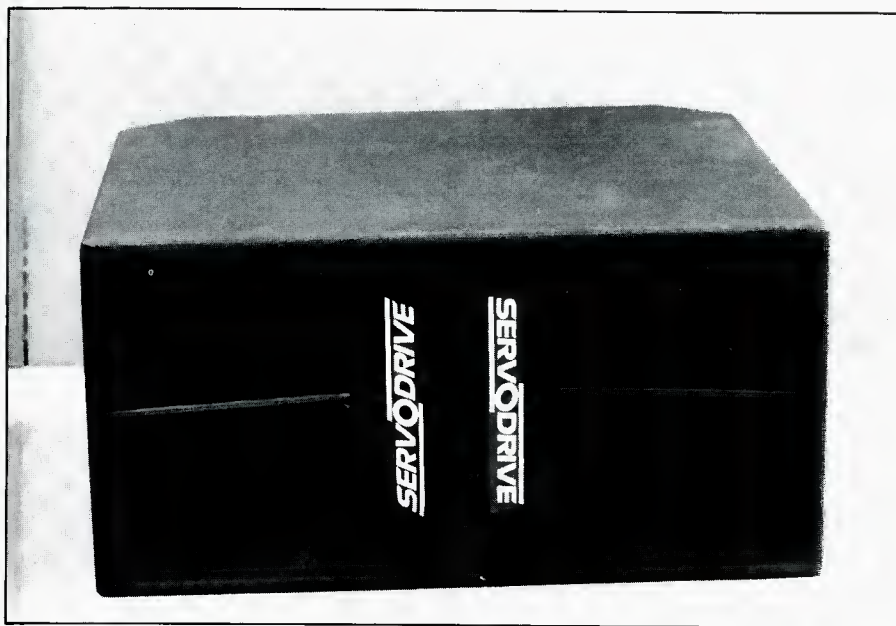

response, 400 watt power capacity, and a 4-ohm nominal impedance. The models are finished in 13-ply Baltic birch plywood and come standard with use-

resistant carpeting and recessed handles.

Mfr: Intersonics Inc.

Circle 40 on Reader Service Card

KURZWEIL MIDI EXPANDER

• Kurzweil's rack-mounted expander, the Kurzweil 150, is for use with any MIDI-equipped keyboard or control source. It is a multi-timbral sound source equipped with 22 instrument voices designed to be controlled via MIDI. It features a range of keyboard, guitar, bass, and mallet sounds. Acoustic keyboard voices include 2 harpsichords and 2 pianos. Among the electric keyboard voices there are 2 different pianos modeled on the well known Fender Rhodes sound. Other voices include 3 different acoustic guitars, and acoustic and electric bass; 4 analog synthesizers; and 2 mallet instruments, vibraphone and marimba. Sixty preset programs give the user access to a variety of sound options that can be called up at the touch of a button. In addition, the K150 permits the user to create his own programs, which can be stored in the K150's battery-backed,

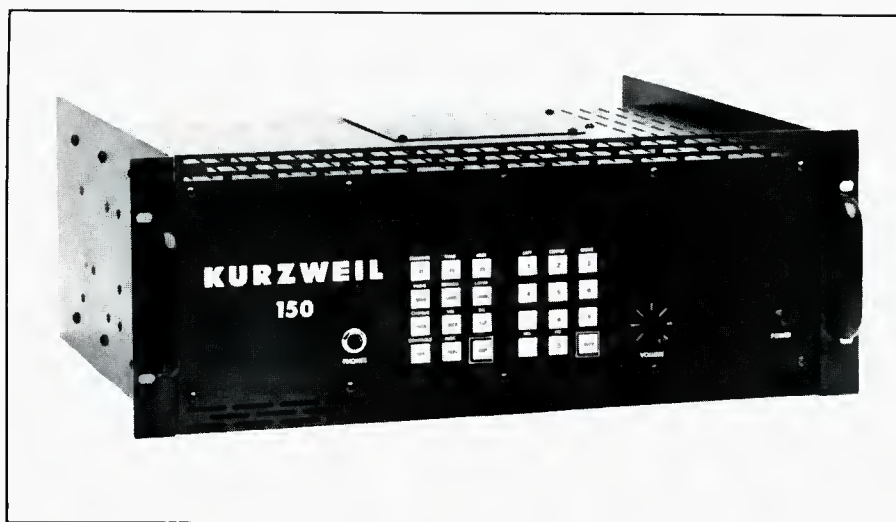

non-volatile memory. The unit's instrument voices—and the programs that control them—are located on ROM chips. The K150 can accommodate 5 additional ROM chips so that more

sound can be added to the instrument later.

Mfr: Kurzweil Music Systems

Price: \$2,995.00

Circle 41 on Reader Service Card

SOUNDMASTER EDITING SYSTEM

• The Soundmaster Integrated Editing System incorporates Syncro® and is totally programmable. Controlled by the IBM PC-based Soundmaster® software, Syncro communicates with the host computer via its 5 MHz data buss. "Smart" machine mounted interfaces allow for universal cabling, and modular construction facilitates rapid field expansion to 16 or more units. Each Syncro contains an 8088 and 8087 microprocessor, and onboard RAM to support edit list multi-tasking. Features include variable speed lock from up to 1/3 to 3 times play speed, numerous programmable closures for external device tripping, the designation of the master machine via the keyboard, simultaneous synchronization of all international time codes, and the capability to servo the master to an external sync source. The Soundmaster Control Software is also enhanced, and

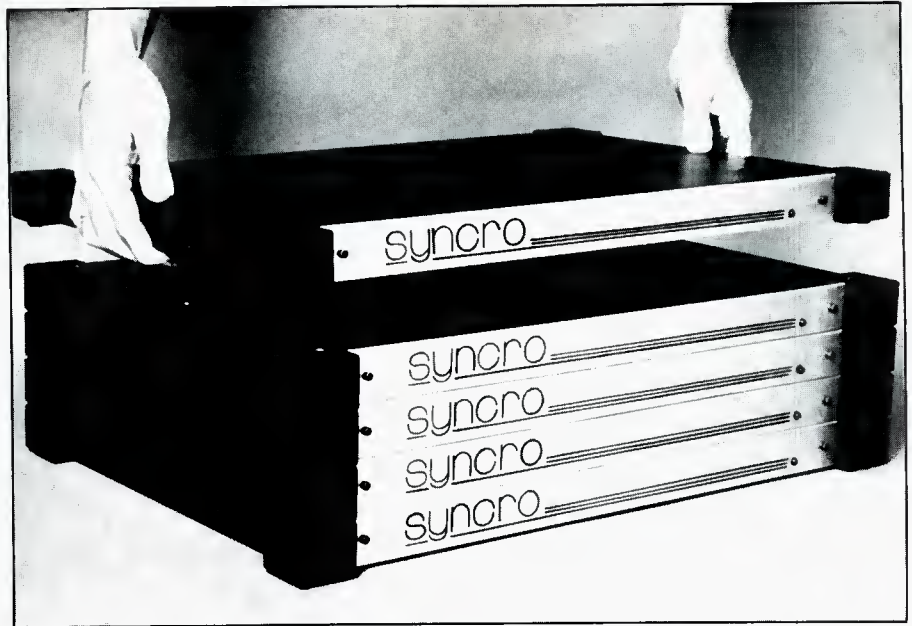

includes significantly expanded edit list features. The system comes complete with cables and interfaces.

*Mfr: Soundmaster International Inc.
Price: \$12,915.00.*

Circle 42 on Reader Service Card

DELTALAB MONITOR

• DeltaLab, the Pro Audio Division of Analog & Digital Systems, Inc. (ADS), has introduced its first studio monitor to the market, the M1. It is a 2-way acoustic suspension, near-field monitor for use in referencing recordings to automotive playback situations and stereo television broadcast. The M1 employs a 1 inch soft dome tweeter woven of polyester fibers that are extremely low in mass yet possess excellent internal damping characteristics. A narrow magnetic voice coil gap results in high strength and efficiency, and the driver combines flat frequency response with high power handling and quick transient capability. The monitor's 4-inch woofer is constructed of Stiffite, a proprietary material chosen for its light weight and high rigidity; it yields superior transience without coloration. The driver's premium butyl rubber outer surrounding helps eliminate distortion at the limits of excursion while its linear drive voice coil is tightly controlled over the full range of travel to further assure clean, clear bass. The monitor also features a protection circuit designed to be triggered by either thermal or electrical overload. When the unit is overdriven, this interrupts the potentially damaging signal. The circuit is automatically reset and speaker operation restored approxi-



mately 20 seconds after amplifier gain is lowered. The M1's bandwidth is 85 Hz to 20 kHz, its sound pressure level is 88 dB from 2.8 volts RMS (1 watt) measured at 1 meter and its power handling capability is 30 watts RMS (150 watts peak power). It is housed in

a sturdy aluminum cabinet finished in lightly textured matte gray and its acoustically transparent grille is of perforated steel.

*Mfr: Analog & Digital Systems, Inc.
Price: \$129.00 each.*

Circle 43 on Reader Service Card

UNIVERSAL AUDIO INTERFACE

• Four Designs Co.'s RTS-321 is an audio interface that provides the user with an easy means to connect various pieces of equipment that use either 1/4-inch (ring-tip-sleeve) or XLR type connectors. The RTS-321 eliminates the need for numerous adapters or special cables. Instead, five miniature slide switches allow instant user selection of several internal wiring schemes to suit each application. The RTS-321 carries a one-year limited warranty.

Mfr: Four Designs Co.

Price: \$29.95.

Circle 44 on Reader Service Card

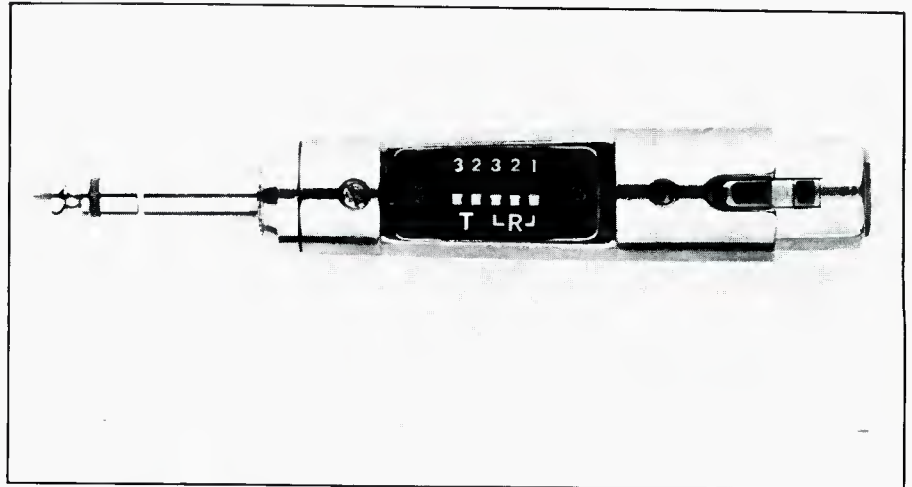

AUDIX DYNAMIC MIC

• Audix Corporation's UD-20H is a rugged vocal/instrument dynamic microphone for home recording, portastudios, VCRs, and public address use. It is a high impedance microphone with a smooth response from 80 Hz to 15 kHz, a tight cardioid pick-up pattern, field replaceable capsule, shock absorbant steel mesh grille with integral pop filter, and on/off switch. It is available in black finish and is supplied with an attached 16-foot high impedance mic cable terminated in a 1/4-inch male connector.

Mfr: Audix Corporation

Price: \$82.50.

Circle 45 on Reader Service Card



ALESIS MIDI DIGITAL SIGNAL PROCESSOR

• The Alesis Corporation's MIDIFEX Digital Signal Processor employs multiple delay lines, multiple high-pass, low-pass, and band-pass filters, and stereo digital reverb. Sixty-three pre-programmed studio effects are instantly available from the front panel or through MIDI control, including stereo generation, multitap delays, echo, ambience generation, multitap panning, and complex reverb algorithms. Many MIDIFEX programs combine all the unit's processing capabilities (time delay, filtering, digital reverb), thus eliminating time consuming programming.

Mfr: Alesis Corp.

Price: \$399.00.

Circle 46 on Reader Service Card



ELECTRO-VOICE RACKMOUNT MIXER

The EV 8108 8-input/4-output mixer provides maximum signal routing flexibility in a compact, rack-mount design. It is EV's answer to extensive field input requesting a straightforward, rack-mount mixer that provides signal outputs for a main system, a monitor system, a remote system, tape recording, broadcast and others—all likely to require different mixes. Unlike mixers designed primarily for live entertainment (/mi mixers) which, for example, assign house speakers to the right channel, the cry-room to the left channel, and require the use of a pan control to change this assignment, the 8108 provides direct channel assignment to four independent mono outputs for simplified operation. Transformer isolated inputs and outputs offer reliable freedom from RF interference and the annoying hum and noise caused by ground loops. In addition, the overall input/output gain

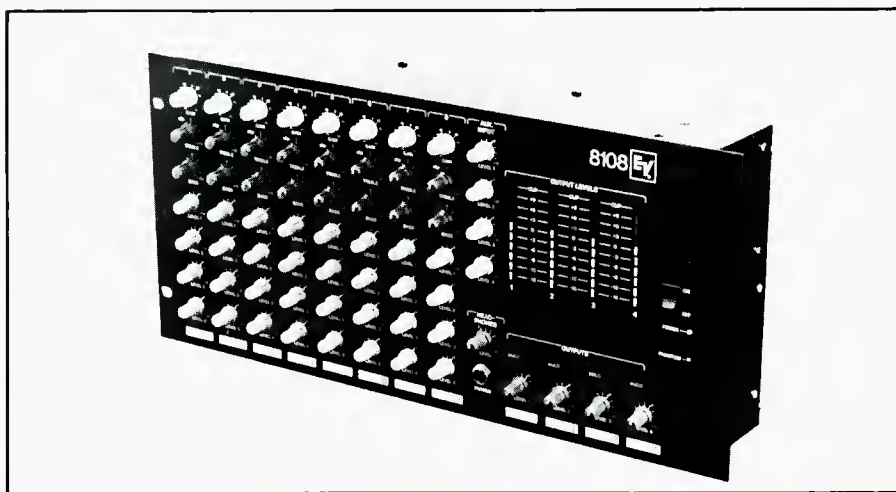

(90 dB) is high enough to provide hiss-free operation from low-level input signals, such as those from an amateur speaking several feet from a dynamic microphone. 48-V phantom power, output solo, and two-band channel EQ, continuously variable gain controls, and clip indicators on each

input offer convenience and operating ease. The 8108's versatile format also allows the mixer to be used in complex monitor systems with larger consoles to provide matrix routing for sub-groups. The 8108 is available for \$1,275.00.

Circle 52 on Reader Service Card

BLACET RESEARCH-ANALOG DELAY

The Time Machine II is a 19-in. rack mount delay line intended for applications where a high quality analog sound is required. This would include situations where the extended bandwidth or sound quality of digital delays would be undesirable. The Time Machine II is especially useful for warm reverberation type sounds, for use with drum machines, and for digital delay post processing. All functions of the unit are voltage controllable. This includes: delay time, effect level, LFO rate, LFO reset, modulation depth and regeneration. Also included is an envelope follower and control

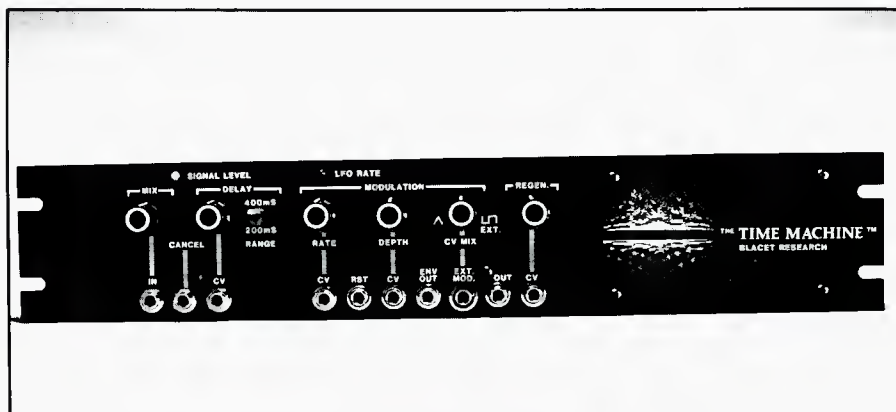

voltage mixer. Two delay ranges offer delay times of 10 ms to 400 ms. The Time Machine II is available direct from the factory and has a one year

warranty. The price is \$298.00 and includes shipping in the continental US.

Circle 55 on Reader Service Card

SENNHEISER HEADPHONE



The new Sennheiser HD 540 incorporates the design principles of circum-aural, open headphone technology, and an innovative new technique (RFT technique). The concept of this technique—employing a novel type of diaphragm with integral acoustic silk dampening and a new ear cushion design—affords virtually resonance-free transmission (from 16 Hz to 25

kHz) and exceptional transparency throughout the entire tonal spectrum, while effectively preventing standing waves between diaphragm and ear...thus making the HD 540 particularly suitable for listening to CD program material or studio use. The suggested price is \$159.00.

Circle 56 on Reader Service Card

SHELF FOR EQUIPMENT RACKS

• The Solid Support Rack Mount Shelf, the RS-1, allows you to add non-rack mountable equipment to your home or studio rack system. It takes two rack spaces and fits components of up to 17-in. wide and 17.5-in. deep. It fits in all standard 19-in. racks

and is constructed of 16 gauge steel in a textured, powder coated black finish. It also fits in rack-type road cases. *Mfr: Solid Support Industries.*

Circle 57 on Reader Service Card

SOUNDTRACS MONITOR CONSOLES

• The MC is a sound reinforcement console designed for all monitoring applications. Available in two main-frame sizes, 32 x 10 x 2 and 24 x 10 x 2, the features include ten monitor outputs plus two auxiliary outputs, all with full parametric eq and variable q, and a variety of pre/post fade selections; two independent auxiliary returns enable externally processed signals to be sent to the ten monitor output channels via 100 mm faders. Four-band eq with sweepable mid frequencies is included on the inputs along with pre/post fade select on the monitor and auxiliary sends. All twelve sends are controlled by a 65 mm linear fader and the input signal presence is indicated on an adjacent LED. Comprehensive talkback facilities include an indicator for external communications. Individual LED meters for monitor sends, auxiliary sends, solo, and peak indicators on each input

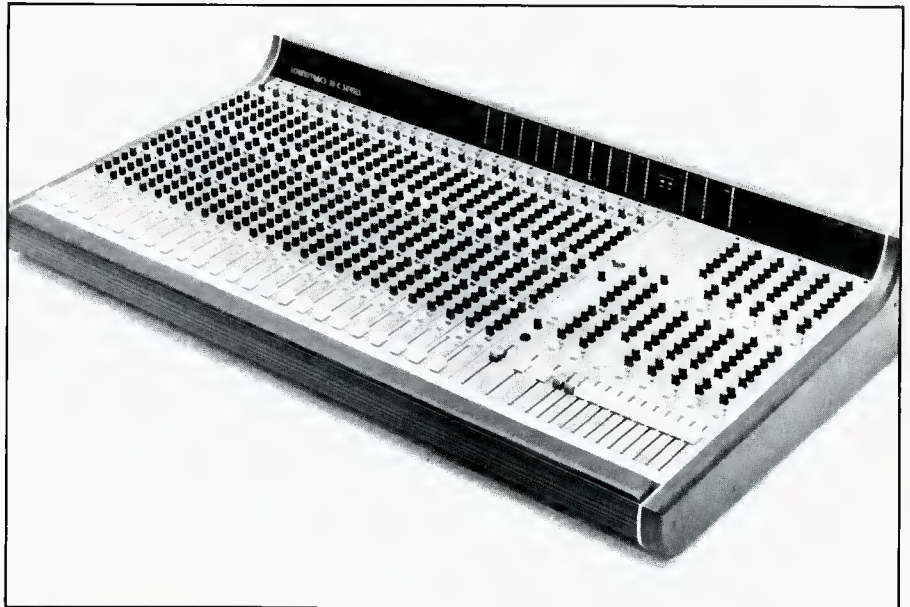

channel when used in conjunction with the signal present indicator provide comprehensive visual monitoring. The MC uses proven mechanical assembly and is rugged enough to withstand the

vigors of constant road use. *Mfr: Soundtracs LTD.*

Circle 58 on Reader Service Card

MIDI SOFTWARE FOR DX-7

• This software program, called AutoPilot, generates new sounds on the Yamaha DX-7 synthesizer and lets the user quickly edit all sound parameters and save the created sound patch onto disk. It uses several random selection methods to create new sounds, and additionally includes an all-joystick controlled visual graphic sound patch editor and disk librarian functions, giving the user a multi-function sound development package for the DX-7. AutoPilot will store to disk and retrieve from disk files containing 32 DX-7 sounds, or files containing only one DX-7 sound. The program requires a DX-7, a Commodore 64 with one disk drive and monitor, a MIDI adapter, 2 MIDI cables and an Atari type joystick.

Mfr: Ultimate Media, Inc.

Price: \$49.95.

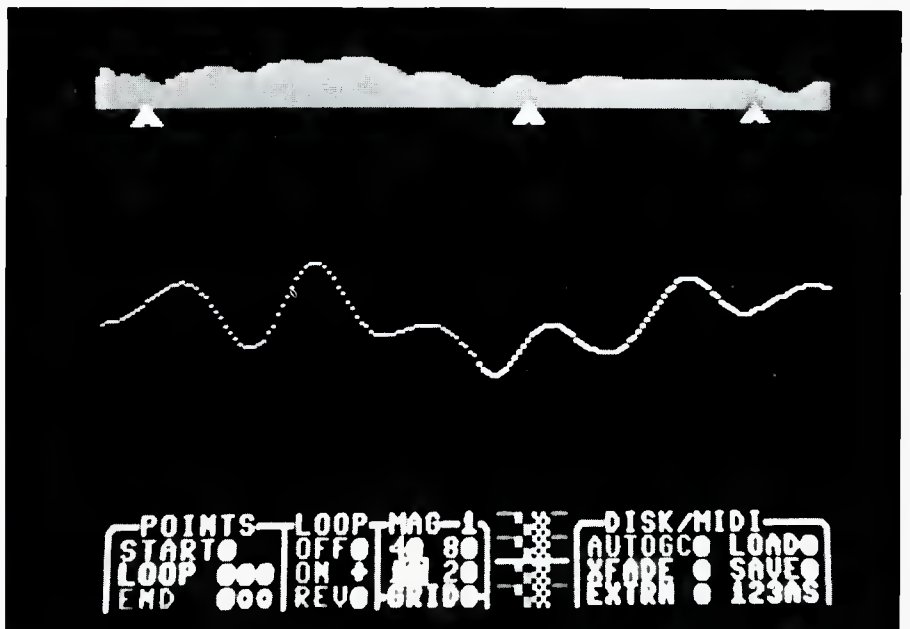

Circle 59 on Reader Service Card

Classified

Rates are \$1.00 per word with \$25.00 minimum. Boxed ads are \$40.00 per column inch. db Box Numbers are \$8.50 for wording "Dept. xx" plus \$1.50

for postage and handling
Discounts 3x-15%
6x-30%.

Send copies to:
db The Sound
Engineering Magazine
1120 Old Country Rd.
Plainview, NY 11803
att: Classified Dept.

ALL CLASSIFIEDS
MUST BE PREPAID.

WANTED: A used (in working order) or new Crown EQ-2. Please reply to **db Magazine**, Dept. 10, 1120 Old Country Rd., Plainview, NY 11803.

HEATSHRINK available by the foot in black sizes 3/64" to 1". For more info. and prices write to **Quality Audio Products PO Box 2595 Fairlawn, NJ 07410.**

COMPLETE 8-Track recording set-up—Otari 8-and-2-Track recorders, 16 x 8 console, effects dbx NR, mics, stands, 200 pt. patch bay, amps, etc. Everything pre-wired, ready to go. Three years old. \$17,000 or make offer. **Contact John at (409) 258-2189 (evenings).**



**TRACK SHEETS
BOX & REEL LABELS**

- Cassette Labels & Inserts
- Drum Machine Sheets
- Alignment Plaques
- Plus many other items

PRINTED WITH
Your Studio Name
Address & Phone

FREE CATALOG
of specialized forms for the
recording & music industries

STUDIOFORMS Co.
186 Glen Cove Av, Ste 201/ d-9, Glen Cove, NY 11542
(516) 671-1047

RADIO TRANSCRIPTION DISCS: Any size, speed. Drama, comedy, music, variety, adventure, soaps, children's, AFRS, big band remotes, library services. **Kiner-db, Box 724, Redmond, WA, 98073-0724.**

FREE 32pg Catalog & 50 Audio/Video Applic.

PWR SUPP. EQ.
PHONO, MIC,
TRANS. ACN,
TAPE, VIDEO,
LINE, OSC.

Stereo/Mono Pwr Ampl. 8-in/2-out, 12-in/4-out, 16-in/4-out
Video & Audio Dist Amplis. TV Audio & Recd Prod Consoles

OPAMP LABS INC (213) 934-3566
1033 N Sycamore Av LOS ANGELES CA, 90038

**1/3 Octave
Real Time Analyzer**

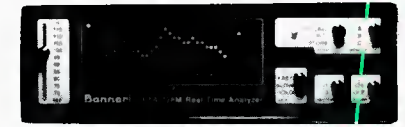

Real Affordable...\$495⁰⁰ Model 728
\$595⁰⁰ Model 728M with Memory

Banner (704) 487-7012
P.O. DRAWER 1803 • SHELBY, N.C. 28150

People, Places...

• **Jeffrey N. White**, who joined **Audio Technica US** in 1981 as a loudspeaker systems design engineer has been promoted to assistant national sales manager, professional products. Previously, he held posts in loudspeaker systems engineering and marketing at Electro-Voice, Inc. A graduate of Purdue University with a degree in electrical engineering, White is a member of the Audio Engineering Society. Audio-Technica manufactures and markets a variety of professional broadcast, recording, and sound reinforcement products, including microphones, mixer/recorders, headphones, microphone stands and accessories, and cables. The company also makes consumer audio and video prod-

ucts, including CD players, phono cartridges, stereophones, and care and maintenance systems for audio and video enthusiasts.

• **Manta Sound Studios** announced the installation of a package of Mitsubishi Digital Audio recording equipment that includes two X-850 32-channel digital multi-tracks, as well as two of the recently announced X-86 digital master decks according to the studio vice-president Sy Potma. One of Canada's largest studio facilities, Manta is one of the first to offer full digital recording in the country. The Mitsubishi X-850 recorder conforms to the recently published ProDigi (PD) Digi-

tal Audio Format, which calls for 32 tracks on the format's multi-track decks. The studio has also ordered two of Mitsubishi's new X-86 digital 2-track decks, which were recently unveiled at the AES Montreaux show. Until these decks become available, the studio has installed Mitsubishi X-80 decks.

• **Different Fur Recording**, San Francisco, Ca, has taken delivery of a new Sony PCM-3324 24-channel recording system. It also added a Yamaha Rev. 7 and a Yamaha SPX90 to its growing list of outboard gear which also includes a Lexicon 224 and a Lexicon 224XL.

• **Saul Walker** has been appointed the new manager for broadcast marketing at **Mitsubishi Pro Audio**. Walker, a recognized professional in the audio electronics industry, brings a wealth of both design and sales experience to Mitsubishi's New York sales team. Walker's role will be to develop sales for the firm's growing list of professional audio and film equipment. Before joining Mitsubishi, Walker served as vice-president of Marketing and Product Development at Straight Wire Audio and prior to that was well known for his work with Automated Processes, Inc, a firm he co-founded in the late 60s. Awarded a patent for his work on a continuously variable attenuator that resulted in the first US produced conductive plastic faders, Walker also received an AES Fellowship for his work on console automation systems.

• **Howard Schwartz Recording, Inc**, a full service recording studio in NYC, has re-opened a post-production room, Studio West. The studio, the seventh in the Howard Schwartz complex, is large enough to fit twenty-five musicians and is ideally set up for commercial music recording, pre and post scoring for film and video, and record production work. Centerpiece of Studio West's 48-track audio/video post-production control room is a fully automated SSL6000E-48 input console, with total recall. Other equipment includes a Sony 3324 Digital Multi-Track; MCI JH24 Analog Multi-track; Studer A820-Center Channel Time Code 2-track MCI JH-110C 4-track; Dolby XP24 Noise Reduction; EMT 140S Plate Reverb; EMT 250 Digital Reverb; Lexicon PCM 70; Lexicon PCM 60; Lexicon PCM 42; Lexicon Prime Time; Lexicon Delta T Delay; Pultec

EQ, LA2A Compressor/Limiter; UREI 1176 Limiters; Orban Parametrics EQ; Technics turntable; Nakamichi MRI Cassette; UREI 813; Yamaha NS10; Visonik; Auratone Speakers; Crown; Hafler, Sound 80-Power Amps.

• **EMI-Abbey Road Studios**, one of the world's most celebrated audio recording facilities, has installed a new 36-input Westar console manufactured in the US by Mitsubishi Pro Audio Group, UK. The new board was made available to the studio under an evaluation lease and is supplied with a full complement of VCA audio faders, 4-band parametric equalizers, and the board offers 24-buss output.

& Happenings

PASS Offers New One-Night Seminars In Technology

STUDIO PASS, New York's non-profit electronic audio arts studio, announces a new expanded schedule of workshops and seminars in new technologies in electronic music for the summer of 1986. In addition to their ongoing monthly MIDI seminar (featuring well known guest speakers and a different topic of interest each month) and their regularly scheduled workshops in Programming the Yamaha DX-7 and Digital Sampling Techniques, they will be offering a new series of one-night seminars in various other areas of interest to the electronic musician of the 80s. The new seminars are as follows: 1) The Fundamentals of MIDI, 2) Programming Analog Synthesizers, 3) Programming the Casio CZ 101, 4) MIDI Software For The IBM-PC and PC-Compatible, 5) MIDI Software For the MacIntosh, 6) MIDI Software For the Apple IIe, 7) MIDI Software For the Commodore 64 and 128. Contact Howard Massey or Carol Parkinson at (212) 206-1680.

Peavey Opens New Manufacturing and Distribution Facility

Peavey Electronics Corp. officials announced that the company has finalized plans to open a manufacturing and distribution facility in Corby,

England. This is the first expansion into the United Kingdom by a United States company in the musical amplification industry and is also a first for Peavey. Peavey Amplification Ltd. is a wholly-owned subsidiary of Peavey Electronics Corporation, a company that has been in business for twenty one years and manufactures and sells commercial sound equipment, solid body electric guitars, microphones, raw frame speakers, power amps, and a variety of related musical equipment.

SMPTE Issues Call For Technical Papers

SMPTE has announced an official call for film and television papers. The 128th SMPTE Technical Conference and Equipment Exhibit will be held at the Jacob K. Javits Convention Center in NYC. Registration for the event will begin on Friday, October 24, 1986, with Eastman Kodak Company's reception for registrants on that evening. A special Technical Presentation by Ampex Corporation will officially open the conference on Saturday, October 25. The papers program will run for four days, beginning on Sunday, October 26. The film papers for this year's conference will be grouped under the following six topic headings: Laborato-

ry Practices, Film and Laboratory Technology, Film and Electronic Production, Film and Video Post-Production, Archival Film and Video, and Audio "Talkies" in stereo. The television topics are: Enhanced Television Systems, Digital Applications to Television, Television Sound Systems, Television Cameras, and Film for Television. Authors or companies and facilities wishing to be represented in the technical program are encouraged to obtain the necessary author forms from Jack Spring, Eastman Kodak Company, 1901 West 22nd Street, Oak Brook, IL 60522. Forms and information are also available from the Editorial/Program Coordinator, SMPTE Headquarters, 595 West Hartsdale Avenue, White Plains, NY 10607.

UCLA Extension Announces Summer Engineering Courses

This summer the **UCLA Extension** recording engineering program is offering three intensive workshops featuring hands-on lessons in equipment use. All classes will apply towards the Professional Designation in Recording Engineering, a sequence of seven required and two elective courses designed to provide participants with a professional level working knowledge of this field.

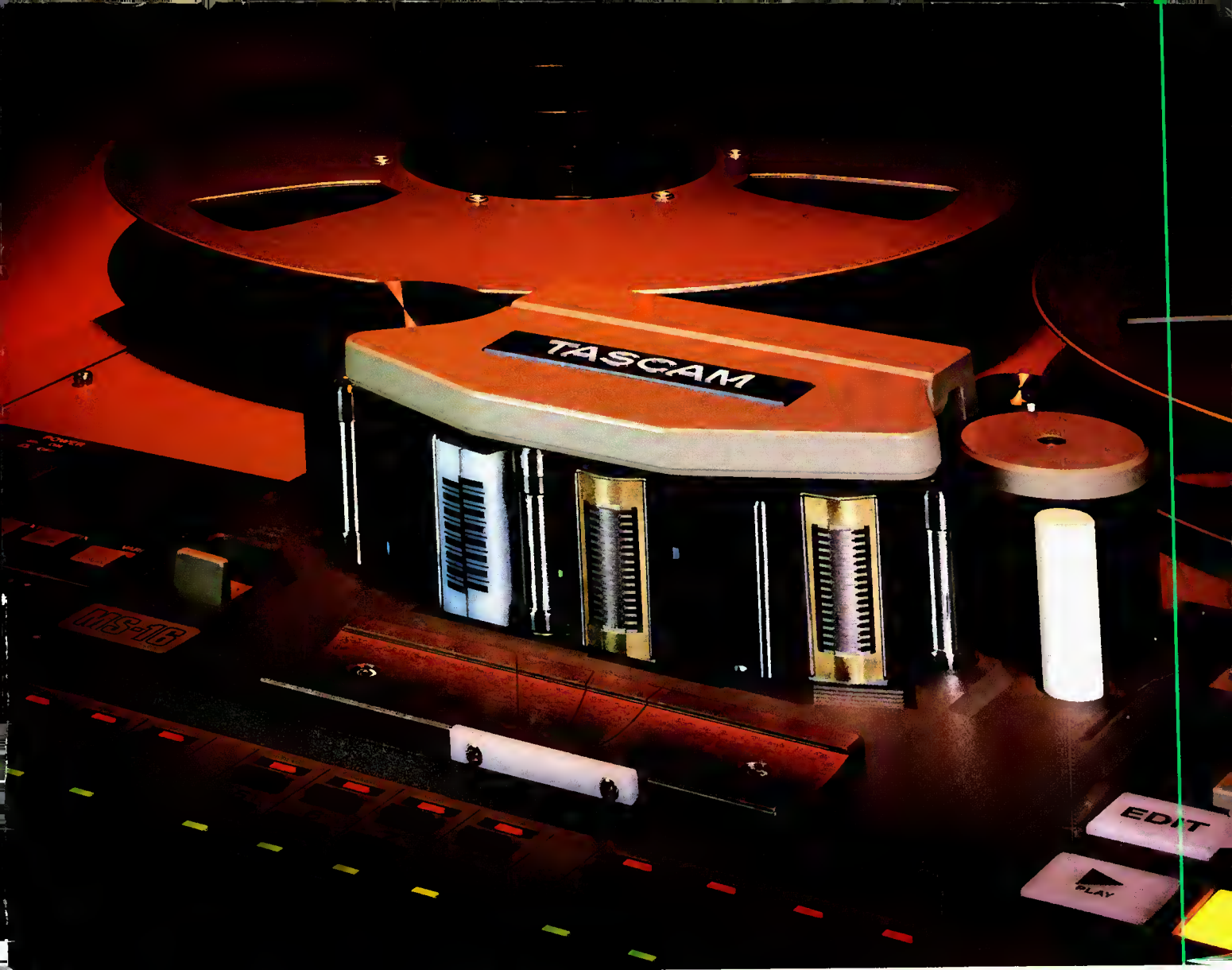

FINISH UP ON TIME WITHOUT SACRIFICING QUALITY.

You want it quick and you want it good. In today's competitive post-production audio/visual scene, the rewards go to those who can produce results that are quick *and* good. That's why TASCAM designed the MS-16 1" 16-track recorder—to bring together top-notch audio quality plus premium features that streamline production and move you ahead of schedule.

Quality reproduction starts with the heads, and TASCAM has three decades of design experience behind the MS-16's new micro-radii heads. They bring "head bumps" under control and ensure flat frequency response. And unlike most tape machines, the MS-16 record/sync and playback heads are identical in performance. Because sync response equals repro response on the MS-16, you can make critical EQ and processing decisions on overdubs or punch-ins without having to go back and listen a second time. You get what you want sooner and with fewer headaches.

The MS-16 cuts down on the time you spend locking up with other audio and video machines as well. A 38-pin standard SMPTE/EBU interface affords speedy, single-cable connection with most popular synchronizers and editing systems. It's the easy, efficient way to get the most out of today's sophisticated synchronization equipment. The MS-16's new Omega Drive transport is tough enough to stand up to long days of constant shuttling... while handling tapes with the kid-glove kindness they deserve.

Record/Function switches for each track allow effortless, one-button punch-ins. Input Enable allows instant talkback during rewinds, fast forwards and cue searches. These features speed you through sessions and let you concentrate on the project at hand... not on your tape machine.

Take a closer look at the MS-16. See your TASCAM dealer for a demo or write us for more information at 7733 Telegraph Road Montebello, CA 90640.

THE TASCAM MS-16 SIXTEEN TRACK

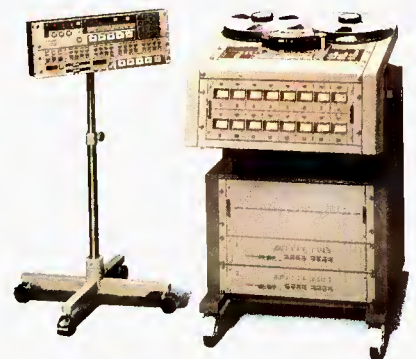

TASCAM THE SCIENCE OF BRINGING ART TO LIFE.



Even if your music starts as a piece of junk, your sampling mic better not.

The new Shure SM94 Condenser Mic can make a big improvement in your digital sampling—at a surprisingly affordable price.

If you've made a major investment in a sampling keyboard or drum machine, don't overlook the importance of the microphone you're using. A vocal mic, for example, might "color" instruments you are sampling.

To capture your sample as accurately as possible, we suggest the new SM94. Unlike many popular mics, the SM94 has no high-frequency peaks, accentuated presence boost, or excessive low-end rolloff. This prevents overemphasis of high frequencies on instruments like strings and brass, while allowing you to retain the important low-frequency response essential to capturing the fullness and richness of many live sounds.

And its extremely low handling noise minimizes the introduction of extraneous handling sounds that might

otherwise creep into your sample. What's more, the SM94 offers exceptionally high SPL capability—up to 141 dB—all but eliminating distortion on transient peaks.

For convenience, you can power the SM94 with a standard 1.5 volt AA battery, or run it off phantom power from your mixing board.

In addition to offering a unique combination of features not normally found in condenser mics in its price range, the SM94 is built with Shure's legendary emphasis on ruggedness and reliability. Features like a protective steel case, machined grille and tri-point shock mount make it rugged enough to go wherever your inspiration takes you.

And for voice sampling, we suggest the new SM96 with its vocal contoured response and built-in three-stage pop filter. Both these fine microphones can bring a new dimension of realism to your digital sampling.

For more information, write or call: Shure Brothers Inc., 222 Hartrey Avenue, Evanston, IL 60202-3696, (312) 866-2553.



SHURE®

Breaking Sound Barriers™

Circle 11 on Reader Service Card

See us at LA AES, booth 107