

MAY/JUNE 1987

\$2.95

Featuring 2 to 8 trk: The Smaller Recording Studio
Guides: Tape, Tape Recorders and Accessories
Stands, Booms, Cases, & Racks

THE SOUND ENGINEERING MAGAZINE

serving: recording, broadcast and sound contracting fields

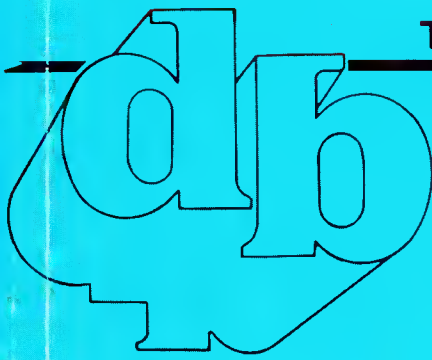



TAKE CONTROL OF A MAJOR RECORDING STUDIO.

It's time to seize power.

Tascam's Studio 8 puts all the power of a professional recording facility into an 8-track production system that's as easy to handle as your own instrument.

Forget bewildering patch bay jungles. The fully assignable 8 buss mixer sends your signals anywhere you want them with the flick of a switch.

Forget open reel headaches. The unique Load feature loads the tape, senses the end automatically and never lets it run off the reel. And because Studio 8 uses 1/4" tape, you'll never be stuck trying to find someone's rare proprietary tape format.

Forget video hassles. The "One Plug" SMPTE/EBU interface gives you easy synchronizer or editor connections.

But there's something more. Something that's greater than the sum of the features. Startling sound. No other system has Tascam heads. Which means that no other system has the impact and clarity that come from Tascam's thirty years of recording experience.

Quality production is what you do. Do it with a major recording studio. Take control of a Tascam Studio 8.



TASCAM

© 1987 TEAC Corporation of America, 7733 Telegraph Road, Montebello, CA 90640. 213/726-0303.

Circle 11 on Reader Service Card



The recording engineer

THE LAUNCHING OF A "MOTHER SHIP" 26
Corey Davidson

BEYOND WORLD CLASS 40
Corey Davidson

LAB REPORT-TASCAM ATR-60-2T 49
Len Feldman

MAKING SMPTE WORK FOR YOU 55
Shelton Leigh Palmer

The broadcast engineer

JOHNNY CARSON IN STEREO 31
Marshall King

2 to 8trk the smaller recording studio

RECORDING TECHNIQUES: TAPE RECORDING, PART 1 8
Bruce Bartlett

AD VENTURES 18
Brian Battles

ON TAXES 20
Mark E. Battersby

ON LAW 22
Kent Klavens

DRAGONVILLE STUDIOS: CONSTRUCTION STORY 44
Barbara King and Diane Schmidt

CONSTRUCTION PROJECT BUILD A-10/+4 DIRECT BOX 57
Jon Gaines

LETTERS 2
CALENDAR 4
NEW PRODUCTS 58
CLASSIFIED 60
BUYERS GUIDE: TAPE AND TAPE RECORDERS/CASES/RACKS/MIC STANDS AND BOOMS 64

Editor/Publisher
Larry Zide

Associate Publisher
Elaine Zide

Editorial Assistant
Carol Lamb

Technical Editor
Corey Davidson

Contributing Editors
Bruce Bartlett
Mark E. Battersby
Brian Battles
Barry Blesser
Drew Daniels
Len Feldman

Graphics & Layout
Karen Cohn

About the Cover

Nile Rodgers and Ben Rizzi at Master Sound Studio (Kaufman Astoria Studios) in New York. They are sitting at the Trident TSM console during the satellite transmission session from Stevie Wonder in California. The article begins on page 26.

About the 2 to 8trk Cover

The control room of Dragonville Studios in LaVerne, California. Equipment pictured includes a Carvin MX 1688 console, Tascam 38 recorder with dbx, and a Teac A-3340 recorder also with dbx. See page 44.

db, The Sound Engineering Magazine (ISSN 0011-7145) is published Bi-monthly by Sagamore Publishing Company Inc. Entire contents copyright 1987 by Sagamore Publishing Company Inc., 1120 Old Country Road, Plainview, NY 11803. Telephone: (516) 433-6530. db Magazine is published for individuals and firms in professional audio recording, broadcast audio-visual, sound reinforcement-contracting, consultants, video recording, film sound, etc. Application for subscription should be made on the subscription form in the rear of each issue. Subscriptions are \$15.00 per year (\$28.00 per year outside U.S. Possessions, \$16.00 per year in Canada) and payable in U.S. funds. Single copies are \$2.95 each. Editorial, Publishing, and Sales offices are at 1120 Old Country Road, Plainview, NY 11803. Second Class postage paid at Plainview, NY 11803 and an additional mailing office. Postmaster: Form 3579 should be sent to the above address.

Goodbye Noise!



Nobody does it better when it comes to tape noise reduction. Our **SYSTEM ONE**, Encode/Decode **MODEL 180A** provides incredible results with no side effects for under \$700.

- Effective noise reduction of 30dB plus 10dB headroom.
- Provides dynamic range better than digital.
- Totally transparent system.
- No side effects (such as "breathing").
- Fully simultaneous encode/decode.
- Also available in four channel (140A) and two channel (120A).

Take advantage of our **PATENTED** technology and improve your recordings. Write us for more information on our **SYSTEM ONE** units, or see your Rocktron Dealer.



1633 Star Batt Drive
Rochester, MI 48063
(313) 853-3055

Circle 16 on Reader Service Card

Empty reels and boxes

And, all 3M, Ampex and Agfa tapes

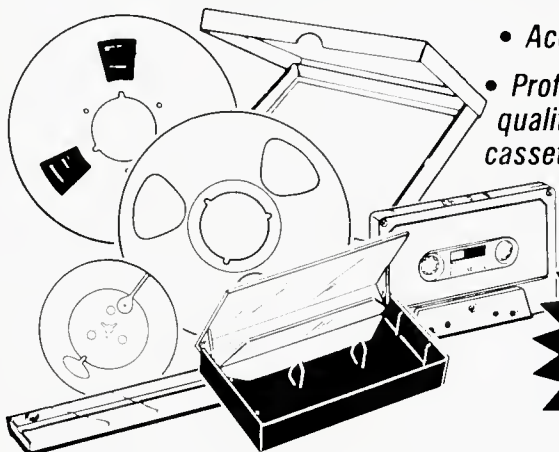

- Accessories
- Professional quality audio cassettes

SHIPPED
FROM STOCK
WITHIN
24 HOURS
under normal
circumstances

ASK FOR OUR FREE CATALOG

Call Polyline
312 / 298-5300
8:30 am - 5 pm Central Time

Polyline
Corp.
1233 Rand Road
Des Plaines, IL 60016

Circle 20 on Reader Service Card

Letters

Dear Editor,

(To Murray R. Allen)

I just finished your article entitled "Looking into the Future to Improve the Past" from the Nov/Dec 86 issue. I would like to inquire of the recording you mentioned in your opening statement concerning having recorded Bill Chase some thirteen years ago. I do not recall the album title, however; had a copy of the work with a remake of "Swanee River." I'm writing to inquire if copies of this album are still available through any source you may know of. I had a copy in 1973, but long since lost it in a move. Being a fan of Chicago, Blood, Sweat and Tears etc., I would like to get another copy of this Chase album, if I can find it. If you have an address or source, I would appreciate it much.

I also want to express my thanks for your interesting and informative article. This copy of *db* came to me through a friend who lent it to me, but I will be subscribing as soon as possible. Thanks again.

Sincerely,
Rodger McIntyre
Owner/Engineer
Headroom Audio Prod.

The last album I recorded for Chase was called "PURE MUSIC." It was an Epic-CBS release. Contact one of their sources to receive a copy if indeed one still exists. Good luck in finding this album.

Murray R. Allen

The AT853 UniPoint™ Condenser Cardioid

**It's been
hung,
planted,
buried,
strapped,
stood up,
clamped,
taped,
and swung...
all in the name
of better,
less visible
sound.**

The AT853 condenser cardioid is a remarkable microphone. Smaller than your little finger, yet with flat response from 30 to 20,000 Hz, and an effective cardioid pattern, even at the lowest frequencies.

The AT853 is so light (1/2-ounce) it can hang on its own 25-foot cord above a choir or orchestra. The ingenious wire adapter permits pointing it exactly where it's needed without support cables or stays, making the AT853 even less visible.

It also includes a neat stand adapter to instantly convert the AT853 into a desk or floor stand model. Or simply hide it in the bushes, behind props, or wherever superb sound is

needed with minimum visibility.

The AT853 is operated by a single 1.5V "N"

battery or phantom power. The power module also has a low-frequency rolloff option to solve rumble and room noise problems.

The AT853 is one of a family

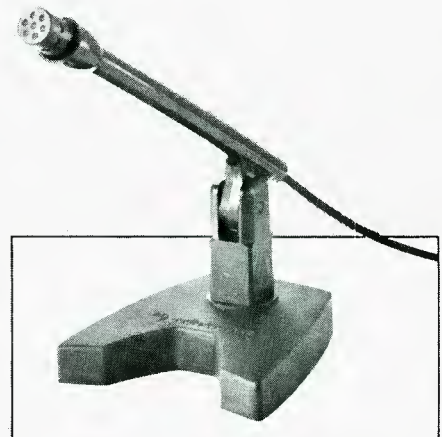

ACTUAL
SIZE



audio-technica®

Audio-Technica U.S., Inc., 1221 Commerce Dr., Stow, OH 44224

Circle 14 on Reader Service Card (216) 686-2600

**wireworks professional audio wireworks
 microphone cable tester wireworks cable
 television production wireworks coaxial
 cable assemblies wireworks broadcast
 studios wireworks audio/video multicable
 systems wireworks professional theatre
 wireworks eng wireworks multi-channel
 microphone splitting systems wireworks
 live performance wireworks hardwired
 multicables wireworks post-production
 facilities wireworks microphone cables
 wireworks hotels and casinos wireworks
 performing arts centers wireworks custom
 designed products wireworks churches
 wireworks recording studios wireworks**

CALENDAR 1987

Nobody puts it together like Wireworks.

wireworks

Wireworks Corporation

380 Hillside Avenue, Hillside, New Jersey 07205 201-686-7400
 TOLL FREE: 1-800-624-0061 and in NJ: 1-800-235-9473

Circle 27 on Reader Service Card

Gaines Audio Rack Chassis

Model 617

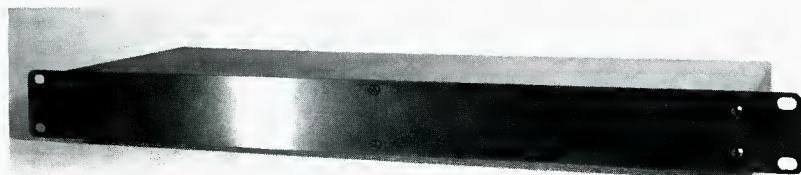

- The Ideal Chassis for Prototypes and Custom Applications
- Heavy Gauge Steel Chassis with Aluminum Front Panel
- Single Rack Space Mounting
- Removable Top and Bottom Covers for Total Access

The Gaines Audio Model 617 Chassis is a high quality enclosure available for prototypes, custom designs, and short run production use. It offers a standard of workability, appearance, and practical application previously unavailable from metal chassis suppliers.

The standard Model 617-1 is a single rack space unit with a front panel dimension of 1 3/4 x 19". Overall depth is 6", with the body of the chassis measuring 17" wide.

For applications requiring a smaller chassis of the same high quality, request literature on our Model 685 "half-rack" chassis.

Gaines Audio 1237 E. Main Street Rochester, NY 14609 (716) 266-0780

An intensive two-week workshop on electronic and computer music production will be held July 20-31, 1987, at the University of Chicago. The "FM Synthesis/MIDI (Musical Instrument Digital Interface) Seminar" will use the Yamaha Computer-Assisted Music System. The special summer seminar in electronic music is designed to present the perfect balance between FM (frequency modulation) theory, computer synthesizer interface and related topics, and electronic music production. The application deadline is June 1, 1987. For more information and to enroll in the seminar, write to:

FM Synthesis/MIDI Seminar

The University of Chicago
 University Office of Continuing
 Education
 5835 S. Kimbark Ave.
 Chicago, IL 60637
 (312) 702-1722

Synergetic Audio Concepts (SynAudCon) is sponsoring a series of two-day seminars dealing with solving audio and acoustic problems.

Detroit, MI June 2,3
 Framingham, MA June 17, 18
 New York- Studio Designers
 Workshop, June 12-14
 Boston, MA June 17, 18
 Lansing, Mich. August 26, 27

Circle 17 on Reader Service Card



Microphones

In the studio, over the air or up on stage, there's a Fostex RP mic specifically designed for the job at hand. RP stands for regulated phase, a transducer technology which has been awarded over 20 international patents to date. These mics have the warmth of condensers, the ruggedness of dynamics and a sound as transparent as it gets.



Headphones

These are more outstanding examples of RP Technology. Model T-20 has become almost legendary among studio musicians, producers and engineers. Its flat response at any listening level and its comfortable design help you listen longer without fatigue. And the sound is so clear and well-defined, critical listening is enjoyable.



Speaker Systems

You're up & going with Fostex PA systems. Modular designs let you control the sound according to the needs of the event. Stack them, gang them. From a simple portable PA to an entire rig, look to Fostex speaker systems to help you solve your sound problems.



Powered Mixers

Model MP-800 has 8 inputs and delivers 180 W per channel and Model MP-1200 has 12 inputs and delivers 250 W per channel. These rugged, road worthy stereo mixers have quiet running fans, digital echo, normalled connections at all critical patch points, stereo graphics on the mains and super monitoring flexibility. The best at any price.



Complete PA Systems

Look to Fostex for any and all of your PA needs. Complete systems or individual components. High quality sound from input to output.

Fostex
Pro Sound Division

15431 Blackburn Ave., Norwalk, CA 90650
(213) 921-1112

© 1987 Fostex Corporation of America

Circle 15 on Reader Service Card

**For the FINEST Tape
Recording Heads
and the
ULTIMATE in
Relapping
Services.**



We stock a full line of direct replacement heads from mono to 24 track.



MAGNETIC SCIENCES

We also provide precision relapping and optical alignment of all magnetic recording heads and assemblies.

If you need optimum performance from your tape recording equipment you need our services. Call or write:

JRF/Magnetic Sciences, Inc.

The audio magnetic professionals with the track record to prove it.

Kennedy Road • P.O. Box 121
Greendell, NJ 07839
(201) 579-5773 • Telex: 325-449



Circle 13 on Reader Service Card

Chicago, IL September 15, 16
Denver, CO September 29, 30
Kansas City, Missouri October 6, 7
New York, NY October 14, 15
Washington October 27, 28

The University of Iowa's eighth annual Seminar in Audio Recording will be held from June 15-26, 1987, with Professors Stanley P. Lipshitz and Lowell Cross as principal instructors. Prof. Lipshitz holds appointments in both applied mathematics and physics at the University of Waterloo (Canada). Lowell Cross is professor of music and director of Recording Studios at the University of Iowa.

Topics to be covered, all of which will involve demonstrations of equipment, are stereophonic and Ambisonic microphone techniques, microphone evaluations, noise reduction systems (dbx, Dolby A and SR, telecom), digital processing, as well as digital-analog and digital-digital (EIAJ-DASH) comparisons. Tuition is \$162.00; on-campus hotel rooms are \$15.00 and \$20.00 per night, single or double occupancy. Each student receives two semester hours academic credit and a certificate at the end of the session.

For more information contact Prof. Lowell Cross, Recording Studios, School of Music, The University of Iowa, Iowa City, Iowa 52242-1793, telephone (319) 335-1664.

The Institute of Audio-Video Engineering, located in Hollywood, California, is sponsoring a summer recording seminar for music educators from July 27 to July 31, 1987. All classes are in a 24-track state-of-the-art recording studio located at the Institute and include a recording workshop, microphone selection and placement, outboard equipment, session procedures, console and 24-track machine operation, mixing techniques and mastering, use of sequencers, synthesizers and drum machines, MIDI and audio for video and film. The seminar concludes with an introduction to digital sampling.

The cost of the 5-day seminar is \$495.00

For more information, call toll free 1-800-551-8877 or call (213) 666-2380.

The 1987 DCI Video Production Workshops

Development Communications, Inc. offers eight different workshops with video professionals that provide hands-on experience. These workshops include Basic Video (June 8-12, Jul 13-17, Sept 21-25, Nov 9-13), Scriptwriting (Jul 20-22, Oct 21-23), Understanding the Video Signal (Jul 10, Sept 11), Audio Techniques (Oct 29-30), Location Lighting (Oct 27-28), The Creative Camera (Jun 3-5, Sept 28-30), Video Editing (May 20-22, Sept 16-18) and Video Technician's Workshop (Oct 2, 9 and 16).

Workshops are conducted from 9:00am to 5:00pm Monday through Friday in Alexandria, Virginia. Registration is first come, first serve.

For information contact Development Communications, Inc., 815 N. Royal St., Alexandria, Virginia 22314 or call (703) 683-3100 to register.

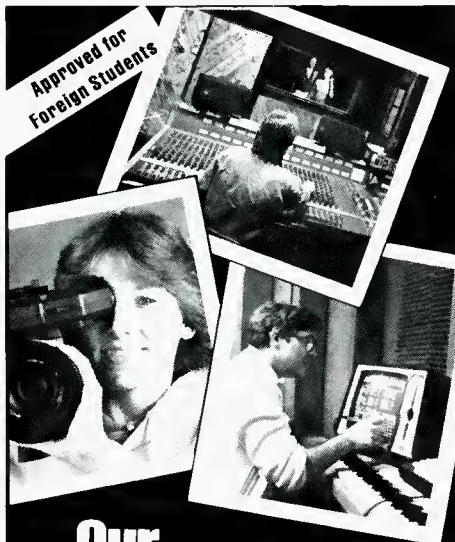

Approved for
Foreign Students

**Our
Graduates Work**

A practical education in audio and video recording arts and sciences for anyone who takes recording seriously.

**Institute of
Audio-Video
Engineering**

1831 Hyperion Ave., (DB) Hollywood, CA 90027

Call Toll-Free: National 1-800-551-8877

State 1-800-972-1414 Local (213) 666-2380
Telex 910 240-4388 IAVE HLWDD

Circle 22 on Reader Service Card

**WE'D LIKE TO
REMIND YOU
THAT THE
UNCENSORED
CONTENT
OF THIS
MAGAZINE
IS MADE
POSSIBLE
BY THE
CONSTITUTION
OF THE
UNITED STATES.**

**THE
CONSTITUTION**
The words we live by

To learn more about the Constitution write Constitution, Washington, DC 20500. The Commission on the Bicentennial of The U.S. Constitution.



Now Available as a Book

The collection of "Recording Techniques" by Bruce Bartlett, as published in db Magazine.

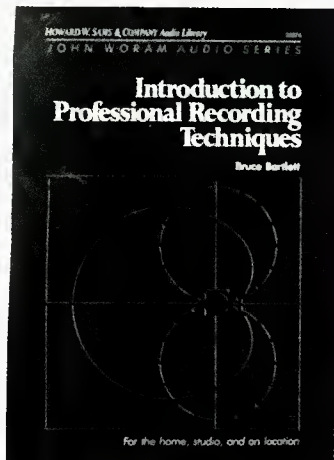

Topics covered:

The Recording and Reproduction Chain.

Simple Home Recording.

Setting Up the Studio. Microphones and Mic Technique.

Control-Room Techniques.

On-Location Recording.

Judging the Recording.

To order your copy of Introduction to Professional Recording Techniques, send \$18.95 plus \$2.00 pp. (Check or money order, US funds.)

Send to db Magazine, 1120 Old Country Road, Plainview, NY 11803

Name _____

Address _____

City _____

State _____ Zip _____

Credit Card# _____

Expiry date _____

Signature _____

New Music Seminar
July 12-15, 1987

Marriot Marquis, New York City
Early registration is \$175.00

For information contact 1747 First Ave., New York, NY 10128 or call (212) 722-2115.

SPARS

May 28- Luncheon at Gallagher's
June 25- Anniversary dinner for SPARS at Gallagher's



38 Revox Industrial and A/V Audio Recorders

Thirty-eight? Where are the other thirty-five?

No need to show them. They all look pretty much the same as the three basic transports shown: PR99 MKII, PR99 Playback Only, and B77 MKII. But, with all our special versions, modifications, and options, you can order a Revox to fill virtually any application. The "menu" includes:

- Auto-reverse 4-track playback for background music
- Auto repeat for loop play
- Alternate recorder control for logging
- Voice activated start
- Any two adjacent speeds from 15/16 to 15 ips

Other choices include balanced or unbalanced in/out, rack mount or cabinet, consoles, transport cases, monitor panels, vari-speed—the list goes on! PR99 MKII models also feature real time counter, autolocate, zero locate, and loop functions. And all three transports offer a die-cast chassis, full logic controls, servo capstan motor, and solid Swiss-German engineering.

If you need audio recording of any kind, give us a call. If we don't have what you need, we'll get cracking on #39.

STUDER REVOX

Studer Revox America

1425 Elm Hill Pike, Nashville, TN 37210 (615) 254-5651

Recording Techniques

BRUCE BARTLETT

Tape Recording, Part 1

Thanks to the tape recorder, an event as fleeting as a musical performance can be permanently captured and relived. This article explains several areas related to tape recording:

- *The analog tape recorder: parts, functions, operation, preventive maintenance

- *Noise-reduction systems

- *Tape handling, storage, and editing

- *The digital tape recorder

The information has been excerpted from my new book, "Introduction to Professional Recording Techniques," published by Howard W. Sams & Co.

THE ANALOG TAPE RECORDER

During recording, a tape recorder converts electrical signals into permanent magnetic signals on magnetic tape. The tape itself is a strip of plastic, usually mylar, with a thin coating of ferric oxide or chromium dioxide particles. These particles have a random magnetic orientation, but they can be aligned into

magnetic patterns by the external magnetic field applied during recording. During playback, the tape machine converts the magnetic field on tape back into an electrical signal.

TAPE-RECORDER PARTS AND FUNCTIONS

The tape recorder has three main parts: the heads, the electronics, and the transport.

- *The heads are electromagnets that convert electrical signals to magnetic fields, and vice versa.

- *The electronics amplify and equalize the signals going to and from the heads.

- *The transport pulls the tape past the heads, which contact the tape.

Let's look at each of the three main parts in detail.

The Heads. Most tape recorders include three heads placed left-to-right as follows: erase, record, and playback. (See *Figure 1*.) The erase head produces an ultrasonic, oscillating magnetic field. As the tape passes over the erase head, the tape is exposed to a gradually decreasing magnetic field. This orients the

magnetic particles randomly and erases any signal on tape.

The record head converts the incoming electrical signal into an analogous varying magnetic field. As the tape passes the record head, the head magnetizes or aligns the tape particles in a pattern that corresponds to the audio signal. This pattern is stored permanently on tape.

The pattern is a magnetic field. As the tape passes the playback head, the head picks up this magnetic field and converts it back into a corresponding electrical signal. This signal is amplified and sent to speakers, the mixing console, or another tape deck. Some recorders have a head that combines the record and playback functions.

There are limits to the signal level that can be recorded. Tape saturation occurs when all the magnetic particles are aligned, so that further increases in recording level do not increase the magnetic signal on tape. If the recording level is too low, tape noise (hiss) becomes audible because the recorded signal is weak in comparison with the random noise signals generated by non-aligned magnetic particles.

It's very important that the heads be correctly aligned with respect to the tape and to each other. The gap in each head (the break in the electromagnet) must be exactly at a right angle to the tape for best high-frequency response. This is called *azimuth alignment*, shown in *Figure 2*. Heads are aligned with the aid of a standard alignment tape, described later in this article.

The Electronics. Tape-recorder electronics perform these functions:

- *Amplify and equalize the incoming audio signal

- *Send the audio signal to the record head

Figure 1. The major parts of a typical tape recorder.

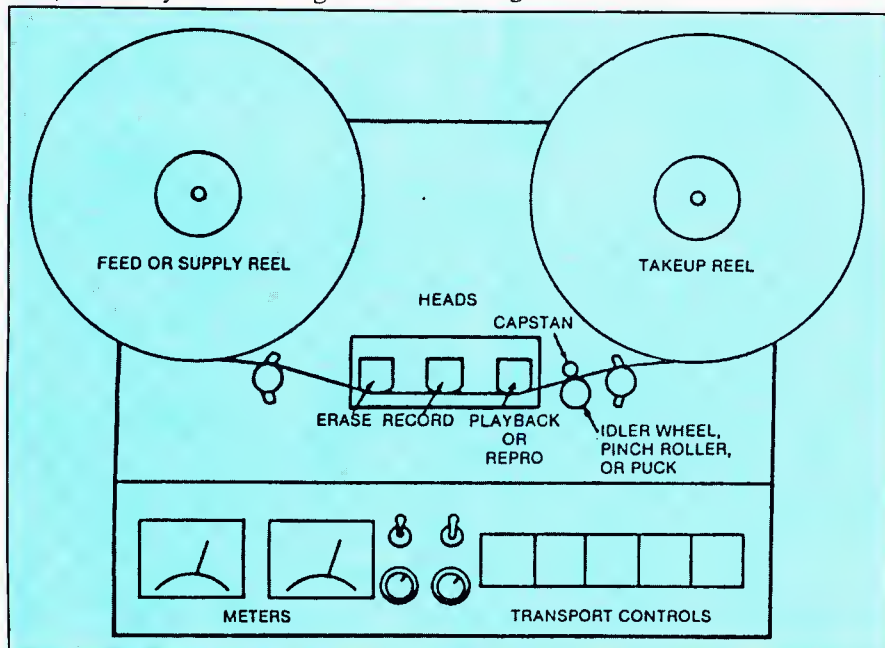

Introducing
ART's
IEQ
with
Smartcurve™



**The
INTELLIGENT
Approach to
Equalization**

- **Fully programmable**, including Smartcurve™
- **Superior audio performance**
 - over 100dB dynamic range
 - less than .009% THD
 - ± 15 dB with $\frac{1}{2}$ dB steps
- **Over 120 user presets**
 - 16 character user definable titles
- **User-friendly alphanumeric LCD display**
- **Complete MIDI interface**
 - Reassignable MIDI presets
 - Total computer control over all functions
- **The composite video shows:**
 - Actual frequency response
 - Slider positions
 - System and MIDI info
- **Controls up to 15 other ART programmable EQ's**
- **Active balanced input**
- **Quick to set up, simple to use, rugged and reliable.**

It Has To Be A Work Of

ART

Applied Research & Technology

215 Tremont Street
Rochester, New York 14608
716-436-2720
Telex: 4949793 ARTROC

Circle 24 on Reader Service Card

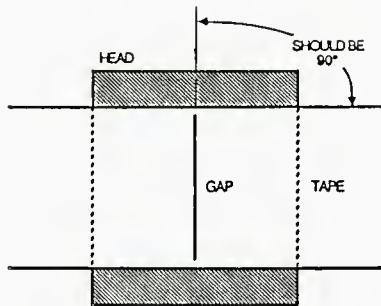

Figure 2. Azimuth alignment

*Amplify and equalize the signal from the playback head.

The equalization provided by the electronics is called *record equalization* and *playback equalization*.

*Record Equalization: Record equalization is a slight boost at low and high frequencies to improve the signal-to-noise ratio at these frequencies.

*Playback Equalization: During playback, the output from the playback head rises 6dB per octave because the head's output depends on the rate of change of magnetic flux, which doubles with frequency. To compensate for this rise, playback equalization falls 6dB per

octave. In addition, playback equalization includes a bass cut to compensate for the bass boost during recording, plus a high-frequency boost to compensate for self-erasure of the tape and losses within the head.

The frequency response of the playback equalization has been standardized in the U.S. to a curve called the NAB (National Association of Broadcasters) curve. Other countries may use different playback equalization.

Also in the electronics is an ultrasonic oscillator that drives the erase head. The ultrasonic signal, called *bias*, is mixed with the audio fed to the record head. The addition of bias is necessary to reduce distortion. The amount of bias, which is adjustable, affects the recording's audio level, frequency response, distortion, and drop-outs (temporary signal loss).

Bias setting is critical. Too high a setting reduces the level recorded on tape and rolls off high frequencies. Too low a setting also reduces the level on tape, results in distortion and drop-outs, and raises the high-frequency response. Bias-setting procedure is covered later in

this article in the section on alignment.

The Transport. The job of the transport is to move the tape past the heads. During recording and playback, the transport should move the tape at a constant speed and with constant tape tension. During rewind or fast forward, the tape shuttles rapidly from one reel to the other.

Most professional machines have three motors in the transport: two for shuttling and tape tension, and a third for driving the capstan. The capstan is a post that rotates against a pinch roller. The tape is pressed between the capstan and pinch roller. As the capstan rotates, it pulls the tape past the heads. The transport also includes rollers that reduce tape-speed variations (wow and flutter).

The tape counter usually shows the elapsed time on tape. A particular point on tape—say, the beginning of a song—can be marked by resetting the tape counter to zero. On some machines, a return-to-zero button shuttles the tape to the zero point and then stops automatically. This function is useful for repeated practices of an overdub or a mix.

The Aphex Compellor.™

Invisible Compression in Stereo or Mono.

The Aphex Compellor is the most acclaimed compressor/leveler/peak limiter ever made. With good reason... you simply can't hear it work. It doesn't add *any* color or other sonic effects. Best of all, the Compellor is easy to use. Set it once and it goes to work automatically... inaudibly controlling your dynamics.

Ask your professional sound dealer for a demonstration of the remarkable Aphex Compellor. Available in monaural and

stereo versions. Or write us for the name of your nearest dealer and more information on the full line of innovative Aphex products.

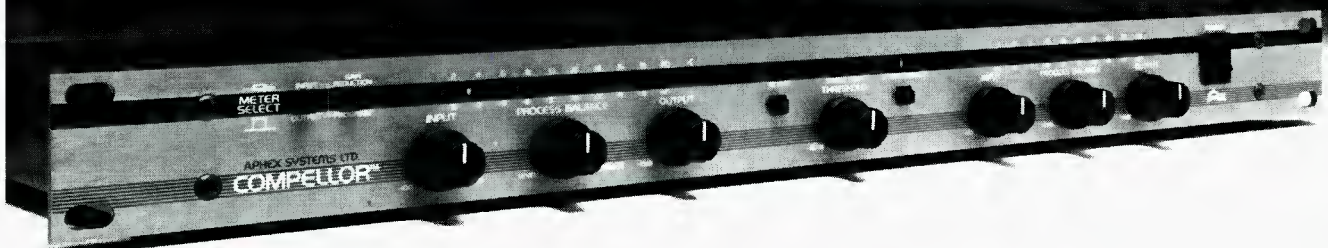

Aphex Systems Ltd.

13340 Saticoy St., N. Hollywood, California 91605
(818) 765-2212 TWX: 910-321-5762

Compellor is a trademark of Aphex Systems Ltd.

© 1985 Aphex Systems Ltd.

Circle 19 on Reader Service Card

N/DYM means better sensitivity

N/DYM design means more microphone signal to cut through the electrical noise of mixers and processors for system "signal-to-noise" that equals even expensive studio microphones.

N/DYM means lower distortion

Neodymium, the rare earth supermagnet at the heart of every N/DYM mic, not only creates an enormous magnetic field within the gap, the "fringe" flux outside the gap is also intense, surrounding the voice coil with a uniform magnetic field for lower distortion even during peak SPL's.

New N/DYM™ microphones break every Electro-Voice tradition but one. Excellence

When was the last time you used a microphone that performed so well you actually did a double take? You actually said, "Wow! This thing is fantastic."

Chances are it hasn't happened in years. It hasn't happened because even though microphones have been modified and improved gradually over the years, there hasn't been any real breakthrough for over two decades.

The new N/DYM™ microphones are going to make you say "Wow!" This innovative series of vocal and instrument dynamics represents the first genuine advance in microphone performance in nearly a quarter century.

At the heart of this Electro-Voice breakthrough is N/DYM, a totally new microphone technology. N/DYM aligned design uses a rare earth supermagnet that is four times more powerful than conventional dynamic microphone magnets. The power and presence of these N/DYM microphones is anything but traditional. They convert more sound energy into usable

signal than any other dynamic microphone. *That's 6 dB hotter than the most popular!*

But the proof is in performance. We know it's not the components but the sound that equates to excellence in your mind. See your Electro-Voice dealer for a demonstration before your next performance.

N/DYM™

N/DYM means high end sizzle

With 50 percent more surface area than other designs, the larger N/D diaphragm intercepts *more sound waves* and converts this energy into *more output*. Reinforced to prevent "breakup," the diaphragm reliably couples high-frequency pressures and voice coil movements all the way to 20,000 Hz.

N/DYM means less feedback

Our supercardioid pattern rejects more unwanted off-axis sound than the usual cardioid. And the *unique geometry* of the N/DYM magnetic structure *keeps our pattern supercardioid at all frequencies*.



To learn more about N/D Series microphones, see your Electro-Voice dealer or write Electro-Voice, Inc., Dept. N, 600 Cecil Street, Buchanan, MI 49107.

a MARK IV company

Circle 18 on Reader Service Card

A professional tape deck moves tape at 7.5, 15, or 30 in/sec (inches per second). As tape speed increases, high-frequency headroom increases and wow and flutter (speed variations) decrease. By contrast, a slower tape speed consumes less tape and allows more running time.

TRACKS

A track is a path on tape containing a single channel of audio. The wider the track (the more tape it covers), the greater the signal-to-noise ratio. Doubling the track width improves the signal-to-noise ratio by 3dB.

Track Width. Tape-recorder heads are available in different configurations. Some can erase, record and play back over the full width of the tape; some are divided so that they

can record two or more independent tracks. Heads are available in the track formats described below. *Figure 3* shows some track-width standards for 1/4-inch tape.

*A full-track mono head records over nearly the full width of the tape in one direction. (*Figure 3-A.*)

*A half-track mono head records one track in one direction and one track in the opposite direction when the tape is flipped over. (*Figure 3B.*) Each track covers approximately one-third of the tape. The unused third between the tracks is a guard band to prevent crosstalk between tracks.

*A 2-track stereo head (*Figure 3B*) records two tracks in one direction. This format is used for stereo master tapes. Track width is the same as half-track.

*A quarter-track stereo head (*Figure 3C*) records two tracks in one direction and two tracks in the opposite direction when the tape has been flipped over.

*A multi-track head (4, 8, 16, 24, or 32 track) records those four or more tracks in one direction.

Tape Widths. Magnetic recording tape comes in various widths to accommodate the track formats, described below:

*1/8-inch for cassettes.

*1/4-inch for full-track mono, half-track mono, 2-track stereo, quarter-track stereo, 4-track, and 8-track (in some semi-pro recorders).

*1/2-inch for 4, 8, or 16 tracks.

*1-inch for 8 or 16 tracks.

*2-inch for 16, 24, or 32 tracks.

MULTI-TRACK AND SYNCHRONOUS RECORDING

A multi-track machine records 4, 8, 16, 24, or 32 tracks on a single tape. Each track contains the signal of a different instrument, or a different mix of instruments. The tracks can be recorded all at once, one at a time, or in any combination. After the tracks are recorded, they are combined and balanced through a mixing console. Unlike two-track recording, multi-track recording lets you fine-tune the mix after the recording session. You can practice the changes in the mix until you get them right.

Over dubbing. The tracks can be recorded at different times. To illustrate, suppose that several tracks of music have been recorded on a



A tough case to crack... on or off the road.

Face it. Musical instruments and sound systems take as much abuse traveling cross-county as they do cross-country. Maybe more. Bouncing in the back of a van, skidding across wooden stages and concrete platforms dragged up and down stairways. Dropped. Your equipment needs protection whether you're on the road-or off. ANVIL® has the perfect

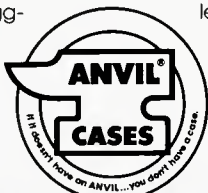

answer. ANVIL® "Professional Grade" ATA Cases-laboratory tested and "Pro-proven" for well over 30 years-are the standard by which all others are judged. ANVIL® Forge® II Cases afford the less rigorous traveling musician many of those same benefits.

Whichever way you travel to share your sound, never forget...If it doesn't have an ANVIL® ...you don't have a case!!

ANVIL CASES, INC., 4128 TEMPLE CITY BLVD., ROSEMEAD, CA 91770

CALL ANVIL TOLL FREE: (800)242-4466 in CA or (800)423-4279 outside CA

Circle 25 on Reader Service Card

CARVIN MX2488 \$3995!

The American made mixer that leads in value!



Made in USA

The CARVIN MX2488 console offers the features, specs and performance you expect from a professional recording console—at a price that's unexpected! That's because CARVIN sells DIRECT, saving you about half the retail price—no commissioned salesmen or store overhead to pay.

The MX2488 is versatile. It handles every recording requirement with ease, from basic tracks to overdubs and mixdowns.

The MX2488 is professional—right down to its modular design and outboard rack power supply. A recent MX1688 test review quoted: "Total harmonic distortion at mid freq. measured only .025% while line inputs measured only 0.01%—very low for a console of this type."

If you want a transparent sound that fits into today's "digital" recording world, then the MX2488 is worth considering. Write for literature and a recent test review or send \$10 for the complete manual (100 pages) including schematics and circuit layouts.

MX2488 RECORDING FEATURES

- Eight track studio control center
- Quick tape playback & rough mix capability
- Three band parametric EQ with defeat
- Complete cue mixing facilities
- Four auxiliary busses with pre-post switching
- Two effects returns with panning and soloing
- Patch jacks and direct outputs on each channel
- Solo & mute on all input & output channels
- Built-in talkback system & monitor diming

FACTORY PRICES

		LIST	DIRECT
MX2488	24x8x2	\$8995	\$3995
MX1688	16x8x2	\$6950	\$2995
MX1644	16x4x2	\$4595	\$1695
AN-16	16ch Anvil case	\$ 395	\$ 269
AN-24	24ch Anvil case	\$ 469	\$ 299

"Having lived with the Carvin MX1688 for a couple of weeks before reluctantly sending it back to the manufacturer, I can attest to the fact that it is truly targeted at the professional recording engineer or sound reinforcement engineer." "It is obvious that the people who designed this unit spent a lot of time in both recording studios and at concerts where sound reinforcement is both critical and complex." Len Feldman—db magazine September/October—1986

CARVIN

Dept. DM77, 1155 Industrial Ave.,
Escondido, CA 92025

Order Direct Today—Visa, MasterCard
Factory Hours: Mon.-Fri. 8:00-4:30 Calif. Time

Call TOLL-FREE
800-854-2235 (Calif. 800-542-6070)

Free Catalog \$10 enc. for MX88 manual

Name _____
Street _____
City _____ State _____ Zip _____

DM77

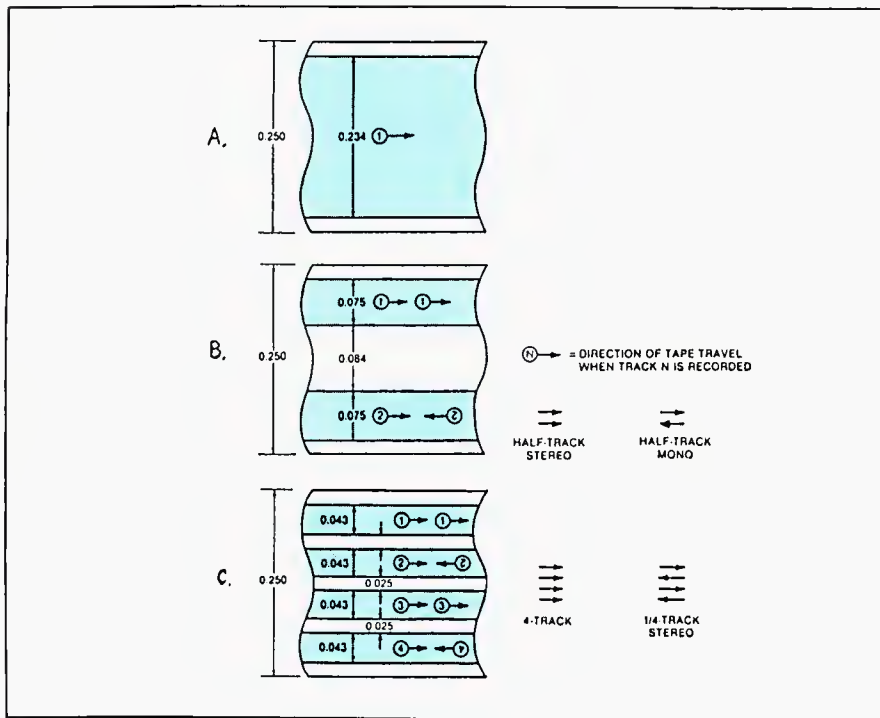

Figure 3. Some track-width standards for quarter-inch tape

Excessive recording levels (greater than +3 VU) saturate the tape, causing distortion. Too-low levels (say, consistently below -10 VU) result in audible tape hiss.

When a complex waveform is applied to a VU meter, the meter reads less than the peak voltage of the waveform. This is because the response of a VU meter is not fast enough to track rapid transients accurately. This inaccuracy can cause problems with level setting. For example, if you record drums at 0 VU on the meter, peaks may be 8 to 14dB higher, resulting in tape distortion.

Whenever you record instruments having transient attacks or a high peak-to-average ratio (such as drums, piano, percussion, or horns), record at -6 to -8VU to prevent tape distortion. Note that mild distortion on drum peaks (recording "hot") may give a desirable effect. Instruments with a low peak-to-average ratio, such as organ or flute, can be recorded around +3VU without audible distortion.

Peak Indicators. Unlike the VU meter, the peak indicator shows peak recording levels more accurately because it responds very rapidly. If your recorder has LED peak indicators, set the levels for all the tracks so that the LEDs only flash occasionally. For setting recording levels, an LED flash takes precedence over the meter reading. If the recorder has LED bargraph peak indicators, set all tracks to peak at 0 to +6dB, depending on the sound source. ■

(Part two, the remainder of this article, will appear in the next issue.)

particular tape. A musician can listen to these pre-recorded tracks, play along with them, and record his or her part on an unused, or open, track.

Let's say the musician listens to the pre-recorded tracks off the playback head, and overdubs a new part. During playback, the new part will be delayed relative to the original tracks. Here's why:

The playback head is a small distance from the record head. The signal on tape travels from the record head to the playback head, and this travel time delays the monitored sound relative to the part being over dubbed. To remove this delay and synchronize the original tracks with the overdub, the original tracks are played through the record head. At the same time, the record head records the overdub on an open track.

This process is called *simul-sync*, *selsync*, or *synchronous recording*. It's usually enabled by setting each track's tape-monitor switch to the SYNC position.

Multi-track recording offers the potential of clearer sound than recording live to 2-track, because you can overdub instruments without leakage rather than recording them all at once. If you record several instruments and vocals simultaneously, leakage or off-mic sound can yield a muddy, loose sound in the mix. When you overdub, there is no leakage, so the final mix can be cleaner.

Note, however, that multi-track recording requires an extra generation, since you must record the multi-track mix onto a 2-track tape. Each generation tape copy adds 3dB of tape hiss. In addition, every time the number of tracks used in the mix doubles, the noise increases 3dB.

METERS AND LEVEL SETTING

Meters on the tape recorder (one per track) show the record and playback levels. These meters may be VU meters, VU meters with built-in peak LEDs, or LED bargraph indicators showing peak levels.

The VU Meter. A VU meter is a voltmeter of specified transient response. It shows approximately the relative volume or loudness of the audio signal. The meter is calibrated in VU or Volume Units. The Volume Unit corresponds to the decibel only when measuring a steady-state sine-wave tone. That is, 1 VU = 1dB only when a steady tone is applied.

A 0 VU recording level (0 on the record level meter) is the normal operating level of a recorder. It produces the desired recorded flux (magnetic field strength) on tape. With a VU meter, 0 VU corresponds to a recording level 8dB below the level that produces 3 percent third-harmonic distortion on tape at 400 Hz. Distortion at 0 VU is typically below 1 percent.

Give.

 **American Heart Association**

WE'RE FIGHTING FOR YOUR LIFE



SERIOUS

High quality, professional performance, versatility, rugged metal construction with performance and feature extras. It's AMR System I.

- 4 Channel Multi-Track Cassette Recording System
- 28 dB of Headroom
- Solid metal construction
- Overdubber™ Multi-function pedal remote control (optional)
- Monitor Mixer section
- 6 x 4 mixer for tracking and overdubbing
- 10 x 2 mixing capability for mixdown
- 3 Band EQ (with sweepable mid-range) on each input
- Peak Hold Level indicators
- Electronic Stopwatch
- Insert "patch" jacks on each input
- Pan Pots on each input (assignable to tracks 1-2, 3-4, or L-R)
- Overdub, Ping-pong and mixdown without patching or changing signal cables
- Mute switch on each input
- Auxiliary master send control
- Assignable Auxiliary master return
- High Power internal headphone amplifier
- Dolby® B and C Noise Reduction
- Solenoid operated transport function controls
- Zero Stop and Zero Play
- Interconnecting cable harness (included)
- Manufactured in the USA.

If you are serious about your multi-track recording, the AMR System I offers the features and performance found in large and expensive professional recording equipment. See the AMR System I at your local AMR multi-track dealer and hear the difference.

Dolby® is a Registered Trademark of
Dolby Laboratories Corporation

AMR™ AUDIO MEDIA RESEARCH / ROUTE 2, HWY. 503/DECATUR, MS 39327 / (601)635-2244

"the American Sound"
Circle 26 on Reader Service Card

"Digital has finally



Sony Communications Products Company, Professional Audio Division,
1600 Queen Anne Rd., Teaneck, NJ 07666. © 1987 Sony Corporation of America.
Sony is a registered trademark of Sony Corporation.

y adapted to me."

Sit down at a Sony PCM-3202 2-channel digital recorder and you'll notice something strange.

Mainly, that it's *not* strange.

You can rock its reels, splice the tape, in fact, you can do everything you're used to doing with a studio-quality analog recorder. But still get great digital sound.

And since it's Sony digital, you'll find that it's not only easier to work with, it's also easier to master with. Because the 3202 makes *direct* digital transfers to the world standard PCM-1630 CD mastering system.

So if you've been waiting for a great tape machine that happens to be digital; don't wait. Contact your Sony Pro-Audio representative for a demonstration.

For more information on the PCM-3202 and the PCM-3102 (7½ ips version) call the Leader in Digital Audio at (201) 833-5231.

SONY
PRO AUDIO



Ad Ventures

BRIAN BATTLES

As a reader of **db** you are undoubtedly attracted to the enormous variety of audio recording and processing devices that fill the marketplace. If you desire to distinguish yourself from the masses and place yourself at a point to take advantage of the recording industry from a financial position, you are well-advised in checking this column for new ideas and methods of increasing revenues through less well-worn paths of endeavor. To date we have looked at various topics involving the business of using your recording studio and skills to produce radio commercials. Now we shall examine some of the technical aspects. Note that many of the tips and advice in *Ad Ventures* may also be used in the recording of audio tracks for use in television spots, too; while peculiarities of certain specific requirements imposed by TV can present separate problems and issues, it is safe to assume that most standard sound recording practices are applicable to the visual medium.

Rather than undertaking a clearly pointless effort to list all the possible kinds of equipment that you could use to record and mix advertising projects, I will describe for you a substantial portion of my vision of a radio producer's fantasy studio, a dream facility that would constitute the third wish I would ask to be granted were I to find myself wearing Aladdin's shoes in the legend of the Djinn in the Lamp (no doubt you can imagine wishes number one and number two).

I will eschew the iteration of particular brand names and models at the present time in avoidance of what may be construed as endorsements. Let us proceed under the assumption that any equipment under serious consideration will provide adequate recording fidelity, frequency response, speed stability, dynamic range, and other standard professional specifications. Beyond

that, it is my feeling that you as an individual should base your choice of gear on a variety of factors that affect you personally, such as cost, individual taste, objective laboratory tests and reviews like those presented elsewhere in **db** and in other reputable audio engineering trade publications, and any experience encountered by yourself or your associates. Nevertheless, if my own preferences are of interest to you, in a future article I plan to describe in detail the apparatus and tools with which I have outfitted my office/studio as head of audio production at CareerTrack Publications, Inc. in Boulder, Colorado.

Obviously, the heart of a serious recording facility is its reel-to-reel tape recorders, and as with all electronic machinery, there are a great deal of configurations to choose from. Although one- or two-track units can serve quite admirably provided you can supply a bit of patience and resourcefulness, and unless you intend to record a fair amount of live music that may dictate the use of sixteen tracks or more for proper recording, for reasons of capital expense and operating costs I recommend owning a multi-track recorder. You can choose from a number of quarter-inch two-, four-, or even eight-track units at modest prices, and the appreciably lower cost of quarter-inch tape is an important consideration when compared to half-inch. Furthermore, clean and convenient editing is a great deal easier with narrower tape widths. The primary considerations in selecting a tape machine are 1) the ruggedness of the transport since it probably will be subjected to a fair amount of rough treatment, 2) ease of access to the head contact area in order to facilitate the marking of splice points, 3) flexible controls that allow you to work efficiently, and 4) variable speed functions to permit the use of special effects and a certain degree of time variation

(keep in mind that radio and television advertisements must conform to fairly strict constraints as to length).

By the way, a good open-reel tape machine should not require you to use special noise reduction devices, since a well-designed recorder using high-grade tape and operated according to correct practices should provide adequate fidelity. Furthermore, being that most broadcasting stations use many gadgets in their audio chains which make it likely that the source material (i.e., your tape) will boast a signal-to-noise ratio superior to the overall output of the transmitted signal. For all practical purposes this means that you can also eliminate any worries regarding the adequacy of conventional analog units and can discard concern for the expense of digital tape decks. Familiar analog gear is perfectly suitable. Remember that the majority of radio listeners own what we may call less than state-of-the-art receiving apparatus, so that extreme sonic eminence is an exaggerated if not entirely unwarranted consideration. The need for costly digital source material is seriously debatable in light of the present form of radio broadcasting and reception technology. If you are already equipped with this new technology, though, it certainly cannot do any harm to go ahead and use it.

Microphones are of utmost importance. It is generally known that the science of transducers has long been regarded as a thorny subject. Here is an area where technical specifications can have the least significant bearing on the actual sound. Since a transducer is a device which rather erratically and inefficiently converts electrical energy to mechanical energy (and vice versa), there can be much variance in how they affect the desired sound. Just as any audiophile knows that his hi-fi speakers are the single most critical link in the audio chain, a good recordist must reverse the

equation and take a long, hard look at microphones. The mics you own must definitely reflect as nearly flat and crisp response as possible. The principal requirement of any commercial is that the message be heard clearly and the mic that provides announcers with the most flattering pickup quality and intelligibility is of vital importance. Given the fact that it is often necessary to choose a microphone to suit a particular voice or style of delivery, you may wish to keep a variety of them on hand to deal with different situations. Occasions may also arise in which a skit or special ad will call for two or more announcers being recorded together. Have at least two mics on hand. Don't skimp on hardware, either—good stands, booms, clamps, shock mounts, connectors, and cables will save you frustration and annoyance at many sessions. I suppose the best advice is to try to buy the best microphones you can afford, preferably with switchable pickup patterns (cardioid, hypercardioid, unidirectional, omnidirectional, etc.). This offers you maximum flexibility in many usual and unusual situations.

Now how about a central control console? In its simplest terms, an effective recording console is a mixer that allows you the necessary manual control over a multitude of functions such as the relative gain of the individual input sources, the route the audio signals will take to their ultimate and intermediate destinations (tape recorder channels, special effects devices, equalization circuits, subgroups, monitoring equipment, and so forth). All this must be accomplished while contributing as little noise and distortion to the original sound. This seems complicated, and well it can be, although for most applications a relatively straightforward console can be purchased and will suffice very nicely. It all depends on how much time you want to spend learning to use the mixer to the best advantage. Planning ahead can also let you avoid problems when you require added capabilities as your system and needs grow.

Multiple inputs allow a wide range of signal combinations. If you have several auxiliary, effects send and receive, pre- and post-fader, and other patch points, this will offer you a helpful variety of ways to route signals. Of course, the more complex the board, the more time you'll have to spend learning to get the most out of it. If you are considering a new mixer, there are really no particular or unusual requirements to look for other than what you would normally want in a general purpose recording console, but just remember that you probably won't have to do much with fancy monitor or cue buses. Here's another point to ponder: Most studios mainly record music sessions, so a multitude of microphones are commonly hooked up all at once. But if you are constructing a studio facility that is primarily going to be a radio production shop, there will be a lot of sessions where you will only use one or two microphones at a time, so look at boards that provide lots of line and tape inputs.

Once you have spent a fair amount of time auditioning and investigating the basic components of tape machines, microphones, consoles, and so on, it is time to turn your attention to the plethora of outboard special effects and sound treatment equipment to be added. This is where your budget and resourcefulness really come into play. I have produced and listened to incredibly slick-sounding and complicated radio commercials that were put together using literally no external processing. Due to the rapid advance of extraordinarily high technology in the past decade or so, now just a twist of a knob or flick of a switch provides the same results and much more. In fact, with today's relatively low prices you can assemble an impressive stable of gizmos that will afford access to a surprising array of remarkable effects like echo, flanging, phase shift, reverberation, compression/limiting, pitch modification, sophisticated frequency adjustment, and a myriad of other common and outlandish expressions of acoustic variation.

I fill out and mail the "bingo cards" (reader service cards) in the music industry trade magazines to get information on all sorts of esoteric devices that look like they could be useful in my work. Then, after I receive the literature, it's fun to take the opportunity to find a local dealer or studio to spend a bit of time observing a live demonstration of the thing in use.

[Well, okay, *one* personal recommendation: I find that of all available outboard effects devices and signal processors, the single most versatile gadget I know of is a compressor/limiter/noise gate, also known as an automatic gain controller (AGC). Any type of production can benefit from its ability to automatically ride gain on the level of program material, and it can also permit you to squeeze the most sound into your system's headroom. (An equalizer would be my second recommendation, but most consoles are already equipped with at least a rudimentary EQ section, so if you can only get one thing, go for the AGC.)]

Any of these effects, or combinations thereof, can and have been used in thousands of radio and television advertisements. Aside from inevitable budgetary considerations, the only constraints imposed upon the average producer are those of taste and skill. Always bear in mind that fancy electronic effects boxes are merely reinforcement, never a substitute for creativity. Anybody in town with a reasonably healthy checkbook can own the same machinery as you, but the distinction between your success in the field of commercials comes primarily from your ambition, motivation, and talent.

Take some time to objectively review your recording facility and look at those gleaming metal objects and flickering LED displays as the tools by which you will lovingly craft the audio creations that will bear your distinctive personal stamp and allow you to reap the rewards of your devotion to the honorable profession of recording the messages that help propel the wheels of commerce. ■

Why You Were Targeted For A Tax Audit

Despite the fact that very few owners of home sound or recording studios actually suffer the inconvenience and trouble of an income tax audit, the mere threat of an audit remains high on almost everyone's list of fears. After all, who knows what prompts the Internal Revenue Service to select one tax return over another? Well, thanks to a recently declassified IRS handbook, the answer to that age-old question is now public knowledge.

The recently declassified IRS handbook, appropriately titled "The Classification Handbook," sets out general areas of IRS concern as well as specific items that are considered either to be especially high or low priority. In selecting these items, the IRS has reportedly considered both the potential for taxpayer error as well as the potential for fraud.

The process begins with a complex computer program that scores individual income tax returns against formulas developed by the experts at the Internal Revenue Service. As the score mounts, so does the chance that a particular tax return will be pulled out from the crowd for further examination.

The home-studio owner gets points, for instance, if deductions are above average for that income level. No one, not even the auditors at the IRS, know the exact, top-secret figures that are used as

norms, but every year the IRS publishes an analysis of returns from which average deductions can be deducted. Such figures are available in most libraries or from most tax advisors, but merely provide guidelines of past years.

The returns that are kicked out by the IRS computers are then screened by IRS employees. They decide which have what they refer to as "audit potential."

How can the average studio owner reduce his or her chances of an audit? Experts believe that the chances can be reduced by simply preparing a tax return with care, drawing as little attention to it as possible, using the correct tax tables and forms. Forgetting to sign the return, failing to answer all questions or neglecting to attach the proper documents will single a tax return out, as will faulty arithmetic. The IRS picks up several million math errors each year and sends out notices with a recomputation.

According to the Internal Revenue Service, adequate identification and the proper treatment of so-called "significant" deductions by taxpayers is a primary IRS concern. These are matters that are usually within a taxpayer's control. For example, a taxpayer should ordinarily be wary of taking "miscellaneous" deductions in "significant" amounts.

The question of just what constitutes a "significant" amount for deductions naturally depends on the taxpayer's income, the nature of his

or her business, the personal family situation or the specific nature of the deductions. In other words, a \$5,000 deduction is significant for a taxpayer earning \$25,000 a year, but not for one earning \$1 million; business expense deductions for air travel are considered significant for a farmer but not for a real estate developer with property located throughout the United States.

Although tax experts are divided on the issue, the handbook seems to indicate that a sound or recording studio owner would be wise to attach separate schedules wherever necessary to give the IRS sufficient information to understand the tax return. If there is not sufficient information, the studio owner risks an examination and the additional time and worry that such a procedure can entail. Of course, giving the IRS the reasoning or specifics behind your deduction may just be begging for rejection—without a hearing.

Casualty losses, for example, are one area that raises a red flag because IRS experience indicates that people frequently miscalculate the amount they are entitled to. If your home studio suffered severe storm damage, you may have a substantial casualty loss. The IRS computer might find it out of line and reject your tax return, but if you attach a letter describing the damages and how you arrived at the deduction, the IRS examiner may well accept it.

On the other hand, the explanation itself, as mentioned, could trigger an audit. If the claim is unusual and the explanation requires extensive documentation, the IRS examiner may automatically send the return to the audit pile because it contains too much information to review quickly.

Particular items of high concern to the Internal Revenue are the often ignored or overlooked recapture of depreciation and investment tax credits after the asset to which they relate has been disposed of. The IRS also looks closely at depreciation deductions in excess of the taxpayer's basis or book value.

According to the manual, particular care should be taken to ensure proper reporting and adequate documentation of transactions between partnerships and their partners or even a sound engineering or recording corporation and its shareholders. Here, the IRS is concerned that items which should be taxed as income to the recipients may have been reported as non-taxable distributions.

The IRS has identified several specific items on individual income tax returns as highly productive in discovering unreported income or excess or improper exemptions or deductions. These items are:

- (1) exemptions claimed by non-custodial parents
- (2) losses claimed on the sale of rental property that has recently been converted from a personal residence
- (3) business schedules where the gross receipts are \$100,000 or more with a relatively low net profit and where the standard deduction is used.

When it comes to first-year partnership returns, the IRS identifies the following as highly productive in an examination:

- (1) contributions to capital (for possible recognition of gain or loss at the partner's level)
- (2) lack of contributed capital by a partner where services may have been performed in exchange for partnership interest

(3) large loss claims where business was commenced late in the tax year

(4) large loss claims in relation to investment

(5) losses claimed in excess of investment because of non-recourse financing

(6) large depreciation deductions where property may not have been placed in service during the year.

And, obviously, returns reflecting income and deductions from tax shelters, and especially "burned out" tax shelters, are likely candidates for examination.

Corporate income tax returns are likely to be carefully examined if the following are present:

(1) a new corporation that incorporates a going concern reflects goodwill, boot or accelerated depreciation

(2) corporate liquidations where recapture income is not shown

(3) consolidated returns that do not have schedules attached that show each member's share of income, expenses, assets, liabilities and capital

(4) short period returns

(5) credits or losses that have been carried forward when they should have been carried back

(6) first-time use of LIFO inventory

(7) manufacturing concerns not using the required full-absorption accounting method to value inventory

(8) substantial passive income that might indicate a personal holding company

(9) low-asset returns reflecting a new operating loss

(10) tax returns with minimum tax.

Not too surprisingly, the Internal Revenue Service has also discovered that some items are low priority, i.e., unlikely to result in appreciable amounts of unpaid or overpaid taxes. These items are:

(1) high medical expenses for large families and for deceased or older taxpayers;

(2) home mortgage interest; and

(3) auto expenses where standard mileage rate is used and the mileage does not appear excessive.

In the light of this recently declassified "Classification Handbook" for classifying income tax returns for examination, it might pay to expend a reasonable amount of extra effort to furnish the IRS with the information it wants. This may save a studio owner a great deal of work later on should the ever-vigilant IRS's attention be called to the tax return and further examination procedures initiated.

If an audit should occur, the first question usually asked is whether representation is necessary. Again, the experts differ, but a good rule of thumb is to calculate how much in additional taxes you stand to lose if every deduction being checked is simultaneously disallowed; the amount may come to less than the cost of hiring a competent professional.

If you stand to lose a lot or if you're unsure about what is and is not tax deductible, having someone with you who knows tax law can be very useful—and can save you a bundle. Remember, too, the professional's fee is, itself, tax deductible.

Even if you decide to go alone, consider preparing for the audit by consulting with your tax advisor. It's important that you know exactly what records to take. You must be able to justify the figures in question. Don't go to an audit with all of last year's canceled checks in a shopping bag and expect your auditor to sort them out.

Finally, remember that all is not lost if the audit goes against you and you are asked to pay more tax. You don't have to accept the IRS ruling. You can protest at the IRS Appeals Office or even petition the U.S. Tax Court to hear your arguments.

Although an audit itself is not a trial in any legal sense, it may feel like one. The big difference is that in courts of law you are innocent until proven guilty. In a tax audit, the burden of proof is on you...the home studio owner. ■

RECORD PRODUCERS

The selection of an appropriate producer, or the development of superior production skills yourself, can be critical to your career as an artist or songwriter. The importance of producers in the music industry is similar to that of directors in the motion picture industry—the best can enhance and maximize talent with their artistic vision and production skills, while the worst can destroy it.

Other than yourself, your producer could be your songwriting collaborator, a member of your band, a recording studio engineer, an actual professional producer with credits or some other person with production experience. Whoever it is, before you record anything, you should discuss mutual plans and perceptions about the project and finalize your business arrangements.

This article is written primarily for those of you who will use someone other than yourself to produce your songs or performances. If you will be producing your own material, or if you will be hiring yourself out as a producer for other projects, interpret this article from the opposite point of view—understand what you will try to negotiate or reserve for yourself, rather than what you will need to pay to others.

In your relationships with producers, there are three general levels of production that you will be concerned with, both from a business and artistic standpoint:

(1) *Demonstration Recordings*. These are the relatively inexpensive recordings you initially make to promote yourself as an artist or songwriter to major producers, recording artists, publishers, attorneys or personal managers. (I will

refer to these recordings as “Demos” throughout this article.) With the increasing availability of affordable, professional-quality audio equipment, Demos are often produced in home studios.

(2) *Independent Master Recordings*. These are produced at varying levels of expense, but are intended for independent release and sale or for submission to record companies for a potential exclusive artist’s agreement. (I will refer to these as “Independent Masters.”) In actual practice, tapes submitted to record companies are also called “demos,” but for artistic and business purposes, such tapes are best discussed separately.

(3) *Company Master Recordings*. These are paid for by record companies. (I will refer to these as “Company Masters.”) Depending upon the budget, the company involved and the songs and performances recorded, these might be lower in quality than many Independent Masters! I have separated this category primarily for the discussion of business points.

I. DEMOS

The object of recording Demos is to get decent quality at minimal cost, although many artists and songwriters spend far too much. There is no standard fee for a Demo producer, but for songwriter Demos, keep in mind that even major publishers limit an entire Demo budget for one song to less than \$500 to \$600. Try to develop a continuing relationship with one Demo producer (if the results are satisfactory, of course). You can then usually negotiate a reduced fee for each song. A similar money-saving strategy would be to hire the

producer for three or four songs at the same time.

If you don’t have enough money to pay a Demo producer when you want to record your project, you might be able to find someone to work on a “spec” (speculative) basis. A “spec” producer is generally one who believes in the probable future success of the project and will therefore accept payment when the project generates income. This can be done in a variety of ways, but be careful not to give away too much.

There is a basic formula that can be applied to most “spec” situations (this could also be used for investors or recording studios). Simply stated, there are three factors (or variables) used to determine what the “spec” producer will be paid—“the percentage,” “what the percentage applies against” and “the ceiling.” For example, if a producer’s normal rate for the Demo would have been \$500, you can offer to pay 25% of the songwriter’s income earned from the song until the producer is paid \$1500. “Sliding scales” are also commonly used. The “spec” participation in the previous example could be designed to pay 50% until the producer has been paid \$500, 25% until an additional \$500 has been paid and 15% until the balance has been received by the producer. If a producer insists on higher ceilings, offer a lower percentage.

Another advisable alternative for a “ceiling” would be to limit the “spec” payment to a specific time period. For instance, you could agree that the entire payment formula only applies if there is a commercial recording of the song within one year after the completion of the

Everyone Says They're Better — We Prove It!



- Time Delay
- Compressor / Limiters
- Reverberation
- Expanders
- Crossovers
- Spectrum Analyzers
- Tape Noise Reduction
- Parametric EQ

Before you purchase another piece of signal processing gear for Studio or Performance use, you would be Wise to listen to our Demo Album. Instead of merely "Saying" we're Better, we Prove it in side by side comparisons with the competition. You really can pay Less and get a Better product through our factory direct sales!

We're out to set new standards for Quality and Performance as well as dollar value. We want you to choose us for our Quality more than our Prices. Our 15 day Satisfaction Guarantee and Two Year Warranty on our Crossovers, Time Delays, Reverberation, Compressor/Limiters, Expanders, Parametric EQ, and Tape Noise Reduction, allow you to purchase with Confidence.

The Demo Album is both fun and Educational. Examples are drawn from the master tapes of Top 40 Hits and show some of the most sophisticated effects ever devised. You will hear our phenomenal MICROPLATE® Reverb with over 18 KHz bandwidth in side by side comparisons with the \$7,000 EMT® Plate on percussion and vocals. No other spring reverb would dare attempt such a comparison! The cost is incredible too, under \$600 mono and \$1,200 in stereo!

Write or call for a free 24 page Brochure and Demo Album.

LT Sound, Dept. D-2 , P.O. Box 338, Stone Mountain, GA 30086

TOLL FREE: 1-800-241-3005 - Ext. 1 In Georgia: (404) 493-1258

LT Sound

We Make A Better Product

Demo, arguing that if there are no results by such time, you will be recording a new Demo. You could also limit the payment formula to sums received by you from exploitation of the song within two or three years after completion of the Demo or after the song is first commercially recorded and released for sale.

For some long-term projects involving great amounts of time, a producer might insist that there be no ceiling as to either money or time periods. Others might ask for the publishing rights to the songs produced or for some percentage of co-ownership in these rights. Be very cautious before agreeing to these types of arrangements.

An assignment of some or all of the "publishing rights" would only be appropriate if: (a) the producer is an established music publisher who will aggressively promote the song or songs involved; or (b) the producer is a record producer for major acts, and has promised to use one or more of the songs in an upcoming project. In either case, get a "reversion clause" reassigning all rights to you if there is not a specified use of the song within a definite time period.

Unless you are an artist who intends that the production project will be used for direct submission to record companies for an exclusive artist's agreement, try to be firm in rejecting a "spec" producer who insists upon publishing rights or refuses any limits as to financial participation in your eventual success. Such demands may cost you far more than the services of the producer were worth, and you will probably be able to find another producer of equal talents on better terms.

II. INDEPENDENT MASTERS

When you decide to record Masters that will be sold to the public or "shopped" to record companies for a potential exclusive artist's agreement, you step up to an even more competitive arena than for Demos. The potential rewards are much greater, so people are willing to spend much larger sums of money and take much greater risks for their recording projects.

A. Promotion to Record Companies

Even though some labels now refuse to accept "unsolicited material" that has not been sub-

mitted by a personal manager, producer or attorney they know, most major record companies still receive tremendous numbers of Independent Masters for their consideration. It is therefore crucial that your tape makes an impact that distinguishes it from the others. In addition to great songs, this uniqueness is most frequently the result of the production sound of the music and vocals—a sound which creates a distinct artistic identity.

The importance of the producer's role in capturing or creating an artistic identity on tape cannot be stressed enough. For this reason, the best producers require large fees and financial participation terms. If a producer will also be "shopping" the project to record labels, it is common for that producer to insist that you sign a "production agreement" and, if you are a songwriter-artist, to require an assignment of all or some portion of your music publishing rights.

Production agreements are essentially exclusive artists' recording contracts. You should carefully review the considerations described there. It is important to understand, before agreeing to this type of situation, that you are essentially employed by the producer, and that the producer, not you, will have the power to make decisions concerning your recorded performances.

As to a producer's possible insistence that you assign music publishing rights (if you can't avoid this altogether by adopting a firm negotiating posture), try to limit the producer's interest to only a "co-publishing" or "administration" agreement. You should also maintain that any music publishing assignment be limited to songs recorded and released for sale under an agreement between the production company and a major record company.

If you have retained a producer who will not require either a production agreement or a music publishing assignment, the payment considerations discussed in the prior section on "Demos" apply. Be aware, however, that the hourly or per-song rates charged will be substantially higher for the kind of producer you will need for high-quality Independent Masters.

In the case of "spec" producers, even if the actual masters they have produced are not released for sale or otherwise commercially exploited, it might still be fair to allow the producer to participate financially in any record company agreement you obtain with those master recordings. (Again, refer back to the "spec" formula in the section on Demos.) Some artists restrict a "spec" producer's financial participation to only the exploitation of the songs and Independent Masters produced by that producer. Others place a time limit on financial participation, as with Demos, arguing that if no exclusive artist's agreement has been offered to them within one year to 18 months, new master recordings will have to be produced. Some agreements grant the "spec" producer a financial participation in only the first album released under the recording contract, while others restrict the producer's financial participation to royalties received by the artist in the first two or three years of the exclusive artist's agreement.

Do not, under any circumstances, guarantee that the producer of the Independent Masters will be retained by you or your eventual record company to produce your first single, first EP, first album or any other record company product. Most record companies invest large sums of money to record and promote new acts, so they demand approval of any producer and may reject your choice. A common compromise here is a "buy-out." The artist promises to use "best efforts" to have the producer approved by the record company to produce the artist, but if the record company refuses, the artist pays a specified sum to the producer (which should be recoupable from any other financial participation the producer will receive from sales of records). In this event, be careful not to promise too large a sum, because the advance you receive from the record company may not be enough to cover this guaranteed payment.

An agreement with your producer should also provide for the possibility that the actual Independent Masters will be released by a record company. The most common form of royalty paid to artists signed directly to a record label is the "all-in" royalty, which is intended to

cover the services of both the artist and the producer. In a "direct signing" situation (contrary to those artists signed to record companies through a production company), the artist determines how much of this royalty will be paid to the producer. In this event, you should pay the producer participation "points" of the all-in royalty. ("Points" are merely percentage points, but are described this way to avoid confusion. For example, if a record company is paying you an all-in royalty of 10% of the suggested retail price for albums sold, and you want to pay your producer a royalty of 3% , this is described as three "points" of your royalty, not 3% of your royalty.)

Most producers are generally paid in the range of either three to five points of an "all-in" royalty that is based upon some version of the retail price of recorded products sold or six to ten points of a royalty that is based upon some version of the wholesale price. Your agreement with your producer should provide for alternate royalties, because you won't know what your royalty basis will be until you have seen the record company's agreement.

You should also provide that the royalty you pay the producer will be computed in the same manner and at the same time as that paid to you by the record company, so that you won't owe money that you have not received to the producer. The computation will differ in one important respect, however—recording costs are usually "recouped" (recovered) only from the artist's share of royalties. This means that, although the artist will not pay the producer royalties until the record company begins paying the artist royalties; the producer will be paid royalties on sales retroactively from the first record sold.

B. Independent Sale of Records

Increasing numbers of artists attempt to sell records on their own in hopes of generating sufficient sales to attract the interest of a major label. Some major acts, such as Missing Persons, Heart, Motley Crue and Quarterflash, have been discovered and signed partly as a result of this strategy.

The distribution network for this kind of product is not often well organized unless an experienced inde-

pendent distributor is used, so it may be difficult to compute any consistent wholesale selling price upon which to base a producer's royalty. This factor, in addition to the reality that many records may be sold directly by an artist at live performances, makes it easiest (and possibly fairest) to compute the producer's royalty based upon the suggested retail list price. Be careful, however, to avoid setting this price at an unrealistically high level, or you may end up paying your producer too much if you are eventually forced to sell your records at a substantially reduced wholesale price.

As with the royalties you would pay if the Independent Masters were released by a record company, the range for producers should be 3% to 5% of the suggested retail list price, although some superstar producers may command a higher royalty. If your royalty computation will be based upon a wholesale price, the percentage should be doubled. As a possible alternative, to avoid the complications of computing accurate wholesale or retail prices for the independent sale of your records, you could offer the producer a percentage of your gross receipts from record sales. Using this method, a fair compensation percentage would be 20% to 30% of your gross receipts, although you should again expect some producers to require a larger percentage.

If you have paid any fees to the producer prior to the sales of records, those fees should be classified as "recoupable advances," and no further sums should be paid to the producer until an amount equal to the advances has been recovered by you from royalties which would otherwise be payable to the producer. (For example, if you have paid the producer an advance of \$2500, and if the producer's royalty is the equivalent of 25 cents per record sold, you would not owe the producer any royalties for sales until 10,000 records have been sold.)

III. COMPANY MASTER RECORDINGS

If you are directly employed or retained as an artist to perform and deliver master recordings to a major record company, you will have stronger bargaining power with

respect to most record producers than if you are merely seeking to promote yourself for possible recording deals in the future. First, you will usually have a recording budget which is sufficient to pay an experienced producer. Second, producers will realize that there is a greater chance to enhance their income and reputation through a major record company release.

When an artist is signed directly to a major record company, the most common source of funds with which to retain a producer is the "recording fund." The record company provides a specified sum to the artist which is available for each album. This sum is designated to cover all costs of recording and, like the "all-in" royalty concept, is the source of funds with which to pay a producer. The artist submits a budget to the record company in advance for approval, and the record company issues checks for various recording costs, including producer advances. This procedure limits the deal-making between the artist and producer, because a record company will not approve a budget containing an improperly high payment to a producer.

The recoupable advances or non-recoupable fees charged by producers in this situation vary widely. For an inexperienced producer of a new act on a minor label with a minimal recording budget, there may be an advance of under \$5000 for an entire album. For a producer with many major credits, producing a superstar act with a large budget from a major label, an advance of \$50,000 to \$75,000 may be required for an album. An agreement with the producer should also contain royalty provisions similar to those discussed in the section on Independent Master Recordings.

IV. CONCLUSION

The right or wrong producer can make or break your project or your career. Your artistic relationship with these individuals is therefore critical to your survival and, in order to maximize your creative and financial success, you should have at least a general understanding of your business relationship with them as well. ■

Kent Klavens is a music industry attorney with offices in Los Angeles.

The Launching of a "Mother Ship"

There's a first time for everything. Satellite transmission is certainly not new, but here is a new application with far-reaching implications for the recording industry

On March 4, 1987, Master Sound Studio at the Kaufman Astoria Studios in Astoria, New York, hosted a bi-coastal remote digital recording demonstration. Stevie Wonder and Quincy Jones at Wonderland Studios in Los Angeles, California, and Nile Rodgers in New York City, laid tracks live, via satellite. The session was a quantum leap for art and technology. The success of "the system" has thrust Master Sound Studios into the limelight as a "Mother Ship" for future sessions of this nature. db brings to you an inside look at how the system actually works, and a background on the makings of a great world class studio. Our interview with Ben Rizzi, co-owner and chief engineer at MSS, was a candid and enlightening one, establishing the logic behind

the magnificent growth pattern that this studio has achieved.

db How about giving us a basic flow of how the satellite system works on a live session.

Ben Rizzi Our machine feeds or console feeds, whatever we're sending to the coast, leave here and hit our ARTEL, a device, basically lasers that convert signal into light impulses. We go down the hall to "the node" which actually feeds Staten Island directly via fiber optics. When we get to Staten Island, which is an international earth station, we can literally feed any satellite in the world including the international ones. So basi-

Figure 1. The basic flow chart of the entire satellite, audio, and video systems

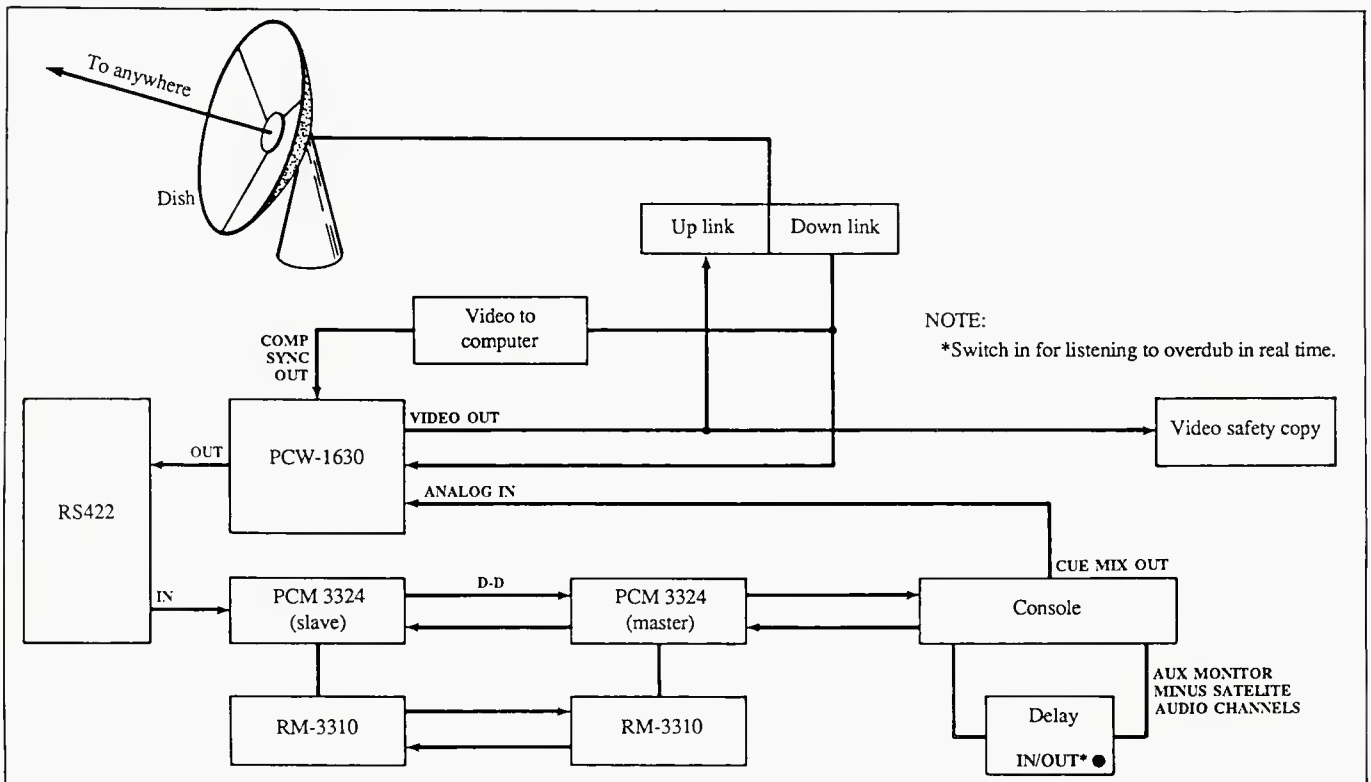

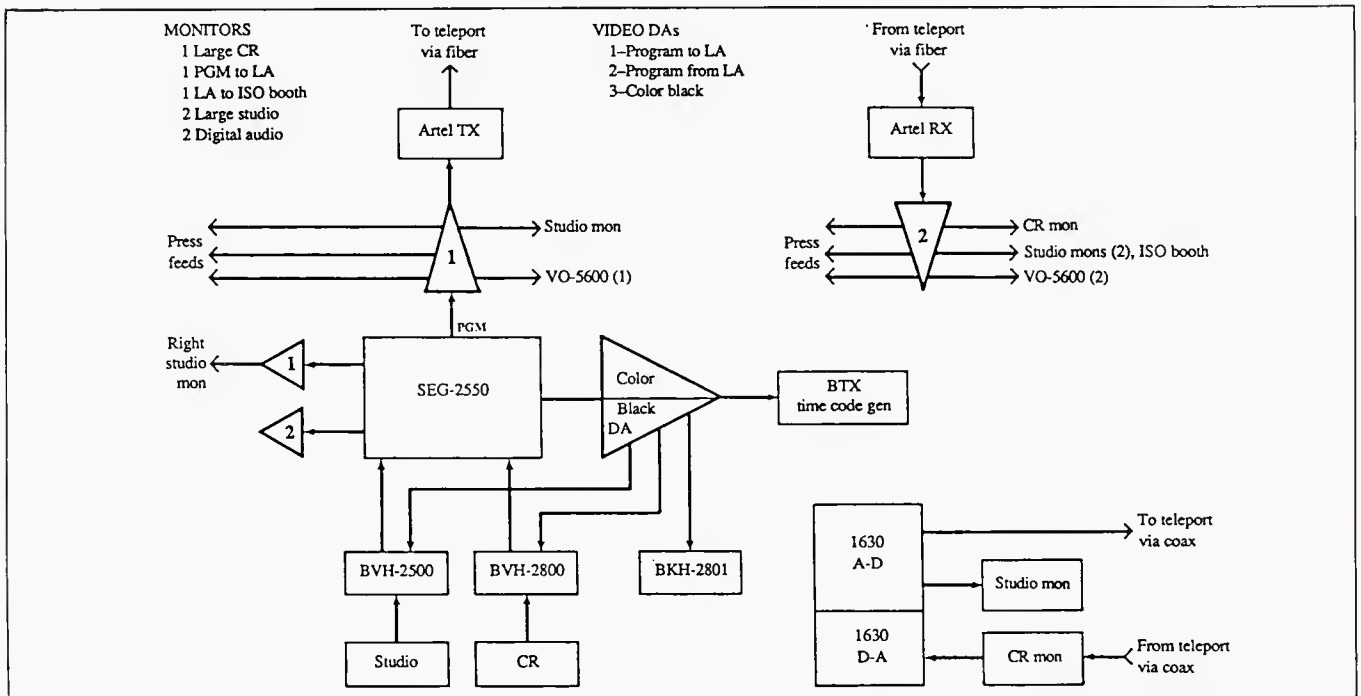

Figure 2. The video plot

cally the earth station feeds the satellite and at the remote location they have a dish. That dish is how they receive their signal. Unfortunately, there is virtually no studio in New York that has a clear shot to the horizon. Even if you do have a clear shot, that doesn't necessarily mean that you're going to be able to use a dish. We're fortunate in having "a node" here. It costs a half million a year to maintain.

db Let's investigate the satellite session in terms of the delays, the corrections that were necessary, and what signals were coming from where.

B.R. The main mix, Stevie Wonder's basic tracks, were being played here (in N.Y.) and we were sending him back the choir. When he was doing the harmonica overdubs, we were receiving his harmonica signal delayed, due to satellite time, and we had to delay our track. Stevie's harmonica was recorded on the second machine with an offset. Then, after it was all over, it was transferred D-D with a correction for that offset, back to the

Figure 3. The time-code plot

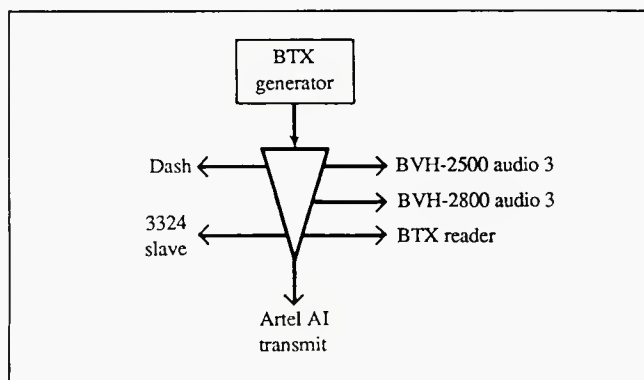

original tracks for Nile Rodgers. Everything stays D-D, no losses. The result of this project speaks for itself. When you, Corey, were here last week for the live demonstration, we had done a test session the week prior. That was our second run with the system. The demonstration was the first time in front of the press and everyone else. Total and utter confusion. Six different networks shooting video and film, stills and what-not. Some people needed mono feeds, some stereo cue feeds, etc.

db A circus... not your typical session environment.

B.R. Right. Not a typical session. Even the most elaborate session doesn't come close to that degree of activity and distraction. Not to mention two hundred people sitting outside, food being cooked and served. It was pretty complicated and yet it still went very, very well.

db That's for sure!

B.R. If it was a typical session, for instance; a one way satellite transmission... that's a coffee break for us now.

db Your choice here in a digital recorder was Sony. Why?

B.R. There are other good multi-track digital machines. I'm not going to say that Sony is the only one, but I am saying that it was particularly easy to do this satellite project with the Sony because it accurately locks up with control track. It's much more sophisticated than SMPTE. It made correcting for any delay a snap.

db Wasn't your ability to correct for that delay dependent upon having two machines?

B.R. Yes, but here's the rest of that story: To me, the Sony system always was a 48-track system, requiring two machines. Number one, they lock together with control



Figure 4. Nile Rodgers and Ben Rizzi at the console during the taping are watching the video monitors

track so well that you essentially have, in every way, shape and form, one machine. The advantage of this system, in my mind, is that I can safety. Pure D-D. The other advantage is redundancy, in case a machine should fail. The machines have been in here for well over a year and they haven't had a tweaker touched to them. Not levels or anything! I have never had machines like that. We pulled them out of the boxes, set the levels a year ago and that's where they've been. We occasionally lay down a 1k tone just to satisfy the client so that if they go elsewhere, they have our reference on tape.

The 48-track system offers me the most flexibility. The tape costs are the cheapest imaginable. On a role of 1/2-in tape, I'm getting twice the time I get on analog. To the client, tape-wise, it's half the price.

db Is simultaneous video going to be utilized for every satellite session?

B.R. It's really up to the artist and/or producer doing it. However, it is desirable to have the video. You can see how an artist is taking instruction. If an artist disagrees with you, you can tell visually by attitude. It gives you a better way of feeling the workings of the session. Yet it's not necessary. What makes the whole system so attractive is that at the current state of the art, if you elect not to have video, you can save about 70% of additional cost. It is expensive to have broadcast quality video going and coming. You can elect to have it just one way.

db How might this become financially accessible to more studios?

B.R. In two to three years, once fiber optic networks become more available, I see more use of that medium. In other words, not relying on the dish *per se* but utilizing the fiber networks to a much greater extent. Before you know it, we're going to be sending console automation information to one another. All kinds of information. That's the way it should be. I don't want to be one of a very few. You see, in order for this to be a profitable endeavor, more and more studios have to join the network. Cooperation with one another, expanding

the network and setting standards for one another might be the greatest achievement in this industry.

db It seems to me that a session of this nature would demand greater preparation on the artist's and producer's parts. Is it possible that this kind of session will have an effect on music itself and preproduction as we know it now?

B.R. To answer that question I will quote Nile Rodgers. He said, on the 25th of February, 1987, "I couldn't believe it was so easy and so natural... it was virtually no different than doing any other session." Of course, we didn't have scores of newsmen jumping all over us. However, there's no doubt about it, if you have satellite time between one and four, you're going to try to be ready. One of the nicest parts about this whole thing was that the technology worked around the aesthetics. Not one iota of musicality was ever sacrificed. Nevertheless, one must face the fact that satellite time is between such and such times.

db Was there anything particularly different about the installation here underneath the KAS facilities as opposed to your old location?

B.R. Well... I'll take you back to the beginning when we first came in here. One of the reasons why we elected to build this monstrous studio here was that we felt that this would be a truly multi-media installation. Above us we have the largest shooting stage (27,000 sq. feet) on the entire east coast.

db...which I presume you are presently wired to, from the control room?

B.R. Yes. We have 50 mic inputs and half a dozen video lines running back and forth.

db That sound stage is quite a stretch of footage away from this control room, isn't it?

B.R. The lines run about 200 feet over and above us. It's right above us, so it's not that far. Now we have two other stages that we are wired to which are 12,000 sq. feet each, to which we run 700 foot lines. We're using booster amplifiers that we convert to line level in conjunction with ultra low capacitance star quad cable coming down to us with a booster amplifier along the way.

db So there are some active black boxes between control room and studios?

B.R. Yes. There's a little active electronics involved. Any time you go 700 feet, you're going to have to do something. By the way, all of our black boxes are custom designed. What we are thinking of doing is converting to light, from the stages above, to here. We might have to wait a little while, because fiber optics as it pertains to recording extended range audio is just starting to become available, and there are a lot of things happening in that area.

db So will you be going digital beyond the 3324's?

B.R. Oh, yes. We could convert those signals from the studio back to analog or leave them the way they are, and shoot the pure digital right into the SONYs. It all depends on what we decide to do.

db The console plays a strong role in maintaining the chain of signal flow that you have established here. Could you elaborate?

B.R. Today many people have not taken into account as to the way the console sounds. We're using a Trident TSM, the biggest one, not because I pulled it out of a hat, but because it has the highest slew rate available. 13 V/uS as opposed to 6V/uS for other popular consoles. If you feed 6V/uS into a digital tape recorder, you're going to have problems. The analog machines have a tendency to digest these problems.

Right now there really isn't a viable alternative to an analog console. Digital consoles aren't here yet. Until the whole chain is pure digital all the way down, we have to convert to analog periodically. What was so nice about the transmission we were getting from the west coast was that it was pure digital. We lost nothing in quality. We gained no noise. Stevie's (Wonder) harmonica overdubs were breathtakingly clear. You could hear his breathing and humming, almost the entire biology of his playing, totally free of any kind of noise or distortion. It was so beautiful.

db Could you give us some of your views relating to the digital vs. analog dilemma?

B.R. I can only tell you in terms of our experience. I feel confident in saying that we have the finest analog multi-track tape recorders in the world. We have Ampex ATR 124's and they're pretty much acknowledged by the insiders in the industry as being real heavyweights. As good as they are, they are still dependent on how we align them, how we got up that morning, bias, etc. As a matter of fact, the machines are much better than the tape itself. Inside of five minutes of tape, I can measure the difference. There can easily be a difference of 1 "dB" in bias requirements. For the first time, I have an analog recorder that is superior to any of the tapes being used. Any recorder has its pros and cons. What I know is whatever you put into a 3324 is what you get back out.

db Why is there so much controversy among some world renowned producers and artists regarding the digital mediums?

B.R. I know of wonderful producers and engineers and others with lots of experience that just haven't had the opportunity to work with the right combination of elements. The good part about digital is that it's the truth. The bad part is that it's the truth. I've had producers come in and say, "I'm doing a rock project, Ben, and it's got to be analog." I say fine. We have wonderful analog machines. Occasionally I'll get a producer in here that I suspect might be a little more open-minded. I say, "Listen, you're doing a rock project, do me a favor, it's on the house, we'll supply a free roll of digital tape. Record it simultaneously analog and digital. We've got 48 tracks

of each." Invariably, as soon as they listen to the playback, they are sold. This has happened on a number of occasions. Some have already said that they would never go back. In another location (another studio) where not as much thought has gone into cable, the console's slew rate, etc., the client gets a very different picture of the format.

db How do you see this skepticism (the bad image of digital) evolving to a greater acceptance level?

B.R. What has to happen is everything else has to start coming up to the quality of digital, which by the way, is getting better all the time.

db Could you touch upon some of your concepts pertaining to studio design and modification?

B.R. This whole satellite thing was a logical progression for us based on the move to here in K.A.S. and on the standards we have set for ourselves. I never followed the pack. There is a particular console that is in vogue right now that I certainly do not have. I chose my console for its slew rate, however, I know that this console lends itself for modification. We've installed all new non-polarized caps and will soon be removing the VCA's, making way for the installation of a new design moving fader system. So we took a good idea and made it bet-

Dare To Compare ?

Go ahead. Take us apart, Compare us to the competition. Then you'll understand why Star Cases are your best value. Fiberglass gives us more impact resistance, One piece inner and outer support extrusion gives us more strength, and step-down hardware gives us added support. For Audio, Video, Film, Computers, Broadcast, Touring Sound or Music, STAR CASES insure that your performance will always shine.

STAR CASES not just different.....built better!



STAR CASE

648 Superior
Munster, Indiana 46321
1-800-822-STAR * 219-922-4440

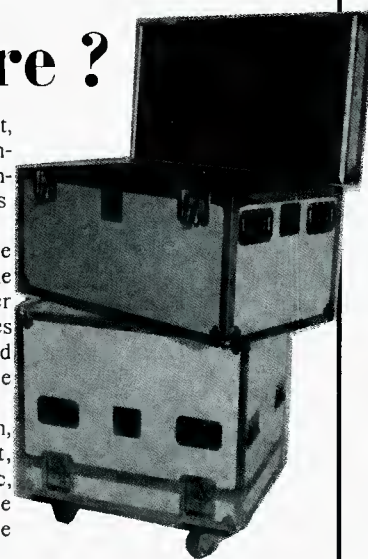

Circle 28 on Reader Service Card

ter. I'm approaching true digital specs here! One of the strongest points here acoustically is that we're controlling reverb time with diffusion and not absorption. We have one of the most honest monitoring systems presently available. I'll be the first to tell you about the problems in having such an honest monitoring system. A pop artist comes in and says it's not bright enough. A classical artist comes in and kisses the speakers. So now what we're finding ourselves doing is changing the monitoring system depending on what artist comes in.

db Is this desirable from your point of view?

B.R. No. It upsets me because I like to have everything perfect and just leave it there. Each time we change the system, it involves setting up a Techron computer and an acoustician, namely Charlie Bollello, and myself looking at it and deciding where to place the HF response. Now we're putting in two separate cross-over systems. One that's truth and one that's B.S. This will be the solution to that problem.

We have no E.Q. on the monitors. When speakers were chosen, the room was built to work with the speakers. When you have to put in an external equalizer, you're correcting for a problem. That's why it's there. A room, ideally, should have no problems. We're hosting the SYN AUD CON convention here in June. At that event, some of the world's heaviest acousticians are going to be tearing us apart. They're going to be figuring out why things are working the way they are here. We're very proud of that. There are very few studios that will lower their pants (so to speak) and say, "O.K., take the measurements... O.K., publish the measurements."

My background is as a musician. In the studio, when I listen to a rock guitar or strings, or an orchestra, or drums or whatever, I'm getting damn close to, if not exactly, what these instruments are inherently to themselves. I know the room is successful from that standpoint. Some people say, "Oh, no! Only your ears can tell what's going on." True... if you don't have a Techron computer and someone to interpret those measurements for you. We're hitting a lot of subjects now...

db Great! We love it! Please continue.

B.R. There's no mystique to building a studio. There are undeniable laws of physics to contend with. Those laws, coupled with the elimination of electronics wherever possible, will lead design in the right direction.

Within the next few years, I think you will see a lot of major rebuilding going on. You cannot escape from the laws of physics. We have two rooms here now and we will be building a third room. Both rooms are constructed in the same way. Because this particular control is so large, we get an extended bass response. There's much more room for the frequencies to build up. In a normal style room, even though it might be a LEDE control room, you won't get that super-low frequency response. Physically, the room cannot build up those waveforms. You can make it appear like you're getting

something that you're really not getting, but you're still at the mercy of physics.

db So no Fletcher Munsons here, huh?

B.R. Ha, ha, ha, ha.

db Is it safe to assume that the right studio acoustics can make a difference in performance as well as the recording?

B.R. Absolutely. How many years now have we had all kinds of absorptive materials and active traps to capture low frequencies? Those items are there because of error in design. What happens is this: Let's say you walk into a room that's semi-alive or whatever. You are a saxophone player; the first thing you do is start playing a little harder and a little harder until either you overcome the absorption or you're blowing your brains out, playing sharp, or squeaking all over the place with the reed. Same with a guitar player. So... when artists can hear themselves, they play more in tune, they enjoy what they're doing and in general, it's related to a better performance. This studio is geared for the performing artist.

db Back-up is very often a sore subject in that there are numerous complaints in the field regarding the lack of assistance and guidance from the manufacturer's end. How alone were you in the conception and realization of this latest satellite project?

B.R. This project was a wonderful success from a cooperative standpoint. The real heavy-duty technical assistance came from Sony and Teleport Communications. Gus Skinas from Sony was a key figure in seeing this through. Mark Schubert from Teleport Communications was also indispensable, being of great help and support.

On the day of the event, I said to Mark, "Now I know what you really do." On the 4th of March, with everyone here, we had every feed available for every network. Mark orchestrated the satellite aspects; he was impressive. Gus gave us incredible technical support from the Sony standpoint. I will say this about Sony... There are very few companies that are so available for all kinds of assistance, advice and back-up. The person responsible for organizing that support, on Sony's behalf, was Gus Skinas himself. GTE Space Net deserves many thanks as well. They supplied us with the satellite time. This whole thing wouldn't have been possible without the cooperation of all these companies. My staff is to be thanked as well. They have not only put up with my craziness, but have helped to maintain a cool and comfortable atmosphere here in the studio.

I feel more confident than ever that we've taken the proper steps, made the right choices and know how to make it all work. The live satellite abilities enable us to link up with the world, and help to compress time thus catalyzing musical activity and cultural expansion.

db Thanks so much for sharing your time with us and best wishes for the launching of your "Mother Ship." ■

Johnny Carson in Stereo

Ron Estes, audio mixer for the Tonight Show and a pioneer of stereo tv broadcasting, has been recording the show's audio in stereo for some time as well. Author Marshall King, in this interview of Ron Estes, sheds much light on stereo in television at NBC

With all the recent interest in stereo, it's sometimes hard to remember that it's been with us for at least 107 years. It was in 1880 that Alexander Graham Bell published a paper in which he referred to the stereophonic phenomena of binaural listening, and in 1892, he demonstrated a binaural telephone. Because this could be enjoyed by only a few people at one time, stereo lay nearly dormant until the mid-1950s when the makers of both phonograph records and magnetic tape started releasing their products in left and right channels. It was then that stereo became a household word, and when the FCC in 1961 announced its official standard for the release of stereo in FM broadcasting, radio, too, was on the bandwagon. For television somehow it was another matter. A general demand for stereo sound in TV was not forthcoming for nearly four decades after television's birth. One guess is that the public was so thrilled with having talking pictures come into their homes, that any thoughts of refinement were not uppermost in the scheme of things. Another guess which sometimes appears in print (and one that is so absurd as to be amusing) is that the equipment and the means for broadcasting high-quality television sound were not developed at the outset because the audio being delivered in the studio was so terrible. The only danger in seeing this incredible statement in print is that

Figure 1. Cluttered and cramped? Perhaps, but everything in the picture, plus a lot that isn't seen, is vital to the production of The Tonight Show. Here, Ron Estes looks up from his work for a brief moment during a commercial.



someone may believe it. Anyone familiar with the truth knows that sound laid down by every knowledgeable audio mixer far exceeded the capabilities of narrow-band land lines, cost-cutting receiver circuits and three-inch speakers. It is not hard to find in the personal libraries of conscientious mixers many audio tapes of the high-quality music which they recorded even in television's earliest days. The fact that this quality, as broadcast, did not find its way to the listener's ears is another matter. The most likely reason for television's delay in going stereo was that an acceptable means for transmitting it had not been agreed upon until March of 1984. In the meantime, many enterprising audio people, knowing that stereo was on its way, were working behind the scenes to get their operations ready for the big day. Sometimes they had to do this without support from the people upstairs. The gear that they put together came largely from junk boxes and spare parts. They were in the forefront of television stereo, however, and when the floodgates were opened in 1984, they were ready. One of these was Ron Estes, currently the audio mixer of *The Tonight Show* starring Johnny Carson. Several years before the FCC gave the green light to TV for stereo broadcasting, Estes had been wanting to make

Figure 2. A study in concentration. Ron "works" a comedy monologue for audience reaction as does the performer. Hopefully, the stereo synthesizer at the transmitter is allowing the center-stage comic to appear in the "center" speaker while keeping the audience reaction in left-and-right channels.



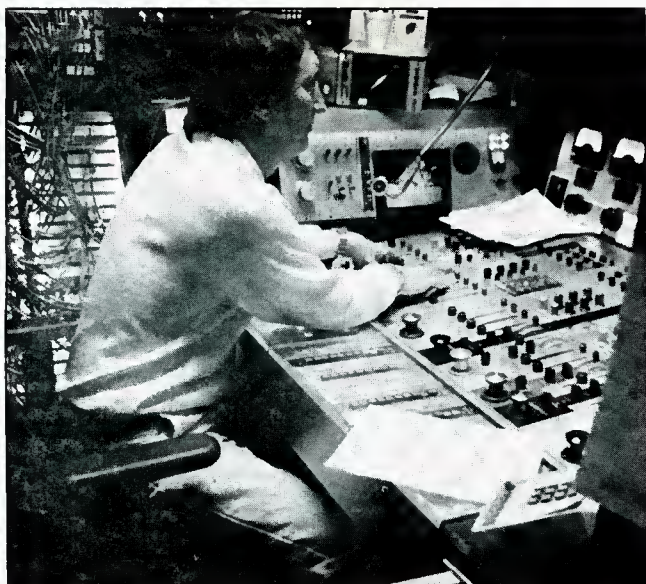

Figure 3. Complete with plexiglass cover to protect faders from busy elbows, the vintage console in Studio 1 has passed along some of the finest sounds in the business, but will soon give way to state-of-the-art equipment ideally suited for fast-moving variety acts televised in stereo.

stereo tapes of the various shows he worked on, even though they were broadcast in mono. Two of these, back in the 1970s, were *Midnight Special* and *The Jazz Show*. In those days, programs were recorded on 2-inch video tape which had only one audio track. But there was a way around this. While the video tape took his mono feed, Ron laid out his console for a left-right split so that a stereo mix could be fed separately to a quarter-inch, 2-track audio tape machine, as shown in Figure 4. This was mainly for his own amusement. There was no attempt to sync it to picture; rather, he saw it as a great opportunity to study the results in order to develop better techniques for broadcasting stereo "live" when it became legal to do so. It was probably a good thing that Estes experimented with two-track rather than 8- or 16- or 24-track machines, since stereo is essentially a two-channel concept. True, the audio on many shows today is laid down on 24 tracks and pan-potted into left and right channels during post-production, but this is an intermediate step at best. It still leads to a 2-track

product. The limitations of working (or just playing around) in two tracks only was probably the luckiest restriction Estes could have had in training for the live stereo that was to follow. After he was assigned to *The Tonight Show*, it wasn't long before Ron was anxious to record it in stereo as well as mono, even though the FCC had not yet approved of a method for its broadcast. At least now, on the Carson program, he had 1-inch video-tape machines to deal with instead of the old quads, which meant that two audio tracks were available instead of one. It was something to think about. There were obstacles, not the least of which was apathy. It wasn't that Estes was expressly forbidden to dabble in stereo, but there was not a great deal of cooperation or interest, from either above or below. Above were the policy-makers, and below was the video-tape department. As Ron puts it, "NBC is a very large company, and if you've ever tried to move a dinosaur you'll know what I mean. So, a few of us just went ahead quietly on our own, experimenting with stereo here and there, doing what we could without making too much fuss about it. Thank God I had the support, both moral and technical, of people like John Strain, who is one of our finest maintenance techs and a real problem-solver." The problems Ron faced however, were not so much technical as they were administrative. As in any large company, channels had to be gone through before things got done. Frustration became the password. For instance, to get permission to feed the show downstairs in two separate channels, left and right, so that it could be preserved in stereo (and played back in mono by combining tracks 1 and 2), was definitely out of the question. Why? Because it just wasn't done. Although the machines had two audio tracks, it was customary to record the composite program on track 1 only. The second audio track was occasionally used for foreign language or "source" sounds, or perhaps as a utility track for editing, but mainly it went unused. To ask the video-tape people at this point to combine tracks 1 and 2 in order to get a mono feed would be a classic example of rocking the boat, a definite no-no in the dinosaur business. Enter John Strain. As the maintenance tech assigned to NBC's Studio 1 from whence emanates *The Tonight Show*, John was well aware of Ron Estes' desire to lay down the show in stereo as it was being broadcast live each night in mono. "I knew Ron was itching to do something in this area," he said,

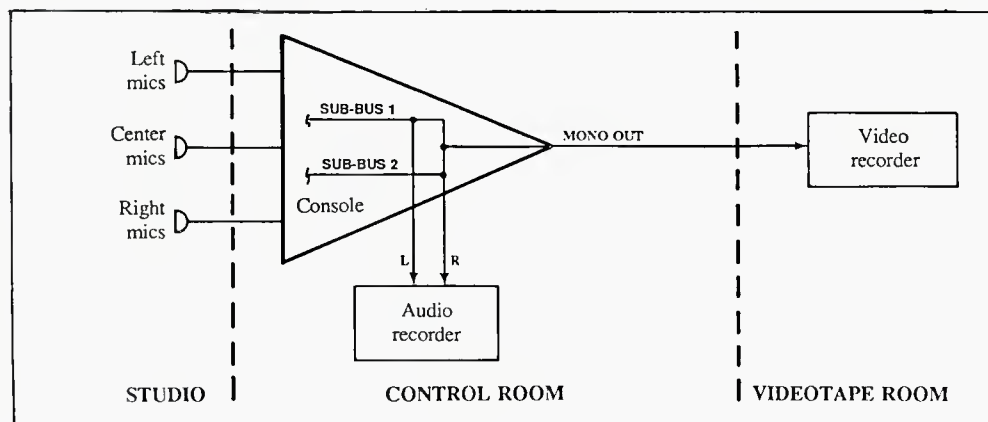

Figure 4. An early method of recording the show in stereo on audio tape, and in mono on videotape.

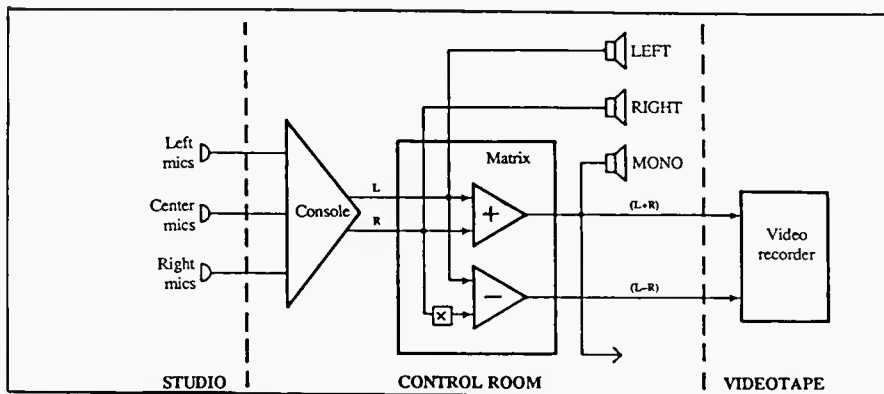
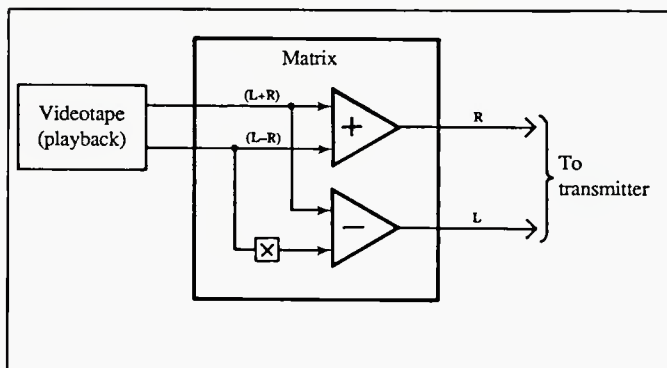

Figure 5. The setup Estes used temporarily to record both mono and stereo on video tape using only two console outputs.

“so we began looking into the ‘sum-and-difference’ method of broadcasting FM radio, thinking that maybe this concept could apply to us.” While the FCC was still examining the various plans being offered for televising stereo sound, John Strain began sketching and wiring. The result was a “black box” matrix of his own design, intended to satisfy both Estes and the NBC establishment. To prepare for its use, Estes divided his stage mics and console into left and right channel assignments as in typical stereo operation. Running the output of the console through John’s matrix, as shown in *Figure 5*, the program was still broadcast live in monaural sound and was still recorded in mono on video-tape’s track 1, but now there was a difference. This mono feed was a L+R signal, created by combining the left and right channels of the console. There was another new element in the process. From John’s matrix, a L-R signal was sent to video tape which was recorded on track 2. This handy signal, while not pretty to listen to by itself, was the magic key which could be used at any later date to extract true stereo from the mono feed on track 1. The sum-and-difference principles were discussed last month in this magazine, but a brief recap might be in order. We can say that if the signals from all the mics used on stage are mixed together, we have a “sum” signal, which is exactly what we’ve been doing for years in order to get our familiar mono output, long before stereo came along. The idea holds true even if we have our console divided left and right for stereo operation. If all the mics of the left-hand channel are added in phase to those of the right-hand channel, we have a “summed” output of all the mics, left plus right, or L+R. Of course, this isn’t stereo, it’s still our familiar composite mono. On the other hand, a L-R signal is obtained by combining the

left-and-right mics as before, with one notable difference. The phase of the right-channel mic is inverted so they’re 180 degrees out of phase with the left-channel mics. By sending both left and right through a mixer or a combining amp, the result is a L-R signal which is sent to video tape to be recorded on track 2. This signal can be considered more as a tool than as a usable sound, for it is the key that allows us to extract full stereo from the L+R signal on video-tape’s track 1. This is so because when (L-R) is added to (L+R), we get a discrete LEFT channel as a result, and when (L-R) is subtracted from (L+R), we get a discrete RIGHT channel. Our stereo can be extracted from a composite mono signal if a sum-and-difference method is used in the original mix. “The nice thing about our black box,” Strain said, “is that the people in video tape didn’t have to change their way of working. They still had the composite show on track 1; all they had to do was record the (L-R) signal on track 2 and forget it. For them it was a minor nuisance, but for us it was of archival importance.” For over a year before the FCC authorized the broadcast of stereo television, *The Tonight Show* was taped in stereo while being broadcast in mono. It may be that the only people who cared about this, one way or the other, were Ron Estes and a handful of knowledgeable cohorts. The people who were monitoring the program, the NBC offices, master control, video tape, the transmitter, etc., certainly were hearing a mono feed as before, only now it was being taken off the output of John Strain’s matrix box instead of the console direct, as shown in *Figure 5*. Ron’s console layout has already been discussed, but on stage other problems existed. The first of these was the assignments of the mics themselves; which channel should they go to? If the show had been a straight musical, with the entertainment center stage, it would be almost too easy. Left-hand instruments go to the left channel, right-hand instruments to the right, and center performers to both. Since the program did not consist of just one camera being aimed at center stage, the problem became more convoluted. Doc Severensen’s band, for example, sometimes fills the screen and sometimes is heard without being seen, so how do you assign the mics? Estes admits there must be compromises. “As a starting point,” he says, “the mics work just as the viewers envision the show. Ed McMahon is on the left, Carson is center, the band is on the right and the audience is split. At times, of course, there is a need to change this, as when an entire production number comes from the band area.” When this happens, there can be some fast button-

Figure 6. A means for decoding the pre-recorded Carson shows before sending them to the transmitter.



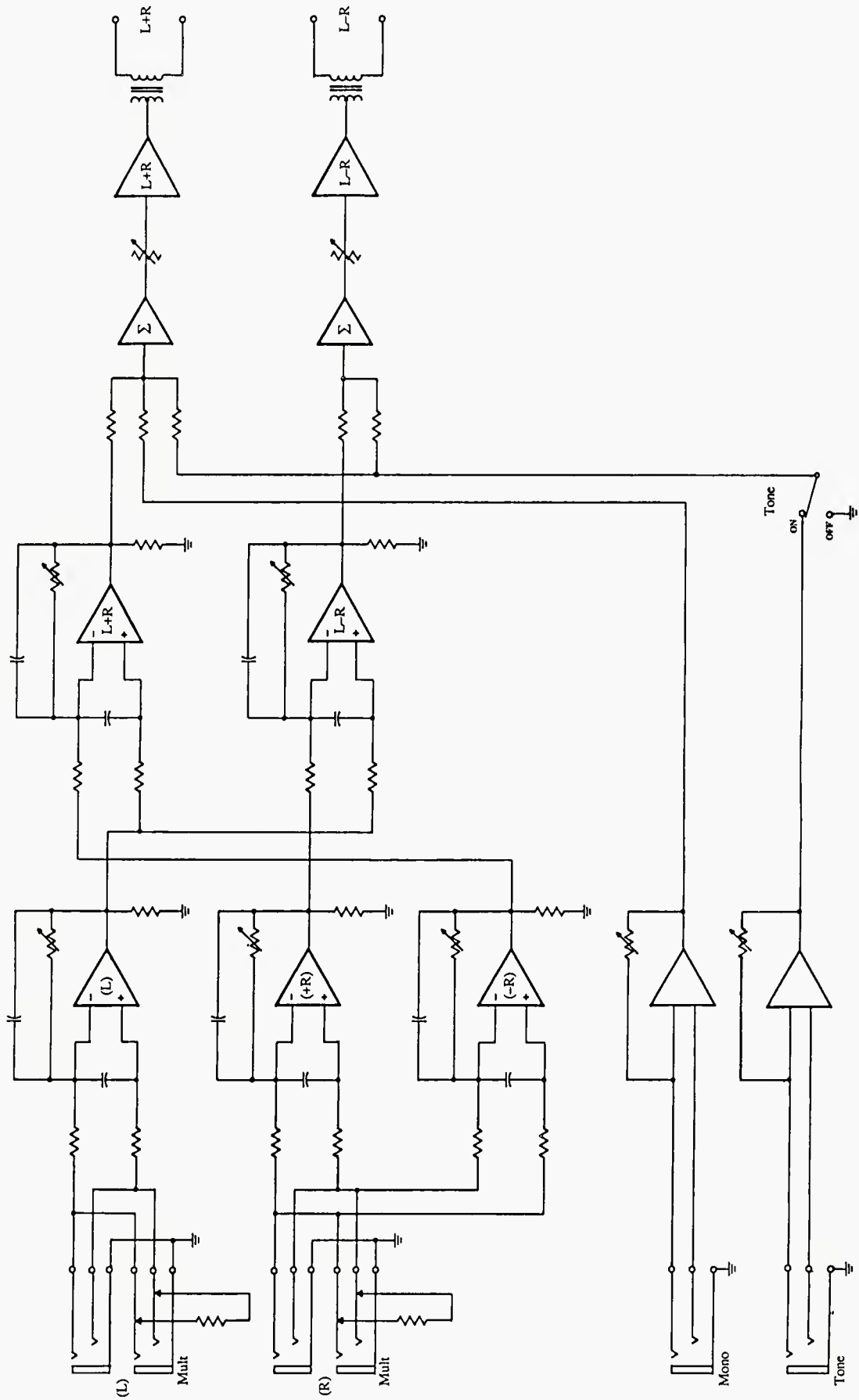
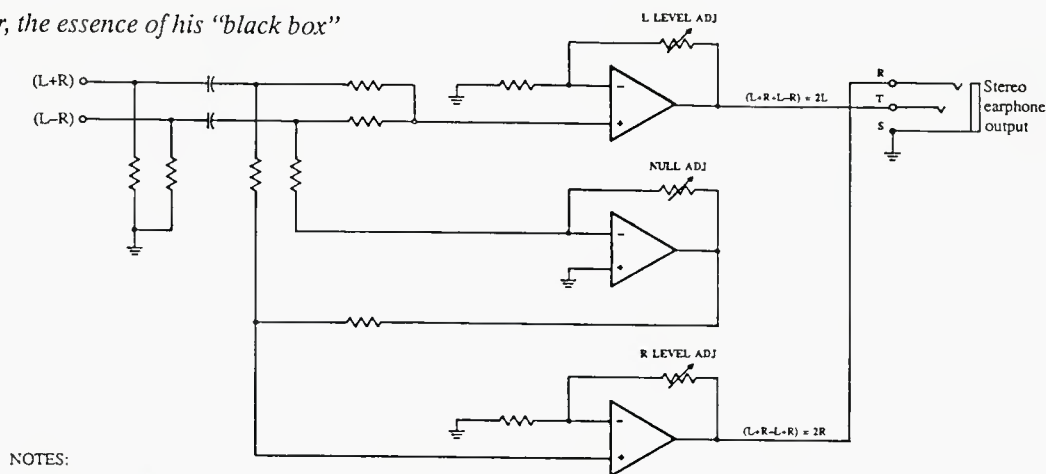

Figure 7. John Strain's sketch of his encoder, and...

Figure 8A. ...his decoder, the essence of his "black box" matrix.



NOTES:

1. L and R level adjusts do not affect null.
2. To set up:
 - #1 - Short (L+R) input to (L-R) input and adjust "NULL ADJ" for no output.
 - #2 - Tone into (L+R) input
 - (A) adjust "L LEVEL ADJ" for L output level
 - (B) adjust "R LEVEL ADJ" for R output level.
3. CHECK OUT! Level as L output should not change with tone input into (L+R) : (L-R) or (L+R) shorted to (L-R) R level should equal L level.

punching in the booth, for Ron works on a console that may have seen more than one pass of Halley's comet. It's a beautiful old workhorse that he plays like a Stradivarius, but the demands put upon it are growing by the week. However, very soon NBC will have completed the installation of their new SSL consoles, and it is presumed that any one of several stereo assignments can be had at the flick of a finger. Airing the band in stereo, Ron gets a bit more "space" to the sound in his use of echo return. "I put the brass on the left and the reeds on the right," he said. "However, I put the *return* of the brass reverb on the right and the *return* of the reeds reverb on the left. This tends to take away some of the ping-pong effect. It's a trick that the recording studios often use and it's very effective, particularly if you're using an older board that doesn't have pan-pots, and your signals must be all the way left or all the way

Figure 8B. In the workshop attached to the control room of NBC's Studio 1, John Strain holds forth the almost-white "black box" matrix he designed for Ron's early experiments on *The Tonight Show*.

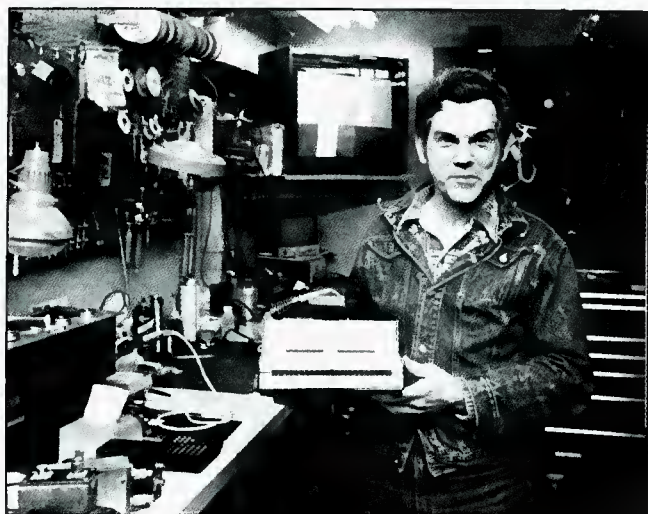

right. With this technique, you hear the initial attack of the brass on the left, but you hear its return coming a bit from the other side. You get your spatial effect that way." Otherwise, Estes follows the maxim that has almost become a "stereo standard;" "stereo standard;" *less is more*, particularly when the show is being done in real time. While the movie industry and certain TV shows may have the luxury of lengthy post-production sessions, whereby it's possible for dedicated stereo to stay with the action no matter where it appears on the screen, live television is far more restrictive. (Perhaps to the relief of the viewer?.) As Estes puts it, "Stereo that is totally faithful to the action is rendered nearly impossible by iso cameras alone. As you know, each iso camera feeds its own video-tape recorder, so when you mix the show you have no idea what they're going to do later in the editing. The only way to beat this is to record the program on audio multi-track so that in post-production, after seeing which shots they actually used, you can steer those audio tracks into the proper stereo channels. What a luxury!"

"But what you saw us do tonight between 5:30 and 6:30 will air at 8:30 (our time) to the east coast and again at 11:30 for people here in the west. There's no time for post-*anything*. The most we can do is to bloop out objectionable words; certainly there's no time for re-doing or re-shaping parts of the program. Of course, if a mic fails or a light blows up they'd stop the show and fix it before going on, for they don't want to air a poor performance, but it would have to be pretty bad before they'd bring things to a halt. In 99% of the time we do the hour show in one hour. In the five years that I've been doing it, maybe we've stopped the tape a total of three times."

On March 29, 1984, Ron Estes received an unexpected birthday present; the FCC approved a method for broadcasting television stereo sound, and it was based on the principle of transmitting sum-and-difference signals. Estes and John Strain couldn't be happier, for they had been doing this very thing for over a year. However,

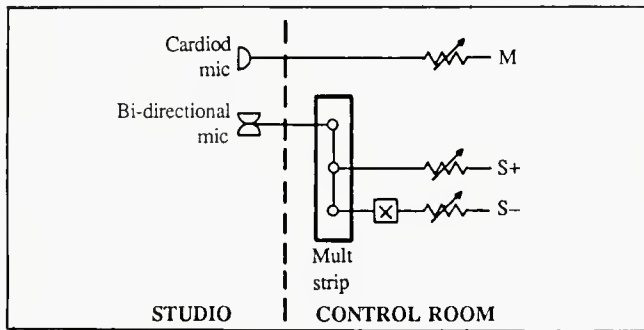

Figure 9. The setup for "coincident" or M/S mic-ing occasionally used by Estes as a point-source pickup for solo performers.

there was a catch; a company engineering policy was announced whereby the two audio signals leaving the studio would not be in the form of (L+R) and (L-R), but rather they'd be sent to the transmitter as TOTAL LEFT and TOTAL RIGHT. The idea now was that the transmitter could do the encoding to form (L+R) and (L-R). This had a familiar ring; it was exactly what Estes and Strain had wanted to put on video tape in the first place, eighteen months ago. That was history. Their solution now was obvious; remove the matrix from the audio console and feed out pure left and right signals as originally planned. While this would take care of the upcoming day-to-day stereo broadcasting of the live Carson show, there were still those 500 video tapes to consider, the ones already laid down in the (L+R) and (L-R) format, which had been planned for use when Carson took a night off. Strain had a solution for this too. Now that his "black box" had been removed from the output of the audio console, why not revamp it so that it became a decoder instead of an encoder, then hang it on the output of the video-tape playback machine? Thus, during playback of these recorded shows, the transmitter would be receiving the proper LEFT and

Figure 10. As one possible arrangement for "coincident" mic-ing, Estes has strapped a Schoeps bi-directional mic (top) to a Schoeps super-cardioid mic to get the setup shown in Figure 9.



RIGHT signals as required. This was done, and the idea is diagrammed in Figure 6. The harmless redundancy during playback was that the audio, previously encoded in the studio, was decoded at the output of the videotape machine, encoded again at the transmitter, and again decoded at home in the TV receivers.

The matrix John Strain devised, both for encoding and decoding, was extremely effective and uncomplicated. Shown here in Figures 7 and 8A, it is based on the bridging principles used by stereo FM radio since 1961. In fact, he saw in its inherent simplicity a possible means for the average TV set owner to have a low-cost decoding device of his own, one that could be put together with inexpensive parts from a Radio Shack-type store. In his memo to me that accompanied the drawings John said, "I had proposed a very simple system of broadcasting the (L-R) channel such that the decoding of it would not involve any complicated circuitry, thus making it cost-effective to install even in the cheapest black-and-white portable TV sets, if desired. Kits could have sold for as little as \$5.00 each, and for television set manufacturers, a single chip could have been built which would have handled the complete decoding process.

"Instead, the system chosen has made decoding so difficult that retrofitting an existing mono TV set is not feasible; an expensive external decoding unit is necessary. It's a shame that consumers are not considered in the implementation of a new technology. I feel sad that the accepted system has excluded so many 'common' people from the enjoyment of stereo TV."

John has a point, although he, like most of us, was not privy to the many parameters the FCC and other committees had to consider in their decision. As he admits,

his circuit does not allow for the decoding of either the "second audio program" or the "professional channel," each of which has been embraced by the FCC but not at

Figure 11. In the studio area near Doc Severensen's band, Rory O'Connor (right) and Ron Estes work out some of the ongoing problems of stage monitoring, another potential obstacle to good stereo.



all necessary for stereo alone.

In addition to a stereo assignment of the many mics on the Carson show, Estes occasionally uses "coincident" or M/S mic-ing. This pickup is effective for use in either a point-source sound, such as a single performer, or for an overall "fixed-camera" presentation such as an opera or symphony. For situations calling for tight mic-ing, as with the Severinsen band or any of the groups Estes works with, the M/S technique would be all wrong, for definition would be lost, particularly in the rhythm and acoustic instruments.

The M/S technique employs either a Soundfield-type microphone or some other close-positioned mic arrangement such as that shown in *Figure 9*. A cardioid mic and a bi-directional mic are placed together so that their patterns are at right angles to each other. The cardioid mic is run into, say, fader #1 of the console, and the bi-directional mic is run into a mult strip, one output of which is run into fader #2 and a second output into fader #3 with the phase reversed (as indicated by the x symbol in *Figure 9*).

"The M-fader is panned center," Estes said, "and the two S's are panned left and right respectively. Now you can steer this thing as follows," he demonstrated. "If you bring up your M-fader only, like this, you'll hear your mono feed. As you start to bring up the two S-faders, you start getting a wider dispersion, a definite *room sound*."

"The M/S I've used here has been very limited. I tried it on a boom once, and the main problem was that the boom cable had only three conductors, which made it a real mess to add another line, with all the racking in and out. However, with a solo performer working center stage, coincident mic-ing is a dream. Instead of that person sitting there as a point source, you now hear the reflections that are normal for the room, and the whole thing comes alive. Another good thing about M/S is that it's totally mono-compatible, because the two halves of the S mic cancel, being out of phase as they are, and you get only the M."

At this point in time, *The Tonight Show* represents a small portion of NBC's programming that is put out in "true" stereo, although there is little doubt that it won't be long before mono in any form (drama, sports, commercials, news, documentaries) will be a thing of the past throughout the medium. In the meantime, the NBC outlet in Los Angeles, like many of the country's stations which are equipped to transmit stereo, apparently does not want its viewers to have to deal with programming that goes back and forth endlessly from mono to stereo. Therefore, many stations such as this have installed a stereo synthesizer at their transmitter which is designed to pass "true" stereo unaltered, while at the same time process any mono signal into "synthesized" stereo. This form of band-splitting is not stereo as we've been discussing here, yet it has met with much viewer-approval in areas that have been tested. Still, among certain aficionados there rages much dissatisfaction with what they hear.

"The trouble begins," according to Estes, "with the synthesizers' inability to discriminate between mono and stereo. Oh, sure, they have recognition circuits which are supposed to take care of that, but here's what happens in our case. I put Carson's monologue in the center channel and the synthesizer says, 'Hey! This must be a mono signal because its equal-amplitude, equal-phase!' Therefore, it promptly throws the program into stereo so that he appears to be coming from the left and right channels instead of center. Then, Carson tells a joke and the audience laughs. Now, I have the audience deliberately split into left and right channels, and when the synthesizer hears this, it shuts off, and Carson is back in the center channel again. So the synthesizer is constantly hunting back and forth during a true stereo program."

"Admittedly, some synthesizers are better than others, and all the designers are working to improve their recognition circuits. The Kintek synthesizer that we use is probably ahead in this area, but it's not infallible. And I've heard some stations flipping back and forth right in the middle of a commercial or a piece of music. When that happens, it's not a pleasant thing to hear; you need Dramamine and seat belts."

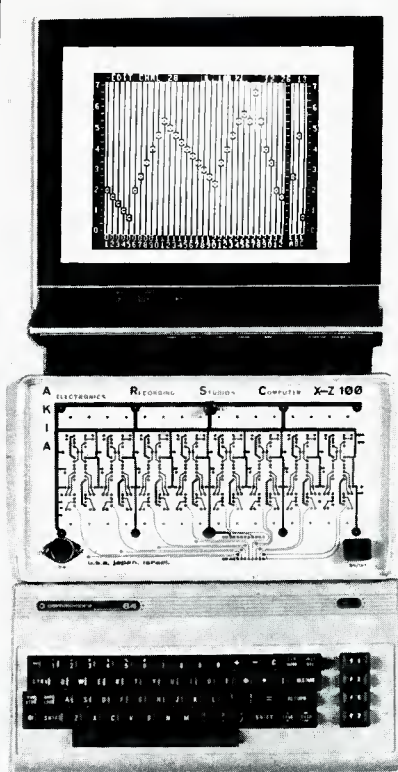

**X-Z 100
COMPUTER**

MIDI EXPANSION
FOR MIXERS

Installs in 30 minutes

Syncs to tape at any
point with
"TIME POINTERS"

THE MOST AD-
VANCED DIGITAL
TECHNOLOGY IN
AUDIO MIXING

all for the basic cost:
\$1499.00

A-KIA electronics
16740 S.W. 301 St.
Homestead, FL 33030

or call:
(305)245-2727
or toll free:
1-800-225-3676

"The one thing we have done here at NBC is that we are computer-controlled. There is a cue inserted into the program that tells the computer, 'This segment is in stereo' or 'This segment is not.' The person who programs the computer works from a log sheet prepared by the traffic department. The point is that the synthesizer at the transmitter cannot, all by itself, make the distinction between the equal-amplitude, equal-phase that comes from both true mono and center-channel stereo."

As many audio mixers know, there are many gremlins lurking to destroy good stereo, even when it's being laid out with the greatest care. One of these is the stage monitors used by music groups, and the Carson show is faced with this almost nightly. This is when a group is doing a guest shot, and without knowing a whole lot about studio pickups for live television, they expect to hear their own amplified sounds coming back to them in great volume from the speakers lying about their feet, much as they do during their concert performances in outdoor amphitheatres. This problem, handed to the mixer by visiting performers, is a nightmare even in traditional mono productions, but in stereo it can be a disaster. Not only does the amplified sound which bounces all over the stage destroy the definition in mono, it renders the spatial concept, the sound separation so crucial to stereo, almost impossible. The lead guitar, for instance, instead of coming from stage left, now comes from stage left, right, center, and perhaps from the ceiling as well.

On *The Tonight Show*, this problem is put in the lap of Rory O'Connor who operates his own console situated between the audience and the stage. His job is to feed to the stage monitors whatever mix the group desires. Usually this means more than one mix; the drummer, in a typical worst case, doesn't want to hear the harmonica, the bass player doesn't want to hear the maracas, and the lead guitar wants only the drums and vocal. Is everybody happy?

"To reduce this madness," Ron said, "We try to get them in here for rehearsal as soon as possible. Now, the group we have coming in Friday, Jimmy Buffet, has a lot of stuff. He plays guitar and sings out front, behind him is a guitar and bass, steel drums, two keyboard players, harmonica, percussion, drums and conga. The more mics you open and the more speakers you feed, the crazier it gets. Also, with synthesizers and other keyboards, they can kill you if they don't pedal their volumes the same way each time. Most of the groups are very cooperative, particularly if they've had TV experience. Otherwise, I've got to let them know that we have our way of doing things here and they are only one act out of a dozen. There has to be a meeting of the minds or the whole thing can go down the drain."

As to whether or not it's all worth it, I asked Estes if what he hears coming back on the air sounds as good as what he heard in the control room. His closing remarks were optimistic.

"About the only criticism I have is that there is more noise, when I listen to it off the air. But remember, I'm

on a cable system just as you are, and I think they're doing a damn good job of passing this stuff through."

"Beyond that, I feel fortunate that I've been able to follow the process through from here to the routing switcher downstairs, from there to video tape on through to master control, from there to the channel that feeds the microwave, and from there on to the mountain (the transmitter at Mt. Wilson). I've made tapes of what I hear on the air, and I've got to say that at each step along the way, they've done an excellent job of protecting the quality of sound."

"You'd be surprised at the satellite system they've put together here, a terrific job. And they did it when everyone else, the other networks and all the rest, were talking about using the C-band for satellite transmission; that's in the 3 to 4 gigahertz region, occupied by the telephone company and others. NBC decided to go with the KU band. A lot of people said it would never work because of rainfall and other sources of interference, but NBC managed to work around all that."

"Also, KU uses smaller dishes, smaller receiving equipment, and you don't have the problem of terrestrial microwaves crossing the country using these same frequencies that C-band uses, with all its heavy traffic. You can put a receiver right at the station and there may be an AT&T microwave transcontinental signal going right across it and it doesn't interfere. If it weren't for that superb satellite delivery system, I don't think we could put out the good stereo that we do. They've really done some fine things in keeping our signal clean."

"Let me leave you with this. Sure we've had our growing pains all along the way. The pressure can build in one area or another, but you can't lose your sense of humor. Just between you and me, when I started doing this, I had a hard time dealing with some of the production people because I was getting no feedback from them. Then I realized that that's where they are when it comes to audio; they just don't want to hear about it unless something is wrong. They wanted us to put up three mics and let it go at that. But attitudes are changing, and I think we have stereo to thank for that. Things are still not perfect, but I think we win more than we lose." ■

Here's a tip . . . a Tax Tip.

Don't Pass up the opportunity to get free information on numerous tax subjects. IRS has over 100 special publications to answer tax questions. In fact, Pub. 910, "Guide to Free Tax Services," describes all of the free tax services available. Call 1-800-424-FORM (3676) or the IRS Tax Forms number in your phone book to get a copy.



A Public Service of the IRS

Beyond World Class

Howard Schwartz Studios in New York City is at the forefront of advanced technology. Can this be supported by the music recording industry?

The Howard Schwartz Studio, today, is as abreast of pre- and post-production technology as a studio can possibly be. A slow, painstaking transition has taken the studio away from the rock and pop record industry into the most competitive high-tech (very, very high tech) world of video, film and audio post production. The result... this studio lands some of the biggest commercial accounts from movies to major network television productions. In this interview, we will examine the kinds of awarenesses that are essential to "staying afloat" in a world that changes with every blink of our eyes.

Born September 18, 1946, Howard Schwartz started with the trumpet at age nine. By the time he was thirteen, he was ranked among the best in the United States. His musical talents won him a full scholarship to the Eastman School of Music. To cover college costs, Schwartz became a D.J. at a local radio station; a career move that served him well after he was drafted. For the next three years he spun discs for Armed Forces Radio in Berlin, Frankfurt and Munich.

Now with seven studios, high speed and real-time dubbing, cassette duplication, computerized trafficking of tapes, satellite uplink and downlink, and six sound-effects libraries, Howard Schwartz has thirty employees. His clients are all Fortune 500 companies and include Exxon, GM, ABC, NBC, HBO, J. Walter Thompson, Young and Rubicam, not to mention numerous record albums, movies and movie soundtracks.

db Let's define "world class."

Howard Schwartz I pose the question to the industry: Who asked for all this stuff? I see people going in and out of business. We are told to buy stuff that doesn't always work, with no back-up, and we're stuck with long-term payments and fickle customers that say "...well, they're out of business so we can't use that piece of gear anymore."

db Is "world class" an illusion?

H.S. The fact is that not one piece of gear has come through my door that has changed my sales except an SSL console. In thirteen years of being in business, not one piece of equipment, besides going from 16- to 24-track, has increased my sales like the SSL did.

db Is this increase the result of the client's demand for that console, or has the console proven to be cost effective as a tool in your hands?

H.S. It's still not cost effective. Now that the dollar is so screwy, as of the 10th of February, an SSL that I bought last year for \$260,000 is now \$340,000. That's just because of the dollar. That means that it takes me one-third more to pay for it. We are not in a growth period.

db Well, maybe we can *re-define* world class and give our readers a new perspective pertaining to an owner's needs, client demands and if possible, cost effectiveness.

H.S. Yes, a redefinition, that's the idea. The word is diversify. I survived to this point in time because I realized the need for diversification years ago. Now everyone wants to get on the bandwagon. Where am I going from here? Am I going to go back into the record business, or am I going to open a candy store in White Plains and sell Lotto tickets? Lotto's a big money maker, and the overhead is nothing. (He laughs.)

Figure 1. Howard Schwartz at his console.





Figure 2. The Studio West control room.

db Do you feel that production techniques and the right personnel help to make up "world class?"

H.S. The human-being side is really the key. We are redefining "world class" based on human beings and service as opposed to the equipment. Everybody can go out and buy equipment that is as good or as bad as the next guy's. At AES, there is one huge floor hosting every manufacturer in the world, many of whom try to sell you junk that you don't need. The fact is that I can do the same job with ten Ampex 351s, one microphone, and if everything was tubes and the stuff worked the way they said it was supposed to in the book. If I had the luxury of ambient space, time, and I could record an orchestra live, I could do an even better job. Because we don't have these luxuries of space and time, we now have to deal with multi-tracks, a storage system, synthesizers, and digital and wigital and schmigital all combined. The parameters of musicality are often neglected. You can't even have a spontaneous laugh in a show anymore because the machines do that. You can't have a sound-effects guy really doing a sound effect. You have to try and find one that somebody recorded four, fourteen or forty years ago (such as at the CBS Sound Library), and put it into a 1987 television show. How do you get it into the 1987 television show? Well... you can sit there and push buttons and shoot it in with your hands and you miss it. Then you roll back the videotape and the 24-track and do it again. Or you have a Compusonics hard-disc storage system, or an AMS so you can have three stereos going all at once... am I going too fast?

db No, not at all!

H.S. You can let what was natural fall on its face, or succeed by its own virtue as did real radio and live television. I'm only forty years old but I remember. Live TV was spectacular. However, today, technology has given people the ability to do these things.

db Is this leading to the democratization of art? In other words, are people going to have the means to do all these things at home in their kitchens?

H.S. With MIDI and such, almost everybody has the ability to do that. When you see a well-known, high-tech synthesizer advertised in the Spiegel catalog, you know something's wrong. It's amazing.

db How do you justify buying the new piece of gear?

H.S. What happens is this: We have a rental medium here. Our inventory is time, so every hour we have has to be sold. Any hour that we don't sell can never be recaptured. Time cannot be listed as an asset. So we are a rental medium. We get phone calls and someone might ask, "How many AMSs do you have?" We might say, "We can rent them for you because we don't own them." Then they say, "Thank you very much, click." That is the justification.

db How far do you go in trying to please clients that might also be victims of a techno-hype market?

H.S. The conformity factor of the recording studio is 99% of what we do. We try to put in the studio what we think will do the job that they ask us for most of the time. When people hear what we have in the studios, they'll always ask us for that one additional piece.

db What kind of questions from clients determine your acquisition of new equipment?

H.S. The questions come from out of the blue; from a television standpoint, we get questions beyond your wildest dreams. The main reason that people ask technically off-the-wall questions is because they screwed up someplace and they can't do it easily. Somebody at their company didn't talk to somebody else about the logistics of their project, so they go to the studio that is the most sophisticated hoping that they can plug fourteen things together and have it all work right. An example is: Somebody shot 25 frames, 50 cycles, NTSC, non-drop frame, "can you do it?" The standards are all over the place. The answer is, "Give us a minute, we'll figure it out..." and then they say, "How much are you going to charge me for it?" I say, "Well, it's \$350.00 an hour." They reply, "So how many hours will it take?" I say, "Well, it'll take about eight hours to do the show." They say, "\$2800.00! I only spent \$2000.00 to shoot the thing!" So I say, "Goodbye." My question is how do you prepare for that? I've got hundreds of thousands of dollars worth of little bread boards to take 50 cycles to 60 and so on and so forth. What happens is that you've got standards.

db You're talking about standardizing something that isn't. That's quite an undertaking.

H.S. Oh! This is the problem! The storage mediums. Not to beat a dead horse, but we have eight 24-track analog tape recorders, one going on two digital machines. There is nothing wrong with an analog tape recorder. We have three ways to record: No noise reduction, Dolby noise reduction, dbx, and now a fourth, Dolby SR. But you still have wow and flutter.

Between you, me, and the lamppost, if digital didn't exist, if nobody asked for it, we'd still be wailing away. I mean, there's \$132,000 that I really didn't need to spend. I have seven studios. That's one million dollars in digital machines that are nearly outdated.

db If I were to ask you how business is, and you were to answer in one word, would you say tough?

H.S. Two words: extremely tough. There's a lot of business around. People are shopping for studio time because there are a lot of studios like ours, at least five, that are in this league equipment wise. People wise, it narrows it down a lot. People are the key. If you don't have somebody that can run the equipment, you can have all the equipment in the world and it isn't going to do you any good. As you'll see, some studios pop up and fade fast. If they don't have the experience, they fall by the wayside. If many manufacturers keep coming up with stuff that we really don't need, and tell my clients that they need these things, I'm going to open that candy store in White Plains. Am I being too negative today?

db Maybe. But someone's got to do it. However, we should bring the positive side to light.

H.S. The positive side is that I really don't want to open a candy store in White Plains. I love the bells and whistles, but...I don't like being lied to. Some of my colleagues would say, "Hey, it's great, everything is wonderful! We're making more money than we ever made before. We just bought three of these storage mediums, two of those storage mediums and my clients love it." The sad fact is that these guys can barely pay their own salaries. All of their money is going to some banker, and/or some equipment manufacturer instead of towards making a decent living for themselves.

db Tell us about your transition into pre- and post-production work. Why have you moved away from the band-oriented sessions?

H.S. The music business has become highly compartmentalized. Previously a band might come in for a lock out. We're talking about weeks, even months. Much of that time is often wasted by the client. Lateness, illness, egos, whatever, all contribute to wasted time. That's wasted time not only for the client, but that's time I could be selling. Pre- and post-production work has its advantages in that the sessions are shorter and are often financed by proper budgets where the client has a better concept as to the utilization of his time according to his needs.

db Could you remember and tell us about your first big project/assignment? What were the highlights?

H.S. Well, I go back much further than a lot of guys. The first big project that I ever did was on a Nagra, a little portable thing. It was mono, with a four-channel Shure mixer. I used two Sennheiser 421s and two Neumanns. I was in the service in Germany. I was sent to a concert hall in Munich to record Oscar Peterson live for Armed Forces radio. I was a disc-jockey in the service. I didn't know what the hell I was doing. I was twenty years old.

db Did you experiment or try to do anything special with what little gear you had?

H.S. Basically I just put the microphones up; I put them like my ears would be, sitting in the front row. It was spectacular, absolutely spectacular. Oscar has a copy of it. I sent it to him years later. There was an upright bass, "real" drums, a "real" flute player and the piano. The sound was gigantic. We all looked at each other and said, "God... this is fun!" I can put that tape up right now and some people might say that it sounds like a digital recording. Did I answer the question? What was the question?

db I asked you to remember...

H.S. Remember? What?

db The old days.

H.S. The old days...

db Things worked well at times for you and you didn't have the gear available that you do now. The fact that this old recording sounds so good (almost digital) suggests that you did something *right*. That's amazing. There's a message in here somewhere.

H.S. The only things that get better over the years are your ears, your brain and your taste. All the equipment in the world does not give you the ability to have taste or ears. I've heard some guys say, "I need those speakers because they'll tell me what I need to know, and I need 4,000 watts." B.S.! Go out in the room. What does it sound like out there? The guys are playing. Oh...well, it's all obnoxious guitar...you can't hear the keyboards or the vocals? That doesn't sound like music to me. What do your ears tell you it needs? Is it music or not? That's the bottom line. All the storage mediums and gizmos should only help you. Our job is to recreate the best way known to man. No piece of gear, by itself, does that.

db Any comments on automation?

H.S. The only thing that automation does is to make things repeatable. It doesn't speed up the process. I just wish manufacturers would stop telling us what we need, and telling my clients the same B.S. at the same time. It's saturation. Overload.

db Do you anticipate automating your bookkeeping soon?

H.S. The computers are here. We're waiting to go on line. We bought a system from a film house; a program that fits our business. Most recording studios do four or five invoices a day, I do one hundred and fifty to two hundred a day. Some might be for \$850.00, some for \$8500.00. We do them all by hand.

db Rumor has it that you are gearing up for the purchase of a "tapeless studio."

Howard Schwartz Studios Latest Addition to the Complex:

STUDIO WEST (1 of 7 studios)

Equipment List

SSL 6000 E- 48 input with total recall
Sony 3324- digital multi-track recorder
MCI JH 24- analog multi-track recorder
Studer A-820- center channel time code, 2-track
MCI JH-110C- 4-track
Dolby XP-24
EMT 140s- plate reverb
EMT 250- digital reverb
Lexicon: PCM 70, PCM 60, PCM 42
Lexicon Prime Time
Lexicon Delta T delay
Pultec EQs
LA2A compressor limiters

Urei 1176 limiters
Orban Parametric EQ
Technics turntable
Nakamichi MRI cassette
Urei 813, Yamaha MS-10, Visonik, Auratone monitors
Hafler, Crown, Sound 80 power amps
Yamaha SPX 90
Yamaha Rev 7
Video, film synchronizers: Adams Smith 2600 Sync. edit system
NEC TT800 1-inch cassette recorder with TBC
Sony BVU 870, 3/4-inch, SP recorder
Fortel 4-688 TBC
Igagami, Videotech, Sony monitors
Tektronic, Grass Valley video system
Magnatech 10,000 series mag. dubber, 35mm, 4, 3 and 1-track, 16mm
Nagra IV- S time code

H.S. If I'm going to be forced into a "tapeless studio," I'm not going to buy one unless I can take my information and go to John Doe's studio and do my job there as well.

db On the flip side of all this negativity, technology is an amazing, beautiful thing. Where's the light at the end of this tunnel? In other words, isn't there some kind of technology or medium that isn't available now that you would like to have?

H.S. I'd want a universal storage system. We would settle on a technology beyond what we have today as opposed to compact discs, for example, which are based on Philips technology from 1980. Even better, something you can pick up and walk around with. I have seven studios, so I'd want to use it in all of them. I want my clients to be able to go somewhere else, too, and work in that medium. A medium that doesn't take real time to load or unload. Digital storage mediums today are still real-time up and down load. If you recorded forty minutes of digital material on a hard disc or some other storage medium, it takes forty minutes to get it off of

that storage medium. Now, do I charge my client for that forty minutes, or do I have to use my time for that forty minutes, or do I wait till the end of the day? Well, the client doesn't have the time because they're going over to the video house to shoot this etc., etc.

db What's the name of this new toy?

H.S. "Fast on, fast off, walk around, in your hand."

db Sounds good. I'll take ten.

H.S. I don't think it's going to happen. Two hours instant access for under \$2000. Stereo. Unbelievable.

db Howard, I want to thank you for this revealing interview and I know all our readers will appreciate your honesty and hard work.

H.S. No sweat! Well...maybe a little. Well...probably a lot!

2 to 8 trk



Dragonville Studios: A Construction Story

From little acorns a studio will grow. Herein read about one small studio that is less small than it started as, and in its building, a story is woven.

Dragonville is one of the very small number of studios which is owned and operated, as well as designed and built, solely by women. We chose LaVerne, California for our location. We're out of the L.A. madhouse, but since the studio is only thirty-five miles from L.A., we're still close enough to the Hollywood "buzz." We have tried to make Dragonville comfortable as well as functional. In doing so, we have created an atmosphere that draws not only local musicians, but many L.A. acts as well.

IN THE BEGINNING

Dragonville began meagerly enough in a bedroom of a condominium as Barbara's personal-use studio. At first we simply called that bedroom with equipment "The Studio," but when we decided to open to the public, a more interesting moniker was needed. We coined Dragonville, as it's an Americanization of "Here Be Dragons" found on the old pirate maps that Barbara has such a fondness for. We distributed flyers through the local music stores and soon were recording acoustic

guitar and piano-oriented singer/songwriter demos. The first full band session we completed was pressed into a four song/four band EP and released on Toxic Shock Records.

In July 1983, we took lease on a 1400 square foot unit in an industrial building. The new site of the studio measured 26-feet wide by 52-feet, 1-inch, and had 14-foot ceilings (*Figure 1*). The east and west walls are of mortar-filled cinder block construction, while the north and south walls, which divide the studio from adjoining units, are standard 2 x 4 and drywall interior walls. Additionally, the southwest corner contains a glass storefront and door (the obvious site for our 14 x 12-foot office), while the east rear wall has a large aluminum loading door with a smaller entry door inset. The 6 x 8-foot restroom is nestled in the northeast corner.

Since the studio's operation time of evenings and weekends compliments those of the neighboring businesses, soundproofing has not been our major concern. Primarily we focus on sound quality inside the studio. Keeping extraneous sounds out of the studio, and security are secondary concerns.

Figure 1. Dragonville Studios floor plan

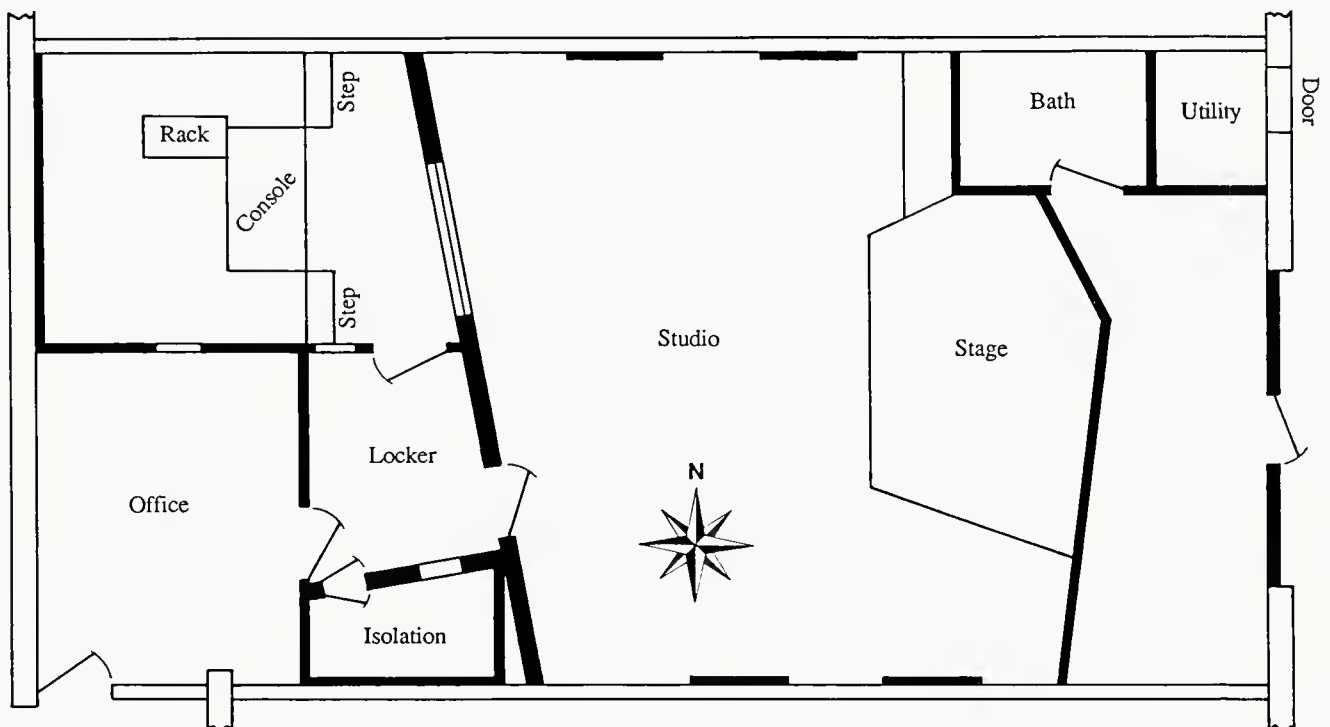

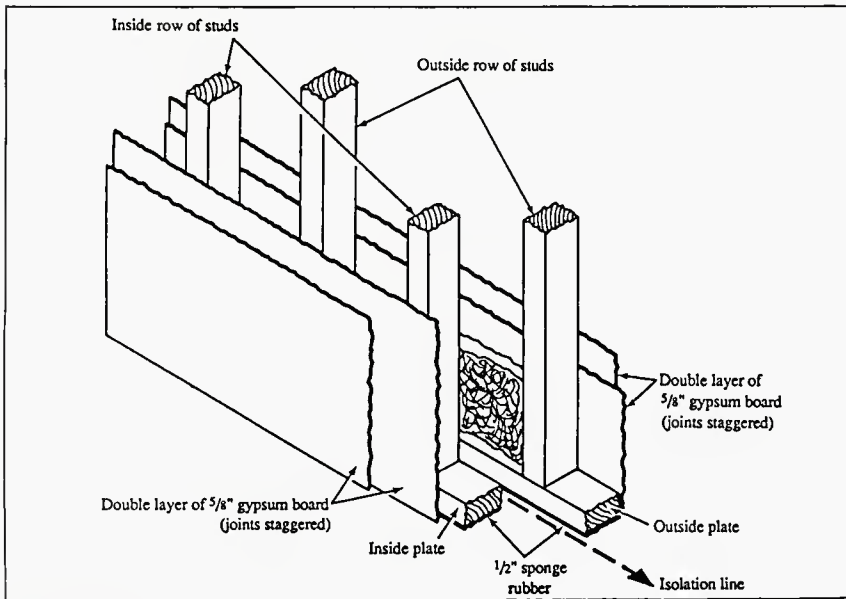

Figure 2. Cross section and composition of wall separating the control room from the main studio

BIT BY BIT

As is best with all great endeavors, we designed the studio on paper and then divided the overall construction into stages. Stage one was completed before the studio was opened for business; stage two occurred during December 1983; stage three was completed about one and a half years later and stage four is set for the near future.

Our lease stipulated the building of the office by the landlord. The 2 x 4-inch and drywall dividing walls span floor to ceiling; it has a "T" bar dropped interior ceiling; a solid-core door leads into the sound lock (before stage three it led into the main studio); and it is 14-feet wide. This width left an open area 12-feet wide beside the office which became the control area and later the control room (stage three). Once the office was completed, we were free to begin Stage I with a lot of help

Figure 3. The cross section of the control room wall containing the double-glass window. Note the skewing of the studio side glass

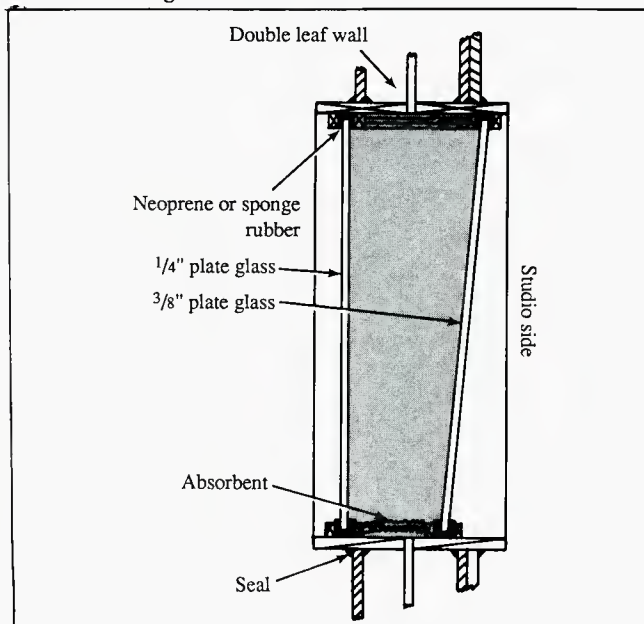

from our friends, especially Bill Mozley, who traded his carpentry expertise for future studio time.

STAGE I

Dragonville's physical creation began in July of 1983, as we transformed the shell in our industrial building into a comfortable place to write and perform music. A great deal of work had to be done before anyone would consider this a place worth recording in. The big loading door (east end), although handy while we loaded lumber, had to be sealed shut and soundproofed. After heavily caulking and weather stripping the perimeter, we reinforced it with 3/4-inch particle board, filled the 3-inch cavity with glass fiber insulation and faced it with tempered 1/4-inch pegboard. The perimeter of the inset entry door was also weatherstripped and reinforced, and we installed a 360 degree peephole.

The main studio was designed to serve as both a recording area and a rehearsal room, to make the most of the studio. A drum booth, though advantageous for recording, would severely divide the room and make it too small an area for comfortable rehearsal. A 9 x 14-foot stage/drum riser, 1 foot high, was built instead. This riser is covered in carpeting to prevent drum walking, and isolated from the studio floor with soundboard and filled with sand. During recording, gobos around the drums control reflections as needed. A broad "V"-shaped wall that functions as a large Helmholtz type absorber backs the stage. Overhead, seven 5 x 5-foot hanging panels diffuse sound waves. A double-wide doorway on the south end of this wall allows access to the storage area, restroom and rear door.

The raised control room floor, of similar construction to the drum riser, is 12 x 12-feet and 1 1/2 feet above the concrete floor. The un-raised area in front of the control room riser, created by the "Stage Three" wall, is a 12 x 2 to 6-foot linoleum-floored visitor/observation area. Three horizontal absorbers, each about 4-feet high, comprise the rear Control Room wall. Layered over the cinder block original wall are, bottom to top: a rigid membrane bass trap (2 x 4 inch, plywood and insulation), a Helmholtz resonator tuned to high frequencies (2 x 4 feet; pegboard and insulation), and a second Helmholtz resonator tuned to absorb broader mid-range frequencies (2 x 4 feet, pegboard and insulation). The pegboard face is also used to hang cables not in use.

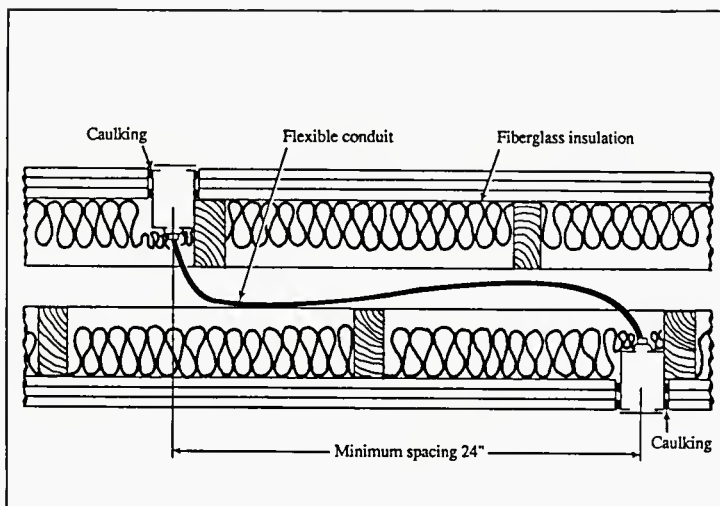

Figure 4. The cross section of the studio/control room wall. Note the staggered access openings

The monitor speakers were hung from the ceiling and aimed down and into the mix position. The console table itself is of 2 x 4 and 3/4-inch particle board construction. Later, in Stage Three, the sides and front were covered in wood slats and the top surfaced with black plexiglass.

The studio side walls, after being painted, were fitted with several Helmholtz resonators (our construction: 4 x 8-foot x 1/4-inch pegboard attached to 1 x 4-inch and 2 x 4-inch frame and filled with insulation) to control the audio spectrum, mostly the mid-range frequencies. We were careful to stagger these resonators between the north and south walls.

OPEN FOR BUSINESS

With Stage One completed, we opened for business on August 6, 1983. The main room sounded very smooth. Rehearsal patrons liked this, and we did too. The musicians could hear themselves easily without needing excessive power and we could hear the live P.A. mix. Recording presented some problems. Although the room provided a great sound, all monitoring had to be done with headphones since we were actually still in the same room as the musicians, amps and instruments. Fortunately, we changed this with Stage Three.

In December 1983, after being open and trying to maintain an even keel, we undertook a small project. We built an isolation booth. Our booth, a trapezoidal shaped free-standing room, measuring 8 x 5 feet at its largest points, decouples from the studio floor via its sand-filled base. The walls are of 2 x 6-inch staggered

stud construction and faced, inside and out, with 3/4-inch particle board. All studs were covered with sponge rubber so that no two actually touch. The particle board increases the mass and density of the walls. Two solid-core doors (one opening in, one out) provide entry into the booth. A double-paned 2 foot square window allows visibility into the sound lock. A second 2 foot square window in the sound lock/control room wall further allows visibility into the control room. Whoever is in the isolation booth can receive visual signals or encouragement from the control room. The interior walls of the booth are covered with a patchwork of carpet and mirrors. The carpet deadens the room while the mirrors reflect sound and create a larger sense of space. We experimented as we tuned the booth and tried to get the right combination of live and dead surfaces to interact. Listening tests and a real time spectrum analyzer helped us to create a room that sounded good and felt right.

This isolation booth has come in handy. We've been able to record full bands live with the guitarist's amp in the booth, amplified to create the artist's "sound," while the band follows with headphones. Individual acoustic guitarists have appreciated the isolation from extraneous sounds provided by the booth. Simply, the booth has made recording easier.

STAGE THREE

October of 1984 saw the beginning of Stage Three, which took us nearly a year to complete, working after and in between sessions. We lovingly nicknamed this project "the Wall," but in reality we built two parallel 26 w x 14-foot h walls 4 inches apart, a smaller "cross" wall of 6 w x 8-foot h x 1 1/2-foot, 3-foot deep soffit in the control room along the new wall. This construction yielded a separated control room, a sound lock and a soffit in which we flush mounted the control room monitor speakers. These were solely the physical benefits. The variety of ways in which this wall has made recording easier are vast.

The largest wall, splayed and spanning the width of our unit was built first, as everything else stemmed from it. Knowing how important it is to keep sounds from transferring from the studio into the control room and vice versa, we built this barrier employing the double-wall construction method (Figure 2). Two separate walls, each with its own top and bottom plates, 2 x 4-inch studing, glass fiber insulation and double-layered gypsum board facing now separate our control room from the main room. We were careful to stagger the seams of the gypsum board. We taped and caulked the joints. The outer perimeter of the wall received a healthy bead of caulk, as did the door, window frames, ceiling and AC plug boxes. A 3 x 8-foot double window, one pane in each wall, allows visibility between the control room and studio. The control room pane is 1/4-inch tempered glass while the studio side is 3/8-inch tempered glass. The panes are mounted into "U" shaped rubber and have been sealed with silicone caulk. The studio side pane is skewed 20 degrees (Figure 3).

The wall on the studio side was wired for electricity and a mic box allows line access to the control room. We took care to stagger all openings in the studio wall in reference to the other side in the control room (Figure 4).

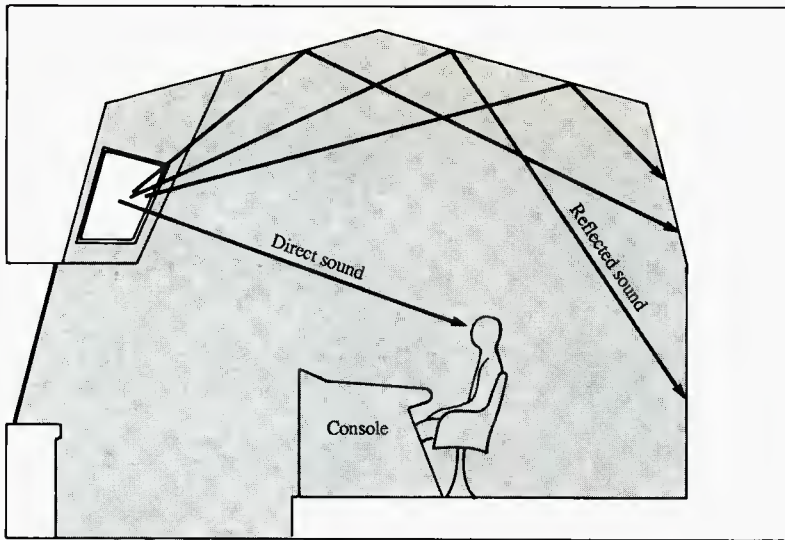

Figure 5. A diagram of the "T" Bar type suspended ceiling used in the control room.

COMPLETING THE WALL

The completion of "The Wall," and a smaller crosswall that extended the office wall created the sound lock. All rooms enter into this sound lock. A 2 x 2-foot window affords a view from the isolation booth to the mixing desk in the control room. A solid core door leads into the control room. We wired the sound lock with mic and line jacks, as well as headphone jacks. The sound lock also functions as a second isolation booth. The lock serves its third purpose by holding all our electronic keyboards.

The area above the isolation booth and sound lock is used for storage and allows access to the control room air-conditioning unit.

We built the wall across the beam where the control room monitors previously hung. We needed to find a new place to put the monitors, and thus built a soffit. Constructed on the east wall of the control room, the soffit spans from 7 feet above the floor of the visitor's area to the ceiling. The monitors, each built into its own cavity, are flush mounted and point down and into the central mixing position. The soffit helps acoustically by working as a bass trap in the control room. Additionally, the rough hewn wood facing the soffit controls higher frequencies (Figure 6).

The completion of "The Wall" resulted in a final version of the control room interior. The control room/office wall is covered with a mixture of rough and smooth wood surfaces, diffusing sound in the control room. The

Figure 6. Master control



control room ceiling is a "T" bar type suspended ceiling, using 1-inch thick, rough-finish acoustic tiles (Figure 5).

Stage Four is planned for the near future. Construction of a splayed second wall along the south side of the studio is planned. A slant front soffit above the drum riser/stage will span the full width of the studio. The soffit will replace the hanging panel diffusers and will be built of 2 x 4s and insulation, faced with rough hewn wood. The soffit will function as a broad-band absorber.

Further treatment to the control room will be minor. The north wall will be covered with rough and smooth wood. The equipment rack we now use will be replaced with three shorter free-standing racks.

After nearly four years in this business, we are gratified to see Dragonville continue to grow and to see our designs work so well. We set out to build a studio that was special. Because of its carefully planned layout, open atmosphere and good feelings, we've achieved this in Dragonville.

We welcome questions about construction or any other facet of the recording studio.

EQUIPMENT LIST:

- Carvin MX 1688 console
- Tascam 38 recorder with dbx
- Teac A-3440 recorder with dbx
- Teac V-4RX, Teac V-417C, Sony TC-FX7 cassette decks
- Transaudio 912 and Auratone "Cube" monitors
- Deltalab, Yamaha, dbx, DOD, NEI, Ibanez, Numark, MXR, PAIA, Loft outboards
- AKG, Sennheiser, EV, Shure, PZM, Sony mics
- Ed-Cor and Tascam headphone amps
- AKG and Koss headphones
- Carvin P.A. system
- Carvin power amps
- Tama drum set
- Fender bass
- Ovation 6 + 12-string acoustics
- Les Paul, Stratocaster and Ovation solid-body electrics
- Carvin, Fender and Peavey amps
- Wurlitzer electric piano

Lab Report

Tascam ATR-60-2T 2-Track Recorder/Reproducer



Figure 1.

General Information

This 2-track tape deck from the professional Tascam division of TEAC Corporation is one of a family of four 2-track stereo tape machines. Employing 1/4-inch tape, the ATR-60-2T has a half-track format with an extra 0.3 mm IEC center stripe data track for time code. It operates at either 7.5 or 15 in./sec., with equalization set for NAB (switchable for IEC standards), fluxivity set for 250 nWb/m (switchable for 320 nWb/m). Other versions of the deck are available, including one that operates at 15 in./sec. and 30 in./sec. The transport is supplied on one chassis with the electronics mounted in another, allowing both sections to be mounted in a standard 19-inch equipment rack, in a portable 19-inch rack case or in a roll-around console. TASCAM's optional RC-65 Remote Transport Control can be used with this model to operate all transport function, including pitch control.

Interfacing between the ATR-60-2T and any time-code-based equipment is made via a single, rear-panel accessory connector that carries all the necessary logic and tally signals for use with most popular time-code systems. Electronics are mounted on plug-in, pc boards for ease of servicing. The VU meter panel swings out and down for easy access to all the trimmers required for maintenance and alignment. This allows you to see the meters while making adjustments, regardless of whether the unit is mounted vertically or horizontally.

The ATR-60-2T transport is fully microprocessor controlled. A full servo reel system keeps tape tension within limits to avoid stretching. The capstan motor is

regulated by a phase-lock loop servo system. Major rotating components are supported by ball bearings for minimum friction while retaining close tolerances. A tachometer roller measures linear tape footage, but the readout is converted to elapsed time from whatever zero point you enter into "memory." The tape head assembly includes two fixed guides, an idler roller and three heads: erase, record/sync and reproduce. A flip up cover and a latching, push-down head shield provide full access to the heads. As we learned during our lab tests of this unit, both the record/sync head and the repro head yield almost identical full frequency range reproduction during playback—a fact that will be appreciated by recording artists during overdub or insert recording.

The ATR-60-2T uses direct coupled amplifiers in its electronics section. The recorder is equipped with a master bias oscillator plus a separate bias amplifier for each track to avoid inter-track interactions through the bias circuit for quieter punch-in and punch-out recording. Audio levels are monitored on the two large VU meters which include peak indicating LEDs. Input level for the center "time code" track is displayed by a set of three LEDs.

A built-in "auto-locator" function lets you search for a precise location on a tape based either upon the zero point of the tape counter or on a user defined cue-point. Cue points can be entered "on the fly" while listening to program material. When the tape enters the stop mode after a search or after fast winding, reels are slowed to a

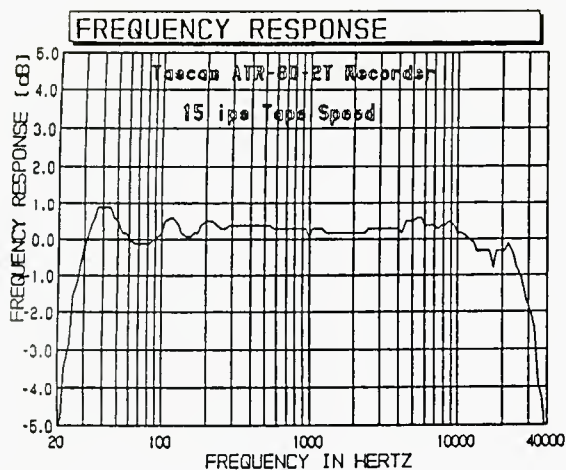

Figure 1A

stop by means of dynamic braking, avoiding slippage and stretching by maintaining a more constant torque during the process. In addition to the usual fast forward and fast rewind modes, there's a spooling mode, during which tape runs at an intermediate speed for a tighter more uniform tape pack.

The familiar "Edit" mode is available for manual turning of the reels in either direction. Tape can be "dump edited" by pressing the "Play" and "Edit" buttons simultaneously.

The special 0.3mm wide track centered between the normal width NAB tracks that differentiates this machine from the TASCAM ATR-60-2N version is used primarily for data such as recording and playback of SMPTE/EBU time-code and other synchronization time codes. In addition, a switch alters the center track input/output circuitry so that it can record voice "memos" or cues or slate tones. The center track is not, however, suitable for use as a full bandwidth audio track. This model uses a special set of heads. A combination head handles erase and record/sync functions. The erase portion of this head has separate gaps for each of the two audio tracks and for the time-code track. The record/sync head also has separate gaps for each track, all three of which are vertically aligned to make certain that the time-code data is perfectly synchronized with audio programs. Unlike tape machines that use a separate head for a time-code track, no time-code delay circuitry is necessary.

CONTROL LAYOUT

The usual NAB reel hub adapters permit use of either 10-1/2 inch reels or 8-inch reels with this recorder. A reel-size selector switch and a speed selector button are

Figure 1B

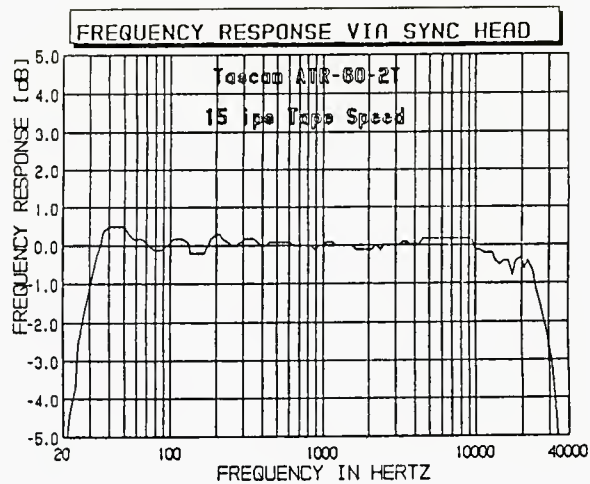
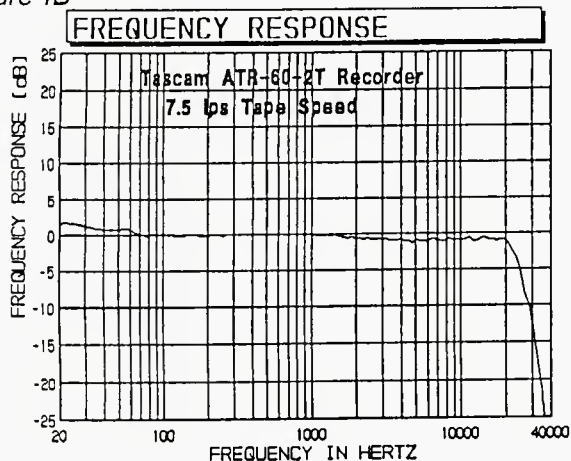
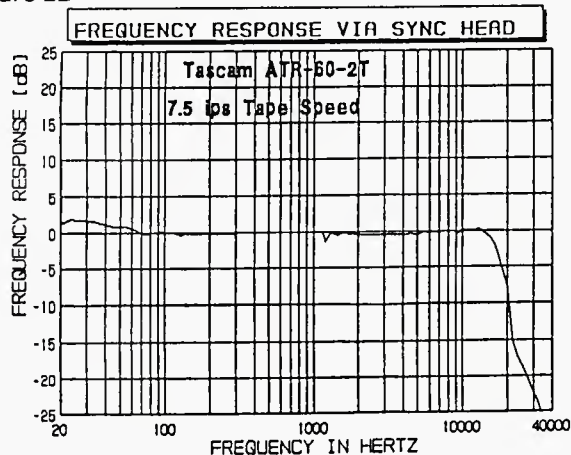

Figure 2A

located adjacent to the power switch at the lower left section of the transport chassis. Also in this area of the panel are the a pitch-control indicator (pitch can be varied by as much as +15%) and three inter-related buttons which determine whether tape speed should be controlled by the course and fine slider pitch controls below, be fixed at the nominal 7.5 in./sec. and 15 in./sec. speeds or be controlled externally. A tape lifter lever, used for audible cueing during fast winding is also found here as are six additional small touch buttons and indicators. Three of these buttons determine the source of the signal to be fed to the output connectors and to the VU meters (input, sync, or repro). Two of these six buttons determine whether the associated track can enter the record mode, and the sixth button, called a "Stop Mute" switch, if engaged, eliminates the usual "dragging" sound that might otherwise be heard as tape is moving up to or down from normal playing speed.

Below the right takeup reel are a four digital tape counter and its reset button, five tape transport buttons plus an "Edit" button. The five transport buttons include Rewind, Fast Forward, Play, Stop and Record and these become back illuminated when depressed. Three smaller buttons positioned just above the main tape transport buttons are labeled "Cue," "STZ" and "RTZ." The Cue button is used to set a cue point by memorizing the tape-counter reading (no actual cue is recorded onto the tape). The STC button activates the search-to-cue function while the STZ button activates a return-to-zero (of the counter) function. The rear panel of the transport section is equipped with a 38-pin accessory connector for direct interface with SMPTE/EBU time code synchronizers or other controllers. A 60-pin remote control connector also found on the rear panel is used with the optional Tascam RC-65 Remote Con-

Figure 2B



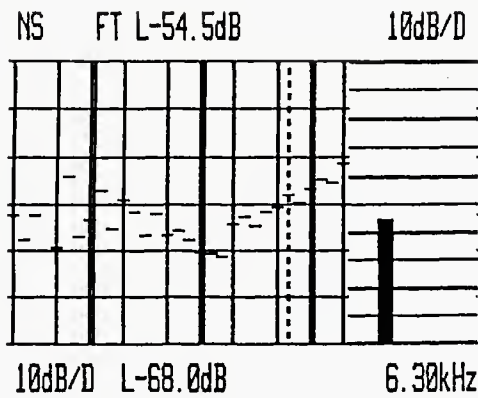

Figure 3A. S/n analysis at 15 in./sec unweighted

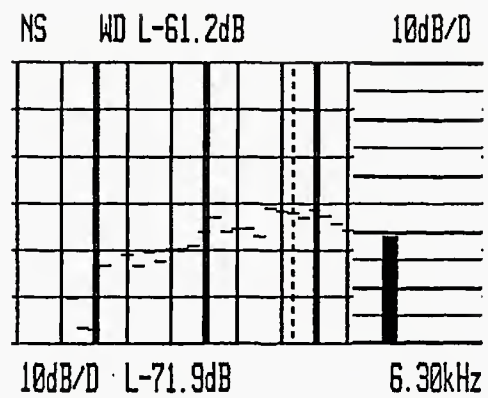

Figure 4B. S/n at 7.5 in/sec A-weighted

trol Unit. The four remaining connectors on the rear panel accept the four cables supplied with the unit, all of which are to be connected to equivalent connectors on the companion amplifier/electronics module.

The Amplifier module houses the two large illuminated VU meters, each of which is also equipped with a peak indicating LED. Input and output level controls, a phone jack and phone level controls are also found on the front panel of the amplifier module as are four "UNCAL" (uncalibrated) buttons for the Channel

XLR connectors are used for audio signal inputs (female XLRs) and outputs (male XLRs). Outputs may be switched to an unbalanced mode by means of nearby slide switches. In addition to the four cable connectors to which cables from the transport module are connected, there is a multi-pin connector used for interface to the optional Tascam MA-650 Monitor system.

LAB MEASUREMENTS

A complete table of VITAL STATISTICS covering

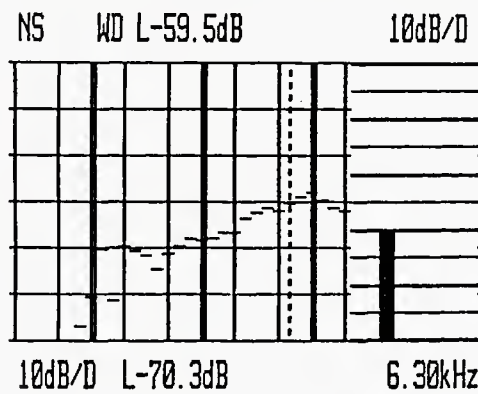

Figure 3B. S/n analysis at 15 in/sec A-weighted

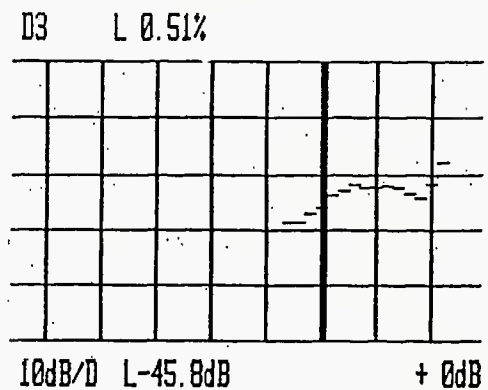

Figure 5A. Third order distortion vs. record level at 15 in.sec

1 and Channel 2 inputs and outputs. When any "Uncal" button is disengaged, the associated level control is bypassed and a +4 dBm nominal input signal can be passed on to the outputs without any level alternation. Input and output level controls are therefore only effective when these buttons are depressed.

Figure 4A. S/n at 7.5 in./sec unweighted

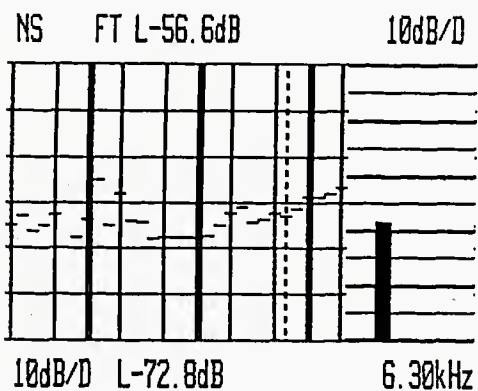
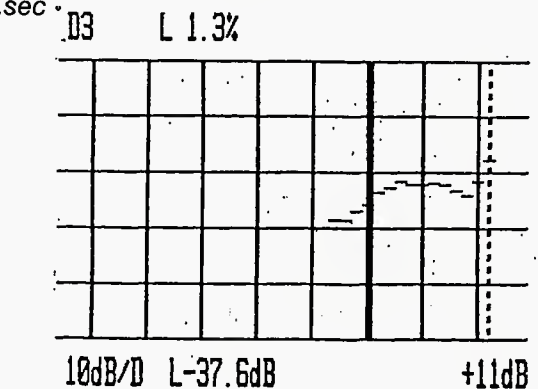

Figure 5B. Third order distortion vs. record level at 15 in.sec



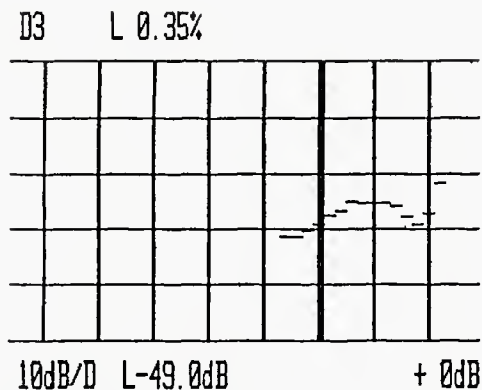

Figure 6A. Third order distortion vs. record level at 7.5 in/sec

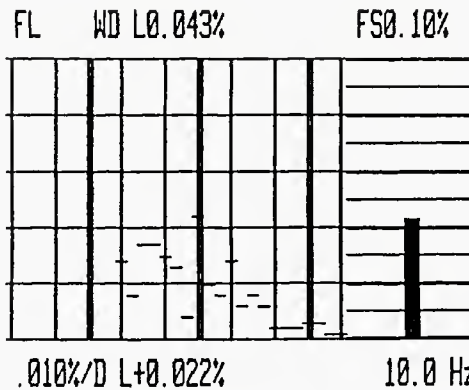

Figure 7B. Wow and flutter analysis at 15 in/sec weighted

level and are shown graphically in Figure 1A. Figure 1B shows response at the slower, 7.5 in./sec. tape speed, and this time, recording level was set to a -10 dB level. Under those conditions, response still extended way out to 24.0 kHz.

We wanted to see how well the record/play response would hold up if reproduction was measured during playback via the "sync" head rather than via the "repro" head. Amazingly, results were very nearly as good, with response extending all the way out to 31.0 kHz for a -3

plete S/N analysis for both of these conditions is shown in Figures 3A and 3B. S/N measurements were repeated at the 7.5 in./sec. tape speed and results of these weighted and unweighted S/N measurements are shown in Figures 4A and 4B. Because of the slightly narrower bandwidth and somewhat different equalization at the slower tape speed, S/N was actually a bit better at 7.5 in./sec. than it was at 15 in./sec., measuring 56.6 dB unweighted and 61.2 dB A-weighted. It is important to bear in mind that all of these S/N results are referenced

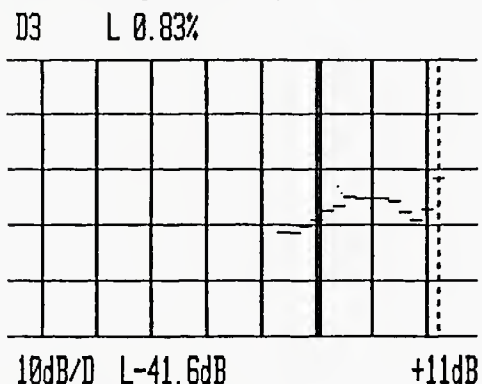

Figure 6B. Third order distortion vs. record level at 7.5 in/sec

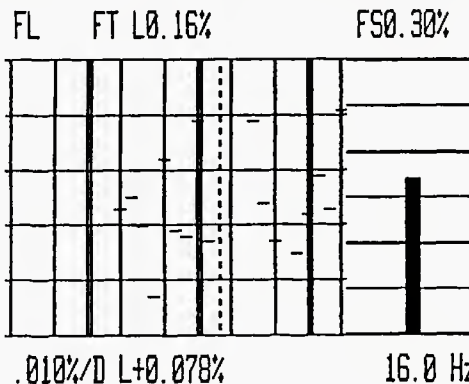

Figure 8A. Wow and flutter analysis at 7.5 in/sec unweighted

dB roll-off at 15 in./sec., as shown in Figure 2A. Even at the slower 7.5 in./sec. speed, record/playback response via the "sync" head extended out to 17.5 kHz, as illustrated in Figure 2B. Overall unweighted signal-to-noise ratio at 15 in./sec. tape speed measured 54.5 dB, while with an A-weighting filter inserted in the signal measurement path, S/N improved to 59.5 dB. A com-

to 0 dB. If we were to add in the headroom available on this machine (TASCAM claims +13 dB or so before the 3% THD point is reached), results would be 67.5 dB unweighted and 72.5 weighted at the 15 in./sec. speed and 69.6 dB unweighted and 74.2 dB weighted at the 7.5 in./sec. speed.

Figure 7A. Wow and flutter analysis at 15 in/sec unweighted

Figure 8B. Wow and flutter analysis at 7.5 in/sec weighted

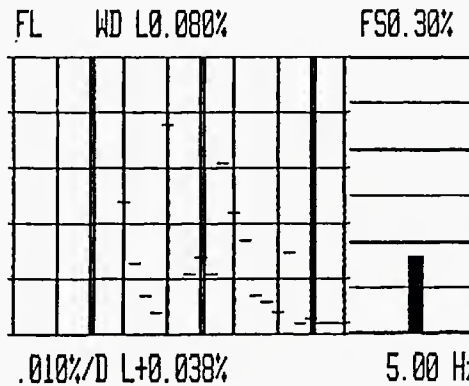
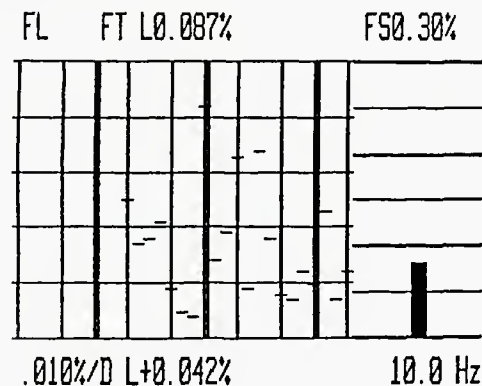

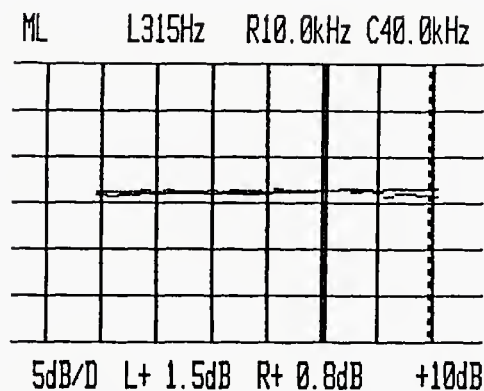

Figure 9A. Maximum output level (linearity) at 315 Hz and 10 kHz at 15 in/sec

Third order distortion at 0 dB record level, using the higher tape speed was 0.51%, as shown in Figure 5A. Figure 5B is identical to Figure 5A except that the electronic "cursor" has been moved to a +11dB record level, at which third harmonic distortion was still well below tape saturation, measuring 1.3%. Our automatic test gear is limited to +11 or +12 dB relative to reference (0 dB) record level, so the plot is unable to show how much headroom the recorder had before actually reaching 3.0% distortion. Manually, we determined that the 3% third harmonic distortion point is reached when recording levels are set at +14 dB above nominal 0 dB on the meters! So, to be perfectly fair, you can even add another 1.0 dB to the S/N figures with respect to the 3% THD point calculated above. The measurements were repeated for the 7.5 in./sec. speed and results are shown in Figures 6A (unweighted) and 6B (A-weighted). Again, bear in mind that the numbers shown in Figure 6A are for 0 dB record level, while those in Figure 6B are for a +11 dB record level, which was still short of the 3% distortion point.

Overall weighted wow-and-flutter at 15 in./sec. measured 0.043% while at 7.5 in./sec., weighted wow-and-flutter was somewhat higher, measuring 0.08%. In both cases, results were better than claimed in the published specifications. Figures 7B and 8B show these results as well as an analysis of the frequency components of the wow-and-flutter. For comparison purposes, the measurements were also made with no weighting, and those results are shown in Figures. 7A and 7B for 15 in./sec. and 7.5 in./sec. conditions respectively.

The graphs of Figure 9 show how much the output, during playback, departs from perfect linearity compared with the referenced input at various levels from well below the nominal 0 dB reference level up to +11 dB (+15 dBm) record levels. Our Ampex tape was a little on the "hot" side and so even at record levels equal to or below 0 dB, output was a bit above the horizontal center line that corresponds to "0 linearity deviation, in dB." The important point of these measurements, however, is the fact that this output level remained almost perfectly constant for both the 315 Hz and the 10 kHz test signals as levels were increased all the way up to +11 dB at the 15 in./sec. speed (Figure 9A). At +10 dB, the difference in output between the low-frequency and high frequency signals was only 0.7 dB (1.5 dB shown as the "L" figure for 315 Hz, minus 0.8 dB shown as the "R" figure corresponding to the 10 kHz test signal). As you might expect, results were not quite as impressive for 7.5 in./sec. operation (Figure 9B). Neverthe-

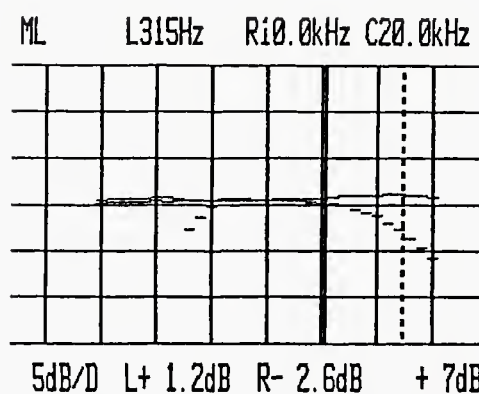

Figure 9B. Maximum output level (linearity) at 315 Hz and 10 kHz at 7.5 in/sec

less, at 0 dB recording level, the difference between the 315 Hz and the 10 kHz output during playback was negligible. At higher recording levels, however, evidence of high-frequency saturation increased, and by the time a +7 dB recording level was reached, the difference between the 315 Hz signal and the 10 kHz signal during playback amounted to 3.8 dB (+1.2 dB -2.6 dB).

COMMENTS

We were very favorably impressed both by the performance of the TASCAM ATR-60-2T and by its many useful features. Among other things, the owner's manual supplied with the recorder was one of the best we have ever seen supplied with a professional piece of recording equipment. The manual is intelligently divided into 11 easy to follow sections, each of which is easy to read, understand and follow. Illustrations are clear, as are the many, many diagrams illustrating use, alignment and, if necessary, servicing of this unit.

The transport was also extremely quiet, both during normal tape play or record and during fast-wind operations. All of the microprocessor controlled functions, including the search modes operated unfailingly and with great precision. The splicing block supplied on the front of the tape transport, unlike many we have seen on other units, is ideally positioned for quick tape splicing. You are not likely to get into a tape tangle when using this block. While we didn't have access to a time-code generator/controller, the availability of that narrow center track is something that many studios will appreciate, particularly since it's rather unusual to find this feature on a 1/4-inch tape deck, professional or otherwise. Our tests extended beyond those illustrated graphically in this report. For example, using spectrum analysis, we checked for modulation noise. It was extremely low at both operating speeds. Erasure was better than 75 dB referenced to +10 dB record level, which means we couldn't see any residual signal at all. If there was any, it was buried beneath the residual noise floor of the tape itself. Although the center time code channel is not intended for wideband use, we did some recording onto it and were surprised to see that in the "memo" mode its response extended to just above 10 kHz—not at all bad for a "data" track that measured only 0.3 mm in width! You can gain some additional insight concerning the excellence of this recorder by checking out the rest of our test results in the VITAL STATISTICS chart, but to fully appreciate the TASCAM ATR-60-2T you ought to treat yourself to a hands-on session with one.

VITAL STATISTICS

MAKE & MODEL: TASCAM ATR-60-2T 2-Track Recorder/Reproducer

SPECIFICATION	MFR'S CLAIM	db MEASURED
Frequency Response (Rec/Play)		
15 ips (-2dB, re:0dB level)	30 Hz-22 kHz	20 Hz - 30 kHz
7.5ips (-2dB, re:-10dB level)	30 Hz-20 kHz	20 Hz - 23 kHz
THD @ 0 dB level		
15 ips	0.6%	0.51%
7.5 ips	N/A	0.35%
Level for 3% THD, 15 ips	+13 dB	+14 dB
S/N Ratio (re: 3% THD Level)		
15 ips (A-Wt'd/Unwt'd)	72/67 dB	73.5/68.5 dB
7.5 ips (A-Wt'd/Unwt'd)	72/67 dB	75.2/70.7 dB
Wow-and-Flutter (Unwt'd/Wt'd)		
15 ips	0.12/0.08%	0.087/0.043%
7.5 ips	0.14/0.09%	0.16/0.08%
Pitch Control Range	+ -15%	+ -16%
Line Input Impedance	10K ohms	Confirmed Maximum
Input/Output Level	+28 dBm	+28 dBm Headphone Output
Level (8 ohms)	Max: 100 mW	115 mW
Bias Frequency	150 kHz	Confirmed
0 VU Reference Level	250 nWb/m	Confirmed
Fast Wind Time (2400 ft. tape)	130 sec.	126 sec.
Spooling Time (2400 ft. tape)	370 seconds	360 seconds
Speed Accuracy	+0.3%	Confirmed
Power Consumption	110 W	108 W
Overall Dimensions (Inches)		
Transport	19 W (21-7/16 including mounted 10-1/2 inch reels) x 20-3/8 H x 12-3/16	
Amplifier Module	19 W x 4-1/8 H x 10-11/16 D (including front knobs and rear protrusions)	
Net Weight		
Transport	83.75 lbs. (38 kg)	
Amplifier Module	16.56 lbs. (7.5 kg)	
Price:	\$5995.00	

Circle 40 on Reader Service Card

Making SMPTE Work For You

If you have thought that you knew much about the use of SMPTE time code for television, read on, and learn more

As all informed music people know, SMPTE (Society of Motion Picture and Television Engineers) time code and MIDI (Musical Instrument Digital Interface) are the buzz words of the 80's. SMPTE time code was developed by NASA to be used as a standard clock reference in the space program and the rest is history.

Everybody is into SMPTE these days. Roland, Yamaha, E-mu, NED, Akai, and even the Dr. Click people. However, SMPTE's promise is not really being kept by the musical instrument manufacturers and in this article we'll discuss what SMPTE or "Smart Sync" can and can't do for you.

SMPTE serves one of its most important functions as a method of identifying frames on video tape. Remember that video tape has no sprocket holes and no edge codes. SMPTE time code serves as both invisible sprocket holes and frame address code. By using SMPTE, a video-tape editor can control his sound and video editing with sub-frame accuracy.

If this does not impress you, it should. It has taken years of technical development to make the 30 fps SMPTE standard a desired addition to the editors toolbox.

WHEN 30 FPS ISN'T 30 FPS

It is extremely important to understand how SMPTE relates to the video tape, so bear with me. Most modern video recorders use a helical scan technology to read the information off of the video tape. The signal is recorded and played back by a rotating drum-mounted record/playback head which places the signal diagonally onto tape. This enables the video recorder to get maximum use of the available video-tape width.

A basic problem of helical scan technology is getting the video-tape head to know where the diagonal signals (frames) are placed on the video tape. The internal syncing of the moving tape and the rotating video head is accomplished by printing a control track onto the video tape to insure that the tape and head are at the right place at the right time. This produces the 30

Shelton Leigh Palmer operates his own studio, complete with a Synclavier. Located in New York City, he is heavily into post-production work for the commercial industry

frame per second time base for which SMPTE time code is famous. It keeps the world in sync and safe for democracy. Still with me?

The first use of SMPTE time code in music production was syncing up a multi-track audio tape machine to a video-tape machine and performing music or sfx right to picture. This could be done either with or without the help of startmarks and click tracks.

But there was more. Recognizing the usefulness of SMPTE time code, many musical-instrument manufacturers have come out with devices which purport to read and generate SMPTE time code as an alternative to the FSK or TTL sync they shoved down our throats a few years ago. The promise of SMPTE is "Smart Sync," a sync track that knows where it is at all times. That is a universal code for console automation, video and audio tape machine synchronization and the generation of proper sync pulses for sequencers and drum machines.

I'm all for "Smart Sync." After all, it will reduce rewind time, cue-location time and solve all kinds of production and editing nightmares. Properly patched, it could even shine your shoes.

Unfortunately, the music industry forgot an important fact - SMPTE time code that does not relate to a control track or a perfectly generated black-burst signal is as arbitrary as an FSK sync pulse. It can cause more problems than it can solve. You will have the illusion of frame accurate sync, only to find the audio and video won't lock up at the layback. What's a mother to do?

A simple but expensive solution to this dilemma is to use a professional SMPTE time code generator to generate your code. These generators accept composite video or black burst for sync. They may also be used with "washed" power as "house code" generators. (When 30 fps is really 30 fps).

So what about your SSL Console, SBX-80, SRC, SMPL System, Master Beat, etc.? You can use the time code generators in these devices, but you run the risk of your tapes not being outworld sync-able.

Outworld compatibility may mean very little to people who use SMPTE for console automation or the practical use of a device like the SBX-80. If you are not locking to picture, outworld compatibility may not matter. Caveat emptor, "Let the buyer beware," is truer than

Figure 1. Different video-tape formats

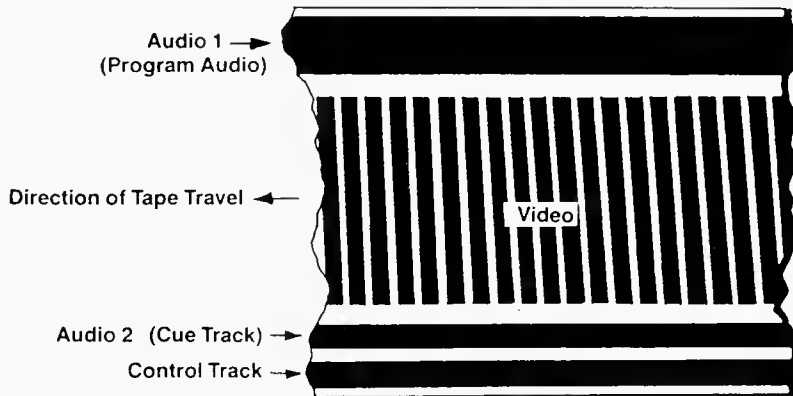

2" Quadruplex Videotape Recording Format

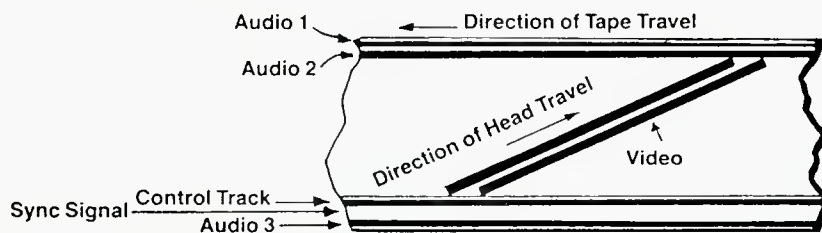

1" Type C Helical Videotape Recording Format

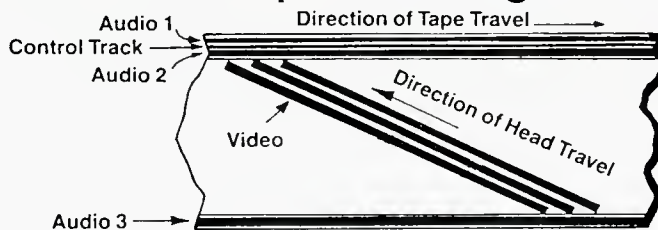

1" Type B Helical Videotape Recording Format

ever when it comes to the promise of SMPTE time code for commercial music-production applications.

RECORDING WITH SMPTE TIME CODE

There are some precautions you can take to head off compatibility problems.

The first best thing you can do is to have all of your elements "stripped" at the same time directly from the video master. This can be accomplished by feeding time code from the video master into a SMPTE reader/generator in jam sync mode and regenerating the exact same SMPTE timecode numbers onto all of your elements.

In this case, elements refer to 2-inch multi-track audio tape, 1/2-inch 4-track, 1/4-inch 2-track, 3/4-inch video workprint and the address track of your F-1 or 1630 digital audio on video master. Note: Since address track audio can only be recorded in Video Record Mode print "Black" on the video and master in video insert edit mode. It is important to remember to place all slaved audio machines back to "internal" reference position or "house-sync" position before recording time code. Otherwise the tape speed may not be correct.

This method guarantees that your SMPTE is real across the board. Whether you are using drop or non-drop SMPTE, all of your automation, synths and synchronizers will be happiest in this mode.

It is inadvisable to print SMPTE time code from your musical instruments for this purpose. If the program length is over 30 seconds, you run the risk of being out of sync by the end of your program.

If you are lucky enough to be able to keep your entire production in-house, nothing in this article should affect you. However, if you plan to layback your audio program to video at an outside video house, your SMPTE must be real.

Soon the music industry will start to pay attention to the video industry. Sequencers are starting to be manufactured with SMPTE capability, and a SMPTE-based MIDI song pointer is not far away. I expect to see "external sync" BNC inputs on the back of professional musical instruments and sequencers by the end of the year. In the meantime, remember my favorite cliché, "The key to great post-production is great pre-production." ■

Construction Project: Build a -10 to +4 Interface

JON GAINES

The thorny problem of interfacing “semi-pro” and “professional” equipment hasn’t gone away. In fact, the two disparate standards become more entrenched every year. Although the distinction between the two camps is increasingly blurred (you wouldn’t call the performance of a CD player “semi-pro”, would you?), the accepted operating levels have remained fixed for some time. For the studio engineer or broadcaster, this means continually having to find a means of hooking two pieces of gear up in such a way as to preserve optimum audio performance. Let’s look at some of the problems.

A typical piece of consumer or semi-pro equipment has a line level output of around -10 dBV, or roughly 0.3V, though some are at -15 or even -20 dBV. In addition, these outputs often have a high source impedance of between 10 and 50K ohms, and are always unbalanced. The most popular connector in this format is the phono (RCA) jack.

Professional equipment, on the other hand, often has balanced inputs and outputs operating at 0 dBV, +4, or even +8. In contemporary equipment, a high impedance, bridging input is the accepted standard, while output impedance is ideally as low as possible, with 100 to 1K ohms being typical. Popular connectors for balanced operation include 3 pin XLR or D3M styles and 1/4-inch Tip Ring Sleeve phone jacks.

Figure 1. Schematics for OA-1 Balanced Output Interface and associated Power Supply

Now, you can hook any piece of equipment to any other without regard to the above considerations and usually get some kind of sound to come out the other end. So what’s the problem? The biggest one is simply a

matter of practicality and convenience; consumer gear usually doesn’t put out enough level to sufficiently drive your console or other equipment. This means that you won’t be operating your faders in a comfortable range and/or you’ll have to boost the gain somewhere else on the input module or output bus, any of which may compromise final signal to noise performance of your system. In most cases we’re talking about a 24 dB discrepancy between that cassette deck and your console input, and the gain has to come from somewhere.

Secondly, the high impedance output of a semi-pro product just isn’t suitable for practical studio use. There are two reasons. When the high impedance output of one piece of equipment is connected to another unit with the same impedance or lower, i.e. 10K connected to 10K, the second unit will “load down” the source unit by at least 6 dB, and much more if the load unit has an input impedance of 600 ohms. Also, if the source impedance is high, then cable length and capacitance become critical factors; you simply can’t run an output around the control room without seriously compromising high frequency performance.

Finally, there is the knotty problem of interfacing the unbalanced output to a balanced input. One circuit uses two wires and the other calls for three. Hmmm...

The circuit presented here addresses all of these common interface problems and is a universal solution for the studio engineer. It accepts the output of any un-

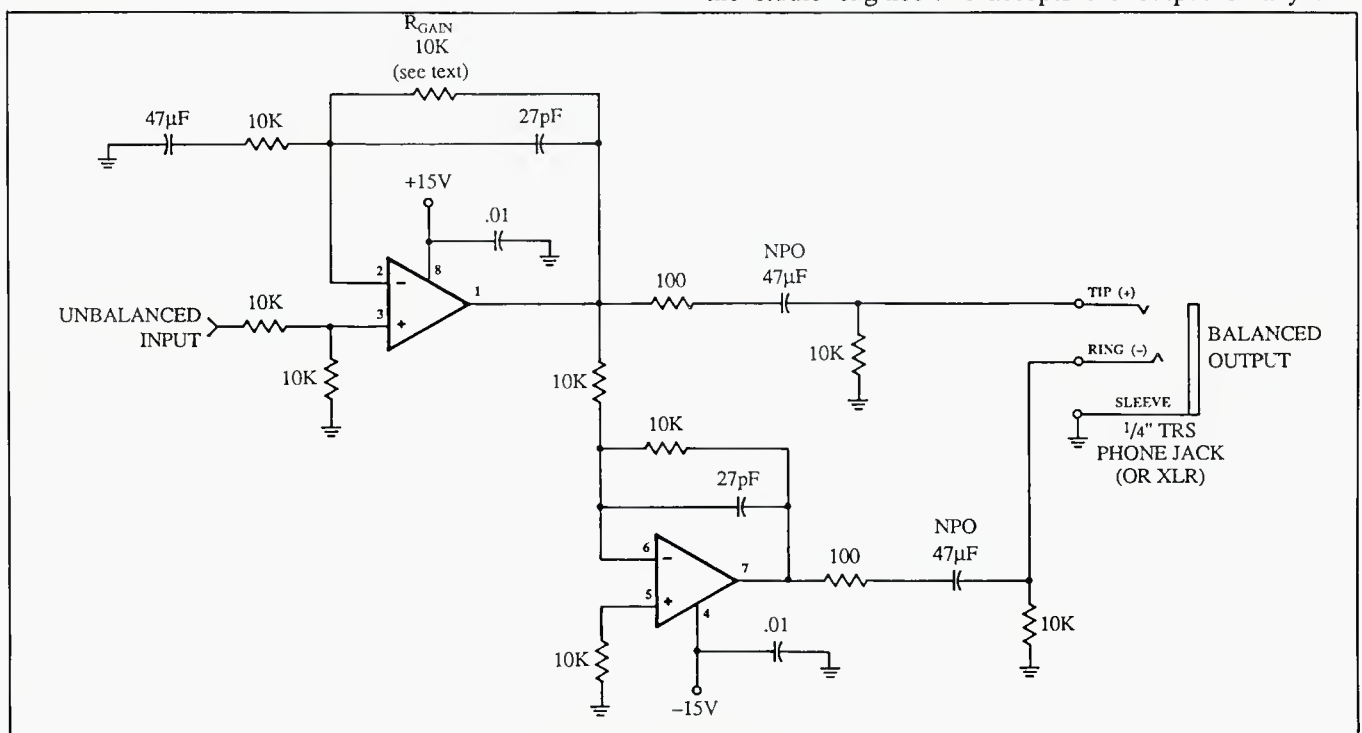

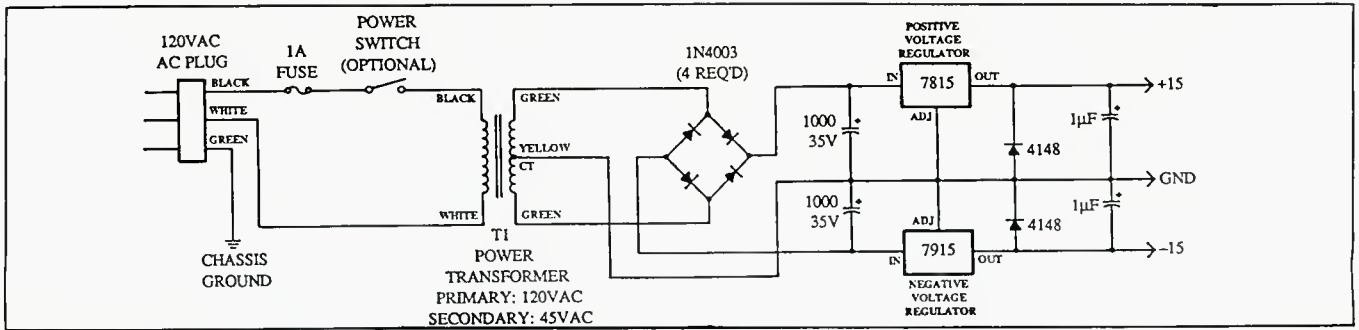

Figure 2. The power supply schematic

balanced piece of equipment, either high or low impedance, and converts it to a balanced low impedance output. Gain may be altered by changing one resistor value, so units with -10 or -20 outputs easily become +4 outputs. The circuit is AC coupled, insuring that DC accidentally applied at the input can never reach the output. As a bonus, this circuit improves the output stability of most equipment, serving as a buffer between the equipment and the unpredictable load conditions of the outside world, including capacitive and reactive loads and short circuits.

The OA-1 Output Amplifier is constructed with commonly available parts obtainable from many sources. It requires a dual polarity power supply, optimally +/-15V DC. In many retrofit applications, you can "borrow" the power supply from the equipment to which it is being connected, although for stand-alone use you will need to build or buy one. This project includes its own power supply as a separate module and its schematic is shown along with the OA-1 in Figure 1 and 2.

Note that the design of the OA-1 is an active, transformerless one, eliminating all of the problems of matching transformers including distortion, noise, susceptibility to external magnetic fields, high cost, and the need to closely match impedances. On the other hand, an active design such as this does sacrifice one of the advantages of transformers, namely a floating output. A transformer will not suffer if one of its output lines is shorted to ground, and indeed its output level will remain unchanged. The active design shown here will lose 6 dB of output level if one of its lines is accidentally shorted, though no other damage will occur. All in all, the active approach is the method of choice in all current equipment designs.

Use this project wherever you need to interface the low level output of one piece of gear with the input requirements of professional equipment: cassette decks, phono preamps, tuners, CD players, PCM converters,

Figure 3. The interior view of the completed project

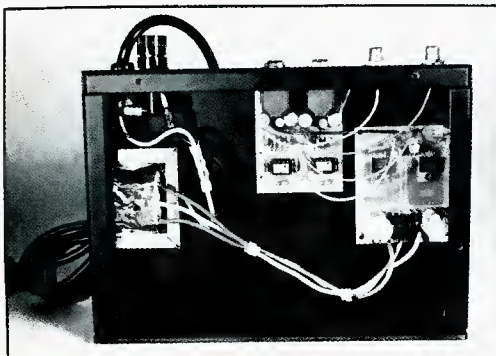

VCR audio outputs, musician's effects and "foot-pedal" devices, and even DAT recorders (if they ever get here!).

CIRCUIT DESCRIPTION

The OA-1 consists of two op-amps, one being used in the inverting mode and the other non-inverting. Gain is set with a single resistor in the feedback loop of the first op-amp. If desired, R-gain may be in the form of a variable resistor or trim pot so that gain may be tweaked after installation. Both op-amps have series resistors on the outputs to provide some isolation from outside loads, followed by AC coupling capacitors which should preferably be non-polarized types. These caps can be eliminated if you like, but you run the risk of passing DC errors at the output. Also, the single polarized electrolytic capacitor at the inverting op-amp prevents DC errors at the input from being amplified by the OA-1.

The performance of the OA-1 is determined primarily by the quality of the op-amps used, and you have several good options. For my layout, I chose a TL 072 Dual Bi-Fet, but you might also use an NE5532, RC4558, or RC2043, all of which are pin for pin compatible with the layout given here. Be sure to use a socket for the IC so that you can substitute different IC's as you like. Typical specifications for this circuit include a frequency response of 5Hz to 30KHz, THD of .01%, slew rate of 9V/uSec., and noise of better than -95 dBV. Current requirements for the OA-1 with a TL 072 installed are around 8 mA DC quiescent rising to around 35 mA when the circuit is operating at full output into a moderately low impedance load. Output impedance is 200 ohms, though you should not load it with less than 600 ohms.

The power supply suggested is a common dual regulated supply using popular and readily available 3-terminal voltage regulators. The power transformer is followed by a full wave bridge rectifier smoothed by two 1,000 microfarad capacitors which then feed the regulators. Two 1 Mfd. caps enhance the stability of the regulators, and two 1N4148 diodes prevent latch-up and reverse voltage damage. I have chosen to omit a power switch on my unit since it's the kind of box that often

Figure 4. View of the completed project.



gets tucked out of the way and forgotten, but you may use a switch if desired. Insert it in series with the HOT side of the power line between the fuse holder and the power transformer primary.

A WORD ABOUT SAFETY

With the exception of the AC wiring ahead of the power transformer, this is a relatively harmless project with everything after the transformer secondary being low voltage at low current. Be sure to observe good safety practices when working with the AC line: 1) Always use a 3 wire grounded line cord with the ground connected to the enclosure. 2) Always use an AC line fuse, and *never* substitute a higher value fuse if the correct one blows! 3) Properly insulate any exposed AC wiring with shrink tubing, wire nuts, electrical tape, etc. 4) Make sure you know what's in contact with what before plugging in the AC line cord.

If you're not sure you know what you're doing around the 120V AC line, STOP and get the assistance of someone who does.

ASSEMBLING THE OA-1

Building this project is as easy as plugging the appropriate components into the circuit board. If you're not using the supplied circuit board, a piece of perf-board will work fine. Keep the layout compact and tidy to insure optimum performance. External wiring consists of just an audio input and ground, taken from the unit's input connector which will typically be an RCA connector. Then hook up the +15, -15, and ground from the power supply module, and you're ready to use the OA-1. The balanced output is taken from the 1/4-inch phone jack mounted directly on the OA-1 circuit board. If you like, you may duplicate or substitute for this connector with an XLR, barrier strip, or whatever connector you prefer.

GAIN SETTING RESISTOR, R-gain

Select a resistor to give you the amount of gain you require. Use either a 10K resistor for 6 dB of gain, 39K for 14 dB of gain, or 100K for approximately 24 dB of gain. Common 1/4 watt, 5% tolerance carbon film resistors may be used with good result.

POWER SUPPLY ASSEMBLY

The power supply section may also be assembled on perf-board or on the supplied printed circuit board. Be extra careful to get the polarity of the large electrolytic capacitors right, as well as the diodes. No heat sinking is required for the voltage regulators since they are working into such a minimal load in this project. However, if you are going to power many OA-1's with the same supply, you may want to add some heat sinking.

AC LINE WIRING

Use a 3 wire grounded AC cord and connect the green ground wire to the metal enclosure of the project. Connect the white (neutral) wire of the line cord directly to the white wire of the power transformer primary. Connect the remaining black (HOT) wire of the line cord to one terminal of the fuse holder, connecting the remaining terminal of the fuse holder to the remaining black wire on the power transformer primary. If you want to use a power switch, insert it in the line between the fuse holder and the transformer primary wire (see schematic).

The power transformer secondary wires connect to the printed circuit board at the points marked "SEC" and "CT." The Yellow wire is the Center Tap (CT) and the

two Green wires are the transformer Secondary (SEC). Either green wire may be connected to either Secondary (SEC) pad on the circuit board.

PACKAGING

Put the OA-1 inside any enclosure you have handy, or use the one supplied with the kit. Metal is preferred, although the circuit is relatively immune to RF and other noise.

PARTS LIST

OA-1 (each channel; multiply x2 for stereo pair shown)

Resistors:

9 10K ohm, 5% carbon film

2 100 ohm, " " "

Capacitors:

2 0.01 mfd. ceramic discs, 50V

2 27 pfd. " " "

2 47 mfd. electrolytic, non-polarized if available

1 47 mfd. electrolytic, 10V

Other:

Printed Circuit Board

8 pin DIP socket

Dual op-amp

phone jack

phono jack

chassis

Power Supply Section: (one needed)

Power Transformer, 120 VAC primary, 45VAC secondary

AC line cord, grounded

Printed Circuit Board

LM 7815 Positive Voltage Regulator

LM 7915 Negative Voltage Regulator

4 1N4003 Rectifier Diodes, silicon

2 1N4148 silicon diodes

2 1,000 mfd. electrolytic capacitors, 35V

2 1 or 1.5 mfd. electrolytic capacitors, 50V

Fuse holder

1/2 Amp fuse

wire nut, miscellaneous hardware

Switch (Optional)

KIT AVAILABILITY

The following parts, kits, and assembled units are available from Gaines Audio, 1237 E. Main St., Rochester, NY 14609 (716) 266-0780:

OA-1 Printed Circuit Board Only: \$5 single channel or \$8.50 per stereo pair, postage paid.

LD-2 Complete Kit, including all parts shown (power supply, stereo OA-1, chassis, etc.) \$74.50 plus \$2.50 shipping.

LD-2 Interface Assembled and Tested, as shown: \$96.50 plus \$2.50 shipping.

VISA, MC, money orders accepted. Personal checks must clear prior to shipping.

COD's add \$1.90 per order. All products are sold with a 30 day return privilege. NY residents please add 7% sales tax. ■

New Products

TAPE REELS

A new professional quality 10-1/2-inch reel with 3-inch NAB center for use with 1/2-inch tape has been introduced by Polyline Corporation, a long-established manufacturer of empty reels and stock packaging materials for audio and video tape, and a leading catalog distributor of blank tape for professional audio and video tape users. Manufactured of semi-transparent "smokey" brown plastic, the reel features a 3-in. NAB center, and may be ordered with or without a hinged white box. The new 10-1/2-inch reel expands the product line offered in the Polyline catalog of professional sound recording and duplicating supplies. Also offered are: 7-inch reels for 1/2-in. tape, 10-1/2-in., 7-in., 5-in., 4-in., and 3-in. reels for 1/4-in. tape, and 10-1/2-in. metal flange reels with NAB centers for 1/4-in. and 1/2-in. tape. Reels for 1-in. and 2-in. tape are also offered.

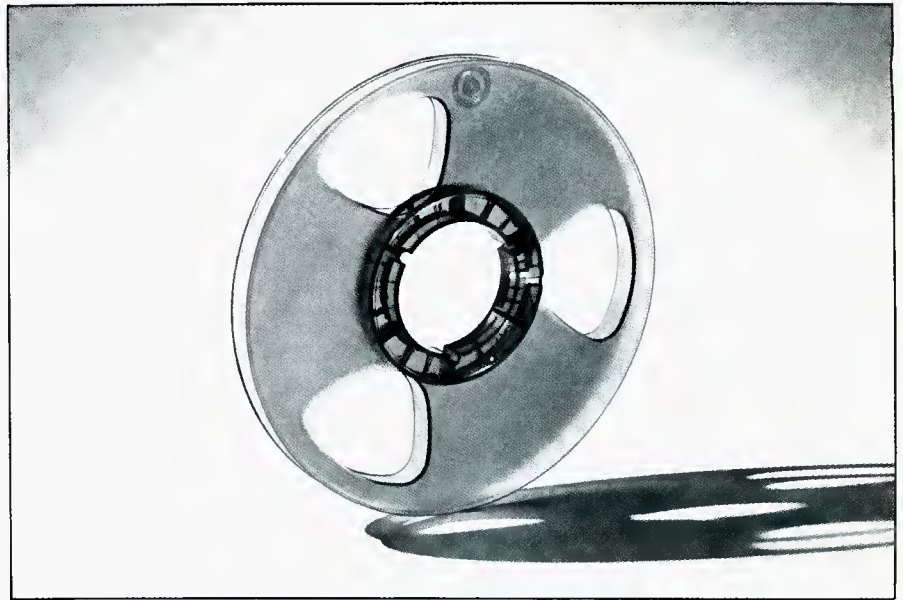

Mfr.- Polyline
Price- With boxes: 1-5 std. pk.(20 per pk.) \$2.82 per reel
over 48 \$1.86 per reel

Without boxes: 1-5 std. pk.(15 per pk.) \$1.53 per reel
over 48 std. pk. \$1.01 per reel
Circle 63 on Reader Service Card

8-CHANNEL DIGITAL RECORDER

Mitsubishi Pro Audio Group has announced the addition of the new X-400 8-channel digital audio recorder to its line of digital audio products. The X-400/8 utilizes the Prodigy (PD) format, the leading digital standard for professional audio recorders. The X-400/8 provides a total of 14 tracks on 1/2 inch tape. In addition to the 8 digital channels, there are two digital tracks for error correction coding, two analog cue tracks, one digital auxiliary track and one time code track. It is fully compatible with the 16-channel X-400, allowing tapes recorded on the X-400/8 to be played back on the X-400/16. The X-400/8 features the RS-422/RS-232 serial interface for use with external equipment such as VTR's and will accept inputs on 9.6 or 8 kHz clock rates. In addition to internally generated SMPTE time code (drop frame or non-drop frame), the X-400/8 offers full compatibility with NTSC, PAL, and SECAM television standards, providing maximum production flexibility.



Mfr.- Mitsubishi Pro Audio Group
Price- \$59,000.00

Circle 60 on Reader Service Card

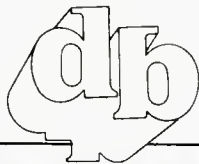

BUSINESS REPLY CARD

FIRST CLASS PERMIT No. 47, DEER PARK, NY

MARDATA
P.O. Box III
Deer Park, NY 11729



NO POSTAGE
NECESSARY
IF MAILED
IN THE
UNITED STATES

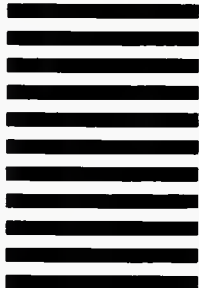

BUSINESS REPLY CARD

First Class Permit No. 1043, Hicksville, New York

Postage will be paid by addressee

Mail to: **The Sound Engineering Magazine**
Sagamore Publishing Co.
1120 Old Country Road
Plainview, New York 11803



NO POSTAGE
NECESSARY
IF MAILED
IN THE
UNITED STATES



BUSINESS REPLY CARD

First Class Permit No. 1043, Hicksville, New York

Postage will be paid by addressee

Mail to: **The Sound Engineering Magazine**
Sagamore Publishing Co.
1120 Old Country Road
Plainview, New York 11803



NO POSTAGE
NECESSARY
IF MAILED
IN THE
UNITED STATES

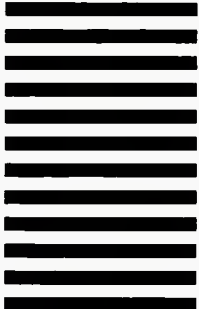

Classified

FOR SALE

BELDEN FLAT SNAKE CABLE

16 or 20 pairs Belden 8451 bonded in durable black jacket on 205 ft. original factory spools. Perfect for snakes, studio installations, OEMs. Superior to round cable at **HALF THE PRICE!**

16 pr.- \$1.20/ft. 20 pr.- \$1.50/ft.
Quantity pricing available
Call 301-949-1298 24 hours.

INCOMPATIBILITY? Inexpensively convert consumer equipment to professional, balanced inputs and outputs with 40 db level adjustment range and 600 ohm drive capability. For instructions, schematics and parts lists, send \$4.95 to **MRH AUDIO CONCEPTS, P.O. Box 339, Fox Lake, IL 60020.**

WATCH THIS SPOT!

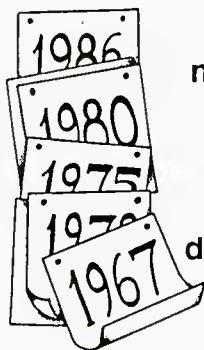

Beginning
next issue,
a culmative
index of
db Magazine
will

be available, from
the year 1967 to 1975,
and from 1976 to 1985.

Studio Forms

Get box labels, track sheets, invoices, etc., printed with your studio's name & address! **FREE Catalog** of specialized forms for the recording industry.

StudioForms, Inc.

186 Glen Cove Ave. Suite 201/ db 5
Glen Cove, NY 11542 *516-671-1047

USED PROFESSIONAL RECORDING EQUIPMENT: BUY, SELL, TRADE.

DAN ALEXANDER AUDIO (415) 474-1625 OR (213) 660-5719.

FREE 32pg Catalog & 50 Audio/Video Applic.

PWR SUPP. EQ.
PHONO, MIC,
TRANS, ACM,
TAPE, VIDEO,
LINE, OSC.

Stereo/Mono Pwr Ampl. 8-in/2-out, 12-in/4-out, 16-in/4-out

Video & Audio Dist Amps. TV Audio & Recd Prod Consoles

OPAMP LABS INC (213) 934-3566
1033 N Sycamore Av LOS ANGELES CA, 90038

AMPEX ATR 104 (1981). Very clean, used in home studio. Remote Control, two-track 1/4-in heads and guides, two-track 1/2-in heads and padnets, cue amplifier, extra set of transport cards, many spares. \$15,000.00. **Write to Box SH, db Magazine, 1120 Old Country Road, Plainview, NY 11803.**

FOR SALE: working audio studio components. Knabe piano, 8 track and 4 track Scullys, 2 track MCI's, microphones, and outboard audio and video equipment. **Call (212) 333-3621 for complete list.**

FLIGHT CASE FOR AMPEX ATR 100. Holds recorder and accessories. Excellent shape. \$450.00. **Write to Box AB, db Magazine, 1120 Old Country Road, Plainview, NY 11803.**

1/3 Octave
Real Time Analyzer

Real Affordable...*495⁰⁰ Model 728
*595⁰⁰ Model 728M with Memory

Banner (704) 487-7012
P.O. DRAWER 1803 • SHELBY, N.C. 28150

Closing date is the first of the second month preceding the date of issue.

Rates are \$1.00 per word with \$25.00 minimum. Boxed ads are \$40.00 per column inch. db Box Numbers are \$8.50 for wording "Dept xx" plus \$1.50 for postage and handling.

Discounts 3x-15%
6x-30%.

ALL CLASSIFIEDS MUST BE PREPAID.

Send copies to:
db The Sound
Engineering Magazine
1120 Old Country Rd.
Plainview, NY 11803
att: Classified Dept

Buyer's Guide

Tape & Tape Recorders

Cases & Racks; Stands & Booms

On the following pages you will discover detailed information on how to specify and buy raw tape, tape recorders of all types, cases and racks to hold your equipment, and stands and booms on which to place your microphones.

We permit, for space reasons, each manufacturer in each category, only eight products. You can appreciate that some companies do indeed make more, particularly the case companies.

Finally, you may also notice that some companies of which you may know may be missing entirely. We have extensive lists of who makes what, and we do try to get everyone. But, sometimes we miss. And, sometimes, as much as we write and even phone, return material is not forthcoming.

TAPE

AGFA-GEVAERT, INC.

PEM 369 is a 1 mil open reel mastering tape that features high output, low noise, low print through, and long play times.

PEM 469 is a studio mastering tape featuring high output and low noise, wide dynamic range, standard bias, low print through, and good winding characteristics.

PEM 468 is a studio mastering tape with high output, low noise, wide dynamic range, low print through, and batch number and web position printed on the backing for permanent tape identification.

PE 649 is a premium iron oxide, high output, low noise, standard IEC Bias I cassette tape, features extended headroom in both low and high frequencies for the most demanding music duplication.

PE 627/827 are extremely low-noise, pure chromium cassette tapes with IEC bias II, 70 microsecond chrome equalization.

PE 619/819/1219 are low-noise, high-output iron oxide cassettes.

Magnetite 62/92 is a bulk cassette tape with extremely low noise, high output and extended dynamic range. It has improved Magnetite formulation designed for music tape duplication.

PEM 526 is a bin loop tape with high mechanical stability and consistent high frequency reproduction.

AMPEX

Grand Master 456 Studio Mastering tape is an analog mastering tape available in 1/4, 1/2, 1, and 2-inch widths, and 1,200 to 5,000-foot lengths. The base film is nominally 1.5 mil polyester with gamma ferric oxide and high conductivity carbon backcoat.

406 analog audio mastering tape is available in 1/4, 1/2, 1, and 2-inch widths, and 600 to 5,000-foot lengths. Base film is 1.5 mil polyester with gamma ferric oxide and high conductivity carbon backcoat. 407 mastering tape is the same as 406 but the base film is 1 mil thick, and it is available in 900 to 3,600-foot lengths.

467 Digital Mastering tape is available in 1/4, 1/2, and 1-inch widths, and 4,600, 7,200, and 9,700-foot lengths. Base film is 1 mil polyester with a cobalt modified gamma ferric oxide and high conductivity carbon backcoat.

467 digital audio cassettes are U-matic cassettes specifically designed for digital audio PCM applications. The cassettes are available in 30, 60, and 75-minute play lengths. Base film is polyester, with thicknesses of 0.81, 0.75, and 0.57 mils, respectively.

600 Series open reel and duplicator tape has a polyester base film in 0.5, 1, and 1.5 mil thicknesses, and 1/4-inch width. Reel configurations are 600 to 3,600-feet, and 2,500 to 7,200 feet for duplicator tape. It utilizes gamma ferric oxide and is non-backcoated.

615/616 cassette duplicator tape is a Type I tape for C-60 (615), and C-90 (616) duplication. Base film is polyester in 0.45 and 0.26 mil thicknesses, respectively, and 0.15-inch width. Both use ferric oxide coating, non-backcoated.

619/620 cassette duplicator tape is a Type II extended range tape for C-60 (619) and C-90 (620) duplication. Base film is polyester in 0.44 and 0.28 mil thicknesses, respectively, and 0.15-inch width. Both utilize a chromium dioxide coating, non-backcoated.

672 professional audio cassettes are available in 30, 45, 60, and 90 minute play lengths. They are available in packaged or bulk configurations. 615 and 616 tape are used in conjunction with a precision molded cassette shell.

BASF

The LH Extra I cassette tapes utilize high performance ferric tape and are available in C-60 and C-90.

The LH Maxima I cassette tapes utilize high performance tape with enhanced low and high frequency MOL values. It is available in C-60 and C-90.

The Chrome Extra II cassette tapes utilize pure chrome tape with extra low and high frequency sensitivity and MOL, and ultra-low bias and modulation noise. It is available in C-60 and C-90 lengths.

The Chrome Maxima II cassette tapes are high density formulation with enhanced low and high frequency MOL for extra dynamic range. It is available in C-60 and C-90.

The Loop Master 920 open reel tape is chrome mastering tape with back-coated design for high-speed bin mastering use. Dynamic range at 3.75 in./sec. is equal to a ferric master recorded at 7.5 in./sec. It is available in 1/2-inch and 1-inch configurations on 2,400-foot hubs.

MAXELL

The Communicator series cassettes are available in lengths from C-30 to C-120.

The Duplicator series cassettes are available in lengths from C-30 to C-120.

The XL series 1/4-inch open reel tape is back coated and is available in lengths of 1,800-ft. (90 minutes), 2,500-ft. (2 hours) and 3,600-ft. (3 hours).

The XLII series 1/4-inch open reel tape is back coated and is available in 1,800-ft. (7-inch reel) and 3,600-ft. (10.5-inch reel) lengths.

TDK

MA-XG Type IV (metal) audio cassette features a new, three-layer RS-II vibration-dampening mechanism that virtually eliminates sympathetic vibration for reduced modulation noise. Excellent for digital taping applications.

MA-X Type IV tape utilizes a newly developed dual-layer plastic mechanism and improved Finavinx metal tape formulation. Like MA-XG, the formulation offers superior MOL characteristics and a wide dynamic range.

SA High Bias tape is for all Type II recording applications. It features TDK's Laboratory Standard mechanism for reliable tape transportation.

HX-S is the first metal formulation designed for Type II (High Bias) recording. Particularly effective in recording from digitally-sourced materials.

AD-X Type I (Normal Bias) audio cassettes utilize Super Avilyn particles for extra recording headroom and features the Laboratory Standard mechanism for reliable tape transportation.

GX-50 open reel tape is back-coated, 1/4-inch, 1.5 mil, high output, low noise tape available on both 7-inch and 10.5-inch reels. The magnetic material is gamma ferric oxide.

GX-35 open reel is the same as the GX-50, but utilizes 1-mil tape.

SA/EE is a Super Avilyn particle 1/4-inch tape engineered for open reel decks featuring EE (Extra Efficiency) EQ/bias position. Coercivity is almost double that of standard ferric oxide tapes.

3M-(SCOTCH)

The #250 audio mastering tape incorporates a 1.5 mil thick back-coated polyester backing. Delivers high output/low noise performance with the widest possible dynamic range of analog mastering tapes. Ideal for high quality music mastering.

The #226 audio mastering tape has a 1.5 mil thick back-coated polyester backing. Provides high output without distortion and minimal print through. Designed for music mastering.

The #227 audio tape has a 1 mil thick back-coated polyester backing. Has the same performance characteristics as #226 with a longer playing time. Ideal for quality music recording where extended recording/playing time is needed.

The #275 digital audio tape utilizes a 1 mil thick back-coated polyester backing. Designed for high-quality, reliable performance on stationery head digital recorders.

The #806 audio mastering tape has a 1.5 mil thick back-coated polyester backing. Developed to give good compromise in print through and maximum output level characteristics. Best tape for applications where both music and speech are being recorded.

The #807 audio tape incorporates a back-coated base of 1 mil thick polyester. Offers the same performance characteristics as #806 with a longer recording/playing time.

The #808 audio mastering tape has a back-coated polyester base, 1.5 mil thick. Has extremely low print-through characteristics. Ideal for speech, sound effects, and other applications where low print through is required.

The #809 audio tape offers the same performance as #808 but has a 1 mil thick back-coated polyester base to provide longer playing time. Product should be used where a combination of low print through and long recording time is needed.

TAPE ACCESSORIES

POLYLINE CORP.

Leader tapes, splicing tapes, special tapes (hold down, cleaning), demagnetizing aids, dispensers, bulk-erasers, splicing blocks, mylar splicing tabs, metal foil tabs, empty reels (plastic, metal, hubs, all sizes), reel boxes, NAB cartridges, lube tape, demo shipper boxes, cassette boxes, cassette loading supplies, labels, index cards, vinyl albums for audio cassettes, ring binders, cassette trays, calibration tapes, calibration and test cassettes, maintenance supplies, cleaners, developers, compressed air, sound libraries.

Bulk prices available on all products.

TASCAM

Tascam has available empty reels for 1/4-inch and 1/2-inch tape. The 1/4-inch tape reels are 7- and 10.5-inch in size; the 1/2-inch tape reels are 10.5-inch only. All reels have Tascam logo on them. For further information contact Tascam.

XEDIT CORP.

Manufacturers of Editall Pro Splicing Blocks

Professional editing/splicing systems

Blocks and kits- Sizes from 1/8-inch to 2-inch blocks, 3.5, 7.5, 15, 30, 45, 60, 73, and 90-degree countersunk holes, adhesive tape backings, cork backings, Otari replacements, edge-clamping types, flat-trough types, clear access blocks.

Editabs- 1/8-inch to 1-inch mylar, foil sheets.

Accessories- Razor blades, editing markers, magnetic-tape developers, texts on editing, drift and flutter meters. Complete kits including blocks, tabs, cleaners, etc. are available.

1/8-inch blocks: \$30.00 to \$38.50

1/4-inch blocks: \$15.00 to \$45.00

1/2-inch blocks: \$30.00 to \$69.00

1-inch blocks: \$69.00 to \$80.00

2-inch blocks: \$140.00 to 165.00

Edge clamping, flat trough, clear access block-

1/2-inch: \$275.00

1-inch digital single cut: \$300.00

1-inch analog three cut: \$325.00

2-inch analog three cut: \$350.00

ADDRESSES

Tape

Agfa-Gevaert
275 North St.
Teterboro, NJ 07608

Ampex
401 Broadway, MS 22-02
Redwood City, CA 94063

BASF
19 Crosby Dr.
Bedford, MA 01730

Maxell Corp. of America
60 Oxford Dr.
Moonachie, NJ 07074

TDK Electronics Corp.
12 Harbor Park Dr.
Pt. Washington, NY 11050

3M
3M Center
Bldg. 236-1B-06
St. Paul, MN 55144

Tape Accessories

Polyline
1233 Rand Rd.
Des Plaines, IL 60016

Tascam
TEAC Corp. of America
7733 Telegraph Rd.
Montebello, CA 90640

Xedit Corp.
133 South Terrace Ave.
Mount Vernon, NY 10050

TAPE RECORDERS

AKAI PROFESSIONAL

MG14D/ML14 14-track rackmountable recorder has programmable auto location system, multiple event auto punch-in, multiple event playback mute, automatic repeat, defeatable dbx TYPE ONE, 50Hz to 20kHz, S/N 94dB, 115dB dynamic range, absolute time counter, +4dB + -10dB input and outputs, full function auto locator.

Price: \$6999.00

MG614 6-channel 4-track recorder w/sync track has 6 input channels, digital busing to any track, 2-band sweep equalization, 2 effect sends, 2 parallel mono effect returns, defeatable dbx, 30Hz to 18kHz, dual speed 1 7/8 or 3 3/4.

Price: \$1799.00

AMR (Audio Media Research)

The MCR 4 Four-track cassette recorder features heavy-duty rack-mountable steel cabinetry, Dolby B and C, zero stop, zero play, peak-hold level indicators for each channel, touch-activated solenoid driven controls, four digit timer/counter, pitch control, front-panel headphone output with level control and ch. 3-4 mute switch. An optional full-function remote footswitch (FS-3) allows hands-off control for overdubbing, punch-in, punch-out, etc.

Price: \$699.50

The MCR 4/S offers the same features, functions and specs as the MCR 4 but with dual-speed selection and is sync-capable via rear panel sync ports when used with the new AMR SyncController, SMPTE synchronizer/controller.

Price: T.B.A.

FOSTEX

The E-16 is a synchronizer ready, 16-track tape machine with built-in 2 position autolocator, servo control of reels, spot erase, real-time counter, 15 in./sec. tape speed, 10.5-in. reels, and Dolby C noise reduction. Weight is 78 lbs.

Price: \$6,995.00

The E-8 is an 8-track version of the E-16.

Price: \$4,295.00

The E-2 is a 2-track recorder with center track for stripping SMPTE time code. It has built-in 2 position autolocator, servo controls of reels in the edit mode, spot erase, and balanced inputs and outputs.

Price: \$3,600.00

The E-22 is a 2-track recorder with center track for time code. It has built-in 2-position autolocator, servo controls of reels in the edit mode, spot erase, automatic programmable punch in/out, and balanced inputs and outputs.

Price: \$3,900.00

The M-80 is a synchronizer ready 8-track recorder. It utilizes 1/4-inch tape on 7-inch reels, and has a frequency response of 40 Hz-18kHz at 15 in./sec. Dimensions are 14 x 13.5 x 6.75; weight is 29 lbs.

Price: \$1,995.00

The M-20 is a 2-track recorder with center track for time code. It can be used with all synchronizers and most video editors. Tape speed is 15 and 7.5 in./sec. Dimensions are 14 x 13.5 x 8.5; weight is 29 lbs.

Price: \$1,200.00

MITSUBISHI PRO AUDIO GROUP

The X-850 32-Channel Digital Audio Recorder uses 1-inch digital audio tape running at 30 in./sec. Offers full use of 32 digital audio channels, with additional channels for SMPTE time code, analog cue tracks, and two auxiliary digital data tracks. Cut and splice editing. Auto punch-in/punch-out. Error correction capabilities. Offers both the professional 48 kHz sampling frequency and the 44.1 Hz frequency for CDs.

Price: \$187,000.00

The X-400 16-Channel Digital Audio Recorder uses 1/2-inch tape running at 30 in./sec. All 16 tracks are available for digital audio recording at all times. There are four additional tracks available- one for time code, two auxiliary analog tracks, and one auxiliary digital track. Cut and splice editing. Offers both the professional 48 kHz sampling frequency and the 44.1 Hz frequency for CDs. Auto punch-in/punch-out.

Price: \$99,000.00

The X-400 8-Channel Digital Audio Recorder offers the same features and capabilities as the X-400 16-Channel recorder, but with 8-channels. It is expandable to 16-channels.

Price: \$69,000.00

The X-86 2-Channel Digital Audio Recorder has a recording format on 1/4 in. tape and represents an improvement on its predecessor, the X-80, adding more functions and even higher reliability. Eight tracks carry the two channels of digital audio, and four additional sub-tracks are provided for auxiliary, digital, analog cue, and time-code data making 12 tracks in all. The standard model features up to 20 bit quantization, with switchable sampling frequencies of 44.1 kHz for CD mastering and 48 Hz for professional recording.

Price: \$18,900.00

NAKAMICHI

The MR-1 professional cassette deck has three discrete heads, dual capstan, balanced (+4 dB) operating levels, rack mountability, Dolby B and C, and a frequency response of 20Hz-20kHz, +/- 3dB, S/N ratio of 70dB, and less than 0.048% wow and flutter.

Price: \$945.00

The MR-2 professional cassette deck is rack mountable and has variable output levels of -10 to +4, 1/4 in. phone jacks, Dolby B and C, a frequency response of 20Hz-20kHz, +/-3dB, a S/N ratio of 68dB, microprocessor controlled transport, and less than 0.11% wow and flutter.

Price: \$559.00

OTARI CORPORATION

The MX-5050 Mark III/8 is a compact, table-top console recorder with a 1/2-inch, 8-track format. Proprietary microprocessors govern dynamic braking, motion sensing and transport logic. Reel size is 10.5 x 1/2-inches.

Price: \$5,835.00

The MTR-10 and MTR-12 Series II are microprocessor controlled recorders designed for recording studios, audio post production, and broadcast. It is available in 1/4-inch, 2-track; 1/2-inch 2-track; 1/2-inch 4-track; and 1/4-inch, 2-track with time code center track.

Price: For 1/4-inch, 2-track

MTR-10: \$7,295.00

MTR-12: \$7,895.00

The MTR-20 is a microprocessor-controlled analog mastering machine designed for broadcast, recording and post production. It is available in 6 formats, 1/4-inch mono, 1/4-inch 2-track, 1/4-inch 2-track with center channel time code, 1/4-inch stereo, 1/2-inch 2-track, and 1/2-inch 4-track.

Price (1/4-inch 2-track): \$12,650.00

The MX-70 is a 1-inch 8- or 16-track mastering recorder for audio post production and recording. It features microprocessor-controlled, constant-tension transport and noiseless and gapless insert recording capability. Reel size is 10.5 x 1-inch.

Price (For 16-track): \$16,750.00

The MX-5050 BQ-II is a compact, table-top console recorder with a 1/4-inch, 2-track format. It has optimized 3-head design, and transformerless balanced inputs. Reel size is 10.5 x 1/4-inch.

Price: \$3,595.00

The MX-80 is a 2-inch 24- or 32-track mastering tape machine for audio post production and recording. It features microprocessor controlled constant-tension transport, and noiseless, gapless punch-in and punch-out. The record circuitry incorporates Dolby HX-Pro.

Price (32-track): \$34,950.00

The MTR-90-II is a 8 ,16 or 24-track, microprocessor-controlled, pinchrollerless master tape machine available in 1-inch and 2-inch transport configurations. It is designed to easily interface with any video editing system, tape controller or tape synchronizer.

Price (24-track): \$44,950.00

The DTR-900 is a 1-inch, 32-track digital audio tape machine based on the PD recording standard and is available in 1-inch, 32-track or 1-inch, 24-track (expandable to 32-tracks) configurations. Reel size is 14 x 1-inch.

Price: \$189,000.00

ROSS

Ross 4X4 II is a personal portable multi-track recorder. Will record 4-tracks simultaneously, Dolby C, 2-band input equalization, auto zero return, 4 VU meters, equipped with bag, power supply and batteries.

Price: \$599.95

Ross 2X4 is a personal portable multi-track recorder. Will record 2-tracks at a time, 2-band input equalization, comes with bag and power supply. 4VU meters.

Price: \$399.95

SONY PROFESSIONAL AUDIO

PCM-3324- open-reel, DASH-format digital audio recorder providing 24 discrete digital audio tracks, two analog tracks, a separate SMPTE time-code track and intelligent addressable control track. The PCM-3324 uses 1/2-inch tape and provides for razor blade editing as well as advanced electronic editing.

Price: \$114,000.00

PCM-3102/3202/3402, family of open-reel 1/4-inch two-track digital tape recorders with new generation microprocessor controlled transport. 44.1 and 48kHz switchable sampling rates. Digital RAM storage built into the 3402 enables the machine to memorize 12-second audio portions, allowing for flexibility in electronic editing.

Price: 3102- \$17,000.00

3202- \$20,000.00

3402- \$25,000.00

APR-5000 series of 1/4-inch analog two-track recorders including microprocessor control transport and "intelligent" electronics to automate the tedious and time-consuming tape management and machine maintenance chores. Recorders permit remote control via serial and parallel ports and feature rigid die-cast chassis construction.

Price: 5000-1- \$6,800.00

5000-2- \$7,500.00

5000-2H- \$8,500.00

5000-3- \$9,500.00

TC-D5PROII portable cassette recorder for ENG/EFP operates for up to 5.5 hours on two "D" alkaline batteries and includes Dolby noise reduction, dual VU meters with peak level indicator and Sonys exclusive Ferrite-and-Ferrite record/play head. Disc-drive capstan-servo tape transport with cordless motor provides reliable operation.

Price: \$790.00

SOUNDCRAFT

The Soundcraft SCM 760 Series recorders all come in 2-inch format. Features on all versions include: modular headblock interchangeable for 16- to 24-track upgrade, custom transport with heavy-duty DC servo-controlled capstan motor and dual bi-directional spool motors, front-panel alignment, signal level and EQ controls, "Hybrid Dynamics" VU metering optimized for tape, noise-reduction interface, remote punch in/out jack, external voltage or frequency control for varispeed or synchronization, A and B line outputs with multi-way gold connectors and all modular construction.

Price: 2-inch 16-track with basic remote- \$19,750.00

2-inch 16-track with full auto locator- \$21,950.00

2-inch 24-track with basic remote- \$25,250.00

2-inch 24-track with full auto locator- \$27,450.00

The Soundcraft Saturn 24-track multi-track total remote has multi-function 10 memory autolocate with return to zero, local zero and "tail-out" start, varispeed +/- one octave, push-button signal electronics alignment with integral test oscillator, three tape speeds and three equalization curves all memorized, 32-key sequence programmable function keys with edit facility, full control over signal electronics modes with automatic monitoring, record ready and mute defeat, LCD information display, integral adjustable VU meter panel, full-quality reverse-play mode, bias/erase timing defeat for perfect punch-ins.

Price: \$50,000.00 to 54,000.00, depending on options

STUDER REVOX

The B77 MkII is a compact professional recorder with die-cast chassis, 3 heads, servo-controlled capstan motor, vari-speed control, and 2 or 4-track stereo. It is available with any 2 adjacent tape speeds up to 15 in./sec. Dimensions are 18 x 16 x 8; weight is 37.5 lbs.

Price: \$2,250.00

The PR99 MkII is a compact professional recorder with balanced and floating inputs and outputs, microprocessor-controlled real time counter, return to zero autolocate, loop, tape dump, vari-speed and self-sync. Dimensions are 19 x 15.7 x 8; weight is 40 lbs.

Price: \$2,799.00

The A810 is a professional broadcast recorder with microprocessor control of all transport and audio electronic functions. Features include 4 tape speeds, selectable softkey functions, zero locate, digital alignment, and optional center track time code. Dimensions are 18.3 x 19.2 x 8.9; weight is 66 lbs.

Price: \$7,790.00

The A812 is a professional recorder with 12.5-inch reel capacity, 4 tape speeds, thumbwheel shuttle/edit control, choice of 40 user programmable functions, transformerless in/out, optional console, serial remote, and center-track time code.

Price (2-channel version): \$9,950.00

The A80VU MkIV is a multi-channel professional recorder in 4, 8, 16, and 24-channel versions. Features include die-cast chassis, modular electronics, master bias oscillator, servo control of capstan and spooling motors, and optional synchronizer interface.

Price: From \$13,500.00

The A820 is a 2-channel mastering recorder with microprocessor control of all transport and audio electronics parameters. Features include 14-inch reel capacity, 4 tape speeds, programmable function library, and digital setting of alignment parameters.

Price: From \$11,500.00

The A807 is a compact microprocessor-controlled 2-track recorder with digital setting and storage of alignment parameters, programmable operating features, tape shuttle, 3 speeds, RS 232 port, and microphone inputs with phantom powering.

Price: From \$5450.00

The A820-24 is a multi-channel recorder with multiple microprocessor control of all transport, switching, and audio alignment functions. Features include automatic simultaneous set-up of all channels, advanced phase compensation, Dolby HX Pro, and optional integral Dolby SR.

Price (24-track): From \$59,500

TANDBERG

The TCD 910-911 is a 4 motor cassette recorder with built-in oscillators for azimuth, bias and record current alignment, 8-bit microprocessor with 32k EPROM, XLR input/output connectors, and optional RS 232 interface.

TASCAM

The ATR-80 is a 24-track recorder with 2-inch transport, featuring many editing features and extensive interface capabilities.

Price: Not available at press time

The 112 is a rack-mounted professional cassette recorder with cue function in both fastwind modes, Dolby HX-Pro, and Dolby B and C noise-reduction systems.

Price: \$599.00

The 112R is an auto-reverse, rack-mounted professional cassette deck with Super Acculign Rotating Head System, and it is capable of multiple-deck operation via a 16-pin connector.

Price: \$795.00

The ATR-60 Series tape recorders includes the ATR-60-2T with center track time code and coincident head configuration; The ATR-60-4HS and 2HS 30 in./sec., 1/2-inch, 4-track and 2-track recorders; the ATR-60-2N 2-track mastering machine; and the ATR-60-8 1/2-inch, 8-track.

Prices: ATR-60-2T- \$5,995.00
ATR-60-4HS- \$6,995.00
2HS- \$6,495.00
ATR-60-2N- \$4,995.00
ATR-60-8- \$6,995.00

TECHNICS

The RS-1500US, 1506US and 1700 are all quartz-locked, 3 motor drive, "Isolated Loop," open-reel tape decks. The "Isolated Loop" forms a tape loop around an unusually large (34 mm) diameter capstan, isolated by a pair of pinch rollers exerting equal pressure on each side and an even larger diameter reversing roller at the bottom of the loop. This results in an excellent wow and flutter rating of 0.018% WRMS at 15 in./sec. A newly developed IC which works in conjunction with the quartz oscillator in controlling capstan speed, assures strict phase, speed and torque control regardless of changes in load, temperature or power. All 3 models are available with a choice of head assemblies selectable between 1/4-track and 1/2-track recording and playback. The RS 1700 features "Two-Way Forward" continuous or reverse play.

Options include: Leather-covered plywood carrying case, dust cover, wireless remote, cable remote, 19-inch rack brackets, battery adaptor.

Price: RS-1500US- \$1800.00
RS-1506US- \$1800.00
RS 1700- \$2200.00

UHER

The 1200 Report Synchro is a portable open reel, full-track mono tape recorder with pilot track, 7.5 in./sec. speed, 3 heads, 5-inch reel, belt drive, VU meter, 2 mixable mic inputs, and switchable ALC selectable record/playback eq. Dimensions are 11 x 3.5 x 9; weight is 8 lbs.

Price: \$4,819.00

The 6000 Report Universal is a portable open reel 2-track mono tape recorder with 4 speeds, 3 heads, 5-inch reel, solenoid control, belt drive, 1 VU meter, built-in voice activation system, memory pulse facility, and full remote control. Dimensions are 11 x 3.5 x 9; weight is 8 lbs.

Price: \$1,729.00

The CR 160AV is a portable cassette, 4-track stereo tape recorder. It has 2 heads, 2 VU meters, Dolby B and C, switchable ALC, sync dubbing outlet, LED function indicator, and solenoid control. Dimensions are 9 x 2 x 7; weight is 7 lbs.

Price: \$899.00

The CR 1601 Monitor is a portable cassette, 4-track mono tape recorder with 3 speeds, 3 heads, VU meter, switchable ALC, solenoid control, full remote control and built-in voice activation system. Dimensions are 9 x 2 x 7; weight is 7 lbs.

Price: \$1,729.00

The 4000 Report Monitor AV is a portable open reel, 2-track mono tape recorder with 4 speeds, 3 heads, 5-inch reel, belt drive, 1 VU meter, and switchable ALC. Dimensions are 11 x 3.5 x 9; weight is 8 lbs.

Price: \$1,449.00

The 4200 Report Monitor is a portable open reel, 4-track stereo tape recorder with 4 speeds, 3 heads, 5-inch reel, belt drive, and 2 VU meters. Dimensions are 11 x 3.5 x 9; weight is 8 lbs.

Price: \$1,549.00

The 4400 Report Monitor is a portable open reel, 4-track stereo tape recorder with 4 speeds, 3 heads, 5-inch reel, belt drive, 2 VU meters, LED function indicators, switchable ALC. Dimensions are 11 x 3.5 x 9; weight is 8 lbs.

Price: \$1,549.00

ADDRESSES

Tape Recorders

Nakamichi, USA Corp.
19701 S. Vermont Ave.
Torrance, CA 90502

Studer Revox
1425 Elm Hill Pike
Nashville, TN 37210

Akai Professional
1316 E. Lancaster
Ft. Worth, TX 76116

Otari Corp.
2 Davis Dr.
Belmont, CA 94002

Tandberg of America
Labriola Ct.
Armonk, NY 10504

AMR (Audio Media Research)
Route 2, Highway 503
Decatur, MS 39327

Ross
1316 E. Lancaster
Ft. Worth, TX 76116

Tascam
TEAC Corp. of America
7733 Telegraph Rd.
Montebello, CA 90640

Fostex
15431 Blackburn Ave.
Norwalk, CA 90650

SONY Professional Audio
1600 Queen Anne Rd.
Teaneck, NJ 07666

Technics
Panasonic Company
One Panasonic Way
Secaucus, NJ 07094

Mitsubishi Pro Audio Group
225 Parkside Dr.
San Fernando, CA 91340

Soundcraft USA
8500 Balboa Blvd.
Northridge, CA 91329

Uher of America
7067 Vineland Ave.
N. Hollywood, CA 91605

NUTS AND BOLTS

(Buying Guide: Cases, Racks, Stands and Booms)

CASES AND RACKS

ANVIL CASES, INC.

A.T.A.- Conforms to Airline Transport Specifications

- Construction:
- 1) side walls- laminated plywood
 - 2) aluminum framework and edging
 - 3) split-steel rivets throughout
 - 4) choice of top sheets- ABS plastic, aluminum, glass fiber.

E.I.A.- Basic ATA type plywood, aluminum, ABS construction for electronic rackmount equipment available in clamp-on, pullover and shockmount designs.

Accessories- locking devices, valence-spanning twist latches, casters (light and heavy).

Options- stacking corners, environmental protection.

CALZONE CASE CO.

Escort- ball corners, high-density Poly Foam, recessed/flush spring-loaded handles, interlocking double-angle 1/4 in. or 1/2 in. subframe structure, 0.093 gauge-interlocking valence, full-length piano hinge, industrial-grade ABS.

Pro Line II- full-length piano hinge, Poly Ether Foam, spring-loaded handle, recessed spring-loaded catch, interlocking valence, internally riveted, Poly Toluene laminate on 1/4 in. plywood (gray or black).

Convoy- nickel-plated butt hinge, nickel-plated flat corners, attache-type catch with lock, molded handle, 1/8 in. extruded valence, foam lined.

Options- casters, locks, colors, glass-fiber laminates, locking catches, 1/8 in. ABS formed shoulder strap.

FLIGHT FORM CASES INC.

Flight Form- ABS bonded to plywood, interlocking slotted panels, rivetless extruded aluminum tracking, steel endcaps, steel hasps, recessed spring-loaded handles, cam locks (on hinged cases), polyester foam, all colors.

Flight Light- slimline, vinyl-bonded plywood, rivetless plastic extrusions sealed with steel endcaps, 1/2 in. polyester foam, padded handles, key-locking drawbolts, aluminum tongue-in-groove lid, rustproof piano hinge, all colors.

FOUR DESIGNS CO.

Rackrate- milk-crate type construction, threaded mounting rails, padded handles, steel reinforced, guaranteed not to crack, chip or dent, up to 6 spaces, 11.5 in. deep, 19 in. standard width.

FX Rack- 18 spaces, furniture-type construction, all wood and laminate materials, vinyl covering.

JAN-AL INNERPRIZES

Rhino- ATA type, recessed hardware, 1/4 in., 3/8 in., 1/2 in. plys available, all types of laminates, all colors, all options (casters, vulcanizing, latches, locks, pullover designs).

Pro Rack- assembles/disassembles, 7, 13, 20 spaces, 18 in. deep, 3/4 in. multi-ply hardwood, water-resistant finish, 400 lb. load capacity, handles with formed grip, steel-rack rail, options include: rear-rack rail, ATA type with casters.

JOE'S SOUND and SALAMI CO.

Stack-Rack- solid baltic birch, stacking corners, natural and black finishes (linseed oil or pebble finish), 4 spaces and up, recessed sessions handles and stack-lock corners, covers held in place by super-velcro system, low cost, extremely rigid (no flex), with or without covers. \$82.50 and up.

PARSONS MANUFACTURING CORP.

MW style- ABS laminated to wood with double-metal edging and steel corners, ATA specifications with all hardware recessed.

M style- The lighter version of the MW with extra-thick ABS instead of wood laminate, reducing weight by 0.20%.

MV style- a lighter version of the M style has lighter hardware and closures.

MRA style- The rack-mounting equipment case, with or without wood laminate. Shock mounting as required.

MU style- The lightest, most economical case with metal corners.

MST style- A universal telescoping case with straps allowing a variable depth for packaging of display photos, signs, etc.

RT style- Built-in wheels, push/pull handles, foam lined, impact construction design.

Case Carts- Collapsible, tubular design, hand-truck styles, two and four wheel versions with bungi cords.

ROADRUNNER CASES, INC.

Heavy-Duty ATA Case- ATA specifications 300, category 1. All seams glued and stapled, top-quality glass fiber (no ABS), one piece valence (lid to body closure), solid-steel split rivets, plastic caps to cover the raw edges of plywood partitions, stacking corners, American-made Douglas fir plywood.

SOUNDOLIER

Select Series- upright racks (all sizes), sloped front consoles (all sizes), sloped front turrets, wedge racks, beige and royal blue.

Standard Series- wall-mount and desk-top cabinets, multi-cabinet system (allows for expansion), beige and royal blue.

Accessories- solid panels, vented panels, trims, drawers, doors, casters, dollies, meter panels, power-strip panels, shelves, 13 optional colors.

STARCASE MANUFACTURING CO.INC.

Carry Star- 1/8 in. ply sidewall plus glass-fiber laminate

ATA Star- 1/4 in. ply sidewall plus glass-fiber laminate, meets all ATA specification 300 category 1 requirements.

Super Star- 1/4 in. ply sidewall plus glass fiber, anodized aluminum, very deep tongue and groove for extra-positive closure, heavy-duty hinge and corners.

Ultra Star- 1/2 in. plywood sidewall plus glass fiber (same as Super Star) with thickest sidewalls for the heaviest items.

All cases: tapered valence clamps, steel-ball corners, mating-rack lids (racks only), recessed latches, locking aluminum valence, 11 colors.

Options- custom nameplates, casters.

ADDRESSES

Cases and Racks

Anvil Cases
4128 Temple City Blvd.
Rosemead, CA 91770

Calzone Case Co.
225 Black Rock Ave.
Bridgeport, CT 06605

Flight Form Cases, Inc.
13102 Stone Ave. N.
Seattle, WA 98133

Four Designs Co.
6531 Gross Ave.
Canoga Park, CA 91307

Jan-Al Innerprizes
4452 E. Washington Blvd.
Los Angeles, CA 90023

Joe's Sound and Salami Co.
981 S. Broad St.
Trenton, NJ 08611

Parson's Manufacturing Corp.
1055 Obrien Dr.
Menlo Park, CA 94025-1476

Roadrunner Cases, Inc.
1745 West 134th St.
Gardena, CA 90249

Soundolier
9380 Watson Industrial Park
St. Louis, MO 63126

Starcase Manufacturing Co., Inc.
648 Superior
Munster, IN 46321

STANDS, BOOMS AND ACCESSORIES

ATLAS SOUND

Mic stands- eight basic straight stands with various base and shaft configurations, grip-action clutches, automatic clutches, two and three section tubes, integral air suspension, tripod bases, "two in one" stands, boom attachments (all types), desk stands (all types), bases with casters, ebony stands and booms.

Accessories- boom-counter weights, mounting brackets (speaker mounts), flexible goosenecks (all lengths), extension tubes, flange-mounting microphone support, twin mounts, snap-on accessories for mic holders, connect-on swivel, gyromatic swivel, shock mounts, adapters, fittings (for all models).

AUDIO TECHNICA U.S. INC.

Floor stands- 2 section, chrome, black, with and without cable clamps.

Floor stands with booms- 3 and 4 section, chrome, matte black, 12 1/2 in. to 24 1/2 in. range, 35 in. to 62 1/2 in. range.

Boom arms- chrome, matte black, 2 sections, 16 1/2 in. to 32 in. range. Stands have round and tripod type bases.

BEYER DYNAMIC INC.

Floor stands- round and tubular tripod type bases, adjustment ranges from 14 in. to 180 in., from \$35.00 to \$115.00.

Heavy duty floor stands- tubular, tripod type legs, adjustment ranges from 47 in. to 86 in., chrome, matte black, \$125.00 to \$180.00.

Booms- 33 1/4 in. non adjustable, 18 1/2 in. to 31 in. adjustable, 22 1/4 in. to 38 1/2 in. adjustable, chrome, matte black, all \$25.00.

Accessories and adapters- angled table stand, 6 in. table stand, plastic tripods, table flanges, twin mounts, padded mic clamps, clamp adapters (for adding mics to stands), 8 in. adjustable mounting rail, thread adapters: 5/8 in. to 3/8 in., 3/8 in.- 5/8 in., 5/8 in.- 3/8 in., 3/8 in.-1/2 in., 1/2 in.- 3/8 in.

EMP INC.

Keyboard stands- single and double "X" stands, all tubular 3-tier stand, 6-tier display stand, triple-modular stands, double-modular stands, single full sized, single miniature.

Mic stands- adjustable tripod-type straight stand, fully adjustable tripod-type boom stand.

LP MUSIC GROUP

Suspenders- mixer stand; length 28 in.- 43 in., depth 12 1/2 in., height 27 in.- 43 in., steel, black.

Suspenders- mic stands and booms; heights 35 in.-65 in., short telescopic 8 1/2 in. -10 1/2 in., boom 29 in., 35 in. -62 in. stand with 29 in. boom, 38 in. - 65 in. stand with 29 in. boom, 28 in. -44 in. with 29 in. boom.

Suspenders- speaker stands; heights 27 in.- 47 in., 3 ft. 4 in.- 7 ft., 3 ft. 2 in.- 6 ft. 4 in., 4 ft.-7 ft., silver, chrome, black, all aluminum, \$66.95 to \$140.95.

Accessories- the claw; mic-clamping device (attaches to drum rims, speaker cabinets, stands, etc.), goosenecks, double clamps, slide-type mic holders, clip-type mic holders.

SOLID SUPPORT INDUSTRIES

Multi Purpose Stand- 5-footed base with casters and keyboard-type pedestal, adjustable height.

Computer Support Series- multi-work station, locking casters, drop shelf, single, double and triple tier.

Rack Mount Stand- slanted front panel, open on all sides, permanent installations, up to 1,000 lbs., black, 19-inch width, 24-inch deep.

ULTIMATE SUPPORT SYSTEMS

Tripods- Two sizes: telescopes to 6 ft. 7 in. and 9 ft, 2 in. The larger holds 100 lbs. and weighs 8 lbs. The smaller holds 75 lbs. and weighs 6 lbs.

Rack stands- Five or ten panel rails, 19 in. width, A frame or inverted "T" supports.

Utility stands- "X" design, quickly disassembles, for mixers, keyboards, recording gear.

Versatable- For large mixers, 4-legged aluminum tubular construction. Each leg adjusts to individual lengths. Hardboard table top.

Mic stands- One hand, adjustable clutch. Legs collapse, 3 lbs., bags available for carrying.

ADDRESSES

Stands, Booms and Accessories

Atlas Sound
10 Pomeroy Rd.
Parsippany, NJ 07054

Audio Technica U.S., Inc.
1221 Commerce Dr.
Stow, OH 44224

Beyerdynamic, Inc.
5-05 Burns Ave.
Hicksville, NY 11801

EMP, Inc.
2915 S. 160th St.
New Berlin, WI 53151

L P Music Group
Suspenders
160 Belmont Ave.
Garfield, NJ 07026

Solid Support Industries
2453 Chico Ave.
South El Monte, CA 91733

Ultimate Support Systems
P.O. Box 470
Fort Collins, CO 80522

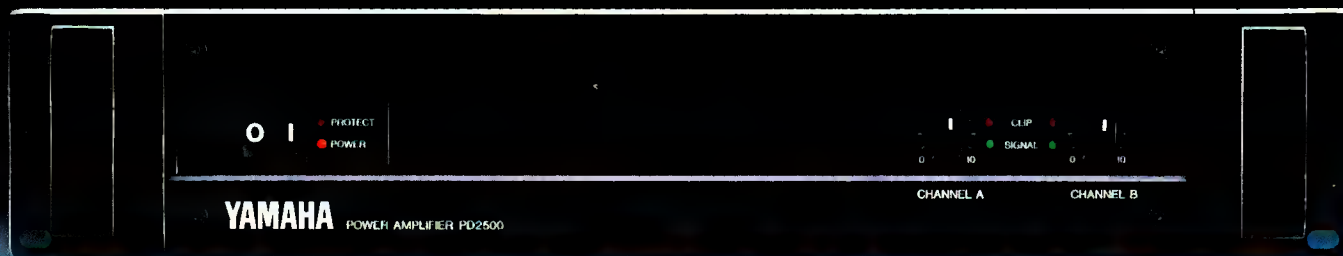

We're not big in power amps anymore.

At just 26½ lbs., our new PD2500 power amplifier makes light work of large-scale sound reinforcement.

But unlike previous attempts to reduce the bulk of high power, Yamaha's doesn't reduce performance.

You get an impressive 500 watts RMS per channel into 2 ohms; 250 watts into 8 ohms. And 1000 watts into a 4-ohm bridged mono load.

All in a very compact 3½-inch by 19-inch rack space.

Yet while it carries like a briefcase, it still sounds like a Yamaha.

The newly designed high-frequency switching power supply is more stable and better regulated than conventional designs. We also increased the switching frequency to 125kHz. For an

improvement you can hear, especially in the low frequencies.

We added a better forced cooling system, and independent dB-calibrated attenuators for precise level balancing.

The PD2500 is even listed by Underwriters Laboratories.

There's more you should know about this elegant combination of high power and easy handling. So write: Yamaha International Corporation, Professional Audio Division, P.O. Box 6600, Buena Park, CA 90622. In Canada: Yamaha Canada Music Ltd., 135 Milner Avenue, Scarborough, Ontario, M1S 3R1.



YAMAHA[®]
Engineering Imagination™

Circle 10 on Reader Service Card



The new SM96. When you don't want home studio tapes to sound homemade.

Your recordings are only as good as the mic you use. Why hurt your chances of selling your song by using an inferior microphone?

The first affordable studio-quality vocal condenser microphone.

The SM96 is especially designed for home studios. It captures vocal subtleties ordinary mics can miss. So the tapes you produce sound crisper, punchier, and smoother.

We've even built in a three-stage pop filter and a precise bass rolloff to compensate for the proximity effect of a close-miked vocal. And, our unique 3-point space frame shock mount totally isolates the SM96 from mechanical noise pickup. Your tapes will sparkle with a sound quality that you would expect only in

professional studio recordings.

Works with or without phantom power.

The SM96 is the first microphone of professional caliber which can be powered by a readily available 1.5 volt AA battery. So you can have the silky-smooth sound of a top quality condenser mic even if your equipment doesn't have phantom power. And you can use the SM96 on stage with any mixing board.

Can you afford to make the modest investment in this remarkable new microphone? If you're serious about your music, a better question is, can you afford not to?

Shure Brothers Inc., 222 Hartrey Ave., Evanston, IL 60202-3696. (312) 866-2553. G. S. A. approved.



SHURE

Breaking Sound Barriers

for over 60 years

Circle 12 on Reader Service Card