



CROWN

SERVICE MANUAL



D-150A POWER AMPLIFIER

CROWN INTERNATIONAL, INC. 1718 W. MISHAWAKA RD. ELKHART, INDIANA 46517

**© 1988 Crown International, Inc.
K80028-2
1/88**



TABLE OF CONTENTS

RVW Sec. Review

I.	Introduction	R-1
II.	Warranty	R-1
III.	Specifications	R-1
IV.	Panel Configuration	R-3
V.	Performance Graphs	R-4

Section 6 Illustrated Parts List

6.1	General Information	6-1
6.2	Standard and Special Parts	6-1
6.3	Ordering Parts	6-1
6.4	Shipment	6-1
6.5	Terms	6-1
6.6	Schematics/Parts Lists/Exploded View Drawings	6-2

Section 7 Maintenance

7.1	Introduction	7-1
7.2	Required Test Equipment	7-1
7.3	Soldering Techniques	7-2
7.4	Basic Troubleshooting	7-7
7.5	Discharging Instructions	7-8
7.6	Disassembly for Inspection, Service, Testing, Adjustment and Repairs	7-8
7.7	Reassembly	7-10
7.8	Electrical Checkout and Adjustment Procedures	7-10
7.9	Troubleshooting Hints	7-12
7.10	Voltage Conversion Chart	7-15
7.11	Block Diagram Circuit Theory	7-16
7.12	Theory of Operation	7-17

Section 8 Service Bulletins

8-1

LIST OF ILLUSTRATIONS

Fig. RVW.1	D-150A Front Panel	R-3
Fig. RVW.2	D-150A Rear Panel	R-3
Fig. RVW.3	Nominal Frequency Response	R-4
Fig. RVW.4	Nominal Phase Response	R-4
Fig. RVW.5	Nominal Crosstalk	R-5
Fig. RVW.6	Nominal Noise Spectrum	R-6
Fig. RVW.7	Nominal Output Impedance	R-6
Fig. RVW.8	Nominal Output Phase Angle	R-6
Fig. RVW.9	Nominal Damping Factor (8 ohms)	R-7
Fig. RVW.10	Nominal Power Efficiency	R-7
Fig. RVW.11	V-I Plot	R-8
Fig. 6.1	MI-261 Main Board Schematic	6-2
Fig. 6.2	MI-261 Foil Board Layout	6-2
Fig. 6.3	MI-261A Main Board Schematic	6-4
Fig. 6.4	MI-261A Foil Board Layout	6-5
Fig. 6.5	MI-261B Main Board Schematic	6-6
Fig. 6.6	MI-261B Foil Board Layout	6-7
Fig. 6.7	MI-261C Main Board Schematic	6-8
Fig. 6.8	MI-261C Foil Board Layout	6-9
Fig. 6.9	MI-261D Main Board Schematic	6-10
Fig. 6.10	MI-261D Foil Board	6-11
Fig. 6.11	MI-261E Main Board Schematic	6-12
Fig. 6.12	MI-261E Component Board Layout	6-12
Fig. 6.13	MI-261E Foil Board Layout	6-13
Fig. 6.14	IOC Component Board Layout	6-13
Fig. 6.15	IOC Foil Board Layout	6-13
Fig. 6.16	Front Panel Assembly	6-16
Fig. 6.17	Chassis Assembly	6-17
Fig. 6.18	Output Assembly	6-19
Fig. 6.19	Miscellaneous Assembly	6-21
Fig. 7.1	Miniature Soldering Iron	7-2
Fig. 7.2	Correct and Incorrect Solder Application	7-3
Fig. 7.3	Unsoldered Wire	7-3
Fig. 7.4	External Strands	7-4
Fig. 7.5	Cut Strands	7-4
Fig. 7.6	Wire Strippers	7-4
Fig. 7.7	Disturbed Joint	7-5
Fig. 7.8	Cold Solder Joint	7-5
Fig. 7.9	Rosin Joint	7-6
Fig. 7.10	Component Lead Spacing	7-6
Fig. 7.11	Component Lead Bending	7-6
Fig. 7.12	Correct Pressure Applied	7-6
Fig. 7.13	Acceptable Solder Joints	7-6
Fig. 7.14	Soldering to a Lug	7-7
Fig. 7.15	Turret Terminal	7-7
Fig. 7.16	Wire Braid Desoldering	7-7
Fig. 7.17	Discharge Points	7-8
Fig. 7.18	IM Distortion Test Set-up	7-11
Fig. 7.19	Signal to Noise Test Set-up	7-12
Fig. 7.20	Voltage Conversion	7-15
Fig. 7.21	D-150A Block Diagram	7-16
Fig. 7.22	Input Stage	7-17
Fig. 7.23	Voltage Amplification Stage	7-17
Fig. 7.24	Output Stage	7-18
Fig. 7.25	Protection Circuitry Stage	7-18
Fig. 7.26	Bootstrap Supply	7-19
Fig. 7.27	IOC Stage	7-19
Fig. 7.28	World-Wide Voltage Map	7-20



REVIEW SECTION

I. Introduction

This manual contains complete service information on the D-150A. It is designed to be used in conjunction with the D-150A Instruction Manual. However, some important information is duplicated in this Service Manual in case the Instruction Manual is not readily available.

NOTE: THE INFORMATION IN THIS MANUAL IS INTENDED FOR USE BY AN EXPERIENCED TECHNICIAN ONLY!

II. Warranty

As a Crown Warranty Service Station, you should be familiar with Crown warranty policies. Each Instruction Manual contains basic policies as related to the customer. However, under questionable circumstances, please contact the Technical Service Department or Director of Customer Service at: Crown International, Inc., 1718 W. Mishawaka Road, Elkhart, IN 46517.

III. Specifications

General Specifications

Hum and Noise (20Hz-20KHz): 110dB below rated output.

Phase Response: +0, -15°, DC-20KHz at 1 watt.

Input Impedance: 25K ohms, $\pm 3\%$.

Amplifier Output Protection: Short, mismatch, and open circuit proof. Limiting is instantaneous with no flyback pulses, thumps, cutouts, etc. No premature limiting on transients.

Overall Protection: AC line fused. Thermal switch in AC line protects against overheating caused by insufficient ventilation. Controlled slewing-rate voltage amplifiers protect overall amplifier against RF burnouts. Input overload protection is furnished by internal resistance at inputs of amp.

DC Output Offset (Shorted Input): 10 millivolts or less, internally adjustable to zero.

Turn-On: Instantaneous, with minimum thumps and no program delay.

Circuit: Wideband multiple feedback loop design utilizing one linear IC (dual op-amp), total equivalent of 48 transistors, 22 signal diodes, 3 zener diodes, and 6 rectifier diodes.

Power Supply: Massive computer-grade filter capacitors store over 20 joules of energy. Two regulated supplies for complete isolation and stability.

Power Requirements: Requires 50-400Hz AC on 100, 200, 220, or 240V $\pm 10\%$ operation. Draws 30 watts or less on idle, 250 watts at 160 watts total output.

Heat Sinking: The entire amplifier is used as a heat sink. 3/16 inch thick chassis acts as a heat sink along with auxiliary fins.

Chassis: All aluminum construction for maximum heat conduction and minimum weight.

Controls: Independent level controls are mounted on the front panel. Power switch with associated pilot light is on front panel. Non-interacting DC balance controls are mounted on main PC board under electronics cover. A mono-stereo switch is located next to the input jacks on the rear panel.

Connectors: Input - 1/4 inch phone jacks, output - color coded binding posts, AC line - 3-wire (grounded) male connector on 5 foot minimum cable.

Dimensions: 17 inches (43.18cm) long, 5 1/4 inches (13.34cm) high, 8 3/4 inches (22.23cm) deep (from mounting surface of front panel), 19 inches (48.26cm) long with standard rack mounting brackets installed.

Weight: 24 pounds.

Finish: Satinized aluminum front panel with gray suede Lexan insert.

Stereo Specifications

Output Power: 80 watts per channel minimum RMS (both channels operating) into an 8 ohm load over a bandwidth of 1Hz-20KHz at a rated RMS sum total harmonic distortion of 0.05% of the fundamental output voltage.

Frequency Response: ± 0.1 dB DC-20KHz at 1 watt into 8 ohms; ± 1 dB DC-100KHz.

1KHz Power: 90 watts RMS into 8 ohms, per channel, both channels operating, 0.1% total harmonic distortion.

Harmonic Distortion: Less than 0.001% from 20-400Hz and increasing linearly to 0.05% at 20KHz at 80 watts RMS per channel into 8 ohms.

I.M. Distortion S.M.P.T.E. (60Hz-7KHz 4:1): Less than 0.05% from 0.01 watt to 0.25 watts and less than 0.01% from 0.25 watts to 80 watts into 8 ohms, per channel.

Slewing Rate: 6 volts per microsecond (slewing rate is the maximum value of the first derivative of the output signal, or the maximum slope of the output signal).

Damping Factor: Greater than 400, DC-400Hz into 8 ohms.

Output Impedance: Less than 15 milliohms in series with less than 3 microhenries.

Load Impedance: Rated for 8 ohm usage; safely drives any load including completely reactive loads.

Voltage Gain: $20.6 \pm 2\%$ or 26.3 ± 2 dB at maximum gain.

Input Sensitivity: 1.19 volts $\pm 2\%$ for 80 watts into 8 ohms.

Output Signal: Unbalanced, dual channel.

Monaural Specifications

Output Power: 160 watts minimum RMS into a 16 ohm load over a bandwidth of 1Hz-20KHz at a rated RMS sum total harmonic distortion of 0.05% of the fundamental output voltage.

Frequency Response (1KHz Power): ± 0.15 dB DC-20KHz at 1 watt into 16 ohms; ± 1 dB DC-60KHz, 180 watts RMS into 16 ohms.

Harmonic Distortion: Less than 0.001% from 20-400Hz and increasing linearly to 0.05% at 20KHz at 160 watts into 16 ohms.

I.M. Distortion S.M.P.T.E. (60Hz-7KHz 4:1): Less than 0.05% from 0.01 watts to 0.25 watts and less than 0.01% from 0.25 watts to 160 watts into 16 ohms, per channel.

Slewing rate: 12 volts per microsecond.

Damping Factor: Greater than 400, DC-400Hz into 16 ohms.

Output Impedance: Less than 30 milliohms in series with less than 6 microhenries.

Load Impedance: Rated for 16 ohm usage; safely drives any load including completely reactive loads.

Voltage Gain: $41.2 \pm 2\%$ for 160 watts into 16 ohms.

Input Sensitivity: 1.19 volts $\pm 2\%$ for 160 watts into 16 ohms.

Output Signal: Balanced, single channel.



IV. Panel Configuration

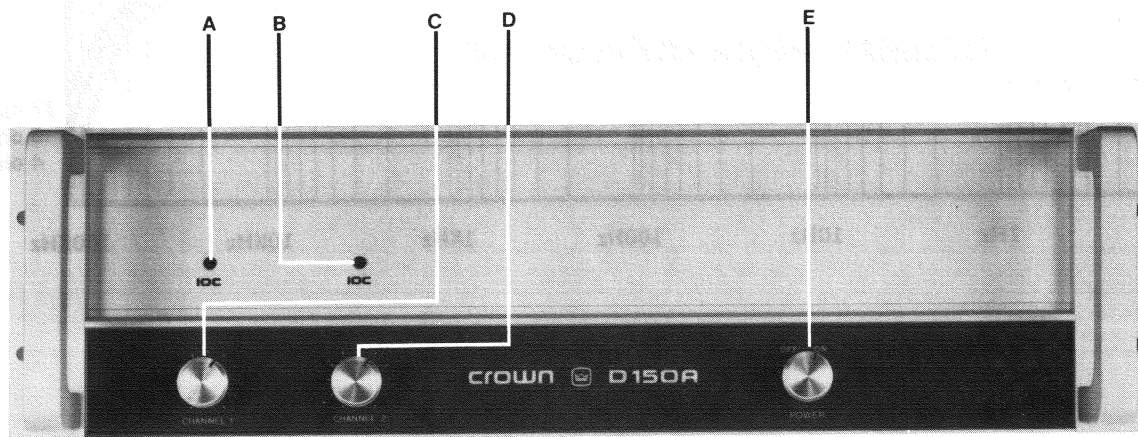

Fig. RVW.1 D-150A Front Panel

- A. CHANNEL 1 IOC INDICATOR
- B. CHANNEL 2 IOC INDICATOR
- C. CHANNEL 1 INPUT LEVEL CONTROL
- D. CHANNEL 2 INPUT LEVEL CONTROL
- E. ON/OFF SWITCH

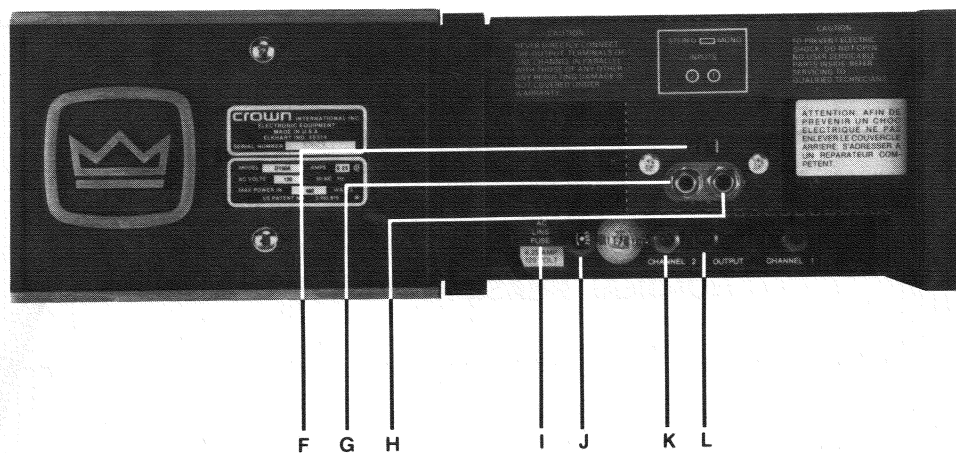

Fig. RVW.2 D-150A Rear Panel

- F. MONO/STEREO SWITCH
- G. CHANNEL 2 UNBALANCED INPUT
- H. CHANNEL 1 UNBALANCED INPUT
- I. AC POWER LINE
- J. FUSE HOLDER
- K. CHANNEL 2 MAIN OUTPUT JACK
- L. CHANNEL 1 MAIN OUTPUT JACK

V. Performance Graphs

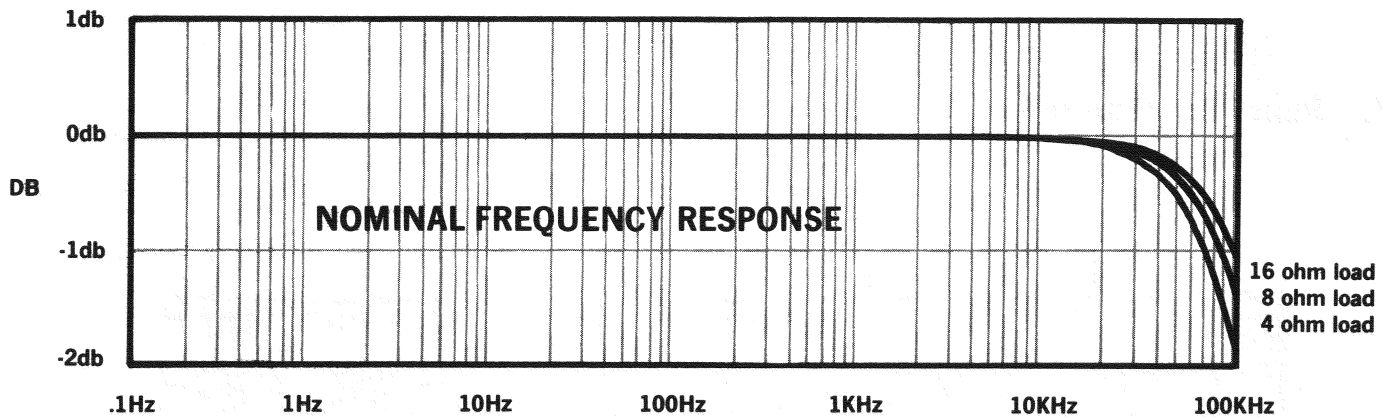

Fig. RVW.3 Nominal Frequency Response

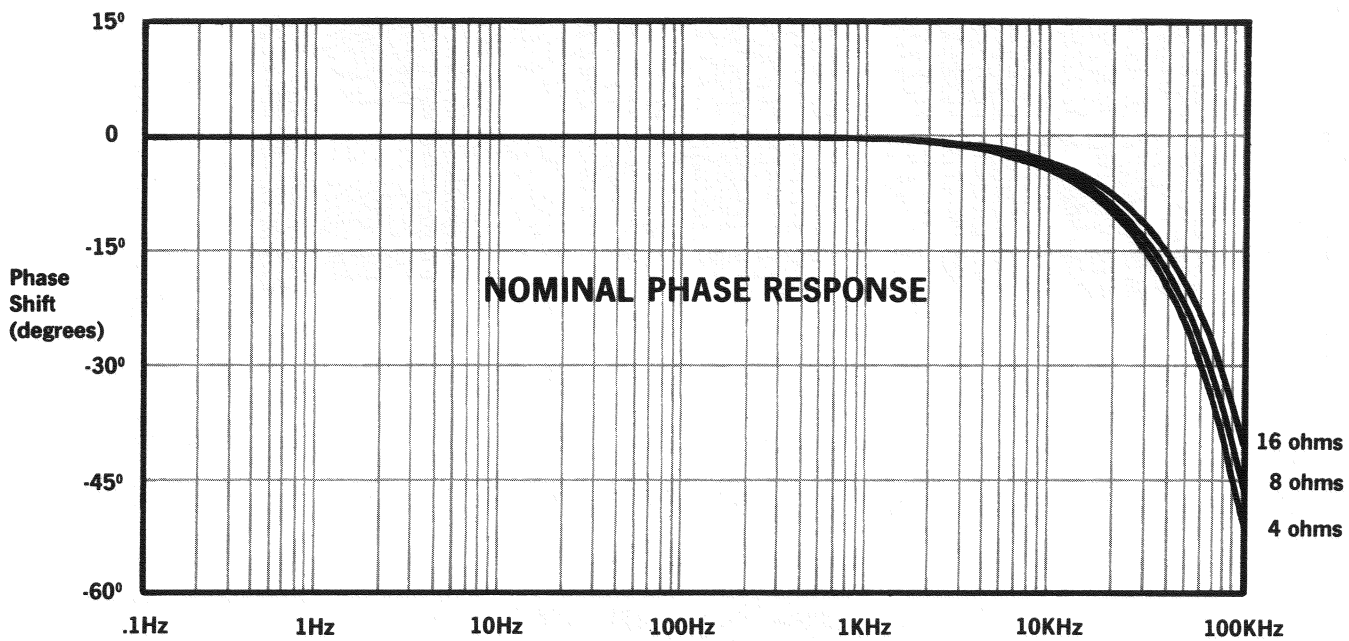

Fig. RVW.4 Nominal Phase Response

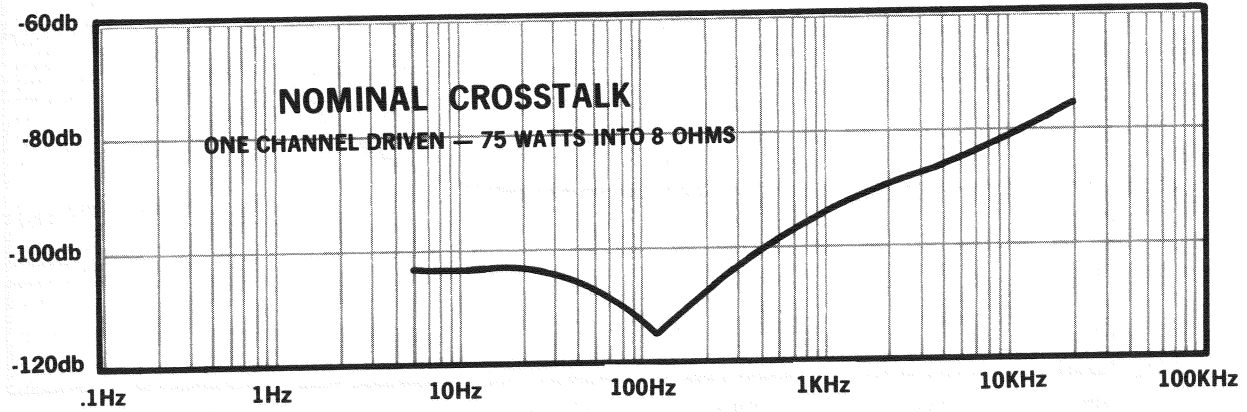

Fig. RVW.5 Nominal Crosstalk

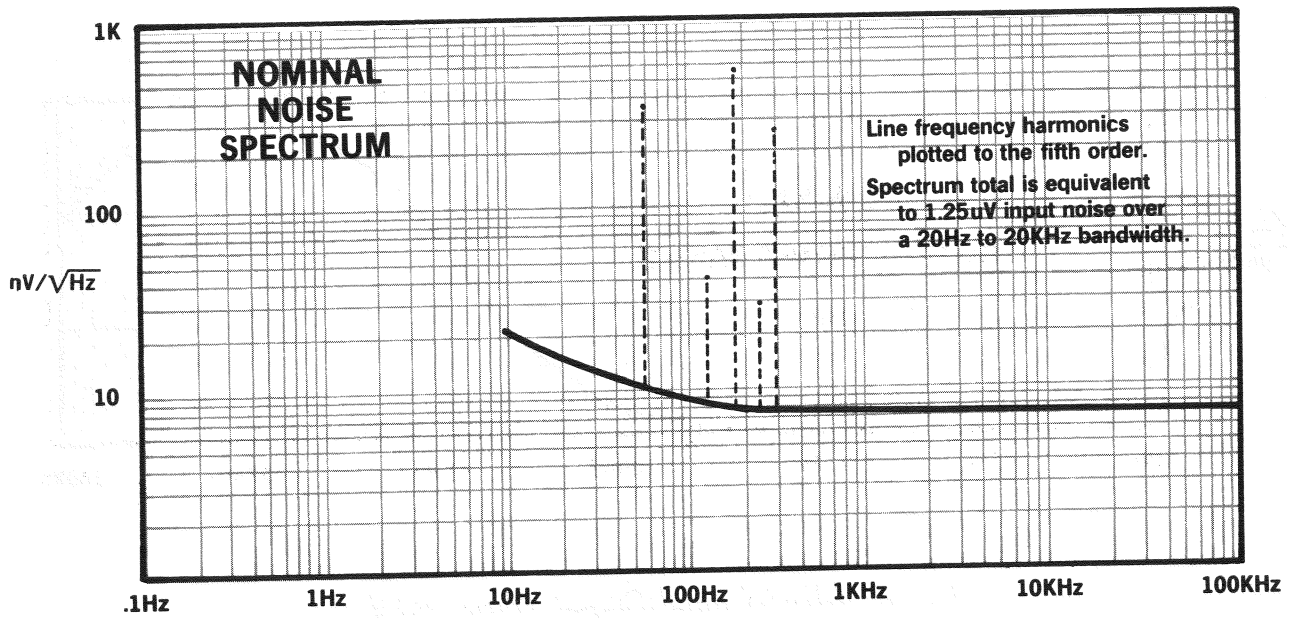

Fig. RVW.6 Nominal Noise Spectrum

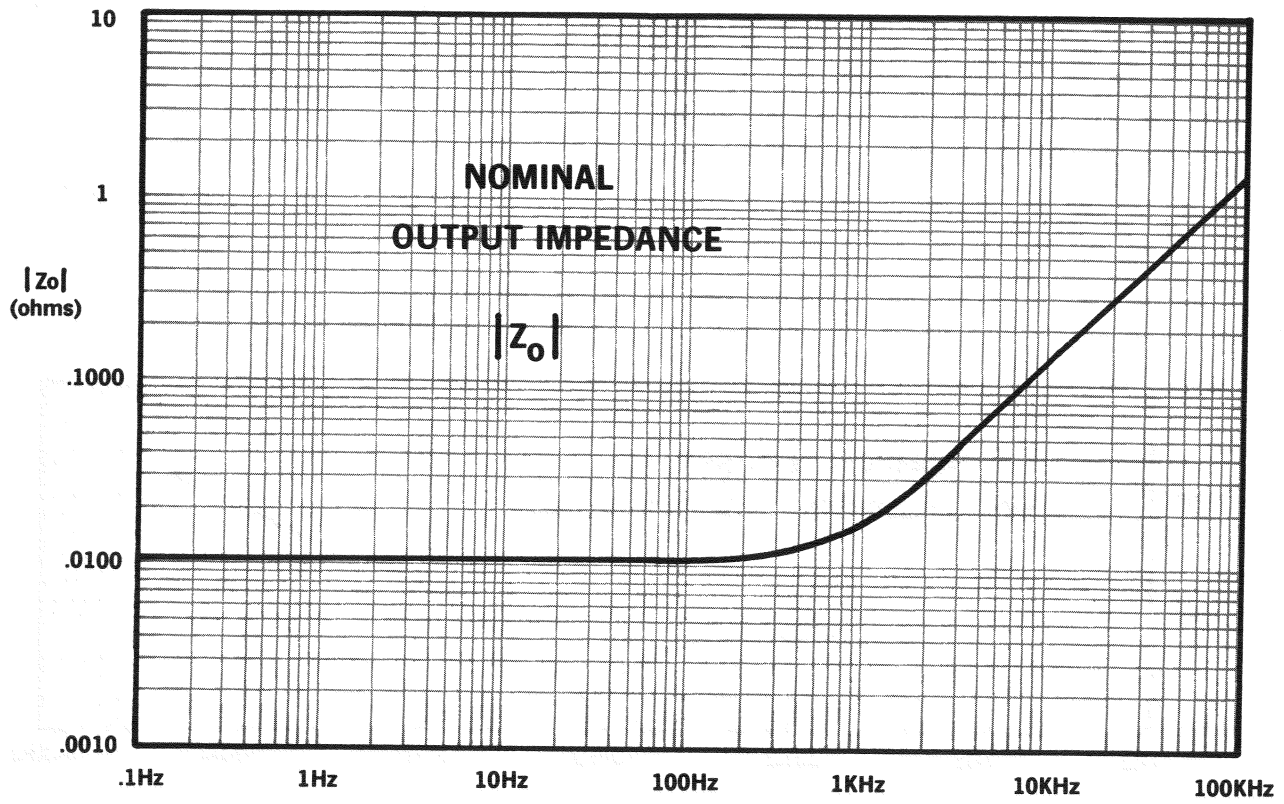

Fig. RVW.7 Nominal Output Impedance

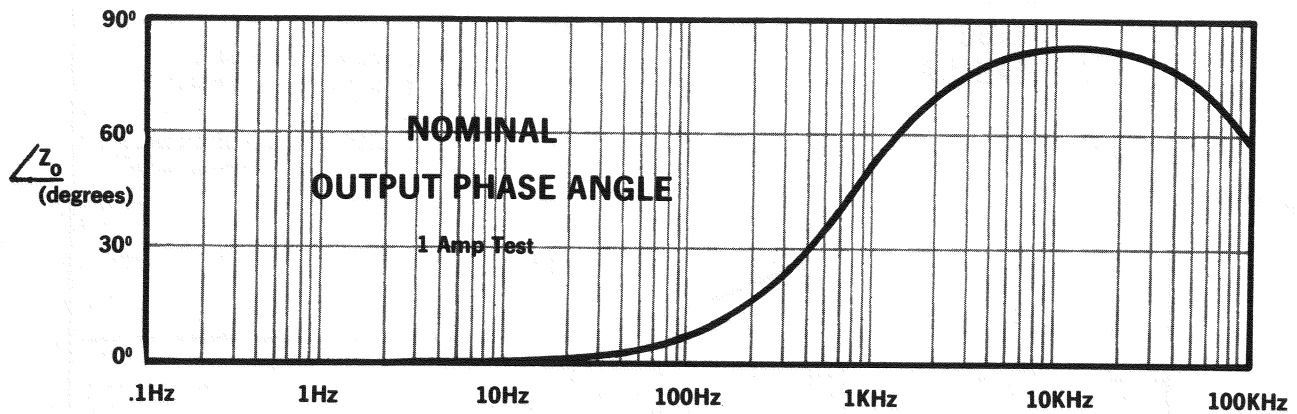

Fig. RVW.8 Nominal Output Phase Angle

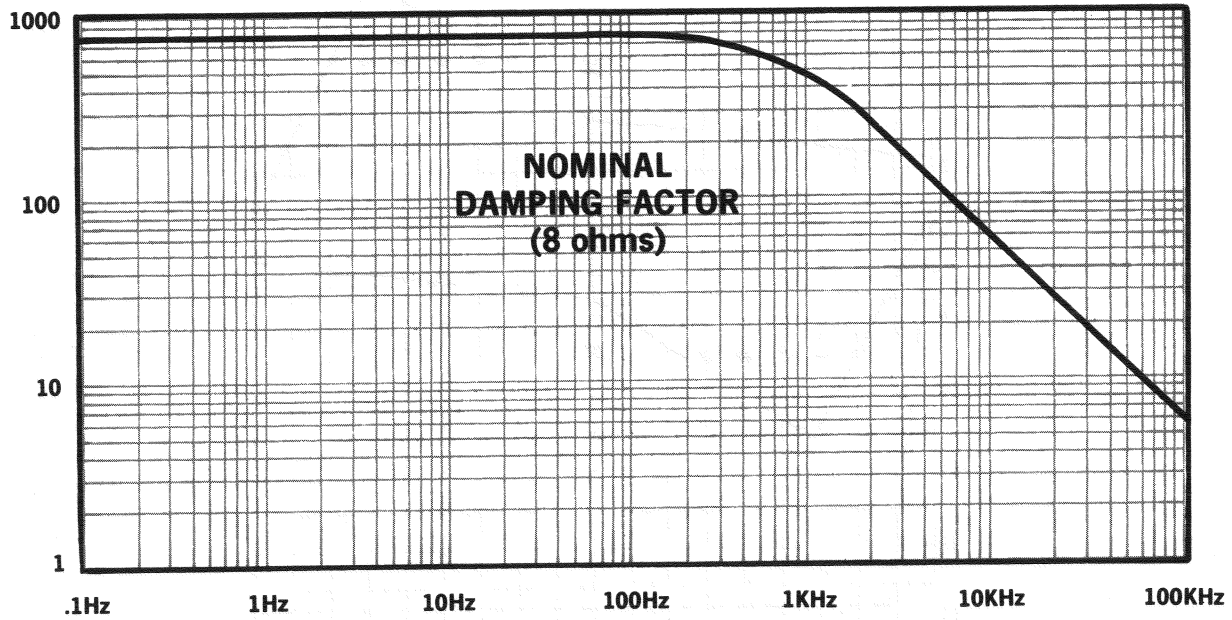

Fig. RVW.9 Nominal Damping Factor (8 ohms)

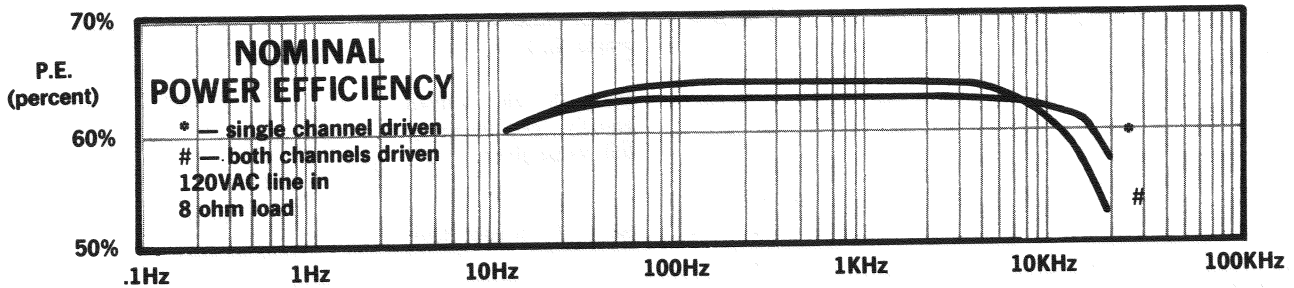
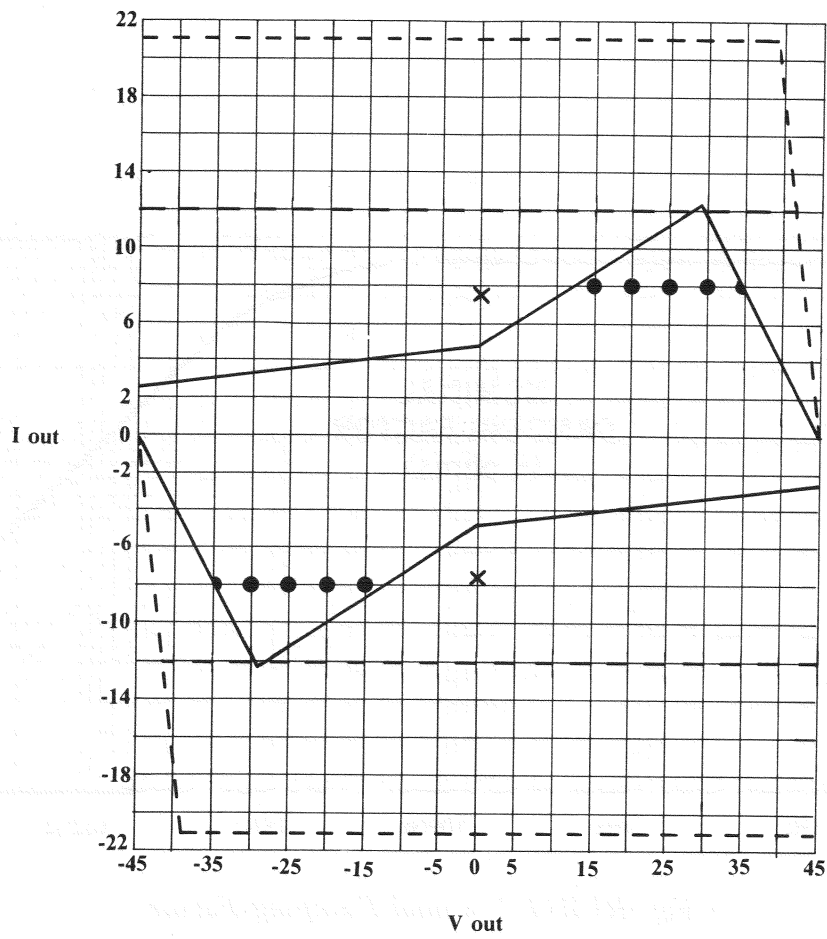

Fig. RVW.10 Nominal Power Efficiency



— — — — — Max. cont AC power
 $Z_L=3$ ohms

● ● ● ● ● AC line fuse blows (DC
 single ch.)
 if both ch. driven
 equally fuse blows at
 half value given

× × Short circuit cont. limit

- - - - - Max. AC limit ($Z_L V_{out}$
 (sine) at max.)

Fig. RVW.11 V-I Plot



SECTION 6

ILLUSTRATED PARTS LIST

6.1 General Information

Section 6 contains illustrations and parts lists for the D-150A. This information should be used with the service, repair and adjustment procedure in Section 7.

Most of the mechanical and structural type parts are illustrated and indexed on exploded view drawings. Electrical and electronic parts on these illustrations are also identified by the circuit reference designation next to the illustration. Both the index number and the reference designation are included in the parts list in separate columns. The reference designations correspond to those shown in schematic diagrams in the Review Section.

Electrical and electronic parts located on printed circuit boards are illustrated by schematic symbols on the trace side and by component shape symbols on the component side. Reference designations also appear on these diagrams.

The quantity of each part used in each location is also shown in the parts listing.

6.2 Standard and Special Parts

Many electrical and electronic parts used in the D-150A are standard items stocked by and available from electronic supply houses. However, some electronic parts that appear to be standard, are actually special. A part ordered from Crown will assure an acceptable replacement. Structural items, covers and panels are available from Crown only.

6.3 Ordering Parts

When ordering parts, be sure to give the amplifier model and serial number and include the part description and Crown Part Number (CPN) from the parts list. Price quotes are available upon request.

6.4 Shipment

1. Shipment will be made by UPS or best method unless you specify a preferred method.
2. Shipments are made F.O.B. Elkhart, Indiana only.
3. Established Crown accounts will be freight prepaid and billed unless shipped by truck or air freight.
4. All others will be shipped freight collect.

6.5 Terms

1. Normal terms are C.O.D. unless the order is prepaid.
 2. Net 30 days terms apply only to those firms who have an established line of credit with Crown.
 3. If prepaying please add an amount for the freight charge. \$1.00 is average for an order under one pound.
- NOTE:** Part prices are subject to change without notice.
4. New parts returned for credit are subject to a 10% restocking charge.
 5. You must receive authorization from the Parts Dept. before returning parts for credit.
 6. We are not a general parts warehouse! Parts are available for servicing Crown products only.

Schematic Designation	Description	Crown Part No.	Qty.	Other Information
Capacitors				
C100, C200, C106, C206	100pF Mica	C 3410-5	4	
C101, C201	.001mF 200V Filmatic	C 3480-8	2	
C102, C202, C103, C203, C114, C214, C107, C207	200pF Mica	C 3411-3	8	
C104, C204, C117, C217	47pF Mica	C 3409-7	4	
C105, C205	120pF Mica	C 3290-1	2	
C108, C208, C109, C209	22mF 50V Vertical	C 5311-3	4	
C110, C210	.0027mF 200V Filmatic	C 3481-6	2	
C111, C211	470pF Mica	C 2511-1	2	
C112, C212	.0022mF 200V Filmatic	C 3285-1	2	
C113, C213, C6	.01mF Ceramic Disc	C 1751-4	3	
C115, C215	0.22mF 100V Filmatic	C 3218-2	2	
C116, C216, C1, C8	.1mF 200V Filmatic	C 2938-6	4	
C2, C3	9400mF 50V	C 3309-9	2	
C4	10mF 160V	C 2796-8	1	
C5	10mF 50V Vertical	C 3728-0	1	
C7	100mF 16V Vertical	C 3729-8	1	
C9	.001mF Ceramic Disc	C 2288-6	1	
Resistors				
R100, R200	100K Horizontal Pot	C 1709-2	2	Output offset adjust
R101, R201	2M ohm .25W 5% CF	C 3199-4	2	
R102, R202	250K Horizontal Pot	C 3087-1	2	Input offset adjust
R104, R204	820K ohm .25W 5% CF	C 3623-3	2	
R105, R205	25K ohm Audio Pot	D 2942-7	2	
R106, R206	4.7K ohm .25W 5% CF	C 3939-3	2	
R107, R207	56 ohm .25W 5% CF	C 3511-0	2	
R108, R208	3.3K ohm .25W 10%	2629	2	Used when IC-1 is UA749. See IC-1 under integrated circuits.
R109, R209	510 ohm .5W 1% MF	C 3304-0	2	
R110, R210	2.4K ohm .25W 5% CF	C 3616-7	2	
R111, R211	56K ohm .25W 5% CF	C 2882-6	2	
R112, R212, R5	8.2K ohm .25W 5% CF	C 2877-6	3	
R113, R213	5.6K ohm .25W 5% CF	C 3220-8	2	
R114, R214, R103, R203	1K ohm .25W 5% CF	C 2627-5	4	
R115, R215, R11	10K ohm .5W 1% MF	C 2343-9	3	
R116, R216	820 ohm .25W 5% CF	C 3301-6	2	
R117, R217	33K ohm .5W 5% MF	C 3137-4	2	
R118, R218, R123, R223	120 ohm .5W 5% CF	C 3837-9	4	
R119, R219, R122, R222, R124, R224	82 ohm .25W 5% CF	C 3960-9	6	

Parts List: D-150A Main Module (For SN26591 and above)

Schematic Designation	Description	Crown Part No.	Qty.	Other Information
R120, R220	5.1K ohm 1W 5% MF	C 2808-1	2	
R121, R221	27K ohm .5W 5% CF	C 1056-8	2	
R125, R225, R2	2.2K ohm .5W 5% CF	C 1036-0	3	
R126, R226	750 ohm .25W 5% CF	C 3803-1	2	
R127, R227	15 ohm .25W 5% CF	C 3614-2	2	
R128, R228	-Selected-	-----	2	Bias resistors
R129, R229, R13	47 ohm .25W 5% CF	C 1011-3	3	
R130, R230, R135, R235	180 ohm .25W 5% CF	C 2873-5	4	
R131, R231, R136, R236	5.6 ohm .5W 5% CF	C 3299-2	4	
R132, R232, R134, R234	0.1 ohm 5W 10%	C 4761-0	4	
R133, R233	2.7 ohm 1W 10%	C 1001-4	2	
R137, R237	180K ohm .2W 5% CF	C 4218-1	2	
R3	1.5K ohm 2W 10%	C 3303-2	1	
R4, R17	200K ohm .25W 5% CF	C 3622-5	2	
R6	91K ohm .25W 5% CF	C 3621-7	1	
R7	6.2K ohm .25W 5% CF	C 3619-1	1	
R8	2.7K ohm 1W 10%	C 1079-0	1	
R9	1 ohm .5W 5% CF	C 3612-6	1	
R10	390 ohm .5W 5% CF	C 2609-3	1	
R12	390 ohm 2W	C 4029-2	1	
R142, R242, R143, R243	13K ohm .25W 5% CF	C 4300-7	4	
R145, R245, R146, R246	2.7 ohm .5W 5% CF	C 2857-8	4	
Transistors				
Q100, Q200, Q104, Q204, Q108, Q208	2N4125 PNP	C 3625-8	6	
Q101, Q201, Q2	PN4250A PNP	C 3786-8	3	
Q101, Q201	MPS93 PNP	C 3578-9	2	
Q102, Q202, Q103, Q203, Q106, Q206, Q111, Q211, Q1	SEL 2N3859 NPN	D 2961-7	7	
Q105, Q205	MPSL01 NPN	C 3232-3	2	
Q107, Q207	NSD106 NPN	C 4069-8	2	<i>c5065-5</i> <i>c4061-5</i> Positive predrivers
Q109, Q209	SEL 2N3585 NPN	D 3295-9	2	Drivers
Q112, Q212	SS7304 PNP	D 5611-5	2	<i>D2923-7</i> Negative predriver
Q113, Q213	SEL 2N3585 NPN	D 3295-9	2	Negative driver
* No longer available				
Q110, Q210				
Q114, Q214	2N3773	*3773	4	Used with D-150A SN 8359 and below
Q110, Q210, Q114, Q214	2N5631	*3991	4	Used with D-150A between SN8360 and 17875 (selected units)
Q110, Q210, Q114, Q214	T6J0377	*3941	4	Used with D-150A between SN8360 and 17875 (selected units)
Q110, Q120, Q114, Q214	2N5631 100V	C 3990-6	4	Used with D-150A SN 17876 and above

Parts List: D-150A Main Module (Continued)

Schematic Designation	Description	Crown Part No.	Qty.	Other Information
Integrated Circuits				
IC1A,B	739PC Dual Op Amp	C 3231-5	1	
Diodes				
D100, D200, D101, D201, D103, D203, D104, D204, D105, D205 D102, D202, D106, D206, D1, D2 D107, D207 D3, D4, D5	IN4148 IN4004 IN270 IN961B 10V Zener	C 3181-2	10	
Miscellaneous				
SW2	2 Conductor Jacks	C 3423-8	2	Input jacks
SW3	A-P Switch	M20105-9	1	On/off
	DPDT Slide Switch	C 4110-0	1	Stereo/Mono
	14 PIN IC Socket	C 3450-1	1	
L100, L200	.5mh coil	C 3510-2	2	

Parts List: D-150A IOC Module (SN22394 and above)

Capacitors				
C118, C218	0.22mF 100V Filmatic	C 3218-2	2	
C8	2.2mF 50V Vertical	C 5362-6	1	
Resistors				
R138, R238	1.6M .25W 5% CF	C 4235-5	2	
R139, R239	2.7K ohm 1W 10%	C 1079-0	2	
R140, R240	27K ohm .5W 5% CF	C 1056-8	2	
R141, R241	18K ohm .25W 5% CF	C 2633-3	2	
R14, R16	33K ohm .25W 5% CF	C 4346-0	2	
R15	150K ohm .25W 5% CF	C 4216-5	1	
R144, R244	10K ohm .25W 5% CF	C 2631-7	2	
Transistors				
Q115, Q215, Q116, Q216	Selected 2N3859A NPN	D 2961-7	4	
IC2A,B,C,D	LM 339 Voltage Comparator	4345	1	
Diodes				
	IN4148	C 3181-2	2	
	MV5053 Red LED	C 4341-1	2	
Miscellaneous				
	14 PIN IC Socket	C 3450-1	1	

Parts List: D-150A Front Panel Assembly

Index No.	Schematic Designation	Description	Crown Part No.	Qty.	Other Information
1		.83 Aluminum Knob	D 4075-4	3	
2		.375 Bright Nut	C 1288N7	3	
3		.625x.375x.030 Brightwasher	C 2189-6	3	
4		Front Panel Lexan Insert	D 4091-1	1	
5		D-150A Front Panel	D 4614-0	1	
6		5.25 Rack Mount Ears	F 9787-7	2	*Optional; end-bar also supplied
7		S 632 .75 Machine Screw	C 1858-7	4	
8		Lamp Bracket	F 9598-8	1	
9		10-32 Hex Nut	C 2170-6	1	
10		#10 Internal Starwasher	C 2279-5	1	
11		End Cover (Transformer Side)	F 9565J6	1	
12		T10 32 .50 Machine Screw	2049N-2	4	
13		Transformer Wraparound	F 9952J6	1	
14		Transformer Cover	D 3355-1	1	
15		T10 32 .50 Machine Screw	2049N2	2	
16		Heatsink Fin	D 3956-6	2	
17		Board Cover	F 9564J9	1	
18		End Cover (Board Side)	F 9566J4	1	
19		Chassis	D 3544-0	1	
20		SW 10 P. 75 Self-tapping Screw	C 4017-7	4	
21		IOC Board Module	M41904-0	1	
22		#6 Internal Starwasher	C 5594-4	2	
23		6-32 Hex Nut	C 1889-2	2	
24		.250x.141x.625 Aluminum Spacer	C 4612-5	2	
25		#10 Internal Starwasher	C 2279-5	2	
26		X 632 1.0 Machine Screw	C 4333-8	2	
27	R106, R206	25K ohm Audio Pot	D 2942-7	2	
28		334 Solder Lug .375 Hole	D 2828-8	2	
29		.375 Internal Starwasher	C 2188-8	7	
30		R6 32 .25 Machine Screw	C 1954-4	6	
31		#6 Internal Starwasher	C 5594-4	6	
32	SW2	Rotary Power Switch	M41549-3	1	

list price
to 2.500
BULB - C 2900-6 Lamp 1822 36V .10A
CHICAGO MIN.

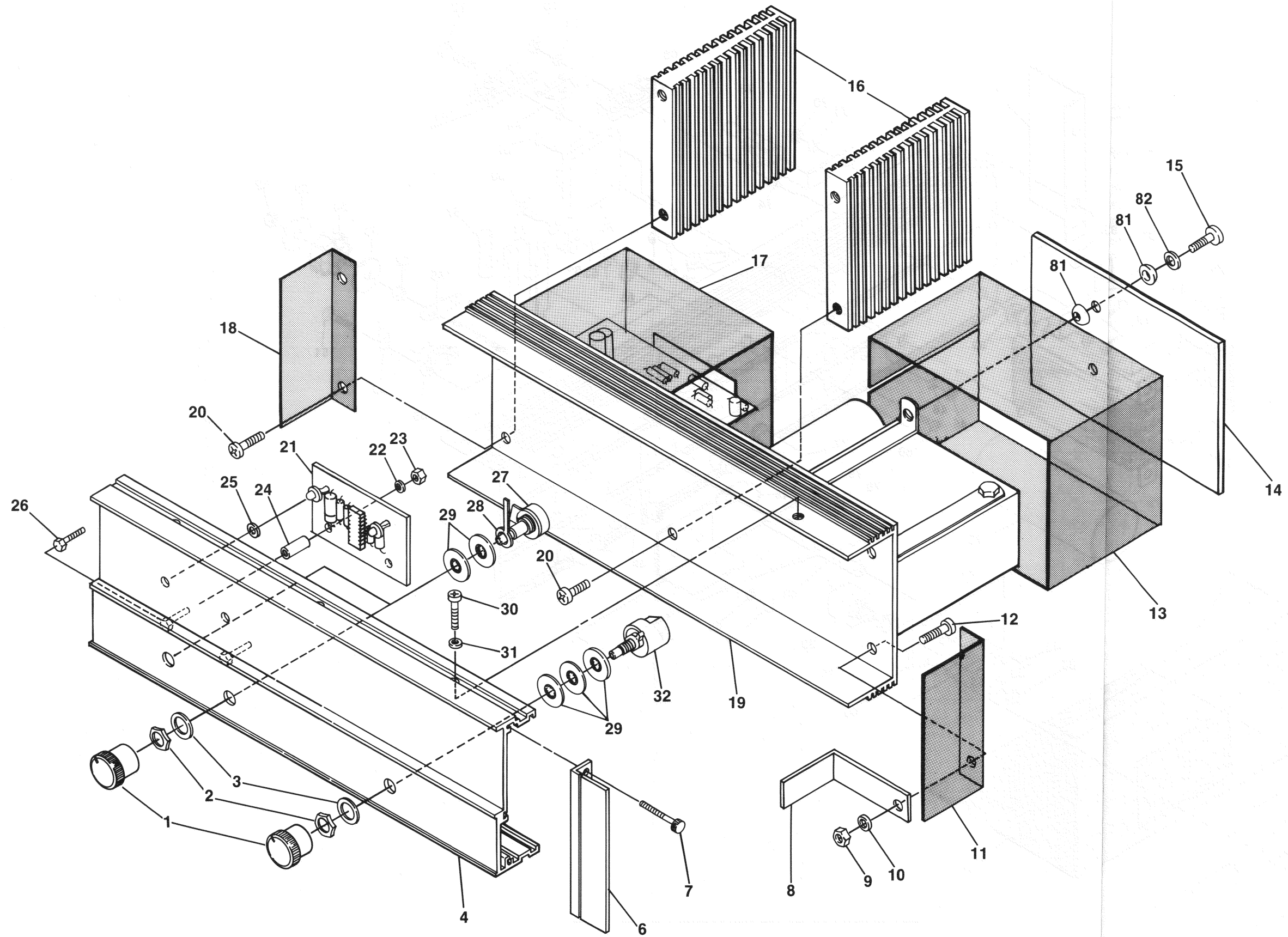

Fig. 6.16 Front Panel Assembly

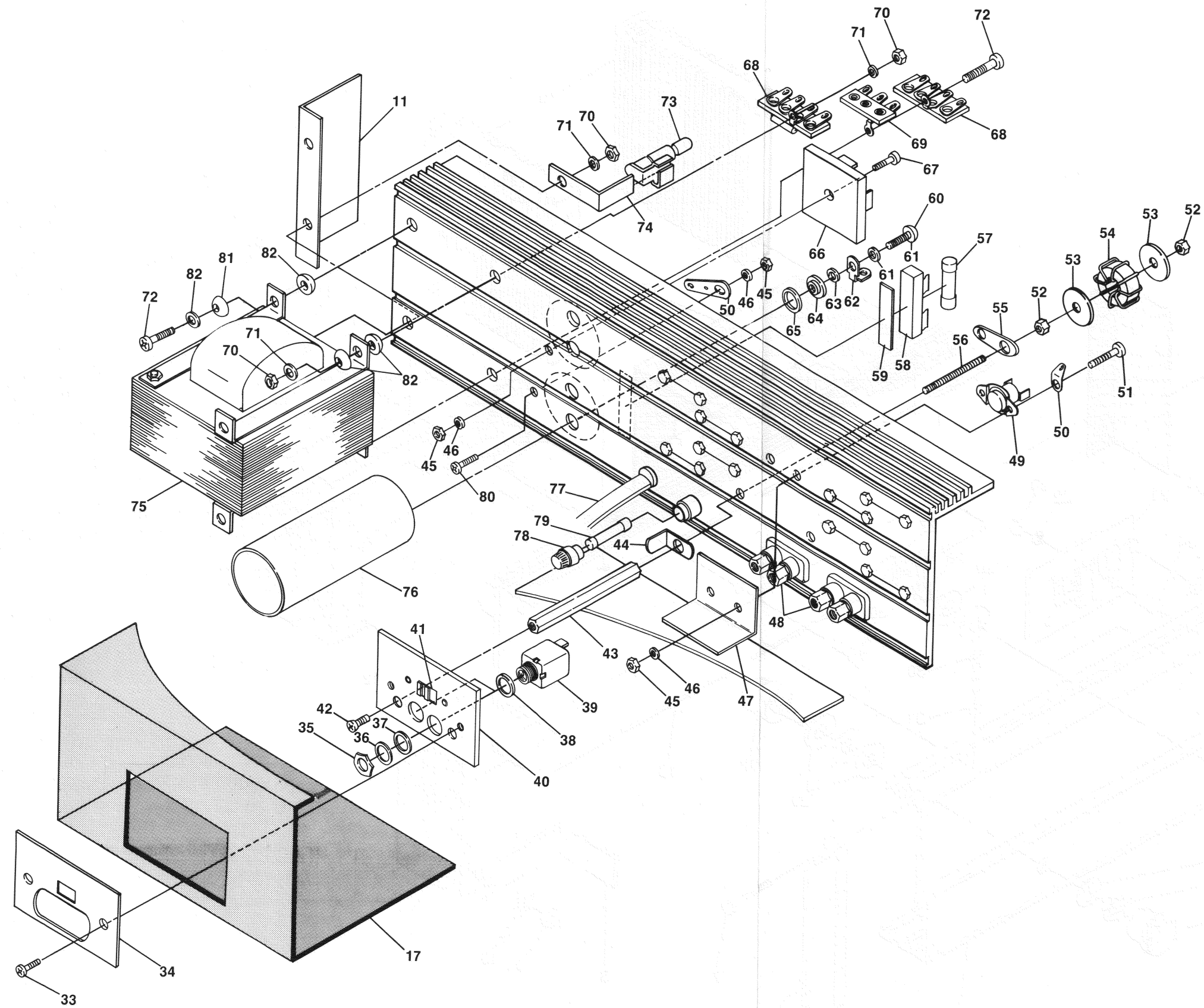

Fig. 6.17 Chassis Assembly

Parts List: D-150A Chassis Assembly

Index No.	Schematic Designation	Description	Crown Part No.	Qty.	Other Information
33		T8 32 .25 Machine Screw	C 2271-2	2	
34		Dress Plate	F 9594J6	1	
35		.375 Bright Nut	C 1288N7	2	
36		.625x.375x.030 Bright Washer	C 2189-6	2	
37		.625x.375x.015 Fiber Washer	C 1646-6	2	
38		.375 Fiber Shoulder Washer	C 1306-7	2	
39		2 Conductor Phone Jack	C 3423-8	2	
40		Jack Plate	F 9595J3	1	
41	SW3	DPDT Slide Switch	C 4110-0	1	
42		F8-32 .23 Machine Screw	C 2136-7	2	
43		Hex Standoff	D 3961-6	2	
44		Solder Lug #8 Hole	D 2935-1	2	
45		6-32 Hex Nut	C 1889-2	19	
46		#6 Internal Starwasher	C 5594-4	19	
47		Board Mount Bracket	F 9562-4	1	
48		Dual Binding Post	C 2823-0	2	
49		SPSTNC Thermal Switch	C 2799-2	1	
50		505 Solder Lug #6 Hole	D 3163-9	8	Misc. use
51		R6 32 .62 Machine Screw	C 3879-1	2	
52		8-32 Hex Nut	C 1986-6	2	
53		.875x.187 Fiber Washer	D 3669-1	4	
54		Output Inductor Assembly	M40959-5	2	
55		Solder Lug #8 Hole	D 2935-1	1	
56		8-32x1.75 Stud Screw	C 3324-8	2	
57	F2	MDX 7 Amp Fuse	C 4385-8	1	
58		Fuse Block	C 3776-9	1	
59		Pressure Sensitive Tape	S 1152-8	-	
60		T10 32 .50 Machine Screw	C 2049N2	4	
61		#10 Internal Star Washer	C 2279-5	8	
62		389 Solder Lug .218 Hole	D 2934-4	4	
63		.625x.234x.047 Steel Washer	C 4917-8	4	
64		5-16 Fiber Shoulder Washer	C 3320-6	4	
65		.730x.525x.187 Nylon Washer	C 1657-3	4	
66		MDA 3502 35A Bridge	C 4305-6	1	
67		R6 32 1.00 Machine Screw	C 2138-3	1	
68		2-G-1 Terminal Strip	D 3323-9	2	
69		3H2A Terminal Strip	D 5366-6	1	
70		10-32 Hex Nut	C 2170-6	4	
71		#10 Internal Star Washer	C 2279-5	8	
72		T10 32 .50 Machine Screw	C 2049N2	4	
73	L1	Lamp 1822 36V .1A	C 2900-6	1	On/off indicator
74		Lamp Bracket	F 9598-8	1	
75	T1	D-150A Power Transformer	D 4380-8	1	
76	C2, C3	9,400mF 50V	C 3309-9	2	
77		3-18 Power Cord	H40960-9	1	
78		HTA Fuseholder	C 3256-2	1	
79	F1	MDX 6.25 Amp Fuse	C 4307-2	1	
80		R6 32 .37 Machine Screw	C 2134C6	1	
81		Grommet .375 Grooved	C 1566-6	6	
82		#8 Type Plain Washers	C 2101-1	6	

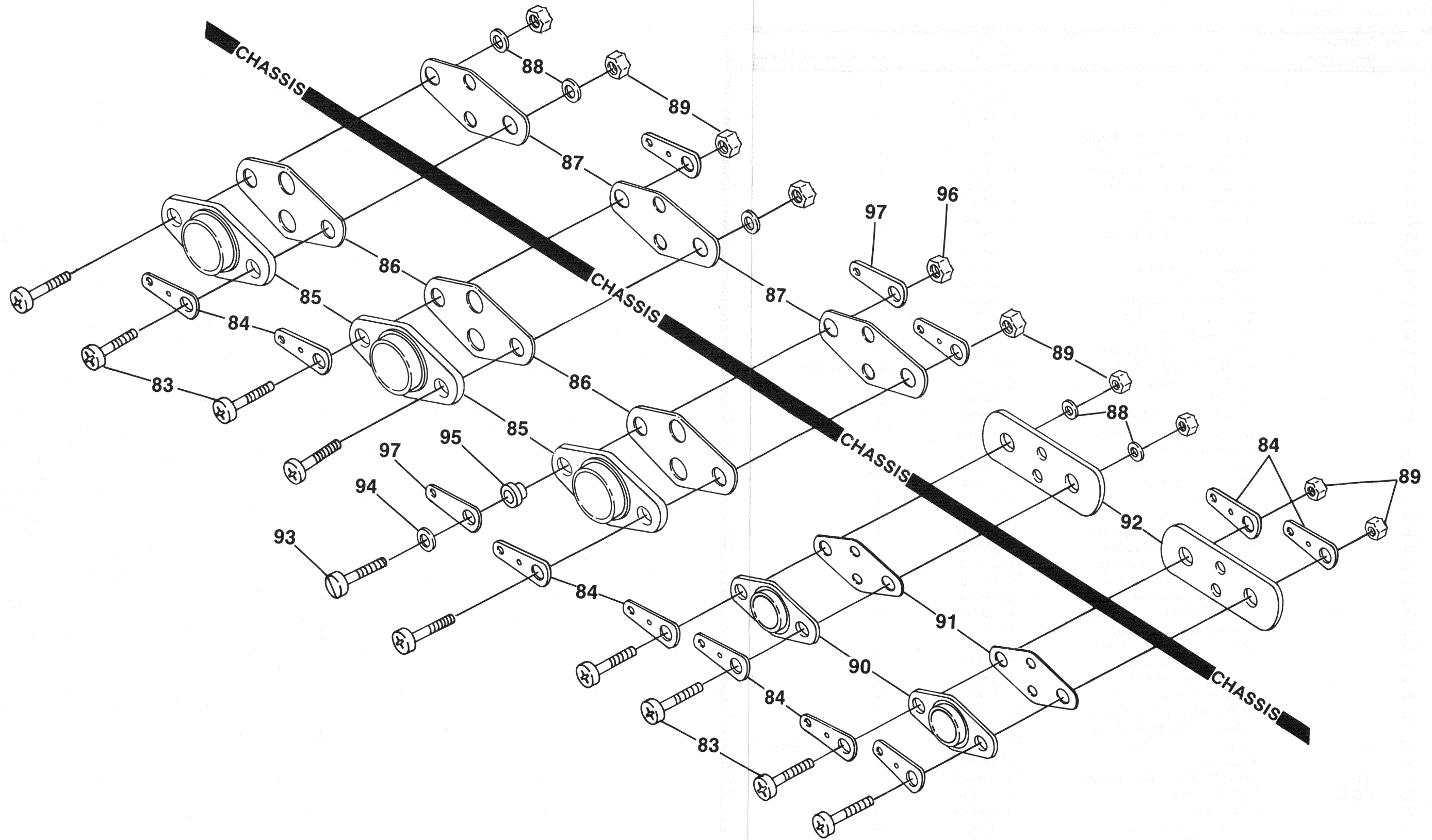

Fig. 6.18 Output Assembly

Parts List: Output Assembly

Index No.	Schematic Designation	Description	Crown Part No	Qty.	Other Information
83		R6 32 .62 Machine Screw	C 3879-1	9	
84		Solder Lug #6 Hole	D 3163-9	13	
85	Q110, Q210, Q114, Q214	2N5631 100V	C 3990-6	4	Outputs
86		Shoulder Insulator	C 4039-1	4	
87		T03 Insulator	D 4071-3	4	
88		#6 Internal Star Washer	C 5594-4	13	
89		6-32 Hex Nut	C 1889-2	13	
90	Q109, Q209, Q113, Q213	Sel 2N3585 NPN	D 3295-9	4	Drivers
91		TO-66 Aluminum Wafer	C 4352-8	4	
92		TO-66 Insulator	D 4113-3	4	
93		R440 .62 Machine Screw	C 3334-7	1	
94		#4 Internal Starwasher	C 1824-9	1	
95		Nylon Shoulder Washer	C 3335-4	1	
96		4-40 Hex Nut	C 1938-7	1	
97		Solder Lug .144 Hole	D 1220-9	2	

Parts List: Miscellaneous Assembly

Index No.	Schematic Designation	Description	Crown Part No.	Qty.
98	R133, R233	2.7 ohm 1W	C 1001-4	2
99	R132, R232, R134, R234	.1 ohm 5W	C 4761-0	4
100	C116, C216, C8	.1mF 200V Filmatic	C 2938-6	3
101	C115, C215	.22mF 100V Filmatic	C 3218-2	2

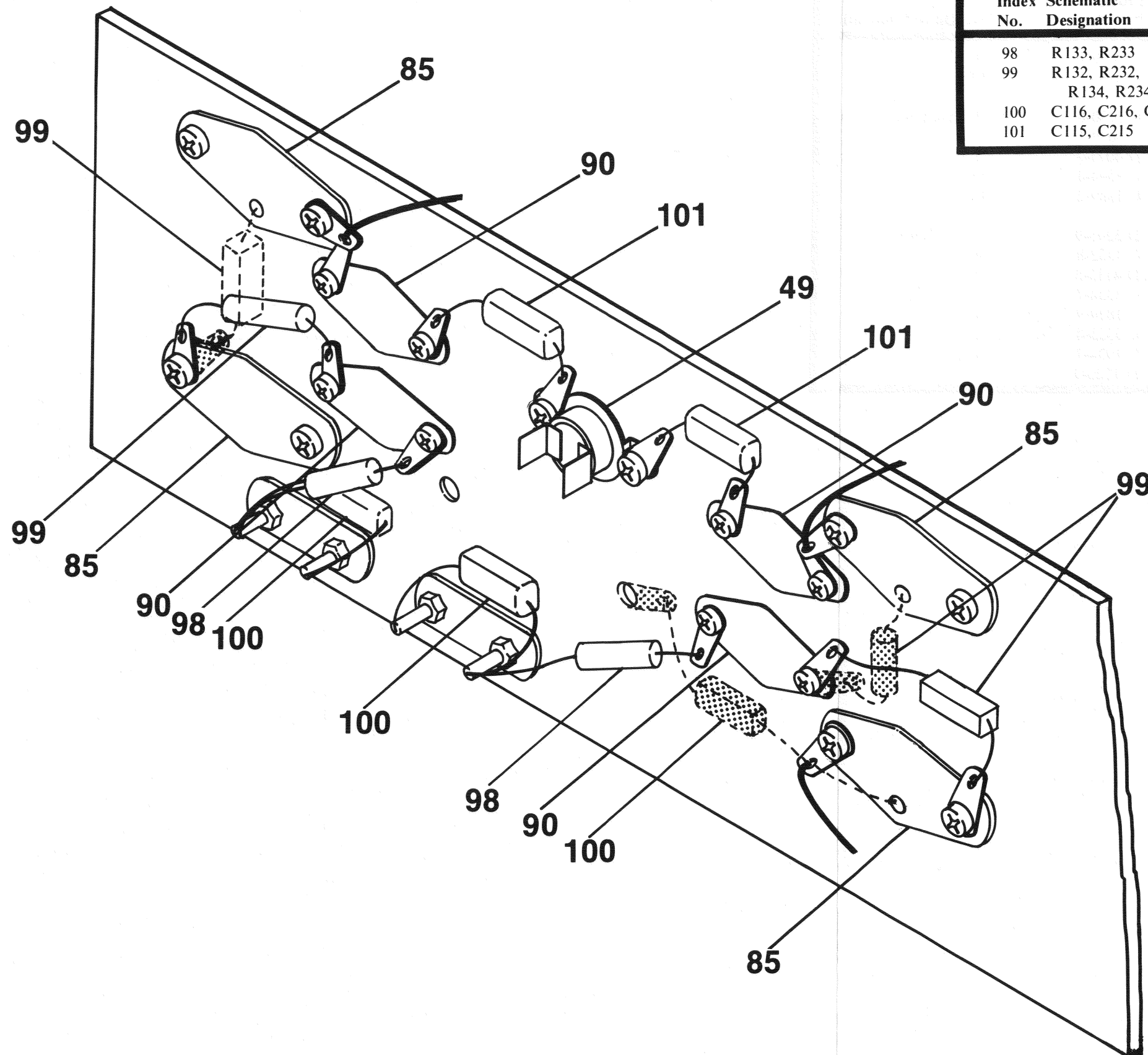

Fig. 6.19 Miscellaneous Assembly



SECTION 7 MAINTENANCE

7.1 Introduction

Section 7 contains technical information required to effectively and efficiently service and repair the Crown D-150A. Included are disassembly and reassembly procedures, required test equipment lists, checkout procedures, basic troubleshooting tips and a soldering technique review.

THIS INFORMATION IS INTENDED FOR USE BY AN EXPERIENCED TECHNICIAN ONLY!

Use this information in conjunction with the Instruction Manual, schematic/board layout diagrams, parts lists and exploded view drawings (the latter located in Section 6 of this manual).

7.2 Required Test Equipment

Many of the service and repair problems with the D-150A can be performed with a limited amount of test equipment. However, in order to return the unit to its "factory new" specifications, the following list of required test equipment is recommended. The "Requirements" column provides information to allow intelligent selection of substitutes if the "Suggested Supplier and Model" is not available or is considered impractical to obtain.

EQUIPMENT	REQUIREMENTS	APPLICATION	SUGGESTED MODEL
Oscilloscope	Capable of displaying a 10MHz signal	Monitoring output during service and testing	Tequipment D54A or equivalent
Volt-ohmmeter (VOM)	Low-voltage resistance probe (100mv range). High-voltage resistance probe (1.5V range)	Check resistance values (low voltage probe). Check semiconductor junctions for opens or shorts (high voltage probe) Check DC voltages	Triplett 601 or equivalent
Freq. Counter		For accurate general monitoring	Heath SM118A
Signal Generator	Sine/Square wave available; flat frequency response. THD. .1% maximum	Provide test signals for service and checkout	Wavetek 130-Series or equivalent
Circuit Breaker	15 ampere rating	In AC line to unit; protects circuitry from overload if power supply has shorted	
AC Line Voltage Monitor	Peak reading meter (displays rms equivalent to a sinusoidal peak for any wave form)	Monitor Line voltage	Available from CROWN

EQUIPMENT	REQUIREMENTS	APPLICATION	SUGGESTED MODEL
Phase Meter			
AC Voltmeter	100mv low range, flat frequency response to 100KHz	Set output level for testing; check noise level	Hewlett-Packard 400F or equivalent
Filter	20-20KHz bandpass, low noise 20Hz-20KHz	Between preamplifier and voltmeter in noise test	Information available from CROWN
Intermodulation Distortion Analyzer	Residual (.002% or lower)	Check IM distortion	Information available from Crown

7.3 Soldering Techniques

Note: Proper continuity between internal components of any electronic device is the key to its successful operation. Therefore, a brief review of the following discussion on soldering techniques may be in order. Because most service work involves component part(s) replacement, hand-soldering with the use of a soldering iron will be the only method covered, even though many exist.

The difference between success and failure in service repair is often determined by the thermal characteristics of an iron and how well it matches the job at hand. One would not use a large flat-head screwdriver to work on a delicate Swiss watch. Likewise, the proper size iron and tip should be used when soldering delicate electronic parts in position.

Iron wattage classification is actually not a very good method of choosing an iron. The reason for this is because of the possible inefficiency of heat transfer to the tip internally. A large wattage iron (125W) may, in effect produce lower tip temperatures than another iron smaller in wattage. Likewise, tip size and shape does not necessarily work in proportion to temperature. Therefore, it is impractical to compare soldering irons by their wattage but more feasible to refer to them by their maximum tip temperature.

Usually, the skilled service technician can pick the right iron and tip for the job from experience or recommendation. In most cases, the miniature or small electrical soldering iron will work well with delicate semiconductor devices (Fig. 7.1). When the proper size iron is used (usually around 700° F. tip temperature), a joint is almost instantly heated (approx. 500-550°) and application of iron and solder melting is simultaneous.

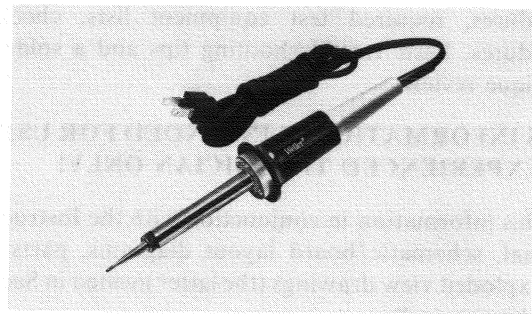

Fig. 7.1 Miniature Soldering Iron

When clean metal is exposed to air a chemical reaction takes place known as oxidation. When heat is applied to metal, oxidation is speeded up and creates a non-metallic film that prevents solder from touching the base metal. By applying a small amount of solder to a hot iron tip, a desirable process known as tinning occurs. The main reason for tinning an iron is to help prevent it from oxidizing as well as to aid in heat transfer. Tinning should be performed prior to each use as well as after long idling times.

To help prevent oxidation or remove existing oxidation while soldering, a natural rosin flux core solder should be used. Not only does flux aid in cleaning, but acts as a catalyst in that it helps speed up the joint formation without actually entering itself, into the bond. Never use an acid flux except to clean a highly oxidized tip that will not tin correctly. Crown recommends 63% tin/37% lead composition with a rosin flux core of 2.5% (melting temperature is approx. 361°F.).

Fig. 7.2 shows the correct and incorrect method of applying rosin flux core solder to a joint. Never apply solder to the iron tip directly and allow solder to run onto the joint (flux is burned away and does not clean the joints). Always apply heat to the connection and allow the joint to melt the solder, not the iron. This insures proper wetting and flow of the solder.

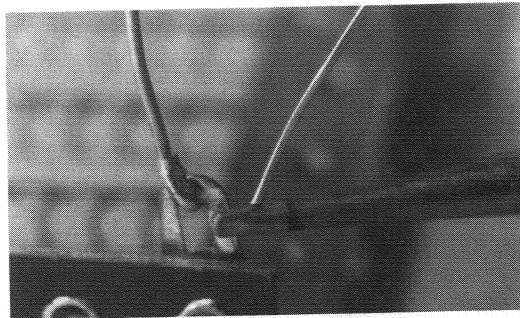
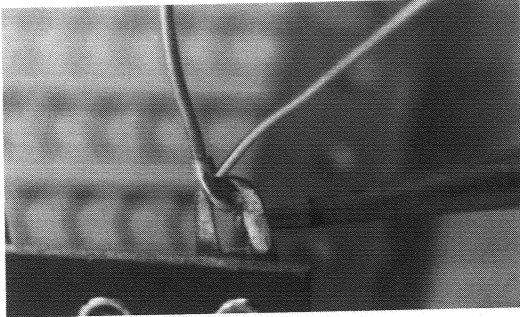

Fig. 7.2 Correct and Incorrect Solder Application

Problem: Unsoldered wire.

Characteristics: Properly assembled junction of wire, but without any solder.

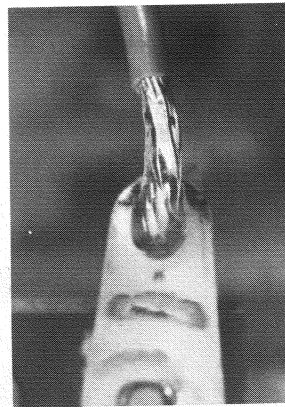

Fig. 7.3 Unsoldered Wire

Cause: Solder not applied.

Remedy: Correct amount of solder applied properly.

One of the main advantages of using solder to make connections is that it is one of the few joining methods responsive to visual examination. This permits 100% inspection, while other methods require sampling and lengthy electrical tests. With proper inspection of materials used, soldering is the most reliable, time-improved, and versatile form of electrical joining offering the benefits of economy, dependability and speed.

A good solder joint will have the following recognizable features:

- a) Proper wetting - mixing of molecules to form a singular, shiny bond of metal
- b) Proper flow - feathering out of solder
- c) Proper contour - outline of wire under solder
- d) Proper fillet - solder filling in holes and crevices.

Because visual inspection is an important part of recognizing a good solder joint, the following examples have been provided to help with familiarization.

Problem: External strands.

Characteristics: One or more strands of wire outside terminal. This defect most common when cup-type terminals are utilized.

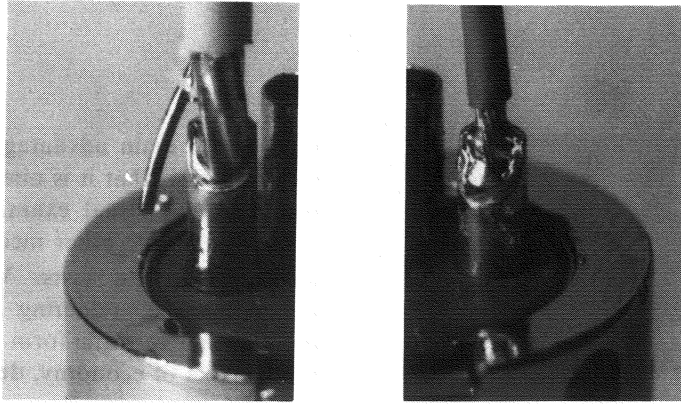

Fig. 7.4 External Strands

Cause: Poor assembly operation, too large diameter wire used.

Remedy: Correct diameter wire tinned prior to insertion.

Problem: Cut strands.

Characteristics: Several strands of wire cut or broken and usually not soldered to terminal.

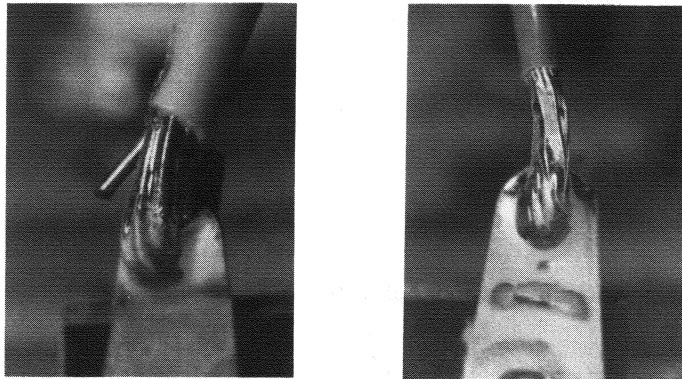

Fig. 7.5 Cut Strands

Cause: Improper wire stripping; wire flexed or bent excessively during or after assembly.

Remedy: Use wire strippers similar to the one shown in Fig. 7.6 . Care must be taken to avoid nicking or cutting.

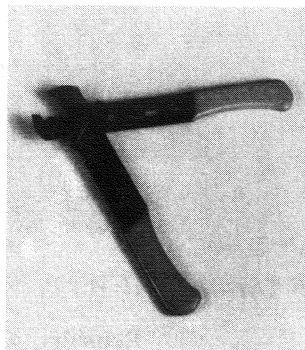

Fig. 7.6 Wire Strippers

Problem: Disturbed joint.

Characteristics: Rough appearance with questionable adhesion.

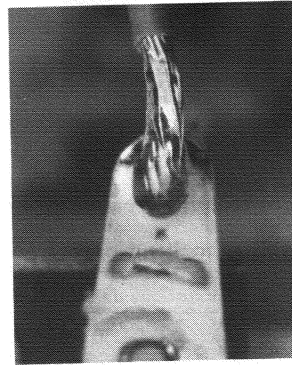
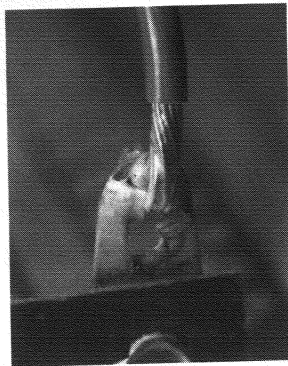

Fig. 7.7 Disturbed Joint

Cause: Movement of wire/joint during cool-off stage.

Remedy: Use of holding vice or similar tool to help prevent movement.

Problem: Cold solder joint.

Characteristics: Joint with dull, frosty appearance; often has poor adhesion as well as imperfect shaping.

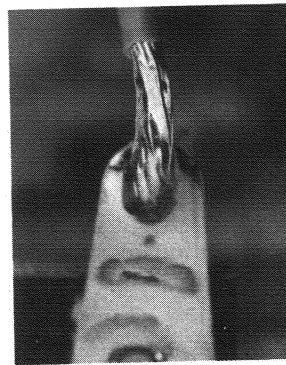

Fig. 7.8 Cold Solder Joint

Cause: Too much heat applied (flux is boiled off before oxide removal action takes place).

Remedy: Correct matching of iron/tip to specific job.
Correct solder flux combination is also important.

Problem: Rosin joint.

Characteristics: Joint is separated by a thin coat of flux producing high resistance to current.

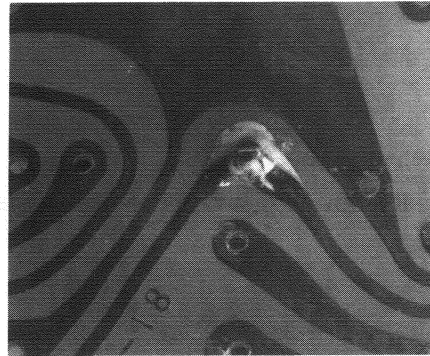
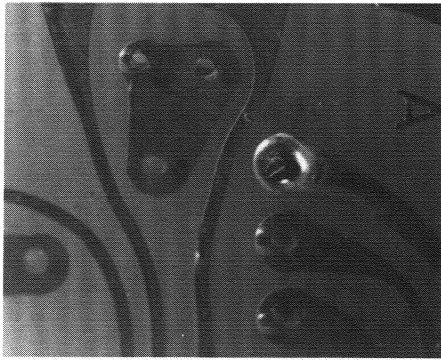

Fig. 7.9 Rosin Joint

Cause: Solder applied previous to terminal reaching minimum temperature (solder melting point).

Remedy: Apply correct amount of heat; remove only after good wetting and fillet is achieved.

When soldering individual component parts to printed circuit boards, several procedures may be followed. The following procedure complies to U.S. Government standards and may be altered to suit a specific situation.

1. Components leads should be bent to exact spacing of mounting holes in PC board (Fig. 7.10). This allows leads to enter PC board at right angles and relieves stress.

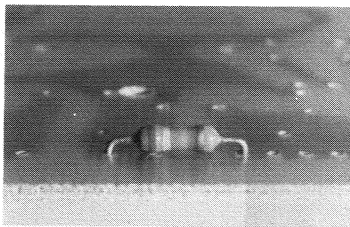

Fig. 7.10 Component Lead Spacing

2. Leads should be bent down tight to pad.

3. Leads should be bent in the direction of the run connected to the pad and clipped at a length approximately $\frac{1}{8}$ " (Fig. 7.11).

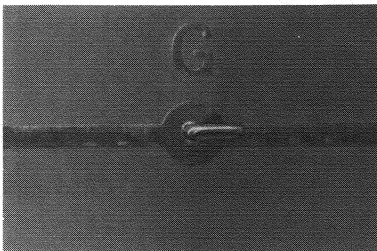

Fig. 7.11 Component Lead Bending

4. Components should be held tight to the PC board while clinching leads on other side (Fig. 7.12) and soldered accordingly. Fig. 7.13 shows acceptable solder joints.

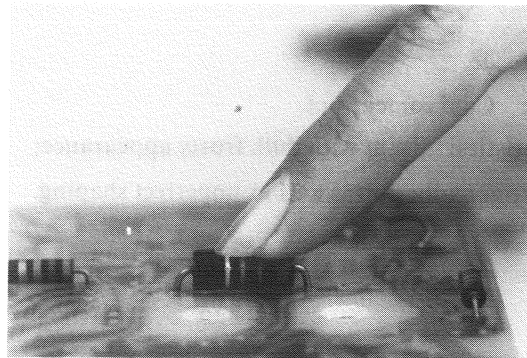

Fig. 7.12 Correct Pressure Applied

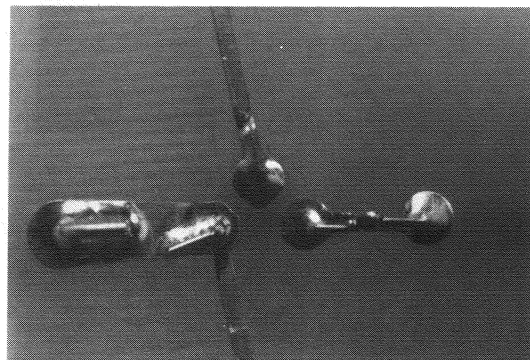

Fig. 7.13 Acceptable Solder Joints

When soldering to lugs (as on potentiometers), the mechanical wire wrap should be a J hook with correct insulation clearance as shown in Fig. 7.14.

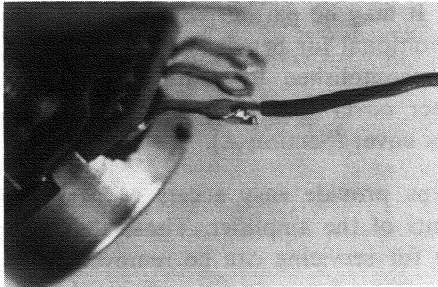

Fig. 7.14 Soldering to a Lug

Turret terminals also utilize the “J” hook (Fig. 7.15). Concentrate on good heat transfer to the terminal first, then the wire. If two wires are to be soldered, be sure of good solder flow to all three.



Fig. 7.15 Turret Terminal

Desoldering

In order to replace a component part, it is often necessary to remove the old part by means of de-soldering. Several methods are available, the most common being the braided bare copper method. This wire is placed on the lead(s) of the component to be removed with the iron placed on top of the braided wire. This allows the solder to heat up while simultaneously adhering to the braid. When the braided wire is removed, the joint should be clean. (See Fig. 7.16)

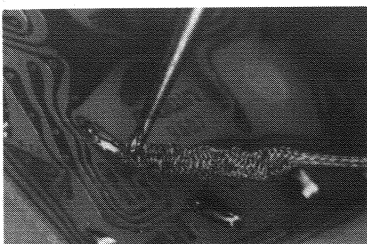

Fig. 7.16 Wire Braid Desoldering

Next, use points of small diagonals to lift ends of component lead wires and remove the part. This procedure is applicable to both PC board desoldering as well as terminal and lug desoldering.

Note: Be sure that lifting of the component lead does not also lift the copper foil pad from the board. Occasionally a small amount of heat will be helpful.

Soldering is one of the most reliable methods of joining electronic component parts and assemblies. When properly used, it can be one of the most helpful tools in service repair work.

7.4 Basic Troubleshooting

As is well known, time is an important factor in providing efficient service repair. Therefore, several time-saving troubleshooting steps are listed below. These hints may or may not already be implemented in your service work. If not, you may wish to experiment with them in order to help improve your efficiency. After all, time is money!

A. Establishing Problems

User complaints about defective operation may not always be clear or simple. Furthermore, the trouble the user has experienced may be due to the system and not the unit itself. If possible talk to the user about his problem. This will usually be simpler than trying to understand written complaints. A first hand account of the problem can help in:

- 1) Getting the problem to re-occur on the service bench.
- 2) Getting an understanding of the probable cause. Some troubles will be obvious upon visual inspection. When the trouble (or its symptoms) is not so obvious ask:

- a) Exactly what was the problem; how was it noticeable?
- b) How was the unit being used?
- c) Has the system as a whole been carefully examined for possible external problems?
- d) How long had the unit been operating when the problem occurred? Was it heat related?

If the user is unavailable or unable to explain the trouble the next step is a thorough visual inspection.

B. Visual Inspection

A good visual inspection may often save hours of tedious troubleshooting. Make a habit of proceeding in an orderly manner to insure that no vital part of the

following procedure is omitted. The visual inspection can be performed in 10 to 15 minutes. It is recommended both as a preventive maintenance procedure and also for its value in determining cause of malfunction.

- 1) Check that all external screws are tight and that none are missing.
- 2) Check all fuses/circuit breakers.
- 3) Check for smooth and proper operation of switches, etc.
- 4) Inspect line cord for possible damage to cap, jacket and conductors.
- 5) Remove protective covers as outlined in disassembly instruction (Section 7.6).
- 6) Check that all attaching parts for internal circuits are tight and that none are missing.
- 7) Inspect all wiring for charred insulation, or discoloration as evidence of previous overheating.
- 8) Check that all electrical connections are secure. This includes wire terminals, screw and stud type terminals, and all soldered connections.
- 9) Check for obvious destruction of internal structural parts. Distortion in any of these parts could mean that the unit has been dropped or subjected to severe shock.

7.5 Discharging Instructions

The D-150A amplifier employs very large-storage capacitors in the main power supply (C2, C3). For this reason, at any time the covers are removed it is necessary to discharge these large capacitors in order to avoid possible damage to the unit and also to prevent shock hazard. This is best performed by placing a 50 ohm/10 watt resistor across capacitor terminals shown in Fig. 7.17. Always use extreme caution while handling the discharge device.

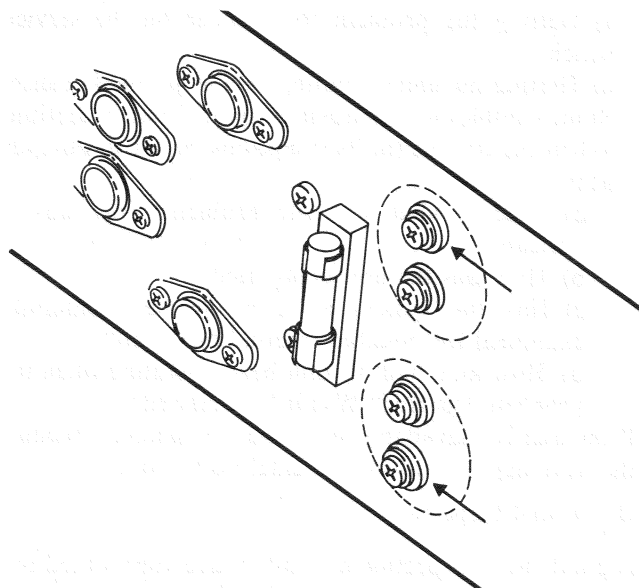

Fig. 7.17 D-150A Discharge Points

7.6 Disassembly for Inspection, Service, Testing, Adjustment and Repair

The extent of disassembly required will depend upon the extent of inspection, service, testing, adjustment and repair to be performed. Illustrations referred to in parenthesis (index numbers) are located in the parts list (Section 6) of this manual.

The D-150A amplifier is specifically designed for easy servicing. It may be partially disassembled and still be made operational for bench testing and servicing. This may be accomplished by removing the front panel, transformer cover and wrap-around, and the board electronics cover (Section A).

These steps provide easy access to nearly all major components of the amplifier. Those that are not now accessible for servicing can be removed following the procedures given for replacing individual assemblies.

Caution: DO NOT attempt component replacement or other repairs with power applied. Always follow discharging instructions (Section 7.5) to prevent possible circuit damage or serious shock.

A. Removal of Front Panel, Transformer Cover and Wrap-Around, and Board Electronics Cover

1. Remove four socket head screws (7), two from each end of the rack ears (6), and remove the six phillips front panel mounting screws (30).
3. Remove two screws (15) from the top of the transformer cover (14), and remove the transformer cover and the transformer wrap-around (13).
4. Remove two screws (33) from the top of the board electronics cover (17) and remove the cover.
5. Reverse the above sequence of actions to reassemble the amplifier covers.

B. Removal of Control Plate Assembly

1. Remove board electronics cover (17) as described in paragraph A, Step 4.
2. Remove two screws (42) from top of control plate assembly.
3. Carefully lift control plate assembly and turn nearest edge (where screws were removed) upward until bottom of control plate is accessible. Do not place unnecessary strain on wiring connected to main PC board.
4. Input jacks (39) are now accessible for replacement.

C. Replacement of Components on Main PC Board

1. Remove board electronics cover (paragraph A, Step 4). Both component and solder sides of board are now accessible.
2. Carefully unsolder and replace (with identical parts) any defective components.



Caution: Use normal soldering precautions. DO NOT use excessive heat; heatsink adjacent components to prevent damage.

3. The IC is a plug-in component.
 4. Resistors R128, R228 (selected bias resistors) are plug-in components.
- D. Replacement of Input Level Potentiometers (R105, R205)
1. Remove board electronics cover, paragraph A, Step 4.
 2. Remove front panel, paragraph A, Step 2.
 3. Unsolder and tag for identification all leads to the terminals of input level potentiometer (27).
 4. Remove control nut (2) using a 1/4" nut driver and remove defective R105 and R205 from the front panel (5).
 5. Solder leads removed in Step 3 to terminals of new input level potentiometer (27).
 6. Place new potentiometer in position and replace control nut (2).
 7. Replace the front panel.
 8. Replace board electronics cover, paragraph A.
- E. Replacement of Thermal Switch, SW-1
1. Remove front panel (paragraph A, Step 2).
 2. Remove board electronics cover (paragraph A, Step 2).
 2. Remove board electronics cover (paragraph A, Step 4).
 3. Disconnect two Faston connectors from terminals of thermal switch SW-1.
 4. Remove two each, screws (51), hex nuts (45), star washers (46), solder lugs (50) and remove thermal switch SW-1 from the chassis.
 5. Place new thermal switch SW-1 (49) in position and replace hardware removed in Step 4.
 6. Reconnect two Faston connectors to terminals of new thermal switch SW-1.
 7. Replace board electronics cover (paragraph A, Step 4).
 8. Replace front panel (paragraph A, Step 2).
- F. Replacement of Bridge, DM-1
1. Remove transformer cover and transformer wrap-around (paragraph A, Step 3).
 2. Remove front panel (paragraph A, step 2).
 3. Disconnect four Faston connectors from terminals of bridge DM-1 (66).
 6. Reconnect four Faston connectors to terminals of bridge DM-1.
 7. Replace front panel (paragraph A, Step 2).
 8. Replace transformer cover and transformer wrap-around (paragraph A, Step 3).
- G. Replacement of Filter Capacitors, C2 and C3
1. Remove front panel (paragraph A, Step 2).
 2. Remove transformer cover and transformer wrap-around (paragraph A, Step 3).
 3. Remove one Faston connector from filter capacitor (C2 or C3) terminal.
 4. Remove two screws, (60), one solder lug (62), two panel washers (65) and two fiber shoulder washers (64) from the filter capacitor terminals.
 5. Remove defective filter capacitor (C2 or C3) from the chassis.
 6. Place new filter capacitor in position and replace hardware removed in Step 4.
 7. Reconnect Faston connector to filter capacitor terminals.
 8. Replace transformer cover and transformer wrap-around (paragraph A, Step 3).
 9. Replace front panel (paragraph A, Step 2).
- H. Replacement of Output Inductors, L101 and L201
1. Remove front panel (paragraph A, Step 2).
 2. Remove board electronics cover (paragraph A, Step 4).
 3. Unsolder one end of brown coil wire from the output binding post terminal and the other end from the adjacent driver transistor terminal.
 4. Remove hex nut (52), nylon washer (53) output coil toroid core and brown wire (54).
 5. Place new output coil toroid core and new brown wire in position and replace hardware removed in Step 4.
 6. Solder one end of brown coil wire to the output binding post terminal (55) and the other end to the adjacent driver transistor terminal.
 7. Replace board electronics cover (paragraph A, Step 4).
 8. Replace front panel (paragraph A, Step 2).

I. Replacement of Driver and Output Transistors

1. Remove front panel (paragraph A, Step 2).
2. Remove board electronics cover (paragraph A, Step 4).
3. Unsolder and tag for identification all wires and component leads connected to transistor terminals. DO NOT unsolder leads attached to solder lugs mounted on transistors.
4. Refer to detail drawings of output and driver transistor and remove hardware shown and the defective transistor.
5. Coat both sides of the insulator (86, 91) between the transistor case and the chassis with a heat-conducting compound (Z5 silicon compound).
6. Install new transistor and tighten screws and hex nuts snugly to assure good heatsinking.
7. Resolder wires and component leads removed from transistor terminals in Step 3 above.
8. Replace board electronics cover (paragraph A, Step 4).
9. Replace front panel (paragraph A, Step 2).

J. Replacement of Power Transformer, T-1

1. Remove front panel (paragraph A, Step 2).
2. Remove transformer cover (14) and transformer wrap-around (13) (paragraph A, Step 3).
3. Disconnect seven transformer wires that pass through the hole in the chassis beside the transformer base.
 - a. Two red wires; remove Faston connectors from DMI terminals and remove Faston connectors from the red wires.
 - b. One yellow wire; unsolder from solder lug (62) at junction of capacitors C2 and C3.
 - c. One black and one white wire; unsolder from terminal strip (68).
 - d. One black/red wire and one black/white wire; unsolder from terminal strip (68).

4. Pull all wires back through hole in chassis.
5. Remove hardware securing transformer T1 to the chassis:
 - a. Remove four hex nuts (70).
 - b. Remove four star washers (71).
 - c. Remove pilot light assembly (73, 74).
 - d. Remove terminal strip (68).
 - e. Remove rubber grommets (81).
 - f. Remove four transformer mounting screws (72).
6. Remove defective transformer T1 (75).
7. Cut leads on new transformer T1 to same length as those on the transformer being replaced.
8. Place new transformer T1 in position on the chassis and replace, in reverse order, all item removed in Step 5.
9. Pull all transformer wires through chassis hole to bottom side of chassis.
10. Connect seven transformer wires to destinations shown in Step 3 (also see Section 7.10).
11. Replace transformer cover and transformer wrap-around (paragraph A, Step 3).
12. Replace front panel (paragraph A, Step 2).

7.7 Reassembly

Reassembly is essentially the reverse of disassembly. If in doubt about types and sizes of attaching parts, refer to the appropriate illustration in Section 6.

7.8 Electrical Checkout and Adjustment Procedures

The following chart outlines an orderly checkout and adjustment procedure for the D-150A. The test equipment required to perform the various procedures is listed in Section 7.2.

Type of Test/Adjustment	Input Signal Characteristics
1. Quiescent DC offset	None
2. Bias Adjustment	None
3. Power Test (one channel driven)	1 volt; 1 KHz sine wave

Comments

A. DC millivolt meter is connected to amplifier output. Input level controls are fully counterclockwise while offset controls (R105, R205) are adjusted for zero volts at output.

B. Input level controls are at twelve o'clock (or adjusted for maximum DC offset). Offset controls (R103, R203) are adjusted for zero volts at output.

Positive output, base-emitter junction should be between .3V and .35V. It is altered by selected resistors R128, R228; they are typically between 92 and 240 ohms.

Into 8 ohms, 28Vrms (98 watts) should be obtainable before signal clip. Into 4 ohms, 26.5 Vrms (175 watts) should be obtainable before signal clip.

- | | | | |
|----|----------------------------|--|---|
| 4. | Protection Circuitry | 1 volt; 1KHz
sine wave | Into 2 ohms, 39Vrms should be obtainable before signal clip without a load. |
| 5. | High Frequency | 1 volt; 10KHz
square wave
1 volt; 20KHz
sine wave | Into an 8 ohm load, a 30 volt peak-peak square wave signal should exhibit no ringing.
Into an 8 ohm load, a 27Vrms signal should exhibit no ringing. |
| 6. | Intermodulation Distortion | .5V \pm 2%; 60Hz-
7KHz signal
summed in 4:1
ratio | (See Fig. 7.18) When using the Crown IMA, typical readings will be as follows:
0dB = .004% (20 volts out)
through -25dB = .01%
through -40dB = .03%
Note: All distortion readings must be below .01%. |
| 7. | IOC | 2.5V peak-peak
.5Hz square wave | IOC lights should illuminate once for every rise time and once for every fall time (twice every full cycle). Test generator rise time must be less than 1.0 microsecond. |
| 8. | Signal to Noise | | (See Fig. 7.19) Signal to Noise should be 115dB below rated output with meter bandwidth of 20Hz to 20KHz. |
| 9. | Quiescent AC Power | | 30 watts at idle as monitored by wattmeter on AC line;
250 watts full rated output. |

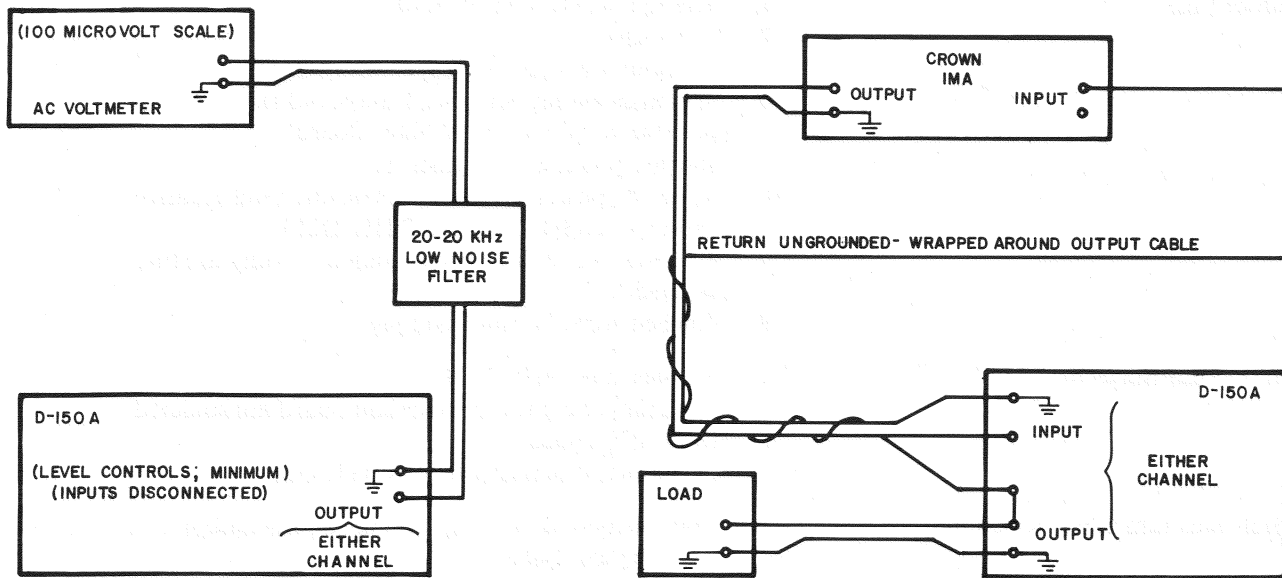

Fig. 7.18 IM Distortion Test Set-up

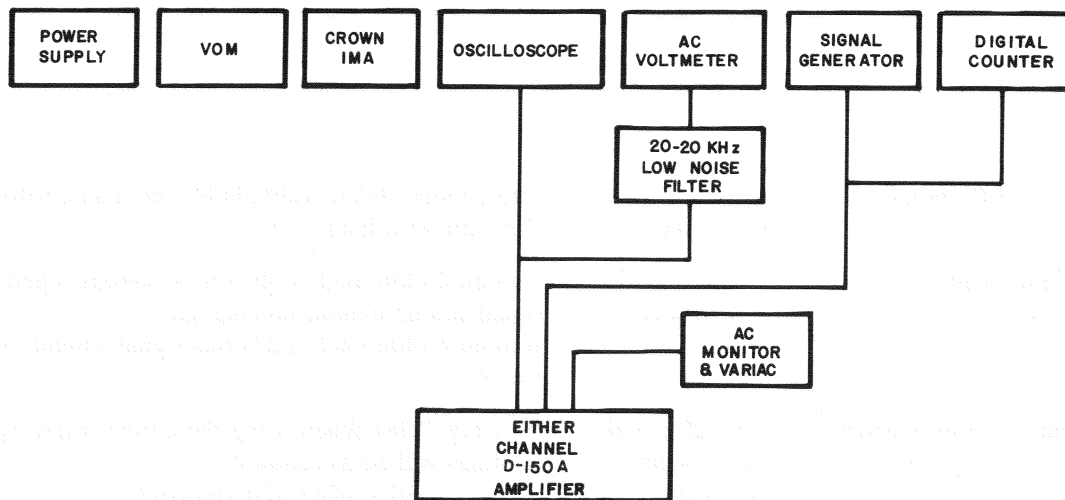

Fig. 7.19 Signal to Noise Test Set-up

7.9 Troubleshooting Hints

Symptom

Defect

Blows Fuse

1. Rectifier block shorted, DM 1
2. C1 shorted
3. Leaky or shorted filter capacitors C2, C3
4. Bootstrap supply AC wire frayed and shorts to positive supply trace on Main Board
5. Shorted power transformer T1
6. A shorted power device in both positive and negative output stage Q110, Q114, Q210, Q214
7. Fuse blown due to external problem - wrong size fuse inserted
8. Pinched wires in power supply

No Output Stage Bias

1. No bias resistor R128, R228
2. Bias resistor connector to circuit board not soldered
3. L100, L200 open
4. C-E short of bias transistor Q111, Q211

High Bias (amplifier heats up)

1. Amplifier instability-high frequency oscillation (check Q106, Q206)
2. Shorted output terminal post
3. DC offset (see offset section)
4. Leaky output device (may pass signal and show okay with continuity test) Q110, Q114, Q210, Q214



Symptom	Defect
Negative Offset -Both Channels-	<ol style="list-style-type: none"> 1. Defective IC op amp (UA739) 2. D5 shorted 3. Q101, Q201 leaky or shorted
Positive Offset -Both Channels-	<ol style="list-style-type: none"> 1. Defective IC op amp (UA739) 2. D4 shorted
Positive Offset -Single Channel-	<ol style="list-style-type: none"> 1. Defective IC op amp (UA739) 2. Q100, Q200 leaky or shorted 3. Q101, Q201 open 4. Q106, Q206 open, leaky or shorted 5. Q105, Q205 open leaky or shorted 6. Positive predriver, driver or output device leaky or shorted Q107, Q207, Q109, Q209, Q110, Q210 7. Q111, Q211 shorted
Negative Offset -Single Channel-	<ol style="list-style-type: none"> 1. Defective IC op amp (UA739) 2. Mono switch hot wire shorted to ground 3. Negative predriver, driver or output device leaky or shorted Q112, Q212, Q113, Q213, Q114, Q214 4. Q101, Q201 base to collector leakage
Small DC Offsets	<ol style="list-style-type: none"> 1. Broken ground on input level control (R105, R205) 2. Input jack hot lead and ground pin not shorted together (level controls full up with no input jack) 3. D100, D200 leaky or shorted
Negative half of Signal missing	<ol style="list-style-type: none"> 1. Q112, Q212 open 2. Violet/white wire from main board to output board open or not soldered
Positive half of Signal missing	<ol style="list-style-type: none"> 1. Bootstrap supply <ol style="list-style-type: none"> a. C4 open b. D1 or D2 shorted c. Green AC wire not soldered correctly 2. Q101, Q202 open 3. Loss of positive supply voltage (+45V) 4. D3 shorted 5. Q108, Q208 open, leaky or shorted 6. Q107, Q207 open 7. R132, R232 open 8. Yellow/white wire from main board to output board open or not correctly soldered
Oscillation (Full waveform)	<ol style="list-style-type: none"> 1. R106, R206 open 2. C116, C216 open
Oscillation (Positive half)	<ol style="list-style-type: none"> 1. Defective IC op amp (UA739) 2. Defective driver, Q109, Q209 4. C113, C213 open

Symptom	Defect
Oscillation (Negative half)	<ol style="list-style-type: none"> 1. Defective IC op amp (UA739) 2. C112, C212 defective 3. Defective driver, Q113, Q213
Protection Circuit - No current limiting	<ol style="list-style-type: none"> 1. Current limiting transistor open <ol style="list-style-type: none"> a. Positive (Q103, Q203) b. negative (Q104, Q204) 2. D101, D107, D201, D207 open 3. R119, R118, R219, R218 open 4. C108, C109, C208, C209 open
-Excessive limiting	<ol style="list-style-type: none"> 1. D101, D107, D201, D207 shorted 2. Q104, Q103, Q204, Q203 shorted 3. Loose output hardware
-Current limiting oscillation-	<ol style="list-style-type: none"> 1. Negative feedback capacitor, in limiting transistor circuit defective, positive C107, C207, negative C110, C210
-Flyback pulses from inductive loads -	<ol style="list-style-type: none"> 1. C108, C109, C208, C209 open
Clipping (negative) Both Channels	<ol style="list-style-type: none"> 1. D5 leaky or open 2. Q2 leaky or open 3. Defective IC op amp (UA739)
Clipping (positive) Both Channels	<ol style="list-style-type: none"> 1. D4 open or leaky 2. D3 open or leaky 3. Defective IC op amp (UA739) 4. D1 or D2 open (positive portion of signal will clip at a 60Hz rate) 5. C4 open or changed in value
Clipping (positive) Single Channel	<ol style="list-style-type: none"> 1. Open or leaky predriver, Q107, Q207 2. Shorted or leaky limiting transistor Q103, Q203 3. Open output emitter resistor R132, R232 4. Defective IC op amp (UA739) 5. Q102, Q202 defective
Clipping (negative) Single Channel	<ol style="list-style-type: none"> 1. Open or leaky predriver Q112, Q212 2. Shorted or leaky limiting transistor Q104, Q204 3. L100, L200 open 4. Open output emitter resistor R134, R234 5. Q115, Q116, Q215, Q216 on IOC board defective
High IM (Load Related)	<ol style="list-style-type: none"> 1. R9 (1 ohm) open 2. Defective IC op amp (UA739) 3. C101, C201 open 4. C114, C214 open 5. Q106, Q206 defective 6. Defective predriver or driver device Q107, Q207, Q112, Q212, Q109, Q209, Q113, Q213
Low dB IM	<ol style="list-style-type: none"> 1. Low output Bias 2. C102, C202 open 3. C104, C204 open



Symptom

Defect

High IM (Not Load Related)

1. R115, R215 changed in value
2. R109, R209 changed in value
3. C105, C205 changed in value
4. C106, C206 changed in value

120Hz in output waveform

1. Power Supply filter capacitor(s) open, C2, C3
2. C5 open
3. Power Supply filter capacitor mounting hardware loose

High noise

1. Input jacks not isolated from chassis ground
2. Noisy zener diode, D3
3. Broken ground on input jack, in input cable or on input level control (R105, R205)
4. Oscillation (C101, C201 open)

7.10 Voltage Conversion Instructions

Often Crown products are purchased in one country and later transported to another requiring an AC mains conversion. For this reason the following chart/explanation as well as a world-wide voltage map (in the rear of this manual) is provided.

The D-150A power supply may be connected for any of five voltages. Converting from one to another can be accomplished with a soldering iron and a pair of wire strippers. Observe the following instructions:

1. Remove the two rack ears from the front panel.
2. Remove the front panel/bottom cover (See Section 7.6A).
3. Position the front panel to gain access to the transformer leads. Locate the two terminal strips (terminals A,B,C, D and E).
4. Determine the correct connection from Fig. 7.20 and solder the leads accordingly.
5. For all connections 200VAC and above, the line fuse F1 is changed from 6.25 amps to 3 amps.
6. Carefully check all connections, then repeat steps 1 and 2 in reverse.

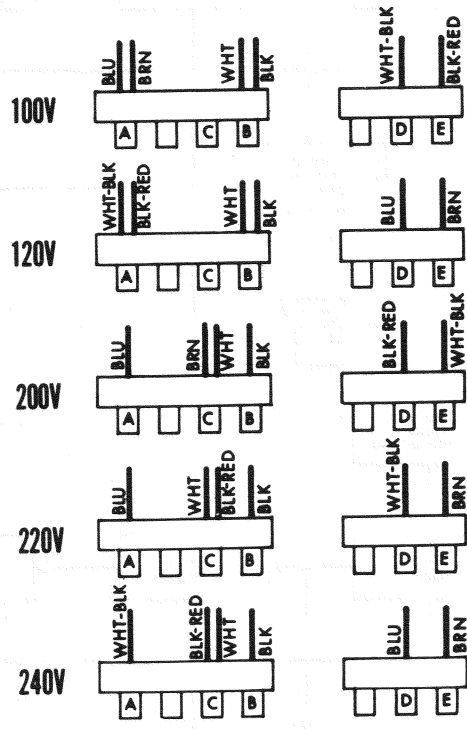

Fig. 7.20 Voltage Conversion

7.11 Block Diagram Circuit Theory

The following discussion refers to the block diagram in Fig. 7.21.

The input amplifier is the initial stage of circuitry that establishes the fixed gain of the D-150A. The input bias compensation stage, directly related to the input stage, helps control any DC drift that may occur with a unique temperature-controlled circuit.

The IOC (Input Output Comparator) circuitry works in conjunction with the error correcting signal of the main op amp. Any time a small "non-linearity" exists in the amplifier, an error signal appears at the output of the main op amp (via the feedback loop of the unit). This produces an abnormally high value, exceeding the "window" of the IOC and illuminating the LED. Since transient overload can happen rapidly, a pulse stretching circuit is added so the eye can detect the LED lighting.

The signal translator stage combined with the last voltage amp form the voltage amplification stages of the D-150A. Virtually no voltage amplification is performed beyond these stages.

Current amplification circuitry consists of basically three stages: the Predriver, the Driver and the output transistor stage. Connected to these stages, is the protection circuitry which is activated when a predetermined amount of voltage and/or current is drawn across the output stage sense resistors. This protection signal is then in turn fed back to the limiting circuit which limits any increase in the bias servo voltage to the power devices.

The power supply is a continuous-duty type. The main DC supplies are full-wave capacitor input type with heavy duty, chassis heat-sinked diodes. The input amplifiers are powered by zener-regulated power supplies. The bias regulators are also powered by zener-regulated current sources with the result that line voltage variations do not cause noise or distortion due to mis-biasing.

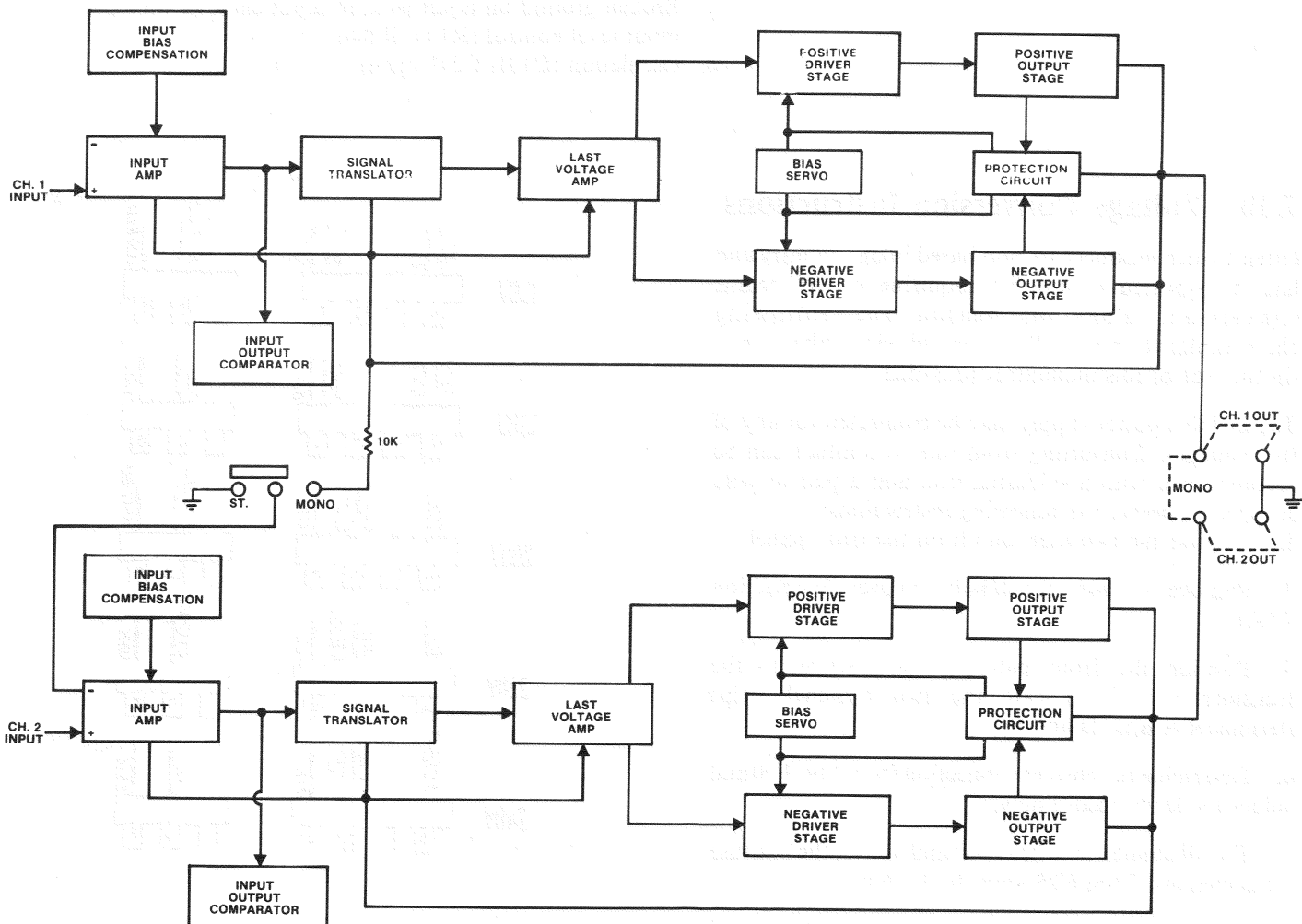

Fig. 7.21 D-150A Block Diagram

7.12 Theory of Operation

The following explanation refers to schematic diagram MI-261E located in Section 6. However, each circuit under discussion is reprinted below in order to aid in circuit familiarization. Only channel 1 is shown for simplicity.

A. Input Stage

After entering the unbalanced 1/4" input jack, the input signal level is adjusted to a desired input amplitude through R105 and then applied to the dual IC operational amplifier (IC1A, IC1B). This op amp is a low noise, large gain bandwidth type which results in usage of feedback circuit loops throughout and ultimately, extremely low distortion values. The direct input signal is applied to the non inverting input (pin 5) of IC1A and the feedback signal is applied to the inverting input (pin 6).

Both signals entering IC1A will be in phase with each other because of the feedback path and will thus produce an output (pin 1) of almost zero. The IC op amp will always try to keep a zero potential difference between both inputs. Any type of non-linearity will cause the op amp to produce a large output, and therefore a substantial size correction signal in order to retain the small output level.

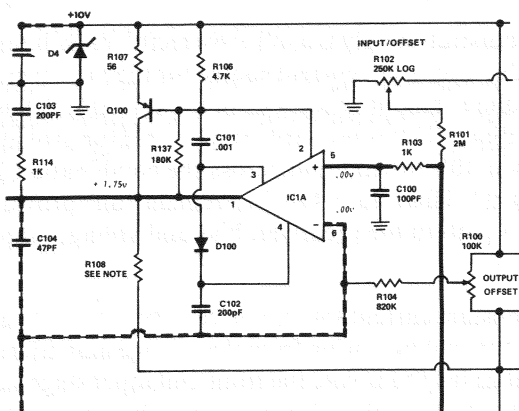

Fig. 7.22 Input Stage

B. Voltage Amplification

The operation of the D-150A front-end circuitry (IC op amp through Q105) is to basically provide voltage amplification. However, the signal translator transistor (Q101) provides no voltage amplification itself, but rather converts the ground referenced input signal to a signal with a reference to the negative supply (-45V). The result is higher voltage swing capabilities from Q105 (final voltage amplifier).

The final voltage amplification transistor (Q105) is the main source of voltage amplification in the D-150A. R116 in the base circuit of this transistor serves two purposes:

01

- 1) it provides collector current for Q101
- 2) it allows the signal on the collector of Q101 to be developed across it and thus amplified.

As this development is in process, Q105 emitter voltage is developed across R124. When this voltage reaches a positive .6V, Q106 turns on and "pulls" the drive away from the last voltage amplifier, thus acting as a current limiter for Q105.

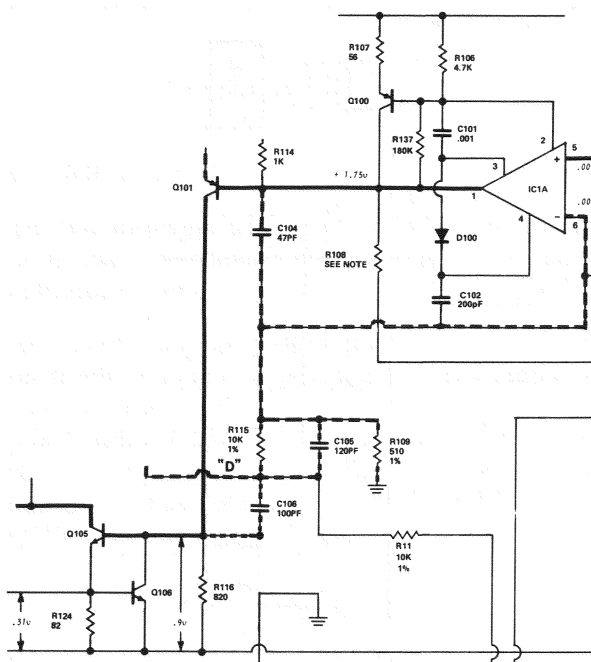

Fig. 7.23 Voltage Amplification Stage



SECTION 8

SERVICE BULLETINS

Periodically, a situation may arise where Crown will feel that it is necessary to change or update specific circuitry by the addition or subtraction of component parts. This information is automatically sent to all Crown Warranty Service Stations. It should be kept with this manual, preferably behind this page as indicated by the note at bottom. Should there be any question pertaining to these changes or updates, call or write the Crown Technical Service Department.

**PLACE ALL
SERVICE UPDATES
HERE**

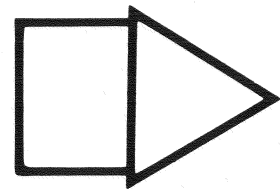

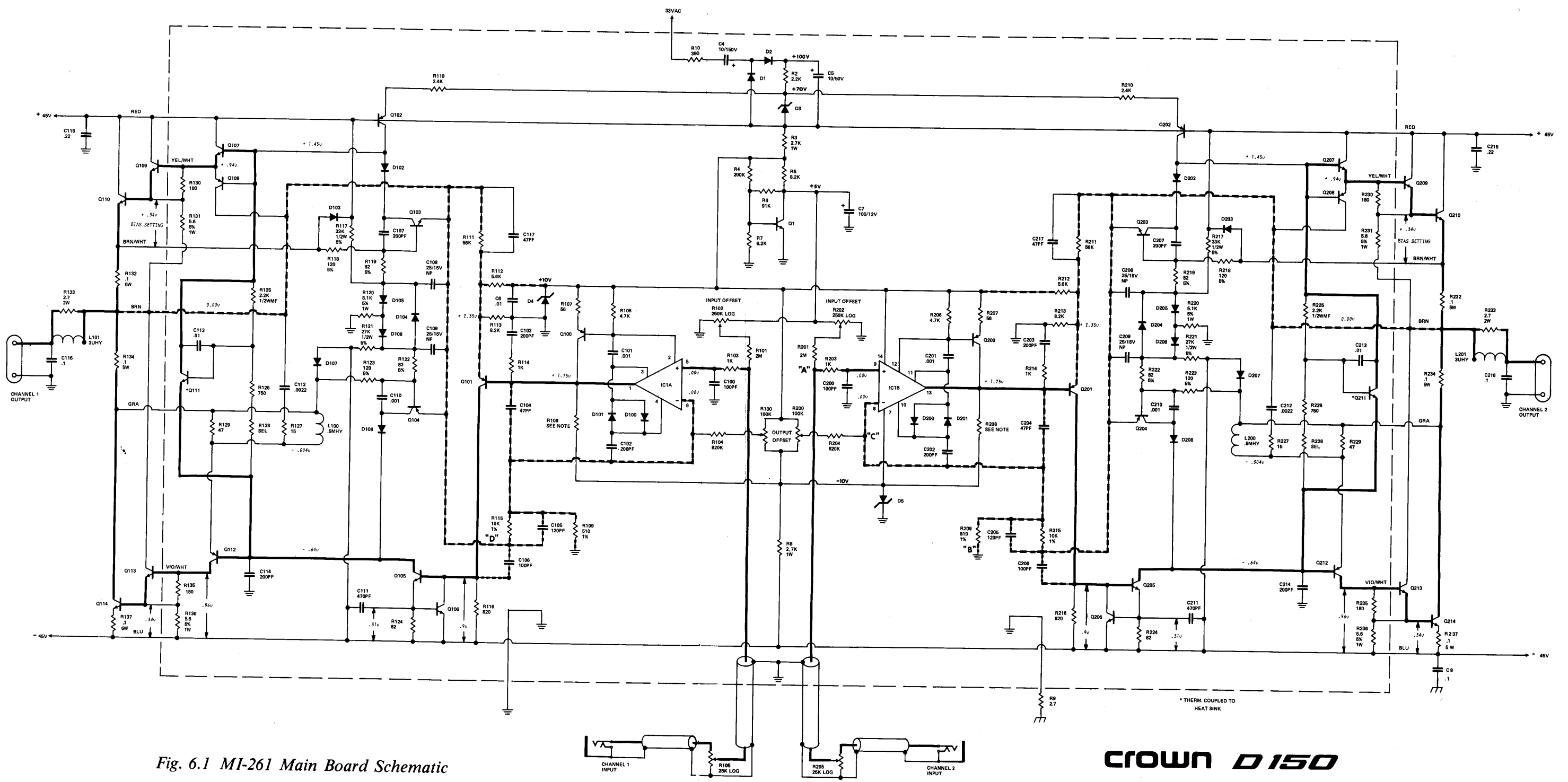
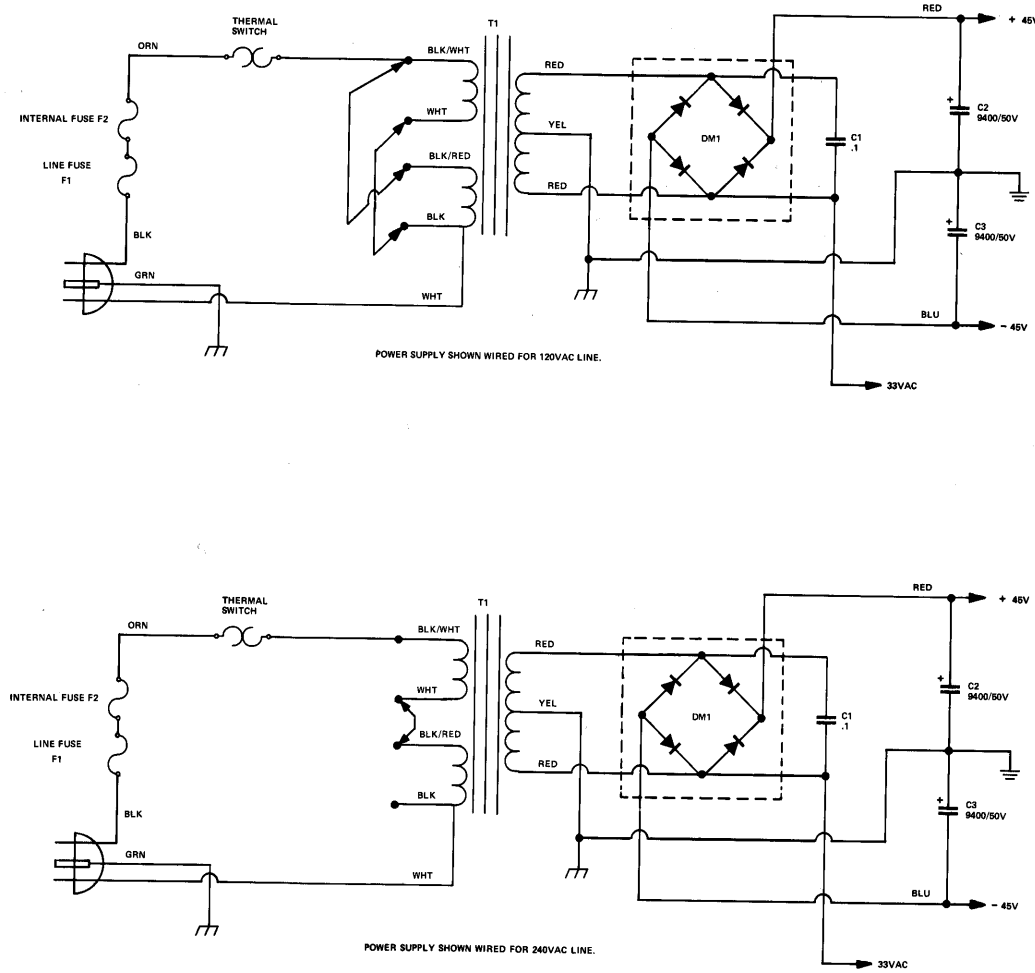

- NOTES:**
- THIS SCHEMATIC APPLIES TO AMPLIFIERS NUMBERED SN8359 TO SN17875 (SELECTED UNITS).
 - DC VOLTAGES ARE SHOWN FOR VARIOUS POINTS. THESE ARE THE NORMAL OPERATING VOLTAGES FOR ZERO INPUT.
 - THE HEAVY CONTINUOUS TRACE FOLLOWS THE PRIMARY SIGNAL PATH THROUGH THE CIRCUIT. THE HEAVY BROKEN TRACE SHOWS FEEDBACK PATHS.
 - WIRE COLOR CODES ARE GIVEN FOR THE MAIN POWER SUPPLY AND SOME BOARD WIRES.
 - ALL RESISTORS IN OHMS UNLESS OTHERWISE STATED.
 - ALL CAPACITORS IN MICRO-FARADS UNLESS OTHERWISE STATED.
 - COMPONENTS COMMON TO BOTH CHANNELS ARE NUMBERED FROM 1 TO 99.
 - CHANNEL ONE COMPONENTS ARE NUMBERED FROM 100 TO 199.
 - CHANNEL TWO COMPONENTS ARE NUMBERED FROM 200 TO 299.
 - FOR MONO CONVERSION TIE POINT A TO B AND C TO D.
 - R108 AND R208 SHOULD BE 3.3K, 1/4W WHEN IC1 IS NA749.

Fig. 6.1 MI-261 Main Board Schematic

CROWN D150
 Laboratory Power Amplifier
 MI 261
 NPC OUTPUTS

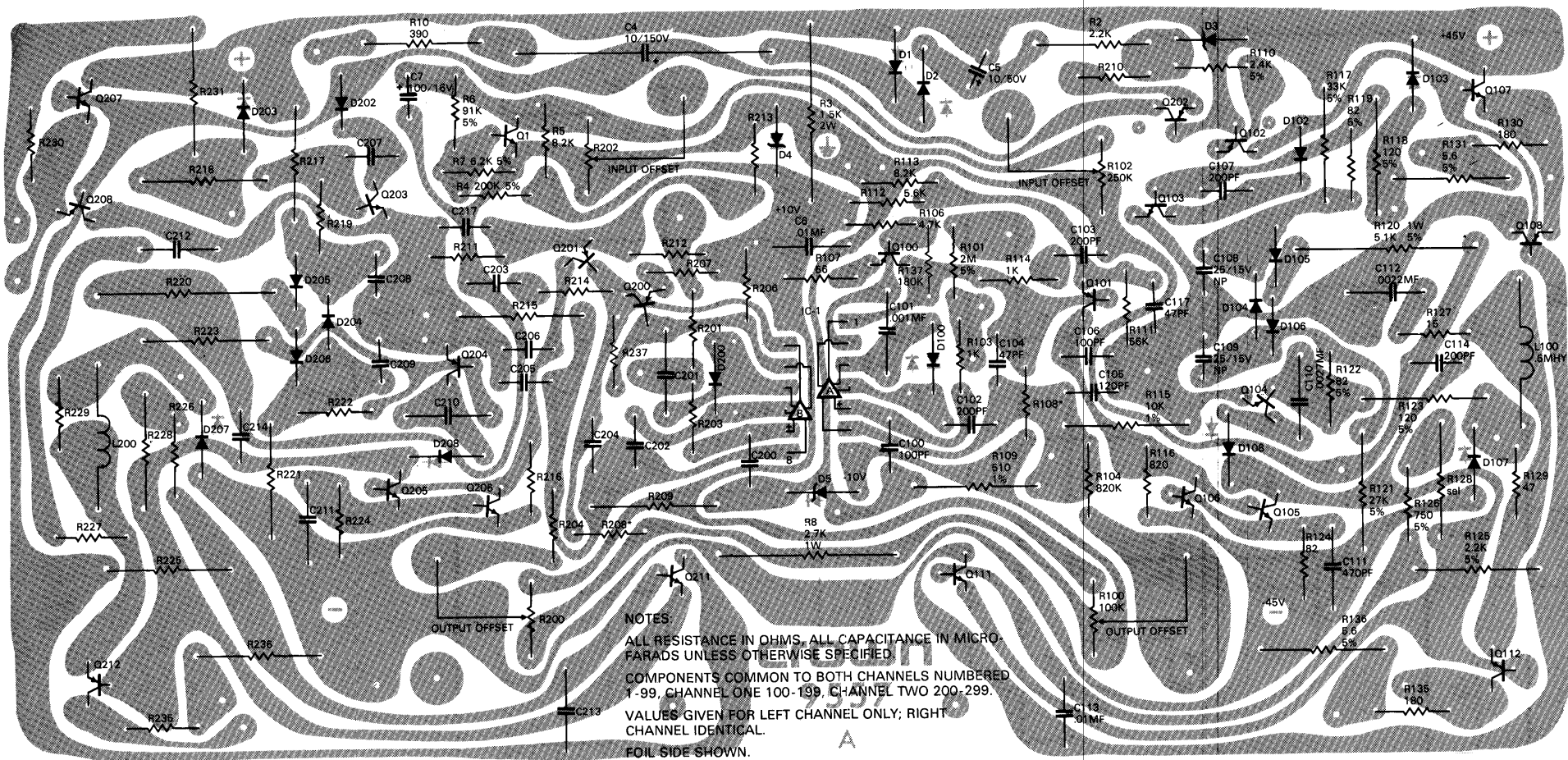

Fig. 6.2 MI-261 Foil Board Layout

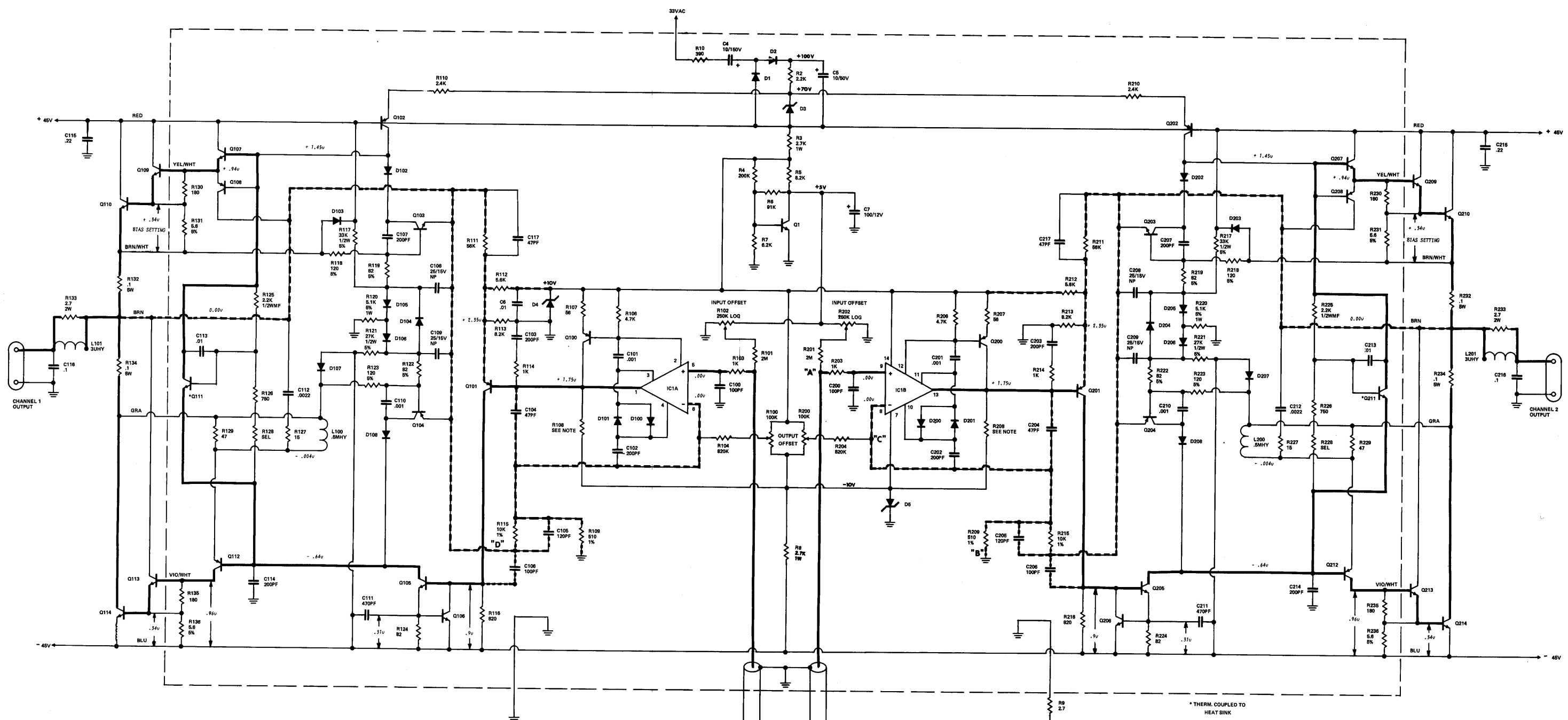
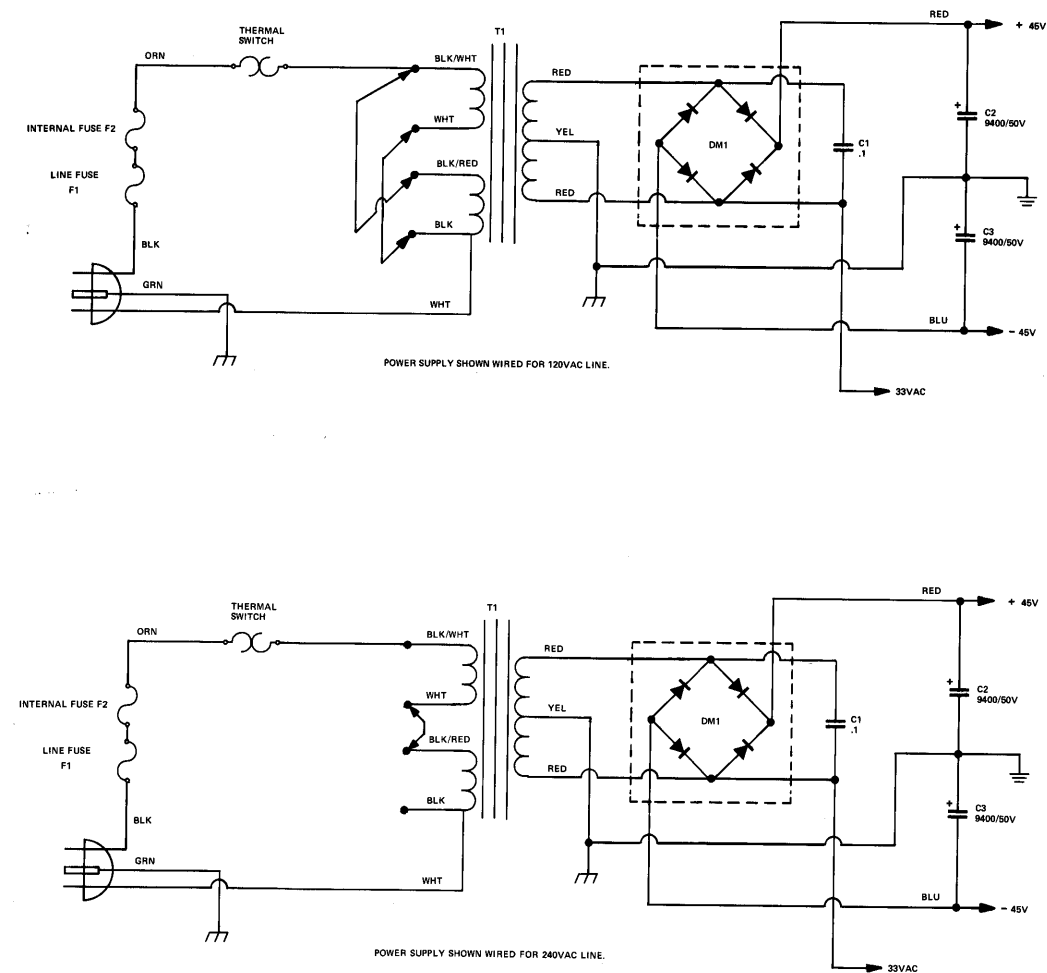
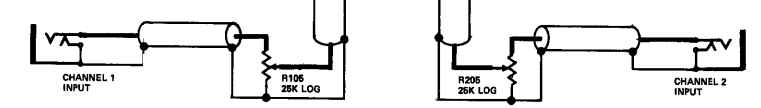

Fig. 6.3 MI-261A Main Board Schematic

- NOTES:**
- THIS SCHEMATIC APPLIES TO AMPLIFIERS NUMBERED SN8359 TO SN17875 (SELECTED UNITS).
 - DC VOLTAGES ARE SHOWN FOR VARIOUS POINTS. THESE ARE THE NORMAL OPERATING VOLTAGES FOR ZERO INPUT.
 - THE HEAVY CONTINUOUS TRACE FOLLOWS THE PRIMARY SIGNAL PATH THROUGH THE CIRCUIT. THE HEAVY BROKEN TRACE SHOWS FEEDBACK PATHS.
 - WIRE COLOR CODES ARE GIVEN FOR THE MAIN POWER SUPPLY AND SOME BOARD WIRES.
 - ALL RESISTORS IN OHMS UNLESS OTHERWISE STATED.
 - ALL CAPACITORS IN MICRO-FARADS UNLESS OTHERWISE STATED.
 - COMPONENTS COMMON TO BOTH CHANNELS ARE NUMBERED FROM 1 TO 99.
 - CHANNEL ONE COMPONENTS ARE NUMBERED FROM 100 TO 199.
 - CHANNEL TWO COMPONENTS ARE NUMBERED FROM 200 TO 299.
 - FOR MONO CONVERSION TIE POINT A TO B AND C TO D.
 - R108 AND R208 SHOULD BE 3.3K, 1/4W WHEN IC1 IS NA749.



CROWN D150
 Laboratory Power Amplifier
 MI 261A
 FAIRCHILD OUTPUTS

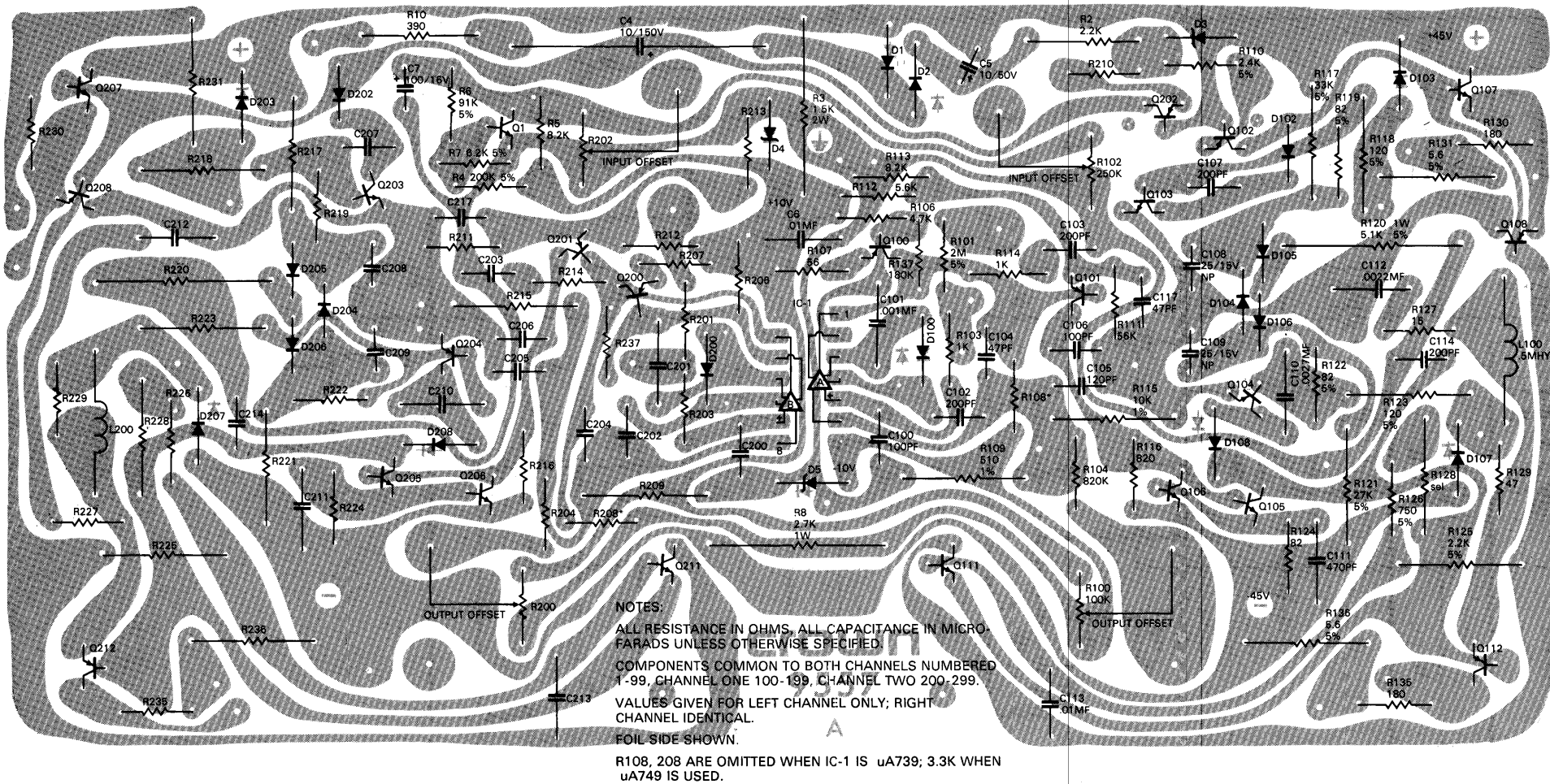

Fig. 6.4 MI-261A Foil Board Layout