



MODEL IM-5

*Crown*

**INSTRUCTION  
MANUAL**

Serial No. . . .  
Issued . . . . .

**D-150  
DUAL-CHANNEL  
POWER AMPLIFIER**

# TABLE OF CONTENTS

|  | PAGE          |
|--|---------------|
| <b>Section 1 DESCRIPTION</b>                 |               |
| 1.1 General .....                            | 1             |
| 1.2 Specifications .....                     | 2, 3, 4, 5, 6 |
| 1.3 Warranty .....                           | 7             |
| 1.4 Accessories .....                        | 7, 8          |
| <b>Section 2 INSTALLATION</b>                |               |
| 2.1 After Unpacking .....                    | 9             |
| 2.2 Mounting .....                           | 9             |
| 2.3 Typical Hi-Fi System Installation .....  | 11            |
| 2.4 Connecting Output Lines .....            | 11            |
| 2.5 Connecting Input Lines .....             | 12            |
| 2.6 Connecting Power .....                   | 13            |
| <b>Section 3 OPERATING INSTRUCTIONS</b>      |               |
| 3.1 Operating Controls and Adjustments ..... | 15            |
| 3.2 Protection Mechanisms .....              | 15            |
| 3.3 Operating Precautions .....              | 17            |
| 3.4 Load Protection Methods .....            | 17            |
| 3.5 Cleaning .....                           | 18            |
| <b>Section 4 CIRCUITRY</b>                   |               |
| 4.1 Principals of Operation .....            | 19            |
| 4.2 Test Procedures .....                    | 19            |
| 4.3 Service .....                            | 20            |
| <b>Section 5 APPLICATION NOTES</b> .....     | 21            |

## LIST OF ILLUSTRATIONS

| TITLE   | PAGE |
|---|------|
| 1-1 D-150 Pictorial .....   | 1    |
| 1-2 Panel Kit Installation .....  | 7    |
| 1-3 5-D Walnut Enclosure .....  | 7    |
| 1-4 Front PA Adapter .....  | 8    |
| 1-5 Back PA Adapter .....   | 8    |
| 1-6 Graph of PA Adapter Filter Response .....   | 8    |
| 1-7 Schematic of PA Adapter .....   | 8    |
| 2-1 Mounting Dimensions .....   | 9    |
| 2-2 Typical Hi-Fi Installation .....  | 10   |
| 2-3 Rear View of Chassis .....  | 11   |
| 2-4 Schematic for Full-range Electrostatic Speaker Connection .....                     | 11   |
| 2-5 Source of Resistance and Damping Factor vs Length and<br>Size of Output Leads ..... | 12   |
| 2-6 Schematic of Earphone Pad .....   | 12   |
| 2-7 Graph for Selection of Input Capacitor .....  | 13   |
| 2-8 Low-pass Filters for Severe RF at Inputs .....                                      | 13   |
| 2-9 Line Voltage Connections (240VAC) .....   | 13   |

|  |           |
|--|-----------|
| <b>3-1 Operating Controls</b> .....                                      | <b>15</b> |
| <b>3-2 Graph of V-I Operating Range of D-150 Output</b> .....            | <b>16</b> |
| <b>3-3 Fuse Selector Nomograph for Loudspeaker Protection</b> .....      | <b>17</b> |
| <b>3-4 Relay-Controlled Load Protector with Overload Indicator</b> ..... | <b>18</b> |
| <b>3-5 Peak Power Limiting Compressor with Overdrive Indicator</b> ..... | <b>18</b> |
| <b>3-6 Turn-on-Transient Muter for Load Protection</b> .....             | <b>18</b> |
| <b>4-1 Schematic of D-150</b>  |           |

## DESCRIPTION

## 1.1 GENERAL

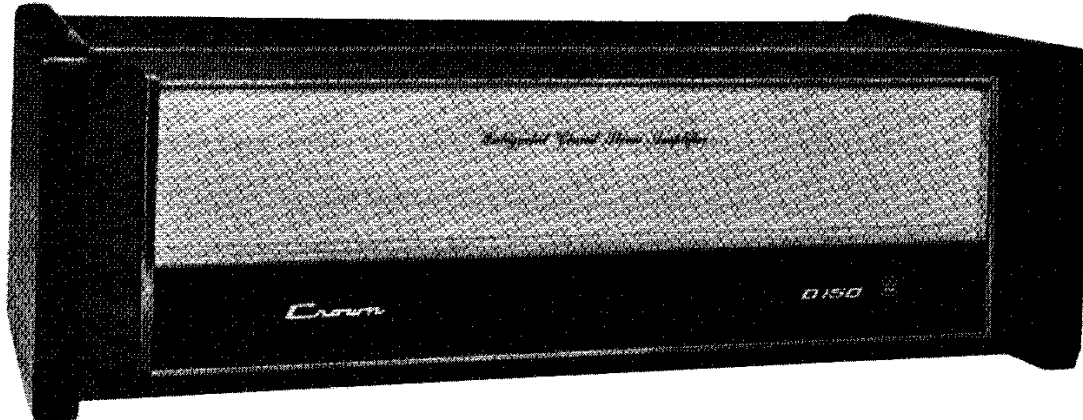

**FIG. 1 - 1**  
**INTEGRATED CIRCUIT STEREO**  
**D-150 AMPLIFIER**  
*(Shown with optional front-panel and walnut cabinet)*

The D150 is a dual-channel medium power amplifier for ultra-low distortion amplification from 5Hz to 20KHz with operation into loads of 4 ohms and higher. The unit features extremely low harmonic and intermodulation distortion, very low noise, highest "damping factor," and quality parts and workmanship. The unit may be wired to produce a balanced 50 volt monaural output. The amplifier is fully protected against mismatched and shorted loads by a resetting V-I (volt-ampere) limiter having no obnoxious muting or program delays. A thermal switch removes power from the unit if overheating occurs due to insufficient ventilation.

The power supply features large computer-grade filter capacitors giving over 20 joules of energy storage.

A total of 24 discrete transistors, 1 linear IC (dual op amp), 20 diodes and 1 bridge rectifier are utilized in a CROWN pioneered Class AB+B output circuit. The effective number of semiconductors is 40 transistors and 30 diodes.

The input voltage-amplifiers, (IC), are powered by two voltage-regulated supplies. This results in complete channel-to-channel isolation and independence from line voltage variations.

Two level controls are mounted adjacent to the input jacks to allow balancing and optimizing of system levels.

## 1.2 SPECIFICATIONS

|                    |  |
|--------------------|--|
| Power Output       | Power output not less than 75 watts R.M.S. per channel into 8 ohms (both channels operating), 20-20,000Hz at rated distortion. Typically 100 watts R.M.S. per channel into 8 ohms, 180 watts R.M.S. per channel into 4 ohms.   |
| Power Bandwidth    | Power bandwidth $\pm 1$ dB, 5-20,000Hz at 75 watts R.M.S. per channel into 8 ohms.   |
| Frequency Response | $\pm 0.1$ dB 20-20,000Hz at 1 watt into 8 ohms; $\pm 1$ dB 4-100,000Hz.  |
| I.M. Distortion    | I.M. less than 0.05%, 0.01 watt to 75 watts, 60Hz and 7,000Hz mixed 4:1. Harmonic - less than 0.05%, 0.01 watt to 75 watts, 20-20,000Hz.   |
| Phase Response     | $\pm 15^\circ$ , 20-20,000Hz at 1 watt into 8 ohms. (See graphs)   |
| Damping Factor     | Greater than 200 from zero to 1000Hz into 8 ohms.  |
| Hum and Noise      | 110dB below 75 watts R.M.S. output.  |
| Verification       | Each unit accompanied by its individual hand-entered proof-of-performance report.  |
| Load Impedance     | 4 to 16 ohms (complete stability with any load); dual binding-post outputs.  |
| Construction       | 100% American-made with industrial grade construction for years of continuous use.   |
| Input              | Impedance - Nominal 25K ohm, screwdriver adjust on rear. Input sensitivity 1.2V for full output. Standard $\frac{1}{4}$ " phone-jack on rear.  |
| Turn-on            | Instantaneous, with no program delay, and minimum thump.   |
| Circuit            | Unique wideband, stable design utilizing one linear IC (dual op-amp). Total equivalent of 40 transistors, 24 diodes, and four rectifier-diodes.  |
| Protection         | Amplifier is short - and mismatch- and open-circuit-proof. Unique V-I limiting is instantaneous with no thumps, cutout, etc.   |
| Power Supply       | Two massive capacitors with energy-storage exceeding 20 joules. Total of two regulated supplies for complete isolation and stability. No fuses except AC power-line.   |
| Dimensions         | 17" width, $5\frac{1}{4}$ " high, 9" deep (from mounting surface). All-aluminum construction with massive chassis, and extruded front-panel. Amplifier will panel-mount in a $16\frac{3}{4}$ " x 5" opening (with optional front panel). With adapters, standard 19" rack mount. |
| Weight             | 22 pounds (24 pounds rack mount).  |
| Warranty           | 3-year on all parts, labor, and round-trip shipping.   |

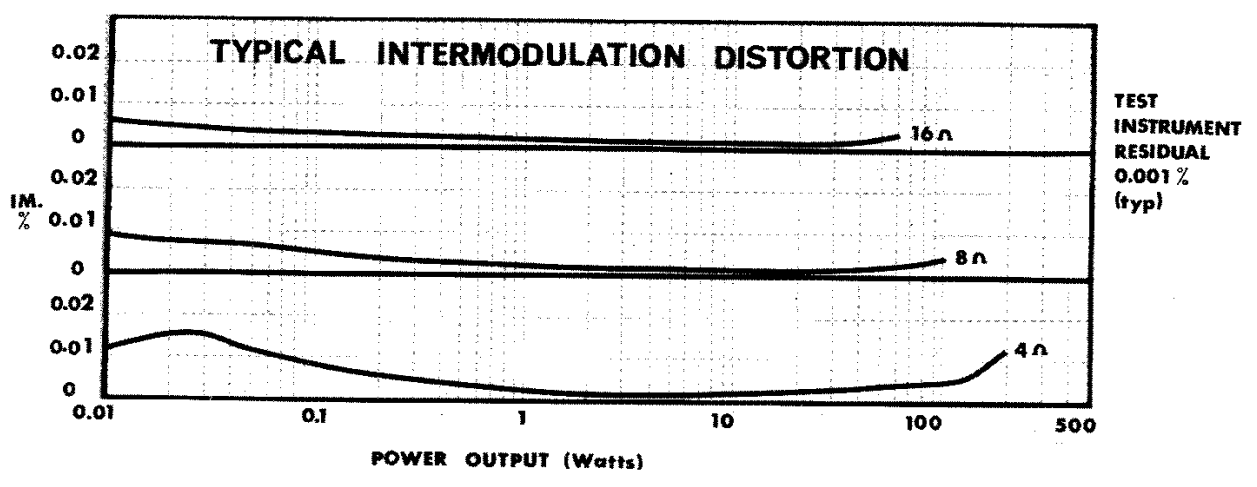
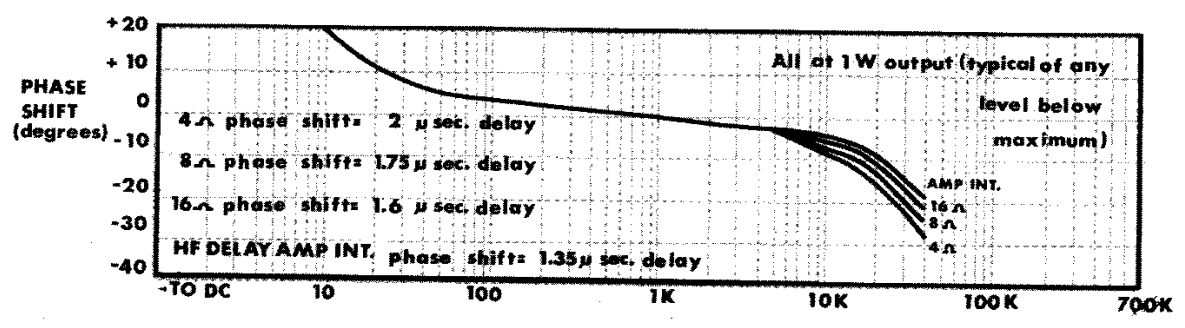
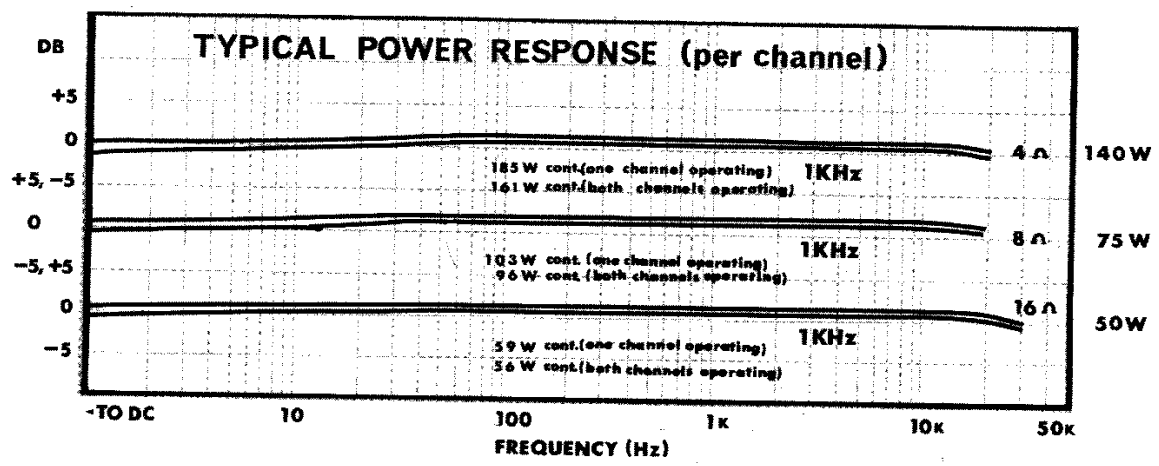
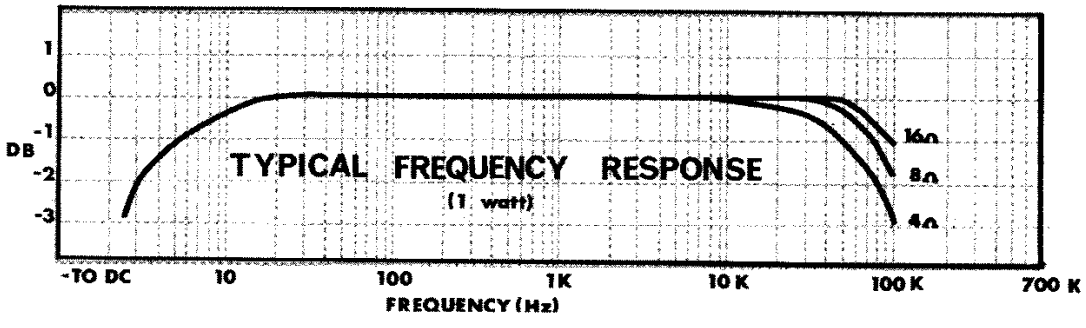

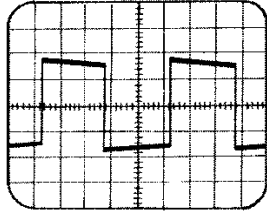

Square Wave  
Response ( 1 watt)

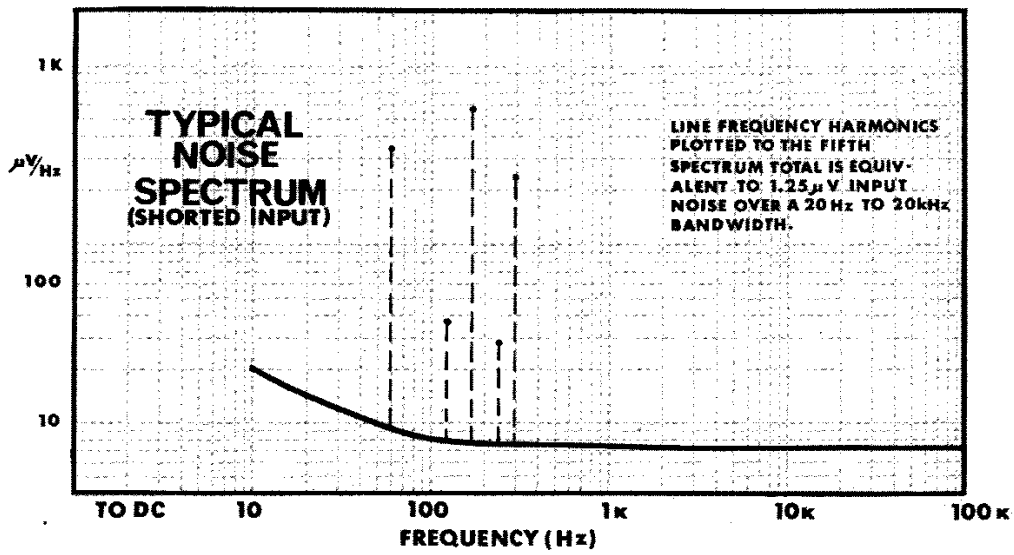
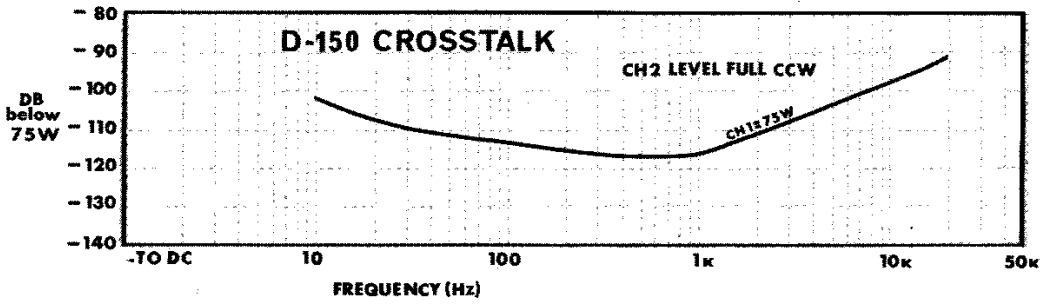
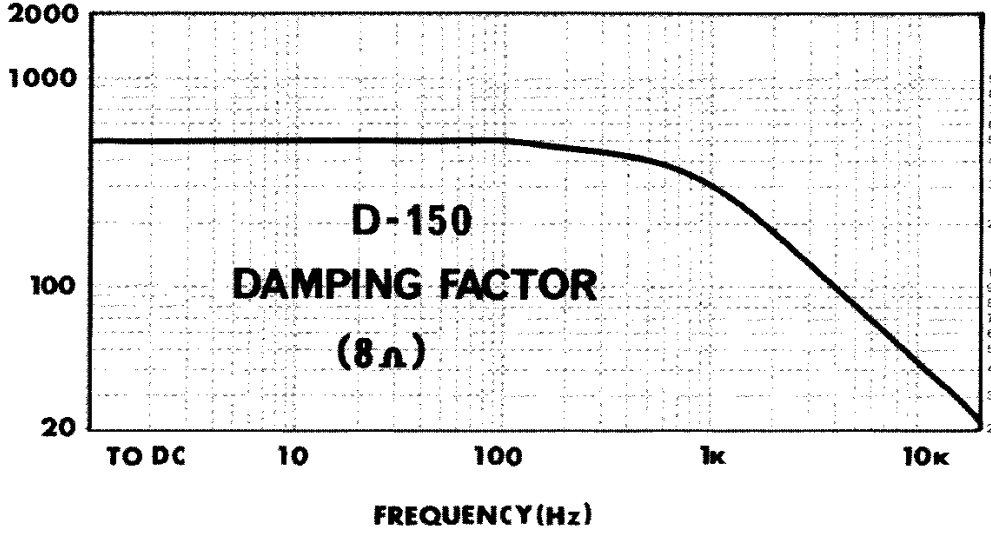
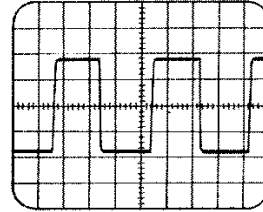

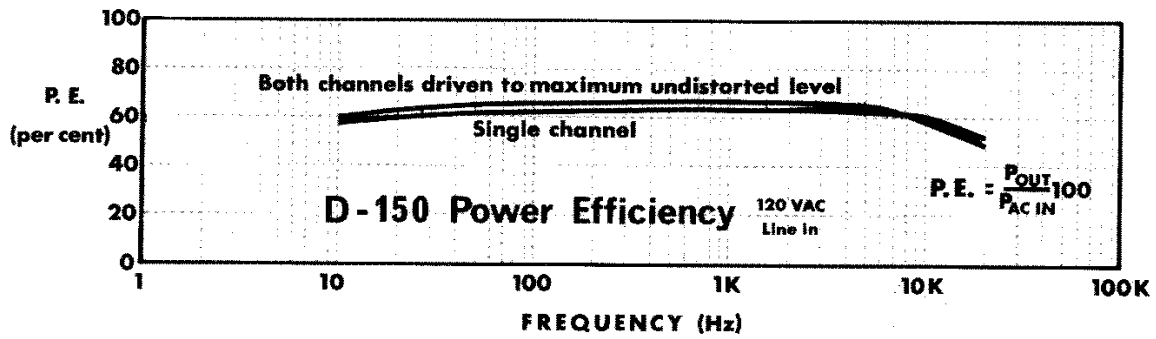
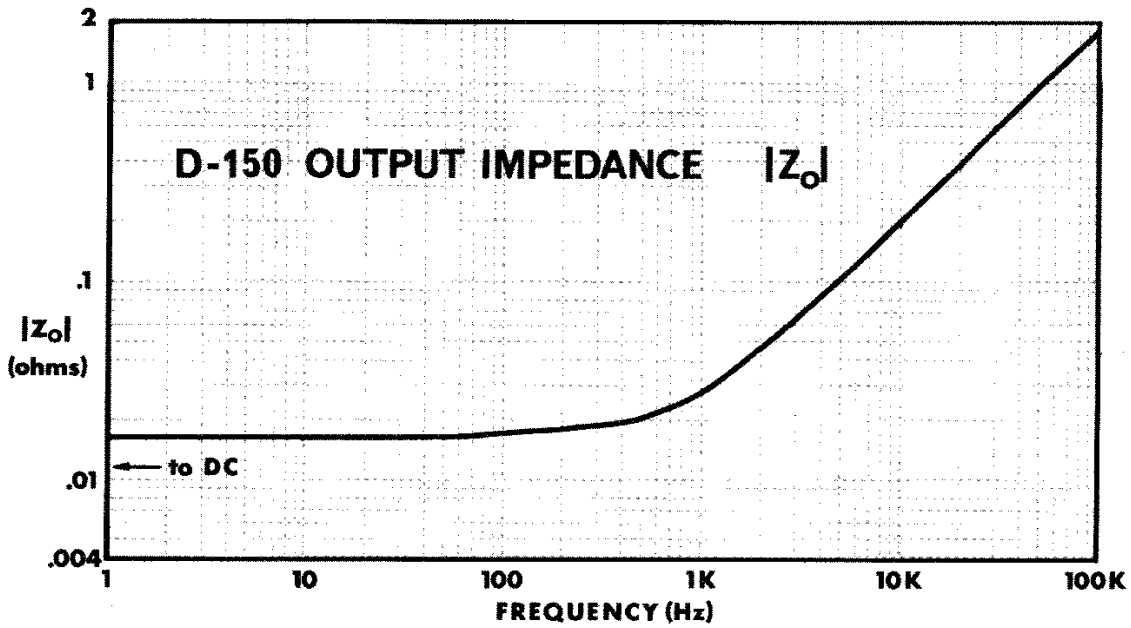
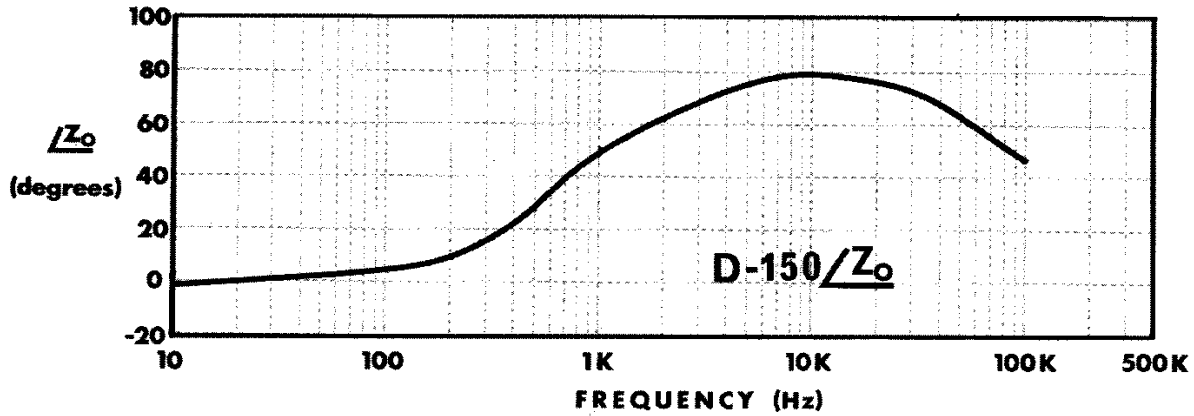



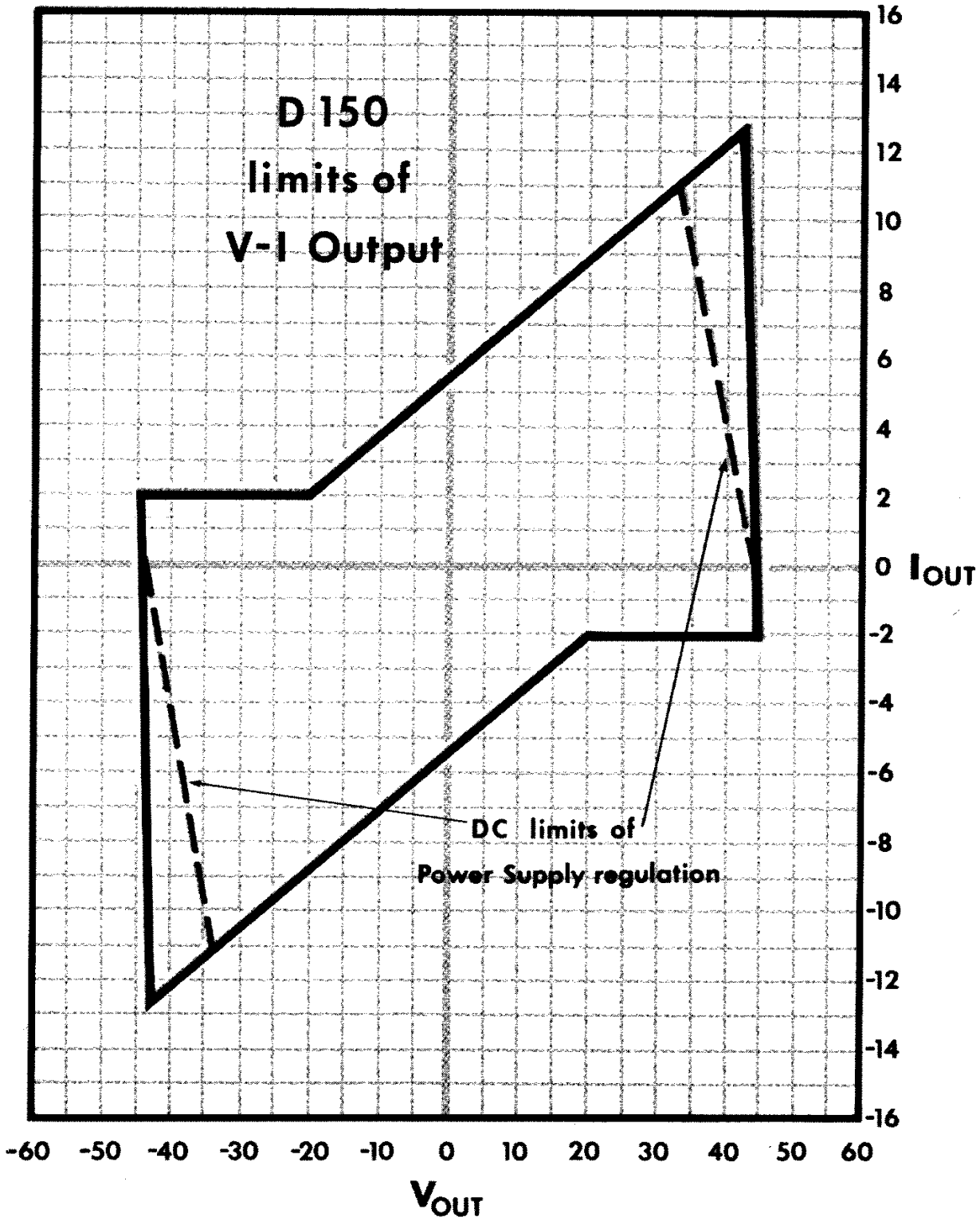

### 1.3 WARRANTY

CROWN guarantees this equipment to perform as specified. CROWN also warrants the components and workmanship of this equipment to be free from defects for a period of 90 days from date of purchase.

This warranty does not extend to fuses, and/or component or equipment damage due to negligence, misuse, shipping damage or accident; or if the serial number has been defaced, altered or removed.

An application for a FREE 3 year WARRANTY TITLE is included with this manual. Upon receipt of this completed form, CROWN will issue the Warranty Title—subject to the conditions contained therein. This title applies to the original end-purchaser and will be issued only upon the receipt of the application.

We urge that you take full advantage of this coverage—fill in and mail the application now!

### 1.4 ACCESSORY EQUIPMENT

#### 1.4.1 Model PK Panel Kit

To facilitate the installation of a D150 into a “custom installation,” an accessory cabinet 5-D or a rack, the accessory panel must be installed.

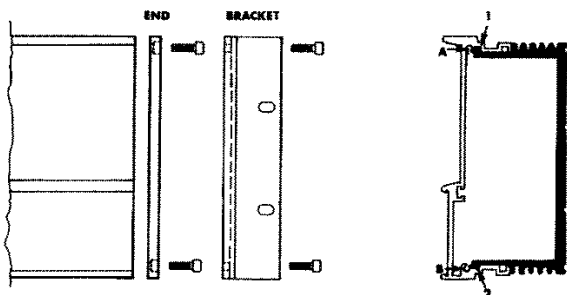

FIG. 1-2 PANEL KIT MOUNTING and INSTRUCTIONS

Placing the amplifier with the rubber feet toward you, pull off the rubber feet. When this is completed, stand the amplifier on its side with the transformer down. The front panel should then be slid onto the unit with the word “Amplifier” first. The plastic wedges supplied in the mounting kit should then be forced into positions No. 1 and No. 2 on both ends of the unit until it stops, then clip or break off the excess.

Align the end caps to the unit so holes “A” and “B” match the end caps. Use 6/32 x 1/2 socket cap screws (Note: Socket screws may look as though they are crossthreading but will straighten approximately halfway through).

In a “custom installation,” install a solid shelf, to support the amp. It should be flush with the bottom edge of the required 16-9/16” wide x 5-1/16” high panel-cutout.

When using the angle brackets for rack mounting always have the brushed side of the angle toward you. Mount the angle bracket in place of the end caps and follow the procedures as outlined in cabinet mounting.

#### 1.4.2 Model 5-D Walnut Enclosure

Rich oil-walnut veneers, highlighted with black-vinyl trim, accent the D150-PK when installed on a shelf or table in a 5-D enclosure. Four rubber feet are provided.

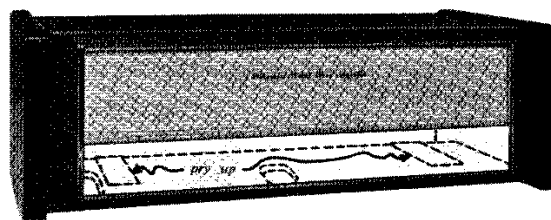

FIG. 1-3

If installing amplifier into 5-D walnut accessory-cabinet, remove the two small wooden shims stapled to cabinet floor.

1.4. 3P-A Adaptor Panel

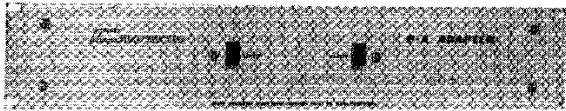

FIG. 1 - 4  
FRONT VIEW OF P-A ADAPTER PANEL

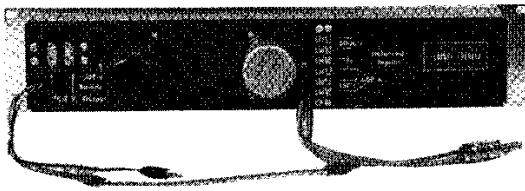

FIG. 1 - 5  
REAR VIEW OF P-A ADAPTER PANEL

The PA adapter panel is used to connect the amplifier to obtain a monaural 50-volt balanced output line (see schematic, Fig. 1-7). This is achieved by a precision push-pull transformer (inverted signal to Channel 1). This results in over 150 watts of 50-volt balanced output from the two output terminals in 16 ohms, over 250 watts when terminated in 8 ohms.

The adapter panel provides balanced inputs of 150 ohms, 600 ohms CT, and 5000 ohms bridging. Sensitivity is -5dbm, 600 ohms.

Two switches are provided on the front panel for insertion of hi-cut and lo-cut filters. The characteristics of these filters may be altered by changing internal capacitors in accordance with Fig. 1-6.

The P-A adaptor comes wired for an amplifier input impedance of 10K. Therefore it will be necessary to parallel

the 18K resistors (furnished with the adaptors) across the amplifier inputs as described on a note with the resistors.

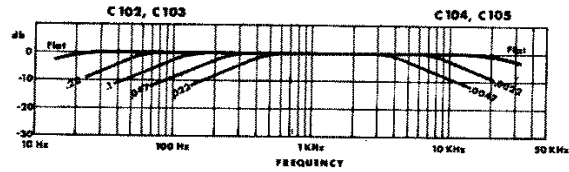

FIG. 1 - 6  
P-A ADAPTER FILTER RESPONSE

The output circuit contains a roll-off capacitor (C 101) which should be used if matching transformers are used on the output line. This will prevent large low-frequency currents from flowing into their primaries.

If matching transformers are not used, and the low-frequency impedance (DC resistance) of the load is 6 ohms or greater, the system may be directly coupled to the amp output terminals, bypassing C 101. Otherwise, use the output terminals on back of the adapter panel.

To ensure maximum output (without premature clipping) both amplifier level controls must be full CW.

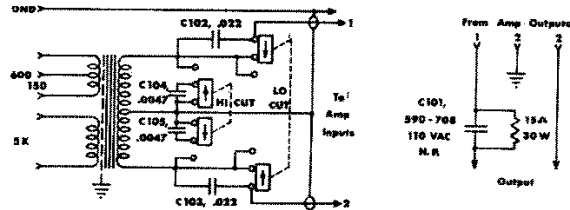

FIG. 1 - 7  
P-A ADAPTER SCHEMATIC

# INSTALLATION

## 2.1 UNPACKING

As soon as the amplifier shipment is received, please inspect for any damage incurred in transit. Since the unit was carefully inspected and tested at the factory, it left the factory unmarred. If damage is found, notify the transportation company immediately. Only the consignee may institute a claim with the carrier for damage during shipment. However, CROWN will cooperate fully in such an event. Be sure to save the carton as evidence of damage for the shipper's inspection.

Even if the unit arrived in perfect condition—as most do—it is advantageous to save the packing materials. They will prove valuable in preventing damage should there ever be occasion to transport or ship the unit. Note the carton and internal pack—each is designed for protection during transit. Do not ship the unit without this factory pack (or equivalent)!

Be sure to return the warranty form to the factory within ten days for the full warranty coverage.

For those interested in hearing the D-150 as soon as possible, please follow this fast procedure on next page:

## 2.2 MOUNTING

The D150 may be custom or rack-mounted if an accessory front-panel kit with rack-mounting brackets was purchased. The installation of this kit is detailed in par. 1.4.2 on page 6. For dimensions see Fig. 2-1. Sufficient ventilation must be provided for the unit. This means that air must be allowed to circulate over the chassis; if not, the unit will intermittently turn off due to the built-in thermal protection. Applications—other than “Hi-Fi”—requiring long, sustained signals at high power-levels may require the use of a cooling fan.

FIG. 2-1  
D150 MOUNTING DIMENSIONS

NOTE: The “basic” D150 shown at right may be converted for rack- or cabinet (panel) mounting by installing the front panel with brackets or end-caps as shown below. For installation see Section 1, par. 1.4.1 or P-K instructions.

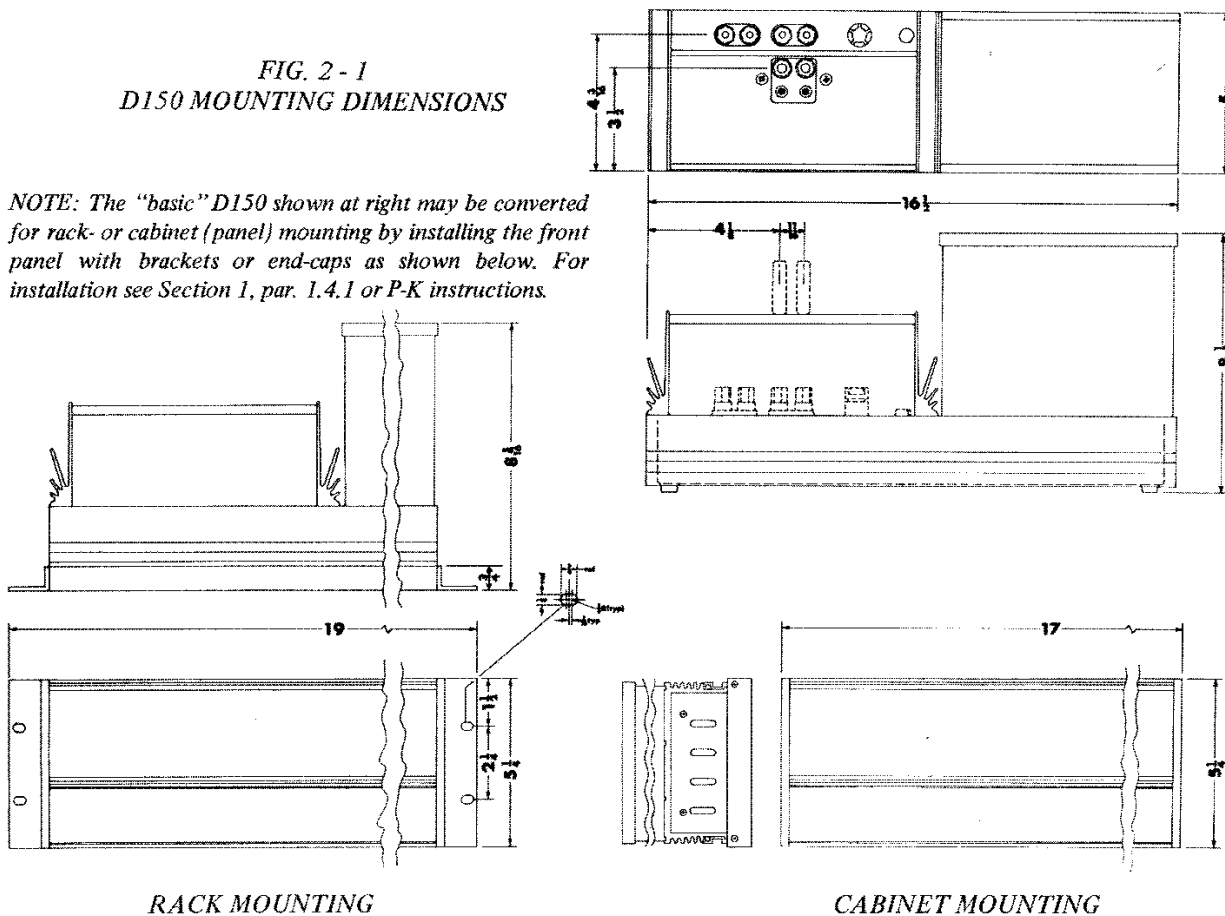

2 INSTALLATION

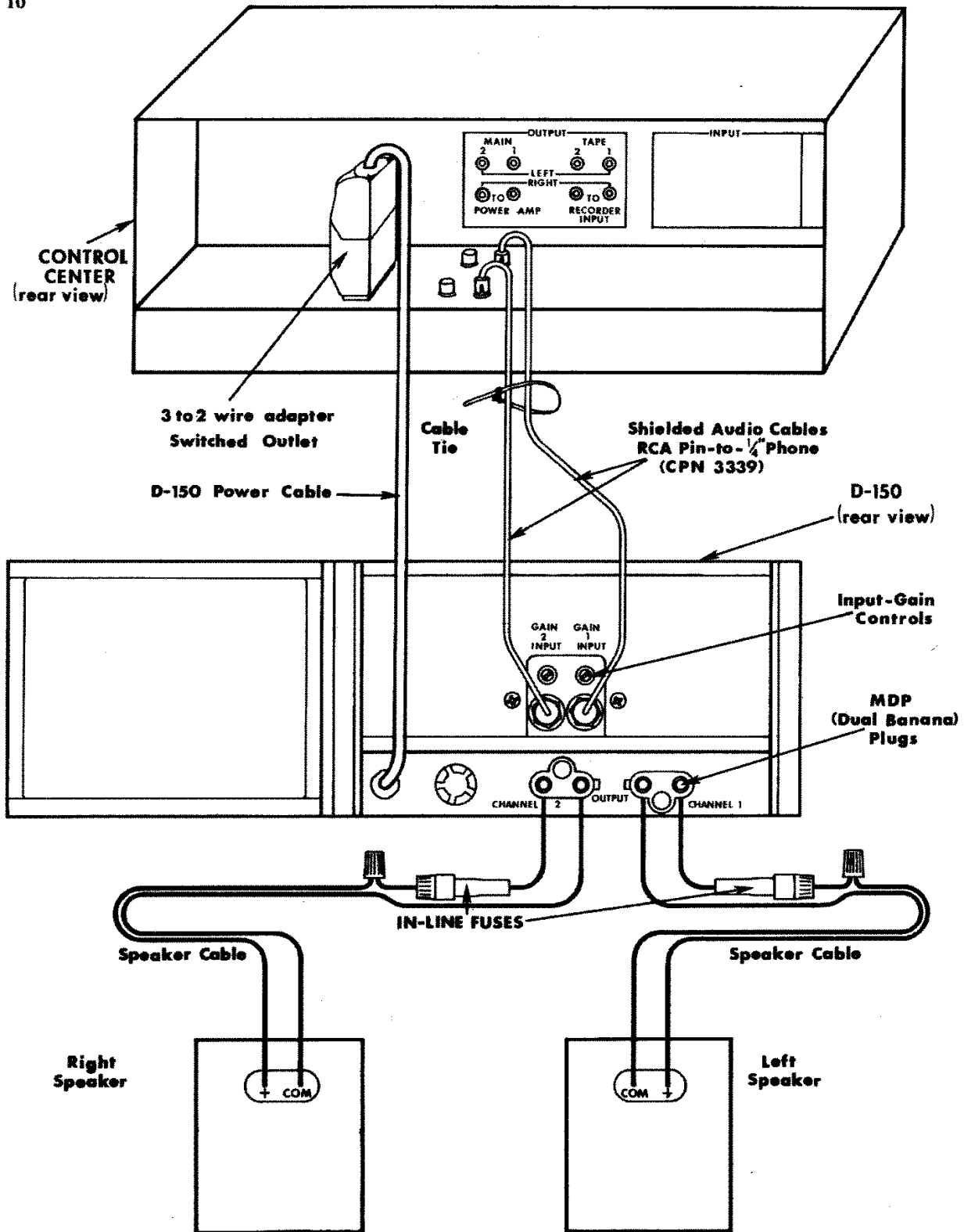

FIG. 2 - 2  
TYPICAL HI-FI INSTALLATION

### 2.3 NORMAL HI-FI INSTALLATION

1. Two-conductor speaker cables must connect to the OUTPUT dual binding posts using terminal lugs, tinned ends, or the special "banana" plugs supplied with the D-150. Connect the in-line fuses as recommended in the Accessory Bag and Fig. 2-2!!

2. Since the D-150 is a "basic amplifier," the main outputs of the control-center or "preamplifier" must be connected via shielded audio-cables to the two jacks marked INPUT. Use RCA-pin at preamp and standard ¼ in. phone-plug at the D-150.

The two cables should be tied parallel along their entire length using the accessory cable ties.

3. U/L requirements prefer a 3-wire AC power connector; however, proper connections to a switched outlet on the control center requires the use of a 3-to-2 wire adapter. NOW, Plug the AC into a *switched* outlet on the control center.

4. Your Control Center may now be turned on. Then advance the D150 Input-Gain Controls about ½-open (150° clockwise)

When using the CROWN IC-150 Control-Center, the LOUDNESS should attain almost full rotation (2 to 4 o'clock) for loudest "concert-hall" volume. If at 3 o'clock the volume is low, increase the D-150 input gain controls; if too high, decrease the D-150 gains.

To assure maximum enjoyment and full speaker protection, read the following detailed sections on OUTPUTS, INPUTS and Chapter 3 - OPERATION.

### 2.4 CONNECTING OUTPUT LINES

Input and output connectors are located on the chassis as shown in Fig. 2-3.

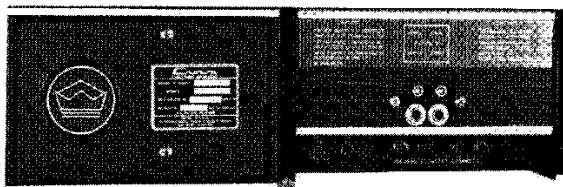

FIG. 2 - 3  
REAR VIEW OF CHASSIS

It is always wise to remove power from the unit and turn the input level controls off while making connections, especially if the load is a loudspeaker system. This will eliminate any chance of loud blasts. CROWN is not liable for damage incurred at any transducer to its being overpowered! The use of the enclosed speaker fuses is therefore highly recommended.

Before making connections, it is recommended that the operator familiarize himself with the amplifiers protective system. See Section 3.2. Section 3.3 entitled "Operating Precautions" should also be read.

Because of the locations of the output connectors (color-coded binding posts) it will be easiest to make these connections first. High-quality, dual "banana" plugs are the preferred connections for permanent installations.

Because the output wire gauge and length raises the resultant source impedance or lowers the Damping Factor by adding series resistance, the nomograph (Fig. 2-5) is provided for wire selection. For dynamic moving-coil loudspeakers the value  $R_L$  should preferably be that measured by an ohmmeter across the voice coil, rather than the manufacturer's rating. For electrostatic speakers and such, the manufacturer's rated impedance should be used for  $R_L$ .

If the load (matching transformer, inductance, or full-range electrostatic speaker system) appears as a short-circuit at low frequencies, a large non-polarized capacitor (paralleled with a resistor) should be placed in series with the load.

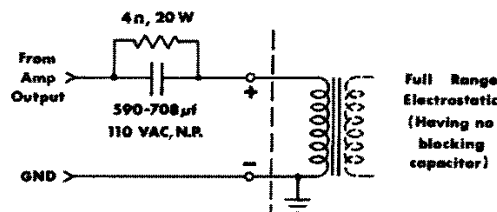

FIG. 2 - 4  
SCHEMATIC FOR FULL RANGE  
ELECTROSTATIC SPEAKER CONNECTION

For electrostatic speakers (if the manufacturer has not provided a capacitor) an external non-polar capacitor of 590-708 mfd and 4 ohm power resistor should be placed in series with the plus (+) speaker lead. This will prevent large low-frequency currents from damaging the electrostatic transformer or from unnecessarily activating the D150's protective system. An effective test to determine if such parts are needed is to measure the DC resistance between the output terminals with an ohmmeter. If the resistance is less than 3 ohms, the parts should be added as shown schematically in Fig. 2-4.

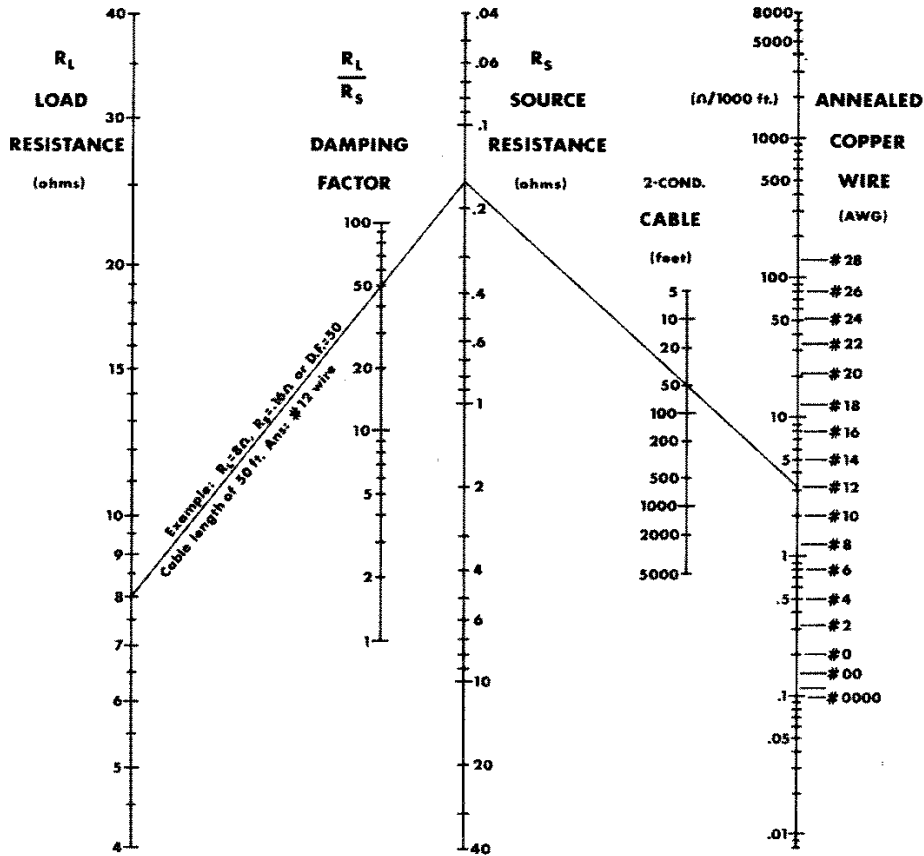

FIG. 2 - 5

*SOURCE RESISTANCE and DAMPING FACTOR VS. LENGTH and SIZE of OUTPUT LEADS*

When selecting connectors for the load (speaker) end of the output lines, the following general precautions apply (with all power connectors):

1. A male plug, carrying signal, must not be on the far end of the line where it can be exposed, giving rise to both shock and short-circuit hazards.
2. Connectors which might accidentally cause the two channels to be tied together during making and breaking of connection should not be used. A common example is the standard 3-circuit 1/4 inch phone jack and plug when wired for stereo sound.
3. Connectors which can be plugged into AC power receptacles should *never* be used.
4. Connectors having low-current-carrying capacity are "verboten."
5. Connectors having any tendency to short, or having shorted leads, are inadvisable.

Most commercially-available headphones employ a 4-circuit 1/4 inch phone plug which violates condition No. 2. This is

no handicap if a pad is inserted between the amp and jack, which is only sensible thing to do, when such a large amplifier is coupled to such a small transducer. If this precaution is ignored, not only may the transducer be burned out but permanent hearing loss could result. The recommended pad is shown in Fig. 2-6.

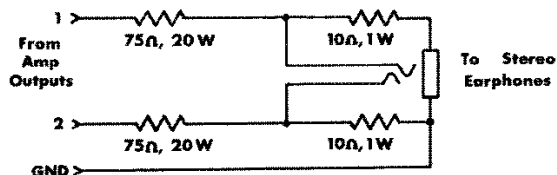

FIG. 2 - 6  
*SCHEMATIC OF EARPHONE PAD*

**2.5 CONNECTING INPUT LINES**

Connecting the inputs will require observance of three basic precautions: Undesirable signals to the inputs, "ground loops," and feed back from output(s) to input(s).

In high-fidelity audio applications any good vacuum-tube or solid-state control center will operate successfully into the 25K ohm inputs of the D-150. Occasionally a high-impedance output of poorly-designed preamps will be encountered, and/or a larger output coupling capacitor may be required (to prevent excessive low-frequency rolloff).

For loudspeaker-driving applications, the input should be free of large sub-audio or undesired low frequencies, as they cause overheating and overloading of the loudspeaker. To remove such low frequencies, a series capacitor may be placed in the input signal line. (The graph of figure 2-7 indicates the effect of the size of the capacitor on the frequency response.) Only a low-leakage paper, mylar, or tantalum capacitor should be used for this purpose.

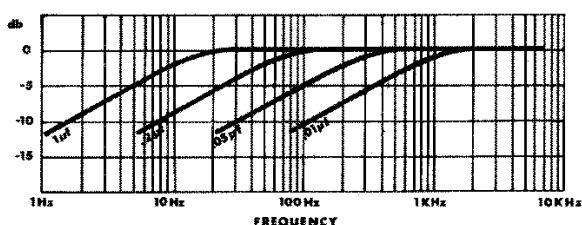
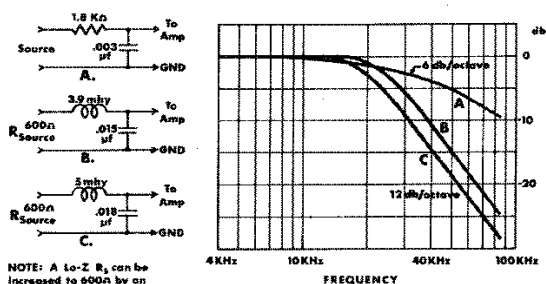

FIG. 2 - 7

GRAPH for SELECTION of INPUT CAPACITOR

If large amounts of ultrasonic or RF frequencies are found on the input, such as bias from tape recorders, etc., a low-pass filter should be placed on the input. While practically-obtainable RF input levels will not damage the amplifier, they may cause burn-out of tweeters or other sensitive loads, activate the amplifiers protective systems, or cause general overload in the controlled-slewing-rate stage of the amp (which is employed to provide RF overload protection). The following filters are recommended for such applications.



NOTE: A Lo-Z  $R_2$  can be increased to 600 $\Omega$  by an appropriate resistor.

FIG. 2 - 8

LOW-PASS FILTERS FOR SEVERE RF AT INPUTS

A second precaution is "ground loops"—electronic jargon for undesirable circulating currents flowing in a grounding system. A common form of loop (possibly resulting in hum in the output) is a pair of input cables whose area is subjected to a magnetic hum field. In practice, both cables should lie together along their length, and away from the power transformer. Tying the input and output grounds together may also form a ground loop.

A third precaution (with input and output grounds together, as in testing or metering) is feedback oscillation, from load current flowing in the loop. In industrial use, even the AC power line may provide this feedback path. Proper grounding, and isolation of inputs, of common-AC-line devices is good practice. Refer to Section 4.2, par. 5 for testing precautions.

2.6 CONNECTING POWER

The amplifier is furnished with a three-wire AC plug as standard equipment. Adaptors are readily available commercially for adapting this to a two-wire system if necessary.

The amplifier offers two standard line-voltage connections: 120 and 240 VAC. The tag attached to the line cord indicates for which voltage the amplifier is connected. Most units are connected for 120 VAC. Figure 2-8 shows pictorially how the 240 VAC connected unit should appear. Note the change to a 2A line fuse.

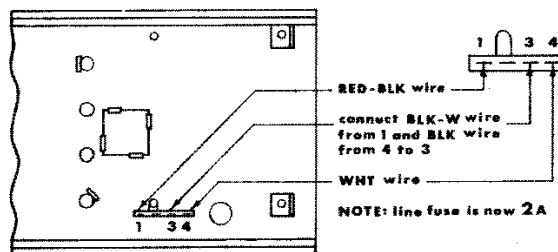

FIG. 2 - 9

LINE VOLTAGE CONNECTIONS (240 VAC)

When testing the amplifier, the line voltage must be the peak equivalent to a sinusoid of the indicated line voltage when at full load. Line regulation problems can introduce serious errors in the measurements on an amplifier of this size.

Only a competent technician should attempt alteration of the line voltage connections.



## OPERATING INSTRUCTIONS

## 3.1 CONTROLS AND ADJUSTMENTS

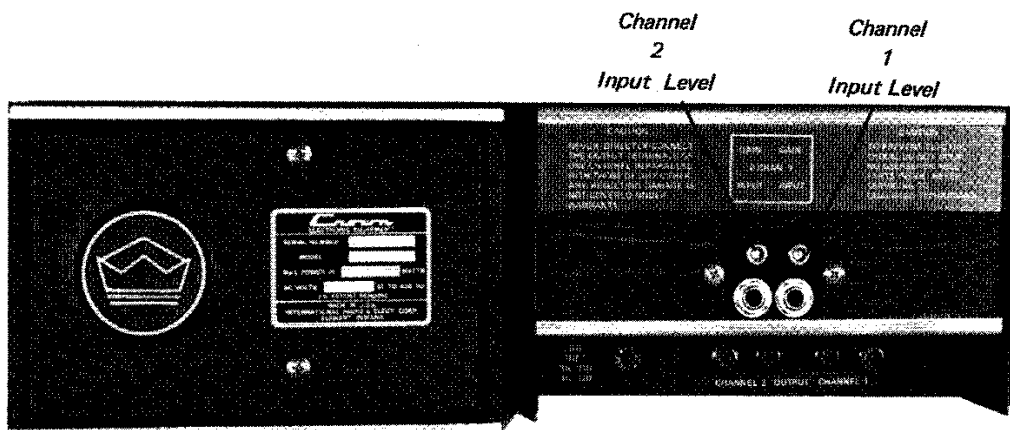

FIG 3 - 1  
OPERATING CONTROLS

The D150 contains all the facilities essential for a high performance amplifier.

The input controls are mounted by the input jacks. Each control should be adjusted for the desired amplifier gain or output level. When the control is fully CW, the gain is 26db as determined by precision 1% resistors in the D150's feedback loop.

## 3.2 THE PROTECTION MECHANISMS

The D150 is protected against all the common hazards which plague highpower amplifiers, including shorted, open, and mismatched loads; overloaded power supplies; excessive temperature; chain destruction phenomena; input overload damage; and high frequency overload blowups.

Protection against shorted and mismatched loads is provided by an instant-acting limiter which instantaneously limits at the volt-ampere product to the maximum safe-stress value for the output transistors.

The area in which the amp will drive the load without being V-I limited is depicted by the cross-hatched areas of Fig. 3-2.

If a load initiates protection in the amplifier, it can be detected generally by watching the transfer characteristics of the amplifier on an oscilloscope or by plotting the load's V-I behavior, if known, on to Fig. 3-2. In applications where the load is a loudspeaker, amplifier protection will be

evidenced by distortion in the speaker. The audible effect ranges from something resembling crossover notch distortion to a snapping sound, depending in the over-all load characteristics. Speaker systems which are truly 8 ohms or greater will not initiate the protection system.

The AC line for 120VAC is fused with a 4A, 250V type AG fuse (on 240, 250VAC, 2A type AG). The use of any other type of fuse will invalidate the warranty.

On the chassis (see Fig. 2-2) is mounted a thermal switch which protects the amplifier against insufficient ventilation. If it becomes too hot, the AC line power will be interrupted until the temperature falls to a safe level, whereupon power will automatically be restored. When such an event occurs, the external symptoms are: no output, and a warm amplifier.

All the amplifier's voltage-amplifiers circuitry is designed to be inherently current-limited. Thereby, if any of the devices should fail, (which is extremely unlikely) no damage will occur to the rest of the stages.

The input stage is protected against overdrive damage by a series limiting resistor should the input signal level ever become very excessive.

The amplifier features a controlled slewing-rate which, coupled with the V-I limiter, protects the amplifier from blowups when fed large RF input signals.

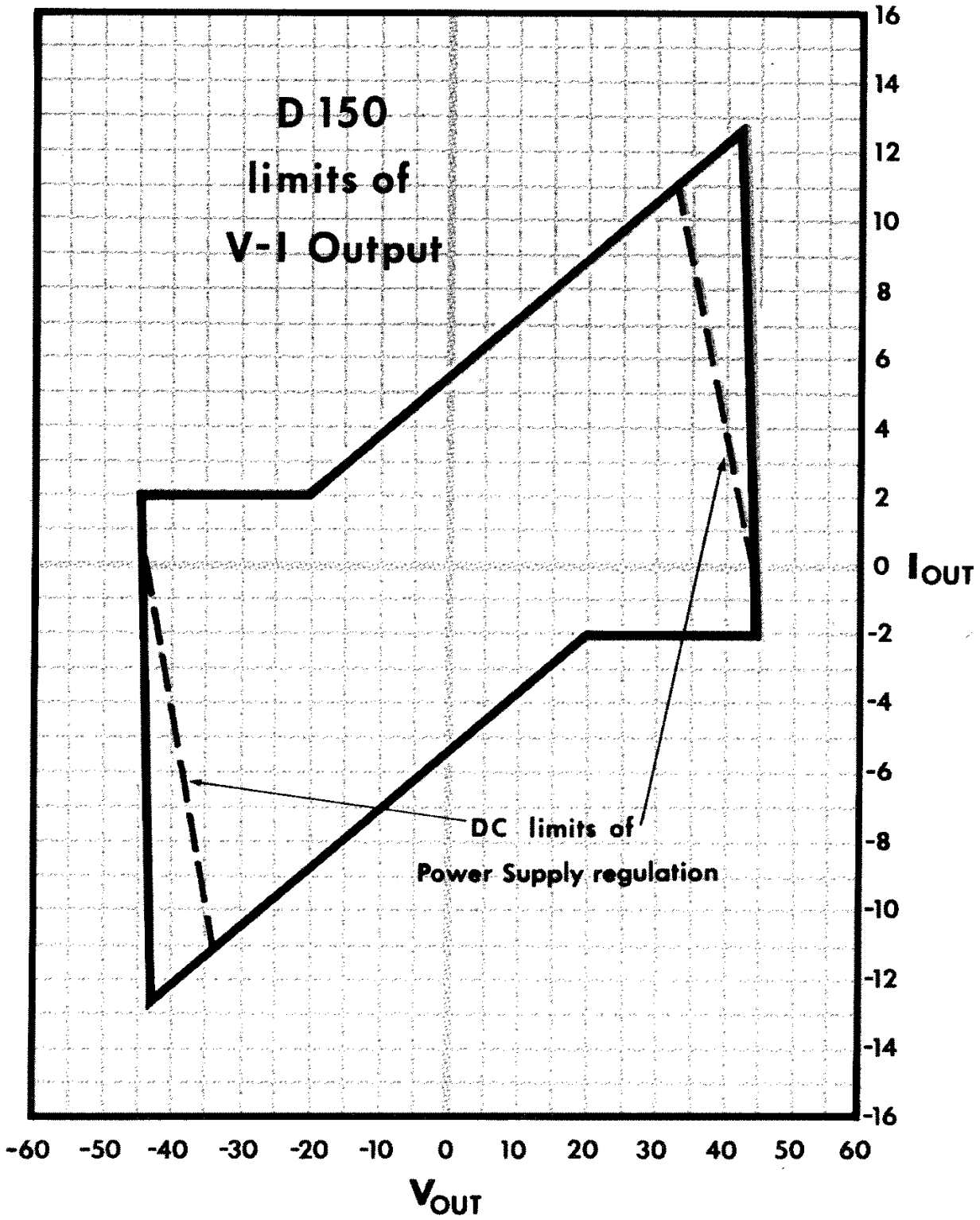

FIG. 3 - 2  
 GRAPH of V - I OPERATING RANGE of D-150 OUTPUT

### 3.3 OPERATING PRECAUTIONS

The following are a number of operating precautions given as an aid to understanding proper and improper amplifier usage:

1. Use care in making connections, selecting signal sources, and controlling the output level. The loudspeaker you save may be your own. CROWN is not liable for any damage done to loads due to careless amplifier usage or deliberate overpowering. For pointers on load protection see Section 3.4.
2. Never parallel the two outputs by directly tying them together or parallel them with any other amp's output. Such connection does not result in increased power output. Damage incurred by such operation is not covered by the warranty.
3. Never drive a transformer-coupled device or any other device which appears as a low frequency short (less than 3 ohm) without a series isolating capacitor. Such operations may damage the device and/or needlessly activate the V-I limiting (see Fig. 2-4).
4. Do not short the ground lead of an output cable to the input signal ground as oscillations may result from forming such a ground loop.
5. Operate and fuse the amplifier only as set forth in section 3.2.
6. Operate the amplifier from AC mains of not more than 10% above the selected line voltage and only on 50, 60 or 400Hz AC. Failing to comply with these limits will also invalidate the warranty.
7. Never connect the output to a power supply output, battery, or power main. Damage incurred by such a hookup is not covered by the warranty.
8. Do not expose the amplifier to corrosive chemicals such as soft drinks, lye, salt water, etc.
9. The amplifier is not recommended for high power industrial usage at frequencies above 20KHz.
10. Tampering in the circuit by unqualified personnel or the making of unauthorized circuit modifications invalidates the warranty.
11. Do not expose the output leads to areas likely to be struck by lightning. Such an installation could invalidate the amplifier.

### 3.4 LOAD PROTECTION METHODS

The most common of all protection schemes is a fuse in series with the load. The fuse may be single, fusing the overall system. Or, in the case of a multi-way speaker system, it may be multiple with one fuse on each speaker.

Fuses help to prevent damage due to prolonged overload, but provide essentially no protection against damage that may be done by large transients and such. To minimize this problem, high-speed instrument fuses such as Littlefuse 361000 series are most appropriate for such applications. For a nomograph showing fuse size vs. loudspeaker ratings refer to Fig. 3-3.

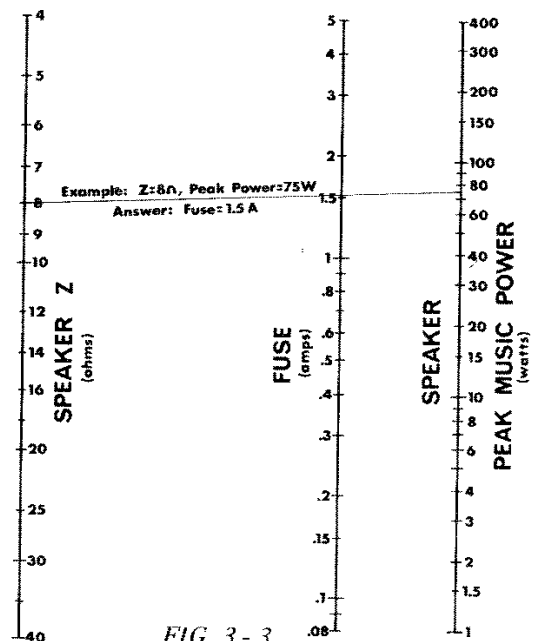

FIG. 3-3

#### FUSE SELECTOR NOMOGRAPH FOR LOUDSPEAKER PROTECTION

Another form of load protector is shown schematically in Fig. 3-4. Whenever the load is overdriven, a relay switches a lamp in series with the load, smoothly relieving the overload. The lamp then doubles as an overdrive indicator as it glows. If overdrive is unreasonably severe, the lamp will serve as a fuse. By adjusting the relay tension adjustment and the protection level control, this system is useful from 25 to 200 watts for a typical 8 ohm load.

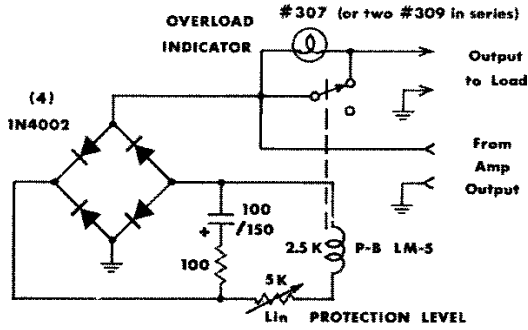

FIG. 3 - 4  
RELAY-CONTROLLED PROTECTOR  
WITH OVERLOAD INDICATOR

Another more sophisticated form of overload protector relieves the overload by controlling the amplifier's input signal which is creating the overload. This form of protector not only saves the load but also eliminates amplifier overload. With this device, it is possible to operate the amplifier at its maximum level with a minimum of clipping. This device is shown schematically in Fig. 3-5. It features an overdrive indicator, distortionless photo-optical control, and a Protection Level control giving adjustment from 1W to 200W when driving 8 ohms.

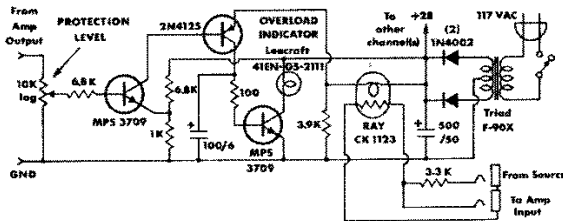

FIG. 3 - 5  
PEAK POWER LIMITING COMPRESSOR  
WITH OVERDRIVE INDICATOR

A common problem which causes damage and irritation is the turn-on thump problem typical to many signal sources. Fig. 3-6 shows the schematic of a muter which, when inserted in the input signal line, mutes for several seconds before connecting the source to the amplifier, thereby eliminating turn-on transients. It also removes turn-off transients occurring after the relay drops open (=0.1 sec.).

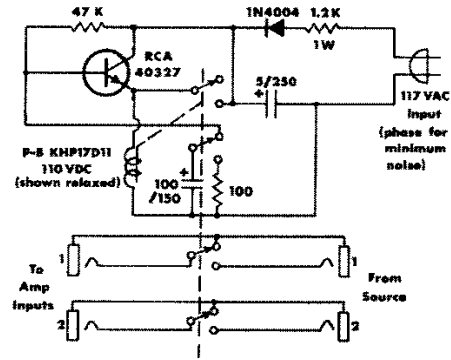

FIG. 3 - 6  
TURN-ON-TRANSIENT MUTER  
FOR LOAD PROTECTION

NOTE: When using the CROWN IC-150 this muter is not required. A built-in muter protects your speakers from any signal source whose AC power is switched by the IC-150.

### 3.5 CLEANING

The CROWN D150 has a rugged anodized front panel (optional) for life-time service. The panel can be cleaned with a moist cloth and mild detergent. Never use steel wool, scouring powder, lye solution, or any strong abrasive cleaner as these will damage the panel's finish.

The chassis should require no more cleaning than periodic dusting with a clean dry cloth.

#### 4.1 PRINCIPLES OF OPERATION

The D150 has two direct-coupled amplifier circuits which employ a dual IC op amp and silicon transistors in all amplifier stages. The CROWN designed and developed circuit represents a level of quality and performance presently un-equalled in the field of audio amplifier design.

The dual IC op amp is of a low noise type having a large gain bandwidth. The results of using it for the input voltage amplifier is that a maximum amount of feedback is applied reducing distortion to record low values. The typical full output (75w, 8 ohms) SMPTE IM is 0.002%. This implies that the full power 1KHz THD is in the vicinity of 0.0005% which is below the capability of present harmonic distortion measurement systems. Multiple feedback loops are employed to allow a maximum of overall feedback.

The lack of noise is evidenced by a typical 20Hz - 20KHz effective input noise of 1.25 u volts which produces an effective 8 ohm output of 80 micro-micro (pica) watts.

The output stage is a quasi-complementary format employing the CROWN class AB+B technique which uses no bias current in the output transistors. The result is maximum efficiency with minimum crossover notch distortion and idling amplifier-heat. Thus there is no bias current adjustment, as the output circuit is not temperature-tolerance critical.

In the new output circuit, the driver transistors carry the bias current, while the output transistors serve only as boosters. The output transistors sense when the driver transistors are delivering significant current to the load and take over and deliver the large load currents.

The output circuit is protected by a V-I limiter which limits the drive to the output configuration whenever the output transistors are overloaded. V-I (volt-ampere) limiting is inherently superior to all other forms of protection as it directly senses the overload condition and acts instantly to relieve the overload, acting only so long as the overload exists. The result is complete freedom from program delays with reliability and maximum safe output power.

The power supply is a continuous-duty type. The main DC supplies are full-wave capacitor input type with a heavy duty bridge rectifier assembly. Computer grade electrolytics furnish over 20 joules of energy storage.

The D150 represents nothing short of the highest quality in both circuitry and components. It should provide a lifetime of trouble-free service for the most discriminating users.

#### 4.2 TEST PROCEDURES

The sole function of this section is to list precautions essential to obtaining accurate measurements when dealing with high-power, high-purity amplifiers such as the D150.

1. Use the proper line voltage, which is the one for which the amplifier is connected. The voltage should be measured throughout the testing with a peak reading meter, and adjusted to the RMS equivalent voltage (to compensate for line voltage regulation errors during the course of the measurements). All measurements should be taken at the power amplifier's plug. When testing for IHF music-power measurements, the line voltage is to be set at 120V when the amplifier is connected to 120V, (IHF standards). If the amp is connected for 240V equivalent test may be given by applying 240 volts.
2. The load should be resistive, having less than 10% reactive component at any frequency up to five times the highest test frequency. The resistor should be capable of continuously dissipating the full output of the amplifier while maintaining its resistance within 1% of its rated value. The load should employ only high-current connectors (if any), and be connected to the binding-post output terminals. All output measurements should be taken at the amplifier output terminals, and not anywhere along the output cable thru which the load current is flowing.
3. The input level controls should be set to maximum for all distortion tests to assure repeatability of all measurements.
4. When measuring hum and noise, all inputs should be disconnected from the amplifier and the level controls set to minimum or to maximum, preferably minimum.
5. Whenever possible avoid ground loops in the test equipment caused by connecting the output ground to the input ground. *Never* connect the ground of the cable going to the load back to the input ground.

Ground loops are especially obnoxious when measuring distortion. An I-M distortion analyzer, for example, has its input and output terminals tied to a common ground. Such a test should use an ungrounded output return, with the output lead(s) wrapped around the well-shielded and grounded input cable.

6. Always monitor the test oscillator when measuring frequency response. Use a wide-band AC voltmeter; or use the same meter for both input and output level measurements, if the meter's frequency response is known not to be dependent on attenuator settings.
7. Accuracy in measuring voltages for computing wattage is critical. For example, a 2% voltage error together with a 1% resistance error can result in an error of 5 watts power into 8 ohms.
8. Residual distortion and noise levels should be fully known for all the test equipment in order to accurately evaluate the amplifier.
9. Never attempt to measure damping factor by placing abnormal loads on the output. D-F measurements taken during clipping, or any other form of overload, are meaningless. The preferred method is to apply an externally generated current to the output terminals and measure the resultant voltage at the terminals. A convenient current is one ampere—as the resultant voltage will read directly in ohms for  $[Z_o]$ . Damping Factor is defined as  $[\frac{Z_o}{Z_L}]$ , where  $[Z_L]$  is typically 8 ohms. A convenient generator for the 1A. current is that amplifier channel not under test. A non-inductive resistance of 8 ohms—coupled between both channels' output terminals—will provide 1A. when 8 volts are impressed across the resistor (by that channel not under test).
10. Never measure hum and noise when in the presence of strong magnetic fields. The amplifier should be at least 4 inches away from any large metallic objects or shield plates for a reading to be meaningful.

11. Noise measurements should be taken with a band-pass filter of 20-20KHz. For audio purposes the measurement of noise above 20KHz is meaningless.

### 4.3 SERVICE

Should service other than routine fuse replacement ever be required, it is recommended that the unit be returned to the factory in the original packing (or replacement, if damaged). For warranty service the machine must be returned to the factory or warranty stations. The CROWN warranty is detailed on page 7.

Because of the level of circuitry sophistication of the D-150, only the most competent technicians should be allowed to service it.

Many of the parts are standard items stocked by most supply houses. However, there are several which appear to be standard parts but are actually different. Although standard parts may be used in an emergency, best results will be with factory parts. A number of the parts are available only from CROWN.

When ordering parts, be sure to give the amplifier serial number as well as the part number and description. Rated firms will be billed, otherwise shipments will be C.O.D.

Before returning an amplifier to the factory for service, authorization should first be obtained from the service manager. All shipments must be sent by Railway Express or truck freight, prepaid and insured at total value. The factory will return your serviced unit by Railway Express or truck freight, collect, and will add C.O.D. charges in the event that the cost is not covered by registered warranty.

# APPLICATION NOTES

## APPLICATION NOTE 1

Evaluating the V-I (volt-ampere) needs of a load: Many loads exhibit large reactances (or energy storage), which limits a power amplifier's ability to deliver a maximum power. If a load stores energy, which in turn flows back into the amplifier, it is clear that the maximum power efficiency of the system is not being achieved. Power that flows back into a linear amplifier must necessarily be dissipated in the form of heat. A pure reactance is not capable of dissipating any power; therefore to drive such a load would only cause power amplifier heating.

In practice all loads exhibit some energy dissipation—however large their energy storage characteristics may be. The ideal coupling to any load is one that optimizes the desired dissipation component while minimizing the reactive or stored-energy component that is seen by the amplifiers output terminals.

In applications where the input is sinusoidal and of small proportional frequency deviation, a relatively stable load may be resonantly tuned to present a real value of impedance to the amplifier.

Any load, no matter how complex its behavior, has a V-I operating range which may be mapped by the following test.

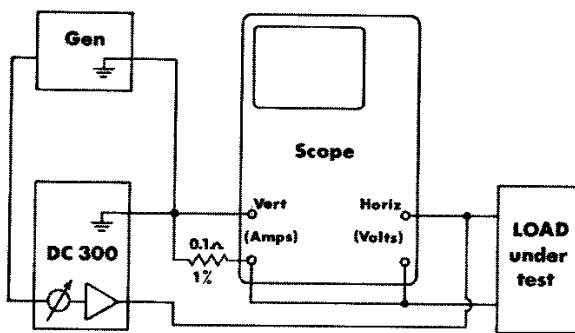

The maximum voltage and amperage excursions in all directions about zero (center of scope screen) define the volt-ampere operating range of the load. If a load is known to be linear over its operating range it is not necessary to supply the maximum desired power to the load. The test may be conducted at low signal levels and the current-sensing resistor (indicated as 0.1Ω) may be enlarged to a convenient value for the oscilloscope's deflection sensitivity. The resulting plot may be then linearly scaled to the desired operating level.

In the following example a reactive load is being fed a sinusoid of varying intensity. The V-I limits of the amplifier are super-imposed in dotted lines. It can be seen that the amplifier needs to be in the hysteresis position to drive this load with this sinusoidal input.

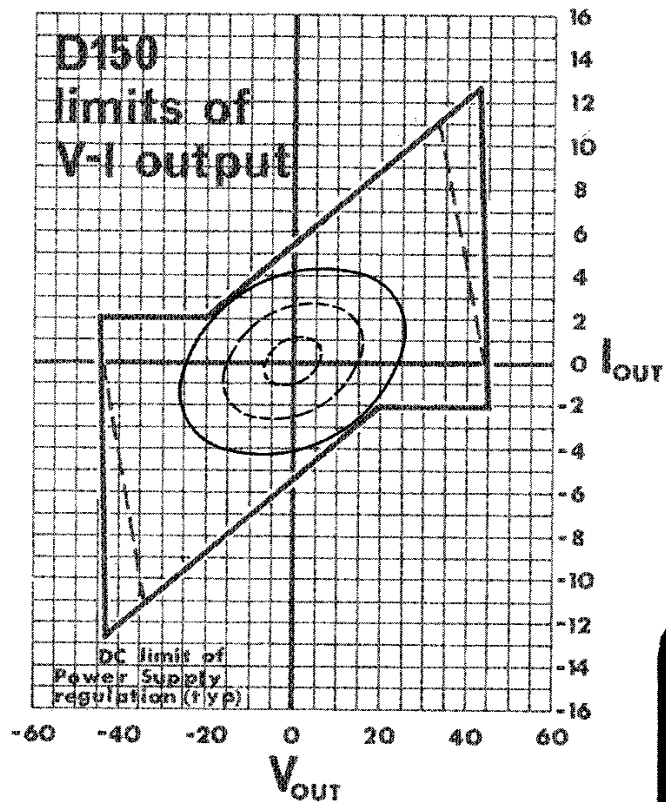

## APPLICATION NOTES

## D150 MONO CONVERSION

## APPLICATION NOTE NO. 2

## A. Wire Changes

1. Remove the two screws (adjacent to the inputs and gains) from the board-cover. Lift cover straight up.

2. Ground No. 1 input (chan. 1) by soldering a 3/4" bare wire (as shown in fig. 1.) between points A and B.

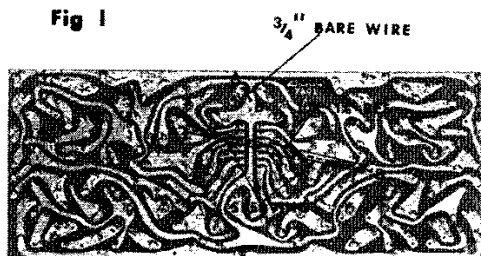

3. Connect a 10K, 1%, 1/2w resistor—with sleeving on both leads—between points C and D, using pre-drilled holes.

## B. Operation

1. Make output cable as shown in Fig. 2.

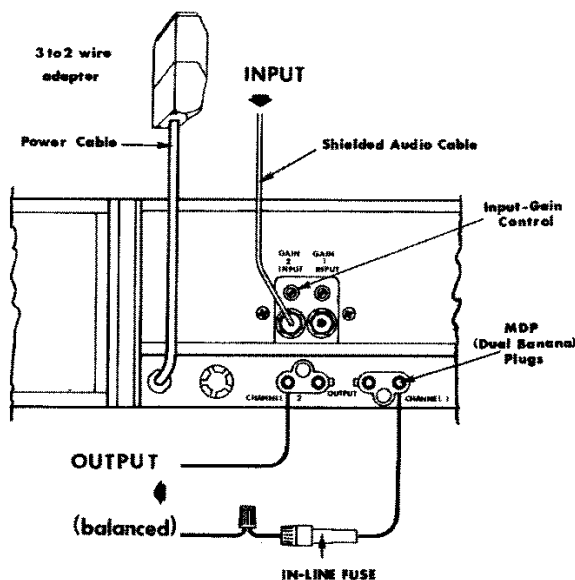

2. Connect one lead to "HOT" (red) amplifier output-post of channel 1, the other lead to "HOT" of channel 2.

**CAUTION: DO NOT CONNECT EITHER "HOT" OUTPUT TO GROUND (EITHER BLACK POST).**

3. Connect an 8 ohm (or higher) load to the output cable. A fuse is recommended! (Refer to Fig. 3-3 on pg. 17 of D-150 manual).

4. Connect input signal, using std. 3/4 phone plug, to channel 2 input-jack. The "channel 2" gain (input level control) may be adjusted for desired output-level.

5. The 3-wire AC powercord meets U/L requirements, but many installations will require a 3-to-2 wire adapter to avoid "ground-loops"—circulating currents caused by more than one ground-path.

## C. Specifications

|                    |   |
|--------------------|---|
| F - Resp.          | $\pm .15\text{db}$ 20 Hz-20 KHz 1W 8 Ohm  |
|                    | $\pm 1\text{db}$ 4 Hz - 60 KHz 1W 8 Ohm   |
| Power Resp.        | $\pm 1\text{db}$ 5Hz - 15KHz 250W 8 Ohm   |
| Power at Clip Pt.  | Typically 320W into 8 Ohm 1 KHz   |
| Total Output (1HF) | Music Power 400W 8 Ohm 210W<br>16 Ohm   |
| 1M Distortion      | Less than .1% from 10mW to full output<br>Typically .01% at 250W  |
| Damping Factor     | Greater than 140 Zero - 1KHz 8 Ohm  |
| Hum and Noise      | 110 db below 250W (typically 117db)   |
| (20Hz-20KHz)       |   |
| Slewing Rate       | 12 Volts/Microsecond  |
| Load Impedance     | 8 Ohm or higher (complete stability with any load)  |
| Output Signal      | Balanced  |
| Input Sensitivity  | 1.1V for 250W into 8 Ohm  |
| Input Impedance    | 25K Nominal   |
| Voltage Gain       | 32.3db $\pm .2\text{db}$  |
| Protection         | Short, mismatch, and open circuit proof. V-1 limiting is instantaneous with no annoying thumps, cutout, etc. Thermal switch in AC line protects against overheating caused by insufficient ventilation. Controlled slewing rate voltage amplifiers protect overall amplifier against RF burnouts. |
| Power Supply       | Two massive capacitors with energy storage exceeding 20 joules. Total of two regulated supplies for complete isolation and stability. No fuses except for AC power line.  |
| Power Requirements | Requires 50-400 Hz AC connectable for 120V or 240 VAC $\pm 10\%$ . Draws 30 watts or less on idle.  |



|                 |  |            |   |
|-----------------|--|------------|---|
| Heat Sinking    | <p>Draws 500 watts or less at 250W out into 8 Ohm.</p> <p>Entire chassis is used as heat sink. Chassis is a rugged heavy gauge aluminum extrusion for maximum heat conduction.</p>       | Dimensions | <p>male connector on 5 ft. minimum cable.</p> <p>16 1/2" long, 5" wide, and 8" high (without panel), 17" long, 5 1/4" high, 8 3/4" deep with front panel (optional). 19" standard rack mounting hardware included with front panel.</p> |
| Controls        | <p>Input level control mounted adjacent to input connector.</p>  | Weight     | <p>22 lb. net wt., 24 lb. with front panel</p>  |
| Input Connector | <p>Input - 1/4" phone jack</p> <p>Output - Color coded binding posts. Center terminals of output (2) coded black. Balanced outputs coded red.</p> <p>AC Line - Three-wire (grounded)</p> | Finish     | <p>Black anodized chassis.</p> <p>Front panel (optional) is bright anodized brushed aluminum with black leatherette lower panel.</p>  |

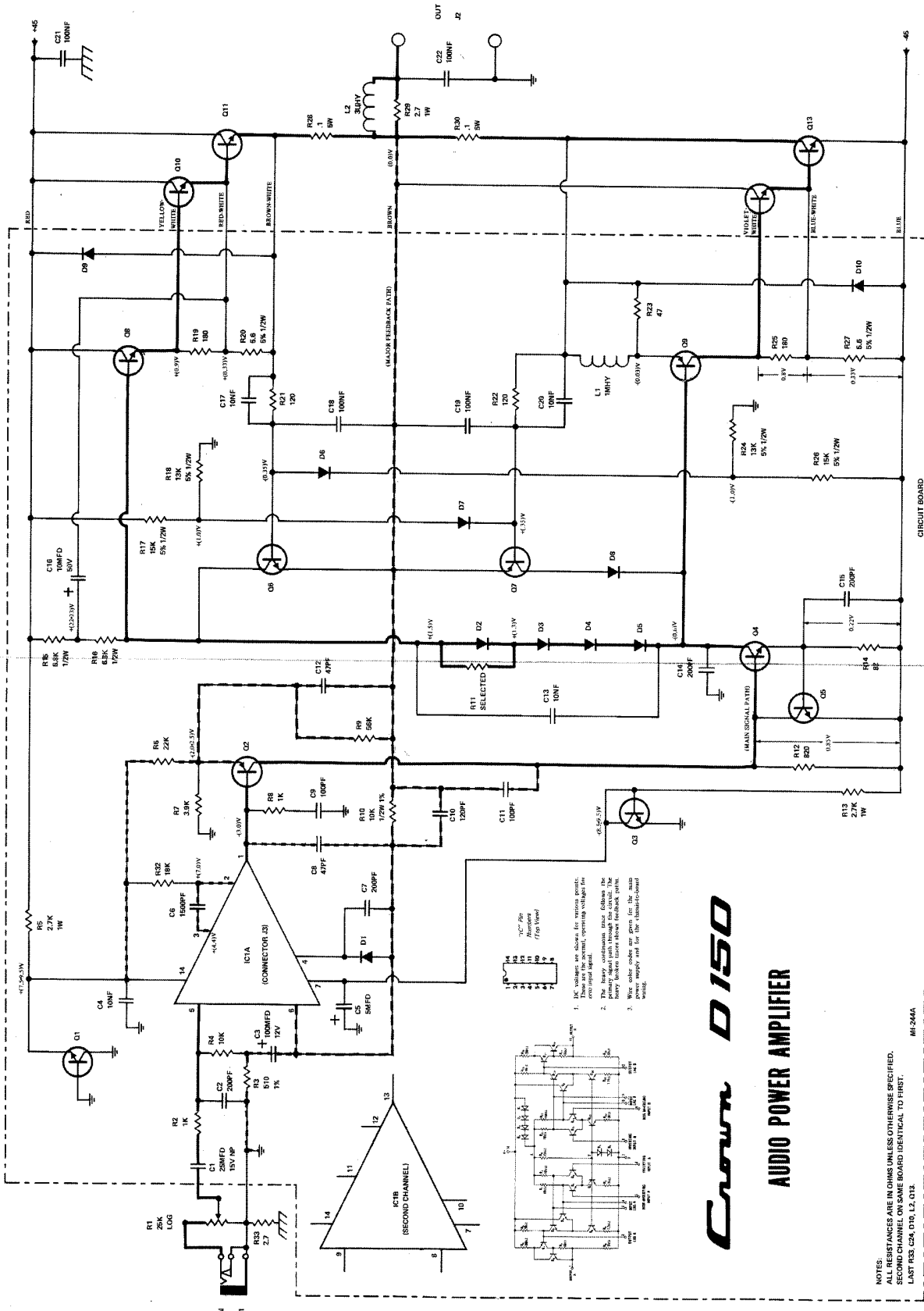

# Crown D150

## AUDIO POWER AMPLIFIER

NOTES:  
 ALL RESISTANCES ARE IN OHMS UNLESS OTHERWISE SPECIFIED.  
 SECOND CHANNEL ON SAME BOARD IDENTICAL TO FIRST.  
 LIST RES. C24, D10, L2, Q13.

M1-244A

1. The values are shown for reference only. The actual values may vary slightly due to component tolerances.
2. The heavy continuous line follows the heavy feedback trace shown below.
3. Wire color codes are given for the main supply and for the classed-out source.

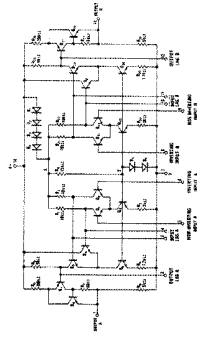

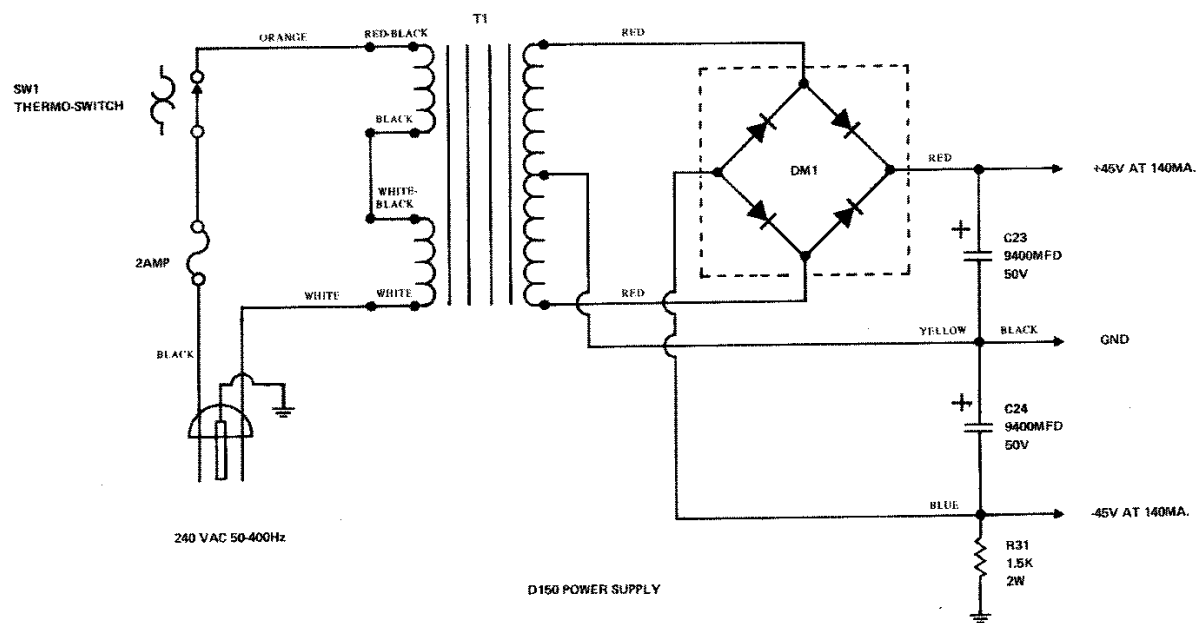
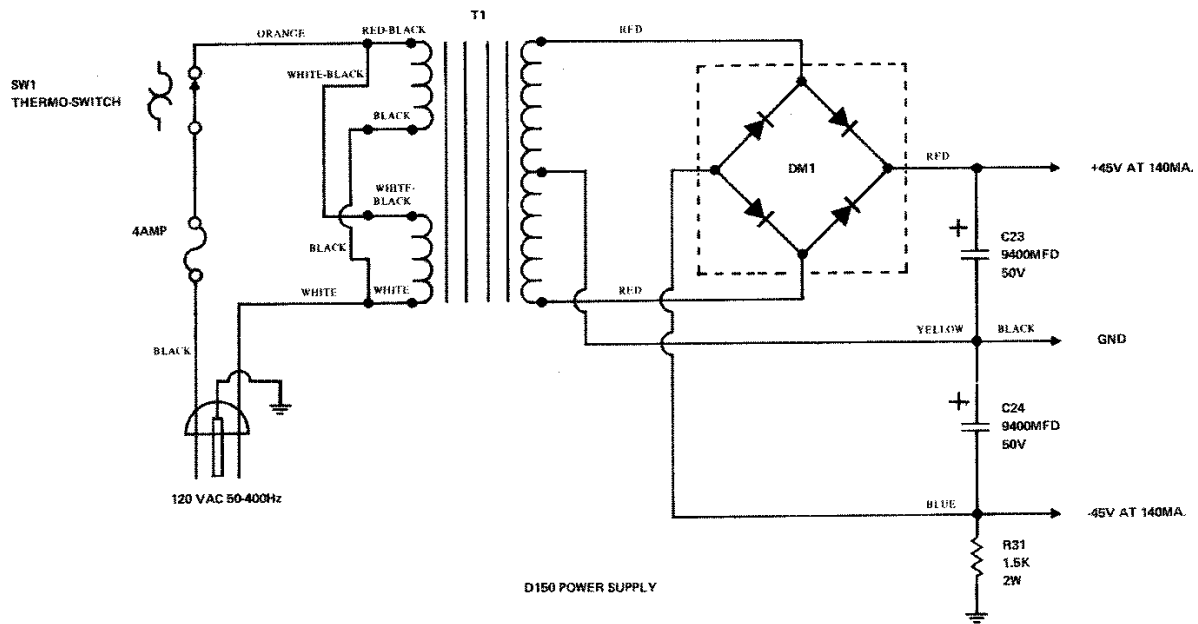

# D150 PARTS LIST

## CIRCUIT BOARD

| QUAN.                 | SCHEMATIC REF.         | DESCRIPTION       | CPN  |
|-----------------------|------------------------|-------------------|------|
| <b>RESISTORS</b>      |                        |                   |      |
| 2                     | R23                    | 47 Ohm ¼ watt     | 1011 |
| 2                     | R5, R13                | 2.7K 1 watt       | 1079 |
| 4                     | R15, R16               | 6.8K ½ watt       | 1639 |
| 2                     | R10                    | 10K ½ watt Film   | 2343 |
| 2                     | R11                    | Selected          |      |
| 4                     | R2, R8                 | 1K ¼ watt         | 2627 |
| 2                     | R7                     | 3.9K ¼ watt       | 2630 |
| 2                     | R4                     | 10K ¼ watt        | 2631 |
| 4                     | R21, R22               | 120 Ohm ½ watt    | 2804 |
| 4                     | R19, R25               | 180 Ohm ¼ watt    | 2873 |
| 2                     | R9                     | 56K ¼ watt        | 2873 |
| 4                     | R17, R26               | 15K ½ watt Film   | 3133 |
| 4                     | R20, R27               | 5.6 Ohm ½ watt    | 3299 |
| 2                     | R14                    | 82 Ohm ¼ watt     | 3300 |
| 2                     | R12                    | 820 Ohm ¼ watt    | 3301 |
| 2                     | R22                    | 22K ¼ watt        | 3302 |
| 2                     | R3                     | 510 Ohm ¼ watt    | 3304 |
| 4                     | R18, R24               | 13K ½ watt Film   | 3305 |
| 2                     | R32                    | 18K ¼ watt        | 2633 |
| <b>CAPACITORS</b>     |                        |                   |      |
| 4                     | C8, C12                | 47pf              | 3409 |
| 4                     | C9, C11                | 100pf             | 3410 |
| 8                     | C2, C7, C14, C15       | 200pf             | 3411 |
| 7                     | C4, C13, C17, C20      | 0.01 Disc         | 1751 |
| 4                     | C18, C19               | 0.1 Disc          | 2600 |
| 1                     | C5                     | 5/30 MFD          | 2868 |
| 2                     | C3                     | 100/12            | 2869 |
| 2                     | C6                     | 0.0015 Mylar      | 3089 |
| 2                     | C1                     | 25/15 NP          | 3186 |
| 2                     | C16                    | 10/50 Vertical    | 3289 |
| 2                     | C10                    | 120pf             | 3290 |
| <b>SEMICONDUCTORS</b> |                        |                   |      |
| 4                     | D2, D8                 | 1N270 Diode       | 3447 |
| 2                     | Q6                     | 2N1304 Transistor | 2721 |
| 2                     | Q7                     | 2N1305 Transistor | 2817 |
| 4                     | D9, D10                | 1N4003 Diode      | 2851 |
| 2                     | Q9                     | SS7304 Transistor | 2923 |
| 4                     | Q1, Q3, Q5             | NPN Transistor    | 2961 |
| 2                     | Q2                     | PNP Transistor    | 2982 |
| 12                    | D1, D3, D4, D5, D6, D7 | 1N4148 Diode      | 3181 |
| 1                     | IC1                    | ua739C I.C.       | 3231 |
| 2                     | Q4                     | MPS101 Transistor | 3232 |
| 2                     | Q8                     | NPN Transistor    | 3348 |

## CIRCUIT BOARD

| QUAN.                | SCHEMATIC REF. | DESCRIPTION          | CPN  |
|----------------------|----------------|----------------------|------|
| <b>MISCELLANEOUS</b> |                |                      |      |
| 8                    |                | Transistor Pads      | 1250 |
| 4                    |                | PC Component Recept. | 1655 |
| 2                    | L1             | 1mhy Choke           | 2441 |
| 4                    |                | Therma Sink          | 3175 |
| 14                   |                | I.C. Terminals       | 3308 |
| 1                    |                | P.C. Board           | 7891 |

## CHASSIS

| SCHEMATIC REF.                   | DESCRIPTION                | CROWN PART NO. |
|----------------------------------|----------------------------|----------------|
| <b>CAPACITORS</b>                |                            |                |
| C21, C22                         | 0.1mfd 200V Mylar          | 2938           |
| C23, C24                         | 9400mfd 50V                | 3309           |
| <b>TRANSFORMERS &amp; CHOKES</b> |                            |                |
| T1                               | Power Transformer          | 3286           |
| L2                               | Output Inductor            | 40959          |
| <b>CONNECTOR</b>                 |                            |                |
| J1                               | 112A Hi-D Jacks            | 3423           |
| J2                               | Dual Binding Post          | 2823           |
| J3                               | Power Cord                 | 2824           |
| <b>FUSES</b>                     |                            |                |
| F1                               | 4A Fuse                    | 1261           |
| <b>POTENTIOMETERS</b>            |                            |                |
| R1                               | 25K Pot                    | 3307           |
| <b>RECTIFIERS AND DIODES</b>     |                            |                |
| DM1                              | MDA980-2 Bridge Rectifier  | 3296           |
| <b>RESISTORS</b>                 |                            |                |
| R28, R30                         | 0.1 Ohm 5 Watt Resistor    | 3291           |
| R29                              | 2.7 Ohm 1 Watt Resistor    | 1001           |
| R31                              | 1.5K 2 Watt Resistor       | 3303           |
| <b>SWITCH</b>                    |                            |                |
| SW1                              | Thermo Switch              | 2799           |
| <b>TRANSISTORS</b>               |                            |                |
| Q10, Q12                         | 2N3585 Selected Transistor | 3295           |
| Q11, Q13                         | 2N3773 West. Transistor    | 3176           |
| <b>MECHANICAL ASSEMBLIES</b>     |                            |                |
|                                  | P.C. Board                 | 40971          |

CROWN PART NO. DESCRIPTION

| MECHANICAL PARTS |                                      |       |                                |
|------------------|--------------------------------------|-------|--------------------------------|
| 1220             | 11B Terminal                         | 3297  | Flag Housing                   |
| 1290             | Tinnerman Captive Nuts               | 3298  | 0.250 Faston Terminal          |
| 1306             | Jack Ins. Shoulder Washer            | 3348  | D-150 Chassis                  |
| 1646             | Flat Fiber Washer                    | 3310  | 614 Inductor Spacer            |
| 1823             | No. 6 Star Lockwasher                | 3311  | 614 Cover Spacer               |
| 1824             | No. 4 Star Lockwasher                | 3312  | 806 Ground Lug (.196 Hole)     |
| 1889             | 6/32 Hex Nut                         | 3316  | 614 Board Clip                 |
| 1938             | 4/40 Hex Nut                         | 3318  | 614 Bottom Cover               |
| 1951             | No. 8 Star Lockwasher                | 3320  | Capacitor Mnt Ins Washer       |
| 1986             | 8/32 Hex Nut                         | 3453  | 614 Heat Sink                  |
| 1994             | 10/32 x 1/2                          | 3323  | 2-G-1 Terminal (.199 Hole)     |
| 2045             | 3/16 Flat Washer                     | 3324  | 8/32 x 1-3/4 Stud              |
| 2046             | 3/8 Bright Washer                    | 3330  | 10/32 x 1/2 O Hd Phil Screw    |
| 2049             | 10/32 x 3/8 Phil. Bd Hd Screw        | 3332  | 614 Back Label                 |
| 2136             | 8/32 x 1/4 Flat Head Screw           | 3334  | 4/40 x 5/8 Rd Hd MScrew        |
| 2170             | 10/32 Hex Nut                        | 3335  | NY04-187 Shoulder Washer       |
| 2176             | 6/32 x 1/2 Bd Hd Phil Screw          | 3419  | D-150 Amplifier Label          |
| 2189             | Bright Washer                        | 2109  | 6/32 x 1/2 Socket Cap Screw    |
| 2271             | 8/32 x 1/4 Truss Head Phillips Screw | 3202  | End Caps                       |
| 2279             | No. 10 Star Lockwasher               | 3314  | 614 Front Panel                |
| 2553             | TO-66 Mica Washer                    | 3327  | Front Panel Label              |
| 2649             | TO-3 Shoulder Washer                 | 7889  | 614 Transformer Cover          |
| 2708             | No. 8 x 3/8 Hex Sht Mtl Screw        | 3342  | SI-5025 Rubber Feet - Black    |
| 2803A            | SR-5P-4 Strain Relief                | 40967 | Pre Assembled Board Cover      |
| 2934             | 389 Solder Lug (.218 Hole)           |       |                                |
| 2935             | 505 Solder Lug (.169 Hole)           |       |                                |
| 3040             | Control Nut                          | 40377 | ACCESSORY HI-FI<br>ADAPTER KIT |
| 3163             | 505 Solder Lug (.144 Hole)           |       |                                |
| 3179             | TO-3 Insulator                       |       |                                |
| 3180             | TO-3 Plastic Film Insulator          | 2957  | Fuse, 3AG, 1 1/2 Amps          |
| 3256             | HTA Fuseholder                       | 2981  | MDP Plug                       |
| 3292             | Transformer Wrap Around              | 3060  | 3AG Fuse Holder                |
| 3293             | 614 Control Plate                    | 3069  | 74B Wire Connector             |

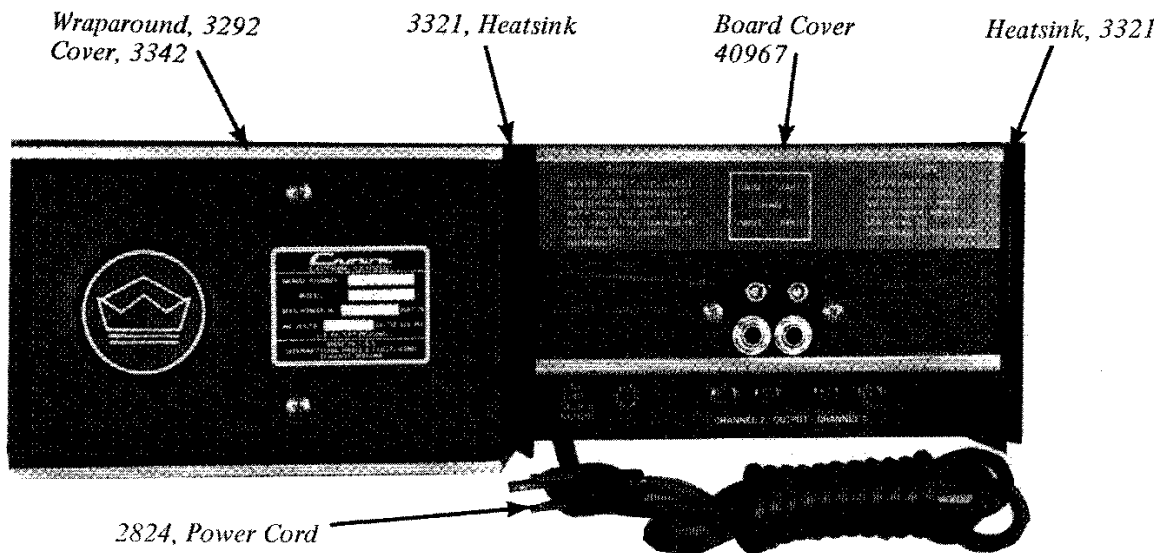

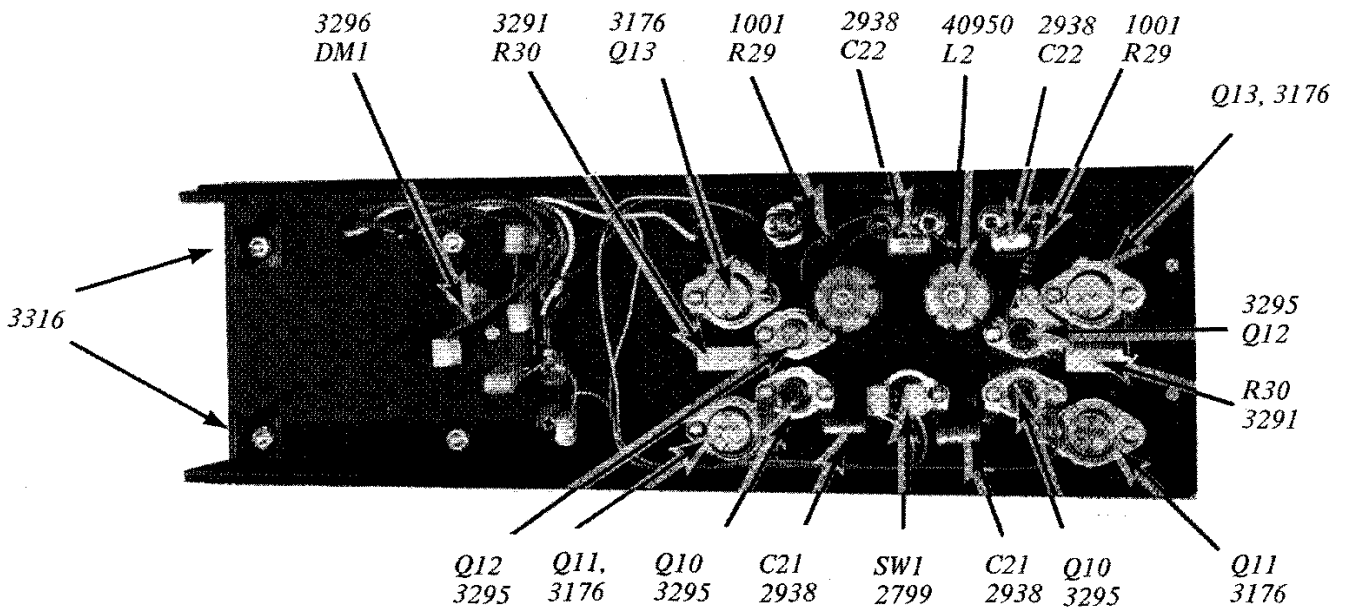
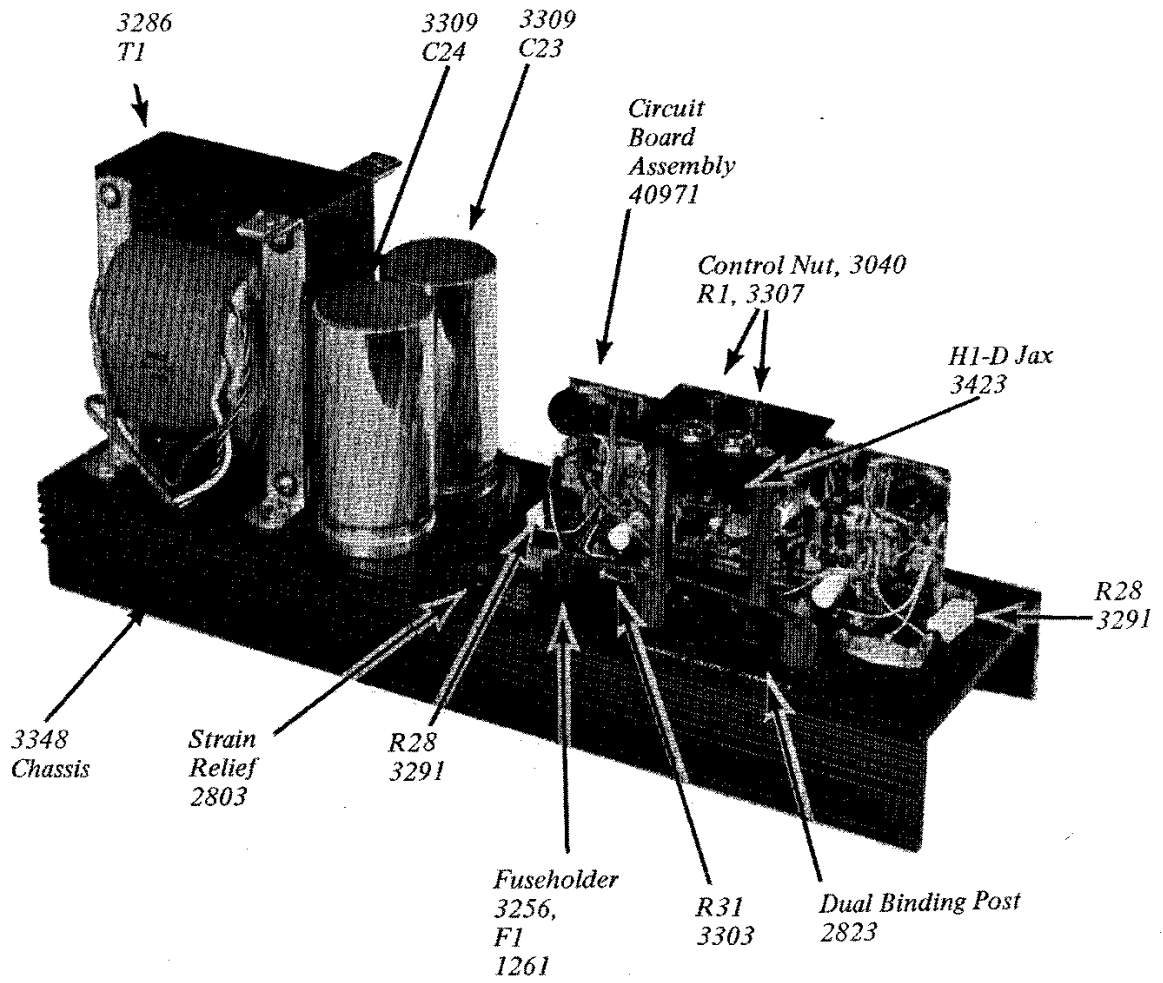

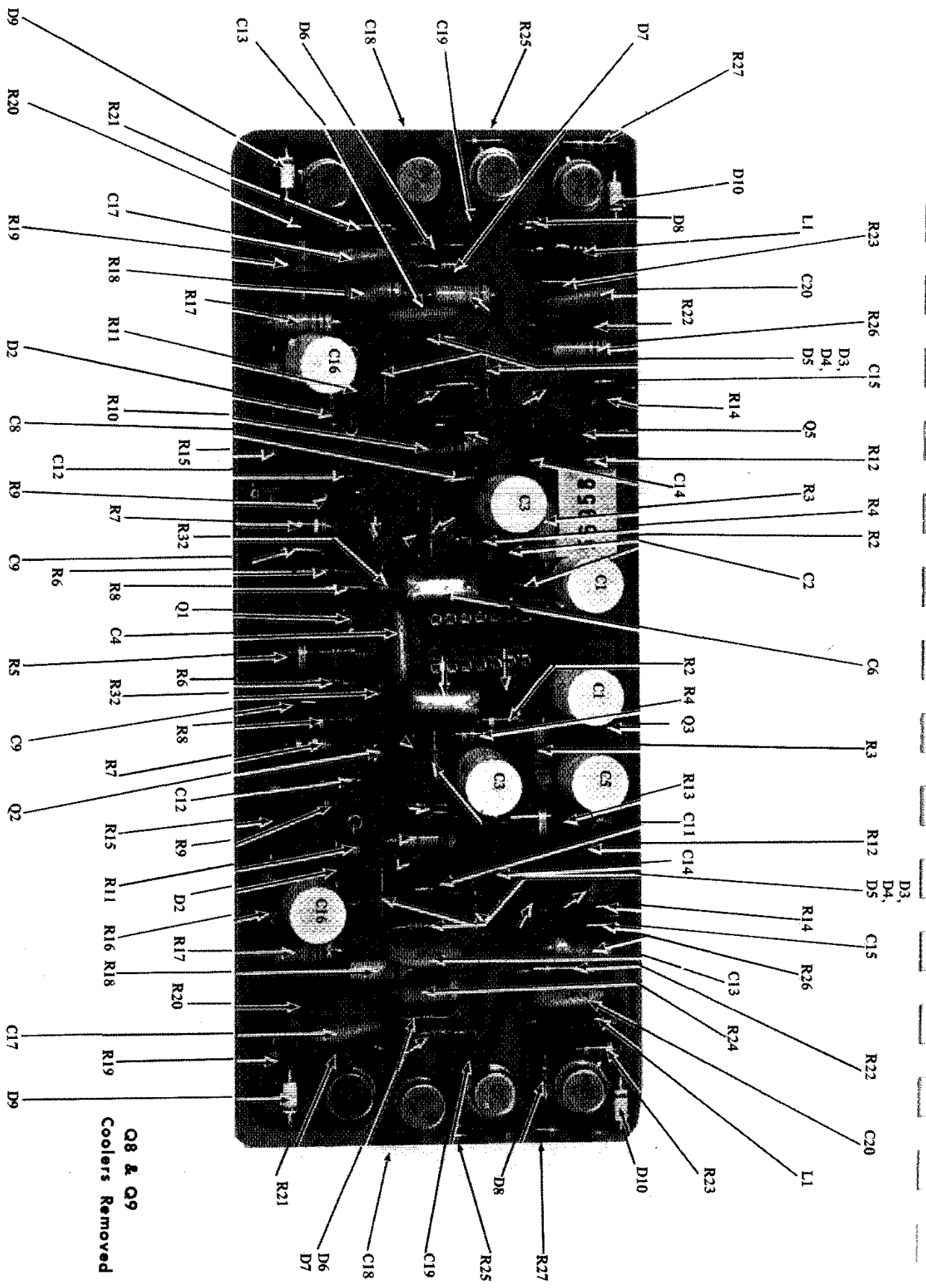

D-150 CIRCUIT BOARD (COMPONENT SIDE)

Q8 & Q9  
Coolers Removed