

DC-300A II

REFERENCE MANUAL



Some models may be exported under the name *Amcron*®.



Applies only to
120 VAC North
American units.

© 1996 by Crown International, Inc., P.O. Box 1000, Elkhart, Indiana 46515-1000 U.S.A. Telephone: 219-294-8000. The DC-300A II is produced by the Professional Audio Division of Crown International, Inc. Trademark Notice: *Amcron*®, *Crown*®, *Com-Tech*®, *IOC*®, *IQ System*® and *Macro-Tech*® are registered trademarks of Crown International, Inc. Other trademarks are the property of their respective owners.



THREE YEAR FULL WARRANTY



WORLDWIDE

NORTH AMERICA

SUMMARY OF WARRANTY

The Crown Audio Division of Crown International, Inc., 1718 West Mishawaka Road, Elkhart, Indiana 46517-4095 U.S.A. warrants to you, the ORIGINAL PURCHASER and ANY SUBSEQUENT OWNER of each NEW Crown¹ product, for a period of three (3) years from the date of purchase by the original purchaser (the "warranty period") that the new Crown product is free of defects in materials and workmanship, and we further warrant the new Crown product regardless of the reason for failure, except as excluded in this Crown Warranty.

¹ Note: If your unit bears the name "Amcron," please substitute it for the name "Crown" in this warranty.

ITEMS EXCLUDED FROM THIS CROWN WARRANTY

This Crown Warranty is in effect only for failure of a new Crown product which occurred within the Warranty Period. It does not cover any product which has been damaged because of any intentional misuse, accident, negligence, or loss which is covered under any of your insurance contracts. This Crown Warranty also does not extend to the new Crown product if the serial number has been defaced, altered, or removed.

WHAT THE WARRANTOR WILL DO

We will remedy any defect, regardless of the reason for failure (except as excluded), by repair, replacement, or refund. We may not elect refund unless you agree, or unless we are unable to provide replacement, and repair is not practical or cannot be timely made. If a refund is elected, then you must make the defective or malfunctioning product available to us free and clear of all liens or other encumbrances. The refund will be equal to the actual purchase price, not including interest, insurance, closing costs, and other finance charges less a reasonable depreciation on the product from the date of original purchase. Warranty work can only be performed at our authorized service centers. We will remedy the defect and ship the product from the service center within a reasonable time after receipt of the defective product at our authorized service center. All expenses in remedying the defect, including surface shipping costs to the nearest authorized service center, will be borne by us. (You must bear the expense of all taxes, duties and other customs fees when transporting the product.)

HOW TO OBTAIN WARRANTY SERVICE

You must notify us of your need for warranty service not later than ninety (90) days after expiration of the warranty period. All components must be shipped in a factory pack. Corrective action will be taken within a reasonable time of the date of receipt of the defective product by our authorized service center. If the repairs made by our authorized service center are not satisfactory, notify our authorized service center immediately.

DISCLAIMER OF CONSEQUENTIAL AND INCIDENTAL DAMAGES
YOU ARE NOT ENTITLED TO RECOVER FROM US ANY INCIDENTAL DAMAGES RESULTING FROM ANY DEFECT IN THE NEW CROWN PRODUCT. THIS INCLUDES ANY DAMAGE TO ANOTHER PRODUCT OR PRODUCTS RESULTING FROM SUCH A DEFECT.

WARRANTY ALTERATIONS

No person has the authority to enlarge, amend, or modify this Crown Warranty. This Crown Warranty is not extended by the length of time which you are deprived of the use of the new Crown product. Repairs and replacement parts provided under the terms of this Crown Warranty shall carry only the unexpired portion of this Crown Warranty.

DESIGN CHANGES

We reserve the right to change the design of any product from time to time without notice and with no obligation to make corresponding changes in products previously manufactured.

LEGAL REMEDIES OF PURCHASER

No action to enforce this Crown Warranty shall be commenced later than ninety (90) days after expiration of the warranty period.

THIS STATEMENT OF WARRANTY SUPERSEDES ANY OTHERS CONTAINED IN THIS MANUAL FOR CROWN PRODUCTS.

Telephone: 219-294-8200. Facsimile: 219-294-8301 9/90

SUMMARY OF WARRANTY

The Crown Audio Division of Crown International, Inc., 1718 West Mishawaka Road, Elkhart, Indiana 46517-4095 U.S.A. warrants to you, the ORIGINAL PURCHASER and ANY SUBSEQUENT OWNER of each NEW Crown product, for a period of three (3) years from the date of purchase by the original purchaser (the "warranty period") that the new Crown product is free of defects in materials and workmanship. We further warrant the new Crown product regardless of the reason for failure, except as excluded in this Warranty.

ITEMS EXCLUDED FROM THIS CROWN WARRANTY

This Crown Warranty is in effect only for failure of a new Crown product which occurred within the Warranty Period. It does not cover any product which has been damaged because of any intentional misuse, accident, negligence, or loss which is covered under any of your insurance contracts. This Crown Warranty also does not extend to the new Crown product if the serial number has been defaced, altered, or removed.

WHAT THE WARRANTOR WILL DO

We will remedy any defect, regardless of the reason for failure (except as excluded), by repair, replacement, or refund. We may not elect refund unless you agree, or unless we are unable to provide replacement, and repair is not practical or cannot be timely made. If a refund is elected, then you must make the defective or malfunctioning product available to us free and clear of all liens or other encumbrances. The refund will be equal to the actual purchase price, not including interest, insurance, closing costs, and other finance charges less a reasonable depreciation on the product from the date of original purchase. Warranty work can only be performed at our authorized service centers or at the factory. We will remedy the defect and ship the product from the service center or our factory within a reasonable time after receipt of the defective product at our authorized service center or our factory. All expenses in remedying the defect, including surface shipping costs in the United States, will be borne by us. (You must bear the expense of shipping the product between any foreign country and the port of entry in the United States and all taxes, duties, and other customs fees for such foreign shipments.)

HOW TO OBTAIN WARRANTY SERVICE

You must notify us of your need for warranty service not later than ninety (90) days after expiration of the warranty period. All components must be shipped in a factory pack, which, if needed, may be obtained from us free of charge. Corrective action will be taken within a reasonable time of the date of receipt of the defective product by us or our authorized service center. If the repairs made by us or our authorized service center are not satisfactory, notify us or our authorized service center immediately.

DISCLAIMER OF CONSEQUENTIAL AND INCIDENTAL DAMAGES
YOU ARE NOT ENTITLED TO RECOVER FROM US ANY INCIDENTAL DAMAGES RESULTING FROM ANY DEFECT IN THE NEW CROWN PRODUCT. THIS INCLUDES ANY DAMAGE TO ANOTHER PRODUCT OR PRODUCTS RESULTING FROM SUCH A DEFECT. **SOME STATES DO NOT ALLOW THE EXCLUSION OR LIMITATIONS OF INCIDENTAL OR CONSEQUENTIAL DAMAGES, SO THE ABOVE LIMITATION OR EXCLUSION MAY NOT APPLY TO YOU.**

WARRANTY ALTERATIONS

No person has the authority to enlarge, amend, or modify this Crown Warranty. This Crown Warranty is not extended by the length of time which you are deprived of the use of the new Crown product. Repairs and replacement parts provided under the terms of this Crown Warranty shall carry only the unexpired portion of this Crown Warranty.

DESIGN CHANGES

We reserve the right to change the design of any product from time to time without notice and with no obligation to make corresponding changes in products previously manufactured.

LEGAL REMEDIES OF PURCHASER

THIS CROWN WARRANTY GIVES YOU SPECIFIC LEGAL RIGHTS, YOU MAY ALSO HAVE OTHER RIGHTS WHICH VARY FROM STATE TO STATE. No action to enforce this Crown Warranty shall be commenced later than ninety (90) days after expiration of the warranty period.

THIS STATEMENT OF WARRANTY SUPERSEDES ANY OTHERS CONTAINED IN THIS MANUAL FOR CROWN PRODUCTS.

Telephone: 219-294-8200. Facsimile: 219-294-8301 9/90

The information furnished in this manual does not include all of the details of design, production, or variations of the equipment. Nor does it cover every possible situation which may arise during installation, operation or maintenance. If your unit bears the name "Amcron," please substitute it for the name "Crown" in this manual. If you need special assistance beyond the scope of this manual, please contact our Technical Support Group.

Crown Audio Division Technical Support Group

57620 C.R. 105, Elkhart, Indiana 46517 U.S.A.

Phone: **800-342-6939** (North America, Puerto Rico and Virgin Islands) or 219-294-8200

Fax: 219-294-8301 Fax Back: 800-294-4094 (North America only) or 219-293-9200

Internet: <http://www.crownintl.com>

CAUTION

**RISK OF ELECTRIC SHOCK
DO NOT OPEN**

TO PREVENT ELECTRIC SHOCK DO NOT REMOVE TOP OR BOTTOM COVERS. NO USER SERVICEABLE PARTS INSIDE. REFER SERVICING TO QUALIFIED SERVICE PERSONNEL.

AVIS

**RISQUE DE CHOC ÉLECTRIQUE
N'OUVREZ PAS**

À PRÉVENIR LE CHOC ÉLECTRIQUE N'ENLEVEZ PAS LES COUVERCLES. IL N'Y A PAS DES PARTIES SERVICEABLE À L'INTÉRIEUR. TOUS REPARATIONS DOIT ÊTRE FAIRE PAR PERSONNEL QUALIFIÉ SEULEMENT.



WARNING

TO REDUCE THE RISK OF ELECTRIC SHOCK, DO NOT EXPOSE THIS EQUIPMENT TO RAIN OR MOISTURE!

Magnetic Field

CAUTION! Do not locate sensitive high-gain equipment such as preamplifiers or tape decks directly above or below the unit. Because this amplifier has a high power density, it has a strong magnetic field which can induce hum into unshielded devices that are located nearby. The field is strongest just above and below the unit.

If an equipment rack is used, we recommend locating the amplifier(s) in the bottom of the rack and the preamplifier or other sensitive equipment at the top.



The lightning bolt triangle is used to alert the user to the risk of electric shock.



The exclamation point triangle is used to alert the user to important operating or maintenance instructions.



Printed on recycled paper.

CONTENTS

1	Welcome	7
1.1	Unpacking	7
1.2	Features	7
2	Facilities	8
3	Installation	9
3.1	Mounting	9
3.2	Cooling	9
3.3	Wiring	9
3.3.1	Mode of Operation	9
3.3.2	Input Connection	11
3.3.3	Output Connection	12
3.3.4	Additional Load Protection	13
3.3.5	AC Mains Power Requirement	14
4	Operation	15
4.1	Precautions	15
4.2	Indicators	15
4.3	Controls	15
4.4	Protection	15
4.5	Fuse Replacement	16
5	Technical Information	17
5.1	Principles of Operation	17
6	Specifications	18
7	Internal Settings	23
7.1	26 dB Gain vs. 0.775 V Input Sensitivity	23
7.2	Changing the Input Sensitivity to 0.775 V	23
8	Service	24
8.1	Worldwide Service	24
8.2	North American Service	24
8.2.1	Service at a North American Service Center ...	24
8.2.2	Factory Service	24

ILLUSTRATIONS

1.1	DC-300A II	7
2.1	Facilities	8
3.1	Mounting Dimensions	9
3.2	System Connection	10
3.3	Input Wiring	11
3.4	Subsonic Filter Capacitors	11
3.5	Unbalanced RFI Filters	11
3.6	Balanced RFI Filters	11
3.7	Wire Size Nomograph	12
3.8	Inductive Load (Transformer) Network	13
3.9	Fuse Selector Nomograph	14
3.10	AC Mains Voltage Conversion	14
5.1	Circuit Block Diagram	16
6.1	Power Matrix	19
6.2	Nominal Output Impedance	20
6.3	Nominal Output Phase Angle	20
6.4	Nominal Damping Factor	20
6.5	Nominal Phase Response	21
6.6	Nominal Crosstalk	21
6.7	Nominal Power Efficiency	21
6.8	Nominal Noise Spectrum	22
6.9	Nominal Frequency Response	22
7.1	Main Circuit Board	23

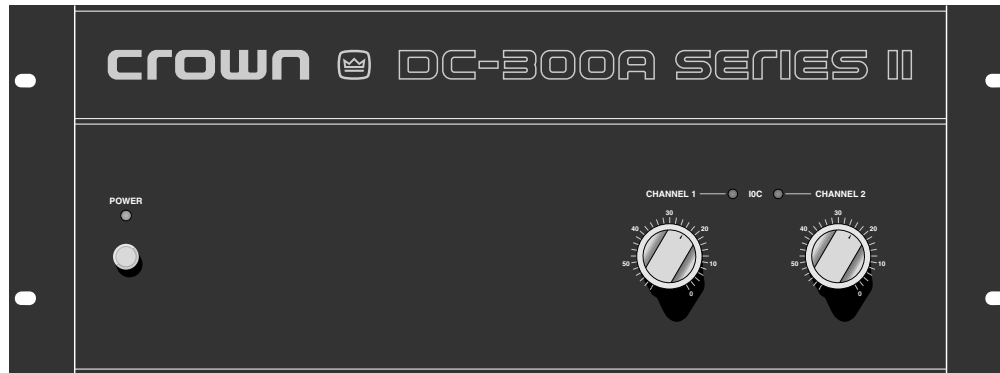

Fig. 1.1 DC-300A II

1 Welcome

Congratulations on purchasing a Crown DC-300A II. Your amplifier is designed to provide reliable operation with a variety of loads. It is a versatile choice for use in studios, laboratories, public facilities and on the road. And the sonic excellence of the DC-300A II makes it a very good choice for your personal listening pleasure.

Using innovative circuitry, the DC-300A II yields ultra-low distortion through a wide range of frequencies from DC (0 Hz) to 20 kHz. The amplifier's output transistors are "direct coupled" to the load so there are no output capacitors or transformers to compromise its superb sonic integrity. The tremendous output power of the DC-300A II enables it to deliver balanced 70 volt output in Bridge-Mono mode without using costly "step-up" transformers. And Crown's innovative JTS (Junction Temperature Simulation) circuitry dynamically adjusts the output protection system for unparalleled sonic headroom. Crown further protects your investment with the industry's only three year "No-Fault" full warranty. After reading this manual and learning about the features, facilities and capabilities of your amplifier, you will understand why Crown amplifiers are recognized as the worldwide standard for audio excellence.

For your protection, please send in your warranty registration card and save your bill of sale, as it is your **official proof of purchase**.

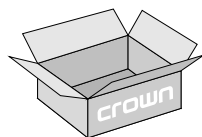

1.1 Unpacking

Please unpack and inspect your new amplifier for any damage that may have occurred during transit. If damage is found, notify the transportation company imme-

diately. Only you may initiate a claim with the carrier for damage resulting during shipment. Even if the unit arrived in perfect condition, as most do, save all packing materials so you will have them if you ever need to transport the unit. **NEVER SHIP THE UNIT WITHOUT THE FACTORY PACK.**

1.2 Features

Your dual channel (stereo) amplifier can be configured for higher-powered single channel operation. It also provides the following features:

- AB+B class circuitry for maximum efficiency with minimum crossover "notch" distortion.
- IOC*[®] (Input/Output Comparator) alerts of distortion exceeding 0.05% to provide *proof of performance*.
- Ultra-low harmonic and intermodulation distortion result in the best dynamic transfer function in industry.
- Very low noise level and wide dynamic range exceed digital audio standards.
- Exclusive JTS (Junction Temperature Simulation) circuitry protects the output devices and provides exceptional dynamic headroom.
- High damping factor gives you greater loudspeaker motion control.
- Bridge-Mono output can drive 70 volt "constant voltage" lines without expensive, distortion-producing "step-up" transformers.
- Convection cooling with integrated heat sink/chassis design for maintenance-free operation.
- Mounts in a standard 19 inch (48.3 cm) rack.
- Three year "No-Fault" full warranty protects your investment and guarantees the specifications of units in North America and other select countries.



Fig. 2.1 Facilities

2 Facilities

A. Power Indicator

This indicator glows when the amplifier is turned on.

B. Power Switch

This push button turns the DC-300A II on and off. The unit has no turn-on delay and minimal thumps. Always turn the amplifier on last so the turn-on transients of other components will not be amplified.

C. Input Jacks

An unbalanced ¼ inch phone jack is used for input to each channel. Do not use the channel 2 input in Bridge-Mono mode.

D. Output Jacks

5-way binding posts provide output from each channel. Use banana plugs, spade lugs or bare wire to connect loudspeaker cables. In Bridge-Mono mode, connect the positive (+) loudspeaker terminal to the positive (+) channel 1 output and the negative (-) loudspeaker terminal to the positive (+) channel 2 output.

E. Dual-Mono Switch

Facing the back of the amplifier, slide this switch to the left for Dual (stereo) mode and to the right for Bridge-

Mono mode. In Bridge-Mono mode, the channel 2 input should not be used, its level control should be turned down and only balanced (ungrounded) loads should be connected to the output (see section 3.3.1).

F. Fuse Holder

The AC line is safely fused. Use a 10 amp, 250 volt, type AB fuse for 100 and 120 VAC operation, or a 5 amp, 250 volt, type MTH fuse for 200, 220 and 240 VAC units (see Sections 3.3.5 and 4.5).

G. Level Controls

The output level of each channel is adjusted with these controls. Turn the channel 2 level control down completely when using Bridge-Mono mode.

H. Power Cord

The unit has a grounded, three wire AC cord and plug.

I. IOC Indicators

The red Input/Output Comparator (IOC) indicators provide *proof of distortion-free performance*. Normally off, they flash in the rare event that the output waveform differs from the input by 0.05% or more.

3 Installation

Your amplifier is designed for standard 19 inch (48.3 cm) rack mounting. Before mounting, determine whether you need to change the amplifier's internal settings for your application.

Your amplifier's internal settings make it possible to change the input sensitivity from the default 26 dB gain to a sensitivity of 0.775 volts. If you need to operate your amplifier with an input sensitivity of 0.775 volts, or if you want more information on input sensitivity, please refer to Section 7 before proceeding.

3.1 Mounting

The DC-300A II can be mounted into a standard 19 inch (48.3 cm) wide equipment rack. It occupies 7 inches (17.8 cm) of vertical rack space. Mounting screws and washers are provided with the unit. Although units can be stacked, this practice is not recommended. Instead, mount multiple units in a rack leaving air space between them. Also, before mounting the amplifier, please read about the amplifier's cooling requirements in the section that follows.

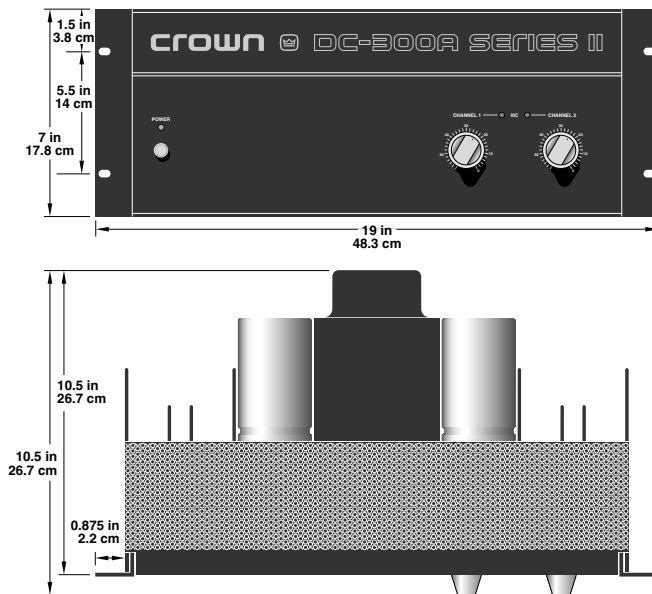

Fig. 3.1 Mounting Dimensions

3.2 Cooling

Your amplifier does not have a cooling fan. To prevent overheating, sufficient ventilation is required. Equipment racks or cabinets should have perforated top and bottom panels. This is especially important if more than one amplifier will be mounted in the same rack. When

mounting, we recommend that you allow a 1.75 inch (4.45 cm) space above and below the unit. If you mount it with the front panel up, be sure to provide air space above and below the unit. Inadequate cooling can cause the built-in thermal protection circuitry to be activated prematurely. Overheating like this can also cause the front panel to become warm. Applications requiring sustained use at high output power levels may require the installation of a cooling fan.

3.3 Wiring

Figure 3.2 depicts three of the most common ways to install a DC-300A II in a sound system. All input and output jacks are located on the back panel. Please use care in making connections, selecting signal sources and controlling the output level. The load you save may be your own! Crown is not liable for any damage done to loads due to careless amplifier usage and deliberate overpowering.

3.3.1 Mode of Operation

The DC-300A II may be operated in either Dual (stereo) or Bridge-Mono mode by setting the Dual-Mono switch on the back panel of the amplifier. There are very important wiring differences between these two modes which are discussed next.

DUAL

Dual mode installation is intuitive. The channel 1 input feeds the channel 1 output, and the channel 2 input feeds the channel 2 output. To put the amplifier in Dual mode, turn off the amplifier and slide the Dual-Mono switch to the left as you face the amplifier's back panel (see Figure 3.2). Be careful not to short the outputs together, and observe correct loudspeaker polarity.

CAUTION: Do not tie the two outputs together. Never tie an output to another amplifier's output. 

MONO

Amplifier installation in Bridge-Mono mode is very different. First, only the channel 1 input should be used. DO NOT USE THE CHANNEL 2 INPUT. For best results, disconnect all channel 2 input sources and turn the channel 2 level control fully counterclockwise (off). *Note: The channel 2 input and level control are not defeated in bridge-mono mode. A signal fed to channel 2 will work against the signal feeding channel 1.*

To activate Bridge-Mono, move the Dual-Mono switch to the right as you face the amplifier's back panel. Both

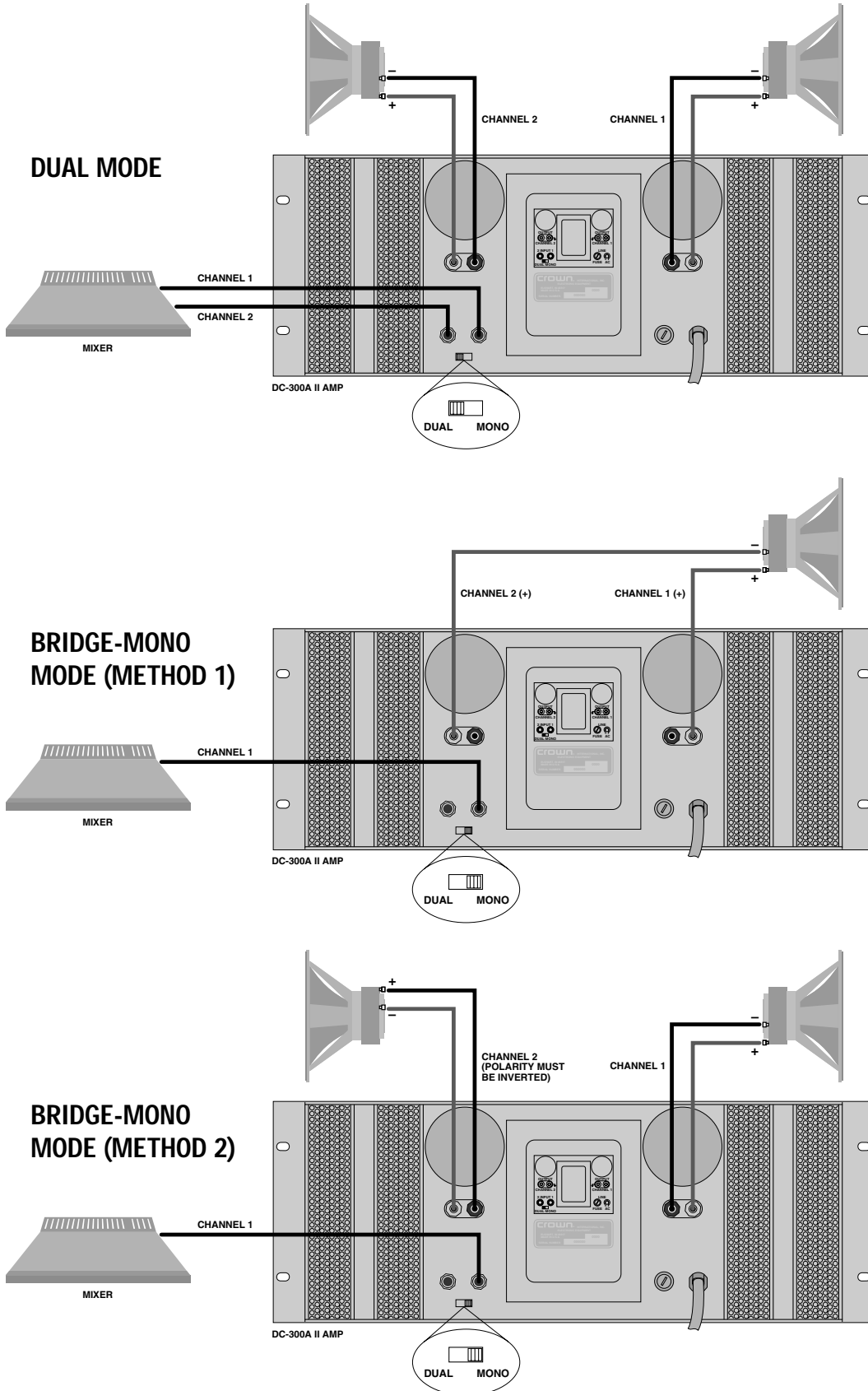

Fig. 3.2 System Connection

outputs will receive the channel 1 input. The channel 2 output is inverted so it can be bridged with channel 1.

There are two different ways to connect Bridge-Mono wiring. The most common method is to connect the positive (+) output of channel 1 to the positive (+) loudspeaker lead, and the positive (+) output of channel 2 to the negative (-) loudspeaker lead (see Figure 3.2). The negative amplifier outputs are not used.

In Bridge-Mono mode, it is also possible to connect a loudspeaker to each output channel, however, the output of channel 2 is inverted. To compensate for this, you can invert the polarity of the channel 2 output wiring. First, connect a loudspeaker to channel 1 as you would normally. Then, connect a loudspeaker to channel 2 so its positive (+) output goes to the negative (-) loudspeaker terminal, and negative (-) output goes to the positive (+) loudspeaker terminal.

CAUTION: Only connect balanced loads to a bridge-mono output. Output lines must be isolated from ground or severe oscillations may occur.

3.3.2 Input Connection

The unbalanced 1/4 inch phone inputs have a typical impedance of 25 K ohms. They accept the line level output from most devices. Figure 3.3 shows how to properly wire both balanced and unbalanced lines.

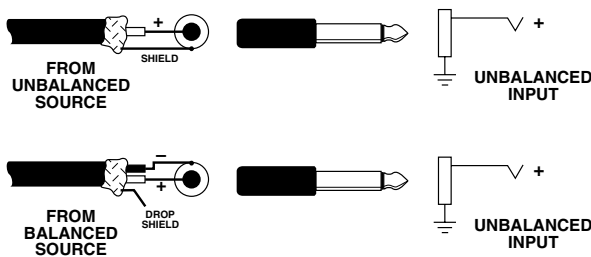

Fig. 3.3 Input Wiring

SOLVING INPUT PROBLEMS

Sometimes large **subsonic** (subaudible) **frequencies** are present in the input signal. These can damage loudspeakers by overloading or overheating them. To attenuate such frequencies, place a capacitor in series with the input signal line. The graph in Figure 3.4 shows some possible capacitor values and how they affect frequency response. Use only a low-leakage paper, mylar or tantalum capacitor.

Another problem to avoid is the presence of large levels of **radio frequencies** or RF in the input signal. Although high RF levels may not pose a threat to the amplifier, they can burn out tweeters or other loads that

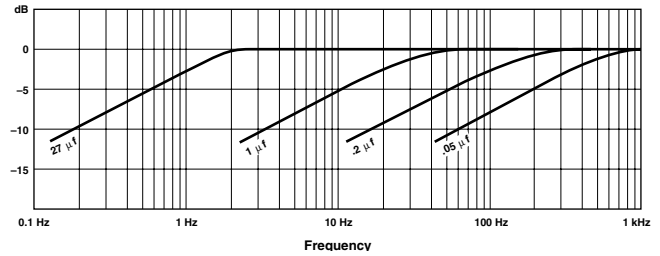
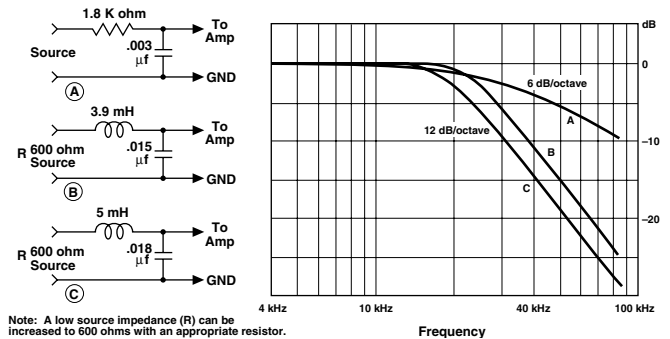

Fig. 3.4 Subsonic Filter Capacitors

are sensitive to high frequencies. Extremely high RF levels can also cause your amplifier to prematurely activate its protection circuitry, resulting in inefficient operation. RF can be introduced into a signal by local radio stations and from the bias signal of many tape recorders. To prevent this from happening, place an appropriate low-pass filter on the input(s). Some examples are shown below for unbalanced wiring.



Note: A low source impedance (R) can be increased to 600 ohms with an appropriate resistor.

Fig. 3.5 Unbalanced RFI Filters

For balanced input wiring, use one of the examples in Figure 3.6. Filters A, B and C correspond to the unbalanced filters above. Filter D also incorporates the subsonic filter described previously.

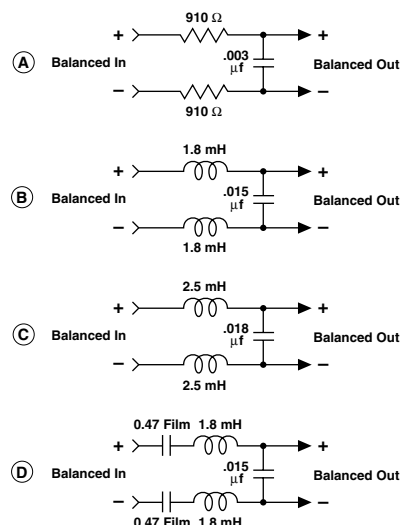

Fig. 3.6 Balanced RFI Filters

A third problem to avoid is **hum**. The two most common sources of hum in an audio system are **inductive coupling** and **ground loops**.

Inductive coupling can occur when input cables are subjected to a magnetic field from a power cord or power transformer. One way to prevent inductive coupling is to lace the input cables together along their length and route them as far away as possible from power transformers and power cords. The use of shielded pair cable is another effective way to reduce or eliminate hum resulting from inductive coupling.

Ground loops often result when two or more devices are improperly grounded. This causes undesirable stray currents that may produce hum in the output. The best way to avoid ground loops is to ensure that all system devices are plugged into the same power strip. In addition, make sure that all cable shields are grounded at one end only.

Input and output grounds are sometimes tied together for testing or metering. This can cause **feedback oscillation** from load current in the test loop. In some systems, even the AC power line may provide this feedback path. Proper grounding, input isolation and isolation of common AC devices in the system is good practice.

Input Wiring Tips

1. Use only shielded cable. Cables with higher density shields are better. Spiral wrapped shield is not recommended.
2. Avoid unbalanced lines longer than 10 feet (3 meters).
3. Keep signal and high level wiring apart.
4. Turn off the unit before making connections. Crown is not liable for injury or damage due to overdriven components.

3.3.3 Output Connection

Consider the power-handling capacity of your load before connecting it. Crown is not liable for damage incurred at any time due to a load being overpowered. The use of loudspeaker protection fuses is highly recommended (see Section 3.3.4). Also, please pay close attention to the precautions in Section 4.1.

HOW TO DETERMINE APPROPRIATE WIRE GAUGE

It is important to use loudspeaker cables of sufficient gauge (thickness) for the length used. The resistance introduced by inadequate loudspeaker cables will reduce both the output power and the motion control of the loudspeakers. The latter problem occurs because the damping factor decreases as loudspeaker cable resistance increases. This is very important because the amplifier's excellent damping factor can easily be negated by using insufficient loudspeaker cables.

Use the nomograph and the procedure that follow to find the recommended wire gauge (AWG or American Wire Gauge) for your system.

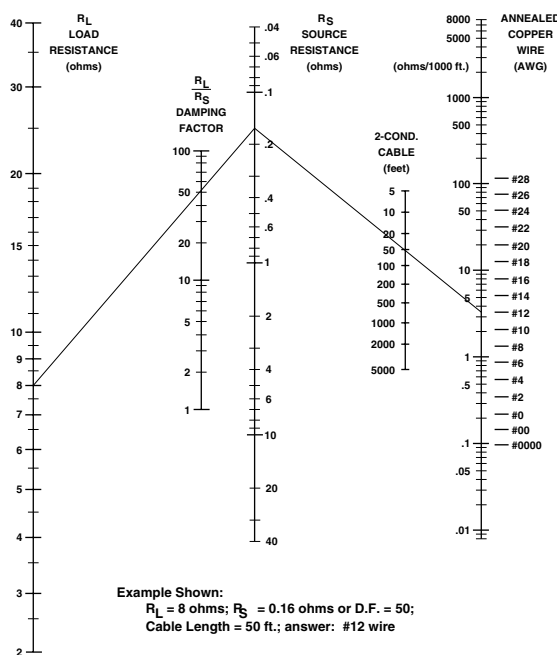

Fig. 3.7 Wire Size Nomograph

1. Note the load resistance of the loudspeakers connected to each channel of the amplifier. Mark this value on the "Load Resistance" line of the nomograph.
2. Choose an acceptable system damping factor and mark it on the "Damping Factor" line. Your amplifier can provide an excellent damping factor of 750 or more from DC to 400 Hz in Dual mode with an 8 ohm load. In contrast, typical damping factors are 50 or lower. Higher damping factors yield lower distortion and greater motion control over the loudspeakers. A common damping factor for commercial applications is between 50 and 100. Higher damping factors may be desirable for live sound, but long cable lengths often limit the highest damping factor that can be achieved practically. (Under these circumstances, Crown's *IQ System*® is often used with Crown's premium *Macro-Tech*®, *Com-Tech*® and *Reference* series amplifiers for easy monitoring and control of units located very near the loudspeakers.) In recording studios and home hi-fi, a damping factor of 500 or more is desirable.

3. Draw a line through the two points with a pencil, and continue until it intersects the "Source Resistance" line.
4. On the "2-Cond. Cable" line, mark the length of cable run.
5. Draw a pencil line from the mark on the "Source Resistance" line through the mark on the "2-Cond. Cable" line, and on to intersect the "Annealed Copper Wire" line.
6. The required wire gauge for the selected wire length and damping factor is the value on the "Annealed Copper Wire" line. *Note: Wire size increases as the AWG gets smaller.*
7. If the size of the cable exceeds what you want to use, (1) find a way to use shorter cables, (2) settle for a lower damping factor, or (3) use more than one cable for each line. Options 1 and 2 will require the substitution of new values for cable length or damping factor in the nomograph. For option 3, estimate the effective wire gauge by subtracting 3 from the apparent wire gauge every time the number of conductors of equal gauge is doubled. So, if #10 wire is too large, two #13 wires can be substituted, or four #16 wires can be used for the same effect.

Use Good Connectors

1. To prevent possible short circuits, do not use loudspeaker cables with exposed male connectors.
2. Do not use connectors that might accidentally tie two channels together when making or breaking connections, such as a standard three wire stereo phone plug.
3. Never use connectors that can be plugged into an AC power receptacle.
4. Avoid connectors with low current-carrying capacity.
5. Do not use connectors with any tendency to short.

SOLVING OUTPUT PROBLEMS

Sometimes **high frequency oscillations** occur which can cause your amplifier to prematurely activate its protection circuitry, resulting in inefficient operation. The effects of this problem are similar to the effects of the RF problem described in Section 3.3.2. To prevent high frequency oscillations:

1. Lace loudspeaker cables together to minimize the chance of them acting like an antenna to transmit or receive high frequencies that can cause oscillation.
2. Keep the speaker cables well separated from input cables.
3. Never connect the amplifier's input and output grounds together.
4. Install a low-pass filter on each input like the RF

filters described in Section 3.3.2.

5. Install the input wiring according to the instructions in Section 3.3.2.

Another problem to avoid is the presence of **large subsonic currents** when primarily inductive loads are used. Examples of inductive loads are 70 volt step-up transformers and electrostatic loudspeakers.

Inductive loads can appear as a "short" at low frequencies, causing the amplifier to produce large low-frequency currents and unnecessarily activate its protection circuitry. Always take the precaution of installing a high-pass filter on the amplifier inputs when a predominantly inductive load is used. A three pole (18 dB per octave) filter with a -3 dB frequency of 50 Hz is recommended. (Depending on the system, it may be preferable to use a filter with a higher -3 dB frequency.) Such a filter can eliminate the subsonic frequency problems mentioned in Section 3.3.2.

Another way to prevent the amplifier from activating its protection systems early and protect inductive loads from large low-frequency currents is to connect a 590 to 708 μF nonpolarized capacitor and a 4 ohm, 20 watt resistor at the output of the amplifier in series with the positive (+) lead of the transformer. This is depicted in Figure 3.8.

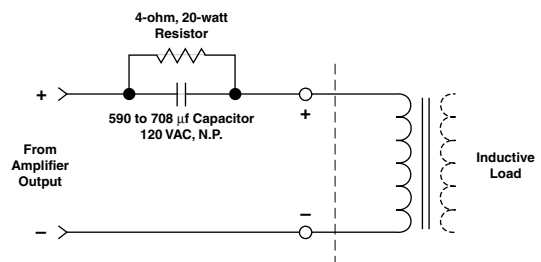

Fig. 3.8 Inductive Load (Transformer) Network

Note: The components shown in Figure 3.8 are commonly available from most electronic supply stores.

3.3.4 Additional Load Protection

Because your amplifier can generate enormous power, you may want to protect loudspeakers or other sensitive loads from excessive power that could result in damage. A common way to do this is to put a fuse in series with the load. This may be accomplished by using a single fuse to protect the entire system, or by fusing each driver.

Fuses help prevent damage due to prolonged overload, but provide essentially no protection against damage from large transients. To minimize this problem, use high-speed instrument fuses such as the

Littlefuse 361000 series. If the loudspeaker is only susceptible to damage caused by prolonged overload (such as overheating), use a fuse or circuit breaker having the same slow thermal response as the loudspeaker itself (such as a slow-blow fuse).

The nomograph in Figure 3.9 shows fuse size versus loudspeaker peak power rating. It can be used to determine the size of the required fuse.

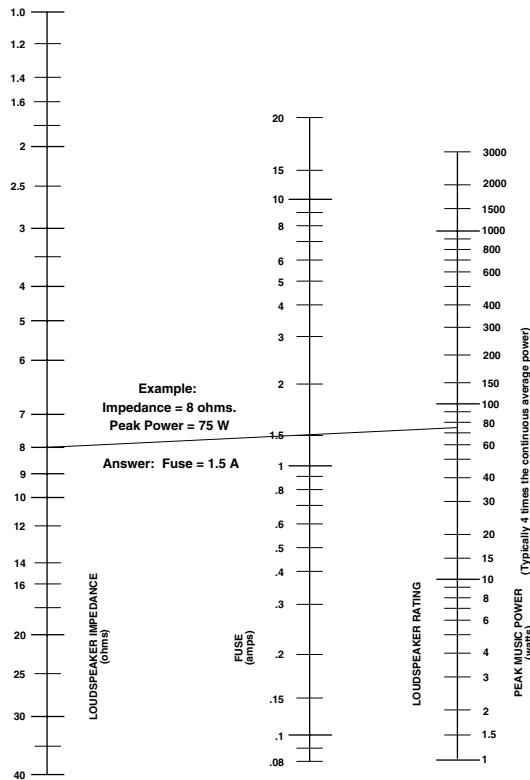

Fig. 3.9 Fuse Selector Nomograph

3.3.5 AC Mains Power Requirement

All units have a standard three wire, grounded AC cord and plug as specified by UL requirements for North American 120 VAC, 60 Hz units. *Note: Crown assumes no liability whatsoever for ungrounded operation, nor for violation of UL or local electrical codes.*

Five standard line voltages are supported, including 100, 120, 200, 220 and 240 VAC. The unit may be operated at AC mains frequencies from 50 to 400 Hz. The model-voltage sticker on the back panel indicates the unit's factory configuration.

⚡ WARNING: Risk of electric shock! Only a qualified technician should attempt to alter your amplifier's AC mains voltage configuration.

To operate your amplifier at a different line voltage, you will need a phillips screwdriver. Then follow these steps:

1. Turn the amplifier off and disconnect it from the AC mains.
2. Remove the perforated top cover by removing the 12 phillips screws that hold it in place.
3. Find the power transformer. The terminal strip with six connector tabs is wired to the transformer.
4. Change the appropriate jumpers for the desired operating voltage (see Figure 3.10).
5. Make sure the proper fuse is installed. Use only a 5 amp, 250 volt, type MTH fuse for AC mains of 200 volts or more; use only a 10 amp, 250 volt, type AB fuse for AC mains below 200 volts.
6. Carefully check all connections.
7. Repeat steps 1 and 2 in reverse order to reassemble the unit.

IMPORTANT: Use only a 5 amp, 250 volt, type MTH fuse for 200, 220 or 240 VAC operation; use only a 10 amp, 250 volt, type AB fuse for 100 or 120 VAC operation.

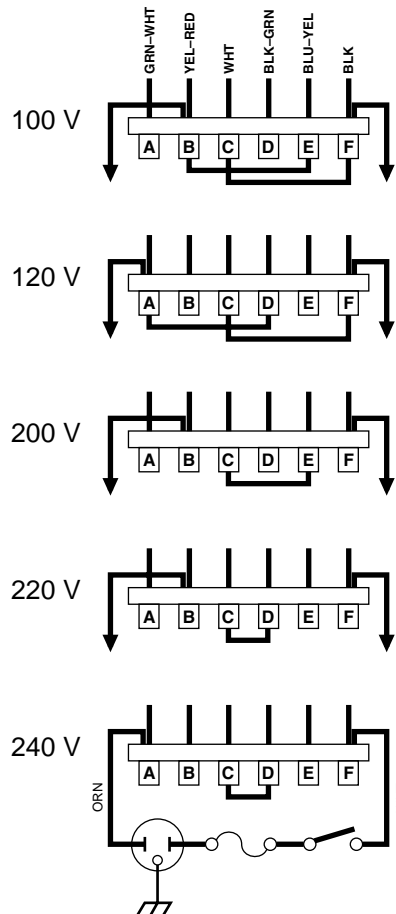

Fig. 3.10 AC Mains Voltage Conversion

4 Operation

4.1 Precautions

Your amplifier is protected from all external faults. Even so, you should take the following precautions:

1. When the level of an input source is uncertain, or an audio component has not been previously used with your amplifier, always begin with the level controls at a minimum and gradually increase them while monitoring the output level. This approach helps avoid loudspeaker blasts.
2. Don't forget, your amplifier does not have a turn on delay. Beware of turn-on transients from other equipment ahead of the amplifier—always turn the amplifier on after other equipment has stabilized.
3. Turn off the amplifier and unplug it from the AC mains before replacing the fuse, installing an input sensitivity jumper or changing the position of the Dual-Mono switch.
4. There are important differences between Dual and Bridge-Mono mode wiring (refer to Section 3.3.1).
5. Operate the amplifier with the correct fuse: a 5 amp, 250 volt, type MTH fuse for units configured for 200 volt or higher AC mains, and a 10 amp, 250 volt, type AB fuse for units configured for AC mains of less than 200 volts.
6. Be careful when driving a transformer-coupled device (such as an electrostatic loudspeaker) or other loads that appear as a low-frequency short circuit (less than 3 ohms) without a series isolating capacitor. Such operation may damage the load and needlessly activate the amplifier's V-I limiting.
7. Operate the amplifier with AC mains of no more than 10% above the selected line voltage and at the specified line frequency (50 to 400 Hz).
8. Never connect the output to a power supply output, battery or power main. This can cause electric shock and damage to the amplifier.
9. Do not expose the amplifier to corrosive chemicals such as soft drinks, lye, salt water, etc.
10. Do not tamper with the circuitry. Unauthorized circuit changes invalidate the warranty.
11. Do not short the ground lead of an output to the input signal ground or oscillations may result.
12. We recommend that you avoid using the amplifier with frequencies above 30 kHz.

4.2 Indicators

Your amplifier has three front panel indicators. The yellow power indicator glows when the amplifier is turned on and the unit is receiving power.

The *IOC* (Input/Output Comparator) indicators work like sensitive distortion meters. Each channel has a red LED (light emitting diode) that flashes when distortion of any kind exceeds 0.05%. They typically glow for about one minute after the AC power is turned off.

4.3 Controls

A power switch and level controls are located on the front panel. When you power up the amplifier, remember that the unit does not have a turn-on delay. Each channel has its own level control which is used to adjust the desired output level. Both level controls are used in Dual mode, but only the channel 1 control should be used in Bridge-Mono mode.

The amplifier is switched between Dual and Bridge-Mono operation with the Dual-Mono switch located on the back panel of the amplifier (see Section 2).

The unit's input gain is 26 dB as determined by 1% precision resistors in the feedback loop. This can be changed to a sensitivity of 0.775 volts by following the instructions in Section 7.

4.4 Protection

Your amplifier is protected against all the common hazards that plague high-power amplifiers, including shorted, open and mismatched loads; overloaded power supplies, chain destruction phenomena, input overload and high-frequency blowups.

Protection against shorted and low impedance loads is provided by the JTS (Junction Temperature Simulation) circuitry. This circuitry instantaneously limits the amplifier's output voltage to the maximum safe level for the output transistors. With a loudspeaker, you can tell the amplifier has activated load protection because it causes audible distortion. The noise might be compared to crossover "notch" distortion or a snapping sound, depending on the load characteristics. Loudspeaker systems with impedances of 4 ohms or higher will not activate this system.

All voltage amplification circuitry is designed to limit current. So in the extremely unlikely event of a device failure, the amplifier will prevent further damage.

The input stages are protected from overload by series resistors. The unit also features a controlled slew rate and the JTS limiter that protect the amplifier from high-frequency blowups.

A thermal switch is mounted on each heat sink to protect your amplifier against overheating. If either heat sink becomes too hot, the AC mains power will be interrupted until the temperature falls to a safe level and the unit resets itself. If the unit overheats, it will not produce any output and it will be very warm to touch.

4.5 Fuse Replacement

An AC line fuse is located beside the power cord on the back panel of the amplifier. To replace the fuse,

turn off the power switch and disconnect the power plug from the AC mains. Unscrew the cap of the fuse holder and remove the fuse.

CAUTION: The fuse holder has power even when the power switch is turned off. Always disconnect AC power before replacing fuses. ⚡

Replace the fuse with a 10 amp, 250 volt, type AB fuse for units operating with an AC mains voltage less than 200 volts, or a 5 amp, 250 volt, type MTH fuse for units operating with an AC mains voltage of 200 volts or more. Reassemble in reverse order.

WARNING: Never replace the original fuse with one rated for higher current (amperage). ⚠

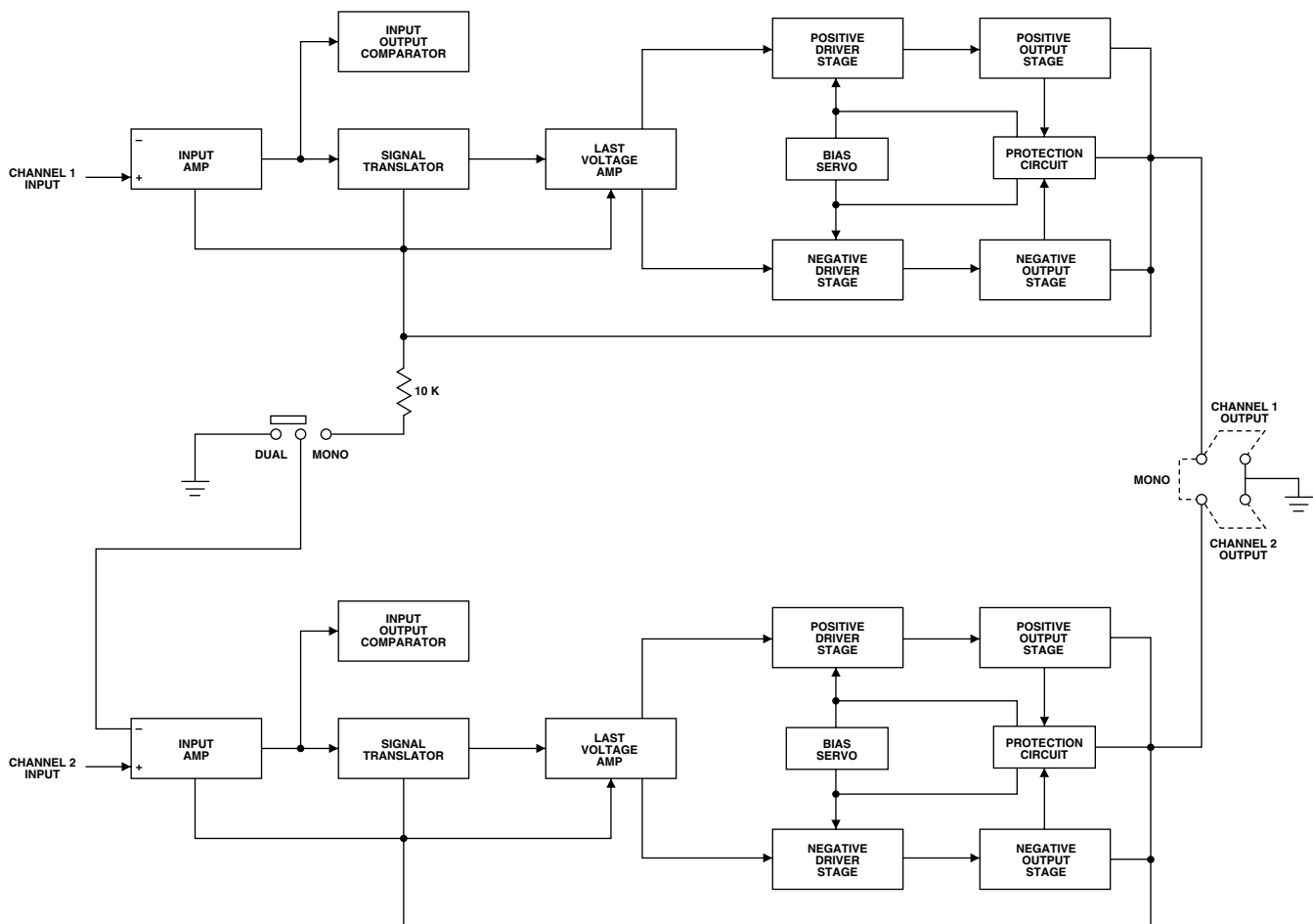

Fig. 5.1 Circuit Block Diagram

5 Technical Information

5.1 Principles of Operation

The DC-300A II has input amplifiers that are powered by zener-regulated power supplies. The bias regulators are also powered by zener-regulated current sources with the result that line voltage variations do not cause noise or distortion due to misbiasing.

The power supply is designed for continuous duty and supports 1 kilowatt loading. The power transformer weighs 25 pounds (11.3 kg) and is made of a very special steel. The main DC supplies are full-wave supplies with heavy duty, heat-sinked diodes. Computer grade electrolytic capacitors furnish over 48 joules of energy storage. A higher voltage at low current is derived from a half-wave voltage-doubling circuit. This is used in the amplifier's driver circuit.

The amplifier has two direct-coupled amplifier circuits employing dual IC opamps and silicon transistors in all stages. Because of its direct coupling, the amplifier has a perfectly flat frequency and phase response extending from DC (0 Hz) to 20 kHz. Flat-to-DC response not only results in low-frequency amplification with absolutely no phase distortion, but it also offers excellent overload characteristics. DC frequency response is combined with ultra-low noise and intermodulation distortion to deliver the classic rendering of a "straight wire with gain." In fact, before the advent of Crown's *Reference* series amplifiers, the DC-300A II enjoyed a reputation of being the most accurate amplifier available.

The two low-noise IC opamps have a large gain bandwidth. Using them as the input voltage amplifiers results in a maximum amount of feedback which reduces distortion to exceptionally low levels.

The output stage is a quasi-complementary format employing Crown's AB+B class circuitry which uses no

bias current in the output transistors. The benefit is maximum efficiency, minimum crossover notch distortion and minimum thermal dissipation at idle. The output circuit does not have a critical temperature tolerance, so there is no bias current adjustment.

In the AB+B output circuit, the driver transistors carry the bias current while the output transistors serve only as boosters. The output transistors sense when the driver transistors are delivering significant current to the load, then they take over and deliver the large current levels.

The *IOC* (Input/Output Comparator) circuitry works with the error correcting signal of the main opamp. If a small non-linearity exists in the amplifier, an error signal appears at the output of the main opamp via the unit's feedback loop. This produces an abnormally high value, exceeding the threshold of the *IOC* and illuminating the LED. Because transient overload can happen very quickly, a pulse stretching circuit is added so you can see the LED flash.

Protection against shorted and low impedance loads is provided by Crown's JTS (Junction Temperature Simulation) control circuit. It functions as an automatic current limiter at audible frequencies and as a V-I limiter at subaudible frequencies. The threshold of current limiting is dependent on the history of the signal, yet the threshold of the limiting with no signal is high enough to allow full power tone bursting. The result is maximum protection with trouble-free output power without an inventory of special fuses or cumbersome load-matching techniques.

The DC-300A II gives you the highest quality in both circuitry and components. It should provide you with a lifetime of trouble-free service.

6 Specifications

Note: The following specifications apply to units configured for 120 VAC, 60 Hz operation in Dual mode with 8 ohm loads and an input sensitivity of 26 dB gain unless otherwise specified.

Performance

Frequency Response: ± 0.1 dB from DC to 20 kHz at 1 watt (see Figure 6.9).

Phase Response: $+0/-15$ degrees from DC to 20 kHz at 1 watt (see Figure 6.5).

Signal-to-Noise Ratio: (20 Hz to 20 kHz) At least 110 dB below rated maximum average power (see Figure 6.8).

Harmonic Distortion (THD): Less than 0.001% from 20 to 400 Hz and increasing linearly to 0.05% at 20 kHz at rated maximum average power.

Intermodulation Distortion (IMD): (SMPTE-IM 60 Hz and 7 kHz) Less than 0.05% from 0.01 to 0.25 watts, and less than 0.01% from 0.25 to rated maximum average power.

Damping Factor: Greater than 750 from DC to 400 Hz (see Figure 6.4).

Crosstalk: See Figure 6.6.

Slew Rate: Greater than 8 volts per microsecond.

Voltage Gain: (At maximum output) 20.6:1 $\pm 2\%$ or 26.3 dB ± 0.2 dB. (Refer to Section 7 for information on the 0.775 volt sensitivity setting.)

Power

Also see the power matrix. *Note: Maximum average power per channel at 1 kHz with 0.1% or less THD.*

Dual mode (both channels driven):

305 watts into 4 ohms.

175 watts into 8 ohms.

100 watts into 16 ohms.

Bridge-Mono mode:

610 watts into 8 ohms.

355 watts into 16 ohms.

Load Impedance: Rated for 16, 8 and 4 ohm use. Safe with all types of loads.

Power Supply: 1 kilowatt transformer with computer-grade filter capacitors storing over 48 joules of energy.

Power Efficiency: See Figure 6.7.

Power Requirements: Requires 50 to 400 Hz AC with

selectable transformer taps for 100, 120, 200, 220 and 240 VAC ($\pm 10\%$) operation. Draws 40 watts or less at idle and 500 watts at rated power.

Controls

Independent level controls and power switch are located on the front panel. Non-interacting DC balance controls are mounted on main PC board under electronics cover. A Dual-Mono switch is located below the input jacks on the back panel.

Indicators

Power: This yellow indicator remains lit while the amplifier is turned on.

IOC: These red indicators are normally off. They flash in the unlikely event of the output waveform differing from the input by 0.05% or more. They act as sensitive distortion indicators providing *proof of performance*.

Input/Output

Input Impedance: Nominally 25 K ohm.

Input Sensitivity: 1.75 volts $\pm 2\%$ for 310 watts into 16 ohms.

Input: $\frac{1}{4}$ inch unbalanced phone jacks.

Output: Color coded binding posts (banana jacks).

Output Impedance: Less than 7 milliohms in series with less than 3 microhenries. See Figure 6.2.

Output Signal

Dual: Unbalanced, dual channel.

Bridge-Mono: Balanced, single channel.

Protection

Overall Protection: AC line fused. Thermal switch in AC line protects against overheating caused by insufficient ventilation. Controlled slew rate voltage amplifiers protect overall amplifier against RF burnouts. Input overload protection is furnished by internal resistance at inputs of amp.

Amplifier Output Protection: Short, mismatch, and open circuit proof. Limiting is instantaneous with no flyback pulses, thumps, cutout, etc. No premature limiting on transients.

Turn-On: Instantaneous, with minimum thumps and no program delay.

Construction

Dimensions: 19 inch (48.3 cm) standard rack mount width (EIA std. RS-310-B); 7 inch (17.8 cm) height; 10.5 inch (26.7 cm) depth behind front mounting surface; 0.625 inch depth in front of mounting surface.

Weight: Net weight is 40 pounds, 11 ounces (18.5 kg); Shipping weight is 45 pounds, 0 ounces (20.3 kg).

Finish: Carbide black front panel, splatter-coat black

chassis and top cover.

Chassis: All aluminum construction for maximum heat conduction and minimum weight. Heavy aluminum front panel is a single extrusion.

Heat Sinking: Massive black-anodized heat sinks are thermally joined with the chassis, thereby utilizing the entire amplifier as a heat sink.

Crown specifications are guaranteed for three years.

In an effort to provide you with as much information as possible about the high power-producing capabilities of your amplifier, we have created the following Power Matrix. All specifications found in these tables are valid for 120 VAC, 60 Hz models and are guaranteed for three years. Some spaces in the tables are left blank because we do not provide this same guarantee for those conditions—however, your amplifier will perform well under all conditions listed in the table.

Power Specifications

When measuring power, 0.1% THD appears to be the industry standard for distortion. One of the maximum average power columns shown in the power matrix is measured when THD rises to 0.1% so you can easily compare Crown specifications to those of other manufacturers. But this high level of distortion actually allows for some clipping which is undesirable. Full-bandwidth maximum average power measured at 0.05% THD provides more reasonable, non-clipped conditions. Crown provides this specification with the hope that other manufacturers will also start providing specifications that correspond to the way amplifiers are used in the real world—without a clipped input signal.

Many manufacturers publish power specifications with a tolerance of ± 1 dB or worse. That means their amplifier can deviate more than 20% in output! A 100 watt amplifier would meet their specification if it only produced 79.4 watts. Other manufacturers qualify their specs by saying they are “typical,” “subject to manufacturing tolerances,” “single channel driven” or that they are specified with “fuses bypassed.” Each of these statements effectively removes any performance guarantee. We take a different approach at Crown—our published specifications are guaranteed for three years. Further, because our “in-house” specs are more stringent than our published specs, every Crown amplifier will exceed its published specs. We believe you should get what you pay for.

DC-300A II												
Dual-Mono Mode	Load (Ohms)	FTC Continuous Average Power at 0.1% THD (See note 1)		Max Average Power at 0.1% THD (See note 2)	Max Average Power at 0.05% THD (See note 3)	Single Cycle Tone Burst Watts at <0.05% THD (See note 4)			40 mS Tone Burst Watts at <0.05% THD (See note 5)			EIA Watts at 1% THD (See note 6)
		20Hz-20kHz	1 kHz	1 kHz	1 Hz-20 kHz	20 Hz	50 Hz	1 kHz	20 Hz	50 Hz	1 kHz	
Dual (both channels driven)	4	250	295	305		260	350	405	260	310	300	310
	8	165	175	175	155	185	195	215	180	185	180	185
	16	95	100	100								100
Bridge-Mono (balanced output)	8	545	595	610		590	660	785	595	615	585	625
	16	340	355	355	310	355	370	415	350	355	345	370

Fig. 6.1 Power Matrix

Notes:

1. Continuous power in the context of Federal Trade Commission testing is understood to be a minimum of five minutes of operation. Harmonic distortion is measured at the RMS sum total as a percentage of the fundamental output voltage. This applies for all wattages greater than 0.25 watts.
2. A 1 kHz sine wave is presented to the amplifier and the output monitored for nonlinear distortion. The level is increased until the THD reaches 0.1%. At this level the average power per channel is reported.
3. A sine wave is presented to the amplifier over the range from 1 Hz to 20 kHz and the output is monitored for nonlinear distortion. The level at each frequency is increased until the THD reaches 0.05%. At this level the average power per channel is reported.
4. A single cycle of sine wave is presented to the amplifier and monitored for nonlinear distortion. The average power during the burst is reported. Speakers must be able to withstand this level if they are to be safely used with this amplifier.
5. A 40 millisecond burst or two cycles of sine wave (whichever is of greater duration) is used and the power computed as the average power during the burst. The duty cycle of this test is 10 percent. This power level is a measure of how loud an amplifier is as perceived by the hearing process.
6. EIA standard RS-490 (both channels driven).

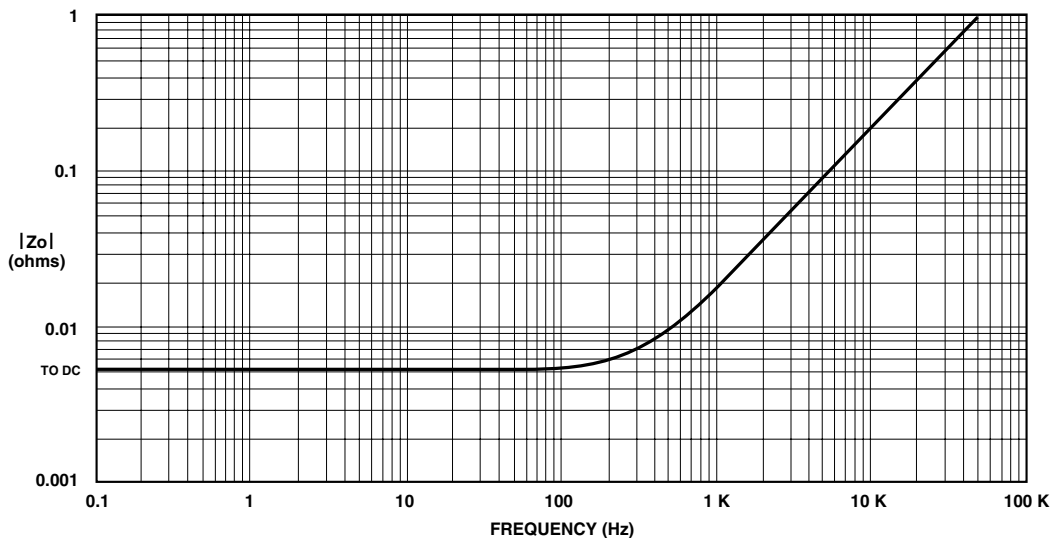

Fig. 6.2 Nominal Output Impedance

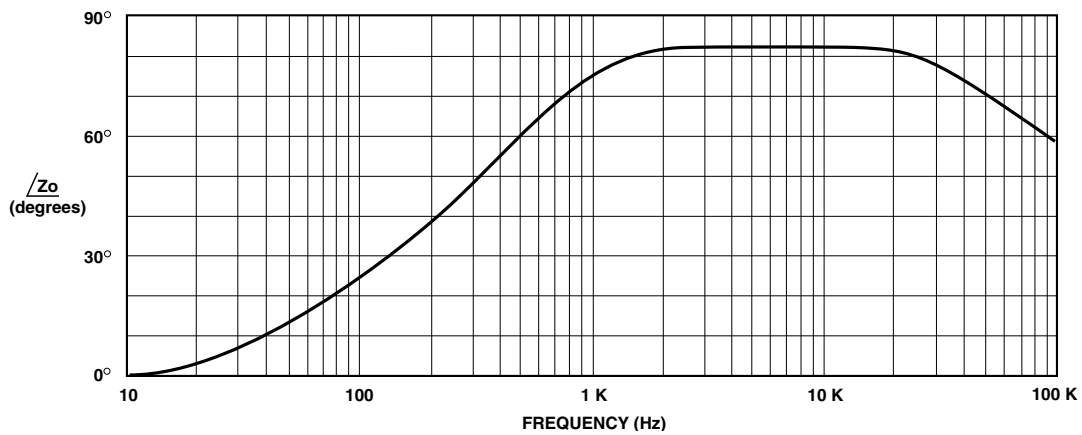

Fig. 6.3 Nominal Output Phase Angle (1 amp)

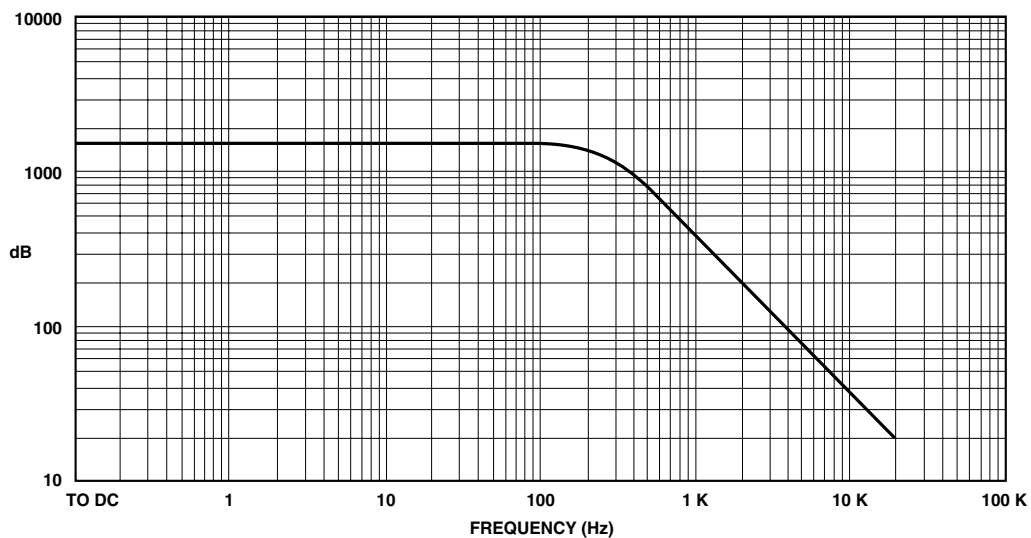

Fig. 6.4 Nominal Damping Factor (8 ohms)

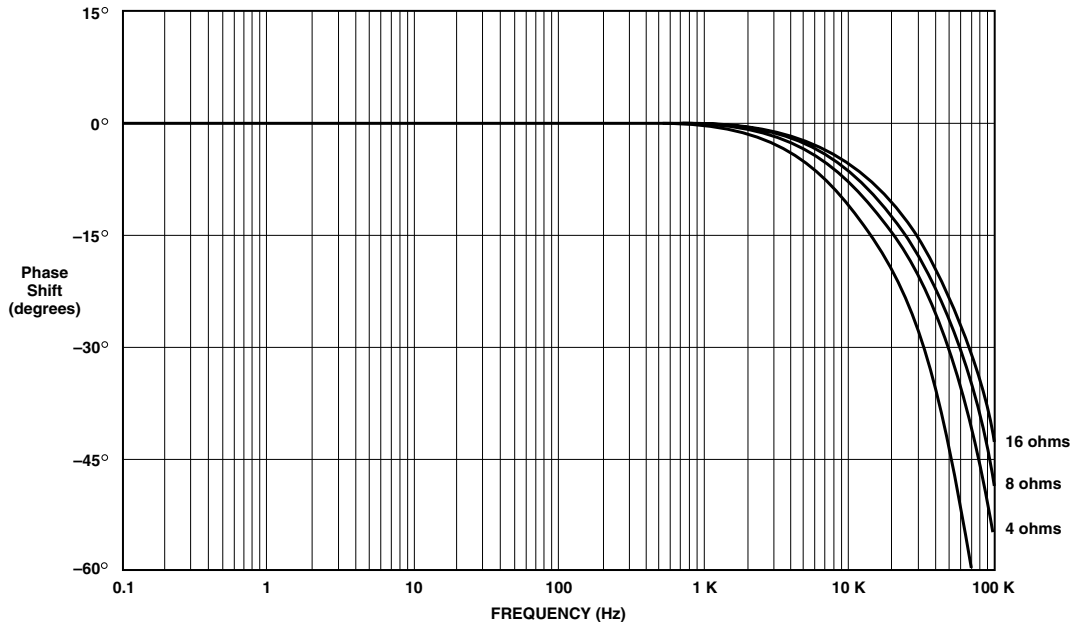

Fig. 6.5 Nominal Phase Response (1 Watt)

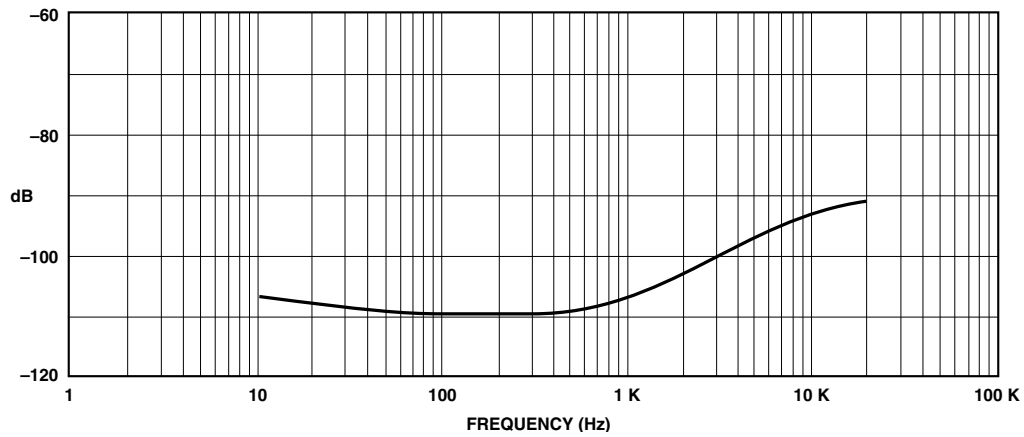

Fig. 6.6 Nominal Crosstalk (Channel 1 at 150 watts and Channel 2 at Maximum Output)

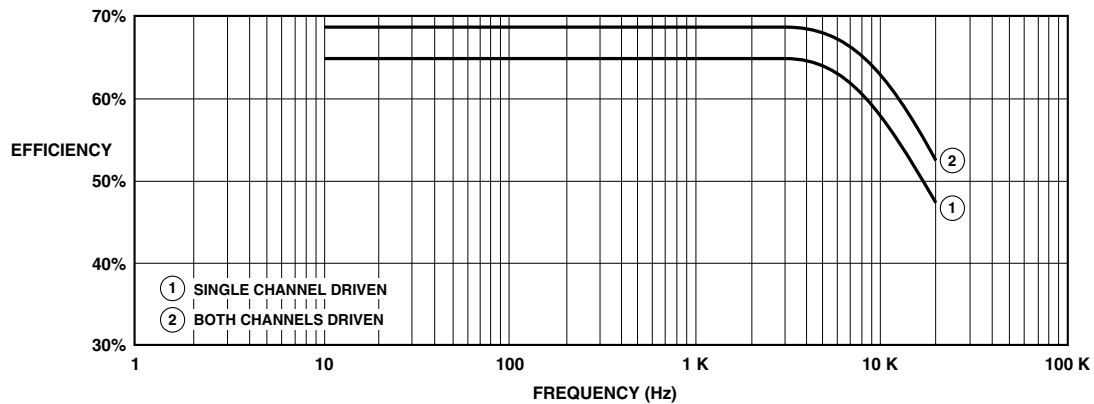
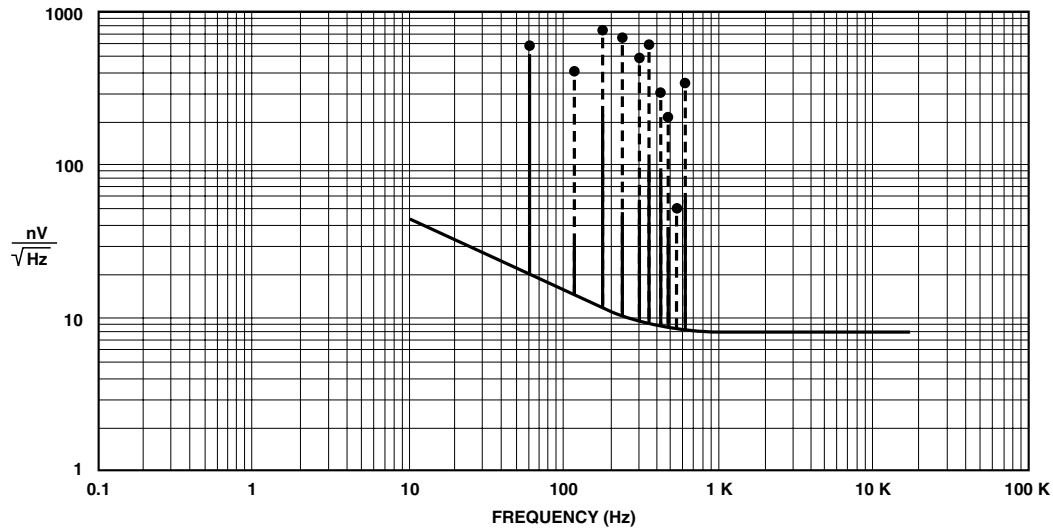

Fig. 6.7 Nominal Power Efficiency (120 VAC Mains and Both Channels Driven)



Line frequency harmonics plotted to the tenth order. The 150 watt output is indicated by the dot at the top of the extended dashed line. Spectrum total is equivalent to 1.3 microvolts input noise over a 20 Hz to 20 kHz bandwidth.

Fig. 6.8 Nominal Noise Spectrum

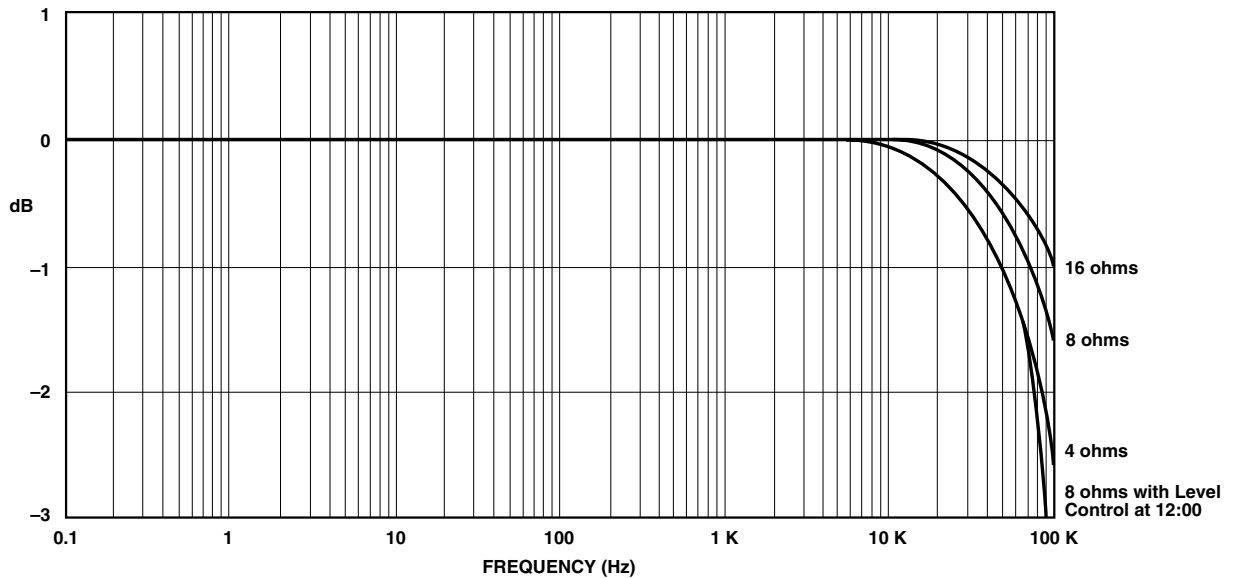

Fig. 6.9 Nominal Frequency Response (16 ohms at 0.5 watts, 8 ohms at 1 watt and 4 ohms at 2 watts)

7 Internal Settings

From the factory, your amplifier is configured for an input sensitivity of 26 dB gain. For the DC-300A II, this setting requires an input signal of 1.75 volts ($\pm 2\%$) to drive the amplifier to full output. You may optionally configure the unit for an input sensitivity of 0.775 volts (0 dBm) for full rated output power. To change your amplifier's input sensitivity to 0.775 volts, the chassis of the unit must be opened.

⚡ WARNING: Risk of electric shock! Turn off the amplifier and disconnect its power cord from the AC mains before opening the amplifier chassis.

⚠ CAUTION: Only a qualified technician should attempt to change the amplifier's internal settings.

7.1 26 dB Gain vs. 0.775 V Input Sensitivity

For most applications, the amplifier's default setting of 26 dB gain will be ideal. At 26 dB gain, full output is achieved with an input signal of 1.75 volts. But some systems require their gain structures to be calculated based on a 0.775 volt sensitivity, while others cannot deliver the voltage required to achieve full output. In these situations, your amplifier's 0.775 volt input sensitivity setting offers a solution. A Crown Service Center

or a technician in the field can activate the setting without voiding the warranty.

7.2 Changing the Input Sensitivity to 0.775 V

Before undertaking this procedure, please read all of Section 7.1 to help determine whether you need to alter the amplifier's input sensitivity.

1. Turn the amplifier off and disconnect it from the AC mains.
2. Place the amplifier upside down on a flat surface. Remove the front panel by unscrewing the eight phillips screws along the top and bottom of the front panel and the four phillips screws behind the rack ears. Pull the front panel straight out from the unit.
3. Remove the four phillips screws that hold the main circuit board to its shield plate. It will hinge forward from the bottom to expose both sides.
4. Solder #22 jumper wires at the locations labeled R158 and R258 on the main circuit board (see Figure 7.1).
5. Reassemble in reverse order of disassembly.

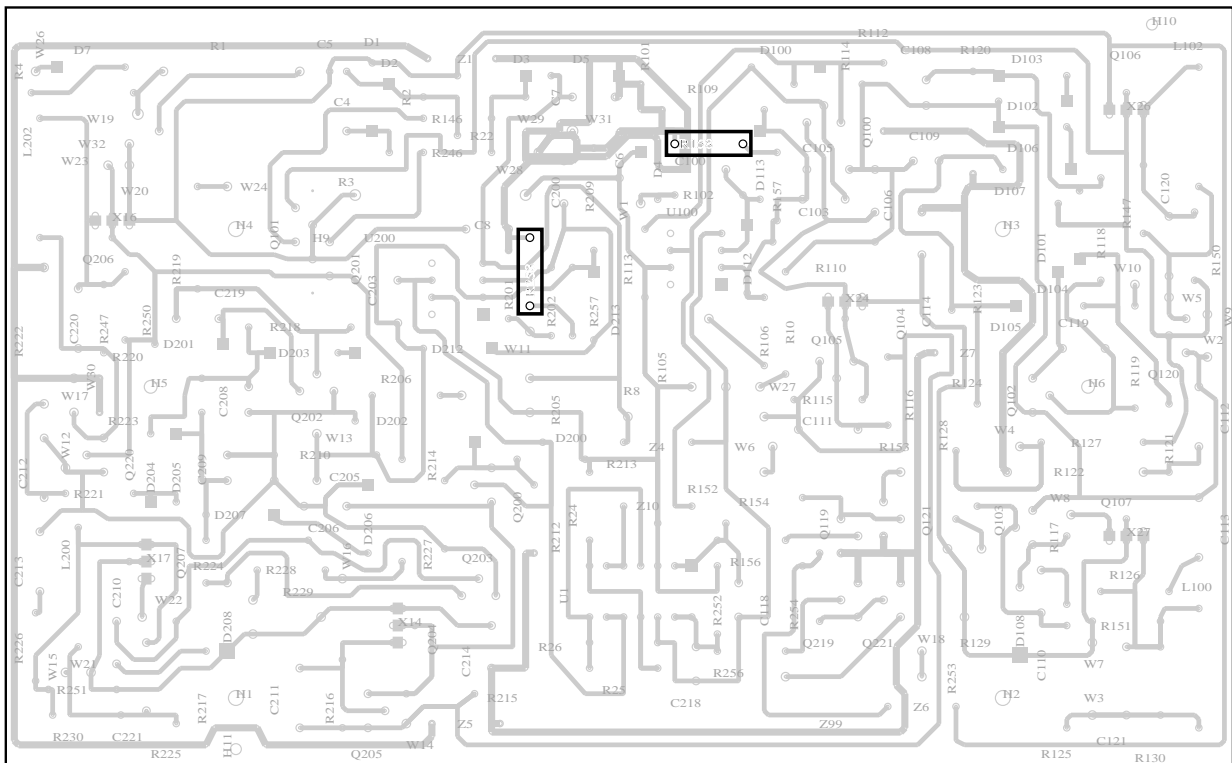

Fig. 7.1 Main Circuit Board (Component Side) and Input Sensitivity Jumper Locations

8 Service

This unit has very sophisticated circuitry which should only be serviced by a fully trained technician. This is one reason why each unit bears the following label:



CAUTION: To prevent electric shock, do not remove covers. No user serviceable parts inside. Refer servicing to a qualified technician.

8.1 Worldwide Service

Service may be obtained from an authorized service center. (Contact your local Crown/Amcron representative or our office for a list of authorized service centers.) To obtain service, simply present the bill of sale as proof of purchase along with the defective unit to an authorized service center. They will handle the necessary paperwork and repair.

Remember to transport your unit in the original factory pack. We will pay the surface shipping costs both ways **for warranty service** to the authorized service center nearest you after receiving copies of all shipping receipts. You must bear the expense of all taxes, duties, and customs fees when transporting the unit.

8.2 North American Service

Service may be obtained in one of two ways: from an authorized service center or from the factory. You may choose either. It is important that you have your copy of the bill of sale as your proof of purchase.

8.2.1 Service at a North American Service Center

This method usually saves the most time and effort. Simply present your bill of sale along with the defective unit to an authorized service center to obtain service. They will handle the necessary paperwork and repair. Remember to transport the unit in the original factory pack. A list of authorized service centers in your area can be obtained from our Technical Support Group.

8.2.2 Factory Service

To obtain factory service, fill out the **service information page** that follows and send it along with your proof of purchase and the defective unit to the Crown factory. For warranty service, we will pay for ground shipping both ways in the United States after receiving copies of the shipping receipts. Shipments should be

sent "UPS ground." (If the unit is under warranty, you may send it C.O.D. for the cost of freight via UPS ground.) The factory will return it via UPS ground. Please contact us if other arrangements are required.

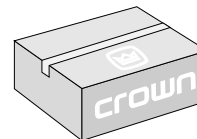

Always use the original factory pack to transport the unit.

Factory Service Shipping Instructions:

1. When sending a Crown product to the factory for service, be sure to fill out the service information form that follows and enclose it inside your unit's shipping pack. Do not send the service information form separately.
2. To ensure the safe transportation of your unit to the factory, ship it in an original factory packing container. If you don't have one, call or write Crown's Parts Department. With the exception of polyurethane or wooden crates, any other packing material will not be sufficient to withstand the stress of shipping. **Do not use loose, small size packing materials.**
3. Do not ship the unit in any kind of cabinet (wood or metal). Ignoring this warning may result in extensive damage to the unit and the cabinet. Accessories are not needed—do not send the instruction manual, cables and other hardware.

If you have any questions, please call or write the Crown Technical Support Group.

Crown Audio Division

Technical Support / Factory Service
57620 C.R. 105, Elkhart, Indiana 46517 U.S.A.

Telephone: 219-294-8200
800-342-6939 (North America,
Puerto Rico, and Virgin Islands only)

Facsimile: 219-294-8301

Fax Back: 219-293-9200
800-294-4094 (North America only)

Internet: <http://www.crownintl.com>

Crown Factory Service Information

Shipping Address: Crown International, Inc., Factory Service, 57620 C.R. 105, Elkhart, Indiana 46517
Phone: 1-800-342-6939 or 1-219-294-8200 Fax: 1-219-294-8301

Owner's Name: _____

Shipping Address: _____

Phone Number: _____

Model: _____ Serial Number: _____ Purchase Date: _____

NATURE OF PROBLEM

(Be sure to describe the conditions that existed when the problem occurred and what attempts were made to correct it.)

Detach and send with unit.

Other equipment in your system: _____

If warranty has expired, payment will be: Cash/Check VISA MasterCard C.O.D.

Card Number: _____ Exp. Date: _____

Signature: _____

ENCLOSE THIS PORTION WITH THE UNIT. DO NOT MAIL SEPARATELY.