

MACRO-TECH[®]

REFERENCE MANUAL

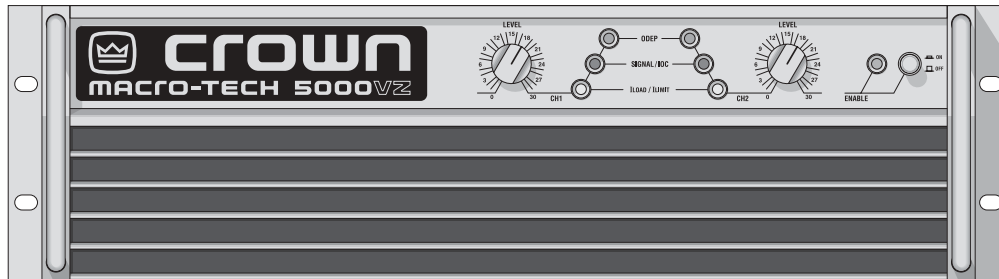

Model: Macro-Tech 5000VZ

Some models may be exported under the name *Amcron*[®]

©2003 by Crown Audio, Inc., P.O. Box 1000, Elkhart, IN 46515-1000 U.S.A. Telephone: 574-294-8000.
Fax: 574-294-8329. Trademark Notice: *PIP*, *SmartAmp* and *Grounded Bridge* are trademarks and *Amcron*, *Crown*, *Macro-Tech*, *IOC*, *ODEP*, *IQ System* and *P.I.P.* are registered trademarks of Crown International, Inc. Other trademarks are the property of their respective owners.



Approved for
THX Theatre
Systems

H A Harman International Company

103169-2A
3/03



THREE YEAR FULL WARRANTY



WORLDWIDE

SUMMARY OF WARRANTY

The Crown Audio Division of Crown International, Inc., 1718 West Mishawaka Road, Elkhart, Indiana 46517-4095 U.S.A. warrants to you, the ORIGINAL PURCHASER and ANY SUBSEQUENT OWNER of each NEW Crown¹ product, for a period of three (3) years from the date of purchase by the original purchaser (the "warranty period") that the new Crown product is free of defects in materials and workmanship, and we further warrant the new Crown product regardless of the reason for failure, except as excluded in this Crown Warranty.

¹ Note: If your unit bears the name "Amcron," please substitute it for the name "Crown" in this warranty.

ITEMS EXCLUDED FROM THIS CROWN WARRANTY

This Crown Warranty is in effect only for failure of a new Crown product which occurred within the Warranty Period. It does not cover any product which has been damaged because of any intentional misuse, accident, negligence, or loss which is covered under any of your insurance contracts. This Crown Warranty also does not extend to the new Crown product if the serial number has been defaced, altered, or removed.

WHAT THE WARRANTOR WILL DO

We will remedy any defect, regardless of the reason for failure (except as excluded), by repair, replacement, or refund. We may not elect refund unless you agree, or unless we are unable to provide replacement, and repair is not practical or cannot be timely made. If a refund is elected, then you must make the defective or malfunctioning product available to us free and clear of all liens or other encumbrances. The refund will be equal to the actual purchase price, not including interest, insurance, closing costs, and other finance charges less a reasonable depreciation on the product from the date of original purchase. Warranty work can only be performed at our authorized service centers. We will remedy the defect and ship the product from the service center within a reasonable time after receipt of the defective product at our authorized service center.

HOW TO OBTAIN WARRANTY SERVICE

You must notify us of your need for warranty service not later than ninety (90) days after expiration of the warranty period. All components must be shipped in a factory pack. Corrective action will be taken within a reasonable time of the date of receipt of the defective product by our authorized service center. If the repairs made by our authorized service center are not satisfactory, notify our authorized service center immediately.

DISCLAIMER OF CONSEQUENTIAL AND INCIDENTAL DAMAGES
YOU ARE NOT ENTITLED TO RECOVER FROM US ANY INCIDENTAL DAMAGES RESULTING FROM ANY DEFECT IN THE NEW CROWN PRODUCT. THIS INCLUDES ANY DAMAGE TO ANOTHER PRODUCT OR PRODUCTS RESULTING FROM SUCH A DEFECT.

WARRANTY ALTERATIONS

No person has the authority to enlarge, amend, or modify this Crown Warranty. This Crown Warranty is not extended by the length of time which you are deprived of the use of the new Crown product. Repairs and replacement parts provided under the terms of this Crown Warranty shall carry only the unexpired portion of this Crown Warranty.

DESIGN CHANGES

We reserve the right to change the design of any product from time to time without notice and with no obligation to make corresponding changes in products previously manufactured.

LEGAL REMEDIES OF PURCHASER

No action to enforce this Crown Warranty shall be commenced later than ninety (90) days after expiration of the warranty period.

THIS STATEMENT OF WARRANTY SUPERSEDES ANY OTHERS CONTAINED IN THIS MANUAL FOR CROWN PRODUCTS.

9/90

Telephone: 219-294-8200. Facsimile: 219-294-8301

NORTH AMERICA

SUMMARY OF WARRANTY

The Crown Audio Division of Crown International, Inc., 1718 West Mishawaka Road, Elkhart, Indiana 46517-4095 U.S.A. warrants to you, the ORIGINAL PURCHASER and ANY SUBSEQUENT OWNER of each NEW Crown product, for a period of three (3) years from the date of purchase by the original purchaser (the "warranty period") that the new Crown product is free of defects in materials and workmanship. We further warrant the new Crown product regardless of the reason for failure, except as excluded in this Warranty.

ITEMS EXCLUDED FROM THIS CROWN WARRANTY

This Crown Warranty is in effect only for failure of a new Crown product which occurred within the Warranty Period. It does not cover any product which has been damaged because of any intentional misuse, accident, negligence, or loss which is covered under any of your insurance contracts. This Crown Warranty also does not extend to the new Crown product if the serial number has been defaced, altered, or removed.

WHAT THE WARRANTOR WILL DO

We will remedy any defect, regardless of the reason for failure (except as excluded), by repair, replacement, or refund. We may not elect refund unless you agree, or unless we are unable to provide replacement, and repair is not practical or cannot be timely made. If a refund is elected, then you must make the defective or malfunctioning product available to us free and clear of all liens or other encumbrances. The refund will be equal to the actual purchase price, not including interest, insurance, closing costs, and other finance charges less a reasonable depreciation on the product from the date of original purchase. Warranty work can only be performed at our authorized service centers or at the factory. We will remedy the defect and ship the product from the service center or our factory within a reasonable time after receipt of the defective product at our authorized service center or our factory. All expenses in remedying the defect, including surface shipping costs in the United States, will be borne by us. (You must bear the expense of shipping the product between any foreign country and the port of entry in the United States and all taxes, duties, and other customs fees for such foreign shipments.)

HOW TO OBTAIN WARRANTY SERVICE

You must notify us of your need for warranty service not later than ninety (90) days after expiration of the warranty period. All components must be shipped in a factory pack, which, if needed, may be obtained from us free of charge. Corrective action will be taken within a reasonable time of the date of receipt of the defective product by us or our authorized service center. If the repairs made by us or our authorized service center are not satisfactory, notify us or our authorized service center immediately.

DISCLAIMER OF CONSEQUENTIAL AND INCIDENTAL DAMAGES
YOU ARE NOT ENTITLED TO RECOVER FROM US ANY INCIDENTAL DAMAGES RESULTING FROM ANY DEFECT IN THE NEW CROWN PRODUCT. THIS INCLUDES ANY DAMAGE TO ANOTHER PRODUCT OR PRODUCTS RESULTING FROM SUCH A DEFECT. **SOME STATES DO NOT ALLOW THE EXCLUSION OR LIMITATIONS OF INCIDENTAL OR CONSEQUENTIAL DAMAGES, SO THE ABOVE LIMITATION OR EXCLUSION MAY NOT APPLY TO YOU.**

WARRANTY ALTERATIONS

No person has the authority to enlarge, amend, or modify this Crown Warranty. This Crown Warranty is not extended by the length of time which you are deprived of the use of the new Crown product. Repairs and replacement parts provided under the terms of this Crown Warranty shall carry only the unexpired portion of this Crown Warranty.

DESIGN CHANGES

We reserve the right to change the design of any product from time to time without notice and with no obligation to make corresponding changes in products previously manufactured.

LEGAL REMEDIES OF PURCHASER

THIS CROWN WARRANTY GIVES YOU SPECIFIC LEGAL RIGHTS, YOU MAY ALSO HAVE OTHER RIGHTS WHICH VARY FROM STATE TO STATE. No action to enforce this Crown Warranty shall be commenced later than ninety (90) days after expiration of the warranty period.

THIS STATEMENT OF WARRANTY SUPERSEDES ANY OTHERS CONTAINED IN THIS MANUAL FOR CROWN PRODUCTS.

Telephone: 219-294-8200. Facsimile: 219-294-8301 9/90

Important Safety Instructions

- 1) Read these instructions.
- 2) Keep these instructions.
- 3) Heed all warnings.
- 4) Follow all instructions.
- 5) Do not use this apparatus near water.
- 6) Clean only with a dry cloth.
- 7) Do not block any ventilation openings. Install in accordance with the manufacturer's instructions.
- 8) Do not install near any heat sources such as radiators, heat registers, stoves, or other apparatus that produce heat.
- 9) Do not defeat the safety purpose of the polarized or grounding-type plug. A polarized plug has two blades with one wider than the other. A grounding-type plug has two blades and a third grounding prong. The wide blade or the third prong is provided for your safety. If the provided plug does not fit into your outlet, consult an electrician for replacement of the obsolete outlet.
- 10) Protect the power cord from being walked on or pinched, particularly at plugs, convenience receptacles, and the point where they exit from the apparatus.
- 11) Only use attachments/accessories specified by the manufacturer.
- 12) Unplug this apparatus during lightning storms or when unused for long periods of time.
- 13) Refer all servicing to qualified service personnel. Servicing is required when the apparatus has been damaged in any way, such as power-supply cord or plug is damaged, liquid has been spilled or objects have fallen into the apparatus, the apparatus has been exposed to rain or moisture, does not operate normally, or has been dropped.

The information furnished in this manual does not include all of the details of design, production, or variations of the equipment. Nor does it cover every possible situation which may arise during installation, operation or maintenance. If your unit bears the name "Amcron," please substitute it for the name "Crown" in this manual. If you need special assistance beyond the scope of this manual, please contact our Technical Support Group.

Crown Technical Support Group

1718 W. Mishawaka Rd., Elkhart, Indiana 46517 U.S.A.

Phone: 800-342-6939 (North America, Puerto Rico and Virgin Islands) or 574-294-8200

Fax: 574-294-8301 Fax Back (North America only): 800-294-4094 or 574-293-9200

Fax Back (International): 574-294-8100 Internet: <http://www.crownaudio.com>



The lightning bolt triangle is used to alert the user to the risk of electric shock.

DANGER: This amplifier can produce *lethal* levels of output power! Be very careful when making connections. Do not attempt to change the output wiring unless AC power has been removed from the amplifier for at least 10 seconds.



The exclamation point triangle is used to alert the user to important operating or maintenance instructions.

WARNING: This unit is capable of producing very high sound pressure levels. Continuous exposure to high sound pressure levels can cause permanent hearing impairment or loss. Caution is advised and ear protection recommended when playing at high volumes.

CAUTION

RISK OF ELECTRIC SHOCK
DO NOT OPEN

TO PREVENT ELECTRIC SHOCK DO NOT REMOVE TOP OR BOTTOM COVERS. NO USER SERVICEABLE PARTS INSIDE. REFER SERVICING TO QUALIFIED SERVICE PERSONNEL. DISCONNECT POWER CORD BEFORE REMOVING REAR INPUT MODULE TO ACCESS GAIN SWITCH.

AVIS

RISQUE DE CHOC ÉLECTRIQUE
N'OUVREZ PAS

À PRÉVENIR LE CHOC ÉLECTRIQUE N'ENLEVEZ PAS LES COUVERCLES. IL N'Y A PAS DES PARTIES SERVICEABLE À L'INTÉRIEUR. TOUS REPARATIONS DOIT ÊTRE FAIRE PAR PERSONNEL QUALIFIÉ SEULEMENT. DÉBRANCHER LA BORNE AVANT D'OUVRIR LA MODULE EN ARRIÈRE.



WARNING

TO REDUCE THE RISK OF ELECTRIC SHOCK, DO NOT EXPOSE THIS EQUIPMENT TO RAIN OR MOISTURE!

Magnetic Field

CAUTION! Do not locate sensitive high-gain equipment such as preamplifiers or tape decks directly above or below the unit. Because this amplifier has a high power density, it has a strong magnetic field which can induce hum into unshielded devices that are located nearby. The field is strongest just above and below the unit.

If an equipment rack is used, we recommend locating the amplifier(s) in the bottom of the rack and the preamplifier or other sensitive equipment at the top.

CONTENTS

1	Welcome	8
1.1	Why So Much Power?	8
1.2	Unpacking	8
1.3	Features	9
2	Facilities	10
3	Installation	13
3.1	Mounting	13
3.2	Cooling	13
3.3	Wiring	14
3.3.1	Stereo (Two-Channel) Operation	14
3.3.2	Bridge-Mono Operation	15
3.3.3	Parallel-Mono Operation	16
3.3.4	Input Connection	17
3.3.5	Output Connection	18
3.3.6	Additional Load Protection	20
3.4	AC Mains Power Requirements	21
4	Operation	22
4.1	Precautions	22
4.2	Indicators	22
4.3	Protection Systems	24
4.3.1	ODEP	24
4.3.2	Standby	24
4.3.3	Transformer Thermal Protection	25
4.3.4	Power Supply Fuses	25
4.4	Controls	26
4.5	Filter Cleaning	27
5	Technical Information	28
5.1	Overview	28
5.2	VZ Power	28
5.2.1	Background	28
5.2.2	The VZ Supply	29
5.3	Circuit Theory	29
5.3.1	Stereo Operation	29
5.3.2	Bridge-Mono Operation	32
5.3.3	Parallel-Mono Operation	32
5.3.4	Terminator Module	32
5.3.5	Display Module	32
6	Specifications	33
7	AC Power Draw and Thermal Dissipation	39
8	Accessories	40
8.1	PIP Modules	40
8.2	Level Control Security Kit	42

Contents continued...

9 Service	43
9.1 Worldwide Service	43
9.2 North American Service	43
9.2.1 Service at a North American Service Center	43
9.2.2 Factory Service	43

ILLUSTRATIONS

1.1 Macro-Tech 5000VZ Amplifier	8
2.1 Front Facilities	10
2.2 Front Facilities behind the Filter Grille	11
2.3 Rear Facilities	12
2.4 International Output Binding Posts	12
2.5 Output Cover	12
3.1 Mounting Dimensions	13
3.2 Top View of a Rack-Mounted Unit	13
3.3 Proper Air Flow in a Rack Cabinet	13
3.4 Stereo Wiring	14
3.5 Bridge-Mono Wiring	15
3.6 Parallel-Mono Wiring	16
3.7 Unbalanced Input Wiring	17
3.8 Balanced Input Wiring	17
3.9 Balanced and Unbalanced Phone Plug Wiring	17
3.10 Loudspeaker Offset Integration Switch	18
3.11 Input Ground Lift Switch	18
3.12 Wire Size Nomograph	19
3.13 Loudspeaker Fuse Nomograph	20
4.1 Indicators	22
4.2 Macro-Tech 5000VZ Indicator States	23
4.3 Input Sensitivity, LOI and Compressor Switches	26
4.4 Channel 1 VZ Mode Switch (Behind Filter)	27
5.1 A Typical Power Supply	29
5.2 Music Waveforms	29
5.3 VZ High-Current Mode	29
5.4 VZ High-Voltage Mode	29
5.5 Circuit Block Diagram	30
6.1 Minimum Power Matrix	35
6.2 Maximum Power Matrix	36
6.3 Typical Frequency Response	37
6.4 Typical Damping Factor	37
6.5 Typical Output Impedance	37
6.6 Typical Phase Response	38
6.7 Typical Crosstalk	38
7.1 Power Draw, Current Draw and Thermal Dissipation	39
8.1 Installing a PIP Module	40
8.2 Installing MA-LOCK Level Control Shaft Locks	42



Printed on recycled paper.

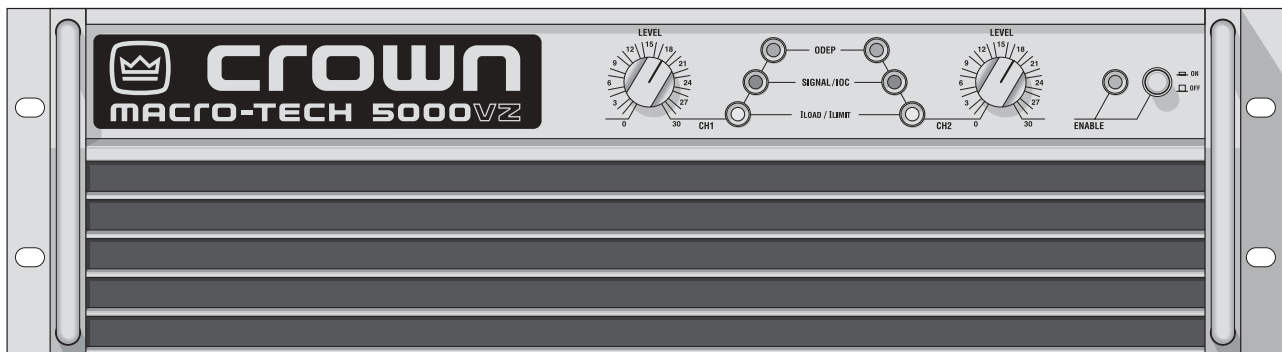

Fig. 1.1 Macro-Tech 5000VZ Amplifier

1 Welcome

Congratulations on your purchase of a *Macro-Tech*[®] *5000VZ*[®]. You have selected one of the most reliable, powerful and cost-effective professional amplifiers ever made. From now on, you can enjoy the advantages of having the highest level of innovation available in any amplifier at any price.

The *Macro-Tech 5000VZ* is the most advanced amplifier to offer Crown's patented Variable Impedance (VZ) power supply technology. New semiconductor technology is combined with superior VZ power supplies to enable the *Macro-Tech 5000VZ* to pack unprecedented power levels into 5¼ inches (13.3 cm) of vertical rack space. And because it is a *Macro-Tech*, you have the benefit of *ODEP*[®] protection to keep the show going long after other amplifiers have failed—even under the most severe conditions. In addition, your amplifier provides enhanced *PIP2* compatibility, which makes it easy to customize with a variety of popular input modules (see Section 8.1 for a list of available *PIP*[™] and *PIP2* modules).

This manual will help you successfully install and use your new amplifier. Please read all instructions, warnings and cautions. Be sure to read Sections 3.3.2 and 3.3.3 if you plan to use one of the amplifier's two mono modes. Also for your protection, please send in your warranty registration card today and save your bill of sale because it is your **official proof of purchase**.

1.1 Why So Much Power?

The *Macro-Tech 5000VZ* can deliver up to 2,500 watts per channel into 2-ohm stereo loads or 5,000 watts

bridged into a single 4-ohm load.* That's a lot of power for a unit that is only 5¼ inches (13.3 cm) tall and weighs less than 80 pounds (36.3 kg).

There are many reasons to use amplifiers with an extremely high power density. As more loudspeakers are driven with fewer amplifiers, audio systems become more compact and efficient. If the system is used for touring, this can reduce shipping costs and setup time. But concentrating so much power in one amplifier creates potential hazards that can permanently ruin your day. Your amplifier is capable of delivering enough electrical power at the output terminals to produce a lethal shock. If used improperly, it can also drive loudspeakers to levels that will cause permanent hearing damage. For these reasons, we have included appropriate warnings and cautions in this manual.

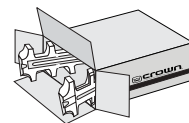

1.2 Unpacking

Please unpack and inspect your new amplifier for any damage that may have occurred during transit. If damage is found, notify the transportation company immediately. Only you, the consignee, may initiate a claim for shipping damage. Crown will be happy to cooperate fully as needed. Save the shipping carton as evidence of damage for the shipper's inspection.

Even if the unit arrived in perfect condition, as most do, save all packing materials so you will have them if you ever need to transport the unit. **NEVER SHIP THE UNIT WITHOUT THE FACTORY PACK.**

1.3 Features

The *Macro-Tech 5000VZ* uses the very latest technology and miniaturized design to provide the highest power and value for its size, weight and price. Its patented *Grounded Bridge™* circuitry offers many advantages over conventional designs. In Stereo mode, the amplifier's separate high-voltage supplies and ultra-low crosstalk make it possible to treat each channel as an independent amplifier. Here are some more of its impressive features:

- Patented Variable Impedance (VZ) power supplies for each channel provide the best power matching to your load. Three special modes are provided to control how and when the supplies shift impedance modes.
- Crown's *Grounded Bridge* design delivers extreme voltage swings without using easily stressed output transistor configurations like conventional amplifiers. The results are lower distortion and superior reliability.
- Patented *ODEP* (Output Device Emulation Protection) circuitry detects and compensates for overheating and overload to keep the amplifier working when others would fail. In addition, *ODEP* can be used to control the VZ power supplies by shifting them into high-current mode based on the requirements of the immediate conditions.
- *IOC®* (Input/Output Comparator) circuitry immediately alerts you of any distortion that exceeds 0.05%, providing dynamic *proof of distortion-free performance*.
- Enhanced *PIP2* (Programmable Input Processor) design accepts accessory modules that tailor the amplifier to suit individual applications, including wide-band load current monitoring.
- Convenient front panel indicators include an Enable indicator for the low-voltage power supply, and an *ODEP*, Signal Presence/*IOC* and I_{Load}/I_{Limit} indicator for each channel.
- Full protection against overvoltage, shorted outputs, mismatched loads, general overheating, DC and high-frequency/RF overloads. Full internal fault protection.
- "Standby" mode protects loudspeakers from low-frequency/DC output, turn-on/turn-off transients and other transients that can occur during an AC brownout. Standby mode also provides overvoltage protection from AC mains of more than 11% over the rated voltage.
- Innovative Loudspeaker Offset Integration (LOI) circuitry prevents asymmetrical audio waveforms from causing off-center woofer cone movement.
- Each channel has an independent, error-driven compressor that can be set for fast or slow attack and release times.
- Two custom toroidal power transformers (one per channel) provide maximum power transfer with minimum electromagnetic fields.
- The soft-start feature slowly brings the power supplies up to full voltage to avoid tripping the breaker that protects your AC wiring.
- Universal power supplies can be easily reconfigured for different AC mains voltages, making the amplifier convenient for use around the world.
- Low harmonic and intermodulation distortion give the best *dynamic transfer function* in the industry.
- Superior damping factor delivers maximum loudspeaker motion control.
- Balanced inputs for each channel have independent three-way input sensitivity switches.
- The factory-installed PIP2-FXQ includes a ground lift switch that can be used to isolate the AC (chassis) ground from the XLR and phone jack input grounds.
- Internal test ports provide rapid manufacturing and service diagnostics.
- Internal diagnostics LEDs make it easy to identify internal operating conditions in the field.
- Modular design makes service and maintenance much more convenient.
- The super-efficient cooling system features front-to-back air flow with cutting edge heat sinks and proportional on-demand forced-air cooling to prevent overheating and prolong component life.
- New touring chassis is extremely rugged and has been torture-tested with over 100,000 miles of simulated road abuse—even passing mil. spec. shock and vibration testing.
- Extruded aluminum front panel provides extra strength to resist physical damage.
- Rack mountable in a standard 19-inch (48.3-cm) equipment rack (the back of the amplifier should be supported) or units can be stacked directly on top of each other.
- Three year "No-Fault" full warranty completely protects your investment and guarantees its specifications.

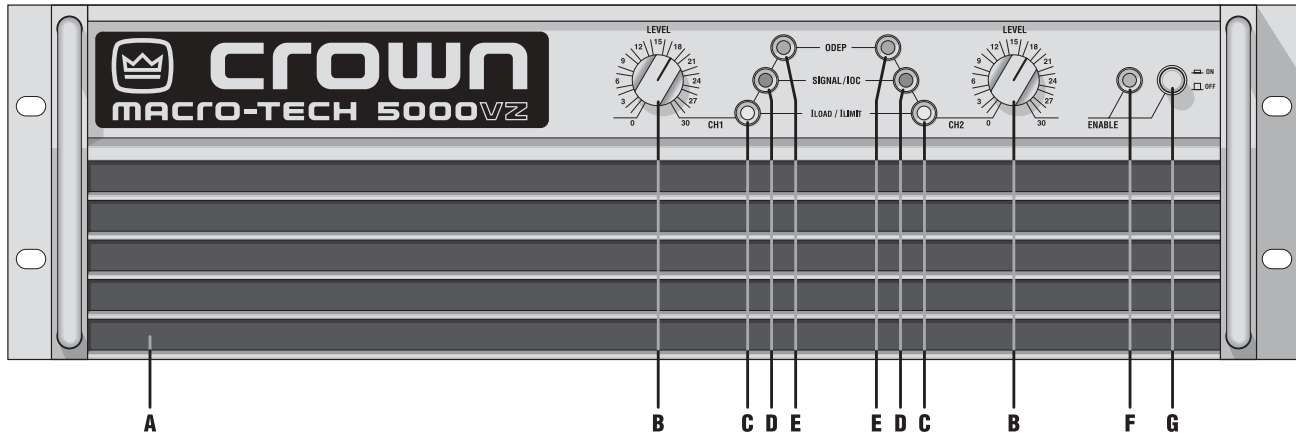

Fig. 2.1 Front Facilities

2 Facilities

A. Dust Filters

The dust filters remove large particles from air drawn in by the cooling fans. Check the filters regularly to prevent clogging (see Sections 3.2 and 4.5).

B. Level Controls

The output level for each channel is set with these convenient front panel level controls. Each control has 31 detents for precise adjustment (see Section 4.4). A security option is also available to prevent tampering (see Section 8.2).

C. I_{Load}/I_{Limit} Indicators

The flow of current to the loudspeakers (“load current”) and the maximum current limit of the amplifier (“limit current”) are monitored by these two-color front panel indicators. Normally, the I_{Load}/I_{Limit} indicators glow green to show that load current is flowing. They turn off when there is no significant load current. This happens when there is no input signal, the input signal is at an extremely low level, or there are no loads connected to the amplifier’s outputs. They turn red if the amplifier has reached its maximum output current capacity.

The I_{Load}/I_{Limit} indicators are very useful when loading the amplifier for maximum output. Just continue to connect additional loudspeakers in parallel with each output until the I_{Load}/I_{Limit} indicator turns red under normal operating conditions. The optimum load is achieved just before the indicator turns red (see Section 4.2).

D. Signal/IOC Indicators

These green multifunction indicators show both signal presence and distortion for each channel. As signal presence indicators, they flash synchronously with the amplifier’s audio output. As IOC (Input/Output Com-

parator) indicators, they flash brightly with a 0.1 second hold delay if there is a difference of 0.05% or more between the input and output audio waveforms. IOC “errors” occur most commonly when a large input signal causes an input overload or output clipping. The IOC function is also provided as proof of distortion-free performance (see Section 4.2).

E. ODEP Indicators

During normal operation of the ODEP (Output Device Emulation Protection) circuitry, these amber indicators glow brightly to show the presence of reserve thermal-dynamic energy. They dim proportionally as energy reserves decrease. In the rare event that energy reserves are depleted, the indicators turn off and ODEP proportionally limits output drive so the amplifier can safely continue operating even under severe conditions. These indicators also help to identify more unusual operating conditions (see Section 4.2).

F. Enable Indicator

This indicator lights when the amplifier has been turned on (enabled) and has AC power (see Section 4.2).

G. Enable Switch

This push button is used to turn the amplifier on and off. When turned on, the output is muted for about four seconds to protect your system from start-up transients. This is why a power sequencer is rarely needed for multiple units. (The length of the turn-on delay can be changed. Contact Crown’s Technical Support Group for details.)

H. VZ Mode Switches

A four-position switch is used to control the switching



Fig. 2.2 Front Facilities behind the Filter Grille



mode for each power supply. The switches are located behind the top dust filter about 1.75 inches (4.5 cm) behind the front panel. **Always turn off the power before changing either switch.** To access the VZ mode switches, remove the top dust filter and reach upward through the grille opening with a long narrow nonconductive object like a plastic pen. The switches are easy to locate with the aid of a flashlight. The switch for Channel 1 is located to the left side of the amplifier, while the switch for Channel 2 is located to the right.

From left to right, the four switch settings are VZ-ODEP, Lock Low, VZ and VZ (the third and fourth switch positions are identical). The first switch position sets the power supply to the VZ-ODEP switching mode, which is the default setting from the factory. The VZ-ODEP mode automatically shifts between high-current and high-voltage modes as needed, except when ODEP actively limits output drive, in which case the power supply is locked in its high-current mode. The second switch position is called “Lock Low.” It locks the power supply in high-current mode so the amplifier will always be ready to deliver maximum current to low-impedance loads. The third and fourth switch positions set the power supply to standard VZ mode. Standard VZ mode automatically switches between high-current and high-voltage modes as needed, but is not affected by ODEP (see Section 4.4).

I. Stereo/Mono Switch

This switch is used to select one of three output modes. Stereo mode is used for normal two-channel operation, Bridge-Mono mode is used to drive a single channel with a load impedance of at least 4 ohms, and Parallel-Mono mode is used to drive a single channel with a load impedance less than 4 ohms. **WARNING: The**

amplifier should be off for at least 10 seconds before changing this switch (see Section 3.3).



J. Compressor Switches

A three-position back panel switch is provided to control each channel’s “error-driven” input compressor. Attack and release times can be set to either “fast” or “slow,” or compression can be turned off for output clipping errors. The “fast” setting yields a 4-millisecond attack time and 300-millisecond release time. The “slow” setting yields a 12-millisecond attack and 600-millisecond release (see Section 4.4).

K. Loudspeaker Offset Integration Switches

Each channel has a two-position back panel on/off switch used to control the Loudspeaker Offset Integration (LOI) circuitry. LOI compensates for asymmetrical audio waveforms that cause off-center woofer cone movement (see Sections 3.3.4, 3.3.5 and 4.4).

L. Input Sensitivity Switches

These three-position back panel switches are used to select the input sensitivity for each channel. Available settings include 0.775 volts or 1.4 volts for standard 1 kHz output power, or a 26 dB voltage gain (see Section 4.4).

M. Power Cord

Units configured for 100 to 120 VAC have a 10-AWG, 30-amp line cord, while units set up for 200 to 240 VAC have a 12-AWG, 20-amp line cord. North American units configured for 120 VAC, 60 Hz power are shipped with a grounded 125-volt, 30-amp NEMA TT30P plug; units shipped outside North America are provided without a plug. See Sections 3.4 and 7 for AC requirements.

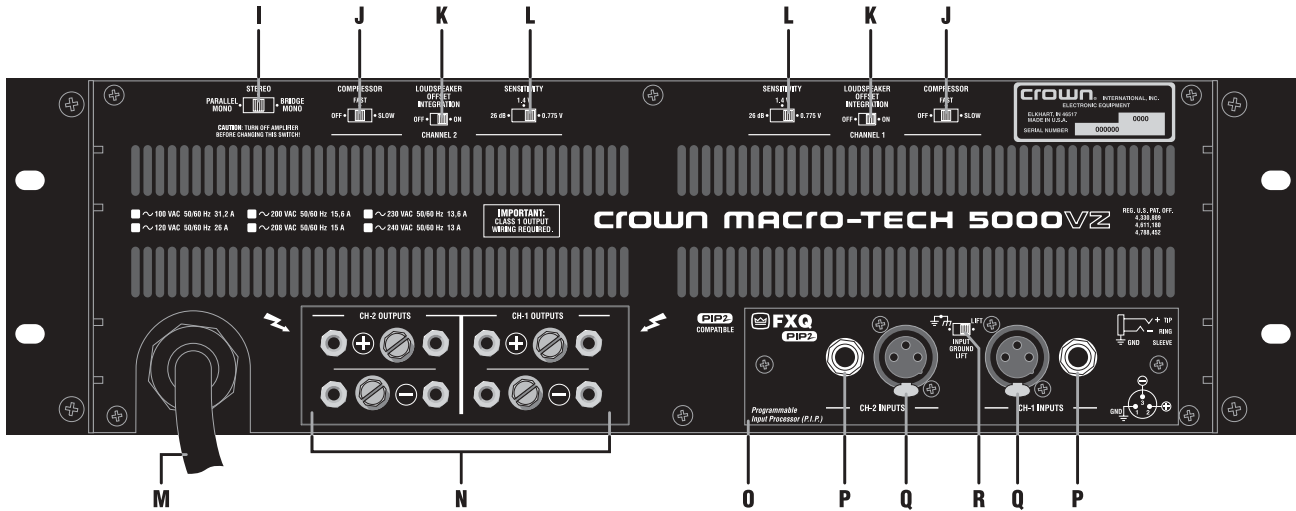

Fig. 2.3 Rear Facilities

N. Output Connectors

This high-current output block is provided for output connection. Its connectors accept banana plugs, spade lugs or bare wire. The detachable output cover (S) shown in Figure 2.5 is used to protect against accidental short circuits and dangerous electrical shock. **DANGER: The outputs can produce lethal energy levels! Do not change the output wiring unless the amplifier has been off for at least 10 seconds.**



Some international models include high-current binding posts for output connection rather than the output block shown in Figure 2.3. The international binding posts are shown below in Figure 2.4:

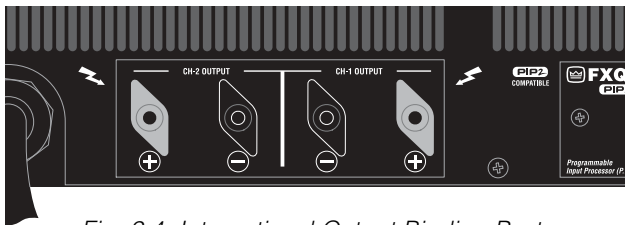

Fig. 2.4 International Output Binding Posts

O. PIP Module

The standard PIP2-FXQ is included with your amplifier. It provides female XLR and 1/4-inch (6.35-mm) phone jack input connectors. Each pair of XLR and phone jack connectors is wired in parallel, so the unused connector can be used as a “daisy chain” output to connect a source to multiple amplifiers. Other PIP and PIP2 modules can be used in place of the PIP2-FXQ to provide additional features that customize the amplifier for different applications. Your amplifier is a PIP2 amplifier, which means it can take advantage of the many advanced features found in PIP2 modules. In addition, your amp can also use standard PIP modules (without the PIP2 logo). See Section 8.1 for available PIP and PIP2 modules.

P. Balanced Phone Jack Inputs

A balanced 1/4-inch (6.35-mm) phone jack for each channel is provided on the PIP2-FXQ. These phone jacks can be used for signal input, or for “daisy-chained” output to other amplifiers. The phone jacks may be used with either balanced (tip, ring and sleeve) or unbalanced (tip and sleeve) wiring (see Section 3.3). *Note: The Channel 2 input is bypassed in either mono mode.*

Q. Balanced XLR Inputs

A balanced 3-pin female XLR connector is provided on the PIP2-FXQ for input to each channel, or for “daisy-chained” output to other amplifiers. *Note: The Channel 2 input is bypassed in either mono mode.*

R. Input Ground Lift Switch

This ground lift switch is located on the PIP2-FXQ. It is used to isolate the input signal grounds from the AC (chassis) ground to help prevent ground loops that can result in unwanted hum and noise.

S. Output Cover

This protective cover is provided to prevent an electrical shock or short circuit at the output terminals.

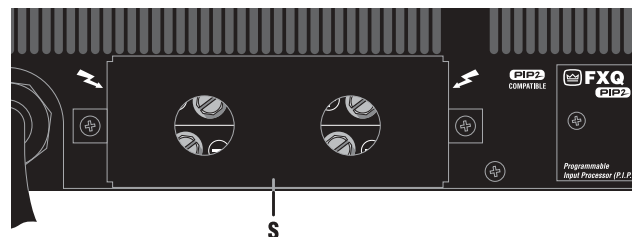

Fig. 2.5 Output Cover

3 Installation

3.1 Mounting

The *Macro-Tech 5000VZ* is designed for standard 19 inch (48.3 cm) rack mounting and “stack” mounting without a cabinet. For optimum cooling and rack support, multiple units should be stacked directly on top of each other.

! Important: Always support the back of the unit. Provide extra support if the unit will be transported.

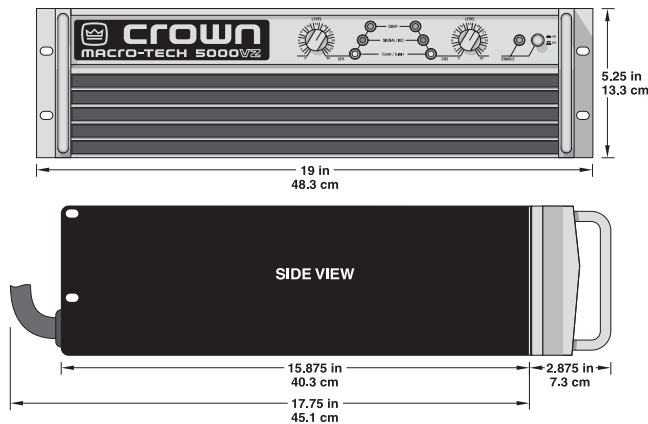

Fig. 3.1 Mounting Dimensions

3.2 Cooling

NEVER block the air vents in the front or back of the amplifier. *Macro-Tech* amplifiers do not need to be mounted with space between them. If you must leave open spaces in a rack for any reason, close them with blank panels or recirculation will result. Allow for air flow of at least 75 cubic feet (2.1 cubic meters) per minute

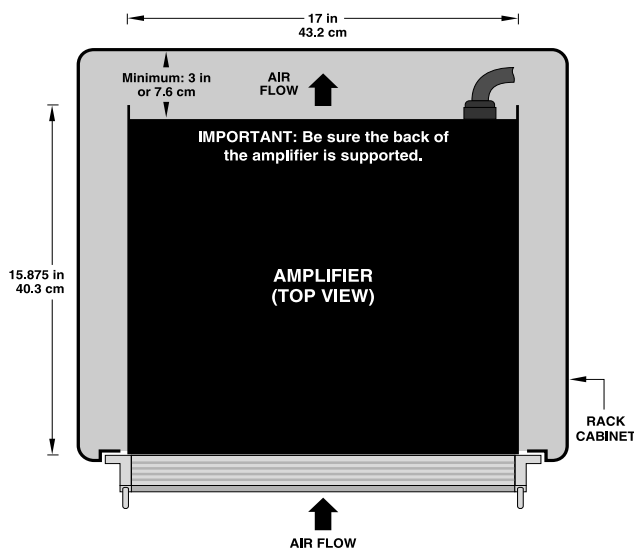

Fig. 3.2 Top View of a Rack-Mounted Unit

per unit. Additional air flow may be required when driving low-impedance loads at consistently high output levels. Refer to Section 7 for detailed information on thermal dissipation.

When mounting the amplifier in a rack cabinet, the back wall of the rack should be at least 3 inches (7.6 cm) away from the back of the amplifier chassis as shown in Figure 3.2.

Tip: An easy way to verify adequate cooling is to observe the ODEP indicators while the amplifier is operating under worst-case conditions. If the indicators dim, additional cooling is recommended.

If your rack has a door that could block air flow to the amplifier’s air intakes, you must provide adequate air flow by installing a grille in the door or by pressurizing the air behind the door. Wire grilles are recommended over perforated panels because they tend to cause less air restriction. A good choice for pressurizing the air behind the rack cabinet door is to mount a “squirrel cage” blower inside the rack (Option 1 below). At the bottom of the rack, mount the blower so it blows outside air into the space between the door and front of the amplifiers, pressurizing the “chimney” behind the door. This blower should not blow air into or take air out of the space behind the amplifiers. For racks without a door, you can evacuate the rack by mounting the blower at the top of the rack so that air inside the cabinet is drawn out the back (Option 2 below).

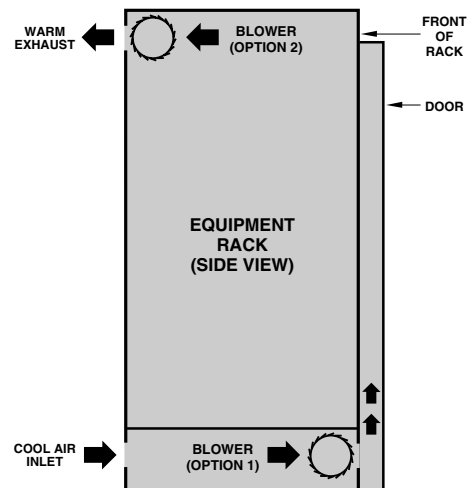

Fig. 3.3 Proper Air Flow in a Rack Cabinet

If the air supply is unusually dusty, you might want to pre-filter it using commercial furnace filters to prevent rapid loading of the unit’s own air filters. When needed, the unit’s filters can be cleaned with mild dish detergent and water (see Section 4.5).

3.3 Wiring

The following instructions describe the most common ways to install your amplifier in a sound system. The input and output terminals are located on the back panel. Please use care when making connections, selecting signal sources and controlling the output level. The load you save may be your own! Crown assumes no liability for personal injury or damaged loads from careless amplifier use or deliberate overpowering. All units include an output cover to prevent accidental electrical shock and short circuits. We strongly recommend that you use this safety feature.

⚡ DANGER: The outputs can produce **lethal energy levels**. Do not change the output wiring unless the amplifier has been off for at least 10 seconds. Turning off the amplifier also reduces the chance of blasts that can damage your hearing or loudspeakers.

Your amplifier can be operated in Stereo, Bridge-Mono, or Parallel-Mono mode by switching the back panel stereo/mono switch.

Turn off the amplifier and wait **at least 10 seconds before changing this switch or internal damage to the circuitry may result**. There are VERY IMPORTANT wiring differences among the three operating modes that will be discussed next.



3.3.1 Stereo (Two-Channel) Operation

In Stereo mode, installation is intuitive: input Channel 1 feeds output Channel 1, and input Channel 2 feeds output Channel 2. To activate Stereo mode, first turn off the amplifier and wait 10 seconds for the power supply to discharge. Then, slide the stereo/mono switch to the center position, and connect the output wiring as shown in Figure 3.4.

⚠ CAUTION: In Stereo mode, **never parallel the two outputs by directly tying them together, and never parallel them with the output of another amplifier**. Such a connection does not result in increased power output, but may result in overheating and premature activation of the protection circuitry.

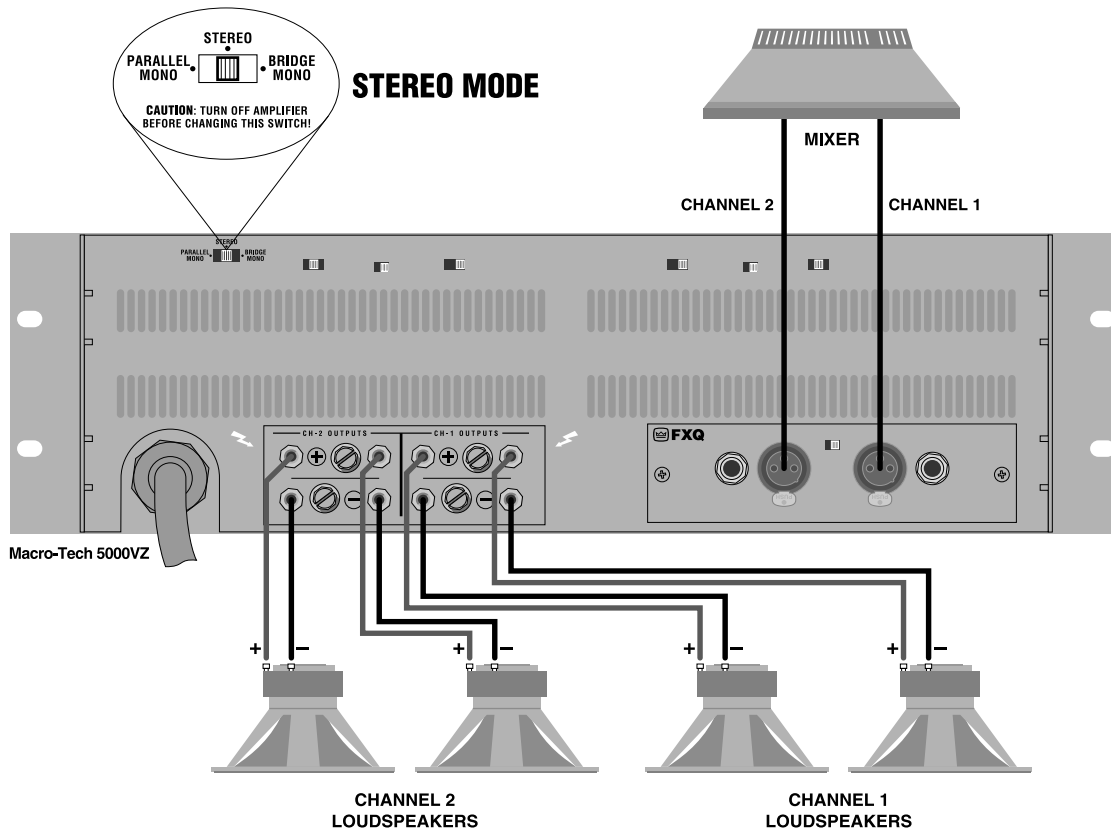

Fig. 3.4 Stereo Wiring

Note: A method for paralleling multiple amplifiers for fail-safe redundancy is available from Crown's Technical Support Group.

3.3.2 Bridge-Mono Operation

Bridge-Mono mode is intended for driving loads with a total impedance of 4 ohms or more (see Section 3.3.3 if the load is less than 4 ohms). Installing the amplifier in Bridge-Mono mode is different from the other modes and requires special attention.

To activate Bridge-Mono mode, turn the amplifier off, wait at least 10 seconds, and then slide the stereo/mono switch to the BRIDGE MONO position. Both outputs receive the signal from the Channel 1 input, with output Channel 2 inverted so it can be bridged with the Channel 1 output.

Note: The Channel 2 input jack and level control are disconnected in Bridge-Mono mode. A signal feeding Channel 2 will have no effect on the output.

Connect the load across the Channel 1 and 2 positive (+) terminals attaching the positive lead from the load to Channel 1 and the negative lead from the load to Channel 2 as shown in Figure 3.5. The negative (-) terminals are not used and should not be shorted. In addition, the connected load must be balanced (neither side connected to ground).

CAUTION: Be certain that every device connected to the Bridge-Mono output is balanced (not ground referenced). If the input signal ground is not fully isolated, connecting an output lead to ground may cause oscillations.

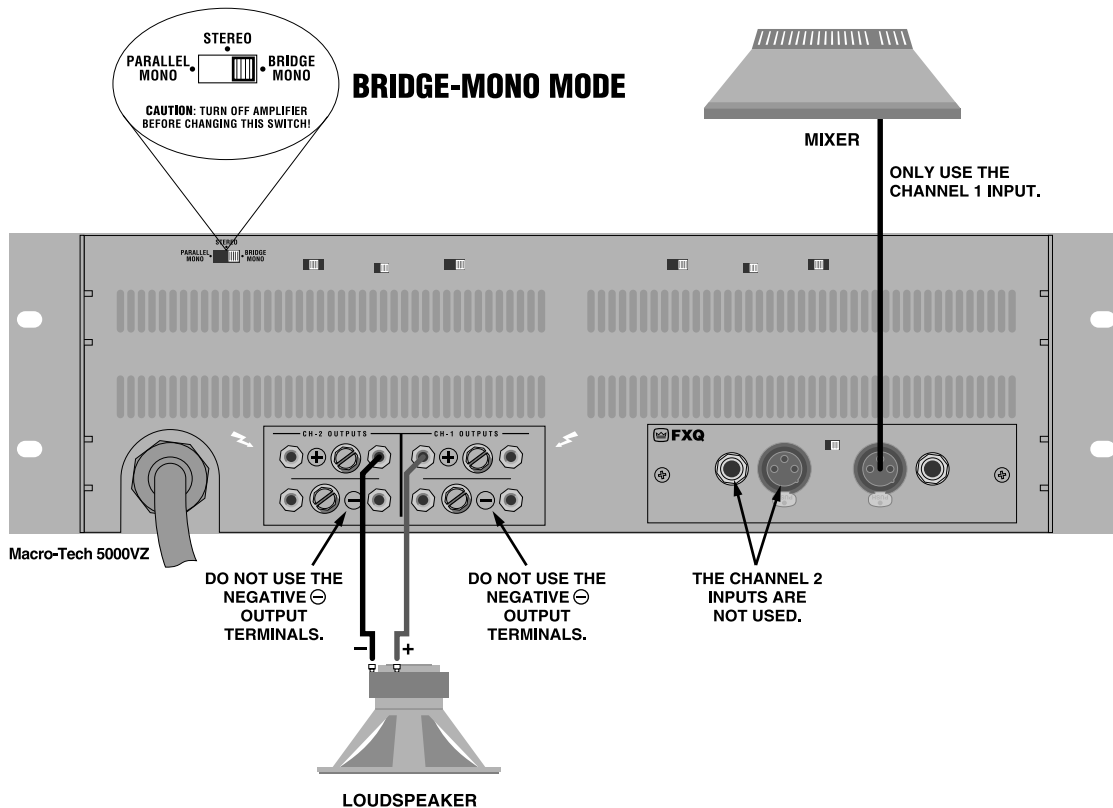

Fig. 3.5 Bridge-Mono Wiring

3.3.3 Parallel-Mono Operation

Parallel-Mono mode is intended for driving loads with a total impedance of less than 4 ohms (see Section 3.3.2 if the load is 4 ohms or greater). Installing the amplifier in Parallel-Mono mode is different from the other modes and requires special attention.

CAUTION: Do NOT operate the amplifier in Stereo or Bridge-Mono mode until the Parallel-Mono jumper is removed. Failure to do so will result in high distortion and excessive heating.

To activate Parallel-Mono mode, turn off the amplifier, wait at least 10 seconds, and slide the stereo/mono switch to the PARALLEL MONO position. Connect the input signal to Channel 1, and do not use the Channel

2 input. Both outputs will now receive the signal from the Channel 1 input.

Note: The Channel 2 input jack and level control are disconnected in Parallel-Mono mode. A signal feeding Channel 2 will have no effect on the output.

Install a jumper wire between the positive (+) outputs of Channel 1 and 2 that is at least 14 gauge in size. Then, connect the load to the output of Channel 1 as shown in Figure 3.6. The positive (+) lead from the load connects to the positive (+) Channel 1 terminal, and the negative (-) lead from the load connects to the negative (-) Channel 1 terminal.

CAUTION: Remove the jumper wire before changing to Stereo or Bridge-Mono mode.

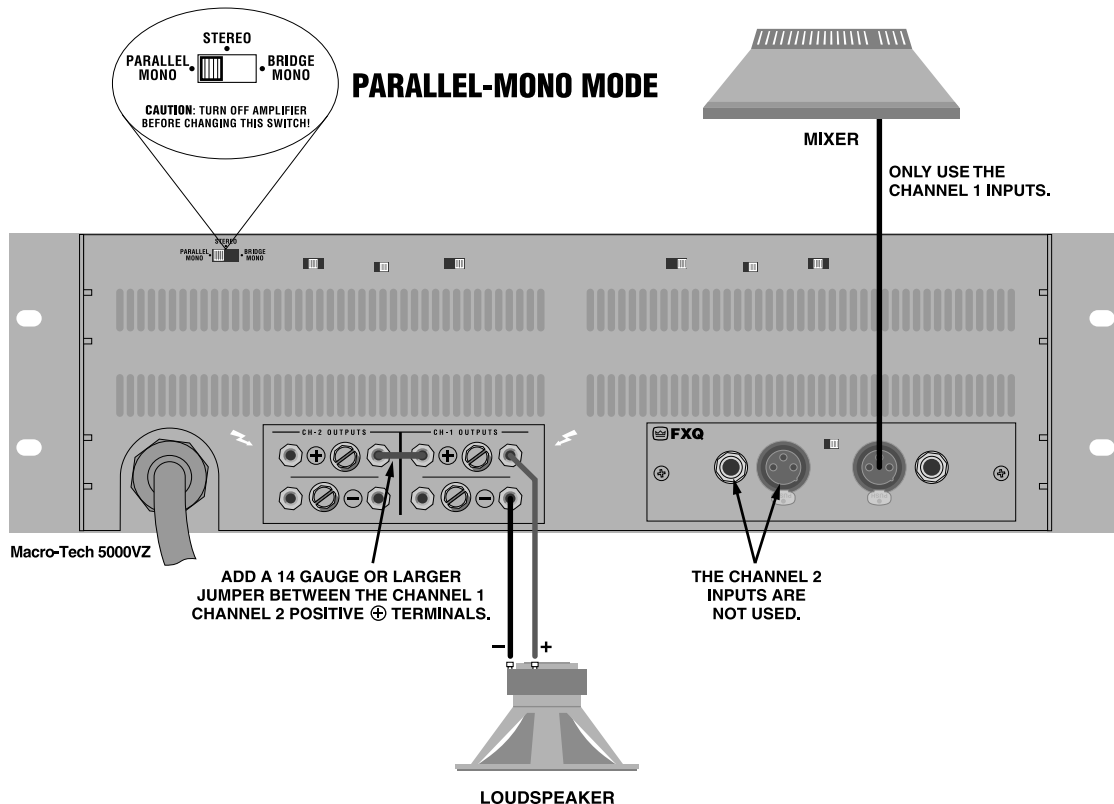

Fig. 3.6 Parallel-Mono Wiring

3.3.4 Input Connection

Both the XLR and 1/4-inch phone jack inputs are balanced. They have a minimum impedance of 10 K ohms (5 K ohms with unbalanced wiring) and will accept the line-level output of most devices. The XLR connectors and phone jacks are provided on the standard PIP2-FXQ input module (other PIP and PIP2 modules are described in Section 8.1). Correct input wiring will depend on two factors: (1) whether the input signals are balanced or unbalanced, and (2) whether the signal source floats or has a ground reference. Figures 3.7 and 3.8 show the recommended XLR connection techniques for each type of signal source.

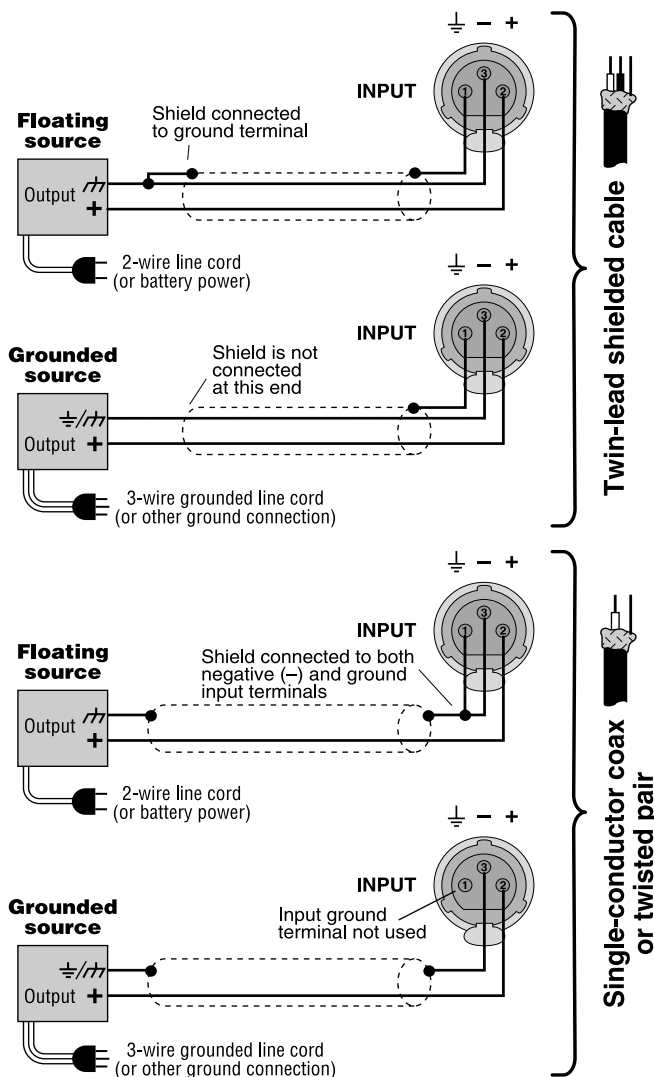

Fig. 3.7 Unbalanced Input Wiring

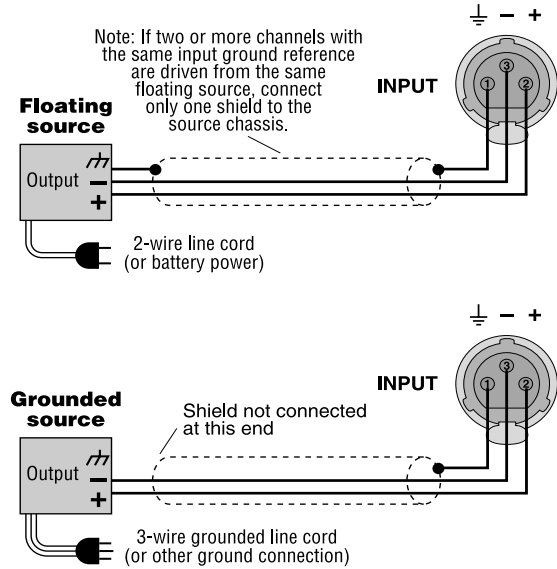

Fig. 3.8 Balanced Input Wiring

The phone jack input connectors can be wired similarly for balanced or unbalanced, ground-referenced or floating sources. They have a standard tip-ring-sleeve (TRS) configuration: the tip is positive (+), the ring is negative (-) and the sleeve is ground (see Figure 3.9). Wiring for various sources follows the XLR wiring guidelines shown in Figures 3.7 and 3.8.

The XLR and 1/4-inch phone jacks provided on the PIP2-FXQ are wired in parallel. This makes it possible to use one set for input to the amplifier and the other set for "daisy-chained" output to other amplifiers.

Please follow the instructions in Section 3.3.2 and 3.3.3 if the amplifier will be used in either Bridge-Mono or Parallel-Mono mode. Remember, the Channel 2 input and level control are disconnected in both mono modes.

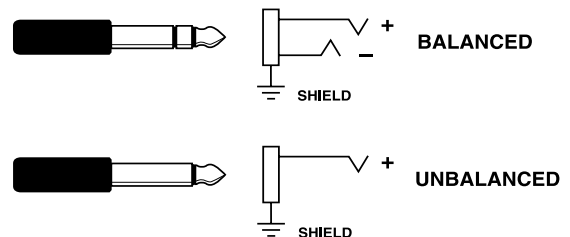

Fig. 3.9 Balanced and Unbalanced Phone Plug Wiring

SOLVING INPUT PROBLEMS

Sometimes large **infrasonic** (subaudible) **frequencies** are present in the input signal. This can cause output clipping and off-center woofer cone movement. As a result, the loudspeakers may handle less power and could be damaged by overload or excess heat. To reduce the risk of such problems, turn on the Loudspeaker Offset Integration (LOI) for each channel. The LOI switches are located on the back panel of the amplifier. This circuitry includes a third-order high-pass Butterworth filter with a -3 dB frequency of 35 Hz.

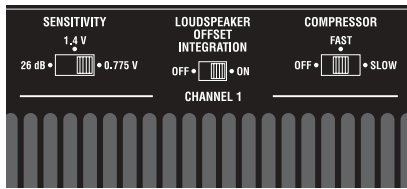

Fig. 3.10 Loudspeaker Offset Integration Switch

Another problem to avoid is the presence of large levels of **radio frequencies** (RF) in the input signal. Although high RF levels may not pose a threat to the amplifier, they can burn out tweeters or other loads that are sensitive to high frequencies. Extremely high RF levels can also cause the amplifier to prematurely activate its protection circuitry, resulting in inefficient operation. RF can be introduced into the signal by local radio stations and from the bias signal of many tape

Input Wiring Tips

1. Use only shielded cable. Cables with higher density shields are better. Spiral wrapped shield is not recommended.
2. When using unbalanced lines, keep the cables as short as possible. Avoid cable lengths greater than 10 feet (3 meters).
3. Do not run signal cables together with high-level wiring such as loudspeaker wires or AC cords. This reduces the chance of hum or noise being induced into the input cables.
4. **The amplifier should be off for at least 10 seconds** before changing any connections. This amplifier can produce lethal output energy and can drive loudspeakers to levels that can cause permanent hearing damage. Turn down level controls completely before powering the system back up. Crown is not liable for personal injury or damage that can result when a system component is overdriven.

recorders. The LOI circuitry will also help to avoid this potential problem. It includes a second-order Bessel low-pass filter with a -3 dB frequency of 50 kHz.

A third problem to avoid is **hum**. The two most common sources of hum in an audio system are **inductive coupling** and **ground loops**.

Inductive coupling can occur when input cables are subjected to a magnetic field from a power cord or power transformer. One way to prevent inductive coupling is to lace the input cables together along their length and route them as far away as possible from power transformers and power cords. The use of shielded pair cable is another effective way to reduce or eliminate hum resulting from inductive coupling.

Ground loops often result when two or more devices are improperly grounded. This causes undesirable stray currents that may produce hum in the output. The best way to avoid ground loops is to ensure that all system devices are plugged into the same power strip. In addition, make sure that all cable shields are grounded at one end only.

Input and output grounds are sometimes tied together for testing or metering. This can cause **feedback oscillation** from load current in the test loop. In some systems, even the AC power line may provide this feedback path. To avoid this problem, use proper grounding, isolate the inputs and other common AC devices. If needed, the input signal ground can be isolated from the AC mains ground with the ground lift switch located on the PIP2-FXQ (see Figure 3.11 and Section 4.4).

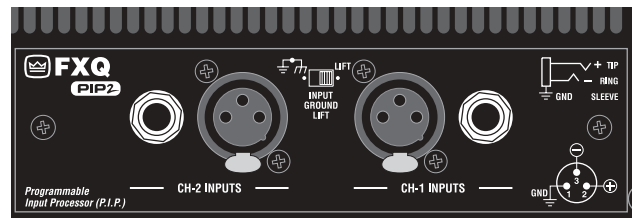

Fig. 3.11 Input Ground Lift Switch

3.3.5 Output Connection

Consider the power-handling capacity of your load before connecting it to the amplifier. Crown is not liable for damage incurred at any time due to overpowering. Fusing loudspeaker lines is highly recommended (see Section 3.3.6). Also, please pay close attention to the precautions provided in Section 4.1.

DANGER: The outputs can produce lethal energy levels! Do not change the output wiring unless the amplifier has been off for at least 10 seconds.



Use Good Connectors

1. To prevent possible short circuits, do not expose the loudspeaker cable connectors.
2. Do not use connectors that might accidentally tie two channels together when making or breaking connections (for example, a standard three-wire stereo phone plug).
3. Connectors that can be plugged into AC power receptacles should never be used.
4. Connectors with low current-carrying capacity should not be used.
5. Connectors with any tendency to short should never be used.

HOW TO DETERMINE APPROPRIATE WIRE GAUGE

It is important to use loudspeaker cables with sufficient gauge (thickness) for the length being used. The resistance introduced by inadequate cables reduces both the output power and the motion control of the loudspeakers. The latter occurs because the damping factor decreases as the cable resistance increases. This is very important because the amplifier's excellent damping factor can easily be negated by insufficient loudspeaker cables.

Use the nomograph in Figure 3.12 and the procedure that follows to find the recommended wire gauge (AWG or American Wire Gauge) for your system.

1. Note the load resistance of the loudspeakers connected to each channel of the amplifier. Mark this value on the **Load Resistance** line of the nomograph.
2. Select an acceptable damping factor and mark it on the **Damping Factor** line. Your amplifier can provide an excellent damping factor of 1,000 from 10 to 400 Hz in Stereo mode with an 8-ohm load. In contrast, typical damping factors are 50 or lower. Higher damping factors yield lower distortion and greater motion control over the loudspeakers. A common damping factor for commercial applications is between 50 and 100. Higher damping factors may be desirable for live sound, but long cable lengths often limit the highest damping factor that can be achieved practically. (Under these circumstances, Crown's *IQ System* is often used so amplifiers can be easily monitored and controlled when they are located very near the loudspeakers.) In recording studios and home hi-fi, a damping factor of 500 or more is very desirable.
3. Draw a line through the two points with a pencil, and continue until it intersects the **Source Resistance** line.

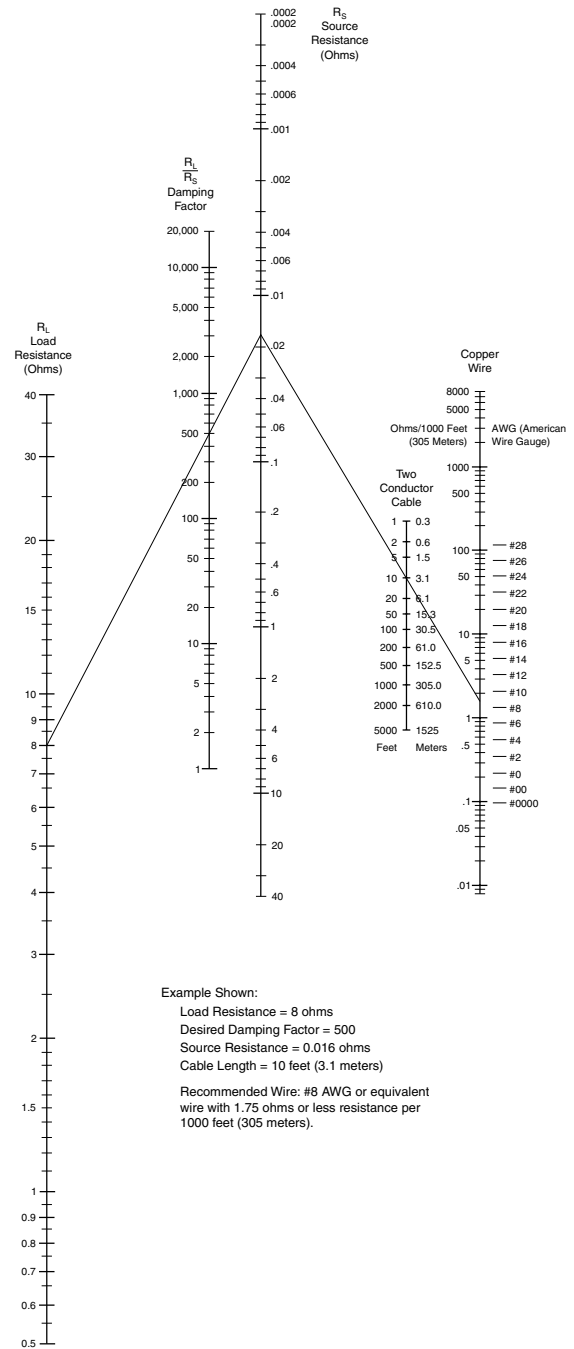

Fig. 3.12 Wire Size Nomograph

4. On the **2-Cond. Cable** line, mark the length of the cable run.
5. Draw a pencil line from the mark on the **Source Resistance** line through the mark on the **2-Cond. Cable** line, and on to intersect the **Annealed Copper Wire** line.
6. The required wire gauge for the selected wire length and damping factor is the value on the **Annealed Copper Wire** line. *Note: Wire size increases as the AWG gets smaller.*

7. If the size of the cable exceeds what you want to use, (1) find a way to use shorter cables, like using an *IQ System*, (2) settle for a lower damping factor, or (3) use more than one cable for each line. Options 1 and 2 will require the substitution of new values for cable length or damping factor in the nomograph. For option 3, estimate the effective wire gauge by subtracting 3 from the apparent wire gauge every time the number of conductors of equal gauge is doubled. So, if #10 wire is too large, two #13 wires or four #16 wires can be used for the same effect.

SOLVING OUTPUT PROBLEMS

Sometimes **high-frequency oscillations** occur which can cause your amplifier to prematurely activate its protection circuitry and result in inefficient operation. The effects of this problem are similar to the effects of the RF problem described in Section 3.3.4. To prevent high-frequency oscillations:

1. Turn on Loudspeaker Offset Integration for each channel. It includes a low-pass filter to prevent RF problems (see Section 3.3.4).
2. Lace together the loudspeaker conductors for each channel (do not lace together the conductors from different channels). This minimizes the chance that cables will act like antennas and transmit or receive high frequencies that can cause oscillation.
3. Avoid using shielded loudspeaker cable.
4. Avoid long cable runs where the loudspeaker cables from different amplifiers share a common cable tray or cable jacket.
5. Never connect the amplifier's input and output grounds together.
6. Keep loudspeaker cables well separated from input cables.
7. Install the input wiring according to the instructions in Section 3.3.4.

Another problem to avoid is the presence of large **infrasonic currents** when primarily inductive loads are used. Such loads include 70 volt step-up transformers and electrostatic loudspeakers.

Inductive loads may appear as a short circuit at low frequencies. This can cause the amplifier to produce large low-frequency currents and activate its protection circuitry. Always turn on the LOI circuitry when a primarily inductive load is used. The LOI circuitry provides protection from most low-frequency input and output problems.

3.3.6 Additional Load Protection

Your amplifier can generate high power levels. If your loudspeakers do not have built-in protection from excessive power, it's a good idea to protect them. Loudspeakers are subject to thermal damage from sustained overpowering and mechanical damage from large transient voltages. Special fuses can be used to protect your loudspeakers in both cases.

Different types of fuses are required for thermal protection and voltage protection. Slow-blow fuses are usually selected to protect loudspeakers from thermal damage because they are similar to loudspeakers in the way they respond to thermal conditions over time. In contrast, high-speed instrument fuses like the Littlefuse 361000 series are used to protect loudspeakers from large transient voltages. The nomograph in Figure 3.13 can be used to select the properly rated fuse for either type of loudspeaker protection.

There are basically two approaches that can be taken when installing fuses for loudspeaker protection. A common approach is to put a single fuse in series with

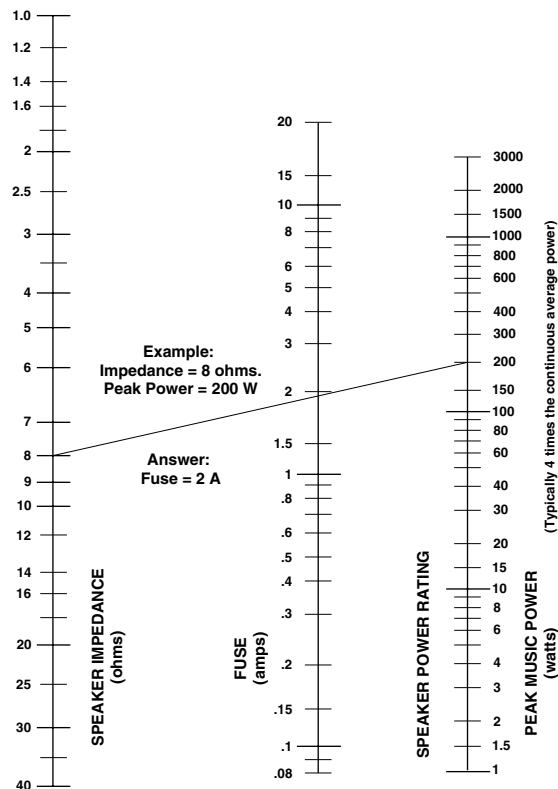

Fig. 3.13 Loudspeaker Fuse Nomograph

the output of each channel. This makes installation convenient because there is only one fuse protecting the loads on each output. The main disadvantage of this approach becomes apparent if the fuse blows, because none of the loads will receive any power.

A better approach is to fuse each driver independently. This allows you to apply the most appropriate protection for the type of driver being used. In general, low-frequency drivers (woofers) are most susceptible to thermal damage and high-frequency drivers (tweeters) are usually damaged by large transient voltages. This means that your loudspeakers will tend to have better protection when the woofers are protected by slow-blow fuses and high-frequency drivers are protected by high-speed instrument fuses.

3.4 AC Mains Power Requirements

Each *Macro-Tech 5000VZ* is supplied from the factory with an appropriate AC cord. Units configured for 100 to 120 VAC operation are shipped with 10 AWG, 30 amp line cords. Units configured for 200 to 240 VAC operation are shipped with 12 AWG, 20 amp line cords. North American units configured for 120 VAC, 60 Hz operation are provided with a 125 volt, 30 amp NEMA TT30P plug. Units destined for other parts of the world are provided without a plug. Whenever possible, connect the power cord to an isolated power circuit with adequate current (see Section 7 for detailed information on current draw). Excessive line voltages of more

than 11% above the amplifier's rated line voltage will activate the overvoltage protection circuitry (refer to Section 4.3.2). For example, do not exceed a line voltage of 133 VAC for units configured for 120 VAC operation.

All specifications in this manual were measured using 120 VAC, 60 Hz power mains unless otherwise noted. Specifications are derived using a mains voltage that is accurate to within 0.5% and with THD less than 1.0% under all testing conditions. Performance variations can occur at other AC mains voltages and line frequencies. In addition, line regulation problems will directly affect the output power available from the amplifier.

A qualified technician can reconfigure your amplifier for different AC voltages and frequencies by changing the power supply connections on the control board inside the amplifier. The proper procedures are outlined inside the top cover of the amplifier. Contact Crown's Technical Support Group for more information.

WARNING: Risk of severe electric shock. Only a qualified technician should attempt to alter the line voltage configuration.









Although this amplifier is rated for operation at 100 and 120 VAC, it is more efficient at 200, 208, 230 or 240 VAC. At these higher voltages, less power is converted to thermal energy in the AC cord and slightly more power is available at low frequencies.

4 Operation

4.1 Precautions

The *Macro-Tech 5000VZ* is protected from internal and external faults, but you should still take the following precautions for optimum performance and safety:

-  **1. DANGER: The outputs can produce lethal energy levels! Do not change the output wiring unless the amplifier has been off for at least 10 seconds.**
-  **2. DANGER: Improper use of this amplifier may result in permanent hearing damage. Be very careful when working near the loudspeakers that are connected to this amplifier.**
3. Improper wiring for Stereo, Bridge-Mono and Parallel-Mono modes can result in serious operating difficulties. Refer to Section 3.3 for details.
-  **4. WARNING: After the amplifier has been turned off, wait at least 10 seconds before changing the position of the stereo/mono switch.**
-  **5. CAUTION: In Parallel-Mono mode, a jumper is used between the positive (+) Channel 1 and 2 output terminals. Be sure to remove this jumper for Stereo or Bridge-Mono mode, otherwise high distortion and excessive heating will occur.** Check the stereo/mono switch on the back panel for proper position.
-  **6. Turn off the amplifier and unplug it from the AC power before removing the *PIP* card.**
7. Use care when making connections, selecting signal sources and controlling the output level. The load you save may be your own.
8. Do not short the ground lead of an output cable to the input signal ground. This may form a ground loop and cause oscillations.
9. Operate the amplifier only at its rated AC power voltage $\pm 10\%$ and the specified line frequency.
-  **10. Never connect the output to a power supply output, battery or power main.** Such connections may result in electrical shock.
-  **11. Tampering with the circuitry or making unauthorized modifications can cause severe electric shock and may invalidate the warranty.**

Remember: Crown is not liable for damage or personal injury that results from overdriving system components.

4.2 Indicators

The *Macro-Tech 5000VZ* has several internal indicators that can be used to help to identify a problem that causes a power supply to be put in “standby.” These indicators are described in Section 4.3.2.

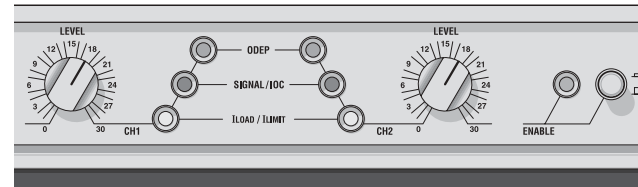

Fig. 4.1 Indicators

The amber **Enable indicator** is provided to show that the amplifier has been turned on (or enabled), and that its low-voltage power supply is working. It does not indicate the status of the high-voltage power supplies. The Enable indicator will stay on during unusual conditions that cause the amplifier's protection systems to put a channel in “standby” (see Section 4.3).

The amber **ODEP indicators** confirm the normal operation of Crown's patented Output Device Emulation Protection circuitry. During normal operation, they glow brightly to show the presence of reserve thermal-dynamic energy. An indicator will dim proportionally as the energy reserve for its channel decreases. In the rare event that a channel has no reserve energy, the indicator turns off and *ODEP* proportionally limits the channel's output drive level so the amplifier can continue safe operation even when conditions are severe. (See Section 4.3.1 for a detailed description of *ODEP*.)

The *ODEP* indicator for the affected channel will turn off if a high-voltage power supply is put in “standby” mode, a high-voltage power supply fuse blows, or a transformer activates its thermal protection circuitry (see Section 4.3). Both *ODEP* indicators turn off if the amplifier loses AC power, the power switch is turned off or the low-voltage power supply fuse blows.

The green **Signal/IOC indicators** show signal presence, distortion and input overload. As signal presence indicators, they flash with normal intensity in sync with the audio output. As *IOC* (Input/Output Comparator) indicators, they flash brightly if there is any difference between the input and output signal waveforms greater than 0.05%. Because transient distortion happens quickly, a 0.1 second “hold delay” keeps the indicators on long enough to be easily noticed. The *IOC* function essentially provides *proof of distortion-free performance*. As input overload indicators, they flash brightly



























Indicator Status	Amplifier Condition
ODEP —  OFF SIGNAL / IOC —  OFF I _{LOAD} / I _{LIMIT} —  OFF	<p>There is no power to the amplifier and all indicators are off, including the Enable light. Possible reasons: (1) The amplifier's Enable switch is off. (2) The amplifier is not plugged into the power receptacle. (3) The AC circuit breaker has been tripped. (4) The amplifier's low-voltage power supply fuse has blown.</p>
ODEP —  ON SIGNAL / IOC —  OFF I _{LOAD} / I _{LIMIT} —  OFF	<p>Normal operation for a channel with NO audio output. Possible reasons: (1) There is no input signal. (2) The input signal level is very low. (3) The channel's level control is turned down.</p>
ODEP —  ON SIGNAL / IOC —  Active I _{LOAD} / I _{LIMIT} —  OFF	<p>Normal operation for a channel with audio output and NO load current. Possible reasons: (1) There is no load connected to the channel. (2) The channel's output level is so low that no significant load current is flowing.</p>
ODEP —  ON SIGNAL / IOC —  Active I _{LOAD} / I _{LIMIT} —  Green	<p>Normal operation for a channel with audio output and a connected load. The signal/IOC indicator will flash with normal intensity to show that the channel has audio output, and the I_{LOAD}/I_{LIMIT} indicator will turn green to show that load current is flowing.</p>
ODEP —  ON SIGNAL / IOC —  Bright I _{LOAD} / I _{LIMIT} —  Off/Green	<p>The channel's output is exceeding 0.05% distortion. The input signal level is too high, and IOC is reporting either an input overload or output clipping.</p>
ODEP —  OFF SIGNAL / IOC —  Bright I _{LOAD} / I _{LIMIT} —  OFF	<p>The amplifier channel is in standby mode. Possible reasons: (1) A PIP module like an IQ-PIP-USP2 has turned off the channel's high-voltage power supply. (2) The amplifier has just been turned on and is still in the four second turn-on delay. (3) The DC/low-frequency protection circuitry has been activated. (4) The fault protection circuitry has been activated. (5) The transformer thermal protection circuitry has been activated. (6) The overvoltage protection circuitry has been activated after detecting voltage of more than 10% over the rated AC mains voltage.</p> <p style="text-align: center;">OR</p> <p>The channel's high-voltage power supply fuse has blown. Transformer overload can cause the channel's internal high-voltage power supply fuse to blow.</p>
ODEP —  OFF SIGNAL / IOC —  Bright I _{LOAD} / I _{LIMIT} —  Green	<p>ODEP limiting has been activated. Possible reasons: (1) The amplifier's air filters are blocked and need to be cleaned. (2) There is insufficient cooling because of inadequate air flow or air that is too hot. (3) The load impedance for the channel is too low because the output is shorted or the amplifier is driving too many loudspeakers for the selected stereo/mono mode. (4) The amplifier channel is continuously being driven to very high output levels.</p>
ODEP —  Dim SIGNAL / IOC —  Active I _{LOAD} / I _{LIMIT} —  Green	<p>ODEP limiting is about to begin. Possible reasons: (1) The amplifier's air filters are blocked and need to be cleaned. (2) There is insufficient cooling because of inadequate air flow or air that is too hot. (3) The load impedance for the channel is too low because the output is shorted or the amplifier is driving too many loudspeakers for the selected stereo/mono mode. (4) The amplifier channel is continuously being driven to very high output levels.</p>
ODEP —  Any State SIGNAL / IOC —  Bright I _{LOAD} / I _{LIMIT} —  Red	<p>Output current is being limited. The load impedance for the channel is too low because the output is shorted or the amplifier is driving too many loudspeakers for the selected stereo/mono mode.</p>

Fig. 4.2 Macro-Tech 5000VZ Indicator States

with a 0.1 second hold delay to show that an input signal is too large and must be compressed at the input.

The indicators will also stay on brightly for a channel that is put in standby mode (see Section 4.3.2). Under abnormal operating conditions, a high-voltage power supply may be put in standby mode to prevent amplifier damage. If this happens, the channel's Signal/IOC indicator will stay on with full brightness.

The two-color **I_{Load}/I_{Limit} indicators** show current flow to the loudspeakers ("load current") and the maximum current available from the amplifier ("limit current"). As load current indicators, they glow green to show that current is flowing to the loads connected to the amplifier outputs. As current limit indicators, they turn red to show that the amplifier is delivering its maximum output current. The indicators turn off when there is no significant load current flowing. This can happen when a channel has no input signal, the input signal is at a very low level, there is no load connected to the output, or the output cable is damaged.

The amount of current an amplifier can produce determines the lowest impedance it can drive. Parallel-Mono mode can deliver the most current, so it can drive the most loudspeakers wired in parallel with the lowest total impedance. For maximum performance, loads should be matched to the amplifier. If load impedance is too low, the amplifier's protection systems will limit output. If load impedance is too high, some of the amplifier's output power capability will go unused.

The **I_{Limit}** feature is designed to help you get the maximum power out of your amplifier. In the real world, loudspeaker impedance varies with frequency, and loudspeaker impedance ratings are only approximations. Without **I_{Limit}**, you have to do some lengthy calculations to approximate the maximum number of loudspeakers you can drive with the amplifier—and this does not allow for a 4 ohm loudspeaker whose impedance drops below 2 ohms at 80 Hz.

This is why your amplifier has **I_{Limit}**. The **I_{Limit}** function turns a channel's **I_{Load}/I_{Limit}** indicator red when it reaches maximum current output. This makes it possible to connect real loudspeakers and conduct realistic tests to find the maximum number of loudspeakers that should be connected. To do a test like this, you can operate under worst-case conditions and continue to connect additional loudspeakers in parallel with each output until the **I_{Load}/I_{Limit}** indicator turns red. The optimum load is achieved before the **I_{Load}/I_{Limit}** indicator turns red, so disconnecting the last added loudspeaker gives you an optimized load.

4.3 Protection Systems

The *Macro-Tech 5000VZ* provides extensive protection and diagnostics capabilities. Protection systems include *ODEP*, "standby" mode, power supply fuses and special thermal protection for the unit's transformers.

4.3.1 ODEP

Crown invented *ODEP* to prevent amplifier shutdown during demanding operation and to increase the efficiency of the output circuitry. To do this, Crown established a rigorous program to measure the *safe operating area* (SOA) of each output transistor before installing it in an amplifier. Next, Crown designed intelligent circuitry to simulate the instantaneous operating conditions of those output transistors. Its name describes what it does: Output Device Emulation Protection or *ODEP*. In addition to simulating the operating conditions of the output transistors, it also compares their operation to their known SOA. If it sees that more power is about to be asked of them than they are capable of delivering under the present conditions, *ODEP* immediately limits the drive level until it falls within the SOA. Limiting is proportional and kept to an absolute minimum—only what is required to prevent output transistor damage.

This level of protection enables Crown to increase output efficiency to never-before-achieved levels while greatly increasing amplifier reliability.

The on-board intelligence is monitored in two ways. First, the front panel *ODEP* indicators show whether the amplifier is functioning correctly or if *ODEP* is limiting the drive level. Second, *ODEP* data is fed to the *PIP* connector so advanced *PIP* modules like the IQ-*PIP*-*USP2* can monitor and control the amplifier.

With *ODEP*, the show keeps going because you get the maximum power with the maximum protection.

4.3.2 Standby

At the heart of the protection systems is standby mode which temporarily removes power from the high-voltage supplies to protect the amplifier and connected loads. Several conditions can put a channel into standby mode. Use the indicator table in Figure 4.2 to identify an amplifier channel in standby mode.

The **overvoltage protection** circuitry puts both channels in standby if the AC line voltage increases to more than 11% of the amplifier's rated AC configuration. This circuitry prevents power supply damage that can result from excessive AC line voltage, voltage spikes, and other unusual conditions.

The **undervoltage protection** circuitry can also activate the standby mode. If the AC line voltage drops to about 20% or more below the unit's rated voltage, both channels will go into standby to prevent loudspeaker damage that can result from brownouts and blackouts.

If dangerous subsonic frequencies or direct current (DC) is detected in the amplifier's output, the **DC/low-frequency protection** circuitry will put the channel in standby to protect the loads and prevent oscillations.

Internal Standby Indicators (For Qualified Technicians Only)

Although it is very unlikely that you will ever see an amplifier channel unintentionally put in standby, eight internal indicators (four per channel) are provided to help troubleshoot such a situation. They are located inside the top cover of the amplifier. **DANGER: Electrical shock from this amplifier can be lethal. The top cover should only be removed by a qualified technician.**

Four indicators are provided per channel, with six on the main board and two on the control board. Main board indicators include the following: (1) DC/low-frequency protection, labeled "DC/LF;" (2) fault, labeled "OUTPUT MOD FAULT;" and (3) standby, labeled "STBY." The control board indicators help identify overvoltage conditions or transformer thermal protection. These indicators are labeled "OVER-VOLT/THERM."

If the DC/LF indicator is lit, see what the indicator does when you remove the input signal. If it turns off, the problem is DC or subsonic material in the input signal and you should refer to Section 3.3.4; if it stays on, refer the amplifier to a qualified technician for service.

If the OUTPUT MOD FAULT indicator is lit, turn the amplifier off, wait ten seconds and then turn it back on. If the indicator stays off, try using the amplifier for normal operation; if the indicator turns on again, refer the amplifier to a qualified technician for service.

If the STBY indicator is lit, the installed *PIP* module has put the channel in standby. For example, *PIPs* controlled by the *IQ System* can be used to put each channel in standby to conserve energy.

If the OVER-VOLT/THERM indicator is lit for one channel, transformer thermal protection has been activated. An overvoltage condition always causes both indicators to light. If both indicators are lit, test your AC mains voltage. If it is within tolerance, you have somehow managed to activate thermal protection for both transformers (a feat that is virtually impossible).

The unit resumes normal operation as soon as the amplifier no longer detects dangerous low frequency or DC output. Although it is extremely unlikely that you will ever activate the amplifier's DC/low-frequency protection system, improper source materials like subsonic square waves can activate this system.

The amplifier's **fault protection** system will put a channel in standby mode in rare situations where heavy common-mode current is detected in the channel's output. The amplifier should never output common-mode current unless its circuitry is damaged in some way, and putting a channel in standby mode helps to prevent further damage.

The amplifier's **transformer thermal protection** circuitry is activated if the unit's transformer temperature rises to unsafe levels. Under these abnormal conditions, the amplifier will put the affected channel's transformer in standby mode. The amplifier will return to normal operation after the transformer cools to a safe temperature. (For more information, refer to Section 4.3.3.)

4.3.3 Transformer Thermal Protection

All *Macro-Tech* amplifiers have transformer thermal protection. It protects the power supplies from damage under conditions where transformer temperatures rise too high. A thermal switch embedded in each transformer removes power to the channel if there is excessive heat. The switch automatically resets when the transformer cools to a safe temperature.

As long as it is operated within rated conditions (see Section 6), it is extremely unlikely that your amplifier will ever activate transformer thermal protection. One reason is that *ODEP* keeps the amplifier working under very severe conditions. Even so, higher than rated output levels and loads with excessively low impedances can generate more heat in the transformer than in the output devices. These conditions can overheat the transformers and activate the protection system.

Macro-Tech amplifiers are designed to keep working when other amplifiers would fail. But even when the limits of a *Macro-Tech* amplifier are exceeded, it will still protect itself—and your investment—from damage.

4.3.4 Power Supply Fuses

An internal fuse protects the *Macro-Tech 5000VZ's* low-voltage power supply. The low-voltage power supply fuse will not blow unless something is wrong with the amplifier. If the low-voltage power supply fuse blows, refer the unit to a qualified technician for service.

The high-voltage power supplies are also protected by internal fuses. With rated loads and output levels, a fuse should only shut down its channel in the rare instance of a catastrophic amplifier failure. Other protection systems like *ODEP* keep the amplifier operational under most other severe conditions. A fuse can also shut down its channel if an extremely low-impedance load and high output level result in current draw that exceeds the fuse rating. Again, this should only be possible when operating *outside rated conditions*, like when the amplifier is used to drive a 1 ohm load in Stereo mode, or when the amplifier is driven with subsonic square waves. If a high-voltage power supply fuse blows, please refer the unit to a qualified technician.

4.4 Controls

The **Enable switch** is located on the front panel so you can easily turn the amplifier on and off. If you ever need to make any wiring or installation changes, don't forget to disconnect the power cord first. Please follow these steps when first turning on your amplifier:

1. Turn down the level of your audio source. For example, set your mixer's master volume to $-\infty$.
2. Turn down the Level controls of the amplifier (if they are not already down).
3. Turn on the Enable switch. The Enable indicator beside the switch should glow. During the four second turn-on delay which immediately follows, the Signal/*IOC* indicators will light brightly, the *ODEP* indicators will stay off, and the *I*_{Load}/*I*_{Limit} indicators usually stay off but may flash immediately after the switch is turned on. After the turn-on delay, all lights should indicate normal operation.
4. After the turn-on delay, turn up the level of your audio source to the maximum desired level.
5. Turn up the level controls of the amplifier until the maximum desired sound level is achieved.



DANGER: This amplifier produces enough power to drive loudspeakers to levels that can cause permanent hearing damage. Be careful when setting the maximum level.

6. Turn down the level of your audio source to its normal range.

Each of the front panel **Level controls** has 31 detents for accurately repeatable settings. To prevent tampering, the Level Control Security Kit is available (see Section 8.2). In Bridge-Mono and Parallel-Mono modes, the Channel 2 level control is bypassed.

The three-position **input sensitivity switches** are located on the back panel and are factory set to 0.775 volts for standard 1 kHz power. They may be set to 1.4 volts for standard 1 kHz power, or a voltage gain of 26 dB. When set to 26 dB gain, the input sensitivity is 5.1 volts for full output.

The **Loudspeaker Offset Integration (LOI) switches** are located on the back panel of the amplifier and are factory set to the "on" position. The LOI circuits use double integrating filters in the amplifier's feedback circuitry to protect loudspeakers in several different ways. First, they center asymmetrical audio waveforms that cause off-center woofer cone movement. Off-center cone movement increases loudspeaker heating and distortion while reducing the loudspeaker's power handling ability. Second, LOI filters unwanted DC and subsonic frequencies using a third-order Butterworth filter with a 35 Hz corner frequency. Third, LOI filters unwanted ultrasonic frequencies (RF) that can cause tweeter burnout using a second-order Bessel filter with a 50 kHz corner frequency.

IMPORTANT: The Loudspeaker Offset Integration circuitry does NOT protect loudspeakers from large transient voltages or excessive power levels for prolonged periods of time. Crown cannot be held liable for damage or personal injury that results from overdriving loudspeakers or other system components. See Section 3.3.6 for information on using fuses to protect loudspeakers.



The **compressor switches** are located on the back panel of the amplifier and are factory set to the "fast" setting. If desired, they can be switched to "slow" or "off." Because the compressors are ahead of all other input circuitry, they compress the input signals before clipping or other types of distortion can be generated.

Each compressor is driven by the channel's input overload and *IOC* error signals. If the *IOC* circuit senses that distortion in the output of the amplifier is equal to or greater than 0.05%, it generates an "error signal" that causes the *IOC* indicator on the front panel to flash brightly, and the compressor to compress the input sig-

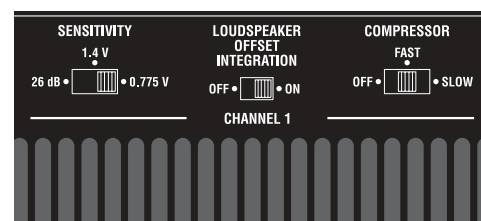

Fig. 4.3 Input Sensitivity, LOI and Compressor Switches

nal (if it is turned on). If an input signal has too much voltage, the input overload circuitry will light the IOC indicator brightly, and the compressor will compress the input signal regardless of the COMPRESSOR switch position. The OFF setting bypasses all drive sources for the compressors except for input overload.

When the COMPRESSOR switch is set to FAST, the compressors have an attack time of 4 milliseconds and a release time of 300 milliseconds. When set to SLOW, they have an attack time of 12 milliseconds and a release time of 600 milliseconds. When set to OFF, an input overload will still drive the compressor which uses the “fast” attack and release times to protect the input circuitry.

The back panel **input ground lift switch** is located on the PIP2-FXQ (see Figure 3.11). It reduces the chance of ground loops by isolating the input signal grounds from the AC ground (see Section 3.3.4). Slide the switch to the right to isolate or “lift” the grounds.

The **VZ mode switches** are located inside the amplifier behind the top dust filter on the front panel. To access these switches, remove the top filter element (see Figures 2.2 and 4.4). **Always turn the power off before changing one of these switches.** Each switch has four settings (from left to right): VZ-ODEP, Lock Low, VZ and VZ. *Note: The third and fourth positions are identical.* The amplifier is shipped from the factory with the switches set to “VZ-ODEP.” Once the top filter element is removed, the switch position label should become visible on the grille below each switch. To access the switches, reach through the grille opening with a long narrow nonconductive object like a plastic pen. The switches are about 1.75 inches (4.5 cm) behind the grille. They are easy to locate with the aid of a flash-



light. The switch for Channel 1 is located on the left side, and the switch for Channel 2 is on the right.

The VZ (Variable Impedance) mode causes the power supplies to automatically shift between high-current and low-current modes of operation as operating conditions change. Normally, the power supplies operate in the high-current (low-impedance) mode for maximum thermal efficiency. When voltage demand reaches high levels, the supplies quickly shift into high-voltage (high-impedance) mode. Because voltage and current requirements vary with the output level and frequency content of the source signals, the power supplies are designed to be able to continually switch between the two modes as needed with no degradation to the audio signal.

The VZ-ODEP mode is very similar to VZ mode. The only difference is that the power supplies are forced into high-current mode when ODEP is close to activating its limiting circuitry. This reduces excessive stress on the output transistors, and effectively increases the thermal performance of the amplifier.

Note: When ODEP limiting begins, the IOC circuitry will see that the input waveform does not match the output waveform, and an error signal is generated. If the compressors are on, they will see the error signal and compress the input signal to correct the problem. When this happens, there is no audible signal degradation. Compression is subtle, and not noticeable unless the system is driven to extremely high levels.

The Lock Low mode locks the power supplies into the high-current mode for low-impedance loads. This may be desirable when driving high-frequency transducers that must be protected from too much voltage, or when driving loads with very low impedances.

The Lock Low mode locks the power supplies into the high-current mode for low-impedance loads. This may be desirable when driving high-frequency transducers that must be protected from too much voltage, or when driving loads with very low impedances.

4.5 Filter Cleaning

Dust filters are provided on the air intakes to the cooling system (see Figure 2.1). If these filters become clogged, the unit will not cool as efficiently as it should and may produce output levels that are lower than normal due to high heat sink temperature.

To clean, remove each of the five filter elements by gently pulling them away from the front panel. Clean with mild dishwashing detergent and warm water. Replacement filters may be ordered from the factory.

Dust filters are not 100% efficient—long term this may require internal heat sink cleaning by a qualified technician. Internal cleaning information is available from our Technical Support Group.

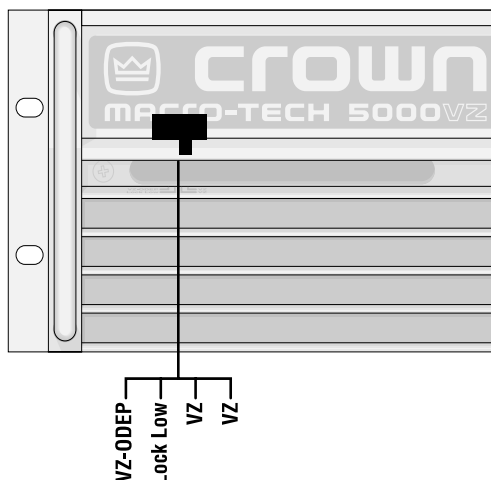

Fig. 4.4 Channel 1 VZ Mode Switch (Behind Filter)

5 Technical Information

5.1 Overview

Your *Macro-Tech* VZ amplifier incorporates several new technological advancements including low-stress output stages, real-time simulation of output transistor conditions, advanced thermal management, a modular system for signal input and processing, multispeed compressors, Loudspeaker Offset Integration, split feedback paths, modular internal construction and articulated VZ power supplies.

Custom protection circuitry limits temperature and current to safe levels while making the amplifier highly reliable and tolerant of faults. Unlike many lesser amplifiers, it can operate at its voltage and current limits without self-destructing.

Real-time computer simulation is used to create an analogue of the junction temperature of the output transistors (hereafter referred to as the “output devices”). Current is limited only when the device temperature becomes excessive—and just by the minimum amount necessary. This patented approach is called *ODEP* or Output Device Emulation Protection. It maximizes the available output power and eliminates overheating, the major cause of output device failure.

The amplifier is protected from all common hazards that plague high-power amplifiers including shorted, open, or mismatched loads; overloaded power supplies, excessive temperature, chain-destruction phenomena, input-overload damage and high-frequency blowups. The unit protects loudspeakers from DC in the input signal, output DC in the output, and turn-on/turn-off transients. The amplifier is also protected from internal faults.

The four-quadrant topology used in the grounded output stages is called the *Grounded Bridge*. The *Grounded Bridge* topology takes full advantage of the power supplies delivering peak-to-peak voltages to the load that are twice the voltage seen by the output devices and twice the voltage generated by the power supplies.

The *Grounded Bridge* topology is ground-referenced. Because the required current exceeds the limits of presently available components, composite output devices are constructed to function as gigantic NPN and PNP devices. Each output stage has two composite NPN devices and two composite PNP devices.

The devices connected to the load are referred to as “high-side NPN and PNP” and the devices connected

to ground are referred to as “low-side NPN and PNP.” Positive current is delivered to the load by increasing conductance simultaneously in the high-side NPN and low-side PNP stage, while decreasing conductance of the high-side PNP and low-side NPN synchronously.

The two channels may be used together to double the voltage (Bridge-Mono) or the current (Parallel-Mono) presented to the load. This feature gives the user flexibility in maximizing the power available to the load.

A wide-bandwidth multiloop design is used for state-of-the-art compensation. This produces ideal behavior and results in ultra-low distortion values.

Aluminum extrusions have been widely used for heat sinks in power amplifiers due to their low cost and reasonable performance. However, measured on a watts per pound or watts per volume basis, the extrusion technology doesn't perform nearly as well as the heat sink technology developed for *Macro-Tech* amplifiers.

The heat sinks for the *Macro-Tech 5000VZ* are fabricated from custom milled fin stock that provides an exceptionally high ratio of area to volume, or area to weight. All power devices are mounted directly to massive heat spreaders that are electrically at the V_{cc} potential. Electrifying the heat spreaders improves thermal performance by eliminating the insulating interface underneath the power devices. The chassis itself is even used as part of the thermal circuit to maximize utilization of the available resources.

5.2 VZ Power

VZ means Variable Impedance. It is the name of Crown's patented articulated power supply technology. This technology is what makes it possible to pack such tremendous power into Crown's VZ amplifiers.

5.2.1 Background

A power supply must be large enough to handle the maximum voltage and current necessary for the amplifier to drive its rated power into a specified load. In the process of fulfilling this requirement, conventional power supply designs produce lots of heat, are heavy, and take up precious real estate. And it's no secret that heat is one of a power amplifiers worst enemies. Consider the circuit in Figure 5.1.

According to Ohm's Law, the higher the power supply voltage, the more heat the power transistors must dis-

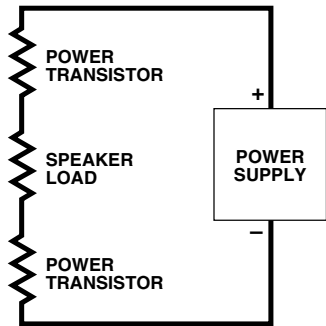

Fig. 5.1 A Typical Power Supply

Also, the lower the resistance of the power transistors, the more voltage you can deliver to the load. But at the same time that you lower the resistance of the transistors, you increase the current passing through them, and again increase the amount of heat they must dissipate.

5.2.2 The VZ Supply

An articulated power supply like Crown's VZ design can circumvent much of this problem by reducing the voltage applied to the transistors when less voltage is required. Reducing the voltage reduces the heat which makes the amplifier runs cooler. This makes it possible to safely pack more power into the chassis.

The VZ supply is divided into segments to better match the voltage and current requirements of the power transistors. Remember that audio signals like music are complex waveforms.



Fig. 5.2 Music Waveforms

For music the average level is always much less than the peak level. This means a power supply does not need to produce full voltage all the time.

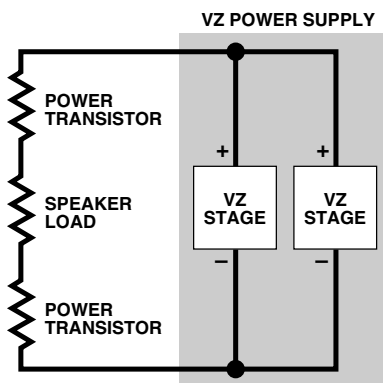

Fig. 5.3 VZ High-Current Mode

The VZ supply is divided into two parts. When the voltage requirements are not high, it operates in *high-current mode* to produce less voltage and more current.

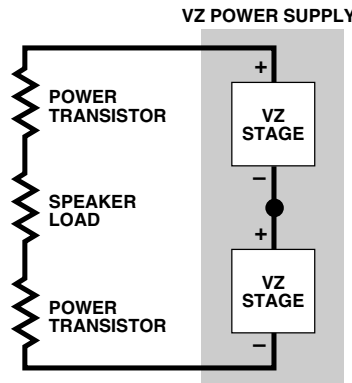

Fig. 5.4 VZ High-Voltage Mode

The power transistors stay cooler and are not forced to needlessly dissipate heat. This is the normal operating mode of the VZ power supply.

When the voltage requirements are high, a VZ supply switches into to a *high-voltage mode* to produce

higher voltage and less current. The amplified output signal never misses a beat and gets full voltage when it needs it—not when it doesn't need it.

Sensing circuitry monitors the voltage and current demands of the signal and load to determine when to switch VZ modes. The switching circuitry controls the power supplies (not the output devices) which yields the highest dynamic transfer function with no audible switching distortion—you hear only the music, not the amplifier. The VZ design gives you maximum power, maximum safety, and power optimized for your load.

5.3 Circuit Theory

Each channel is powered by its own transformer, T100 or T200. The secondary of T100 is full wave rectified by DB100 and DB101 and filtered by large computer grade capacitors (C810 and C812 for Channel 1). The transformers are protected against catastrophic failure by fuses F700 and F701 and thermally protected by internal self-resetting switches.

Both channels share T1, a low-voltage transformer. The output of T1 is rectified by diodes D709 through D714 providing an unregulated 24 volts. Monolithic regulators U715 and U716 provide the regulated ± 15 volts. T1 is protected by fuse F702.

5.3.1 Stereo Operation

For simplicity, the discussion of stereo operation will refer to one channel only. Mono operation will be discussed later.

Please refer to the block diagram in Figure 5.5 and the schematics provided at the back of this manual.

The input signal at the XLR and phone jack input connectors passes directly into the balanced input stage (U100A). When the compressor is enabled, the compressor control circuit (U101, U102 and U103) causes

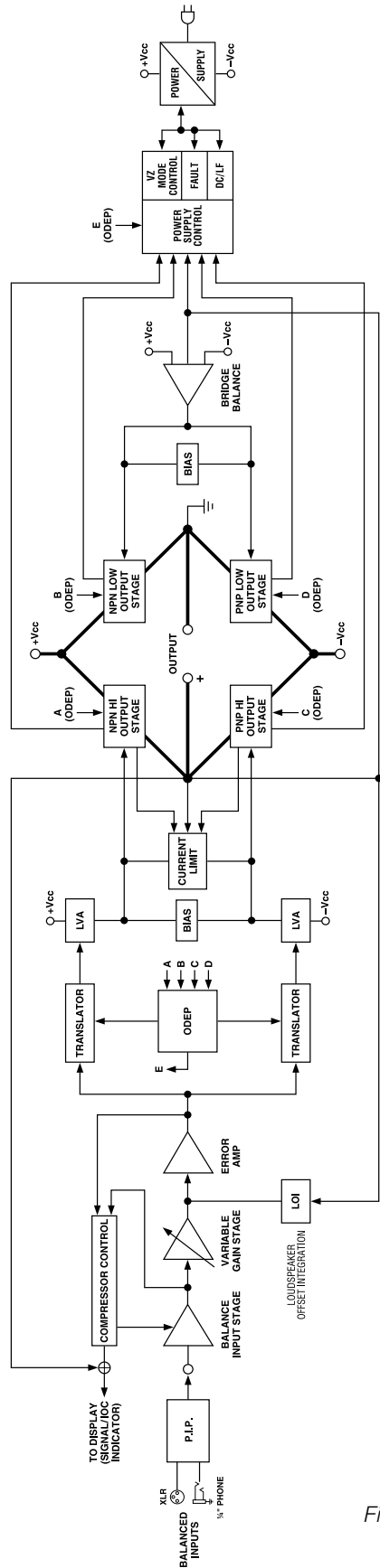

ONLY ONE CHANNEL SHOWN

Fig. 5.5 Circuit Block Diagram

a reduction in gain of the balanced input stage at the onset of clipping in the output stage. The compressor is also activated any time the first stage is about to be overdriven. The compressor control circuit also sends signals to the display module to indicate *IOC* or input overload.

The variable gain stage (U100B) sets the input sensitivity. Switch S100 is used to select 26 dB gain, 1.4 volts or 0.775 volts sensitivity for standard 1 kHz power. From there, variable resistor (R120) controls the gain.

The “error” amplifier (U105) is the heart of the unit. It is located in the main feedback loop and controls the performance of the amplifier. The error amp amplifies the difference (“error”) between the output signal and the input signal, and drives the voltage translator stage to compensate for these differences.

The output of the error amplifier is then sent to the signal translators (U106, U107, Q101, Q102, Q113 and Q114). This stage translates the ground-referenced output of the error amplifier to a V_{CC} -referenced signal to drive the last voltage amplifiers. The translators output drive is controlled by the *ODEP* circuit via Q101, Q102, Q113 and Q114.

The output of the signal translators next goes to the Last Voltage Amplifiers or LVAs (Q501, Q502, Q503, Q507, Q508 and Q509) located on the output module. The output of the LVA stage is limited by D514 through D517 so that there is maximum current to feed the predriver transistors and the slew limit capacitors (C506 and C507) yielding a constant slew rate.

The output stage consists of the predrivers (Q504 and Q510), the drivers (Q511 and Q512), and the outputs (Q513 through Q518, Q536 and Q537). These devices are configured as emitter-follower stages to supply current gain to the output of the amplifier.

The bias servos (Q533 and Q505) are thermally coupled to the heat sinks and set the quiescent current point for the output stage to lower the distortion in the crossover region of the output signal.

The bridge-balance circuit (U503) receives a signal from the output of the amplifier and differences it with the signal at the V_{CC} supplies. The bridge-balance circuit then develops a voltage to drive the bridge-balanced output stage. This results in the V_{CC} supply having exactly one half of the output voltage added to their quiescent voltage. Q529 and Q530 along with R556 set the quiescent current point for the bridge-balance output stage.

The protection mechanisms that affect the signal path are implemented to protect the amplifier under real-world conditions. These conditions are high instantaneous current, excessive temperature, and operation of the output devices outside safe conditions.

The instantaneous current limiter (Q534, Q535, Q540 and Q541) has two distinct limiting points. The current limit is nominally set to 55 amps and will switch to 32 amps when the V_{CE} voltage exceeds a predetermined level. When the output current exceeds the set limit, drive is removed from the LVA stage, thus limiting the output current to a safe level.

To further protect the output stages, a specially developed *ODEP* circuit is used (U112, U113, U114, U116 and U117). It produces an analog output proportional to the always changing safe operating area of the output transistors. This output controls the translator stage and the low-side predriver stage, removing any further drive that may exceed the safe operating area of the output stages.

Thermal sensors U500 and U501 give the *ODEP* circuits vital information on the operating temperature of the heat sink on which the output devices are mounted.

Should the amplifier fail in such a way that would result in DC (caused by excessive current or voltage) across the output terminals, the DC/low-frequency protection circuit (U109C and U109D) senses this on the negative feedback loop and shuts down the power supply and all drive to the output stage until the DC is removed. If an output device fails, the fault circuit (U115, Q105, Q106, Q108 and Q109) detects the common-mode current in the output devices and removes power from the channel until it can be repaired.

The Loudspeaker Offset Integration or LOI circuit (U104) senses the output signal and does a double integration, feeding the resultant “error” signal to the error amplifier to correct for any net DC in the output.

Additional protection is provided by the overvoltage protection circuit (U707D) which monitors the incoming line voltage and shuts down both power supplies in the case of excessive line voltage.

The VZ control circuit (U110) monitors both the V_{CC} and the output signal. When the output signal comes to within a ΔV of the V_{CC} (as determined by the output voltage and current demands), the control circuit tells the supply to switch into high-voltage mode. The supply is then latched in this mode for a minimum of 50 microseconds by U703. U711 provides protection for the FETs. The FETs (Q810, Q811 and Q812) and the

steering diodes (D810 and D811) provide the two modes of the power supply.

The VZ mode switch (S700) has four positions which control how the articulated supply functions. (Two of the four switch positions are identical because there are only three VZ modes.) In the VZ position, the supply will automatically change as needed depending on the signal demands. In the Lock Low position, the supply stays in high-current mode and cannot switch into high-voltage mode. In the “VZ-ODEP” position, the supply operates as it would in the VZ position unless the *ODEP* limit is reached. If the *ODEP* limit is reached, the supply will be locked into high-current mode to lower the thermal dissipation of the output devices until it is cool enough to return to normal VZ operation.

The fan control circuit (U713, U707B, U712 and Q706) uses the *ODEP* thermal information to control the speed of the fan. The summation of the *ODEP* signal and the heat sink temperature is used to determine its speed.

In order to reduce the turn-on current needed by the power transformers, a “soft start” circuit is provided (U701B, U701A, U111, U700 and Q701) which limits the maximum start-up current to less than 22 peak amps per channel with 120 VAC mains. The primary voltage is ramped up to the full voltage, then relay K700 closes across triac Q701 for normal operation.

5.3.2 Bridge-Mono Operation

By setting the back panel stereo/mono switch to BRIDGE MONO, the user can convert the *Macro-Tech 5000VZ* into a bridged mono amplifier. With a signal applied to the Channel 1 input and the load connected between the positive output terminals of Channel 1 and Channel 2, twice the voltage output of a single channel is achieved.

The Channel 1 output feeds the Channel 2 error amp (U205). Because there is a net inversion, the Channel 2 output is out of polarity with Channel 1. This produces twice as much voltage across the load. Each of the channel's protection mechanisms work independently and both *IOC* indicators are operational.

5.3.3 Parallel-Mono Operation

With the stereo/mono switch set to PARALLEL MONO, the output of Channel 2 is paralleled with that of Channel 1. A suitable jumper capable of handling high current must be installed to gain the benefits of this operating mode. The jumper should be connected across a positive output terminal from each channel.

The signal path for Channel 1 is the same as for stereo operation. The signal for Channel 2 is fed from the same source as for Channel 1 and is paralleled at the input to the error amplifier (U105 and U205). A signal from the current sense circuit is also sent to the Channel 2 error amplifier giving Channel 2 an electronic ballasting resistor to better match the two outputs. In Parallel-Mono mode, twice the current of one channel alone can be obtained. Each of the channel's protection mechanisms work independently if a fault occurs and both *IOC* indicators are operational.

5.3.4 Terminator Module

The terminator module provides a high-frequency load to the amplifier in order to maintain stability. It includes a current sense circuit (U750) which is used for the I_{Load}/I_{Limit} display and in the Parallel-Mono mode.

5.3.5 Display Module

On the display module there are seven indicators. The amber Enable LED shows that the low-voltage supply is enabled. The green *SPI/IOC* LED is driven by Q502 from the output signal and flashes with the output signal at normal brilliance. When the amplifier reaches early clipping, the LED driven by Q504 will flash brighter indicating an *IOC* event. The amber *ODEP* LED driven by Q500 normally lights at full brilliance and diminishes when thermal-dynamic power reserve drops. This LED will stay off if the channel is put in standby. The two-color I_{Load}/I_{Limit} LED flashes green when U500, U501 and Q505 see output current. It turns red when the amplifier's maximum current output is achieved.

6 Specifications

The following applies to units in Stereo mode with 8 ohm loads and an input sensitivity of 26 dB gain unless otherwise specified. All units have multitap transformers and can be configured for any AC line voltage.

Standard 1 kHz Power: refers to maximum average power in watts at 1 kHz with 0.1% THD.

Full Bandwidth Power: refers to maximum average power in watts from 20 Hz to 20 kHz with 0.1% THD.

Performance

Frequency Response: ± 0.1 dB from 20 Hz to 20 kHz at 1 watt (see Figure 6.3).

Phase Response: $\pm 20^\circ$ from 10 Hz to 20 kHz at 1 watt (see Figure 6.6).

Signal-to-Noise Ratio: 20 Hz to 20 kHz: Better than 100 dB below full bandwidth power. A-weighted: Better than 105 dB below full bandwidth power.

Total Harmonic Distortion (THD): Less than 0.05% at full bandwidth power from 20 Hz to 1 kHz increasing linearly to less than 0.1% at 20 kHz.

Intermodulation Distortion (IMD): (60 Hz and 7 kHz 4:1) Less than 0.05% from 411 milliwatts to full bandwidth power.

Damping Factor: Greater than 1,000 from 10 Hz to 400 Hz (see Figure 6.4).

Crosstalk: See Figure 6.7.

Slew Rate: Greater than 30 volts per microsecond.

Voltage Gain: 20:1 $\pm 3\%$ or 26 dB ± 0.25 dB at the maximum level setting. 132:1 $\pm 12\%$ or 42 dB ± 1 dB at 0.775 volt sensitivity. 71:1 $\pm 12\%$ or 37 dB ± 1 dB at 1.4 volt sensitivity. Also see Section 4.4.

Power

Output Power: See the Minimum Guaranteed Power table in Figure 6.1 for the output power specifications under a variety of conditions.

Load Impedance: Safe with all types of loads. Rated for 2 to 8 ohms in Stereo, 4 to 16 ohms in Bridge-Mono and 1 to 4 ohms in Parallel-mono mode.

Required AC Mains: 50 or 60 Hz, 100, 120, 200, 208, 230, 240 VAC ($\pm 10\%$). Draws 90 watts or less at idle. See Section 7 for additional information.

It is extremely important to have adequate AC power available to the amplifier. Power amplifiers cannot create

energy—they must have the required voltage and current to deliver the rated power you expect.

Controls

Compressor: A three-position back panel switch is used to control each channel's input compressor. The "fast" setting provides an attack time of 4 milliseconds and a release time of 300 milliseconds; the "slow" setting provides an attack time of 12 milliseconds and a release time of 600 milliseconds; the "off" setting defeats output-driven compression.

Enable: A front panel push button used to turn the amplifier on and off.

Input Ground Lift: A two-position back panel switch located on the PIP2-FXQ used to isolate the input audio signal grounds from the AC (chassis) ground.

Level: A front panel rotary potentiometer for each channel with 31 detents used to control the output level.

Loudspeaker Offset Integration: A two-position back panel switch for each channel used to turn the loudspeaker protection circuitry on and off. The circuitry protects against DC, off-center woofer cone movement, and unwanted subsonic and ultrasonic frequencies.

Sensitivity: A three-position back panel switch for each channel used to select input sensitivity: 0.775 volts or 1.4 volts for standard 1 kHz power, or a 26 dB voltage gain.

Stereo/Mono: A three-position back panel switch used to select Stereo, Bridge-Mono or Parallel-Mono mode.

VZ Mode: A four-position switch for each channel inside the front panel used to control the switching mode of the VZ power supplies.

Indicators

Enable: This amber front panel indicator shows the on/off status of the low-voltage power supply.

Signal/IOC: Each channel has a green front panel indicator that flashes to show amplifier output. If a channel's output waveform differs from its input by 0.05% or more, the indicator flashes brightly to show distortion. This function provides *proof of distortion-free performance*.

ODEP: Each channel has an amber front panel indicator that shows thermal-dynamic energy reserve. Normally, each ODEP indicator is lit to show available

reserve energy. In the rare event that a channel has no reserve, its indicator will dim in proportion to *ODEP* limiting. An *ODEP* indicator may also turn off under other conditions (see Section 4.2).

I_{Load}/I_{Limit}: Each channel has a two-color (green/red) indicator that shows load current and limit current. They glow green to indicate load current flowing out the amplifier, and they turn red when maximum current is being delivered to the load.

Input/Output

Input Connectors: Balanced three-pin XLR connectors and balanced phone jacks are provided on the factory-installed PIP2-FXQ (see Section 8.1 for optional *PIP* modules).

Input Impedance: Greater than 10 K ohms, balanced. Greater than 5 K ohms, unbalanced.

Input Sensitivity: Settings include 0.775 volts or 1.4 volts for standard 1 kHz power, or a 26 dB voltage gain (see Section 4.4 for more information).

Output Connectors: A multifunction, high-current output block is provided. Crown output blocks include three pairs of connectors for each channel (a total of 12 connectors). This allows multiple loudspeakers to be easily connected to each channel. High current screw terminals and banana jacks are provided which accept spade lugs, banana plugs or bare wire.

Output Impedance: Less than 10 milliohms in series with less than 2.5 microhenries (see Figure 6.5).

DC Output Offset: ± 10 millivolts.

Output Signal

Stereo: Unbalanced, two-channel.

Bridge-Mono: Balanced, single-channel. Channel 1 controls are active; Channel 2 controls are removed from operation.

Parallel-Mono: Unbalanced, single-channel. Channel 1 controls are active; Channel 2 controls are removed from operation.

Protection

Macro-Tech amplifiers are protected against shorted, open or mismatched loads; overloaded power supplies; excessive temperature, chain destruction phenomena, input overload damage and high-frequency blowups. They also protect loudspeakers from input/output DC and turn-on/turn-off transients.

If unreasonable operating conditions occur, the patented *ODEP* circuitry will proportionally limit the drive level to protect the output transistor stages, particularly in the case of elevated temperature. Transformer overheating will result in a temporary shutdown of the affected channel; when it has cooled to a safe temperature, the transformer will automatically reset itself. Controlled slew rate voltage amplifiers protect against RF burnouts. And input overload protection is provided by the input compressors and current-limiting resistance at the input.

Turn On: The four second turn-on delay prevents dangerous turn-on transients. (Contact Crown's Technical Support Group to change the delay time.) It also has "soft start" to avoid tripping the AC circuit breaker by gradually bringing the supplies up to full voltage.

Construction

Steel chassis with durable black finish, aluminum front panel with Lexan overlay, and specially designed flow-through ventilation from front to back panels.

Cooling: Internal heat sinks with on-demand, proportional forced-air cooling controlled by *ODEP*. Includes custom heat diffusers and patented circuitry to promote uniform dissipation.

Dimensions: 19 inch (48.3 cm) standard rack mount width (EIA RS-310-B), 5.25 inch (13.3 cm) height, 15.875 inch (40.3 cm) depth behind mounting surface, and 2.875 inches (7.3 cm) in front of mounting surface. Allow 3 inches (7.6 cm) behind the back panel for adequate air flow (see Figures 3.1 and 3.2).

Approximate Weight: 77 pounds, 9 ounces (35.2 kg) net; 88 pounds, 10 ounces (40.2 kg) shipping weight.



Crown specifications are guaranteed for three years.

In an effort to provide you with as much information as possible about the high power-producing capabilities of your amplifier, we have created the following power matrices.

Minimum Guaranteed Power Specifications

Crown’s minimum power specifications represent the absolute smallest amount of output power you can expect from your amplifier when it is driven to full output under the given conditions. Some spaces in each matrix may be left blank because the same guarantee is not provided for those conditions—however, your amplifier will perform well under all conditions listed in each matrix.

When measuring power, 0.1% THD appears to be the industry standard for distortion. Two of the maximum average power specifications shown in each minimum power matrix are measured at 0.1% THD so you can easily compare Crown specifications to those of other manufacturers. But this high level of distortion actually allows for some clipping which is undesirable. Because of this, a maximum average power specification at 0.05% THD is included in each minimum power matrix which represents non-clipped conditions. Although most manufacturers do not give you power specifications at 0.05% THD, we encourage them to provide these specifications so you will have a more realistic representation of the way amplifiers should be used in the real world—without a clipped output signal.

Macro-Tech 5000VZ – Minimum Guaranteed Power (Watts)							
AC Mains	Stereo-Mono Mode	Load (Ohms)	Maximum Average			FTC Continuous Average	
			At 0.1% THD (See note 1)	At 0.1% THD (See note 2)	At 0.05% THD (See note 3)	At 0.1% THD (See note 4)	
			1 kHz	20Hz-20kHz	1 kHz	1 kHz	20Hz-20kHz
120 VAC, 60 Hz	Stereo (both channels driven)	2	2500	2155	2325		
		4	2000	1775	1995	1865	
		8	1300	1090	1295	1295	1030
	Bridge-Mono (balanced output)	4	5000		4875		
		8	4000	3670	3970	3790	
		16	2600	1875	2550	2570	2035
	Parallel-Mono	1	5000		4945		
		2	3700		3700	3790	
		4	2600		2570	2580	
100 VAC, 50 Hz	Stereo (both channels driven)	2	2375		2340		
		4	1865	1740	1835	1770	
		8	1250	1065	1235	1230	1015
	Bridge-Mono (balanced output)	4	4725		4670		
		8	3700	3355	3650	3635	
		16	2490	2120	2425	2455	2015
	Parallel-Mono	1	4695		4630		
		2	3730		3675	3470	
		4	2490		2465	2455	
230 VAC, 50 Hz	Stereo (both channels driven)	2	2525		2430		
		4	1985	1760	1965		
		8	1310	1070	1285	1240	1015
	Bridge-Mono (balanced output)	4	5070		5025		
		8	3935	3525	3910		
		16	2645	2150	2600	2605	1985
	Parallel-Mono	1	5085		5025		
		2	3960		3920		
		4	2635		2615	2605	

Fig. 6.1 Minimum Power Matrix

Many manufacturers publish power specs with a tolerance of ±1 dB or worse. This means their amplifier can deviate more than 20% in output! A 100 watt amplifier would meet their specification if it only produced 79.4 watts. Other manufacturers qualify their specs by saying they are “typical,” “subject to manufacturing tolerances,” “single channel driven” or that they are specified with “fuses bypassed.” Each of these statements effectively removes any performance guarantee. In fact, some manufacturers use these tactics to generate large power numbers, and they don’t even print a disclaimer. We take a different approach at Crown—our amplifiers are *guaranteed* to meet or exceed their specifications for three years. Further, because our published specs are set below our “in-house” measurements, you can expect every Crown amplifier to exceed its published minimum power specs. We believe you should get what you pay for.

Minimum Power Notes:

All minimum power specifications are based on 0.1% regulated AC mains and an ambient room temperature of 70° F (21° C). Standard EIA power (RS-490) is not identified here because it is identical to FTC Continuous Average Power.

1. A 1 kHz sine wave is presented to the amplifier and the output monitored for nonlinear distortion. The level is increased until THD reaches 0.1%. At this point, average power per channel is reported.
2. A sine wave is presented to the amplifier over the range from 20 Hz to 20 kHz and the output monitored for nonlinear distortion. The level at each frequency is increased until THD reaches 0.1%. At this point, average power per channel is reported.
3. A 1 kHz sine wave is presented to the amplifier and the output monitored for nonlinear distortion. The level is increased until THD reaches 0.05%. At this point, average power per channel is reported.
4. Continuous power in the context of Federal Trade Commission testing is understood to be a minimum of five minutes of operation. Harmonic distortion is measured as the RMS sum total and given as a percentage of the fundamental output voltage. This applies for all wattages greater than 0.25 watts.

Maximum Power Specifications

Crown's maximum power specifications represent the largest amount of output power you can expect from your amplifier when it is driven to full output under the given conditions. These specifications can be used to prevent loudspeaker and hearing damage.

The maximum power matrices include specifications for single cycle and 40 millisecond burst sine waves. Burst signals act like large transient peaks that are present in common source signals. Loudspeakers can respond to a single cycle burst, so the single cycle burst specifications should be used to help you protect your loudspeakers. In contrast, a 40 millisecond burst represents the typical response time of the human ear. Your ear will not respond to the entire dynamic change of a burst that lasts less than 40 milliseconds.

The burst power specifications are provided at 0.05% THD which is a practical low distortion condition. Operating the amplifier at levels higher than 0.05% THD can result in output power levels that are higher than those listed in the maximum power matrices.

Macro-Tech 5000VZ – Maximum Power (Watts)										
AC Mains	Stereo-Mono Mode	Load (Ohms)	Single Cycle Tone Burst At less than 0.05% THD (See note 1)				40 Millisecond Tone Burst At 0.05% THD (See note 2)			
			20 Hz	50 Hz	1 kHz	7 kHz	50 Hz	1 kHz	7 kHz	
			120 VAC, 60 Hz	Stereo (both channels driven)	2	2285	3070	3195	2460	2825
4	1820	2310			3220	1530	2100	1940	1510	
8	1305	1440			1760		1330	1270	870	
Bridge-Mono (balanced output)	4	4905		6400	6605	4815	5750	5320	4815	
	8	4280		5035	6780	3135	4455	4070	3100	
	16	2770		3000	3695		2770	2670	1815	
Parallel-Mono	1	4910		6765	6925	4550	5925	5285	4505	
	2	3885		5005	6740	2975	4425	4045	2975	
	4	2720		3025	3660		2770	2670	1795	
100 VAC, 50 Hz	Stereo (both channels driven)	2		2305	3040	3085	2060	2870	2415	2040
		4		1835	2380	3305	1280	2080	1895	1280
		8		1245	1470	1800		1340	1265	740
	Bridge-Mono (balanced output)	4	4635	6030	6125	3985	5935	4845	3945	
		8	3685	4820	6670	2540	4255	3805	2540	
		16	2495	2940	3620		2740	2545	1485	
	Parallel-Mono	1	4600	6300	6455	4090	5705	4865	4050	
		2	3660	4785	6615	2560	4310	3820	2560	
		4	2490	2990	3595		2685	2565	1515	
230 VAC, 50 Hz	Stereo (both channels driven)	2	2350	2930	3000	2125	2905	2545	2125	
		4	1845	2380	3205	1300	2210	1925	1300	
		8	1235	1425	1740		1365	1270	740	
	Bridge-Mono (balanced output)	4	4995	6060	6155	4155	6060	5310	4155	
		8	3900	5065	6695	2615	4615	4060	2615	
		16	2590	2995	3655		2865	2665	1535	
	Parallel-Mono	1	4865	6250	6450	4345	6145	5275	4305	
		2	3865	4930	6635	2690	4485	4025	2690	
		4	2570	3025	3630		2795	2670	1560	

Maximum Power Notes:

All maximum power specifications are based on 0.1% regulated AC mains and an ambient room temperature of 70° F (21° C). Although it is an unusual condition, your amplifier can function well with AC mains voltages up to 10% over the specified line voltage. With overvoltage conditions, your amplifier may be capable of delivering instantaneous power levels up to 20% greater than the specifications in the matrix.

1. A single cycle sine wave is presented to the amplifier and monitored for nonlinear distortion. The average power during the burst is reported. Loudspeakers must be able to withstand this level if they are to be safely used with this amplifier.
2. A 40 millisecond sine wave burst (10 percent duty cycle) is presented to the amplifier and monitored for nonlinear distortion. The average power during the burst is reported. This power level is a measurement of the amplifier's maximum transient power that can be perceived by the human ear.

Fig. 6.2 Maximum Power Matrix

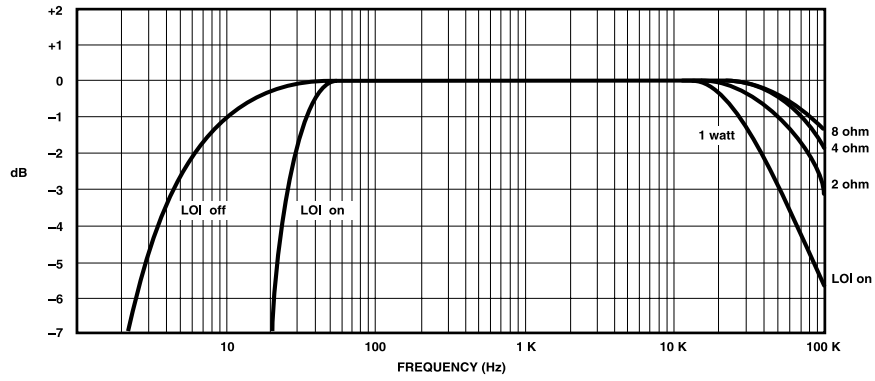

Fig. 6.3 Typical Frequency Response

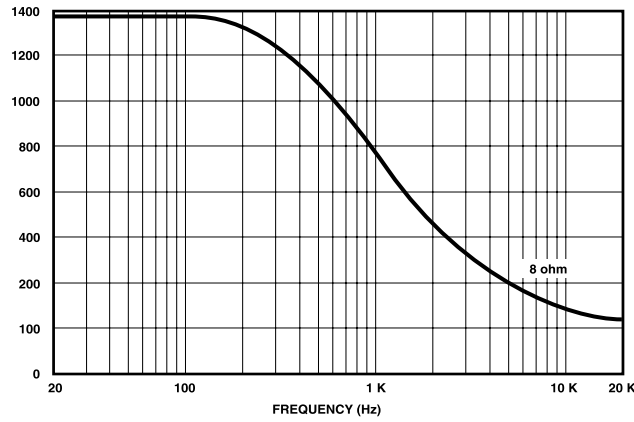

Fig. 6.4 Typical Damping Factor

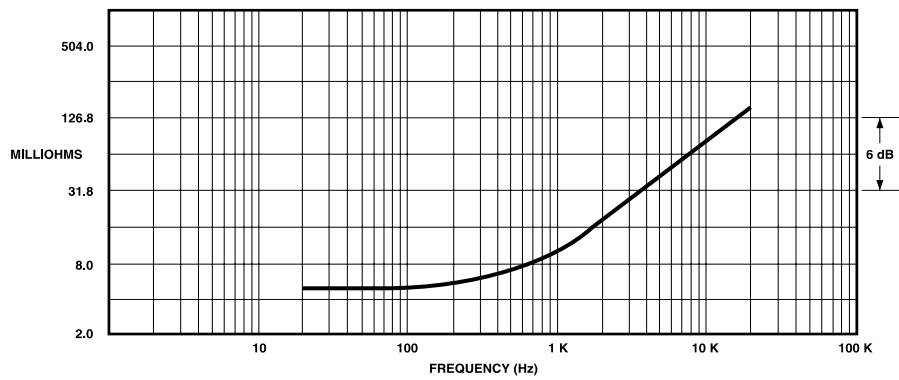

Fig. 6.5 Typical Output Impedance

TEF[®]
Measurement

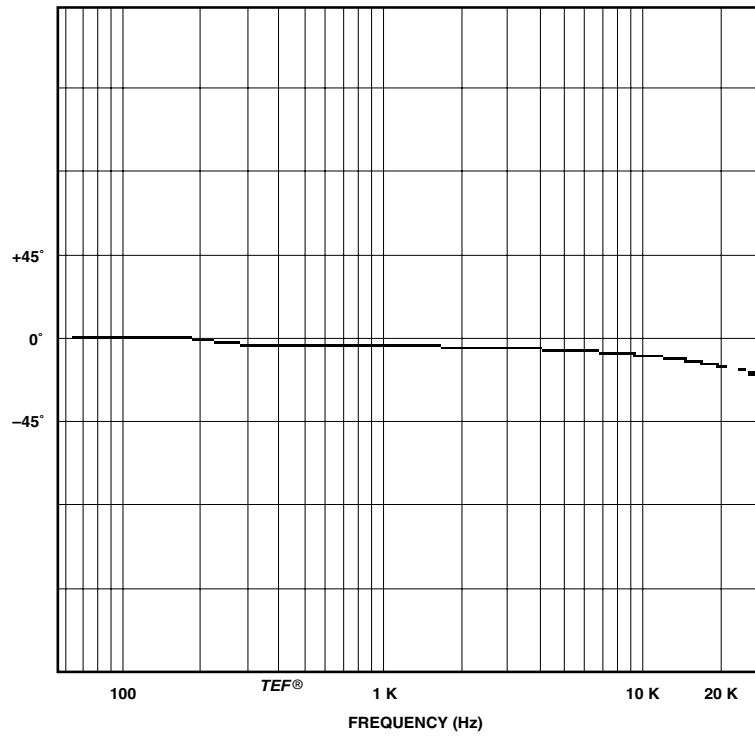

Fig. 6.6 Typical Phase Response

TEF[®]
Measurement

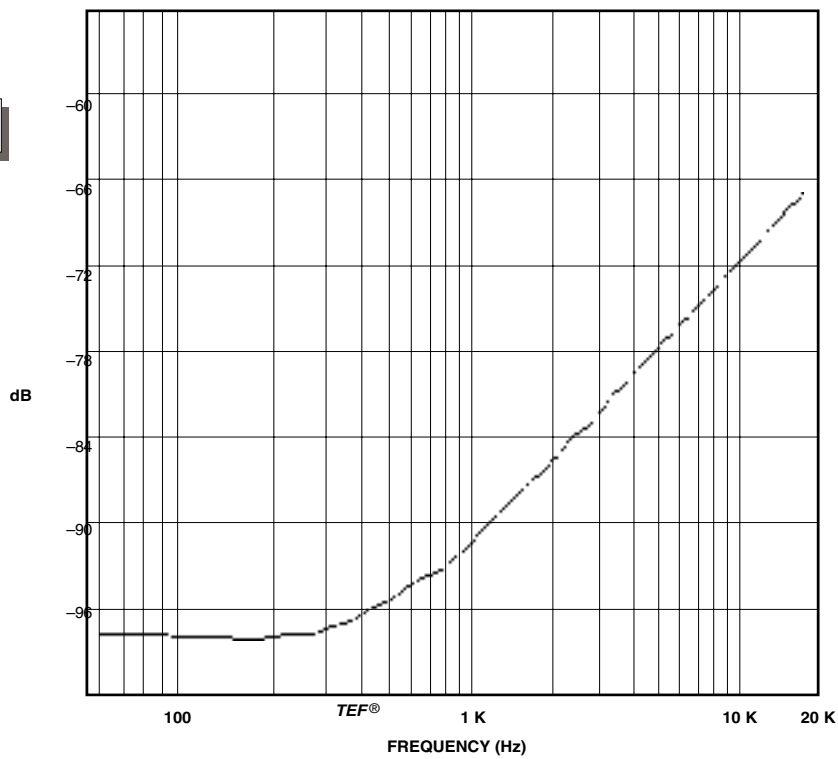

Fig. 6.7 Typical Crosstalk



7 AC Power Draw and Thermal Dissipation

This section provides detailed information about the amount of power and current drawn from the AC power line by the *Macro-Tech 5000VZ*, and the amount of heat produced under various conditions. The calculations presented here are intended to provide a realistic and reliable depiction of the amplifier. The following assumptions were made:

- The amplifier's available channels are loaded, and full, standard 1 kHz power is being delivered.
- Quiescent power draw is 90 watts (an almost negligible amount for full-power calculations).
- Quiescent heat dissipation equals 105 btu/hr at 90 watts.
- Duty cycle of pink noise is 50%.
- Duty cycle of highly compressed rock 'n' roll midrange is 40%.
- Duty cycle of rock 'n' roll is 30%.
- Duty cycle of background music is 20%.
- Duty cycle of continuous speech is 10%.
- Duty cycle of infrequent, short-duration paging is 1%.

Here are the equations used to calculate the data presented in Figure 7.1:

$$\text{AC Mains Power Draw (watts)} = \frac{\text{Total output power with all channels driven (watts)} \times \text{Duty Cycle}}{\text{Amplifier Efficiency}} + \text{Quiescent Power Draw (watts)}$$

The quiescent power draw of 90 watts is typical, and assumes the cooling fans are not running.

$$\text{Thermal Dissipation (btu/hr)} = \left[(1 - \text{Power to Load}) + \frac{\text{Quiescent Power Draw (watts)}}{\text{Amplifier Efficiency}} \right] \times 3.415$$

OR

$$\text{Thermal Dissipation (btu/hr)} = \left(\frac{\text{Total output power with all channels driven (watts)} \times \text{Duty Cycle} \times \text{Amplifier Inefficiency}}{\text{Amplifier Efficiency}} + \text{Quiescent Power Draw (watts)} \right) \times 3.415$$

The constant 3.415 converts watts to btu/hr. Thermal dissipation in btu is divided by the constant 3.968 to get kcal.

To convert the power draw in watts to current draw in amperes, use the following equation:

$$\text{Current Draw (amperes)} = \frac{\text{AC Mains Power Draw (watts)}}{\text{AC Mains Voltage} \times \text{Power Factor (.83)}}$$

The current draw values shown in Figure 7.1 depend on the AC mains voltage (power draw and thermal dissipation are typical for any AC power voltage).

Macro-Tech 5000VZ

Duty Cycle	L O A D														
	8 Ohm Stereo / 4 Ohm Parallel-Mono					4 Ohm Stereo / 8 Ohm Bridge-Mono / 2 Ohm Parallel-Mono					2 Ohm Stereo / 4 Ohm Bridge-Mono / 1 Ohm Parallel-Mono				
	AC Mains Power Draw (Watts)	Current Draw (Amps)		Thermal Dissipation		AC Mains Power Draw (Watts)	Current Draw (Amps)		Thermal Dissipation		AC Mains Power Draw (Watts)	Current Draw (Amps)		Thermal Dissipation	
	100-120 V	220-240 V	btu/hr	kcal/hr		100-120 V	220-240 V	btu/hr	kcal/hr		100-120 V	220-240 V	btu/hr	kcal/hr	
50%	1,715	20.7	9.4	1,420	360	2,590	31.2	14.2	2,015	510	3,215	38.7	17.6	2,440	615
40%	1,390	16.7	7.6	1,195	300	2,090	25.2	11.4	1,675	420	2,590	31.2	14.2	2,015	510
30%	1,065	12.8	5.8	975	245	1,590	19.2	8.7	1,330	335	1,965	23.7	10.8	1,590	400
20%	740	8.9	4.1	750	190	1,090	13.1	6.0	990	250	1,340	16.1	7.3	1,160	295
10%	415	5.0	2.3	530	135	590	7.1	3.2	650	165	715	8.6	3.9	735	185

Fig. 7.1 Power Draw, Current Draw and Thermal Dissipation at Various Duty Cycles

8 Accessories

8.1 PIP Modules

One advantage of *Macro-Tech* amplifiers is the ability to customize them using *PIP* (Programmable Input Processor) and *PIP2* modules. The *MA-5000VZ* amplifier is equipped with ribbon cables that will connect either directly, or via the *PIP2* adapter to a *PIP* module. The modules install easily.

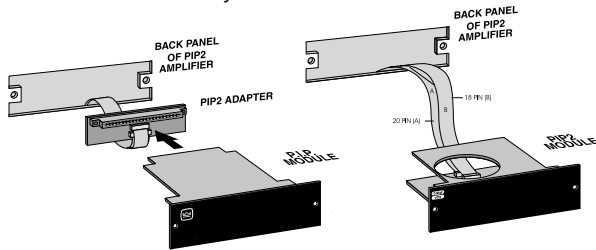
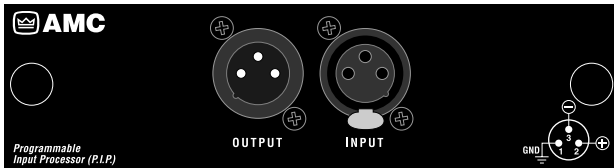

Fig. 8.1 Installing a *PIP* or *PIP2* Module

WARNING: Disconnect power to the amplifier when installing or removing a *PIP* module.

PIPs carrying the *PIP2* logo are configured to use one or more of the *PIP2* enhanced features. These features are only available in a *PIP2*-compatible amplifier. Of course, the exact features used will depend upon the function of the *PIP2* module. Here are some of the available *PIP* and *PIP2* modules:



P.I.P.-AMCb unites many features of the *P.I.P.-XOV* and *P.I.P.-CLP*. It offers a variable 4th-order Linkwitz-Riley crossover and an *IOC*-driven, variable threshold compressor. In addition, it provides “constant-directivity” horn equalization and filter-assisted B_6 vented box equalization. Biamping and triamping capabilities are provided via *XLR* connectors.

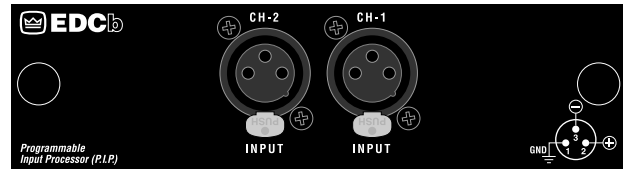

P.I.P.-EDCb combines a sophisticated error-driven compressor and smooth limiter with a maximum level setting and a subsonic filter for each channel. The compressors have adjustable attack and release times, and can be set to track each other. The compressors activate when a signal would otherwise clip the input, an *IOC* error occurs, or the output exceeds the selected threshold. The subsonic filters have corner frequencies of 24, 28, 32 and 36 Hz.

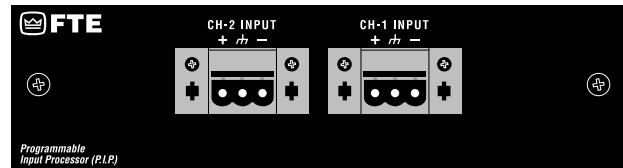

P.I.P.-FTE uses balanced 1:1 transformers to isolate the amplifier from the input signal. It also includes 12 dB/octave RFI filters, 18 dB/octave high pass filters, and 6 dB/octave 3 kHz shelving networks for “constant-directivity” horn equalization. Screw terminal plugs are provided for input.

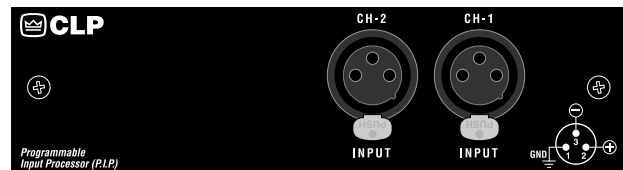

P.I.P.-CLP detects and prevents overload. Its compressor is driven by the amplifier’s built-in *IOC* error detection circuitry. Unlike typical signal-driven compressors, it only compresses the signal to prevent overload. It can deliver up to 13 dB of additional headroom without being noticeable.

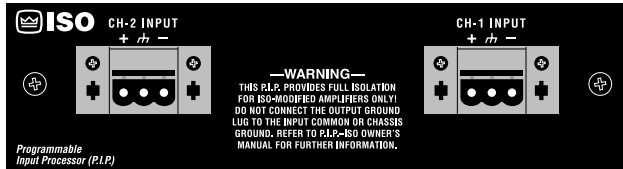

P.I.P.-ISO is designed especially for 25 to 140 volt distributed systems where UL®-listed isolation is required. Installation requires minor amplifier modifications. With the P.I.P.-ISO installed, the amplifier outputs are safely isolated from the input terminals and the chassis.

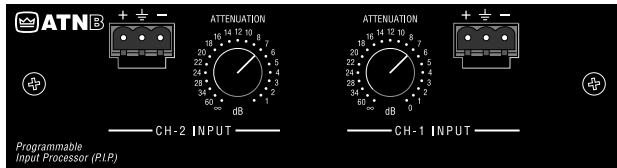

P.I.P.-ATNB uses balanced 1:1 transformers to isolate the amplifier from the input signal. It also includes 12 dB/octave RFI filters, variable 18 dB/octave high-pass filters, and 6 dB/octave 3 kHz shelving networks for “constant-directivity” horn equalization. The module also includes a calibrated 21-step precision attenuator for each channel. Screw terminal plugs are provided for input.

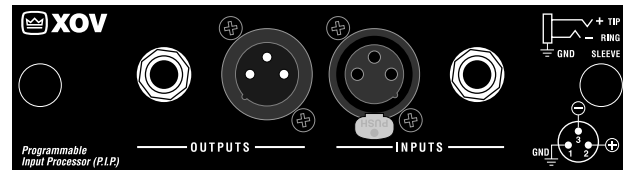

P.I.P.-XOV is a versatile 18 dB/octave mono crossover/filter with blamping and triamping capabilities

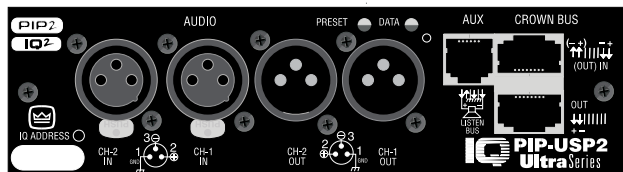

IQ-PIP-USP2 is an IQ2-series component. This means it supports Crown’s UCODE protocol and requires an IQ System with an IQ2-compatible IQ interface. UCODE (universal code) enables users and third parties to develop custom software objects to control and monitor IQ2-compatible components like the IQ-PIP-USP2.

For more information on these or other PIPs under development, contact your local dealer or Crown’s Technical Support Group.

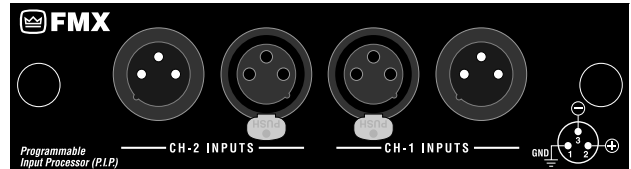

P.I.P.-FMX facilitates “daisy-chaining” balanced amplifier inputs. Female to male three-pin XLR connectors are used to passively bridge the inputs.

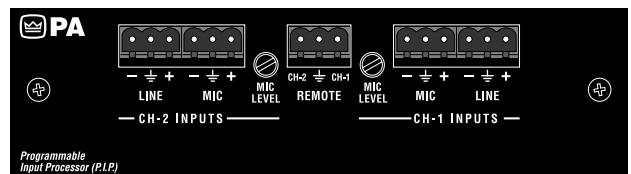

P.I.P.-PA adds a switchable balanced low-impedance mic input, a balanced line-level input and a compressor to each channel. Remote switching circuitry provides quick and quiet fades from mic to line and back.



P.I.P.-BEQ is a two-channel module providing equalization for BOSE® loudspeakers. For example, the P.I.P.-BEQ can be used in place of a BOSE 102 controller. Screw terminal plugs provide balanced connections. Each input channel has an output from the PIP that can be independently configured for output with no processing, loudspeaker equalization or loudspeaker equalization with bass-cut.

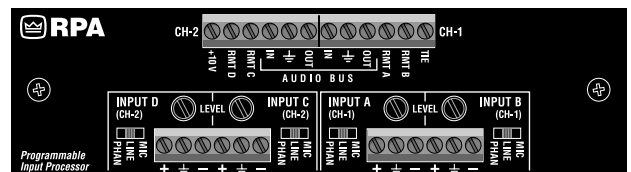

P.I.P.-RPA adds the features of a 4x2 mixer to your amplifier. Its four inputs accept mic- or line-level input. It offers priority switching (“voice-over”) of each input and remote level control with the RPA-RMT. Other features include bus inputs and outputs, adjustable input sensitivity, phantom power and RFI suppression. Input isolation transformers are optional.

8.2 Level Control Shaft Lock

A security accessory, the shaft lock can be used to secure your amplifier's level controls in situations where the front panel controls are subject to tampering. One is needed for each channel. They can be ordered

through the Crown Service/Parts Department. For more information, contact the Crown Service Department.

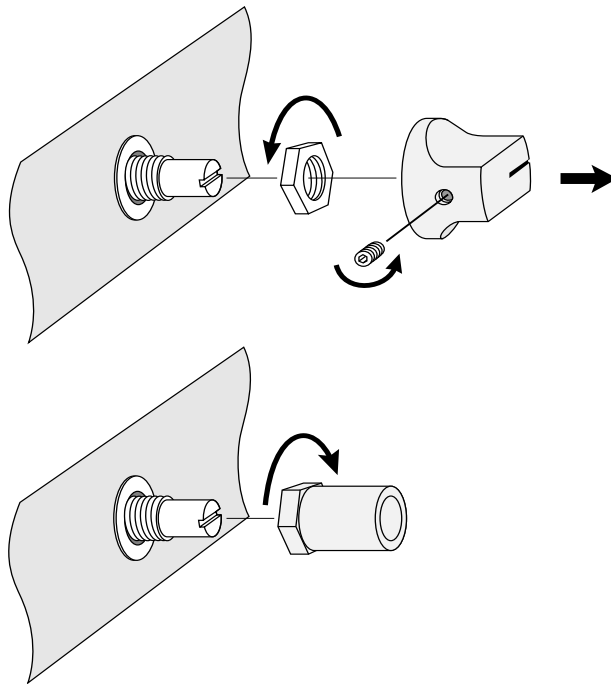

Fig. 8.2 Installing a Level Control Shaft Lock

9 Service

This unit has very sophisticated circuitry which should only be serviced by a fully trained technician. This is one reason why each unit bears the following label:



CAUTION: To prevent electric shock, do not remove covers. No user serviceable parts inside. Refer servicing to a qualified technician.

9.1 Worldwide Service

Service may be obtained from an authorized service center. (Contact your local Crown/Amcron representative or our office for a list of authorized service centers.) To obtain service, simply present the bill of sale as proof of purchase along with the defective unit to an authorized service center. They will handle the necessary paperwork and repair.

Remember to transport your unit in the original factory pack.

9.2 North American Service

Service may be obtained in one of two ways: from an authorized service center or from the factory. You may choose either. It is important that you have your copy of the bill of sale as your proof of purchase.

9.2.1 Service at a North American Service Center

This method usually saves the most time and effort. Simply present your bill of sale along with the defective unit to an authorized service center to obtain service. They will handle the necessary paperwork and repair. Remember to transport the unit in the original factory pack. A list of authorized service centers in your area can be obtained from our Technical Support Group.

9.2.2 Factory Service

To obtain factory service, fill out the **service information page** found in the back of this manual and send it along with your proof of purchase and the defective unit to the Crown factory.

For warranty service, we will pay for ground shipping both ways in the United States. Contact Crown Factory Service or Technical Support to obtain prepaid shipping labels prior to sending the unit. Or, if you prefer, you may prepay the cost of shipping, and Crown will reimburse you. Send copies of the shipping receipts to Crown to receive reimbursement.

Your repaired unit will be returned via UPS ground. Please contact us if other arrangements are required.

Factory Service Shipping Instructions:

1. When sending a Crown product to the factory for service, be sure to fill out the service information form that follows and enclose it inside your unit's shipping pack. Do not send the service information form separately.

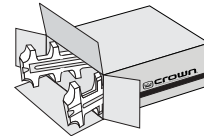

Always use the original factory pack to transport the unit.

2. To ensure the safe transportation of your unit to the factory, ship it in an original factory packing container. If you don't have one, call or write Crown's Parts Department. With the exception of polyurethane or wooden crates, any other packing material will not be sufficient to withstand the stress of shipping. **Do not use loose, small size packing materials.**
3. Do not ship the unit in any kind of cabinet (wood or metal). Ignoring this warning may result in extensive damage to the unit and the cabinet. Accessories are not needed—do not send the instruction manual, cables and other hardware.

If you have any questions, please call or write the Crown Technical Support Group.

Crown International

Technical Support / Factory Service
1718 W. Mishawaka Rd., Elkhart, Indiana 46517
U.S.A.

Telephone: 574-294-8200
800-342-6939 (North America,
Puerto Rico, and Virgin Islands only)

Facsimile: 574-294-8301 (Technical Support)
574-294-8124 (Factory Service)

Fax Back: 574-293-9200 (North America only)
800-294-4094 (North America only)
574-294-8100 (International)

Internet: <http://www.crownaudio.com>

Crown Factory Service Information

Shipping Address: Crown Factory Service, 1718 W. Mishawaka Rd., Elkhart, IN 46517

Phone: 1-800-342-6939 or 1-574-294-8200 Fax: 1-574-294-8301

Owner's Name: _____

Shipping Address: _____

Phone Number: _____ Fax Number: _____

Model: _____ Serial Number: _____ Purchase Date: _____

NATURE OF PROBLEM

(Be sure to describe the conditions that existed when the problem occurred and what attempts were made to correct it.)

Other equipment in your system: _____

If warranty has expired, payment will be: Cash/Check VISA MasterCard C.O.D.

Card Number: _____ Exp. Date: _____

Signature: _____

ENCLOSE THIS PORTION WITH THE UNIT. DO NOT MAIL SEPARATELY.

Detach and send with unit.