

I N S T R U C T I O N   M A N U A L

M O D E L   6   7   0  
S T E R E O   L I M I T E R

Serial No. \_\_\_\_\_

Fairchild Recording Equipment Corporation  
10-40 45th Avenue  
Long Island City 1, New York

December 1959  
(Supersedes all previous issues)

## FAIRCHILD STEREO LIMITER - MODEL 670

### OUTSTANDING FEATURES

#### FIRST MODERN LIMITER

A radical departure from the classical limiter design in the MODEL 670 is characterized by the complete absence of audible thumps, absence of distortion and noise, and it is extremely stable over long periods of time.

#### 4 UNITS IN ONE

The MODEL 670 is either 2 Independent Limiters, or by the flick of a switch a Vertical-Lateral Component Limiter--all this enclosed within 14 inches of rack space.

#### INDEPENDENT CONTROL OF BOTH VERTICAL AND LATERAL AMPLITUDES ON STEREO DISKS

Large vertical amplitudes on STEREO DISKS often produce processing as well as tracking problems. Large vertical amplitudes are produced by random coincidence of out-of-phase components in the two STEREO channels. The MODEL 670 is the only unit presently in production which can control both components (vertical and lateral) independently, and accomplish this with minimum loss of separation.

#### EXTREMELY FAST ATTACK TIME

Many a short transient can pass through conventional limiters because of their slowness in attack. The MODEL 670 can produce full limiting effect during the first 10,000ths of a second.

#### VARIABLE RELEASE TIME

Different program materials require different limiting action. By choosing the correct release time characteristic, even severe limiting can be made to be practically imperceptible. The MODEL 670 supplies six different timing curves, several of them making the release time an automatic function of the amount of limiting used.

#### LIMITER OR COMPRESSOR

The type of program material as well as personal preference dictate the use of either a limiter or a compressor. The MODEL 670 can be adjusted to work either as a compressor, with a ratio of 2 to 1 and a threshold of 5 db below normal program level; or as a peak limiter, with a compression ratio of 30 to 1 and a threshold of 10 db above normal program level; or it can be adjusted to operate anywhere in-between these two extremes.

#### RELIABILITY

Highest grade commercial and military components are used throughout working well below their maximum ratings to insure long, trouble-free operation.

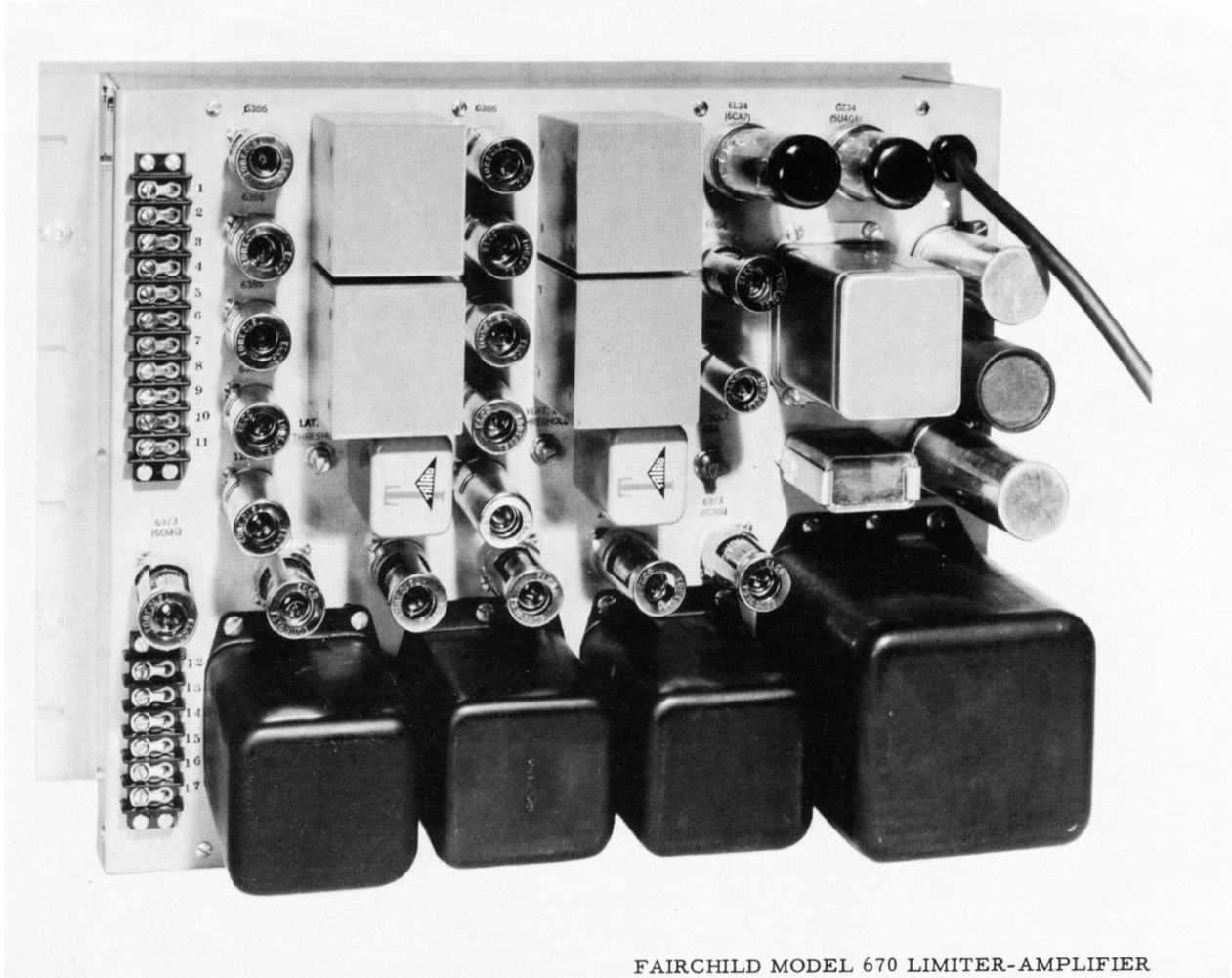
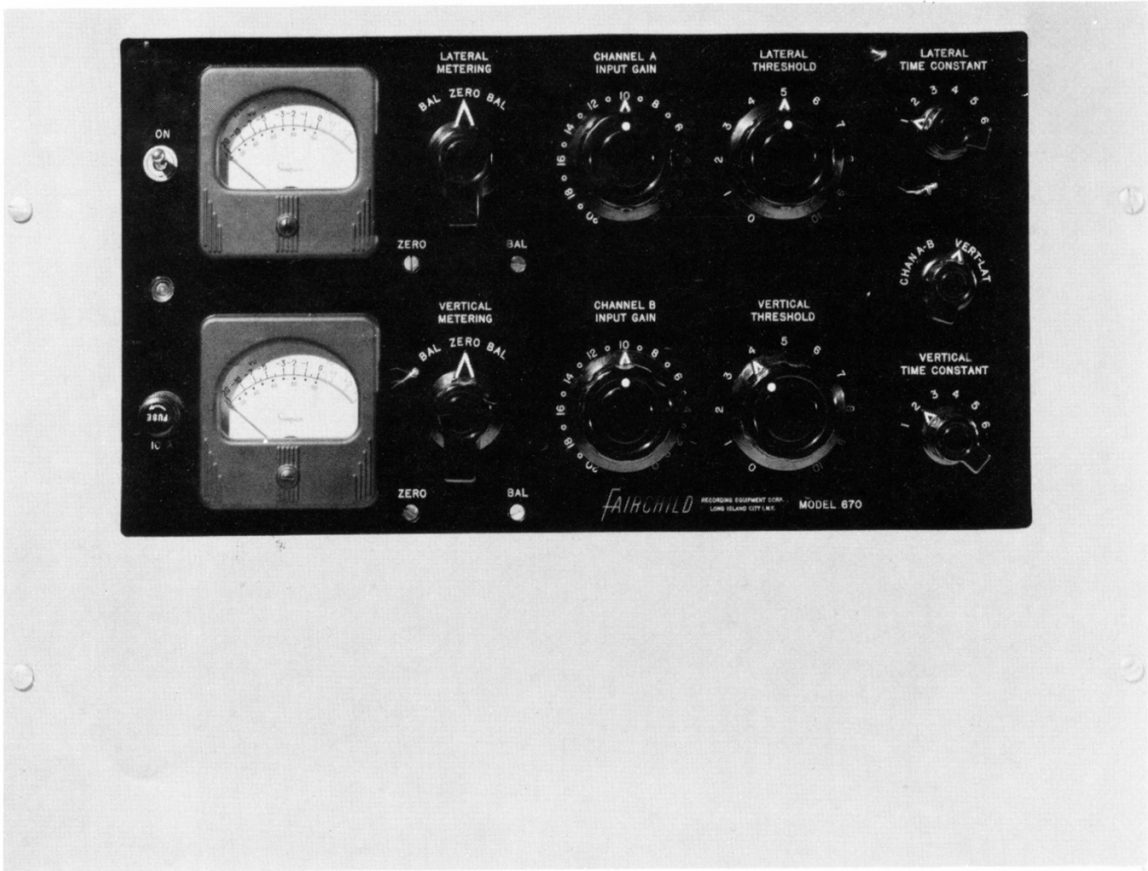

FAIRCHILD MODEL 670 LIMITER-AMPLIFIER  
TWO-CHANNEL FOR STEREO

## MODEL 670 STEREO LIMITER

### GENERAL DESCRIPTION

The FAIRCHILD MODEL 670 incorporates on one chassis two independent limiters which can limit either two independent signals, such as the left and right channels of a stereo signal, or the vertical and lateral components of same. The latter is accomplished by first bringing the two stereo channels through a matrixing network, dividing them into their vertical and lateral components, limiting them independently, and recombining them through a second matrixing network into left and right channels.

Each half of the MODEL 670 uses only a single push-pull stage of audio amplification and an extremely high control voltage, with the result that the Automatic Gain-Controlled Amplifier never produces any audible or observable thumps. Contrary to most limiting amplifiers heretofore available, this unit has extremely low distortion and noise under all conditions, both as a straight-through amplifier and under maximum limiting conditions.

The attack time of the unit is made extremely fast in order to catch short transients, and the release time is made adjustable from 0.3 seconds to 25 seconds in six steps. Two of these have release times which are automatic functions of the program material, providing fast recovery for short-duration peaks and an automatic reduction with very long recovery time of overall gain should the program level remain high.

In the circuitry used, each half of the amplifier consists of two separate amplifiers: one is the Automatic Gain Amplifier, and the other provides the necessary power for producing the DC control voltage. Because of this, the controls are somewhat different from those of most other limiters. Essentially there is one control common to both channels which will switch between independent limiting and vertical-lateral component limiting, besides four controls for each channel: a Switch for Metering; an Input Level Control; a Limiting Threshold Control; and an Attack and Release Time Switch.

Owing to the wide choice of attack and release time, as well as the automatic recovery feature, this unit can be used to limit program material severely without producing the audible thumps or pumping so often associated with limited program material. A limiting meter is provided with provision for connecting a remote meter to the terminals exposed at the rear of the amplifiers.

The MODEL 670 is designed to be placed into any normal line level circuit and can be set to have a unity gain at no limiting. Since all critical components are of highest quality, working well below their maximum ratings, a dependable operation can be expected.

## LIMITING IN STEREO DISK RECORDING

The cutting of STEREO DISKS has uncovered a number of new problems heretofore unknown. The normally modulated STEREO groove requires approximately twice the space of lateral grooves for similar modulation, yet the available space is no greater. In addition, the two STEREO channels, depending on their phase relationship, may result in either lateral or vertical modulation, or a combination of both. It stands to reason that some peaks may result in purely vertical modulation on the disk, others purely lateral. If this were allowed to happen continually, the result would be only 15 minutes on the STEREO LP side or else it would be necessary to reduce the recorded level radically. Otherwise, judicious use of variable pitch and variable depth would have to be exercised. The fact is, because of the smaller playback tip radii and the response of the playback pickups to vertical as well as lateral motions, the signal-to-noise ratio on STEREO DISKS is already reduced over the lateral counterpart. Besides, radical use of automatic variable depth will further increase processing problems already severe in STEREO DISKS.

Another problem exists because of the difficulty of tracking large vertical amplitudes. Most commercially available STEREO pickups have considerably less vertical compliance and consequently are less capable of tracking large vertical modulations. Also, we should not forget that the tip radius on the STEREO playback stylus is still 0.7 mil, which necessitates a minimum of 1 mil groove width, or poor tracking might result.

The one apparent solution to these problems is to break the STEREO signal down to its respective vertical and lateral components. Limit the vertical and lateral components independently corresponding to the available groove space and depth, then recombine these components to regain the original STEREO signal. This can be done with the FAIRCHILD MODEL 670 LIMITER and many thousands of STEREO masters have been cut successfully with the help of this FAIRCHILD unit.

The limiting of the vertical and lateral components instead of the left and right channels has additional merits. Such limiting will retain the spatial distribution of instruments and soloists as originally recorded without producing any annoying image drift. Of course some program material of the ping-pong type requires independent limiting of each channel, and this is also available in the MODEL 670 LIMITER.

SPECIFICATIONS (Each channel, unless otherwise specified)

INPUT IMPEDANCE	600 $\Omega$
OUTPUT IMPEDANCE	600 $\Omega$
OUTPUT LEVEL	+4 or +8 VU (+27 dbm clipping point)
GAIN	7 db (no limiting)
FREQUENCY RESPONSE	40 cycles to 15 kc $\pm$ 1 db
NOISE LEVEL	70 db below +4 dbm
LIMITING NOISES	Below audibility.
INTERMODULATION OR HARMONIC DISTORTION	Less than 1% at any level up to +18 dbm output (no limiting).  Less than 1% at 10 db limiting and +12 dbm output.
ATTACK TIME (adjustable)	.2 milliseconds in positions 1, 2, and 6. .4 milliseconds in positions 3, 4, and 5.
RELEASE TIME (from 10 db of limiting)	Position 1: .3 seconds. Position 2: .8 seconds. Position 3: 2 seconds. Position 4: 5 seconds. Position 5: Automatic function of program material: 2 seconds for individual peaks, 10 seconds for multiple peaks. Position 6: Automatic function of program material: .3 seconds for individual peaks, 10 seconds for multiple peaks, 25 seconds for consistently high program level.
COMPRESSION RATIO	Variable from 1:1 to 1:20 above a predeter- mined level. Predetermined level factory- adjusted to +2 dbm.
SEPARATION	Left-Right position: 60 db Vertical-Lateral position: 40 db
POWER REQUIREMENTS	117 volts, 50-60 cycles, 3 amps
STABILITY	Unit maintains stability of gain, gain reduction and balance over a range of line voltage fluctuations from 100 to 127 volts.

SPECIFICATIONS contd.

CONTROLS

- a) 2 Input Gain Controls  
Step attenuator: 1 db per step.
- b) 2 Threshold Controls  
Continuously variable.
- c) 2 Time Constant Switches  
6 positions each, so as to provide fixed and variable time constants for any type of program material.
- d) 2 Metering Switches  
3 positions each, which permits the measurement of plate current of each set of control tubes.
- e) Mode Switch  
Left-Right position: 2 independent limiters.

Vertical-Lateral position: matrixing input and output, left and right in and out, limiting action vertical-lateral.

- f) ON-OFF Switch

MECHANICAL DIMENSIONS

Standard 19" rack, 14" panel space, depth behind panel 11".

WEIGHT

Approximately 65 lbs.

TUBE COMPLEMENT

8-6386; 1-6084; 1-5651; 2-12AX7; 2-12BH7;  
1-EL34; 4-6973; 1-GZ34 (5V4).

- 1. 0 dbm out
- 2. 4 dbm out
- 3. 8 dbm out
- 4. 12 dbm out
- 5. 16 dbm out
- 6. 20 dbm out
- 7. 24 dbm out

IM DISTORTION AS A FUNCTION OF  
OUTPUT LEVEL & AMOUNT OF LIMITING  
60 CYCLES 7KC 4:1

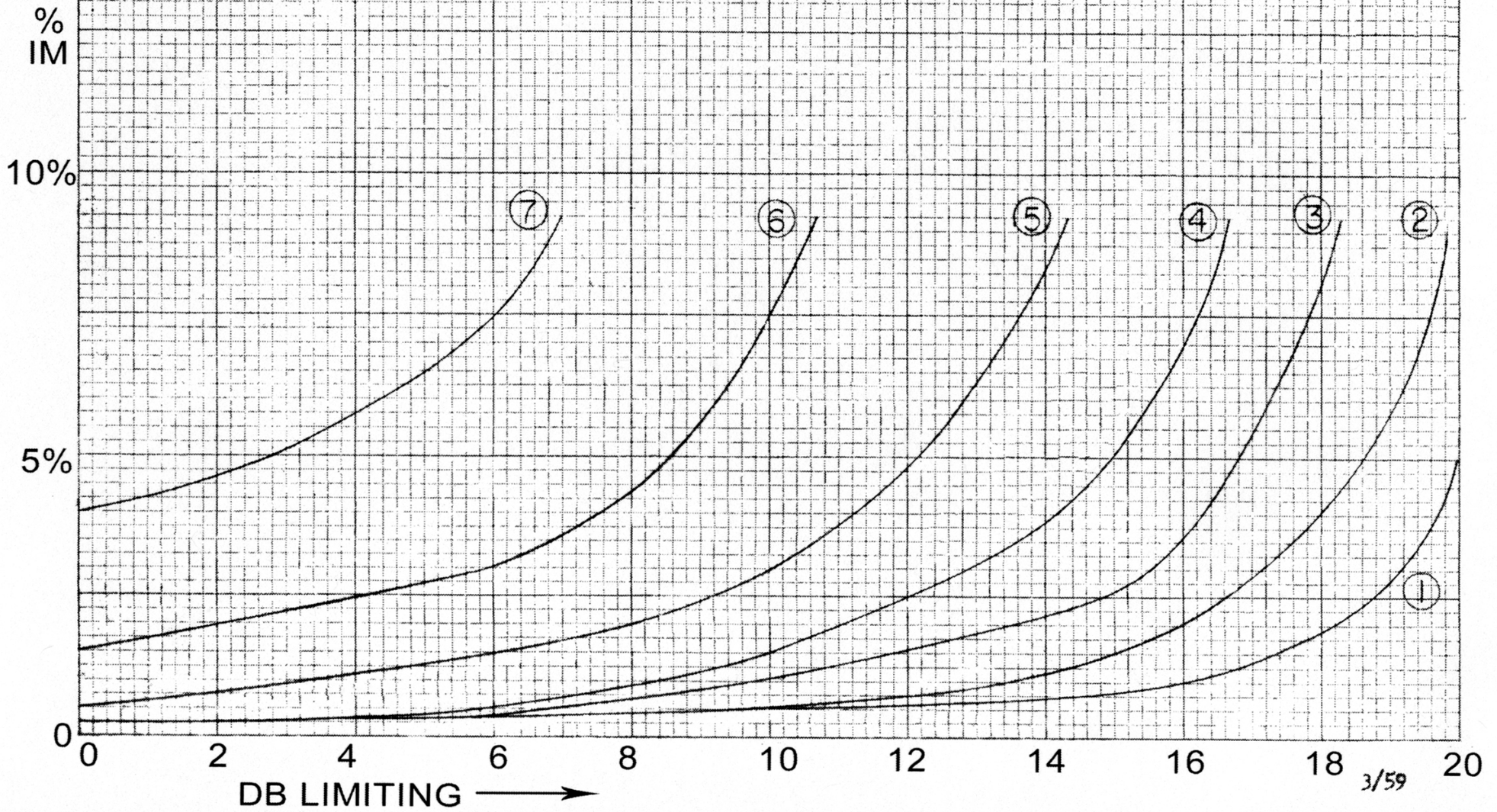



## INPUT AND OUTPUT CONNECTIONS

LEFT CHANNEL - INPUT  
(Z = 600  $\Omega$ )

Terminal 1 Tie point (no internal connection)  
Terminal 2 High  
Terminal 3 Low  
Terminal 4 Ground (chassis)

RIGHT CHANNEL - INPUT  
(Z = 600  $\Omega$ )

Terminal 5 Tie point (no internal connection)  
Terminal 6 High  
Terminal 7 Low

NOTE: If a floating circuit is used, it is necessary that Terminals 3 and 7 be strapped to Terminal 4 (chassis).

LEFT CHANNEL - REMOTE METER Terminals 8 and 9

RIGHT CHANNEL - REMOTE METER Terminals 10 and 11

CAUTION: Terminals 8, 9, 10, and 11 are 240 V above ground.

LEFT CHANNEL - OUTPUT  
(Z = 600  $\Omega$ )

Terminal 12 High  
Terminal 13 Low  
Terminal 14 Ground (chassis)

RIGHT CHANNEL - OUTPUT  
(Z = 600  $\Omega$ )

Terminal 15 High  
Terminal 16 Low  
Terminal 17 Ground (chassis)

Any standard VU-Meter can be used as a Remote Meter if the internal rectifier is removed. A variable resistor of approximately 10K should be used in connection with the Remote Meter. This variable resistor (Ohmite CLU-1031) enables the zero of the Remote Meter to coincide with zero on the meter in the unit (see "REMOTE METER CONTROL" illustration).

If desired, Fairchild Recording Equipment Corporation can supply such Remote Meter (order Fairchild Part No. A-23294).

## REMOTE METER CONTROL

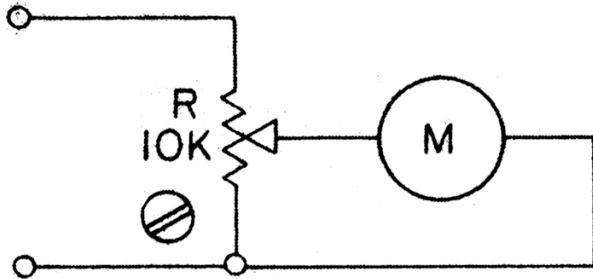

R - OHMITE, AB OR SIMILAR QUALITY POTENTIOMETER

M - ANY STYLE VU METER WITH RECTIFIER REMOVED OR FAIRCHILD PART A-23294

CAUTION - REMOTE METER LEADS ARE APPROX 250V ABOVE GROUND

## REMOTE THRESHOLD CONTROL CIRCUIT

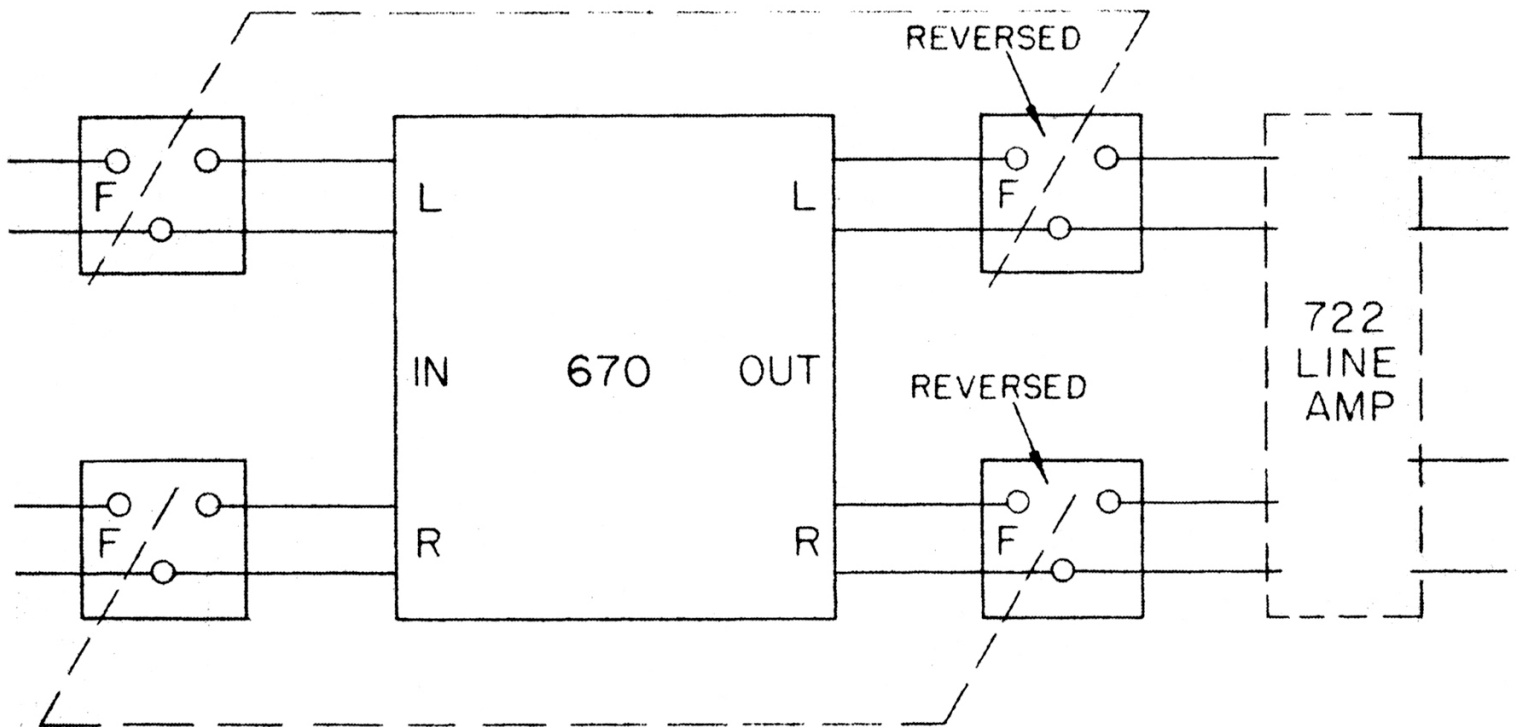

THE FADERS MARKED "F" ARE GANGED 20 STEP - 20 DB BRIDGED "T" FADERS

## BALANCE AND ZERO ADJUSTMENTS

The unit normally maintains the balance and zero adjustments over a wide range of power line voltage changes as well as tube aging. Small unbalances in the order of 1/4 db do not normally produce any ill effects in operation. If it is necessary to re-adjust, the procedure is as follows:

1. Allow the unit to warm up for at least a half hour.
2. Adjust the BALANCE control until same meter reading is obtained in both BALANCE positions.
3. With the METERING switch in zero position, adjust the ZERO control for a meter reading of zero.
4. Repeat step 2 if necessary.
5. If above procedure does not produce reasonable balance, exchange one or more of the 6386 tubes.
6. Repeat the above procedure for the other channel if necessary.

NOTE: Do not adjust R313 (B+ ADJ) inside the amplifier unless the voltage on Pin 8 of V302 (EL34) deviates from 240 V.

## THRESHOLD ADJUSTMENTS

Through the use of the AC and the DC THRESHOLD controls, it is possible to adjust this unit to any operating point between a limiting amplifier and a compressing amplifier (see "INPUT VS. OUTPUT CURVES" where (3) indicates the curve the unit is adjusted to from the factory).

The slope and position of the curve are functions of the desired output level and the position of the AC and the DC THRESHOLD controls. Before adjusting these controls, the desired output level at 3 db and 10 db of limiting respectively, must be chosen. The 3 db limiting point is controlled by the DC THRESHOLD, the 10 db limiting point by the AC THRESHOLD.

The AC THRESHOLD control is located on the front panel as a knob adjustment, whereas the DC THRESHOLD control is located inside the chassis as a screwdriver adjustment. The adjustment procedure is as follows:

1. Set the AC THRESHOLD control to zero and adjust the INPUT GAIN control for unity gain.
2. Turn both the AC and the DC THRESHOLD controls to their full clockwise rotation.
3. Apply a signal to the input 3 db higher than the desired output level and adjust the DC THRESHOLD control to desired output level.
4. Increase the input signal to 10 db higher than the desired output level and adjust the AC THRESHOLD control to desired output.
5. Repeat Steps 3 and 4 until the desired slope and position are obtained.
6. Repeat the above procedure for the other channel if necessary.

REMOTE THRESHOLD control is possible in different ways. One way which does not involve changes in the 670 circuit is the external method, where ganged T-faders are used at in- and output (see "REMOTE THRESHOLD CONTROL CIRCUIT" illustration). This will involve a loss in level of approximately 10 to 16 db which, for example, can be compensated for by using a line amplifier, such as FAIRCHILD MODEL 722.

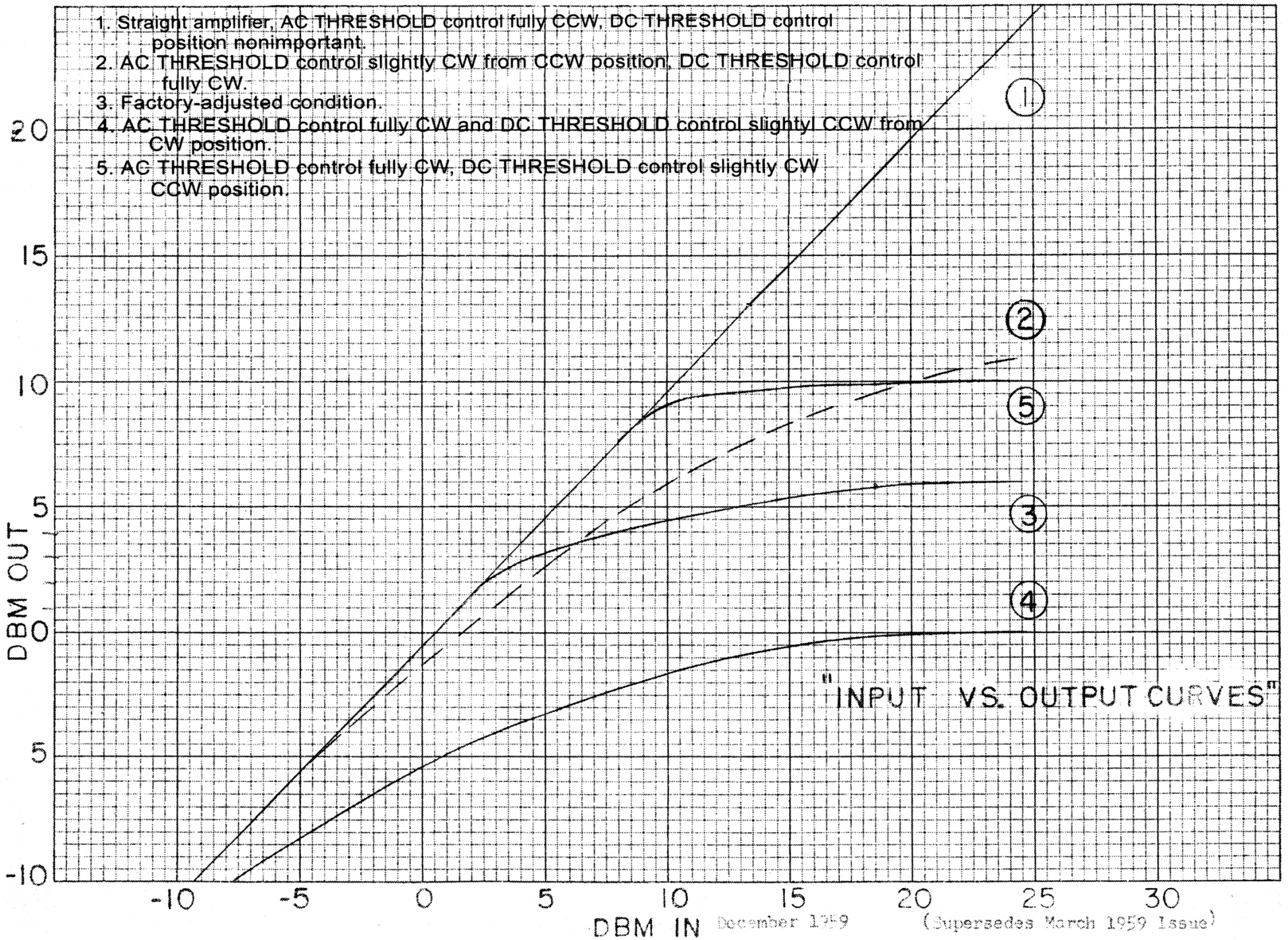

## NORMAL OPERATION

To simplify the initial setting up, here is the standard procedure:

1. Observe if any shipping damage has occurred and make certain that all tubes are firmly seated in their sockets.
2. Mount the unit into a relay rack.
3. Connect input and output leads as specified under "INPUT AND OUTPUT CONNECTIONS."
4. Check the LEFT-LAT and RIGHT-VERT metering as outlined in "BALANCE AND ZERO ADJUSTMENTS."
5. Set the INPUT GAIN controls to unity gain (approx. 10 db attenuation).
6. Set the LEFT-LAT and RIGHT-VERT TIME CONSTANT switches to position 3.
7. Turn the LEFT-LAT and RIGHT-VERT AC THRESHOLD controls on the front panel to zero.
8. Turn the MODE SELECTOR switch to Left-Right position.
9. The unit is now set up as TWO independent limiters. It can be used for TWO separate program sources or for the "ping-pong" type of stereo.
10. To secure the desired degree of limiting, advance the AC THRESHOLD control until the desired amount of limiting or desired output level is achieved.
11. Turning the AC THRESHOLD controls completely counterclockwise removes the limiting action completely. The unit is now a simple Unity Gain Line Amplifier.
12. The unit is adjusted in the factory to conform to curve 3 (see "INPUT VS. OUTPUT CURVES"). This curve is achieved by advancing the AC THRESHOLD controls fully clockwise.
13. Should a different Input vs. Output Curve be desired, see "THRESHOLD ADJUSTMENTS." Generally speaking, a pure peak-limiting action is required for operations having a definite overload point (such as 100% modulation in transmitters), whereas a lesser sloped curve, somewhere in between compressor and peak-limiting, is useful in recording applications. The pure peak-limiting operation generally produces maximum volume within given overload limits; but if a great deal of limiting is used, it tends to become somewhat obvious since all peaks, irrespective of their initial value, will get reduced to the same level. Milder sloped curves, on the other hand, will tend to give a greater apparent dynamic range.

NORMAL OPERATION contd.

14. It should be remembered that the standard VU-Meter is only an average reading instrument. A VU indication of "0" in complex program material may result from actual peak values as much as 10 db higher. In setting up limiting curves, this should be kept in mind.
15. Individual beliefs and previous habits often influence the form of limiting desired. It is with this in mind that we have provided a tool flexible enough to be set up to fulfill almost any requirement.
16. The TIME CONSTANT switches give a wide choice of constants. Position 3 is merely a first suggestion for a general purpose timing circuit. With certain popular music or speech a much faster time constant, such as positions 1 or 2, might be more desirable. For classical music a much slower position, such as 4, is useable. Positions 5 and 6 combine fast release with slow release and can be useful if a great amount of automatic level correction is required. These positions should also make the limiter action least audible since they will reduce overall program level if continual limiting persists.
17. So far the unit has been described as TWO separate limiters. If it is desirable to use the unit for correcting the respective lateral and vertical components in transferring tapes to stereo disks or dubbing original tapes to the master tape, the Vertical-Lateral position is advantageous. In this position, each stereo channel is divided into its respective lateral and vertical components. The upper channel now acts as a limiter for the lateral component, the lower channel as a limiter for the vertical component. As long as the amount of lateral and vertical component reduction in each channel is identical, no deterioration of separation will occur. However, often it is advantageous to reduce the vertical component more than the lateral, resulting in some loss of separation. Limiting the lateral and vertical components can be of great help in producing good stereo masters with only negligible loss of separation.

.....

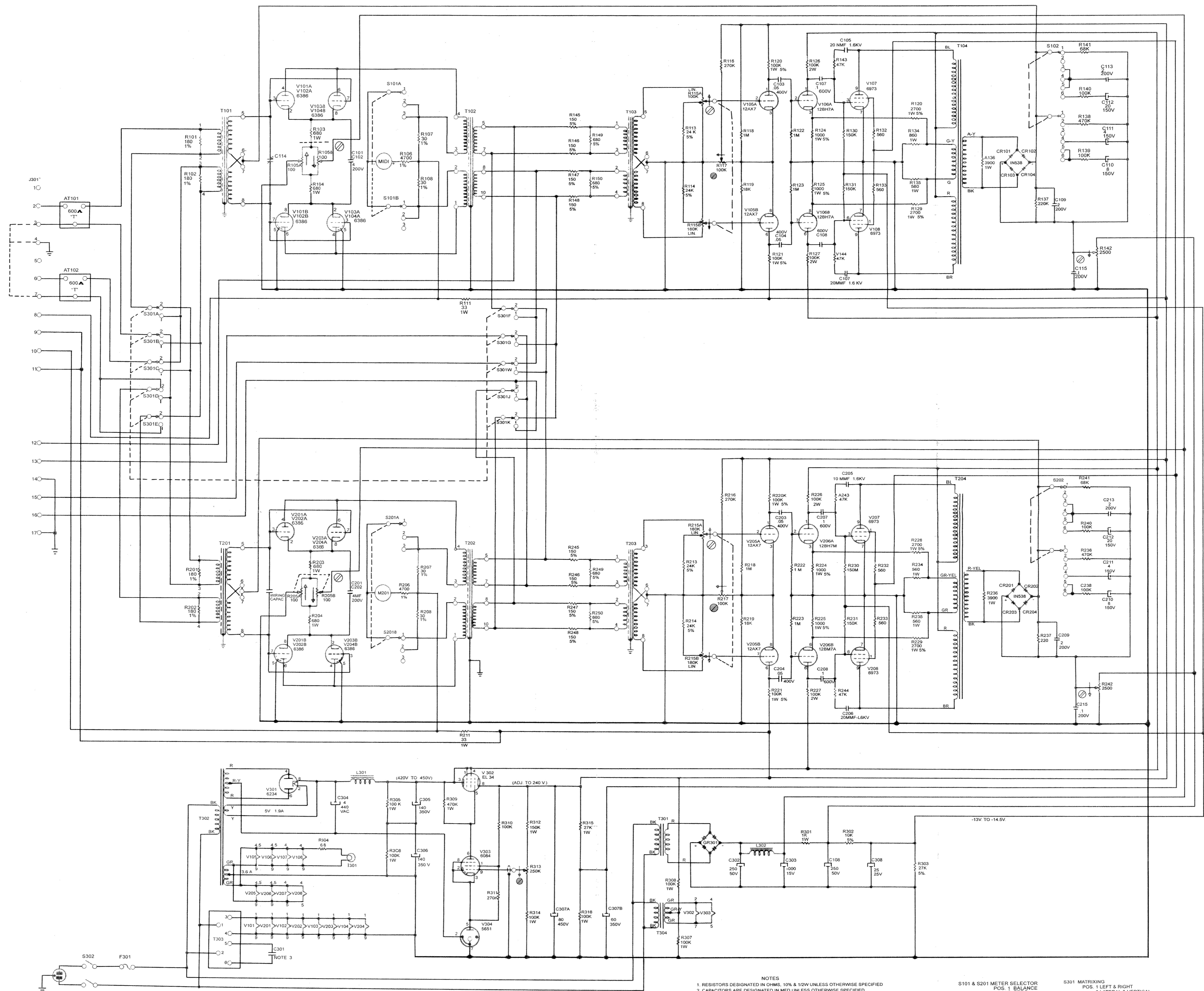

- NOTES
1. RESISTORS DESIGNATED IN OHMS, 10% & 1/2W UNLESS OTHERWISE SPECIFIED
  2. CAPACITORS ARE DESIGNATED IN MFD UNLESS OTHERWISE SPECIFIED
  3. C301 SUPPLIED AS PART OF T303 & HAS A VALUE OF 9500 VAC
  4. SCREWDRIVER ADJUSTMENT FRONT PANEL
  5. SCREWDRIVER ADJUSTMENT BENEATH FRONT PANEL
  6. KNOB ADJUSTMENT FRONT PANEL
  7. ALL SWITCHES SHOWN IN CCW POSITION EXCEPT S301

- S101 & S201 METER SELECTOR  
 POS. 1 BALANCE  
 2 ZERO  
 3 BALANCE
- S102 & S202 TIME CONSTANT  
 POS. 1-6

- S301 MATRIXING  
 POS. 1 LEFT & RIGHT  
 2 LATERAL & VERTICAL
- R133 REG. B+ ADJ.

AT101 & AT201 INPUT GAIN  
 R105 & R205 BALANCE  
 R115 & R215 AC THRESHOLD  
 R117 & R217 DC THRESHOLD  
 R142 & R242 ZERO