

pcm 42

digital delay processor

Owner's Manual

lexicon

TABLE OF CONTENTS

SECTION ONE — INTRODUCTION			
1.0	Description	3	
1.1	Precautions	3	
SECTION TWO — CONTROLS & INDICATORS			
2.0	Introduction	4	
2.1	Front Panel	4	
2.2	Rear Panel	7	
SECTION THREE — INSTALLATION			
3.0	Mounting	9	
3.1	Power Requirements	9	
3.2	Audio Signal Connections	9	
3.3	Audio Control Jacks	10	
3.4	Operating Levels	10	
3.5	Non-Audio Remote Control Functions	11	
3.6	Clock Output	12	
3.7	Voltage Changeover	12	
SECTION FOUR — APPLICATIONS			
4.0	Interconnecting the PCM 42	13	
4.1	General Application Notes and Set-ups	14	
4.1.0	Introduction	14	
4.1.1	Echo	15	
4.1.2	Double Tracking	16	
4.1.3	Flanging	17	
4.1.4	Resonant Effects	17	
4.1.5	Vibrato	18	
4.1.6	Pitch Twisting	18	
4.1.7	Stereo Image Placement	18	
4.2	Special Applications of Long Delay	19	
4.2.0	Introduction	19	
4.2.1	Layering and the Infinite Repeat Mode	19	
4.2.2	Looping Techniques for Live Performance	20	
4.3	Programming and Using the Metronome/Clock Output	21	
4.3.1	Setting the Clock Rate	21	
4.3.2	Interfacing the Clock with Rhythm Machines	22	
4.4	Interfacing to Other Units	23	
4.5	Delay Lines in Distributed Sound Reinforcement Systems	26	
SECTION FIVE — BLOCK DIAGRAM			27
SECTION SIX — SPECIFICATIONS			
6.0	Test Conditions	28	
6.1	General Performance	28	
6.2	Interface Information	28	
6.3	Controls and Indicators	29	
6.4	Power and Dimensions	30	
SECTION SEVEN — IN CASE OF DIFFICULTY			
7.1	General	31	
7.2	Unit Will Not Power Up	31	
7.3	Unit Powers Up, Gives Improper Display	31	
7.4	Unit Powers Up, But Will Not Pass Audio	31	
7.5	Returning Units For Repair	31	
7.6	Replacement Parts	32	
7.7	Limited Warranty	32	

SECTION ONE INTRODUCTION

1.0 DESCRIPTION

The PCM 42 is a high-performance digital delay line/processor that features up to 2.4 seconds of high quality audio delay, expandable to 4.8 seconds with optional memory. Delay times are indicated by a highly accurate numeric display, which provides rapid tracking of ALL changes in delay time. The PCM 42 includes versatile audio patching and remote control facilities, and a unique synchronizing clock feature that allows highly musical usage of the very long delays of which it is capable. Long repeat loops and layering effects which were formerly confined to the studio may now be used easily and reliably on stage.

The 42 provides superior audio performance through Lexicon's proprietary method of analog-to-digital encoding. An increased sampling rate gives wider bandwidth without aliasing effects. In addition, a new "soft-knee" limiting circuit eliminates the unpleasant distortion that most digital circuits generate when overloaded. The PCM 42's excellent sonic quality, unique features, light weight, flexibility and ease of use make it the perfect choice either on stage or in the studio.

1.1 PRECAUTIONS

Although the PCM 42 is a very well-behaved device, precautions consistent with good practice for any piece of audio gear should be observed as a matter of course.

Before turning the PCM 42 on or off, it is advisable to lower the volume on your power amplifier or monitoring system to avoid undesirable transients.

Never connect power sources or audio power amplifiers directly into ANY of the PCM 42's phone jacks. The PCM 42's inputs are designed for line level signals. If a guitar amplifier is used as a signal input, then a suitable attenuator pad must be used to lower the level of the feed to the PCM 42.

To prevent fire or shock, never operate the PCM 42 in the rain or in exposed wet locations.

Please read Section Three (INSTALLATION) of this manual before operating the PCM 42.

WARNING

ALL SERVICING OF THE PCM 42 SHOULD BE PERFORMED BY QUALIFIED SERVICE PERSONNEL. THERE ARE HAZARDOUS VOLTAGES LOCATED UNDER BOTH THE TOP AND BOTTOM COVERS OF THE UNIT. TO AVOID ELECTRICAL SHOCK, REMOVE THE POWER CORD BEFORE REMOVING COVERS. SERVICING PROCEDURES CONSISTENT WITH GOOD SAFETY PRACTICE SHOULD BE USED AT ALL TIMES.

SECTION TWO CONTROLS & INDICATORS

2.0 INTRODUCTION

This section briefly describes the PCM 42's controls, connectors and indicators. More detailed information about installation and applications is contained in Sections 3 and 4. Audio levels are given in dBV (0 dBV = 1.0 Volts RMS).

If you are already very familiar with the operation of digital delay lines, reading this section and looking at the setup diagrams in Section 4 will get you started on the PCM 42. But be sure to read sections 4.2 and 4.3 for information on the PCM 42's unique layering and looping capabilities.

2.1 FRONT PANEL

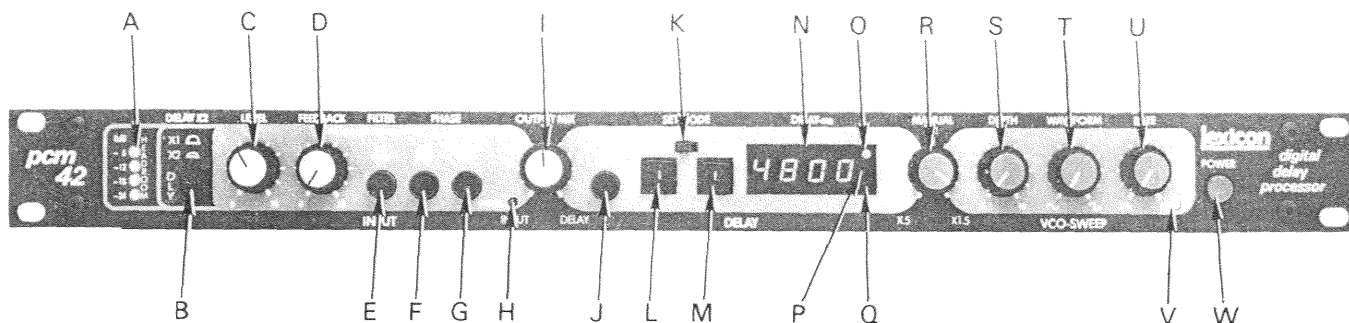

Figure 2.1 — PCM 42 Front Panel

A. HEADROOM DISPLAY

The HEADROOM display monitors the audio level after the INPUT LEVEL and FEEDBACK controls. The display has 5 LEDs which indicate peak levels relative to converter overload. The input stage operates normally up to 3 dB below the absolute limit, where a 5:1 compression ratio comes into play. At 0 dB, the input stage limits, and further increases in input level will produce no additional input to the digitizer. Even extreme input levels produce only a soft distortion, rather than clipping. The Headroom Display follows the compressor/limiter, indicating the audio level actually seen by the analog-to-digital converter; thus it becomes non-linear with respect to the input signal when the 0-dB LED is lit.

B. DELAY RANGE

The DELAY X2 switch determines whether the PCM 42 is in the short (X1) or the long (X2) time delay range.

When the button is out, the unit is set for the short range (0-1200 ms standard, 0-2400 ms with memory option) and 16 kHz bandwidth. Pushing the button selects the long range (0-2400 ms standard, 0-4800 ms with memory option) with 6 kHz bandwidth, illuminating the 6 kHz LED (Fig. 2.1, Q). The numeric delay display always indicates the actual delay time.

C. INPUT LEVEL

The INPUT LEVEL control adjusts the input gain for proper matching of the PCM 42's sensitivity to the input signal. Set this control so the HEADROOM display occasionally indicates 0 dB on program peaks, with average levels at about -12 dB (in the green zone).

NOTE: A rear panel switch provides an additional 20 dB of gain for low level inputs, such as the output of an instrument pickup. For details, see Section 2.2, paragraph "I".

D. FEEDBACK

Turning the FEEDBACK control clockwise feeds the delayed audio back to the input, mixing it with the input signal. At high settings the FEEDBACK control tends to sustain sounds and create resonant effects.

E. HI CUT FILTER

Engaging the HI CUT FILTER button inserts a 6 dB/octave low-pass filter (-3 dB @ 4 kHz) into the feedback path. This is useful for creating tape-delay sounds, simulating room ambience, or moderating the harshness of highly resonant effects.

F. FB INV PHASE

Engaging the FB INV (Feedback Invert) pushbutton reverses the polarity of the delayed audio which is being fed back to the delay line input. Inversion of the feedback signal alters phase cancellation characteristics, and is typically used for resonant flanging sounds.

G. DLY INV

Engaging the DLY INV (Delay Invert) button reverses the polarity of the delayed sound which is fed to the OUTPUT MIX control (Fig. 2.1, I).

H. BYPASS LED

In Bypass mode, the Delay signal is cut out of the mix at the MAIN OUTPUT, and all input to the delay line is cut off. This LED is illuminated when the BYPASS is activated by the optional footswitch or an external logic signal.

I. OUTPUT MIX

The OUTPUT MIX control establishes the ratio of direct to delayed sound in the PCM 42 MAIN OUTPUT. Full counterclockwise position (toward INPUT) provides 100% direct sound from the input preamplifier. Full clockwise position provides 100% delayed sound. The control is detented in center position, where the blend of signals is equal. This point is calibrated for maximum notch depth during flanging.

J. ∞ RPT

The INFINITE RPT pushbutton causes the PCM 42 to capture the sound in the delay memory at the first clock pulse after the button is pressed and repeat that segment continuously until the button is pressed again. The repeat mode uses the entire delay memory — the length of the captured segment is independent of the delay tap selected with the UP and DOWN pushbuttons, but changes with the settings of the MANUAL VCO-SWEEP control and the DELAY X2 pushbutton.

Note that the infinite repeat mode is enabled not at the instant the button is pressed, but at the first clock pulse (as shown by the flashing CLK LED at the right of the display) after that time. To allow rapid entry into this mode, set the clock rate to a small fraction of the total delay time (see section K, below).

The PCM 42 will not power up in repeat mode. If the INFINITE RPT button is "IN" at time of power up, the unit will not enter the repeat mode until the pushbutton is released and pressed again. Repeat mode can also be selected through a momentary-contact switch attached to the rear panel INFINITE REPEAT jack (Fig. 2.2, D).

K. SET-MODE

The SET-MODE slide switch determines the function of the display and the UP and DOWN pushbuttons. In normal operation, this switch is set to DLY (left) and the display shows the delay time in milliseconds, while the pushbuttons increment and decrement the delay tap selection.

With the SET-MODE switch in the CLK (right) position, the UP and DOWN pushbuttons change the rate of the flashing CLK LED and of the pulses appearing at the CLOCK output. In this mode, the display indicates the period of the clock as a fraction of the maximum delay time (as determined by the DELAY X2 and the MANUAL VCO-SWEEP settings). The numerator of the fraction is on the left, the denominator on the right. The DOWN button cycles the numerator through odd integers 1, 3, 5, 7, and 9. The UP pushbutton causes the denominator of the fraction to cycle through binary values 1, 2, 4, 16, 32, and 64.

L. DOWN BUTTON — DELAY/CLOCK

The DOWN pushbutton decrements the delay tap value or the denominator of the CLOCK output ratio, as described in paragraph "K" above. With the SET-MODE switch in DLY, a short press and release of the button will decrease the delay time by one increment. If the button is held in, the selection will decrease approximately once per second. To move rapidly to a new setting, the UP button may be pressed while continuing to hold DOWN. When UP is released, the increment rate reverts to once per second.

M. UP BUTTON — DELAY/CLOCK

The UP pushbutton increments the delay tap value or the numerator of the clock ratio as described above in paragraphs "K" and "L". As with DOWN, the rate of increase of the delay time may be accelerated by pressing DOWN while holding UP. Thus, the direction of change is determined by which button is pressed first, while the rapid mode is enabled by the opposite button.

N. DELAY DISPLAY

When the SET-MODE switch is in the DELAY position, the DELAY DISPLAY gives a precise 4-digit display of the actual delay time in milliseconds. With the SET-MODE switch at CLOCK, it shows display of the clock fraction (see section K above). The delay time display is accurate and updates itself very quickly, allowing it to track all sweep functions as fast as the eye can follow.

O. CLK LED

The CLK LED flashes in synchrony with the CLOCK OUTPUT on the rear panel. The rate at which the lamp blinks is determined by the fraction programmed with SET-MODE, DOWN and UP, coupled with the settings of the VCO-SWEEP controls.

To determine the exact period of the CLOCK, step the delay tap value upward with UP until the display ceases to increment, indicating maximum delay time. (Use the fast-forward function described in paragraphs K and L.) Note the delay time, and then switch SET-MODE to CLOCK and read the display as a fraction, with the numerator on the left and the denominator on the right. The clock period is equal to the delay time times the clock fraction. Note that if DEPTH is not set to 0, or an external modulation is present, the clock rate will not be stable.

P. ∞ LED

The INFINITY LED is illuminated whenever the repeat mode is selected by the INFINITE RPT pushbutton or the corresponding footswitch jack.

Q. 6 kHz LED

The 6 kHz LED lights when the long delay mode is selected by DELAY X2, indicating a reduction in bandwidth to 6 kHz and a doubling of the available range of delay.

R. MANUAL VCO-SWEEP

The MANUAL VCO-SWEEP control provides continuous, smooth control of delay times over a range of 3 to 1 by modifying the sampling rate. This control functions as a manual modulation for flange, chorus and pitch twisting effects, and for access to very long delay times.

S. DEPTH

The DEPTH control adjusts the amount of internal modulation of the VCO, affecting the depth of sweep

for flange, chorus and pitch-twisting. When DEPTH is set at "0", the internal sweep is inactive. As the DEPTH control is advanced clockwise toward "10", the range of the sweep increases to a maximum clock ratio of 3:1.

The DEPTH control interacts with the MANUAL VCO-SWEEP control (Fig. 2.1-R). The MANUAL control has its maximum effect with the DEPTH at "0", and no effect with the DEPTH control at "10".

T. WAVEFORM

The WAVEFORM control selects the type of VCO modulation:

1. Full counterclockwise rotation selects sinusoidal modulation: the delay time smoothly increases and decreases at a speed governed by the RATE setting.
2. Setting the control at the center detent selects envelope-follower modulation: the delay time changes in response to the level of the input signal.
3. Full clockwise rotation selects square-wave modulation: the delay time jumps instantaneously up and down according to the setting of the RATE control.
4. Intermediate positions of the control blend either sinusoidal or square-wave modulation with envelope-follower modulation.

U. RATE

The RATE control adjusts the low-frequency oscillator (LFO) that controls the frequency of the sine- or square-wave modulation. With the WAVEFORM control in the center (envelope-follower) position, the RATE control will have no effect.

V. RATE LED

The RATE LED flashes on and off to indicate the rate of the LFO and to allow playing in synchronization with the delay sweep.

W. POWER SWITCH

This latching pushbutton turns the AC power on and off. On power-up, the delay time is automatically set to 0 ms, the infinite-repeat function is turned OFF, and the clock ratio is set to a value of 1/2. All other switch and control settings remain as they had previously been set.

2.2 REAR PANEL

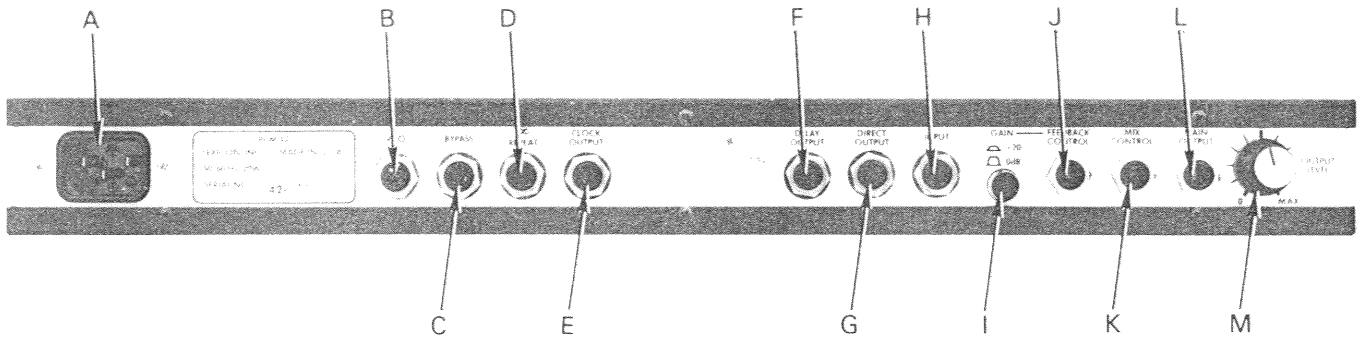

Figure 2.2 — PCM 42 REAR PANEL

A. POWER CONNECTOR

The POWER connector accepts standard IEC power cords. Before plugging in the AC cord and applying power, check the adjacent data plate to ensure that the set operating voltage matches that of the AC mains.

B. VCO REMOTE JACK

The VCO input jack allows remote operation of the MANUAL VCO-SWEEP control by means of a foot controller (optional), or an external control voltage (range 0 to +10 Volts; 0 Volts = maximum delay, +10 Volts = minimum; linear over a range of 3:1). The VCO jack accepts a standard 1/4" phone plug for control voltages, or a stereo tip/ring/sleeve plug when used with the optional foot controller (Lexicon A-CP-41 Foot Pedal). When the plug is inserted, the MANUAL VCO-SWEEP is bypassed and has no effect.

C. BYPASS SWITCH JACK

The BYPASS function provides a means of quickly switching the delay signal out of the MAIN OUTPUT mix, while at the same time killing the feed to the delay circuitry itself. The BYPASS jack accepts a 1/4" phone plug and the BYPASS is activated when the tip of the plug is shorted to the sleeve, or when a TTL logic "0" is present at the tip.

D. ∞ REPEAT SWITCH JACK

The INFINITE REPEAT function is activated by a momentary switch closure or the falling edge of a TTL compatible clock pulse. The unit remains in repeat mode until another closure or pulse arrives OR the front panel INFINITE REPEAT pushbutton (Fig. 2.1, J) is released from a depressed position. The BYPASS function and the INFINITE REPEAT mode may be controlled with a single Lexicon A-FS-41 Dual Footswitch Assembly, or any combination of one latching (BYPASS) and one momentary-contact (INFINITE REPEAT) switch.

E. CLOCK OUTPUT JACK

The CLOCK OUTPUT jack provides a TTL-compatible square wave output suitable for clocking many automatic rhythmic devices and sequential controllers. The rate of the clock is a fraction of memory capacity at the current sampling rate, programmable from the front panel. This allows synchronization of external devices to the delay period. (See Sections 3.6 and 4.3.2.)

F. DELAY OUTPUT JACK

The DELAY OUTPUT is an unbalanced tip/sleeve jack carrying the output of the delay line at line level, unmixed with any of the direct signal. (See Sections 3.2 and 4.4.)

G. DIRECT OUTPUT JACK

The DIRECT OUTPUT is an unbalanced tip/sleeve jack which carries only the input signal after preamplification. This signal is at system line level.

H. INPUT JACK

The INPUT jack is a balanced, differential input which accepts a 1/4" tip/ring/sleeve phone plug; unbalanced sources can be accommodated by simply substituting a tip/sleeve phone plug. A high input impedance allows the PCM 42 to interface with either low or high impedance sources.

I. GAIN SWITCH

The GAIN Switch matches the PCM 42's input sensitivity to the signal source. Engaging the switch increases sensitivity by 20 dB for sources such as electric pickups, high-output microphones, and some electronic instruments.

J. FEEDBACK CONTROL JACK

The FEEDBACK CONTROL jack provides two distinct functions. When used with a tip/ring/sleeve plug and a

foot pedal (Lexicon A-CP-41) or any potentiometer, the user can add feedback to the sound remotely. It can also function as an auxiliary input which is combined with the main input without gain control (nominal line level). (See Sections 3.3 and 4.2.2.)

NOTE: THIS FUNCTION IS INDEPENDENT OF THE FRONT PANEL FEEDBACK CONTROL. RUNAWAY FEEDBACK CAN RESULT IF BOTH CONTROLS ARE RAISED AT THE SAME TIME.

K. MIX CONTROL JACK

Like the FEEDBACK CONTROL, the MIX CONTROL jack provides dual functions. With a potentiometer or foot pedal, the user can raise and lower the volume of the delayed signal in the MAIN OUTPUT mix. Thus, delay effects can be faded in and out at will. This jack

can also be used to inject an external signal into the output mix. (See Sections 3.3 and 4.2.2.)

L. MAIN OUTPUT

The MAIN OUTPUT is an unbalanced tip/sleeve jack whose signal level is determined by the adjacent control. It carries the blend of direct and processed signal which is set with the front panel OUTPUT MIX control (Fig. 2.1, 1).

M. OUTPUT LEVEL

The OUTPUT LEVEL control adjusts the MAIN OUTPUT level from its maximum of +19 dBV (9 V rms) down to full attenuation. This control should be adjusted to provide the maximum level to the monitor system, amplifier or console without clipping its input stage.

SECTION THREE INSTALLATION

3.0 MOUNTING

The PCM 42 fits in a standard 19 inch relay rack, occupying one unit (1-3/4") of rack space and extending 11" behind the front panel. If the unit is to be transported in its rack, it should be protected from vibration and shock by supporting the rear of the chassis. It will also help to place rubber washers on the front mounting screws in front of and behind the front panel.

The PCM 42 is fitted with rubber feet and may be placed on any flat surface. **BE SURE TO PROVIDE ADEQUATE VENTILATION AROUND THE TOP, BOTTOM AND SIDES OF THE UNIT**, whether or not it is rack-mounted. This is of particular importance if the unit is mounted above power amplifiers or other heat-generating gear.

Since the PCM 42 processes low-level audio signals, it is advisable to locate it away from strong electromagnetic fields, such as those generated by power transformers, motors, fluorescent ballasts, etc.

3.1 POWER REQUIREMENTS

The PCM 42 is set at the factory to operate at either 100, 115, or 230 volts (50 - 60 Hz). The factory-set voltage is indicated on the rear panel next to the power receptacle. The maximum power required is 20 watts. Units set for 100 or 115 volts are fused at 1/4 ampere, 230-volt units at 1/8 ampere.

THE OPERATING VOLTAGE SHOULD NOT BE CHANGED EXCEPT BY A QUALIFIED SERVICE TECHNICIAN.

The PCM 42's power cord has a standard three-pin IEC connector to simplify adaptation to power sources in various countries, and to provide chassis-to-mains grounding according to accepted safety standards.

3.2 AUDIO SIGNAL CONNECTIONS

All connections on the PCM 42 are 1/4" phone jacks, and all the audio inputs and outputs will accept two-wire mono (or unbalanced-line) tip/sleeve (T/S) cords. Several, however, are configured for stereo (or balanced-line) tip/ring/sleeve (T/R/S) plugs for input or foot pedal control functions. Read this subsection to ensure that you are using the proper cable for each function.

INPUT (Fig. 2.2, H)

The PCM 42's high input impedance (40 kilohms) allows interfacing with sources having either low- or high-impedance outputs. The audio INPUT jack works as a balanced differential input when used with a T/R/S phone plug (Tip = signal high, Ring = signal low, Sleeve = shield ground).

It can also be used with unbalanced input sources when fed by a T/S phone plug (Tip = signal high, Sleeve = signal low/shield). This creates a traditional single-ended input.

NOTE: If a T/R/S plug is used with a single-ended source, be sure to short the ring and sleeve terminals together.

OUTPUTS

The MAIN, DIRECT and DELAY audio outputs (Fig. 2.2, L, G and F) are unbalanced (single-ended), and are intended for use with a T/S phone plug. Load impedances of 5 kilohms or higher can be driven to full levels; loads as low as 600 ohms may be driven without loss of signal quality, although the output level will be reduced slightly. If the PCM 42 is used to drive microphone level inputs from the DIRECT or DELAY outputs, it will be necessary to insert a 20- or 30-dB pad at the input to the driven device. The MAIN OUTPUT has its own level control.

3.3 AUDIO CONTROL JACKS

The PCM 42 has two audio control jacks which are wired in T/R/S configuration. In both of these, the sleeve is a common ground, and a single-ended, buffered delay output appears on the ring. The tips of the jacks are connected to different input patch points in the PCM 42.

FEEDBACK CONTROL JACK (Fig. 2.2, J)

The tip terminal of this jack is connected to a patch point that is mixed with the main INPUT. The input accepts single-ended, line-level audio from a source of any impedance. Connecting a Lexicon A-CP-41 foot pedal to this jack places the foot pedal's internal potentiometer between the ring and the tip, mixing the delay output with the main input and thus allowing remote control of feedback or regeneration.

Since the delay-only output on the ring is buffered, a two-way T/S phone plug may be inserted in this jack to mix any other line-level signal with the main input without compromising the delayed signal. A T/R/S plug with connections to the ring and sleeve only will permit the use of either audio control jack as a separate delay-only output.

NOTE: The feedback loop enabled by this control jack is separate from, and operates in parallel with, the front panel FEEDBACK control and its associated HI-CUT and FB INV switches. If the two controls are used simultaneously, runaway feedback (howling) can occur. When using the FEEDBACK CONTROL jack with the foot pedal, turn the front panel FEEDBACK control to 0.

MIX CONTROL JACK (Fig. 2.2, K)

Inserting a phone plug into this jack interrupts the connection of the delay signal to the OUTPUT MIX control on the front panel. A foot pedal plugged into this jack allows the performer to fade the delay effects as desired from zero up to the setting of the OUTPUT MIX control. This jack may also be used to insert other signal processors, such as equalizers, into the path of the delayed signal. The input accepts single-ended, line-level audio from a source of any impedance.

3.4 OPERATING LEVELS

INPUT LEVELS

The PCM 42 can handle a wide variety of input sources including microphones, electric instruments, mixer outputs and so on. The high-impedance delay line input will operate equally well with low- or high-impedance sources. It is important, however, to set the

input sensitivity so that the unit can accommodate the full dynamic range of the source with adequate signal/noise ratio and without excessive limiting.

To match the PCM 42's input sensitivity to the source, you must first set the 20 dB GAIN switch on the rear panel. Push the button in (selecting 20 dB of extra sensitivity) when using sources with peak levels ranging from -23 dBV to 0 dBV (0.07 V to 1.0 V rms). This includes electric pickups, high output microphones, low-level mixer outputs, and some electronic instruments or instrument preamplifier outputs.

The button should be out (unity gain) when using sources with peak levels ranging from -3 dBV to +19 dBV (0.70 V to 9.0 V rms). This includes high level mixer outputs, some electronic instrument/preamplifier outputs and some direct box outputs.

With the appropriate switch position engaged, adjust the front panel INPUT LEVEL control for peak HEADROOM displays of 0 dB, with average levels around -12 dB.

When the signal level is unknown, start at the 0 dB GAIN position (button out), and adjust the INPUT LEVEL control to bring the HEADROOM display within the desired range. If the gain is insufficient to achieve peaks of -6 dB with the INPUT LEVEL at maximum, turn down the INPUT LEVEL and engage the +20 dB position.

WARNING

NEVER CONNECT THE PCM 42 INPUT DIRECTLY TO POWER SOURCES, IMPROPERLY ISOLATED AC/DC DEVICES, OR POWER AMPLIFIERS. DISREGARDING THESE PRECAUTIONS CAN LEAD TO ELECTRICAL SHOCK, AND MAY DO SEVERE DAMAGE TO THE PCM 42.

MAIN OUTPUT LEVEL

The PCM 42 MAIN OUTPUT is designed to drive loads of 5 kilohm or higher impedance at a level of 9 V rms (+18 dBV). It is possible to drive impedances as low as 600 ohms, although maximum output level is reduced to about 5 V rms (+14 dBV).

NOTE: Do not use the INPUT LEVEL control to set output level.

Once the proper input level is established, the rear panel OUTPUT LEVEL control can be used to adjust the MAIN OUTPUT level for a wide range of devices. In general, best signal-to-noise performance results at settings of mid-scale or higher.

WARNING

THE PCM 42 OUTPUTS ARE PROTECTED AGAINST SHORT CIRCUITS, BUT SHOULD NEVER BE CONNECTED TO SIGNAL SOURCES.

AUXILIARY INPUT AND OUTPUT LEVELS

The DIRECT and DELAY outputs, as well as the delay

outputs on the rings of the FEEDBACK CONTROL and MIX CONTROLS jacks have the same drive capability as the MAIN OUTPUT, but do not have their own level controls. These are nominally 3.5 Vrms (+ 11 dBV) for full input level.

The audio patch points connected to the tips of the audio control jacks are high impedance, line level (+ 11 dBV maximum), single-ended inputs.

3.5 NON-AUDIO REMOTE CONTROL FUNCTIONS

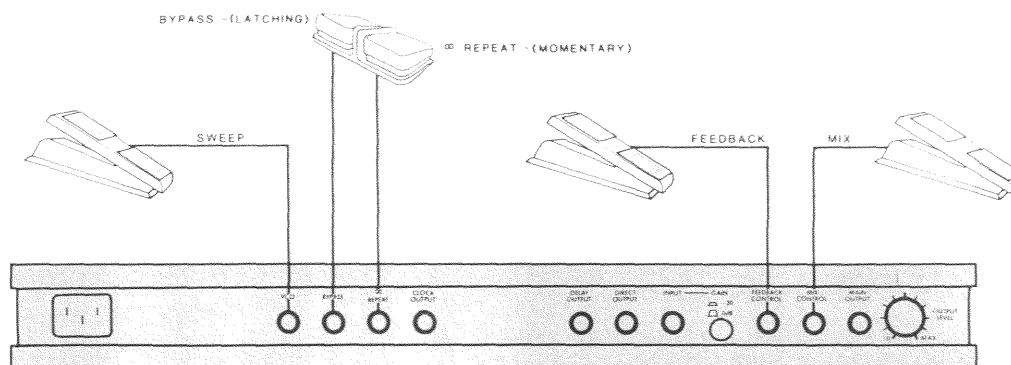

Figure 3.1 — FOOT PEDAL DIAGRAM

Three rear panel phone jacks permit remote control of the BYPASS, INFINITE REPEAT, and VCO functions. The Lexicon A-FS-41 Dual Footswitch Assembly may be used to control the first two functions, and a Lexicon A-CP-41 Foot Pedal for VCO control; or any of a number of common foot switches or controls may be substituted. You can also construct your own controller according to the information provided below.

BYPASS SWITCH JACK (Fig. 2.2, C)

In BYPASS mode, two things happen: the delayed audio is cut out of the MAIN OUTPUT MIX, and the input to the delay line is interrupted. The BYPASS jack accepts a standard 1/4" tip/sleeve (mono) phone plug, and is activated either by a switch closure which grounds the tip to the sleeve, or by a low-going (logic "0") TTL signal. Opening the connection (or inputting a logic "1") will turn off the BYPASS mode; we recommend a latching footswitch for this function.

INFINITE REPEAT SWITCH JACK (Fig. 2.2, D)

The REPEAT function allows permanent retention of any sound stored in the delay memory. The REPEAT jack accepts a standard 1/4" tip/sleeve phone plug; the feature is activated either by a momentary switch closure which grounds the tip to the sleeve, or by a low-

going TTL pulse. This mode is cancelled by any subsequent momentary switch closure or pulse. Unlike BYPASS, INFINITE REPEAT mode may also be controlled from the front panel.

VCO REMOTE JACK (Fig. 2.2, B)

The VCO jack allows remote operation of the delay sweep. It serves the same purpose as the front panel MANUAL VCO-SWEEP control. When a standard 1/4" T/R/S phone plug is inserted in this jack, the front panel MANUAL VCO-SWEEP control is switched out and the remote control is substituted. This function can be controlled either by a potentiometer or by an external voltage source with a range of 0 to +10 volts.

If a potentiometer is used, it should have a linear (rather than log or audio) taper. Values of 10k to 500k ohms will work; 50k is preferred. The CCW end of the potentiometer should be connected to the sleeve terminal of the VCO jack, the CW end to the ring terminal, and the wiper to the tip terminal. The remote control will then function exactly as the MANUAL VCO-SWEEP control does (i.e. CCW = X.5, CW = X2).

Voltage programming of the VCO function requires a source with a range of 0 to +10 volts, which could be a

function generator, a simple 0-10 volt DC power supply, or the control voltage output of a synthesizer or sequencer. 0 volts corresponds to a MANUAL VCO-SWEEP setting of X2, 10 volts to X.5. Connect the positive voltage to the tip of the VCO jack, and use the sleeve for the common connection. The ring can be ignored or shorted to the sleeve (as for instance by the use of a tip/sleeve plug instead of tip/ring/sleeve).

3.6 CLOCK OUTPUT (Fig. 2.2, E)

The synchronizing clock is a feature unique to the Lexicon PCM 42. This output, with its front panel indicator, allows precise synchronization of a musical per-

formance with long or short delay times. Many types of sequencers and rhythm devices may be locked on to this clock.

The clock output itself provides a TTL-level (0 to +5 volt) square wave. The nominal output impedance is 100 ohms.

3.7 VOLTAGE CHANGEOVER

THERE ARE NO USER SERVICEABLE PARTS IN THE PCM 42. PLEASE REFER ALL SERVICE, INCLUDING CHANGES IN OPERATING VOLTAGE, TO A QUALIFIED TECHNICIAN.

SECTION FOUR APPLICATIONS

4.0 INTERCONNECTING THE PCM 42

Within a given sound system, there are a number of possible patch configurations for using the 42. The ex-

amples shown below are representative of typical performer, studio and sound reinforcement setups. Front panel control settings to achieve specific effects are given in Section 4.4.

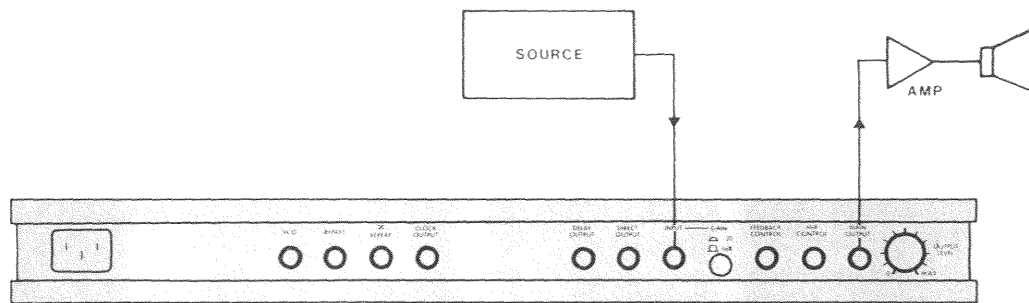

Figure 4.1 — BASIC MONO SETUP

The setup shown in Fig. 4.1 is the most basic form of connection for a performer. If other effects/processing devices are used, the 42 delay line should be the last

item in the chain before the amplifier. See Section 4.5 for special types of interconnect to external devices.

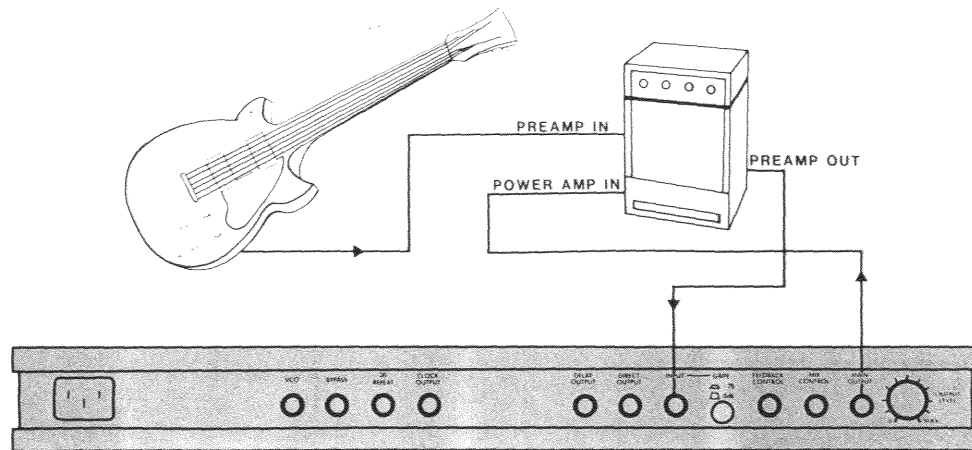

Figure 4.2 — BASIC SETUP WITH AMPLIFIER EFFECTS LOOP

Many modern instrument amplifiers provide preamplifier send and return jacks. If such a facility is available on your amp, it is recommended that the PCM 42 be

connected into that loop. This puts the amplifier's tone controls and distortion effects ahead of the delay line, generally giving a cleaner, more pleasing effect.

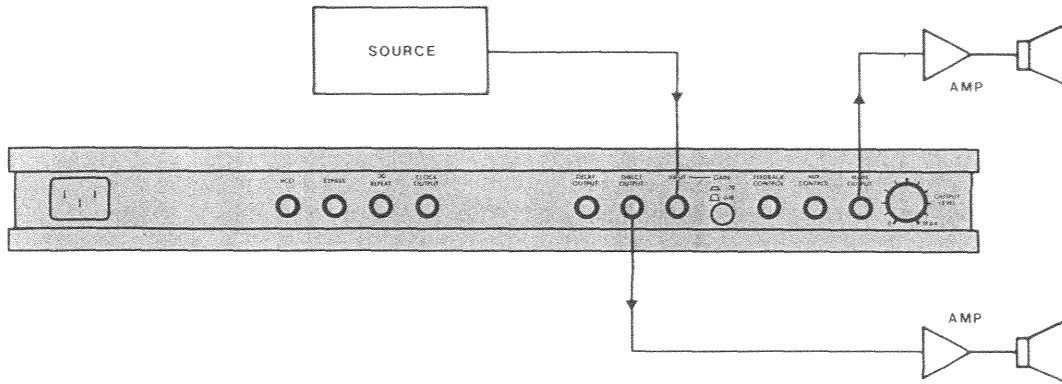

Figure 4.3 – BASIC STEREO SETUP

Many of the very striking effects achievable with audio delay require a stereo field for maximum impact. These include ambient enhancements, double tracking, slap echo and others. A few applications are possible

only in stereo, e.g. mono-to-stereo conversion and localization of sound image. We highly recommend the use of the stereo setup in Fig. 4.3, or a more general setup using a mixing console (See Fig. 4.4).

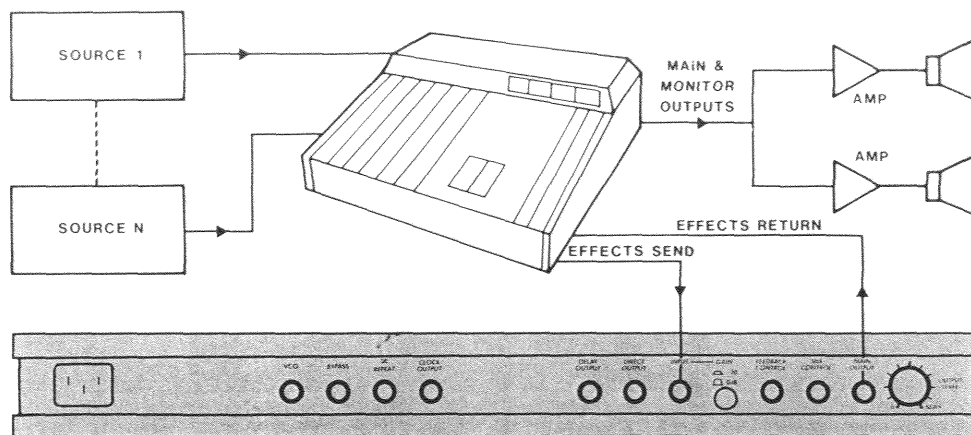

Figure 4.4 – BASIC RECORDING OR SOUND REINFORCEMENT SETUP

For sound reinforcement and studio applications, the PCM 42 is usually connected to an effects send and return on the console.

4.1 GENERAL APPLICATION NOTES AND SET-UPS

4.1.0 Introduction

In the course of showing you how to create specific delay processing effects with your PCM 42, we will

review the definition of each effect. If you are completely familiar with the common usages of time delay, the illustrations and their captions will be all you need. Readers who would like to learn more about time delay applications than is presented here may send for a copy of Lexicon Application Note AN-3.

In trying out these settings, consider the fact that for any given setup the audible effect may be completely different for different program sources. For example, some tunneling effects may be dramatic with vocals and scarcely noticeable with guitar. For this reason, the

patch diagrams are intended only as suggested starting points. By all means experiment and derive your own favorite effects.

In the following front panel drawings, darkened buttons are engaged (pressed in). Control settings are marked on the knobs except where the setting does not alter the basic effect (e.g., wherever VCO DEPTH is at "0", the WAVEFORM and RATE settings are

irrelevant). Input level is not shown as this must be set up for the specific source in use. For setups that use sweeping delay times, the numbers indicated in the display window are to be set up with the DEPTH control set at "0"; then DEPTH should be raised to the level indicated for that effect. Generally speaking, the delay times shown need not be precisely emulated to achieve the desired effect, and the longer the delay time involved, the less critical the setting.

4.1.1 Echo

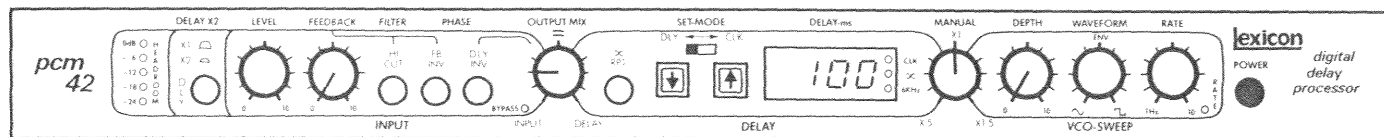

Figure 4.5-a — SLAP ECHO

This set-up adds rhythmic interest by doubling the attacks, and tonal interest by doubling the sustains. Sending the output through a fuzztone circuit will produce a more dramatic distortion.

This mode simulates an acoustic echo, in which sound bouncing off a hard surface is heard as a distinct repetition of the original. The level of delayed sound relative to direct sound gives the ear information about the hardness and size of the reflecting surface. Natural echoes have losses in the upper frequencies due to air absorption; it may be desirable to use the DLY X2 push-

button with its 6 kHz rolloff when simulating a distant echo even when the delay time is within the limit imposed by full-bandwidth operation. An external equalizer may also be inserted between the delay and the output mix using the MIX CONTROL jack (See Section 4.4, "Interfacing to Other Units"). Delay times of 75 to 100 ms create what is commonly known as "slap echo".

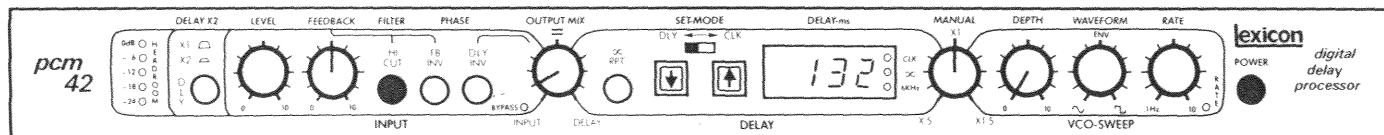

Figure 4.5-b — AMBIENT ECHO

These settings simulate echoes from a medium-sized hard room. The reverb time will be a function of the FEEDBACK setting. The proper amount of VCO modulation varies with the material, and can be quite high with a pure vocal track.

Ambient echo effects simulate sound reflections from room surfaces. In true reverberation there are many random reflections, a gradual decay of overall level, and a gradual narrowing of bandwidth. While the PCM 42 only simulates reverberation with its ambient echo effects, there are situations where the results are reasonably convincing and quite desirable.

If the reflected sound continues to bounce back and forth between surfaces, it provides a long decaying

"tail". To produce this effect, use 30 to 150 ms of delay, in conjunction with some recirculation. Experiment with the HI CUT filter and the FB INV function to simulate the absorption characteristics of different reflecting surfaces. To further enhance diffusion of the echoes, try very small amounts of VCO modulation at slow rates. With musical programs that have few sharp attacks, the ambient echo can closely resemble true reverberation.

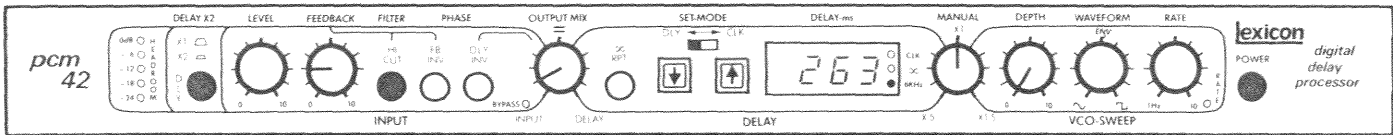

Figure 4.5-c — MULTI-ECHO

More obvious echoes and less ambient effect than with the settings of Fig. 4.5-b. For more repeats, increase the FEEDBACK; for more prominent echoes, advance OUTPUT MIX.

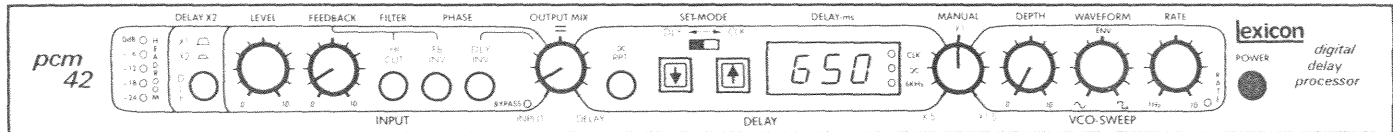

Figure 4.5-d — LONG ECHO

For layering effects, the delayed outputs should be made equal to the direct sound by centering the OUTPUT MIX. Increasing the FEEDBACK will increase the number of layers. These settings only begin to show the layering of which the PCM 42 is capable; see Section 4.2 for further information.

Longer delay times provide a more distinct repetition of the source. The PCM 42 has 2400 milliseconds of delay time available in standard configuration, and up to 4800 milliseconds with the memory option. This corresponds to a reflecting surface a half a mile away!

Recirculating the delayed signal with the FEEDBACK control provides multiple repeats, suggesting an echo-canyon effect. Large amounts of feedback give an artificial 'infinite layering' effect at long delays. (See Section 4.2.)

4.1.2 Double Tracking

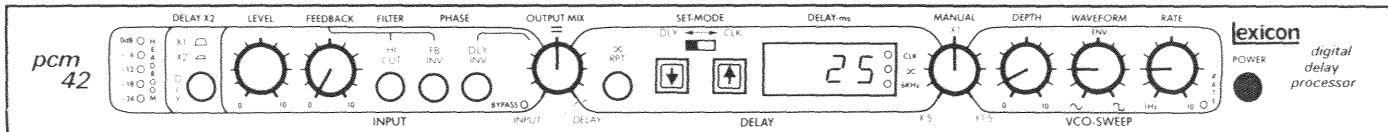

Figure 4.5-e — DOUBLE TRACKING

Doubling is most effective in stereo; feed one channel from the DIRECT output, the other from the MAIN output, and turn the OUTPUT MIX all the way to DELAY. (See Fig. 4.3.)

Doubling, also called automatic double tracking or chorusing, combines original and delayed sound in order to make a single performer sound like two or more. Doubling was originally done with a multitrack tape recorder by having a performer overdub a performance on two or more tracks; when the takes are combined, normal pitch and timing variations between the "identical" performances provide enhancement and thickening. The PCM 42 can of course provide doubling during a live performance — something not practical with tape recorded effects.

Doubling provides the most convincing effect in stereo mode: use the DIRECT and MAIN outputs to feed different tape tracks, console inputs or amplifier/speaker systems, as in Fig. 4.3. If the effect is

done in mono, the amount of delayed sound should not exceed the amount of direct sound in the output mix: set the OUTPUT MIX control between "INPUT" and "=". Delay times in the range of 10 to 60 ms are useful. A small amount of VCO modulation should be used: set WAVEFORM to "SINE" or mix ENVELOPE FOLLOWER and SINE, then bring DEPTH up very slowly until there is a noticeable vibrato in the output. Back off again until the vibrato subsides to a subtle enhancement, then adjust RATE for the desired effect.

Short doubling times, coupled with some feedback and somewhat exaggerated sweep provide the "rotary speaker" effect, which is more exaggerated than simple doubling.

4.1.3 Flanging

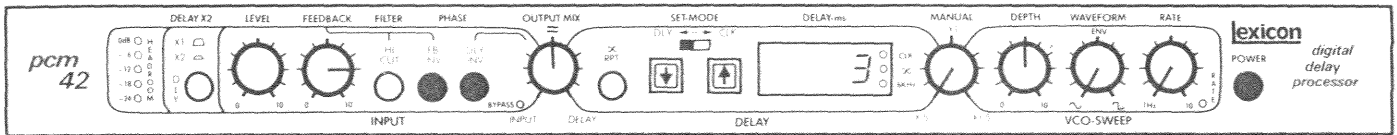

Figure 4.5-f — FLANGING

The delay should be set initially with the DEPTH control fully counterclockwise. This effect will be most pronounced on sound with rich harmonic content — those with reedy timbres or complex chords. Possible variations include changing FB INV, FEEDBACK, and all VCO-SWEEP controls.

The classic sweeping flange effect was produced by recording the same program on two tape recorders and mixing their output while slowing them alternately. In effect, a short delay time (1 - 20 ms) is mixed with the direct signal and the delay time is varied continuously. This causes cancellations of narrow frequency bands, called nulls, to sweep across the various components of the program input. Different harmonics are boosted or cut in relation to each other, causing the tone of the input to change in a characteristic way.

A variation occurs if the polarity of the delayed signal is inverted with respect to the input signal. This causes the nulls to fall only at the odd multiples of the fun-

damental null frequency. This effect is known as a "negative flange".

The flanging effect can be further altered by recirculating the delay signal back to the input. Larger amounts of recirculation, or feedback cause exaggerated "deep" flanges. Phase inversion of the feedback signal gives a characteristic "hollow" sound.

Use of the envelope follower modulation source on the PCM 42 produces an interesting "talking flange"; a sweep is produced for each attack of the input. Envelope and sine wave sweep can be combined for a complex sweep. Square wave modulation may be used to create an unusual effect.

4.1.4 Resonant Effects

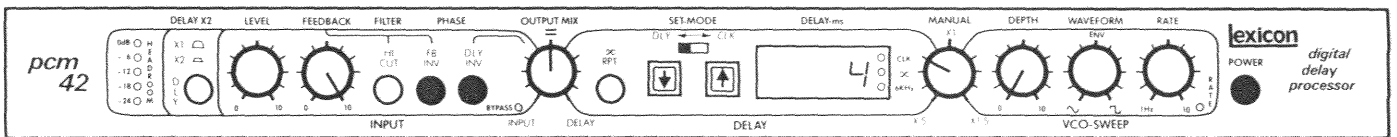

Figure 4.5-g — RESONANCE

A pipe-y single-note resonance whose frequency may be varied in steps (with the delay time pushbuttons) or continuously (with the MANUAL VCO-SWEEP control).

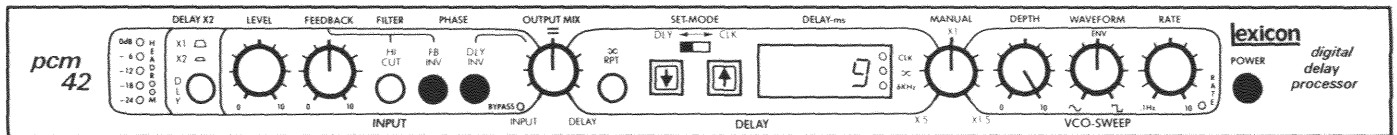

Figure 4.5-h — TALKING RESONANCE

A resonance that varies with signal level. Be sure to adjust the input LEVEL control for full modulation; moderate overload will be taken care of by the PCM 42's soft clipping circuits. (Severe clipping will still produce some unwanted side effects.)

Singing in the shower is one way to obtain a natural, moderate resonant effect. Using the PCM 42 at short delay times with large amounts of feedback causes buildup of fundamental notes and harmonics whose period is equal to the set delay time. The effect is to add a ringing, metallic quality to the sound, especially with percussive inputs. The pitch and tone of the resonance

are affected by the delay time, the amount of feedback used, and the status of the HI-CUT and FB INV pushbuttons. Turning FEEDBACK all the way up and the setting OUTPUT MIX on DELAY, with a delay time of about 12 ms, will create the "Cylon" voice of TV fame.

4.1.5 Vibrato

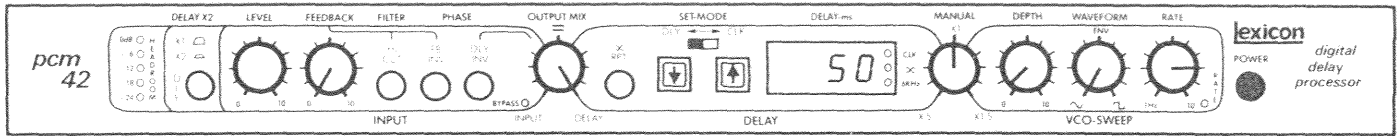

Figure 4.5-i – VIBRATO

The DEPTH and RATE of the vibrato are controlled with the corresponding VCO-SWEEP controls. Setting the VCO WAVEFORM clockwise produces an interesting “trill” effect.

Vibrato is the effect produced by small, regular variations in pitch. The PCM 42 can create automatic vibrato for any instrument or sound. The DEPTH knob controls the depth of the vibrato, the RATE controls the speed. Use short delays with no feedback, and turn the OUT-

PUT MIX all the way clockwise. Inflections can also be controlled manually by the MANUAL VCO-SWEEP control, or by an external foot controller connected to the VCO jack.

4.1.6 Pitch Twisting

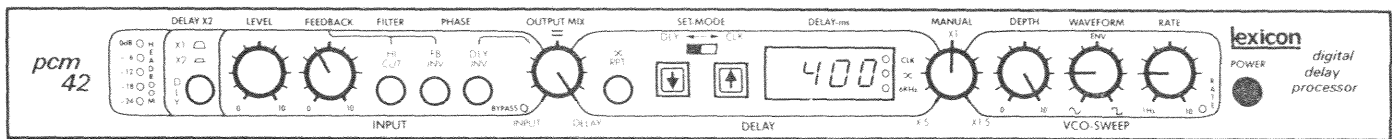

Figure 4.5-j – PITCH TWISTING

Radically altered swept pitches completely transform any instrument into something totally alien. For less extreme effects, turn down the DEPTH control.

When an audio delay line is modulated, as by the VCO-SWEEP section of the PCM 42, a transient shift in pitch occurs that is proportional to the rate of change in delay time. The effect is analogous to the acoustic effect known as Doppler shift. The use of larger amounts of sweep at longer delay times produces exaggerated bends in pitch which can be used for very odd special effects. With the settings shown in the figure, the shift follows the waveform of the modulation. The amount of shift for a given setting of DEPTH increases with the amount of delay selected by pushbuttons. The use of waveforms such as envelope follower, square wave or

rapid sine wave can produce some very unusual sounds, indeed.

The VCO control jack on the rear panel may be used to inject any synthesizer waveform into the unit, provided the range of the waveform is 0 to +10 volts. Many unique effects can be produced using common synthesizer functions such as sample-and-hold, sequencer, pitch follower, envelope generator, or audio oscillator. Pitch Twisting may also be controlled manually by the MANUAL VCO SWEEP knob or by the use of a foot pedal plugged into the VCO jack.

4.1.7 Stereo Image Placement

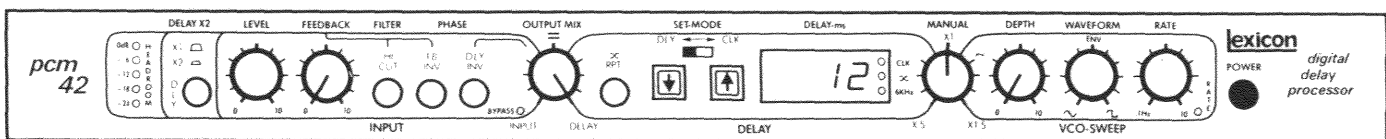

Figure 4.5-k – STEREO IMAGE PLACEMENT

Delaying the right output causes the sound source to shift to the left. Adjust the delay between about 6 and 30 ms to achieve the desired degree of shift.

The prevalent technique for placing the image of a source within a stereo sound field is to pan the signal from left to right, relying on the amplitude difference between the channels to create the perceived image position. But certain advantages can be realized by using delay in conjunction with, or even in place of, conventional panning. Imaging by means of level differences alone works well only for listeners located midway between the two loudspeakers; at off-axis locations, the image shifts toward the loudspeaker from which the sound arrives first, a psychoacoustic phenomenon known as the Haas effect.

The Haas effect arises from the brain's ability to identify similarities between sounds arriving at the ears at different times. Any sound sufficiently similar to one which arrived at the ears within the previous 30 milliseconds will be perceived as a reflection of the original, and the brain will localize the source as coming from the direction of the first arrival. The greater the delay between the two arrivals, the more the source's apparent location shifts toward the first one.

The Haas effect can be transformed from a problem into an asset by using it in a controlled way to shift the apparent position of a sound source in the stereo field. With the PCM 42 connected in the Basic Stereo Setup as shown in Fig. 4.3, simply adjust the delay to achieve the desired degree of apparent offset of the sound source. Delaying the sound in the right channel will cause the source to shift to the left, and vice versa. Delay times of 5-30 ms are most useful; above 30 ms, the delayed sound begins to be perceived as a separate echo, destroying the effect. (For additional information

on this subject, consult Lexicon Application Notes AN-2 and AN-3.)

4.2 SPECIAL APPLICATIONS OF LONG DELAY

4.2.0 Introduction

The class of musical applications for long delay (greater than one second) is somewhat distinct from the applications discussed above. These are closely akin to results obtained with tape loops, but the special qualities of digital delay and the unique features of the PCM 42 allow much greater freedom than is attainable with tape, even without the PCM 42's obvious advantages over a couple of high-quality open-reel recorders in compactness, ruggedness and cost. Many techniques previously confined to home or studio can now be used in live performance.

In general terms, the use of very long delays in music produces a type of "canon" or polyphonic effect by superimposing the audio image of previously performed phrases over current material. With no feedback, only one previous phrase will be audible, but if feedback is added, each delay period will repeat more than once before it dies away. With large amounts of feedback, the performance will pile up, one phrase over another, until input to the delay line ceases or the unit is placed into the infinite repeat mode. At full feedback and maximum delay time (with the optional memory extension) the decay time of the PCM 42 exceeds 3 minutes!

4.2.1 Layering and the Infinite Repeat Mode

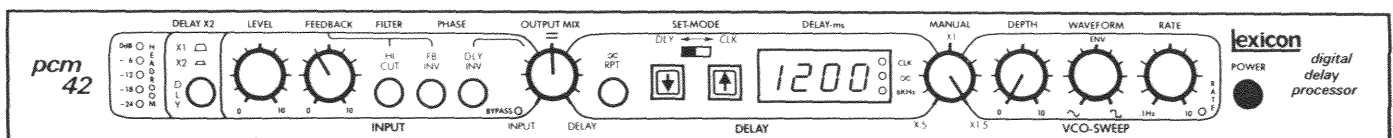

Figure 4.5-1 — CANON

This option begins to make use of the multilayering potential of the PCM 42. The delay time should be set at the maximum available; for machines with the memory option, the MANUAL VCO-SWEEP control will be at about 10:30 o'clock.

Using this overlay technique, it is possible to create compositions and rhythmic beds in real time that can be trapped via infinite repeat, or continuously evolved by adding new notes as older ones are fading out. When the repeat function is used, the resulting backgrounds may be soloed over without entering the notes into the delay loop.

It is important to be aware of the nature of the Infinite Repeat function in the PCM 42 in order to make full usage of the looping technique. WHEN THE INFINITE REPEAT MODE IS ACTIVATED, THE FULL MEMORY IS ALWAYS UTILIZED. The length of the segment captured in memory is independent of the delay tap selected by the UP and DOWN pushbuttons. It is af-

ected ONLY by the setting of the VCO-SWEEP controls and the DLY X2 pushbutton.

NOTE: Be sure to keep the DEPTH control all the way down (counterclockwise) for all applications described in this section.

In working with long loops, the delay tap should be synchronized to the period of the infinite repeat loop, i.e. to the total length of the available memory. The following procedure will achieve this:

1.) SET THE DELAY TIME TO THE MAXIMUM AVAILABLE. Press the UP pushbutton and hold it down while pressing DOWN. In about 5 seconds time, the display will "top out" at the maximum delay time for the present sampling rate. Now release the two buttons (DOWN first, then UP; otherwise the setting will back up one or two steps from maximum). The segment length is now exactly equal to the delay time as displayed on the front panel.

2.) ADJUST THE MANUAL VCO-SWEEP CONTROL TO AN EVEN VALUE OF DELAY. If your PCM 42 has no memory option, a value of 800 will occur near the center of the control's travel; with the memory option, the value will be 1600.

3.) SET THE DELAY TIME TO AN EVEN DIVISOR OF THE MAXIMUM. For one echo return per memory cycle, leave the SET-MODE switches as they are. For two returns, change the setting to 400 (800 with memory option); for four returns, 200 (400 with memory option), and so on.

4.) ADJUST THE MANUAL VCO-SWEEP CONTROL FOR THE DESIRED TEMPO. Now that the delay time and the length of the INFINITE REPEAT loop are synchronized, you may change both together by adjusting the MANUAL VCO-SWEEP control. The decaying echoes will remain in synchronization as the sampling rate is varied.

A very useful technique with the infinite repeat is to get a basic line or part trapped into the memory, then turn feedback up full clockwise. When the infinite repeat is released, the looped segment does not die away immediately, but continues to repeat due to the high degree of regeneration used. (Be sure you have set the segment length as described above.) While in this state, new notes, rhythms, or lines may be added over the old. Then if the unit is placed once more into repeat mode, both the old and new parts will be heard. This technique would not be feasible except for the superior qualities of Lexicon's special encoding circuitry, which contribute very little audio degradation to a recirculated signal.

4.2.2 Looping Techniques for Live Performance

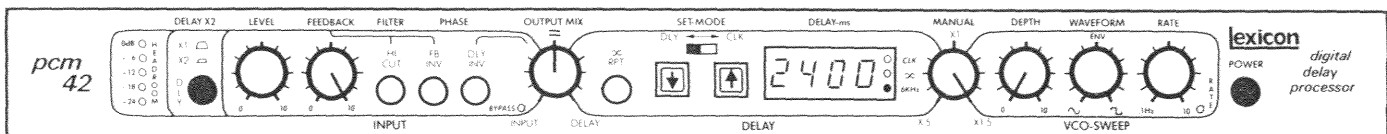

Figure 4.5-m — LONG DELAY LOOP

This is a more extended form of the setup in Fig. 4.5-l, with many layers. Sound can be captured in INFINITE REPEAT mode; when this mode is turned off, new layers can be added to the sound and the composite put back in INFINITE REPEAT. For instructions on how to synchronize the beginning of the measure to the beginning of the repeat cycle, see below.

Once the procedure described in Section 4.2.1 has been carried out, the delay times will be synchronized with the length of the INFINITE REPEAT loop. There remain two potential barriers to the maximally effective

use of this facility: how to synchronize the beginning of a measure with the start time of the loop, and how to establish tempo within a repeated loop that is too long to count reliably.

Many performers who have made use of tape looping have compensated for this problem by using a slow, arrhythmic style with long attack times, or simply limited their usage of loop techniques to the studio. A few have developed elaborate means of measuring the delay time in a tape loop. All of these strategies have sharp limitations in application. Another problem is the nature of the splice created by entering infinite repeat. Without elaborate and expensive special processing, the instantaneous transition in voltage that occurs at the splice in an infinite repeat loop often produces a sharp "tick" which is repeated once per cycle of the loop.

All these problems have been addressed in the PCM 42 by a highly novel programmable metronome/clock output. THIS CLOCK IS SYNCHRONIZED TO THE LENGTH OF THE INFINITE REPEAT LOOP, BUT AT A SELECTABLE FRACTION OF THAT LENGTH. For the 2.4-second loop in Fig. 4.5-m, the clock may be programmed to provide 4 or 8 output pulses during the period of the delay, giving intervals of 0.6 and 0.3 seconds, either of which can be easily followed. The clock pulses are displayed by an LED on the front panel, or may be taken from the CLOCK OUTPUT jack on the rear panel and amplified as an audible metronome. And since the clock rate is adjustable independently of the delay time, this output may also be adjusted to a more rapid pulse rate and used to drive external rhythm units.

THE INFINITE REPEAT FUNCTION IS SYNCHRONIZED TO THE CLOCK PULSES. THE MACHINE ENTERS OR LEAVES INFINITE REPEAT ONLY ON THE BEAT OF THE METRONOME, REGARDLESS OF WHEN THE CONTROL IS ACTIVATED. Synchronization between the music and the starting point of the repeat loop can be achieved by watching or listening to the clock pulse. Once the clock rate is adjusted properly, a composition may be begun with the confidence that the end point of the first repeated loop will occur an exact number of measures after the opening note. Furthermore, any splicing glitches that occur at the end of the loop will fall exactly on the beat, where they are most effectively masked. For detailed instructions in the programming and interfacing of the clock output, see Section 4.3 below.

The two audio control jacks on the rear panel (MIX CONTROL and FB CONTROL) are also very effective tools for use in looping. Connected to Lexicon foot pedals by means of a stereo phone plug, these jacks allow foot control over the level of delayed audio in the output mix, and the amount of feedback in the loop. With the MIX CONTROL, the user can set up loops that are faded in and out at appropriate points in the music; this can be especially effective if a tight synch to the metronome/clock is maintained. The FEEDBACK CONTROL jack provides a convenient means to clear out the loop in preparation for new material.

4.3 PROGRAMMING AND USING THE METRONOME/CLOCK OUTPUT

4.3.1 Setting the Clock Rate.

In order to set the rate of the Clock Output, first locate the SET-MODE switch on the front panel [Fig. 2.1, K]. When this switch is moved to the CLK position, the 4-digit display of delay time is replaced by a two- or three-digit display with blank spaces in between. This display is read as a fraction of the delay memory size. For instance, on power-up this display is set to read "1 2". This should be read as the fraction "1/2" and implies that the period of the clock is equal to one-half of the delay time obtained by advancing to the maximum value settable by the UP and DOWN pushbuttons.

A brief experiment will make this concept clear. Slide the SET-MODE switch to the left-most (DLY) position and quickly advance to maximum delay (press UP and hold it while pressing DOWN and hold until the display stops changing; release DOWN, then UP). The number now displayed is the maximum delay time for the current sampling rate. It is also the length of any Infinite Repeat segments that might be captured, and the time against which the Clock Output rate is referenced.

Assuming that the clock ratio has not been changed since the unit was turned on, the red CLK indicator flashing at the upper right corner of the display window will be flashing at an interval equal to one-half the time in milliseconds displayed in the window. If the display reads "1600 ms", the CLK lamp will flash every 800 milliseconds. Each flash of this lamp is accompanied by a pulse at the CLOCK OUTPUT jack on the rear panel. Since this rate is a fraction of the total available delay time, it is NOT affected by the UP and DOWN pushbuttons, but only by the MANUAL VCO-SWEEP control [Fig. 2.1, R] and the DELAY X2 pushbutton [Fig. 2.1, B].

Now we can begin to program the clock rate to different relationships with the memory size. Note the presently displayed delay time (all of the programming to follow is referenced to it) and then slide the SET MODE switch to the "CLK" position. The display will read "1 2". Now, press the UP pushbutton once and release. The display will now read "1 4" and the CLK lamp will flash at twice its previous rate. The clock period is now equal to one fourth of the delay time noted before. Further button pushes will cycle the rate down to 1/64th of the loop length, and then around to 1/1, equal to the loop length. If the button is held down, the display steps automatically about once per second.

Now try the DOWN pushbutton. The left portion of the display is stepped through the odd integers 1, 3, 5, 7, and 9. These select the numerator of the fraction, such as 3/2, 5/8 etc. These ratios are useful for poly-rhythmic work. Most of the time, however, the figure

desired here is "1". Experiment with this button, observing the rate of the CLK lamp, then return to a value of "1" when finished.

Another way to think of the clock ratios is in terms of musical notation. If the delay memory size is considered to be equal to one bar of music, then the clock intervals may be expressed in the familiar forms of half-notes,

quarter notes, eighths, etc. The different values for the numerator of the fraction can be considered to be ties between notes. For instance, the clock ratio "1/2" can be expressed as in Fig. 4.6-a and a value of "1/4" as in 4.6-b. The ratio "3/16" is depicted as three sixteenth notes in Fig. 4.6-c. In actual practice, the loop length will often be equal to two, four, or eight measures. Simply expand the note values to fit the context of tempo.



	CLOCK PULSES	CLOCK SETTING
(a)		1 / 2
(b)		1 / 4
(c)		3 / 16

Figure 4.6 — THE MUSICAL VALUES OF SELECTED CLOCK RATIOS

One measure represents the length of the maximum available delay time; the notes or ties span the length of the interval between clock pulses.

4.3.2 Interfacing the Clock with Rhythm Machines.

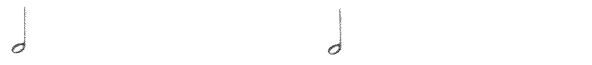
The Clock Output may also be used as a clock signal for many types of sequencers and electronic rhythm units. Most models of synthesizer sequencers provide an external clock input. All that is needed in most cases is to patch the PCM 42 CLOCK OUTPUT jack to this external clock. Some models (e.g. Moog) use 1/4" phone jacks and some (Arp, Oberheim) use 1/8" mini-phone jacks. In a few cases, the +5 volt output of the PCM 42 will need to be boosted in order to provide enough signal for the sequencer. Consult the manufacturer's literature if you have any problems.

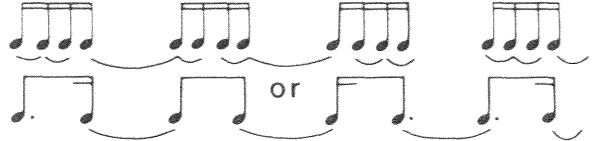
Once the user's sequencer is connected to the PCM 42, the CLOCK OUTPUT may be programmed to drive the sequencer at the rate desired. If the sequence output is now fed through the PCM 42, it will be found that the note intervals synchronize perfectly into the delay loop length. By using FEEDBACK and INFINITE REPEAT, a very tight, locked-in feeling can be obtained. If the sequence or rhythm pattern is played back

without processing, and a lead or rhythm instrument is played through the PCM 42, the instrument can be used like another sequencer in parallel with the first. Working in this fashion, and with the loop techniques described in Section 4.2, some remarkable textures and effects can be generated.

The Clock Output may also be interfaced to ANY automatic drum unit which provides an external clock input. A number of lower-cost units do not provide this feature, but in many cases it is possible to modify the unit slightly to accommodate it. Consult the manufacturer for information. In many cases, the unit will be set up to operate with an odd subdivision of the meter such as 24 or 48 clock pulses per quarter. This is not a problem providing that the PCM 42 clock input is also used during the programming of the beat. All that will be lost is some of the triplet divisions of time. In programming rhythms on a system set up in this fashion, it is useful to first program a kick drum beat at the quarter note rate to establish the bar length. Then enter the rest of the rhythm, erasing the initial reference beat if necessary.

The usage of long delay times is a highly individual matter, involving as it does issues of composition and performance. Only experience can reveal the depth of possibilities and what they mean for you as an artist. Lexicon would be very interested to hear from users about their experience with these techniques and the implications of synchronized loops. If you would like to communicate with us, send letters and/or tapes (cassette is always easy, but other formats are welcome) to:

42 Applications
 Lexicon, Inc.
 60 Turner St.
 Waltham, MA 02154

All communications, tapes in particular, will be held in strictest confidence unless specifically released by the contributor. We look forward to hearing from you, and Good Playing!

4.4 INTERFACING TO OTHER UNITS

The PCM 42 provides a comprehensive set of input and output points to allow connection to another PCM

42, to other Lexicon products, or to signal processors such as equalizers. Figs 4.7 - 4.11 illustrate the most common connections.

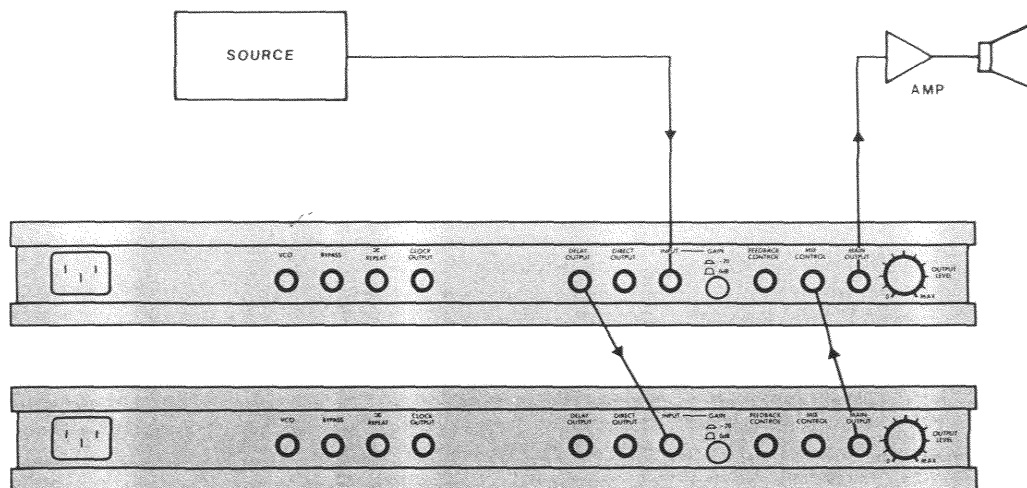

Figure 4.7 – SERIES CONNECTION OF TWO PCM 42s

Processed sound from one unit feeds the second. A typical use would be to add chorusing and then flanging.

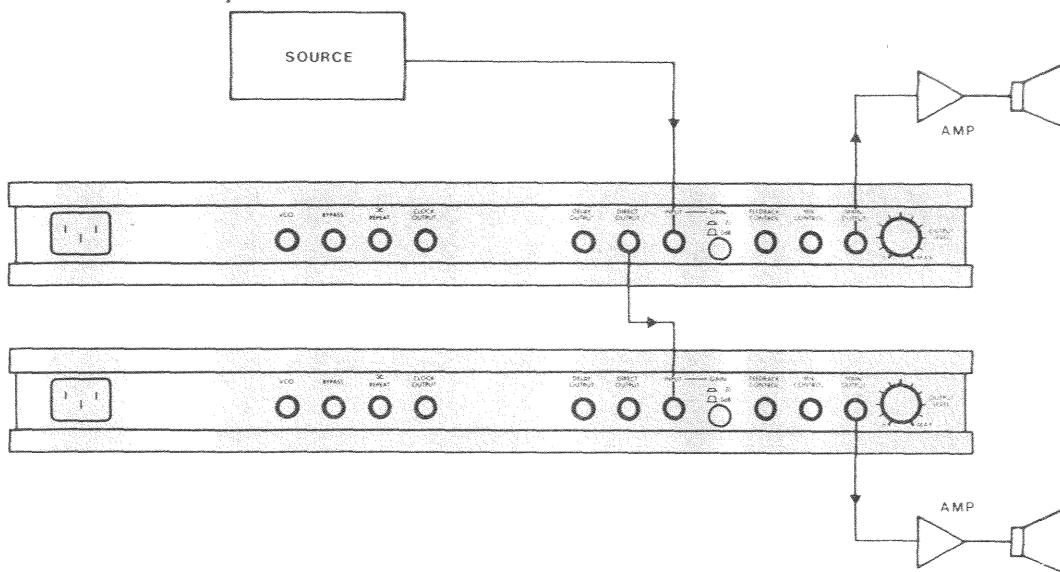

Figure 4.8 — PARALLEL CONNECTION OF TWO PCM 42s

The same unprocessed input feeds both units. The MAIN OUTPUTS are sent to the two channels of a stereo recording or PA system for such effects as stereo chorusing.

Connecting the two outputs in parallel allows deeper flanging than any single delay line can provide. On BOTH machines: dial in 6 ms of delay, set FEEDBACK all the way CCW and MIX all the way CW. On ONE

machine: push DLY INV and set DEPTH, WAVEFORM and RATE as in Fig. 4.5-f. Adjust OUTPUT LEVELS for desired depth of flange.

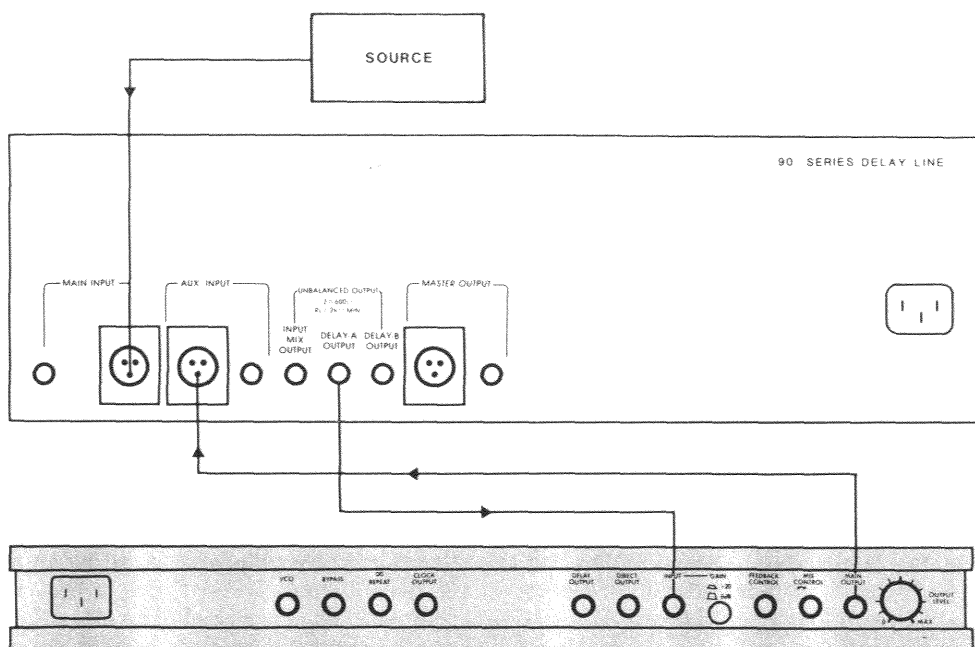

Figure 4.9 — CONNECTION OF PCM 42 WITH LEXICON 90-SERIES DELAY LINES

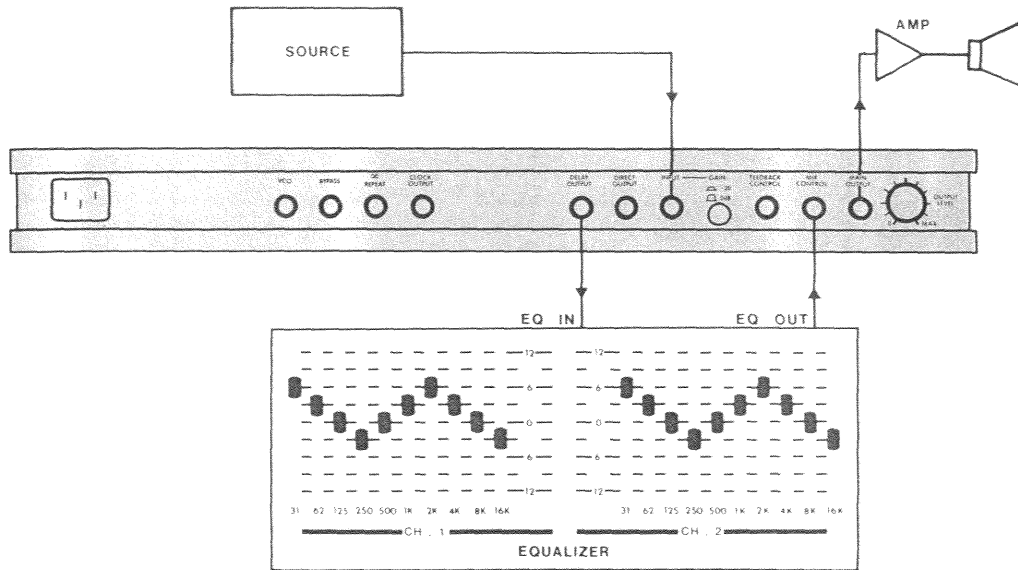

Figure 4.10 — CONNECTION OF PCM 42 WITH EQUALIZED OUTPUT

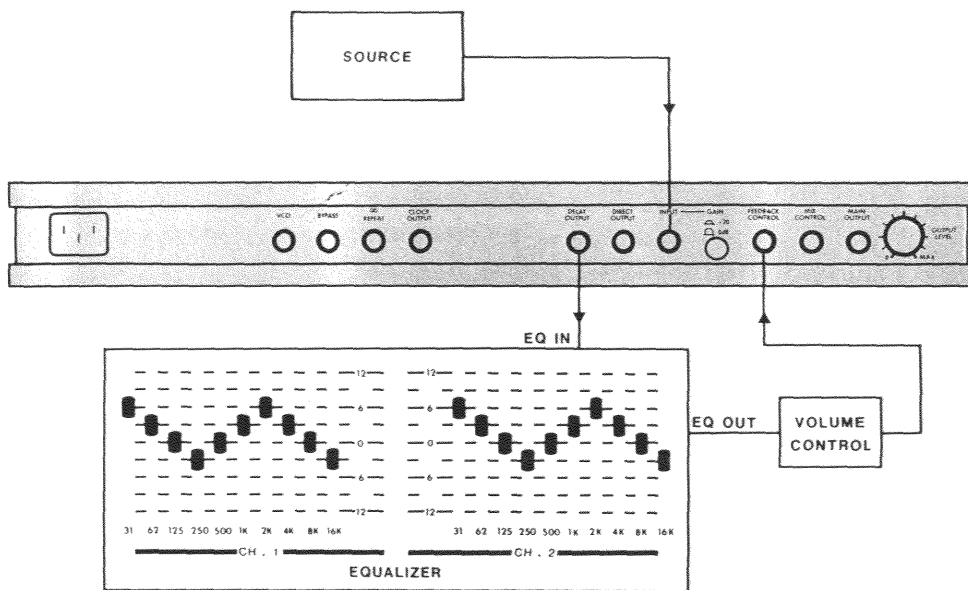

Figure 4.11 — CONNECTION OF PCM 42 WITH EQUALIZED FEEDBACK

4.5 DELAY LINES IN DISTRIBUTED SOUND REINFORCEMENT SYSTEMS

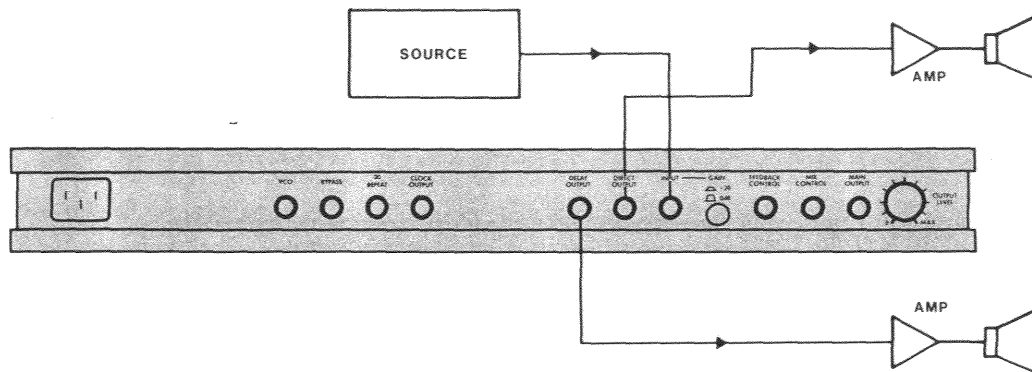

Figure 4.12 — SOUND REINFORCEMENT WITH ONE REMOTE ZONE OF SPEAKERS

The delay for the remote speakers in milliseconds should be equal to the distance of the listener from the main speakers (in feet), minus his distance from the remote speakers, times 0.885, plus 20.

In sound reinforcement systems, delay lines can be used not to create echoes but to eliminate them. Time delay cannot help reflections from walls or ceilings, but it can be used to avoid the confusion that results when the sound arrives at the listener from different loudspeakers at different times.

Ideally the sound from a reinforcement system should arrive at each listener first from a main cluster of speakers over or near the stage, and then, between 5 and 30 milliseconds later, from any other auxiliary speaker(s). This can be achieved by connecting the PCM 42 as shown in Fig. 4.12 and dialing in the proper amount of delay. Use the DLY X1 setting for full bandwidth.

The correct amount of delay for a given setup may be calculated exactly with the algorithm given in Lexicon

Application Note AN-2, "Application of Digital Delay Units to Sound Reinforcement." The general principle is to calculate the difference in path length to the listener from the main and remote speakers in feet, multiply the result by 0.885, and add 20. The result is the number of milliseconds of delay required for the remote speakers.

As an example, suppose that the remote speakers are 100 feet closer to the listener than the main cluster. The required delay for the remotes would be $88.5 + 20 = 108.5$ ms. All speakers with the same path length difference may be fed from a single delay; speakers whose distance differs by more than about 40 feet must be fed from a separate delay line (or tap) and a separate power amplifier.

SECTION FIVE BLOCK DIAGRAM

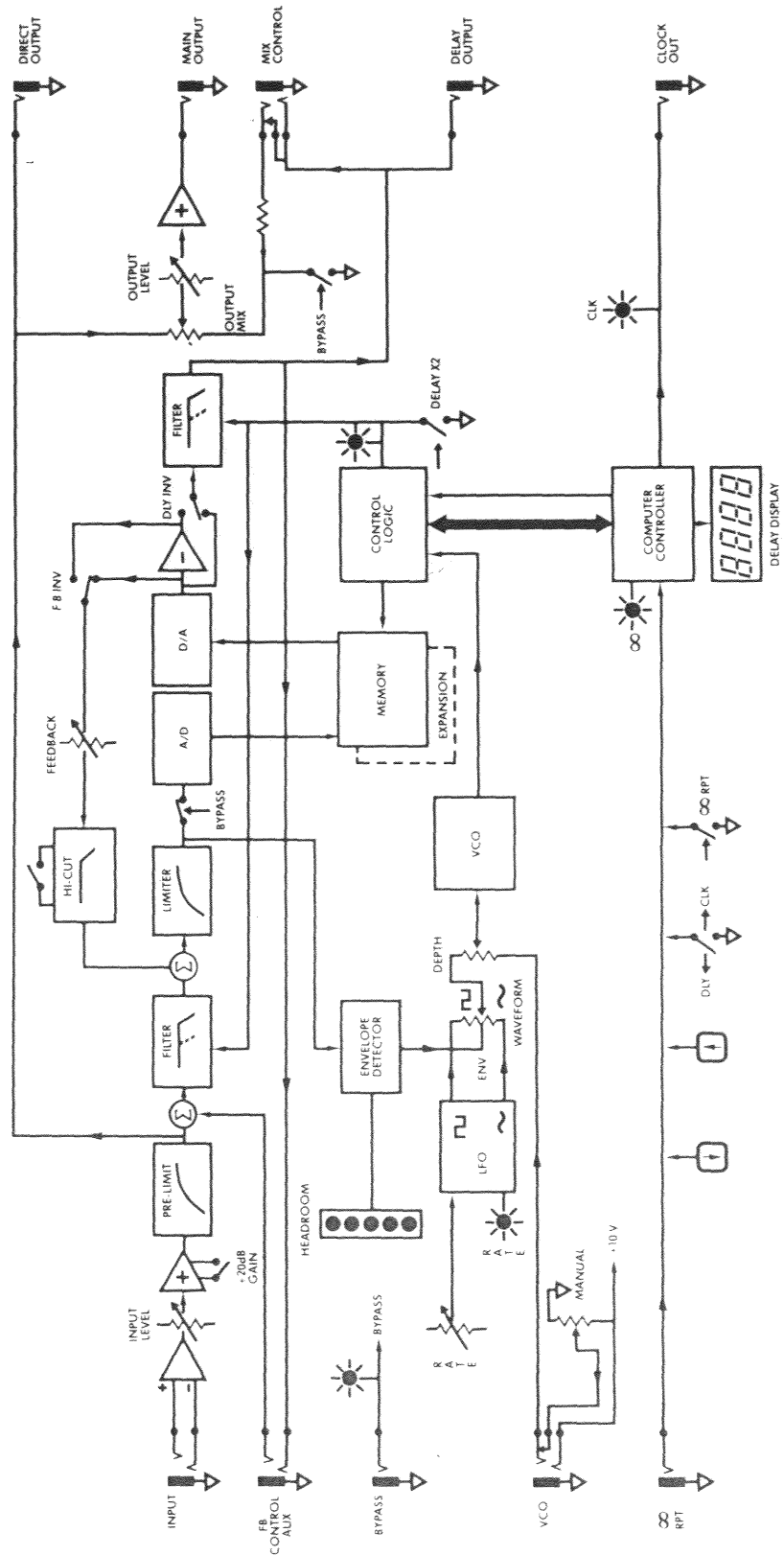

LEXICON PCM 42

SECTION SIX SPECIFICATIONS

6.0 TEST CONDITIONS

Unless otherwise stated, all measurements are performed with the unit operating at room temperature, in 16 kHz mode, with the VCO-SWEEP, MANUAL control set to X1.

Unless otherwise stated, all audio measurements are taken with the input and output levels set as follows: with a 1 kHz sine wave input at a level of 0 dBm, adjust the INPUT LEVEL control for 0 dBm out from the DIRECT OUT jack. With the OUTPUT MIX control on the front panel set fully clockwise, adjust the OUTPUT LEVEL control on the rear panel for 0 dBm out from the MAIN OUTPUT jack.

6.1 GENERAL PERFORMANCE

Total Distortion and Noise

0.06% typical, 0.1% maximum @1 kHz, +9 dBm input
0.2% typical over bandpass of 20 Hz to 15 kHz.

Frequency Response

10 Hz to 16 kHz, +0.5 dB, -3 dB in X1 mode
20 Hz to 6 kHz, +0.5 dB, -3 dB in X2 mode

Dynamic Range

Better than 90 dB, 20 Hz - 20 kHz noise bandwidth.

Delay capacity

Standard Memory:

16 kHz mode:

MANUAL VCO-SWEEP = X0.5; 400 milliseconds
= X1.5; 1200 milliseconds

6 kHz mode:

MANUAL VCO-SWEEP = X0.5; 800 milliseconds
= X1.5; 2400 milliseconds

Extended Memory:

16 kHz mode:

MANUAL VCO-SWEEP = X0.5; 800 milliseconds
= X1.5; 2400 milliseconds

6 kHz mode:

MANUAL VCO-SWEEP = X0.5; 1600 milliseconds
= X1.5; 4800 milliseconds

Delay selection

Two delay ranges - X1 and X2 - each providing 256 selectable delay taps. All delay taps are adjustable over a 3 to 1 range using the VCO-SWEEP, MANUAL control.

Delay Step Size

Evenly spaced over the selected delay range; e.g. 800 ms range, step size is approx. 3 ms.

Delay Display

Delay time is indicated by a four-digit numeric display which tracks all delay sweeps.

Display Accuracy

Plus or minus 1 millisecond for settings up to 200 ms; 0.5% for settings between 200 ms and maximum delay.

VCO Modulation

Depth is adjustable from 0 (none) to full 3:1 sweep of delay time. Low Frequency Oscillator rate is adjustable from 0.1 Hz to 10 Hz and is displayed by a RATE LED indicator.

VCO Modulation Waveform

Continuous adjustment is available between Sine Wave and Envelope Follower or Square Wave and Envelope Follower functions.

6.2 INTERFACE INFORMATION

Input Type

Balanced differential input, via standard 1/4" Tip/Ring/Sleeve phone jack, offers 40 dB common mode rejection. Will also accept unbalanced input.

Input Impedance

Balanced or unbalanced; 40 kilohms impedance.

Input Level

With adjustable INPUT LEVEL control and 20 dB GAIN switch on rear panel, maximum input levels of from -12 dBV to +20 dBV (0.25 V to 10 V rms) can be accommodated (0 dBV = 1.0 volts rms).

Input Limiting

The main input is subject to two step compression/limiting. Between preamp/mixer and anti-aliasing filter is a compression stage with a threshold at +9 dBV and a compression ratio of 5:1. Between the filter and the sample-and-hold, there is a limiter with a threshold at +12 dBV.

Auxiliary Inputs (See also Remote Jacks)

Two audio control jacks function as secondary input points. The tip portion of the Feedback Control Jack is mixed at unity gain with the main input signal, after the compression stage but before the anti-aliasing filter and limiter. This input has an impedance of 20 kilohms. The tip of the Mix Control Jack connects to the CW side of the OUTPUT MIX control.

The normal connection of delayed audio is broken when a 1/4" phone plug is inserted in this jack. Input impedance is 30 kilohms.

Output Type

The Main, Direct and Delay outputs are unbalanced, and have standard 1/4" Tip-Sleeve phone jacks. The delayed signal is also available at the Ring portion of the Recirculation and Mix control jacks.

Output Impedance

Main Out: 100 ohms actual source impedance.
Direct & Delay Out: 600 ohms actual source impedance.

All outputs are intended for driving high impedance loads, but are operable with loads as low as 600 ohms.

Output Level

Main Output: +18 dBV (9 V rms) maximum. Will drive loads of 2 kilohms or greater at full level. An Output Level control varies the output level.

Direct Out: Varies with system level. This output is compressed, but not limited. Nominally +12 dBV at limit point.

Delay Out: Varies with system level. Limited to +12 dBV

Remote Jacks

Rear panel 1/4" phone jacks accommodate external switches and controls as follows:

FB Control: When connected by a stereo phone plug to Lexicon A-41-CP Foot Pedal, allows external control of recirculation

Mix Control: Allows control of delay volume level in main output with Lexicon Foot Pedal.

Clock: This is a TTL level timing pulse that is synchronized to the Infinite Repeat interval. This may be used to cue a musician or clock an external sequencer or rhythm unit.

Bypass: When the Tip and Sleeve of the (mono) phone jack are shorted together, the PCM 42 is placed in bypass mode.

Infinite Repeat: When the Tip and Sleeve are momentarily shorted, the PCM 42 captures a segment of the input and holds it in repeat mode. A subsequent momentary contact of Tip and Sleeve releases the segment, returning the unit to normal operation.

VCO: This stereo phone jack may be connected either to a potentiometer or to a voltage source; whenever a plug is inserted in the jack, the MANUAL VCO SWEEP control is replaced by the external control. For control by a voltage source a range of 0 to +10 V is required.

6.3 CONTROLS AND INDICATORS

Mixing Controls

Level: Rotary control sets level of signal from the main input.

Feedback: Rotary control set level of delay output mixed into the input signal.

HI CUT: Switch inserts single pole low pass filter at 4 kHz cutoff into feedback path.

FB INV: Switch inverts the phase of the delayed signal fed to input.

DLY INV: Switch inverts the phase of the delayed signal fed to the output.

Output Mix: Rotary control sets blend of direct and delayed signal at Main Output.

Modulation Controls

- Manual VCO-Sweep: Sets sampling rate.
- Depth: Sets amount of internal delay sweep.
- Waveform: Sets mix of modulation waveforms
- Rate: Sets frequency of internal low frequency oscillator.

Headroom Indicator

5 LEDs display input in 6-dB steps. "0 dB" is the point at which the input is limited.

Bypass Indicator

Single LED, indicates the unit has been placed in the bypass state from the rear panel.

Clock Indicator

Single LED, flashes in time with clock output.

6 kHz Indicator

Single LED, indicates unit is in extended delay mode.

Infinity Indicator

Single LED, indicates that an audio segment is trapped in delay memory.

Rate Indicator

Single LED, flashes in time with LFO output.

6.4 POWER AND DIMENSIONS

AC Requirements

115 or 230 volts (selectable), 50-60 Hz, 20 watts maximum. Standard IEC power connector on rear of unit; 3-prong cord provided.

Protection

Mains are fused (standard U.S. 3AG fuses).

Export Models — Mains and secondaries are fused (European 20mm fuses). An RFI power line is also installed. NOTE: a 100-Volt export model is available on special order.

Dimensions

Standard 19" relay rack mount (483 mm). 1 3/4" high (44mm) by 11" deep (280 mm).

Weight

Net 5.5 lbs (2.5 kg); shipping 8 lbs. (3.6 kg).

SECTION SEVEN IN CASE OF DIFFICULTY

7.1 GENERAL

Before you attempt to verify whether there is a genuine problem with the unit, it is important that you understand the operating and installation information presented in this manual.

WARNING

ALL SERVICING OF THE PCM 42 SHOULD BE PERFORMED BY QUALIFIED SERVICE PERSONNEL. THERE ARE HAZARDOUS VOLTAGES LOCATED UNDER BOTH THE TOP AND BOTTOM COVERS OF THE UNIT. TO AVOID ELECTRICAL SHOCK, REMOVE THE POWER CORD PRIOR TO REMOVING COVERS. SERVICING PROCEDURES CONSISTENT WITH GOOD SAFETY PRACTICES SHOULD BE USED AT ALL TIMES.

7.2 UNIT WILL NOT POWER UP

If the PCM 42 will not power up, first check the AC line cord to ensure it is securely plugged into the PCM 42 and the service outlet. Then verify the service outlet is "live" and that the voltage is correct for the PCM 42 (use a voltmeter, neon test light, or a common lamp). If correct voltage is present, unplug the PCM 42, and refer the problem to a Lexicon authorized service technician, or return the unit to Lexicon (see Section 7.5).

7.3 UNIT POWERS UP, GIVES IMPROPER DISPLAY

The numeric display of the PCM 42 should always read either the delay time in milliseconds or the fractional ratio of the clock output period to the delay time. An incorrect display indicates a problem with the microprocessor section of the unit. Refer the problem to a Lexicon authorized service technician, or return the unit to Lexicon.

7.4 UNIT POWERS UP, BUT WILL NOT PASS AUDIO

Check Cables

Check all audio cables to be sure they are securely plugged into the proper jacks. If the connections are good, check the cables themselves. Look for continuity and shorts between conductors while flexing the cable to check for intermittent contacts.

Check Other Sound Equipment in System

If all cables are good, the next step is to check the rest of the equipment in the sound system to ensure it is indeed operating properly. Unplug the PCM 42 MAIN OUTPUT cable at both ends, and set it aside. Then unplug the cable from the PCM 42 INPUT, and instead connect it to the point which had been fed by the PCM 42's output. This bypasses the PCM 42 entirely. If the audio now passes through the sound system, the problem resides in the PCM 42; if audio still does not pass, there is a problem elsewhere, and probably not in the PCM 42.

Check PCM 42 Control and Switch Settings

Be sure the rear-panel OUTPUT LEVEL control is set properly. In its full counterclockwise position, this control is capable of completely shutting down the main output. Also, be sure the unit is not in INFINITE REPEAT mode, since it may be "holding" no signal at all.

7.5 RETURNING UNITS FOR REPAIR

If it becomes necessary to return a PCM 42 for service, bear in mind that Lexicon assumes no responsibility for units in shipment from customer to factory whether or not they are in warranty. It is important, therefore, that shipments be well packed, properly insured, and consigned to a reliable agent such as UPS or Federal Air Express. Be sure to include (inside the carton) a note explaining the nature of the problem, referencing any conversation with Lexicon personnel you

may have had. Also, detail the preferred return shipping method, and indicate a date when the unit is again needed. Do not include accessories such as power cords, manuals, and remote switches. It is also important to provide Lexicon with the name and telephone number of a person we may contact should any questions arise.

7.6 REPLACEMENT PARTS

Replacement parts and the service manual may be ordered from:

Lexicon, Inc.
100 Beaver Street
Waltham, MA 02154
U.S.A.
Attn: Customer Service
Telephone: (617) 891-6790
TWX: 923 468

Parts will be shipped F.O.B. Waltham. Charges will be those in effect at the time the order is received. Lexicon may be consulted at any time, during business hours, for a parts quotation.

When ordering parts, refer to the appropriate parts list in the PCM 42 Service Manual, or order by complete description and give the following information:

- A. Part ID number, if available.
- B. Item description (e.g., RATE control knob, etc.)
- C. Quantity desired.
- D. The serial number of the PCM 42, if available.

7.7 LIMITED WARRANTY

Lexicon, Inc. warrants each PCM 42 to be free from defects in material and workmanship for one year, under normal use and service. This warranty begins on the date of delivery to the purchaser or his authorized agent or carrier. During the warranty period Lexicon will repair or, at its option, replace at no charge, com-

ponents that prove to be defective, provided the equipment is returned, shipping prepaid, to Lexicon's factory or designated service facility.

This warranty is null and void under any of the following conditions:

A. Abuse, neglect, alteration, or repair by unauthorized personnel.

B. Damage caused by improper use, or operation from an incorrect power source.

C. Damage caused by accident, act of God, war, or civil insurrection.

Lexicon shall not be responsible for any loss or damage, direct or consequential, resulting from PCM 42 failure or the inability of the product to perform. Lexicon shall not be responsible for any damage or loss during shipment to or from the factory or its designated service facility.

This warranty is in lieu of all other warranties, express or implied, and of any other liabilities on Lexicon's part, and Lexicon does not assume or authorize anyone to make any warranty or assume any liability not strictly in accordance with the above.

Lexicon reserves the right to make changes or improvements in the design and construction of the PCM 42 without obligation to make such changes or improvements to the purchaser's unit. No equipment may be returned under this warranty without prior authorization from Lexicon. Authorized return shipments must be prepaid and should be insured.

System modules being returned for repair/exchange should be wrapped or packed in soft packing material and shipped in an appropriate small protective box. In the case of returning the entire PCM 42, it should be carefully packed in the original carton and packing material. If this is not available, new packing may be procured from Lexicon.