

**BEFORE PROCEEDING WITH COMPLETE UNPACKING AND SETUP,
CONSULT UNPACKING AND INSPECTION INSTRUCTIONS**

model 525

ELECTRONIC CROSSOVER

EFFECTIVE WITH SERIAL NUMBER 896



**UREI Incorporated
8400 BALBOA BOULEVARD
NORTHRIDGE, CA. 91325-4100 U.S.A.
PHONE: (818) 895-UREI (895-8734)
FAX: (818) 891-5475**

JBL PROFESSIONAL

CUSTOMER SERVICE

**8370 BALBOA BOULEVARD
NORTHRIDGE, CA 91329, U.S.A.
PHONE (818) 893-8411
FAX (818) 891-9619**

**Printed in USA
© Copyright 1980, 1989 UREI Inc.**

TABLE OF CONTENTS

	PAGE
<u>SECTION I. INTRODUCTION</u>	
1.1 DESCRIPTION	1
1.2 ELECTRICAL SPECIFICATIONS	2
1.3 PHYSICAL SPECIFICATIONS	3
1.4 CONTROLS AND INDICATORS	4
1.5 CONNECTIONS	5
 <u>SECTION II. INSPECTION AND INSTALLATION</u>	
2.1 UNPACKING AND INSPECTION	6
2.2 ENVIRONMENTAL CONSIDERATIONS	6
2.3 POWERING	6
2.4 LINE VOLTAGE SWITCH	7
2.5 50-60 Hz SWITCH	7
2.6 EXTERNAL CONNECTIONS	7
2.7 IMPEDANCE AND TERMINATION	9
2.8 MODE SWITCH AND LED INDICATORS	9
2.9 FREQUENCY COUNTER (DISPLAY)	10
2.10 EXTERNAL COUNTER INPUT	10
 <u>SECTION III. OPERATING INSTRUCTIONS</u>	
3.1 GENERAL	11
3.2 SYSTEM CHECK	11
3.2.1 WITH INTERNALLY GENERATED TEST SIGNALS	11
3.2.2 WITH PROGRAM MATERIAL OR EXTERNALLY APPLIED TEST SIGNAL	11
3.3 APPLICATION	12
3.4 DOCUMENTATION	12
3.5 LEVEL CONTROLS	12
GRAPHS OF FILTER AND OUTPUT CHARACTERISTICS	13
3.6 PRECAUTIONS	15
 <u>SECTION IV. THEORY OF OPERATION</u>	
4.1 INPUT AMPLIFIER	16
4.2 STATE VARIABLE FILTER/OSCILLATOR	16
4.3 MODE SWITCH	16
4.4 OUTPUT AMPLIFIER	17
4.5 MODE INDICATORS	17
4.6 FREQUENCY COUNTER	17
4.7 POWER SUPPLY	18
 <u>SECTION V. MAINTENANCE</u>	
5.1 GENERAL	19
5.2 REPAIRS AND WARRANTY	19
5.3 SERVICE ADJUSTMENTS	20
5.3.1 COMMON MODE BALANCE	20

	PAGE
5.4 IN CASE OF DIFFICULTY	20
5.4.1 GENERAL	20
5.4.2 PRECAUTIONS FOR TROUBLESHOOTING	20
5.4.3 VISUAL TEST	20
TROUBLESHOOTING CHART (TABLE 5-1)	21

SECTION I
INTRODUCTION

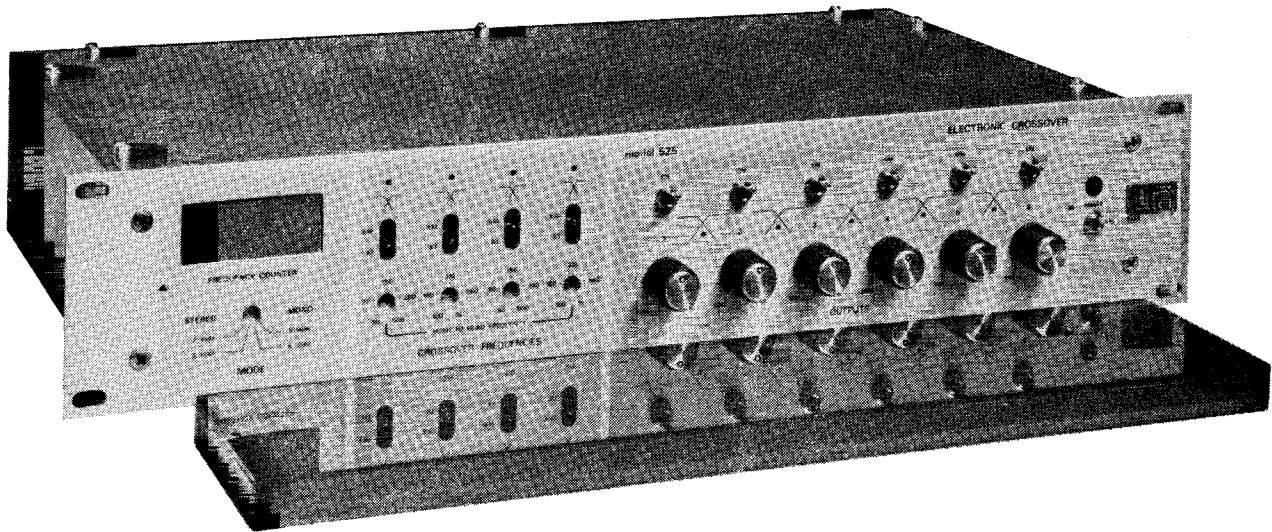

FIGURE 1-1. MODEL 525 FRONT PANEL.

1.1 DESCRIPTION

The Model 525 Electronic Crossover was designed with the versatility required for use in professional sound systems. Whether in a fixed installation or a portable system, it provides the frequency bands and signal levels necessary for well balanced multi-level amplification. The Model 525 is an ideal choice for such applications as studio monitoring, live concert systems, discotheques, and sound reinforcement in theatres, churches and schools.

A unique feature of the Model 525 is the built in frequency counter, which provides an accurate display of the actual crossover frequency during adjustment. Whenever the frequency adjust control of any of the four crossover filters is depressed, the filter will oscillate at the frequency to which it is tuned. The counter measures and displays this frequency with a resolution of 1 Hz. Simultaneously, this signal is reproduced at a low level through the sound system as an additional aid for tuning. With a simple front panel control, the crossover may be switched from stereo 2-way or 3-way to single-channel 4-way or 5-way mode. LEDs indicate which frequency and level controls are active for a selected mode. Through an additional input jack at the rear of the chassis, an external signal may be applied to the counter, which will measure and display its frequency from 1 Hz to 9,999 Hz.

The crossover filters are third order Butterworth, state variable type, with 18 dB per octave slopes. We have found that most professional users prefer this characteristic because it provides unity summing, that is, maximally flat response when

combined. Each filter is tunable over a 100:1 range. The two inputs are bridging and balanced, and the six outputs are transformer isolated.

All crossover frequency controls and the mode selector switch are recessed. This reduces the possibility of accidental changes of these critical settings while still providing convenient access to the controls. The output level controls and individual output mute switches are front panel mounted, allowing easy access during setup and in emergencies. A front panel security cover is available for the Model 525 Electronic Crossover to protect control settings from tampering or inadvertent disturbance.

1.2 ELECTRICAL SPECIFICATIONS

INPUTS (2)

TYPE: Balanced bridging, differential amplifier.

INPUT IMPEDANCE: 40 kohms balanced, 20 kohms unbalanced.

MAXIMUM INPUT LEVEL: +20 dB (Ref. 0.775 V rms).*

GAIN: Unity, \pm 1 dB

CROSSOVER FILTERS

TYPE: 3rd order Butterworth, 18 dB per octave.

TUNING RANGE: Filters number 1 and 3, continuously variable from 50 Hz to 500 Hz (x1 range), and 500 Hz to 5 kHz (x10 range); filters number 2 and 4 continuously variable from 100 Hz to 1 kHz (x1 range) and 1 kHz to 10 kHz (x10 range).

FREQUENCY COUNTER

RANGE: 1 to 9,999 Hz.

RESOLUTION: 1 Hz.

ACCURACY: 0.1%, \pm 1 Hz.

EXTERNAL INPUT: -10 dB to +20 dB (0.245 V to 7.75 V rms).

* In these specifications, where "dB" refers to a specific level, the 0 dB reference is 0.775 volts rms unless otherwise noted.

OUTPUTS (6) : Floating, transformer isolated.
OUTPUT LOAD: 600 ohms or greater.
POWER OUTPUT: +20 dBm into 600 ohm load (7.75 V).
DISTORTION: Less than 0.5% THD, 30 Hz to 15 kHz at maximum rated output.
FREQUENCY RESPONSE: ± 1 dB, 20 Hz to 20 kHz.
OUTPUT NOISE: Less than -90 dBm (15.7 kHz bandwidth, input and output terminated with 600 ohms, controls set for unity gain).
LEVEL CONTROLS: Unity gain to greater than 30 dB attenuation. Mute switches for each output.

INDICATORS : Four digit frequency display and nine pinhead LEDs indicate selected mode, active crossover filters, and output amplifiers in use.

POWER REQUIREMENTS : 100 to 125 VAC or 200 to 250 VAC, 50/60 Hz, switch selectable, less than 10 watts.

ENVIRONMENT : Operating 0°C to +50°C;
Storage -20°C to +60°C.

1.3 PHYSICAL SPECIFICATIONS

CONNECTIONS: Inputs and outputs on rear panel barrier strips and XLR/QG connectors. Power through 3-wire IEC-style connector.

DIMENSIONS: 483 x 89 mm rack panel, depth behind panel 248 mm (19" x 3-1/2" x 9-3/4").

FINISH: Panel is 3.18 mm (1/8") brushed clear-anodized aluminum in two shades. Chassis is cadmium plated steel.

WEIGHT: 4.54 kg (10 pounds).

SHIPPING WEIGHT: 6.35 kg (14 pounds).

ACCESSORY: Model SC-2 Security Cover: smoke gray transparent plastic: covers all operating controls.

1.4 CONTROLS AND INDICATORS

- MODE SELECTOR:** Four position switch, recessed in the front panel. This switch selects either:
- 2-way stereo
 - 3-way stereo
 - 4-way mono
 - 5-way mono
- A screwdriver must be used to change the switch position.
- CROSSOVER FREQUENCIES:** Four individual, recessed controls. With a screwdriver, continuously adjustable over the range indicated on the front panel. These controls have a momentary push position. When pushed in, the frequency counter will measure and display the frequency to which the crossover is tuned.
- MULTIPLIER SWITCHES:** These four recessed toggle switches select the range of the associated crossover frequencies, x1 or x10.
- OUTPUT CONTROLS:** These six front panel controls adjust the level of each individual output amplifier. Clockwise position is unity passband gain. Coupled with the level controls are individual push-pull Mute switches. When pulled out, the signal to the output amplifier is switched off.
- POWER:** Toggle switch, with LED to indicate when the Model 525 is turned on.
- FREQUENCY COUNTER:** A four digit LED display which normally indicates 0000. When any of the crossover frequency adjustments is pushed in, the frequency is displayed in the readout window. Similarly, if an external signal is applied to the External Counter Input, the display will indicate that frequency.
- MODE INDICATORS:** Four small LEDs over the crossover frequency adjustments are turned on according to the selected mode. This indicates which crossover point is active.
- Five additional small LEDs, each between two output amplifier controls, show the outputs associated with the active crossover filters.

REAR PANEL CONTROLS: A slide switch to select the correct mains voltage; and a slide switch to select the line frequency reference for the counter (50 Hz or 60 Hz).

1.5 CONNECTIONS

All connections for input and output are made on the rear panel through barrier strips and/or 3 pin XLR/QG connectors. Power is applied through a 3-wire IEC-style connector. (See Installation Instructions, Section 2.6., Figures 2-1 and 2-2.)

SECTION II INSPECTION AND INSTALLATION

2.1 UNPACKING AND INSPECTION

Your Model 525 was carefully packed at the factory, and the container was designed to protect the unit from rough handling. Nevertheless, we recommend careful examination of the shipping carton and its contents for any sign of physical damage which could have occurred in transit.

If damage is evident, do not destroy any of the packing material or the carton, and immediately notify the carrier of a possible claim for damage. Shipping claims must be made by the consignee.

The shipment should include:

Model 525 Electronic Crossover

UREI Instruction Manual (this book)

Two-part Warranty Card bearing the same serial number as the Model 525.

Rack mounting hardware.

2.2 ENVIRONMENTAL CONSIDERATIONS

The system will operate satisfactorily over a range of ambient temperatures from 0°C to +50°C (+32°F to 122°F), and up to 80% non-condensing relative humidity.

If the system is installed in an equipment rack with high heat producing equipment (such as power amplifiers), adequate ventilation should be provided in order to assure longest component life. Also, while circuitry susceptible to hum pick-up is sufficiently shielded from moderate electromagnetic fields, installation should be planned to avoid mounting the system immediately adjacent to large power transformers, motors, etc.

2.3 POWERING

The 525 may be operated from either 100 to 125 VAC or 200 to 250 VAC mains (50 Hz or 60 Hz, single phase.) As indicated in Section 2.4, the nominal line voltage and frequency (counter reference) may be selected with rear panel switches. BE SURE TO VERIFY THE ACTUAL LINE VOLTAGE, MAINS FREQUENCY, AND THE SETTING OF THE VOLTAGE AND FREQUENCY SELECTOR SWITCHES BEFORE CONNECTING THE 525 TO THE MAINS.

To comply with most Electrical Codes, the 525 is supplied with a three-wire IEC style connector, the grounding pin of which is connected to the chassis. In some installations this may create ground-loop problems. Ground loops can result in hum and buzz if a significant potential difference exists between the AC conduit ground and the grounded metal enclosure in which the chassis is installed. If hum is experienced, one may check for the possibility of ground loops by using a 3-prong to 2-prong AC adapter between the power cord and the mains supply, ungrounding the AC plug temporarily. This ungrounds the Model 525, and may cure the hum or buzz, but is not a substitute for proper system grounding. Be aware that unless the Model 525 Electronic Crossover is AC grounded, a safety hazard can exist. UREI accepts no responsibility for legal actions or for direct, incidental or consequential damages that may result from violation of any electrical codes.

2.4 LINE VOLTAGE SWITCH

Unless a tag on the line cord specifies otherwise, the Model 525 was shipped ready for operation with nominal 115 VAC power mains. In order to change this for nominal 230 V (50 Hz or 60 Hz), slide the VOLTAGE SELECTOR switch on the rear panel to the 230 position. The voltage is visible in a window next to the switch slot. A small screwdriver should be used to move the recessed switch. Be sure to change the fuse to the correct value: 1/8-amp slo-blo when changing to 230 V operation or 1/4-amp slo-blo for 115 V operation.

2.5 50-60 Hz SWITCH

Since the frequency of the AC mains is used as a time base for the frequency counter, this switch provides a convenient way to adapt the Model 525 to either 50 Hz or 60 Hz.

2.6 EXTERNAL CONNECTIONS

Permanent input and output signal wires should be shielded cable, and connected in accordance with standard wiring practice to either the barrier strips or the XLR/QG connectors on the back of the chassis.

NOTE: The pins of the XLR's are wired as follows:

- #3 = "+" of input and output;
- #2 = "Common" of input and output;
- #1 = to chassis GROUND.

If the Electronic Crossover output is connected to a high impedance circuit, we recommend shunting the "+" and "COM" output terminals of the Model 525 with a 620 ohm, 1/2 watt resistor. This assures optimum loading.

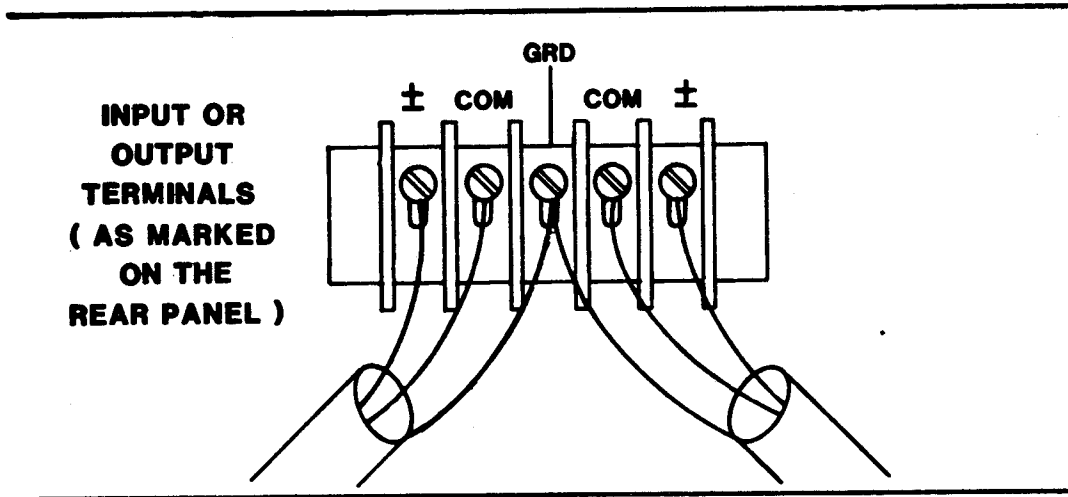

FIGURE 2-1. CONNECTING THE MODEL 525 WITH BALANCED
INPUT AND BALANCED OUTPUT CIRCUITS.*

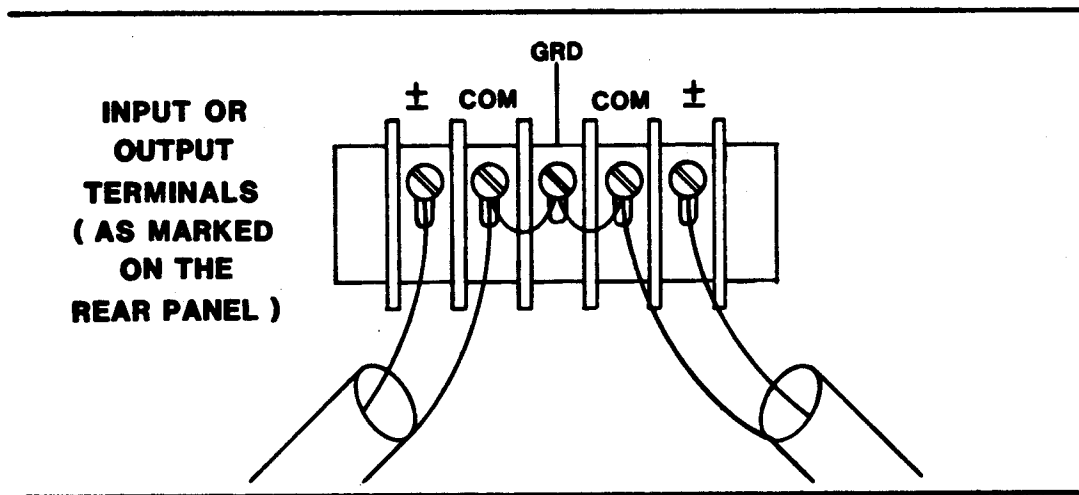

FIGURE 2-2. CONNECTING THE MODEL 525 WITH UNBALANCED
INPUT AND UNBALANCED OUTPUT CIRCUITS.*

*With a balanced input and unbalanced output, or vice-versa,
use the appropriate connections suggested by each of the above
diagrams. No special switching or transformers are needed.

2.7 IMPEDANCE AND TERMINATION

Audio engineering had its roots in the telephone industry, and "600 ohm circuits" (together with their predecessors, "500 ohm circuits") are carry-overs from telephone transmission practices. Long audio transmission lines, like their video counterparts, must be properly sourced from and terminated in equipment which matches their characteristic impedance, if optimum frequency response and noise rejection are to be achieved.

However, transmission line theory and techniques are not only unnecessary but impractical within modern recording studios, broadcast studios and other local audio systems where transmission circuits are seldom more than several hundred feet in length. The advent of negative feedback circuitry and solid-state electronics has spawned modern audio amplifiers and other signal processing devices having source impedances of only a few ohms. They are essentially indifferent to load impedances and by varying their output current inversely to changes in load impedance, maintain the same output voltage into any load impedance above a rated minimum, with no change in frequency response.

Modern audio systems, therefore, utilize amplifiers and other active devices which have very low output impedances and high (10k to 50k) input impedances. These products may thus be cascaded (operated in series), or many inputs may be connected to a single output of a preceding device, without regard to impedance "matching". Switching, patching, etc. is simplified because "double loads" and "unterminated" bugaboos are essentially eliminated. "Floating" (ungrounded) transformer outputs minimize ground loop problems, and differential transformerless input circuitry (or input transformers) minimize common mode noise or interference which may be induced into the interconnecting wires or cables.

Where audio must be transmitted through cables or wire pairs of more than several hundred feet in length, however, transmission line termination practices should still be observed.

The Model 525 has input impedances of 40,000 ohms when used in a balanced, differential input configuration, and 20,000 ohms when used unbalanced (one side grounded). This makes the crossover suitable for use with any nominal source impedance, low or high. Only when it is used from a source which requires a low impedance termination (such as a 600-ohm transmission line or older vacuum-tube equipment) is a source termination resistor required at the 525 input.

2.8 MODE SWITCH AND LED INDICATORS

The Mode Switch is recessed in the front panel and its position can only be changed with a screwdriver. The slot of the shaft

points to the selected mode. For the convenience of the user, little LEDs indicate which crossover filters and which output amplifiers are active in each of the different modes (see table below).

NOTE: The LEDs are numbered from left to right. Numbers 1 through 4 designate the crossover filters, and numbers 5 through 9 each light up for a pair of output amplifiers.

LED #	1	2	3	4	5	6	7	8	9
MODE	-CROSSOVER FILTERS-				-----OUTPUT AMPLIFIERS-----				
					1 - 2	2 - 3	3 - 4	4 - 5	5 - 6
2-WAY STEREO	X		X		X			X	
3-WAY STEREO	X	X	X	X	X	X		X	X
4-WAY MONO	X	X		X	X	X	X		
5-WAY MONO	X	X	X	X	X	X	X	X	

TABLE 2-1. (See also pages 13, 14)

2.9 FREQUENCY COUNTER (DISPLAY)

In normal operation, the four digits of the counter will indicate zeros. When any of the crossover filters is pushed in (momentary switch position), the counter indicates the crossover frequency. It takes approximately two seconds to display the final count.

The maximum indication of the display is 9,999 Hz. When the frequency goes beyond this number, the display will indicate only the last four digits; for example, 10,500 Hz will be displayed as 0500. This condition can occur when the high frequency crossover point is adjusted to the extreme clockwise position, or when an external signal exceeds 9,999 Hz (see Section 2.10). The accuracy of the displayed numbers is not affected by the overflow condition.

2.10 EXTERNAL COUNTER INPUT

On occasion it may be desirable to know the frequency of an external signal. The RCA jack on the back panel accepts signals from -10 dB to +20 dB (Ref. 0.775 V rms) to be counted.

NOTE: Disconnect or turn down any external signal when it is necessary to read the frequency of the crossover point. An external signal may confuse the counter and give an erroneous reading.

SECTION III
OPERATING INSTRUCTIONS

3.1 GENERAL

After the Electronic Crossover has been installed and is connected to both the signal source(s) and the succeeding amplifiers according to Section II, power may be switched on. Set controls as follows:

OUTPUT LEVEL: minimum (CCW), pushed in.

MODE SWITCH: as required for the system.

CROSSOVER FREQUENCIES: (in conjunction with the x1-x10 multipliers) to the approximate frequency as required by the selection of transducers in the system.

3.2 SYSTEM CHECK

3.2.1 With Internally Generated Test Signals.

Push in the continuously variable frequency adjustment and read the crossover frequency on the counter. During this operation, that is, while the shaft is pushed in, the filter is switched to oscillate at the frequency of the crossover point. The resulting signal is coupled to the respective output amplifiers (at a level of approximately -10 dBm at unity gain setting of the output level control). Slowly turn the output level control of the Model 525 clockwise until the signal can be heard through the appropriate loudspeaker. If the output level control is pulled out, no signal is connected to the output stage. Continue to check each active output of the crossover, and the associated amplifier and loudspeaker system.

3.2.2 With Program Material or Externally Applied Test Signal.

The crossover points may be changed while program material is played through the system. However, this adjustment should be made without pushing in the frequency adjustment control in order to avoid mixing the audio signal with the internal test signal. Turn each output level control until the desired signal level is reached, and then balance each section of the sound system.

This concludes the performance test of the Model 525. Additional measurements and subsequent adjustments may be necessary to achieve optimum performance of the entire sound system, which includes parameters such as power level, headroom, frequency response, dispersion, phasing (polarity), etc.

3.3 APPLICATION

The simplified graphs on the following two pages (Fig. 3-1) show the various ways in which the crossover filters and outputs can be combined for the best matching to the sound system. Dotted curves indicate crossover outputs which are not used. Dotted vertical lines indicate crossover frequencies.

3.4 DOCUMENTATION

The very nature of the design of the Model 525 permits an almost infinite number of crossover points and output level settings. Although accidental misadjustments are eliminated through the use of recessed controls and the optional Security Cover, it is a good idea to document the frequency response of the adjusted crossover. This is made convenient by the Model 525's built-in counter, mode indicators, and markings of the level controls.

In addition, a frequency response curve of each output may be drawn with a suitable sweep generator and X-Y recorder system, such as the UREI Model 200/2000.

3.5 LEVEL CONTROLS

The Model 525 Electronic Crossover was designed as a unity gain device and for optimum performance it should be operated as such. The level controls are provided to allow for matching of speaker efficiencies in a system. If one section of a system is much less sensitive than another the least sensitive section should have its output level at maximum (unity gain) with the other sections having their levels adjusted downward to match. In no event should the output level control be operated at below one-half rotation (- 10 dB gain) or the signal-to-noise performance of the system may be degraded.

INPUT

FREQUENCY RESPONSE

**CONFIGURATION
(SWITCH POSITION)**

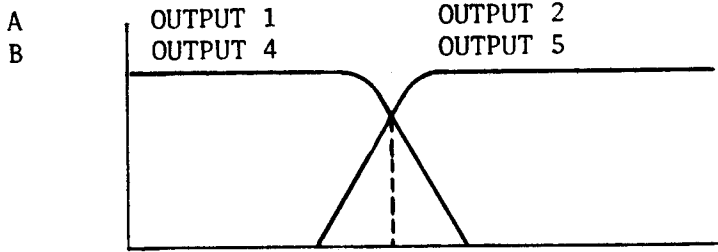

**STEREO MODE
(2-WAY STEREO)**

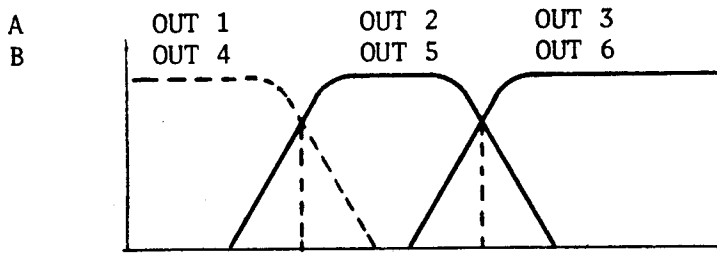

**STEREO 2-WAY
WITH HI-PASS FILTER
(3-WAY STEREO)**

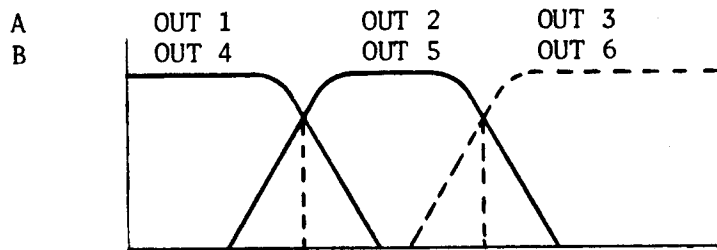

**STEREO 2-WAY
WITH LO-PASS FILTER
(3-WAY STEREO)**

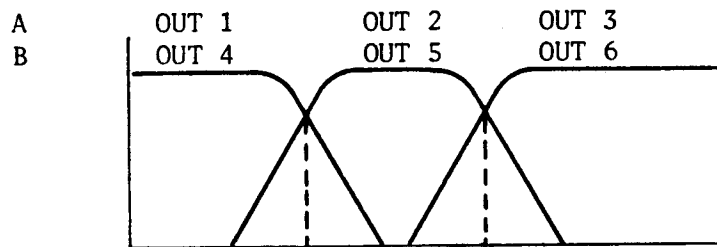

**STEREO MODE
(3-WAY STEREO)**

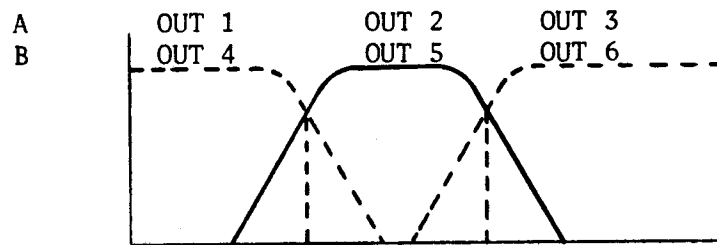

**STEREO BANDPASS
(3-WAY STEREO)**

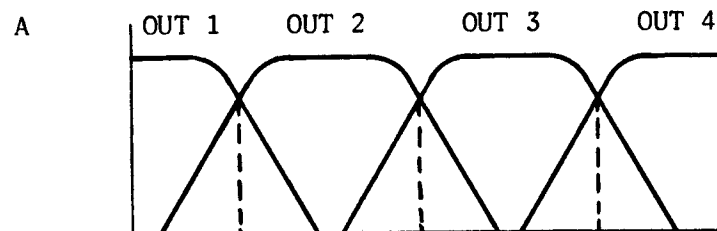

**MONO MODE
(4-WAY MONO)**

FIGURE 3-1

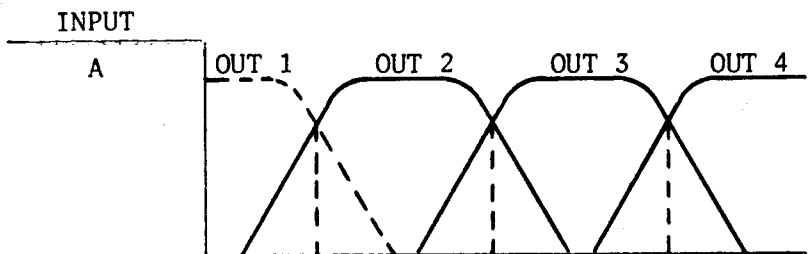

**MONO 3-WAY
WITH HI-PASS FILTER
(4-WAY MONO)**

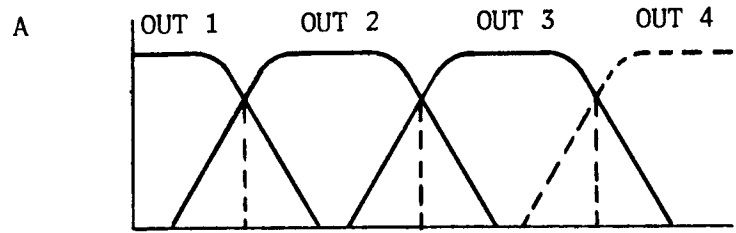

**MONO 3-WAY
WITH LOW-PASS FILTER
(4-WAY MONO)**

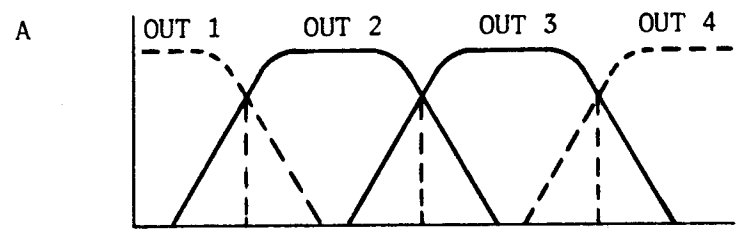

**MONO 2-WAY
WITH BANDPASS FILTER
(4-WAY MONO)**

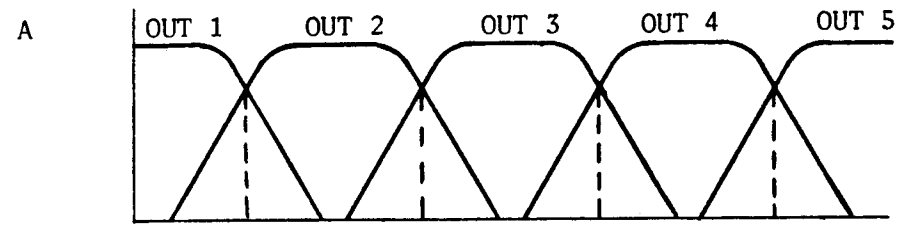

**MONO MODE
(5-WAY MONO)**

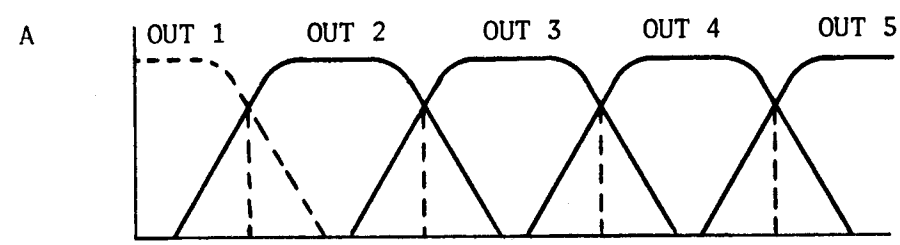

**MONO 4-WAY
WITH HI-PASS FILTER
(5-WAY MODE)**

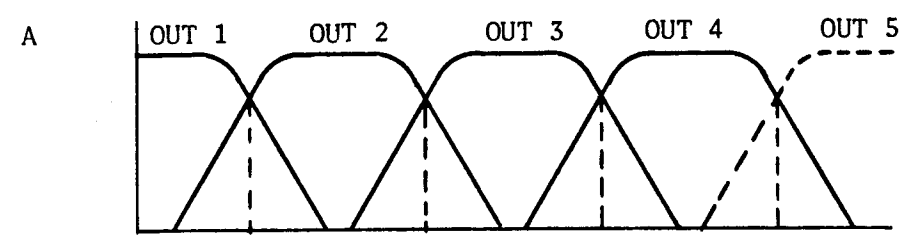

**MONO 4-WAY
WITH LOW-PASS FILTER
(5-WAY MODE)**

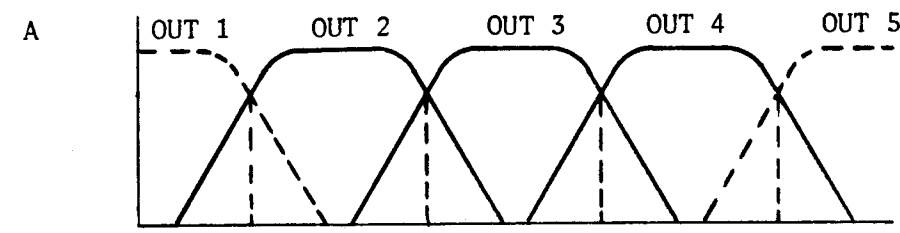

**MONO 3-WAY
WITH BANDPASS FILTER
(5-WAY MODE)**

**FIGURE 3-1
(Continued)
PAGE 14**

3.6 PRECAUTIONS

The application of an electronic crossover has some obvious advantages, for example, more efficient use of amplifier power, more headroom, less distortion, better damping. Usually this list also includes protection of high frequency drivers. This is true since low frequencies in the program material are below the crossover point. However, there are other causes for low frequencies with high power levels in a sound system, which develop after the audio signal has been divided in the crossover; for example, when equipment is turned on, or when cables are connected and disconnected. Therefore it is a good idea to protect the high frequency drivers against low frequencies. A single capacitor between the amplifier output and the speaker terminal is sufficient. The following Table 3-1 shows capacitor values with a cutoff frequency to be one octave below the crossover point selected in the Model 525. This capacitor should be a non-polarized, oil filled, high quality component. The voltage rating must be at least equal to the maximum peak-to-peak voltage which the amplifier is capable of producing at its output.

CAPACITOR CUTOFF FREQUENCY (Hz)	100	200	400	500	1.5 k	3 k	4.5 k
MODEL 525 CROSSOVER FREQUENCY (Hz)	200	400	800	1 k	3 k	6 k	9 k
FOR THE FOLLOWING TRANS- DUCER IMPEDANCES, USE THESE CAPACITOR VALUES (μ F)							
4 OHMS	400	200	100	80	25	13	8.8
8 OHMS	200	100	50	40	13	6.6	4.4
16 OHMS	100	50	25	20	6.6	3.3	2.2

TABLE 3-1.

SECTION IV THEORY OF OPERATION

4.1 INPUT AMPLIFIER

The signal is applied to a differential amplifier (IC2, Sections D and A for channel A; Sections C and B for channel B). The input accepts either balanced or unbalanced sources. Common mode rejection is factory adjusted with R4 (R6) and is typically better than 60 dB. The output from channel A's input amplifier is fed to state variable filter number one. The output from channel B is connected to the mode switch. In the stereo modes, the signal from channel B continues to state variable filter number three. In the mono modes, channel B's input amplifier is not used.

4.2 STATE VARIABLE FILTER/OSCILLATOR

During normal operating conditions, the circuit in the state variable filter is of conventional design. Special attention has been given to the selection of components to achieve the maximum performance of the circuit. The filter is a third order Butterworth, which yields 18 dB per octave slopes. If summed, the outputs combine flat throughout the tuning range.

The high frequency signal is taken from the output of IC 3 Section A, respectively 4,5,6). The low frequency component is inverted in IC7 to achieve the correct phase relationship.

The bandpass outputs of the filter are combined in IC8, and the resulting output signal is amplitude limited by diodes CR1 and CR2. The maximum output from IC 8 occurs when the bandpass outputs of the state variable filter have maximum amplitude, that is, when the high and low outputs reach the -3 dB point.

Since, under normal operating conditions, the switch S1 is open, no feedback from the output of IC8 can occur (S1 is a switch with a momentary push position, and is part of the frequency tuning potentiometer). When S1 is closed, the feedback loop to the input of the state variable filter is completed, and the circuit will oscillate at the frequency of maximum feedback signal. As described in the previous paragraph, this occurs at the crossover point of the high and low frequency outputs.

During oscillation, a large amplitude signal is fed to the input of the frequency counter.

4.3 MODE SWITCH

The various outputs from the four state variable filters are connected to the mode switch. This switch is comprised of eight single pole, four position switch sections. While six poles route

the audio signal to filter three and four, and the various output amplifiers, two poles activate the diode matrix to indicate the different modes.

4.4 OUTPUT AMPLIFIER

The audio signal is coupled through a 6.8 microfarad capacitor to the output level potentiometer. The capacitor prevents any DC offset from previous stages from reaching the output amp and causing switching noise when the signal on/off switch is activated.

The op amp drives a complementary pair of power transistors. The gain through the entire Electronic Crossover is unity, ± 1 dB with the output terminated in 600 ohms.

4.5 MODE INDICATORS

For identification, these small pinhead LEDs are numbered 1 through 9 from left to right looking at the Model 525 front panel. (See also Section II, Table 2-1 for sequence and switch positions.) Some LEDs are connected in series to minimize the current drain from the power supply.

4.6 FREQUENCY COUNTER

This circuit block consists of four different sections: Signal conditioning (IC10, Sections B & C), time base (IC12 and IC13), gate (IC11), and the display.

When any of the state variable filters is switched into the oscillating mode, the sinusoidal signal is coupled through R8-11. The following stages amplify the signal, and the positive half of the resulting square wave is fed to the gate (IC11, Section A) where a 1 second timing signal allows a precise number of cycles to pass through the gate.

The timing signal is derived from the mains frequency, which is accurate enough for the intended application. IC13 divides by 10, and IC12 divides further by 5 and 6. Depending on the standard of the country where the Model 525 is used (50 Hz or 60 Hz), the rear panel switch must be selected accordingly. The 1 second signal interval is separated by a 164 millisecond gap. Simultaneously a 16.4 millisecond latching signal is generated and conditioned in IC11, Sections C and D, which is used to hold the counted number in the display after the count is updated once every second.

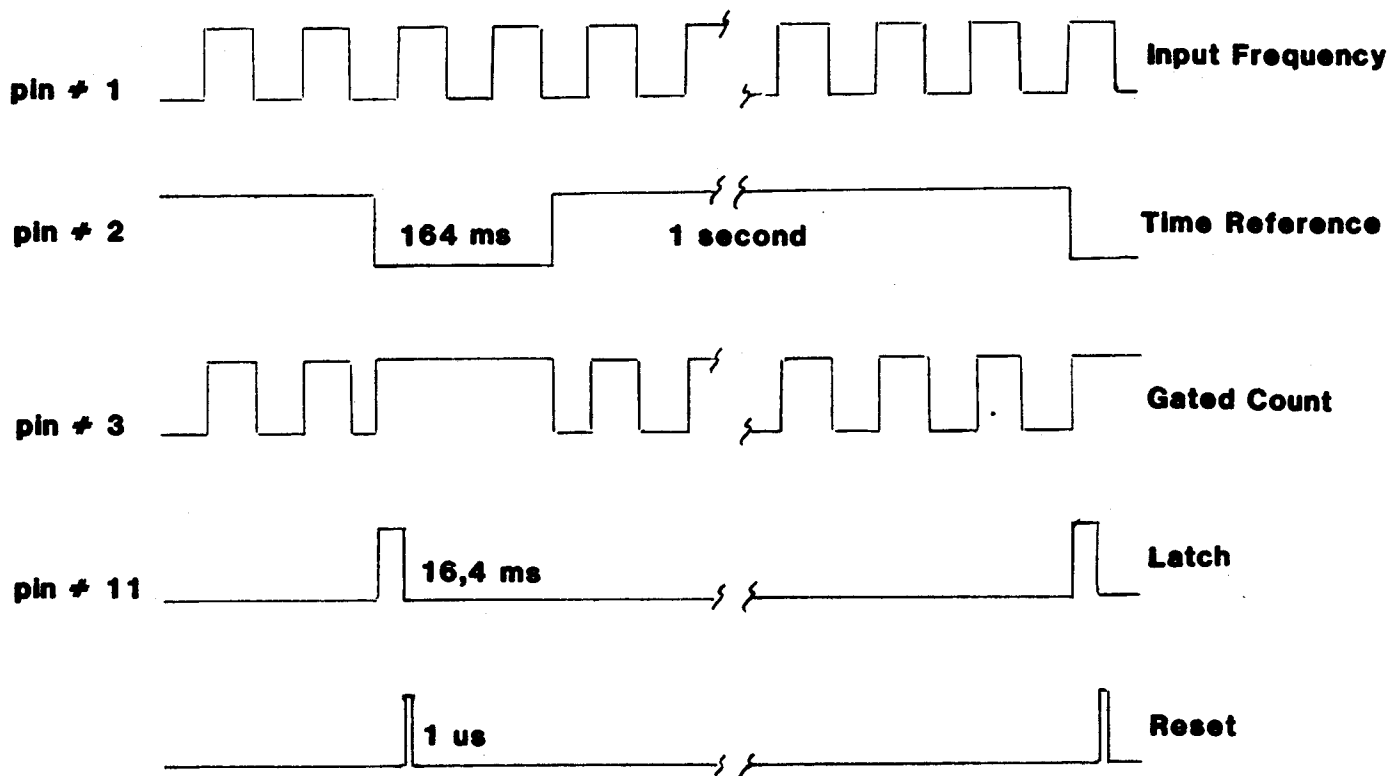

SIGNAL FLOW THROUGH GATE (IC 11).

IC1 (on the front panel PC board) is counting the incoming signal, decodes the information, and drives the four digital readouts. After each second, the count is updated and latched into the display.

A reset pulse is used to clear the display circuit and to reset the dividers.

4.7 POWER SUPPLY

The power supply provides bipolar voltages (± 18 V) for the analog circuitry of the Model 525, while an additional +5 V is supplied for the digital circuitry. All dc voltages are IC regulated to guarantee low ripple, low noise, and stable operation under all conditions.

There are also separate ground systems for the analog and digital circuits. The chassis is connected to the power supply ground at one central point only.

NOTE: All LEDs may be used as a convenient method to check the correct operation of the power supply. Diodes 1 through 6 and 8 are connected to +18 V; diodes 7 and 9 are powered from the +5 V supply, and the power ON LED is connected to the -18 V supply.

SECTION V MAINTENANCE

5.1 GENERAL

The Model 525 is an all solid state unit, ruggedly constructed with only the highest quality components. As such, it should provide years of trouble free use with normal care. All parts used are conservatively rated for their application, and workmanship meets the rigid standards you have learned to expect in UREI products.

NO SPECIAL PREVENTIVE MAINTENANCE IS REQUIRED.

5.2 REPAIRS AND WARRANTY

This product is factory warranted to the original purchaser against defects in material and workmanship for one year after initial purchase. This limited warranty must be activated at the time of purchase by returning the registry portion of the Warranty Card to the factory. Should a malfunction ever occur, the dealer from whom the unit was purchased will be glad to handle return for factory repair. Please call or write to the factory for a Return Authorization Number which must accompany all repairs. For prompt service, ship the unit prepaid directly to the factory with the RA Number visible on the shipping label. Be sure it is well packed in a sturdy carton, with shock-absorbing material such as foam rubber, styrofoam pellets, or "bubble-pack" completely filling the remaining space. Particular attention should be paid to protecting the controls, switches, etc. Tape a note to the top of the unit describing the malfunction, and instructions for return. We will pay one-way return shipping costs on any in-warranty repair.

Because of specially selected components in this product, field repairs are not authorized during the warranty period, and attempts to perform repairs may invalidate the warranty.

Even if your unit is out of warranty, we recommend that you return it to the factory for repairs. Our experienced personnel, supported by special test equipment, will be able to find and eliminate any problem in the most efficient way.

WARNING: The full AC Line voltage is present at several points inside the chassis. Be careful to avoid personal shock when you work on the unit with the covers removed.

5.3. SERVICE ADJUSTMENTS

These controls have been carefully set at the factory and should not require adjustments except after service work. (Channel B component designations, where given, are in parentheses.)

5.3.1 COMMON MODE BALANCE

The internal trimpots R4 (R6) affect the COMMON MODE BALANCE. If a check or an adjustment is necessary the following procedure should be followed (each channel):

Connect the Iand and COM input terminals together and apply an input signal between this connection and the GND terminal (100 Hz, 3 V RMS).

Switch the Model 525 to the stereo mode, either 2-way or 3-way, and adjust the crossover frequency to be above 100 Hz. Measure the signal with an AC meter across the output terminals of amplifier #1 (#3). Adjust the trimpot for a minimum reading, switching the voltmeter gradually to more sensitive readings.

5.4 IN CASE OF DIFFICULTY

5.4.1 GENERAL

The overall schematic, circuit description (Section IV), and troubleshooting table (Table 5-1) can often be used to isolate a problem. Safety considerations outlined in Section II apply when working inside the device. If a problem cannot easily be solved, it is best to send the unit to the factory using the procedure described under paragraph 5-2.

5.4.2 PRECAUTIONS FOR TROUBLESHOOTING

Be cautious when testing IC and transistor circuits. Although they have almost unlimited life when used properly, they are very vulnerable to damage when accidentally shorted or connected to incorrect voltages.

Be sure not to short any terminals when making measurements. If a probe should slip, for example, and short out a bias or supply point, it will very likely damage IC's, transistors or diodes. Do not remove any components while the line cord is connected to the AC outlet.

5.4.3 VISUAL TEST

Look at wiring and connections. Check to be sure that all transistors and IC's are properly fitted into the sockets. Check for resistors which may look burned, indicating trouble in associated circuitry.

TABLE 5-1. TROUBLESHOOTING

PROBLEM	POSSIBLE CAUSE	REMEDY
Signal does not pass through the device.	<ol style="list-style-type: none"> 1. Incorrect hookup. 2. Output level controls turned CCW or knobs pulled out. 3. Bad output amplifier. 4. Power supply defective. 5. Loose or broken wires between PC board and front panel assembly. 	<p>See Section II, Installation.</p> <p>Adjust clockwise and push knob in.</p> <p>Try other channel. Repair.</p> <p>Check voltages.</p> <p>Locate and resolder.</p>
Incorrect range of crossover filters.	<ol style="list-style-type: none"> 1. Multiplier switch x1-x10 in wrong position. 2. Connected to wrong output amplifier. 	<p>Select proper range.</p> <p>Verify hookup.</p>
Channel B input signal does not pass through device.	<ol style="list-style-type: none"> 1. Switched to wrong mode. 	<p>Switch to stereo.</p>
Counter does not count at all.	<ol style="list-style-type: none"> 1. Counter does not receive signal. 2. Bad IC in counter circuit. 	<p>Push any of the crossover frequency adjustments.</p> <p>Apply a periodic signal, (20 Hz - 20 kHz, -10 dB to +20 dB) to External Input.</p> <p>Replace</p>
Counter counts incorrectly during adjustment.	<ol style="list-style-type: none"> 1. Audio signal present at input. 2. Signal connected to external input. 3. 50-60 Hz switch in wrong position. 4. Bad IC in circuit. 5. Frequency higher than 9,999 Hz (overflow). 	<p>Disconnect or turn down input signal.</p> <p>Disconnect external input signal.</p> <p>See Section II, 2.5.</p> <p>Repair.</p> <p>This is not a problem, see Section II, 2.9.</p>

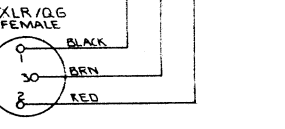
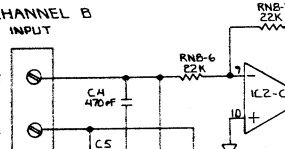
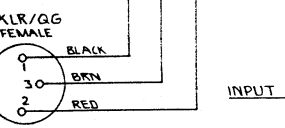
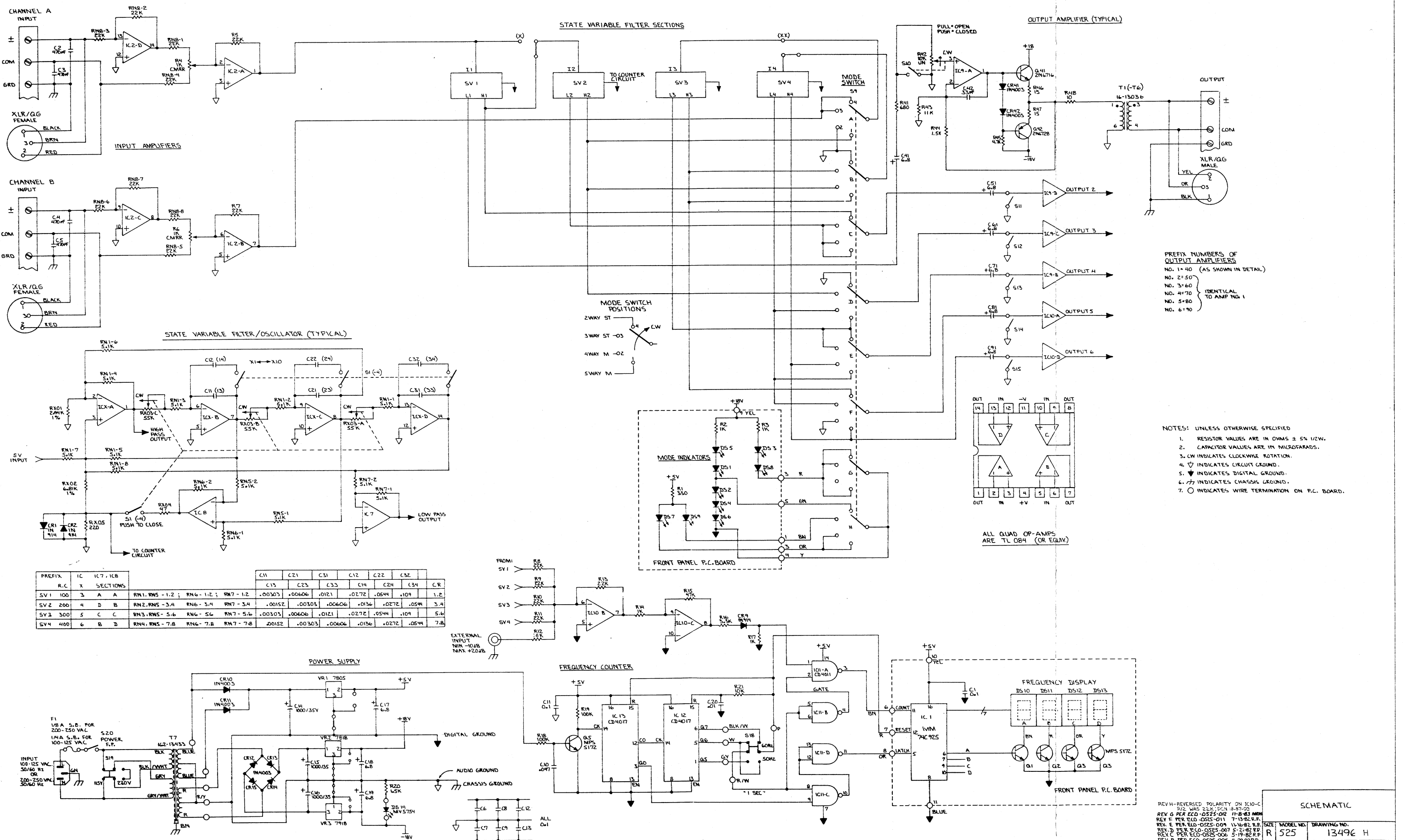

PREFIX	IC	IC7, ICB	R.C	X	SECTIONS	C11	C21	C31	C12	C22	C32	C.R
SV 1	100	3	A	A	RN1, RN5 - 1.2; RN6 - 1.2; RN7 - 1.2	.00303	.00606	.0121	.0272	.0544	.109	1.2
SV 2	200	4	D	B	RN2, RN5 - 3.4; RN6 - 3.4; RN7 - 3.4	.00152	.00303	.00606	.0134	.0272	.0544	3.4
SV 3	300	5	C	C	RN3, RN5 - 5.6; RN6 - 5.6; RN7 - 5.6	.00303	.00606	.0121	.0272	.0544	.109	5.6
SV 4	400	6	B	D	RN4, RN5 - 7.8; RN6 - 7.8; RN7 - 7.8	.00152	.00303	.00606	.0134	.0272	.0544	7.8

PREFIX NUMBERS OF OUTPUT AMPLIFIERS
 NO. 1 = 40 (AS SHOWN IN DETAIL)
 NO. 2 = 50
 NO. 3 = 60
 NO. 4 = 70
 NO. 5 = 80
 NO. 6 = 90
 IDENTICAL TO AMP NO. 1

- NOTES: UNLESS OTHERWISE SPECIFIED
1. RESISTOR VALUES ARE IN OHMS ± 5% 1/2W.
 2. CAPACITOR VALUES ARE IN MICROFARADS.
 3. CW INDICATES CLOCKWISE ROTATION.
 4. ∇ INDICATES CIRCUIT GROUND.
 5. ▼ INDICATES DIGITAL GROUND.
 6. ⊕ INDICATES CHASSIS GROUND.
 7. ○ INDICATES WIRE TERMINATION ON P.C. BOARD.

ALL QUAD OP-AMPS ARE TL 084 (OR EQUIV.)