

WOELKE-STRASSE 2-3  
8069 SCHWEITENKIRCHEN  
☎ 08444 / 394 · ☎ 55547  
NOTBURGSTRASSE 5  
80MÜNCHEN19 ☎ 089/177021

# WOELKE MAGNETBANDTECHNIK



The ME 401: a completely new automatic, direct reading, third harmonic distortion analyzer for alignment of studio tape recorders as well as consumer cassette decks. The ME 401 is a development resulting from experiences gained in manufacturing test equipment for quality control, repair and service labs. It is another in the well known ME series of test equipment made by the Woelke organization.

# AUTOMATIC DISTOR

The usual annoying switching between ranges is eliminated thanks to the specially aligned scale on the ME 401 meter.  $K_3$  values between 0.2-10% are easily read. The 3% most often found in practice is located at the center of the scale and thereby guarantees the highest indicating and reading accuracy, especially in view of the built-in 3% calibration generator.

The ME 401 provides direct indication of level and third order harmonic ( $K_3$ ) content for the reference frequency 333 Hz, without the necessity of time consuming switching and calibration procedures.

For those tape recorders which do not have a built-in "after tape" output i. e. separate record and playback heads, the 333 Hz test tone must first be recorded. The 333 Hz oscillator is built into the ME 401 unit.

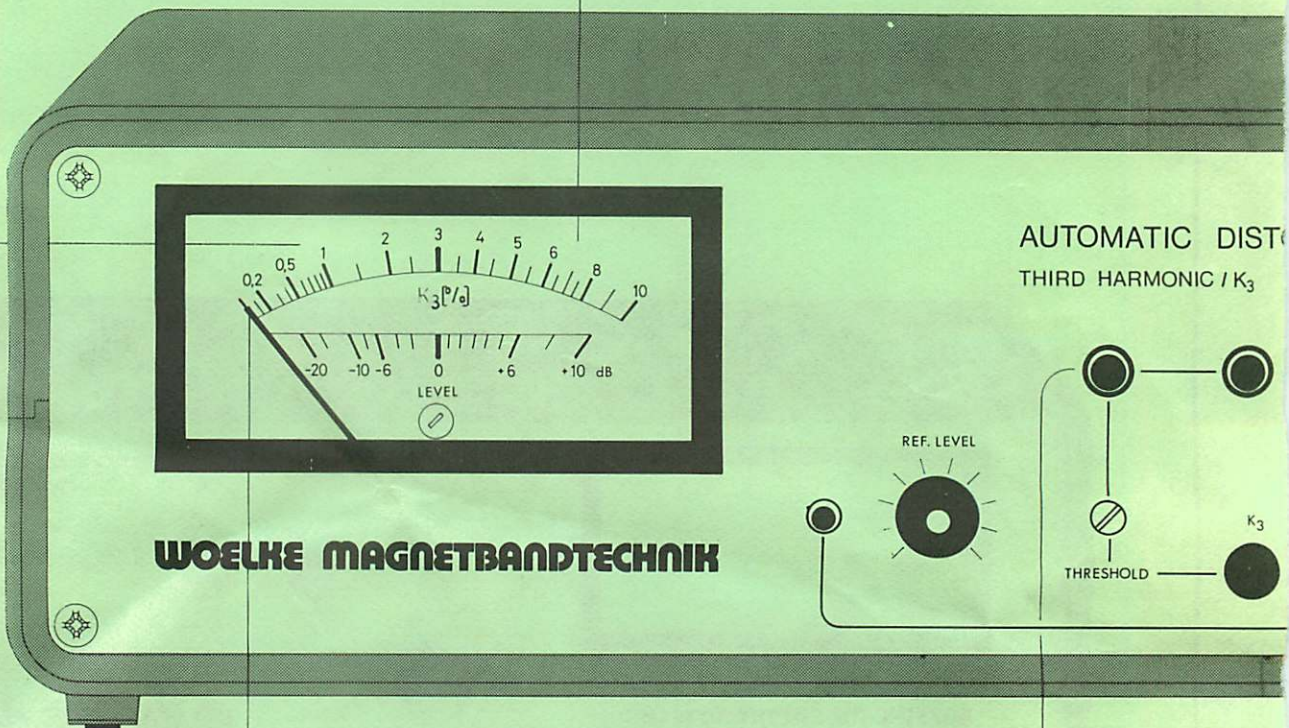

AUTOMATIC DISTOR  
THIRD HARMONIC /  $K_3$

**WOELKE MAGNETBANDTECHNIK**

Reduction of the record current in steps, results in the  $K_3$  value reaching a minimum after which the  $K_3$  value rises again. This minimum represents the portion of tape noise around 1000 Hz and erroneously seems to indicate  $K_3$  components

The self-contained diagnosis and easy ME 401 without the

The low and high s  
by a green and red

Well designed accessories provide simple and time saving operating procedures in the check-out or quality control lab.  
MEZ 401: remote control of the stereo channels.  
MEZ 402: additional switch-over between Flutter meter (ME 101-105) and the ME 401

Existing recordings  
be analyzed with g  
flutter values up to

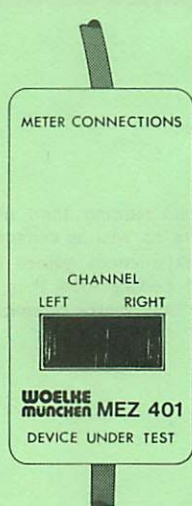
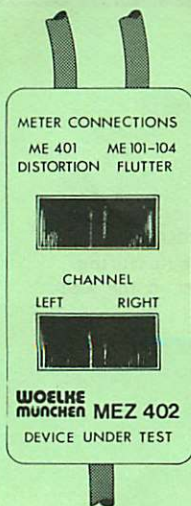

**WOELKE MAGN**

# PORTION METER ME 401

By pushing a button or by remote control ( Foot pedal MEZ 24), the unit can be momentarily switched from  $K_3$  indication to level indication. This permits instant recognition of the relationship between recorded level and  $K_3$  content. If an alignment tape is available, an absolute level test is possible if the ME 401 has first been calibrated with the unit under test.

Input level changes between 50 mV and 10 V are automatically compressed to a range of  $\pm 1\%$  through use of a double regulated amplifier ( forwards / backwards ), and are therefore without any influence on the test result.

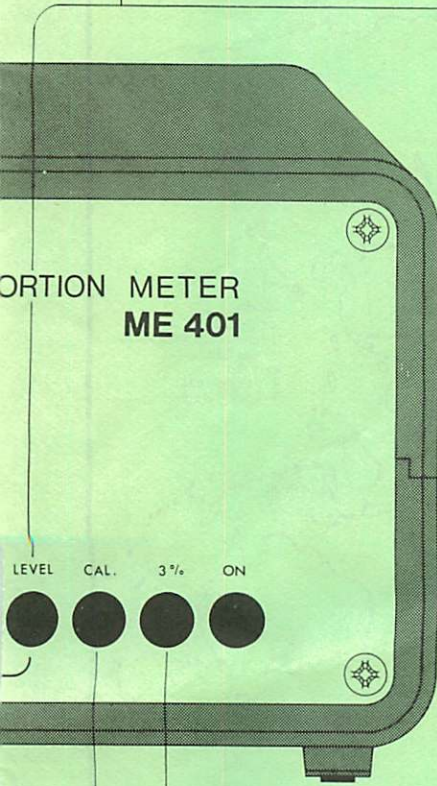

calibration system facilitates the correction of any misalignment of the lamp respectively. No need to disassemble the unit.

side of a preset threshold is indicated by lamp respectively.

of the 333 Hz alignment frequency can be tested with great accuracy ( $\pm 2\%$ ). Drift and / or  $\pm 4\%$  will not falsify the results.



## Technical specifications

Powering	110 / 220 V $\pm 10\%$ 40 - 60 Hz approx. 5 VA
Input voltage	333 Hz $\pm 4\%$ 50 mV - 10 V
Allowable deviation of the input signal from proper frequency	max. $\pm 4\%$
Input impedance	approx. 500 k $\Omega$
Self-contained oscillator	333 Hz
Output voltage	approx. 8 mV
Source impedance	approx. 8 k $\Omega$
Temperature coefficient	$2.5 \times 10^{-4} / ^\circ\text{C}$ ( 333 Hz )
Test ranges	0.1 - 10% $K_3$ -20 to +10 dB level ( 0 dB $\hat{=}$ 500mV )
Settability of indicating threshold	0.8 - 10% the function "Level" is remote controllable ( foot pedal MEZ 24 indicated by lamp )



approx. 4.2 lbs

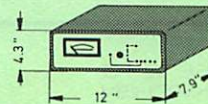

# ETBANDTECHNIK

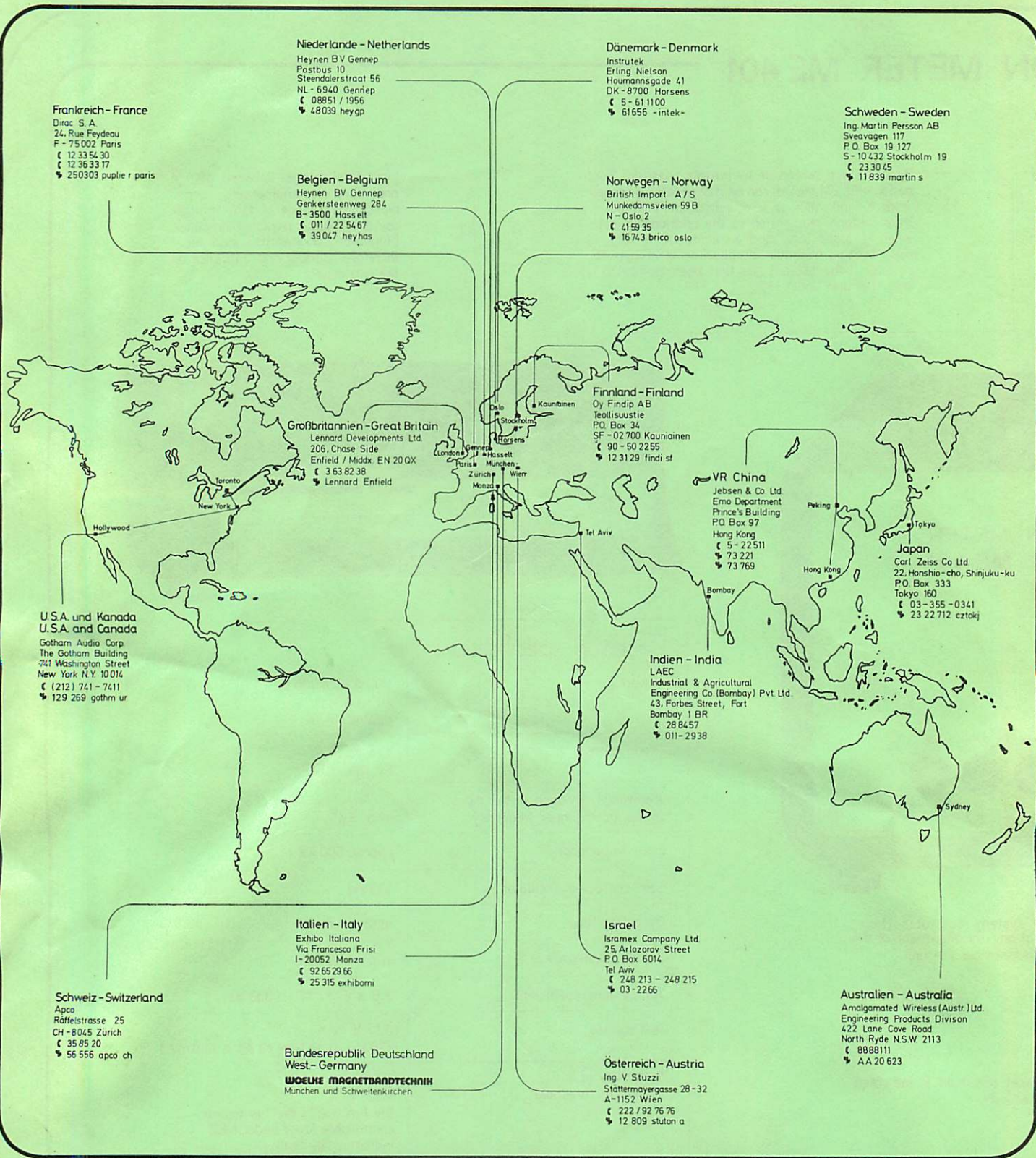

**Frankreich - France**

Dirac S.A.  
24, Rue Feydeau  
F - 75002 Paris  
☎ 12 33 54 30  
☎ 12 36 33 17  
✉ 250303 puplie r paris

**Niederlande - Netherlands**

Heynen BV Gennep  
Pastbus 10  
Steendalerstraat 56  
NL - 6940 Gennep  
☎ 08851 / 1956  
✉ 48039 heygp

**Dänemark - Denmark**

Instrutek  
Erling Nielsen  
Houmannsgade 41  
DK - 8700 Horsens  
☎ 5 - 611100  
✉ 61656 -intek-

**Schweden - Sweden**

Ing. Martin Persson AB  
Sveavägen 117  
P.O. Box 19 127  
S - 10 432 Stockholm 19  
☎ 23 30 45  
✉ 11839 martin s

**Belgien - Belgium**

Heynen BV Gennep  
Genkersteenweg 284  
B - 3500 Hasselt  
☎ 011 / 22 54 67  
✉ 39047 heyhas

**Norwegen - Norway**

British Import A/S  
Munkedamsveien 59 B  
N - Oslo 2  
☎ 4159 35  
✉ 16743 brico oslo

**Großbritannien - Great Britain**

Lennard Developments Ltd.  
206, Chase Side  
Enfield / Middx EN 20 QX  
☎ 3 63 82 38  
✉ Lennard Enfield

**Finnland - Finland**

Oy Findip AB  
Teollisuustie  
P.O. Box 34  
SF - 02 700 Kauniainen  
☎ 90 - 50 2255  
✉ 12 31 29 findi sf

**USA und Kanada  
U.S.A. and Canada**

Gotham Audio Corp  
The Gotham Building  
741 Washington Street  
New York N.Y. 10 014  
☎ (212) 741 - 7411  
✉ 129 269 gothm ur

**Italien - Italy**

Exhiba Italiana  
Via Francesco Frisi  
I - 20052 Monza  
☎ 92 65 29 66  
✉ 25 315 exhibomi

**Israel**

Istramex Company Ltd.  
25, Arlozorov Street  
P.O. Box 6014  
Tel Aviv  
☎ 248 213 - 248 215  
✉ 03 - 2266

**Schweiz - Switzerland**

Apco  
Räffelstrasse 25  
CH - 8045 Zürich  
☎ 35 85 20  
✉ 56 556 apco ch

**Bundesrepublik Deutschland  
West - Germany**

**WOELKE MAGNETBANDTECHNIK**  
München und Schweitenkirchen

**Österreich - Austria**

Ing. V. Stuzzi  
Stattermayergasse 28-32  
A - 1152 Wien  
☎ 222 / 92 76 76  
✉ 12 809 stutan a

**Australien - Australia**

Amalgamated Wireless (Austr.) Ltd.  
Engineering Products Division  
422 Lane Cove Road  
North Ryde N.S.W. 2113  
☎ 8888111  
✉ AA 20 623

WOELKE-STRASSE 2-3  
80689 SCHWEITENKIRCHEN  
☎ 08444 / 394 · ✉ 55547

NOTBURGSTRASSE 5  
81MÜNCHEN 19 ☎ 089 / 177021

**WOELKE MAGNETBANDTECHNIK**

WOELKE-STRASSE 2-3  
8069 SCHWEITENKIRCHEN  
☎ 08444/394 · ☎ 55547  
NOTBURGASTRASSE 5  
8 MÜNCHEN 19 ☎ 089/177021

# WOELKE MAGNETBANDTECHNIK

## OPERATING INSTRUCTIONS

AUTOMATIC DISTORTION METER ME 401



# AUTOMATIC DISTOR

## 1. Setting up for

The ME 401 is ready for operation after the a.c. line plug has been plugged in (Caution! make sure that a.c. line voltage is correct) and the ON button has been pushed. As soon as the device under test (tape recorder or cassette recorder) is connected to the ME 401 via the DIN phono cable, the Distortion Measuring Set is ready for operation when the button "K<sub>3</sub>" is actuated.

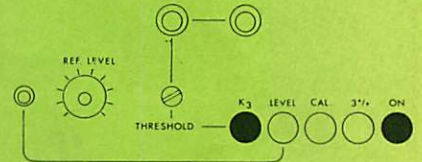

## 2. Measuring the third harmonic distortion (K<sub>3</sub>)

For a tape (or cassette) with a 333 Hz pre-recorded frequency played back on the mechanism under test, the third harmonic (K<sub>3</sub>) value is directly read on the upper scale of the panel meter, on the condition that the input voltage is between 50 mV<sub>rms</sub> and 10 V<sub>rms</sub>. If a two channel device is tested, which does not have a built-in switch for selecting tracks to the output at pins 3 and 2 of the DIN output connector - i.e. a stereo only device such as all cassette recorders - then a special cable, the MEZ 401, must be used which includes a channel change-over switch. Both stereo channels can be individually tested using the MEZ 401. The MEZ 402 is intended for use when wow and flutter is to be measured at the same time as K<sub>3</sub>.

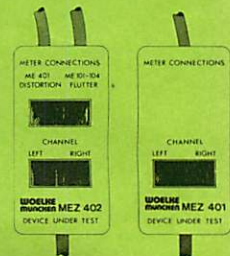

## 3. Testing the relationship between recording level and distortion (e.g. Bias adjustment)

The device under test is switched to RECORD mode to apply the 333 Hz signal as the input signal for recording via the phono-cable. The ME 401 delivers this low distortion signal. After the equipment has been rewound and switched to playback, the K<sub>3</sub> value can immediately be read as a function of the recording level or even of the type of tape. For equipment having an output for after tape monitoring, the distortion is readable during the recording process itself.

It can be observed that with progressive decreases of the recording level, the indicated K<sub>3</sub> value does not continue to drop, but at an extremely low level (e.g. -16 dB), it increases again. This presumed distortion is actually the noise component contributed by the tape itself in the 1 kHz range, therefore, it is not a harmonic of the fundamental frequency. This measurement provides an estimate of the signal-to-noise ratio of a recorder.

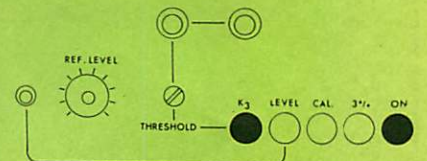
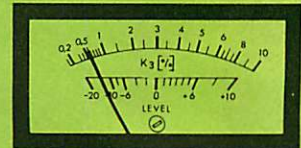

# MEASUREMENT METER ME 401

## 4. Level Measurement

The ME 401 Harmonic Distortion Measuring Set can be used to measure the level correlated with each measured  $K_3$  value: either the appropriate push button or a remote-controlled switch (Foot switch MEZ 24) may be operated for this test, which is indicated when the yellow lamp lights. If operation according to the DIN Standard Level is to be obtained, then a reference level test cassette (or a reference level test tape) must be played back before calibrating to the "0 dB" mark on the lower scale of the meter of the ME 401.

This is done as follows:

Push the LEVEL button, (reference level test cassette or tape being played back) and adjust the knob "REF. LEVEL" to a "0 dB" meter reading. After this calibration which must be re-done for every item of equipment or for every stereo channel, the meter provides readings of absolute level values.

Without a reference test tape (cassette), it is possible to estimate the applied level when the control is rotated to its full clockwise position. "0 dB" then corresponds to approx. 500 mV.

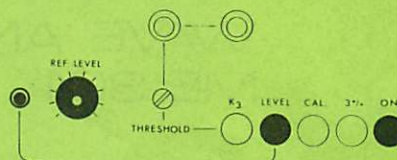

## 5. Recalibration

Two buttons, the one marked CAL. and the other, "3%" are pushed. The meter pointer should now read exactly 3%. If this value is not indicated, a correction is possible with the trimmer accessible from the bottom panel of the ME 401. When the button "3%" is not pushed, the meter indicates  $\pm 0.03\%$ , a reading of the intrinsic noise and distortion introduced by the generator and the automatic level control amplifier.

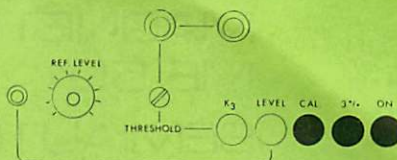

## 6. Adjusting the threshold value indication

Reaching or exceeding a pre-determined  $K_3$  value can be visually indicated by the green lamp extinguishing and the red lamp illuminating. The change-over threshold can be adjusted to be located in the range 0.8% to 10%. The Buttons LEVEL and CAL. are to be pushed simultaneously to override their mechanical interlock. Then the button "3%" is pushed and with potentiometer REF. LEVEL, the meter pointer is set to the desired value. Finally, the screw driver potentiometer, below the green indicator lamp, is set to a position which just causes a change-over from "green" to "red".

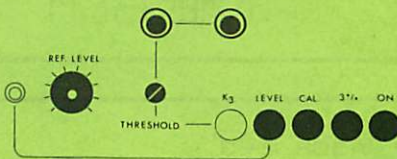
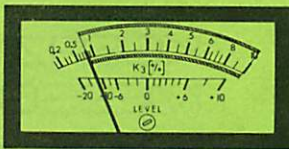

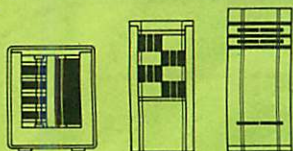

MAGNETKÖPFE  
MAGNETIC HEADS

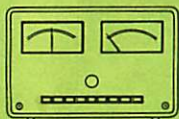

WOW AND FLUTTER METERS  
ME 102 C / CE  
ME 104 C



ME 105



WAVE ANALYZER  
ME 301

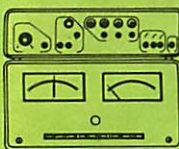

FLUTTER CLASSIFICATION UNIT  
ME 201



AUTOMATIC DISTORTION METER  
ME 401

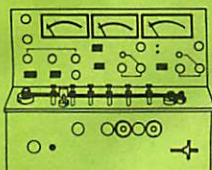

HALBAUTOMATISCHES  
MAGNETKOPF PRÜFGERÄT  
ME 501

SEMIAUTOMATIC CONTROL  
INSTRUMENTS FOR MAGNETIC HEADS  
ME 501



KOERZITIVFELDSTÄRKE  
MESSGERÄT  
ME 601

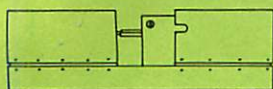

COERCIVE FORCE METER  
ME 601

WOELKE-STRASSE 2-3  
8069 SCHWEITENKIRCHEN  
( 08444 / 394 · ☎ 55547  
NOTBURGASTRASSE 5  
8 MÜNCHEN 19 ( 089 / 177021

**WOELKE MAGNETBANDTECHNIK**



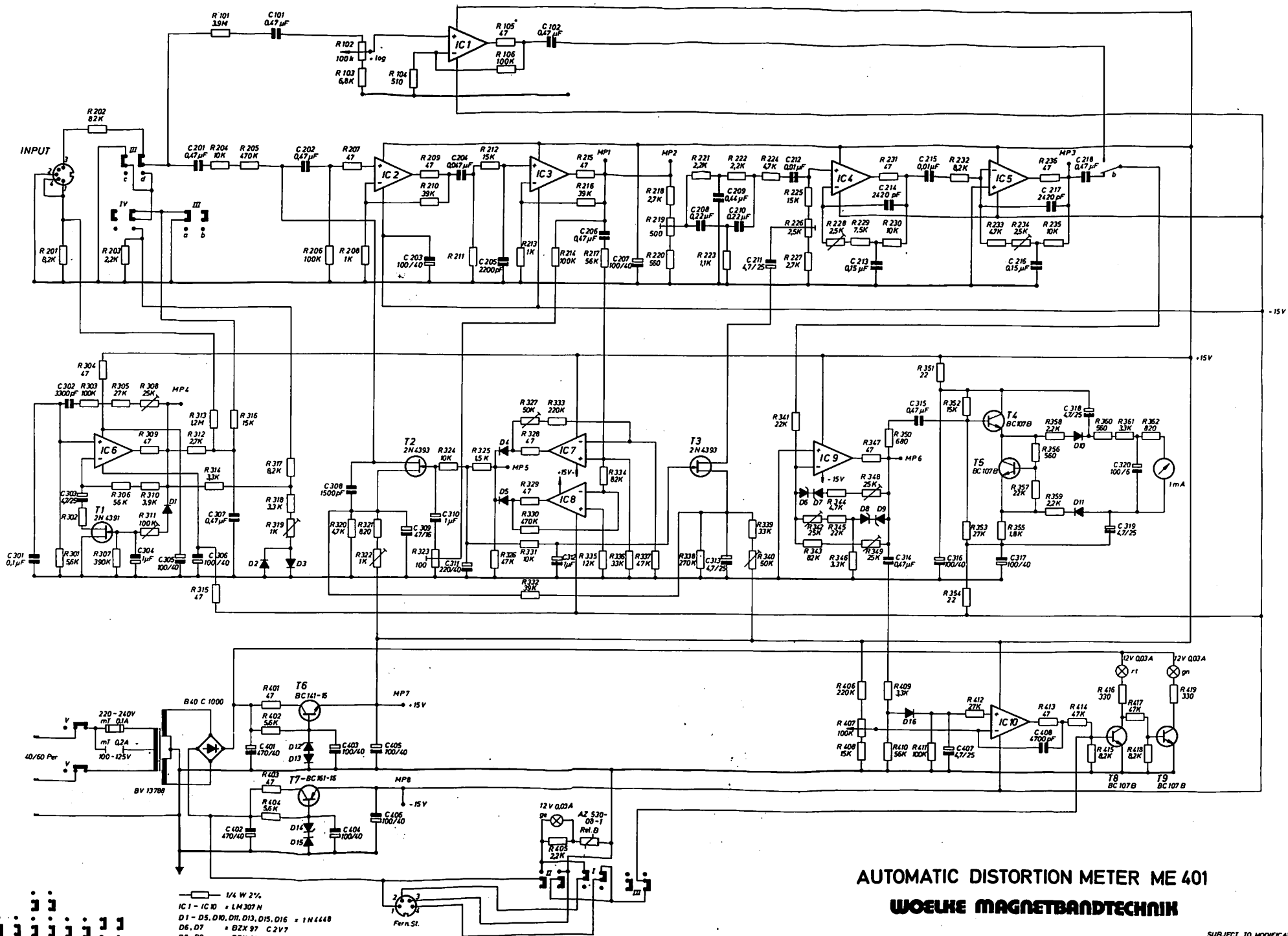

**AUTOMATIC DISTORTION METER ME 401**  
**WOELKE MAGNETBANDTECHNIK**

- 1/4 W 2%
- IC 1 - IC 10 = LM 307 N
- D 1 - D 5, D 10, D 11, D 13, D 15, D 16 = 1N 4448
- D 6, D 7 = BZX 97 C 2 V 7
- D 8, D 9 = BZX 97 C 6 V 8
- D 12, D 14 = BZX 97 C 1 5

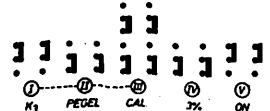

K3 LEVEL CAL. 3% ON

Fern. St. (Remote Control) INPUT

REF. LEVEL THRESHOLD

ME 401-1276

110 V  
220 V

