

KB

Res

Mod. 27/28

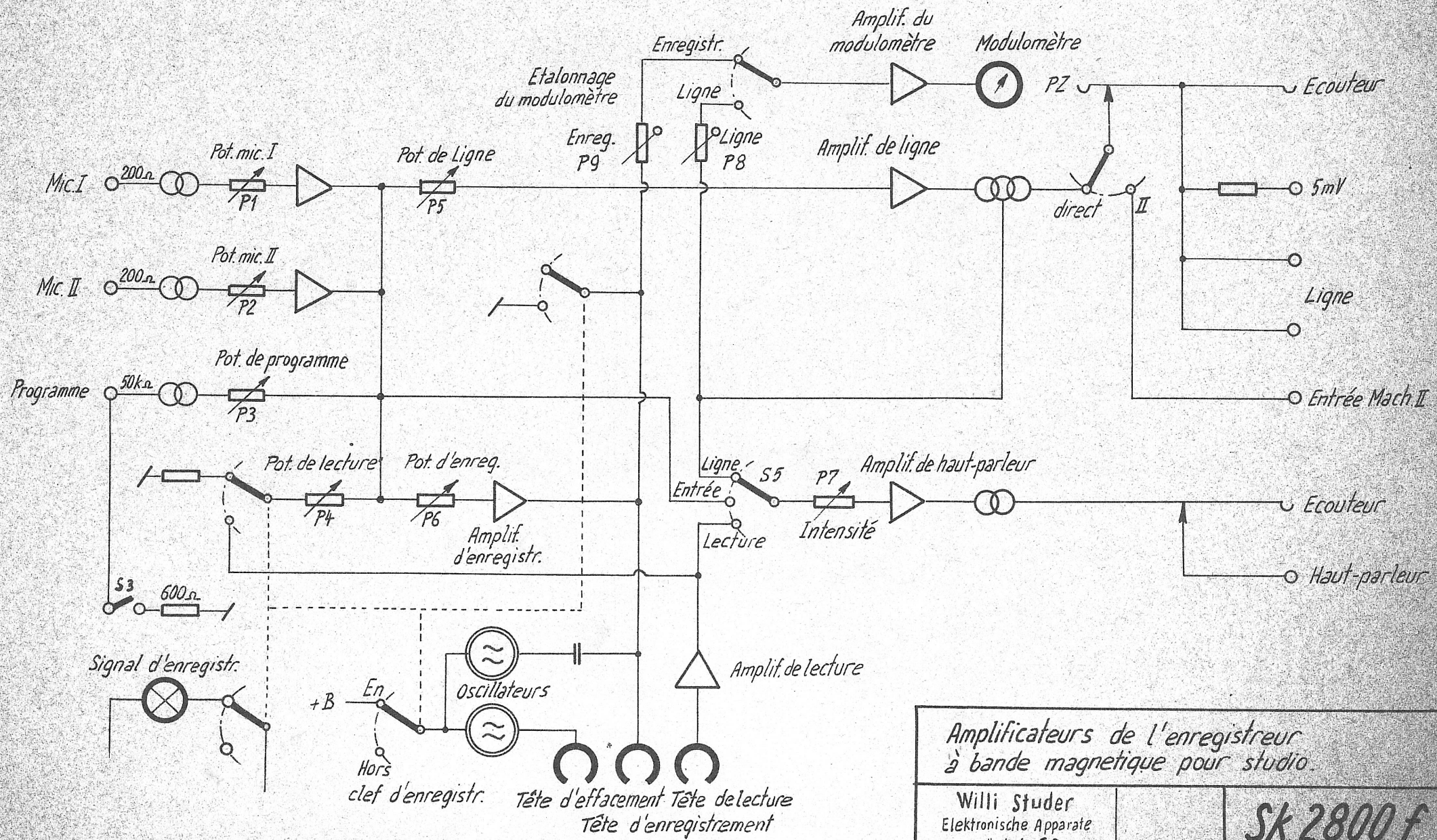

Amplificateurs de l'enregistreur
à bande magnétique pour studio.

Willi Studer
Elektronische Apparate
Zürich 56

SK 2800 f

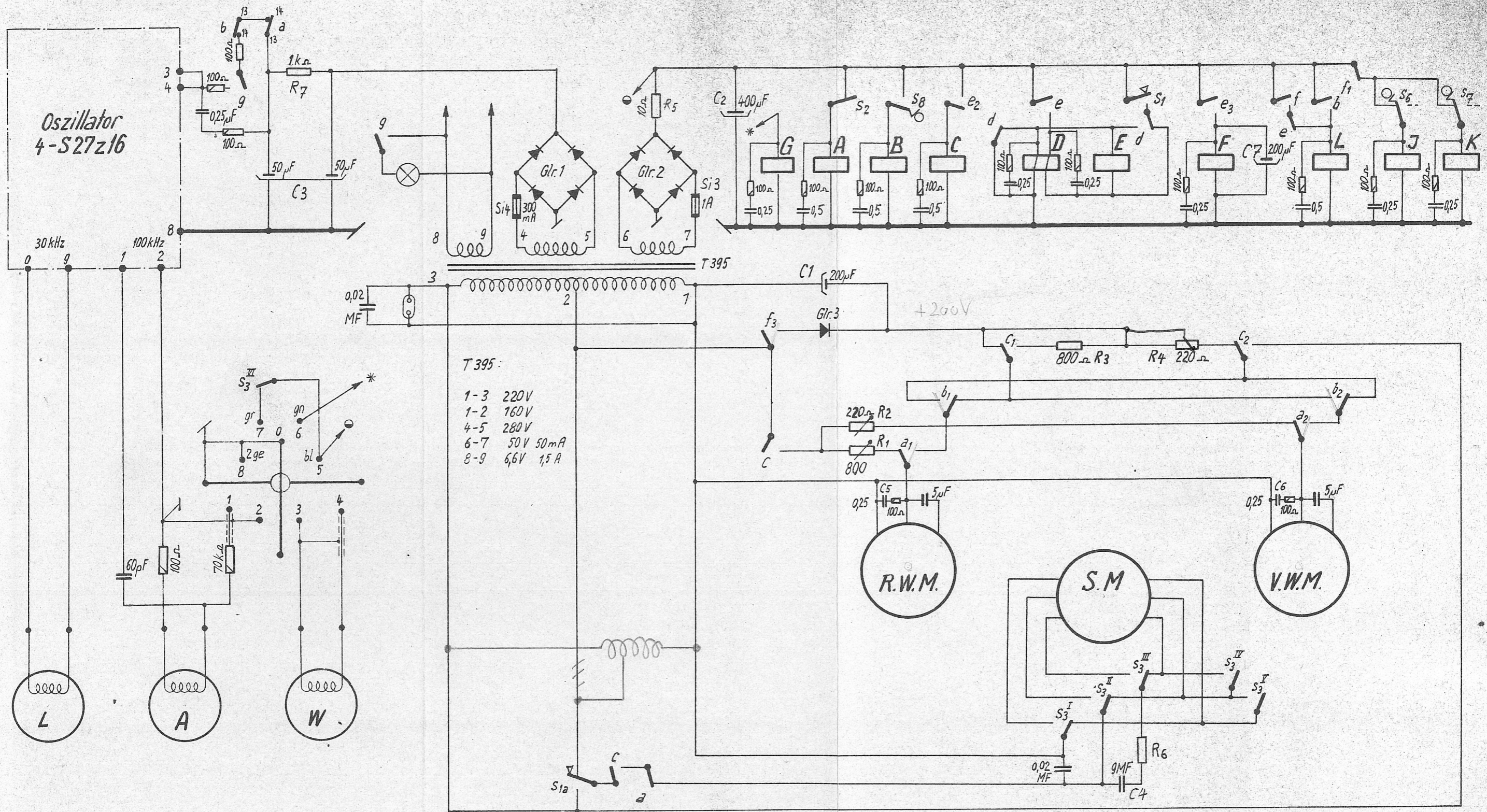

T 395:
 1-3 220V
 1-2 160V
 4-5 280V
 6-7 50V 50mA
 8-9 6,6V 1,5A

- A : Betrieb-Schnelllauf-Schütz
- B : Vor-Rückw.-Schütz
- C : Betrieb-Brems-Schütz
- D : Start-Stop-Hilfsrelais
- E : Start-Stop-Relais
- F : Bremsverzögerungsrelais
- G : Aufnahme-Relais (osz.)
- J : Block-RWM (links)
- K : Block-VWM (rechts)
- L : Halte-Relais
- S1 : Start-Stop
- S1a : Anlauf-Umschalter
(muss vor S1 schalten)
- S2 : Betrieb-Schnelllauf-Schalter
- S3 : Dahlander-Schalter in Stellung 7,5", umschaltbar auf 15"
- S6 : Block Rückwärtsmotor (links)
- S7 : Block Vorwärtsmotor (rechts)
- S8 : Vor-Rücklauf (Vorw. offen)

Stück			Pos.	No.	Gegenstand	Mat.	Bemerkung		
III	II	I			Studio - Laufwerk	Maßstab	Gez.	21.5.52	<i>W. St.</i>
						Gepr.			
Willi Studer Elektronische Apparate Zürich 56					Aend.:	3-S27			

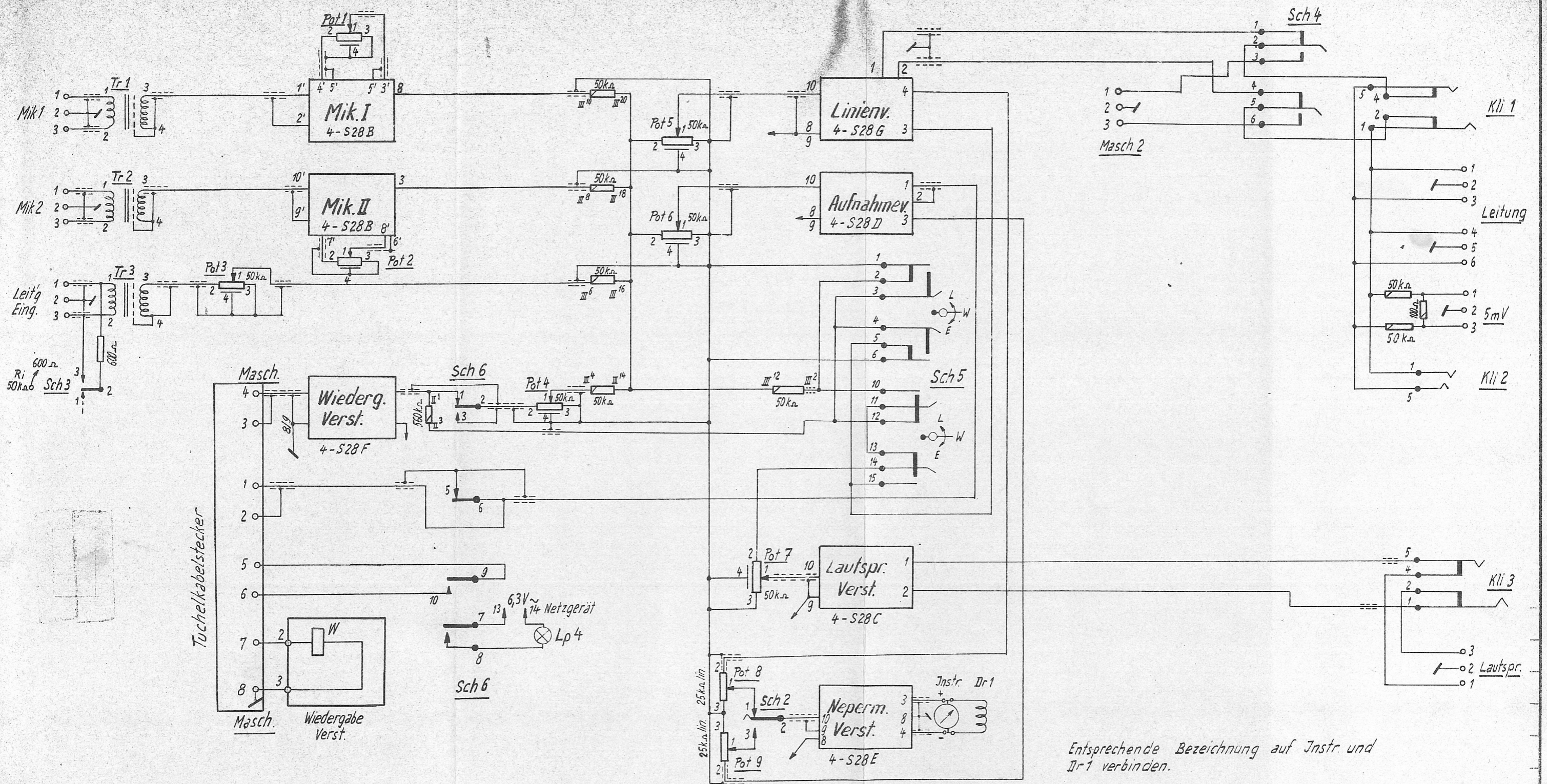

Schalter S6 justieren
 Kontakt 5-6 muss öffnen
 vor 9-10 schliesst

Entsprechende Bezeichnung auf Instr. und
 II-1 verbinden.

Stück			Pos.	No.	Gegenstand	Mat.	Bemerkung		
III	II	I			Studio - Verst.	Maßstab	Gez.	27.5.52	WJm
							Gepr.		
Willi Studer Elektronische Apparate Zürich 56						Aend.:	3-S28		

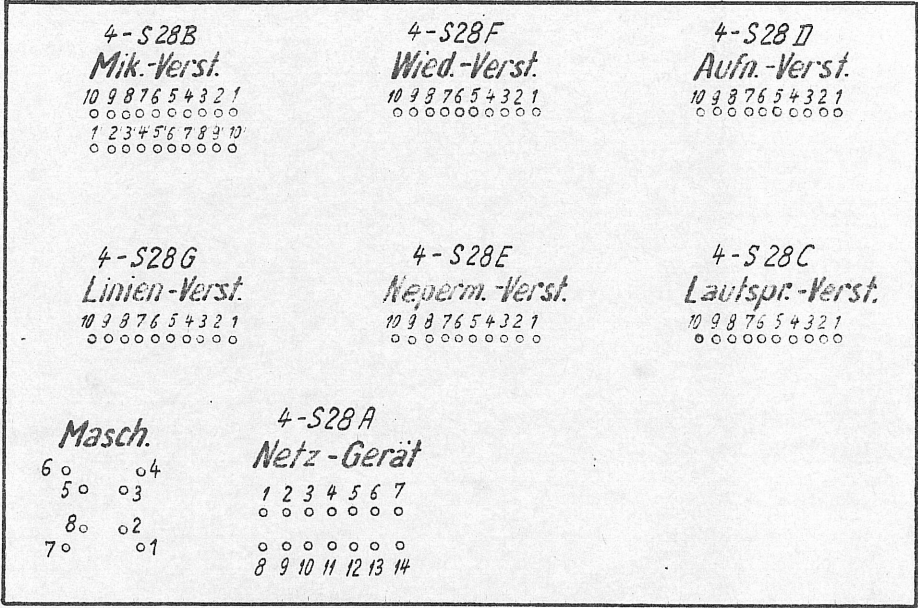

Stück			Pos.	No.	Gegenstand	Mat.	Bemerkung		
III	II	I			<i>Studio-Verst. Belegungsplan</i>	Maßstab	Gez.	1.7.52	<i>H. J. ...</i>
						Gepr.			
				Willi Studer Elektronische Apparate Zürich 56	Aend.:	4-S28-1			

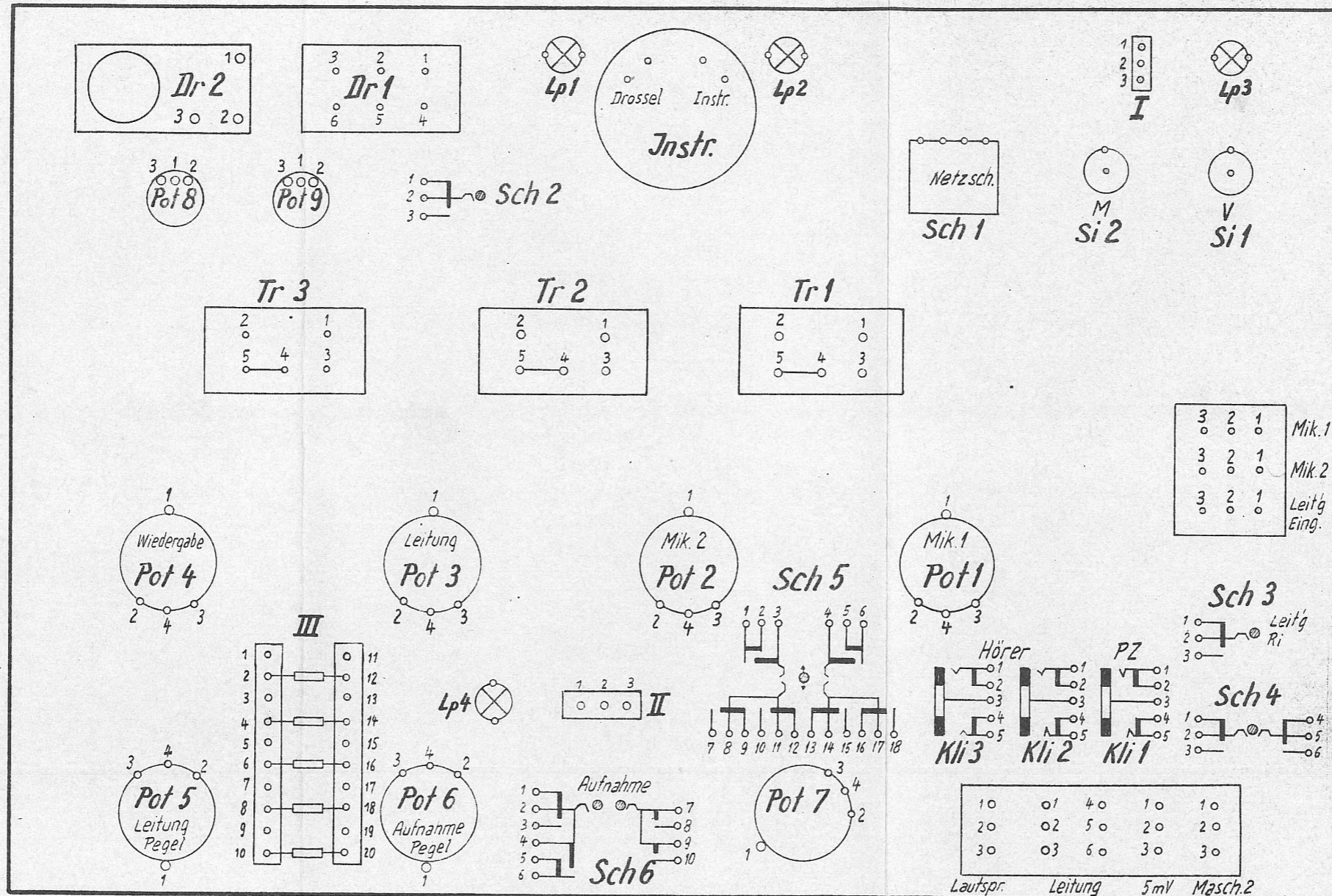

Stück	Pos.	No.	Gegenstand	Mat.	Bemerkung
III	II	I	<i>Studio-Verst. Belegungsplan</i>	Maßstab	1.7.52 <i>HW</i>
				Gez.	
				Gepr.	
Willi Studer Elektronische Apparate Zürich 56			Aend.:	3-528-2	

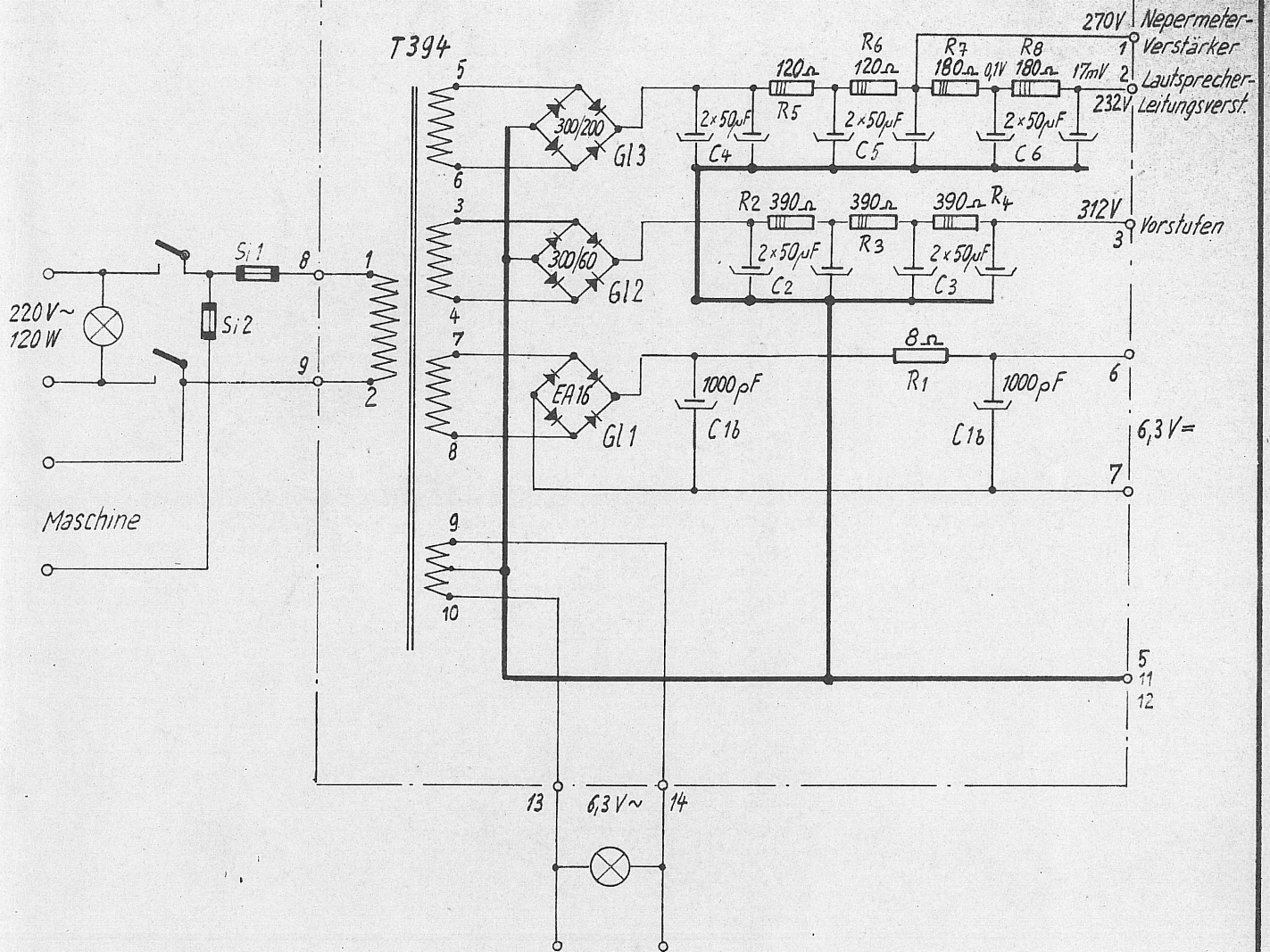

T394:

- 1 - 2 220V
- 3 - 4 280V 35 mA
- 5 - 6 280V 150 mA
- 7 - 8 12V 0,8 A
- 9 - 10 6,6V 5 A

Stück			Pos.	No.	Gegenstand	Mat.	Bemerkung		
III	II	I			Netz-Gerät	Maßstab	Gez.	27.5.52	Hf
						Gepr.			
				Willi Studer Elektronische Apparate Zürich 56		Aend.:	4 - S28 A		

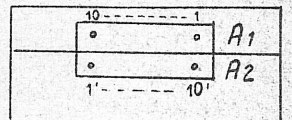
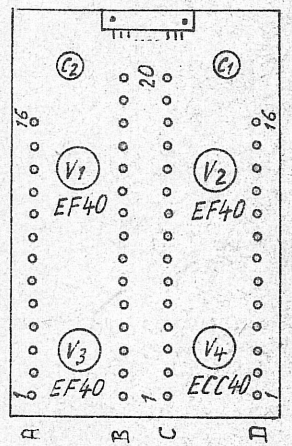
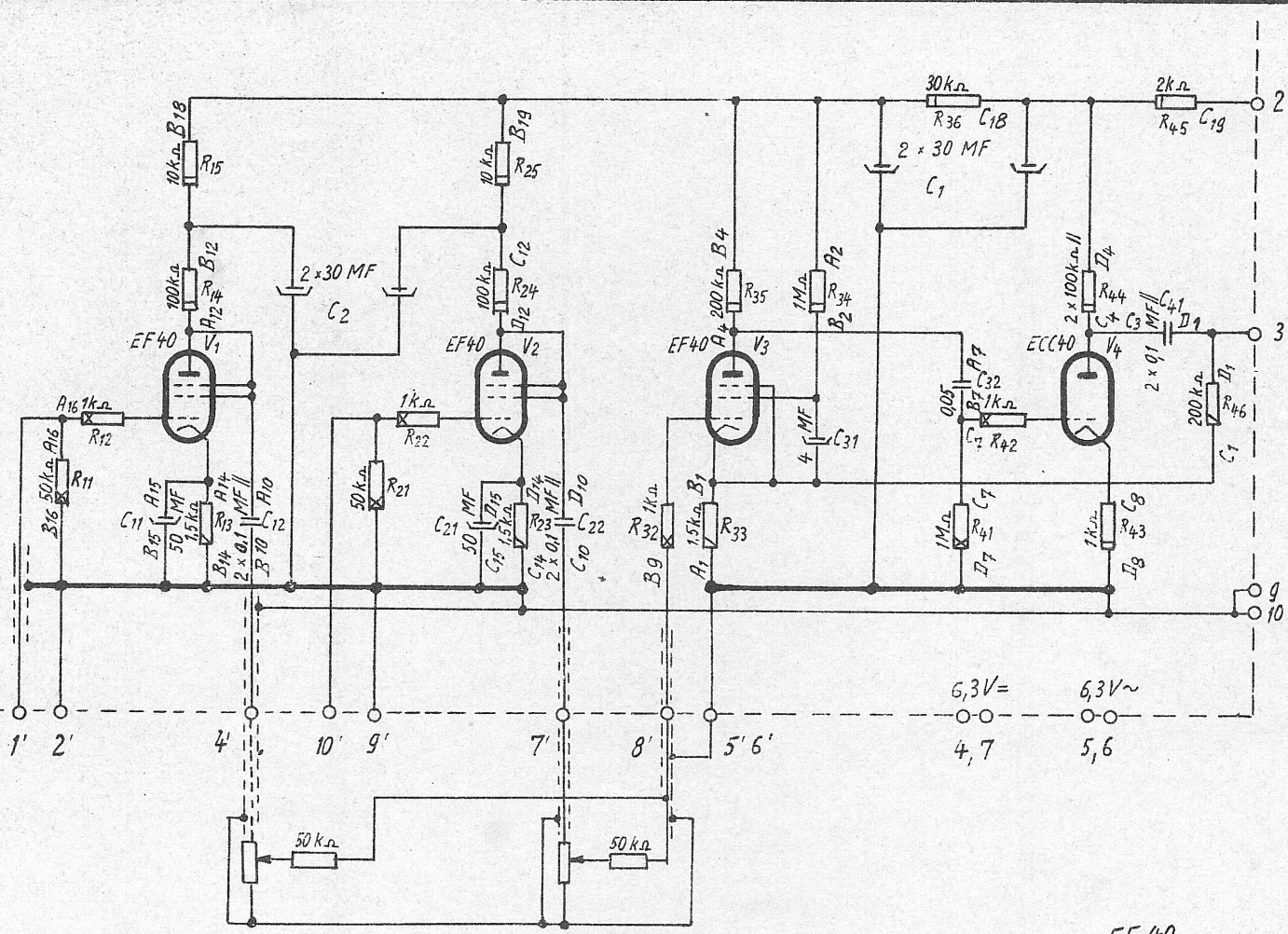

EF 40

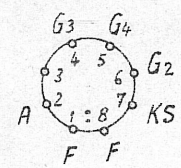

ECC 40

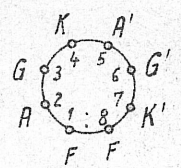

V4 * Beide Systeme parallel geschaltet

Heizung : V1 V2 6,3V = Klemme 4, 7
 V3 V4 6,3V ~ Klemme 5, 6

Studio - Magnetophonverst. Mod. 28

Mikrophon - Vorverstärker

ab Fabrik Nummer 63

Willi Studer
 Elektronische Apparate
 Zürich 56

Aend.:

Gez. 12.153 HFL

S 28 B a

Willi Studer
Elektronische Apparate
Zürich 56

Ampl.:

Laufspr.-Verst.

4-S28C

III
II
I

Stück	Pos.	No.	Bezeichnung	Mat.	Bemerkung

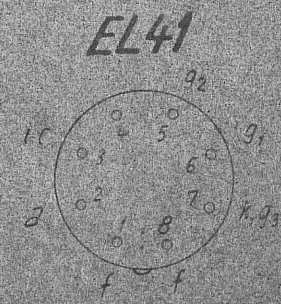
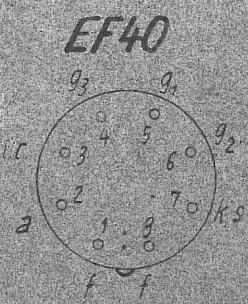
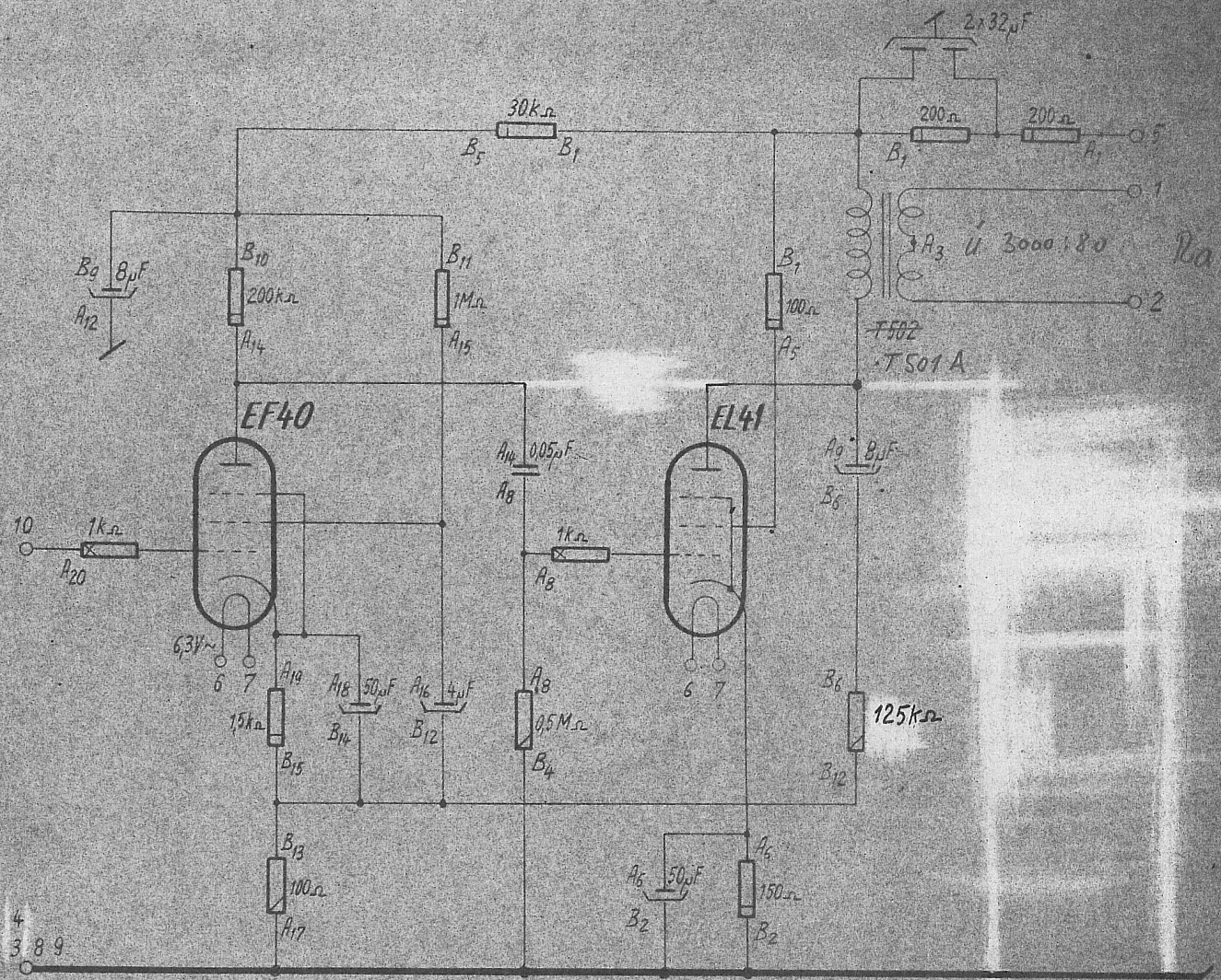

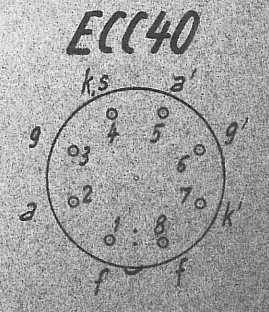
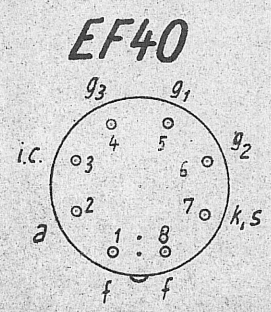
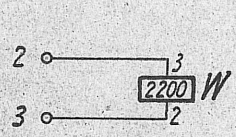
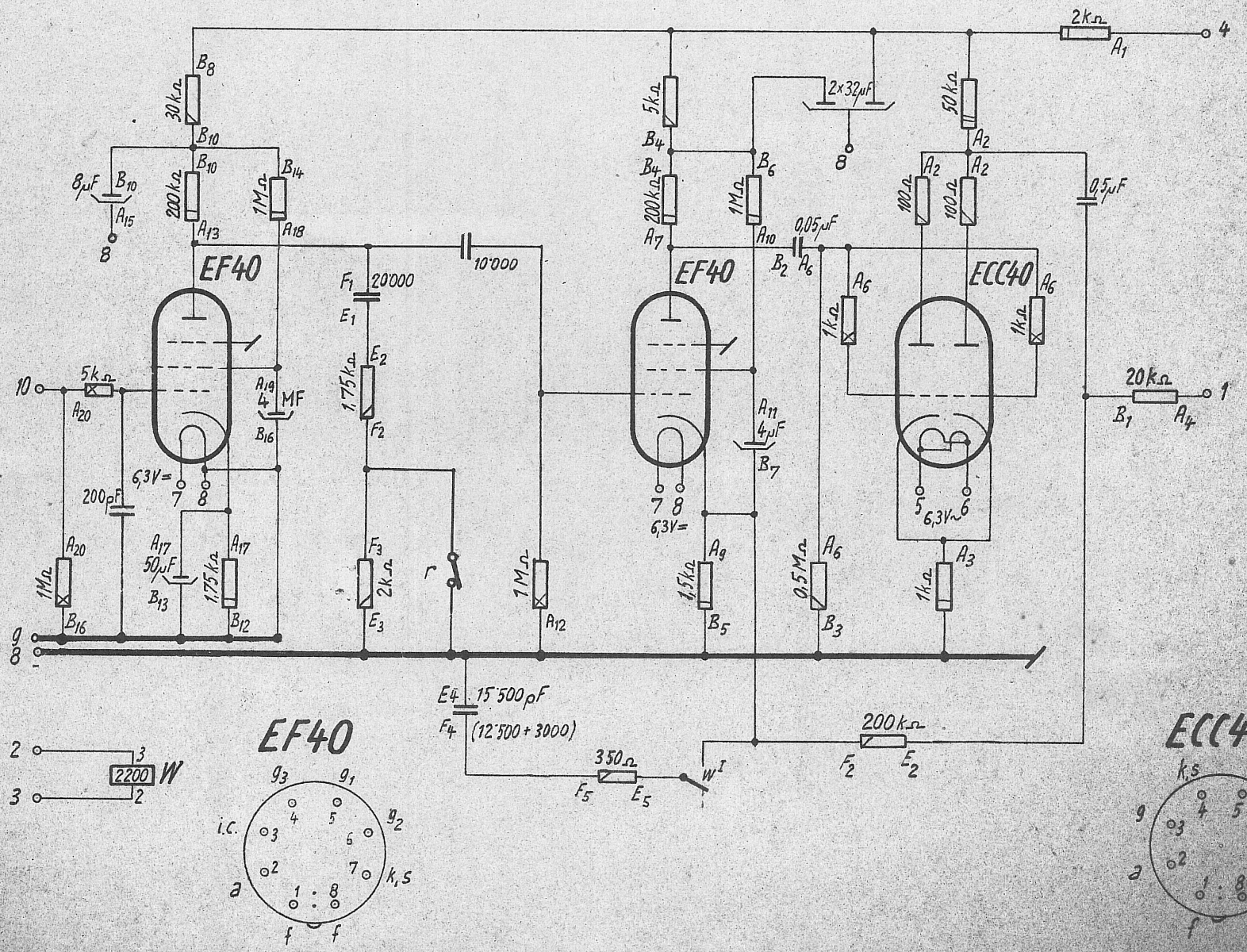

Willi Studer
Elektronische Apparate
Zürich 56

Aend.:

4-S28G

Leistungs-Verst.

Stück	Pos.	No.	Gegenstand	Mat.	Bemerkung
III					
II					
I					

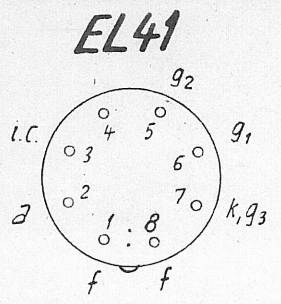
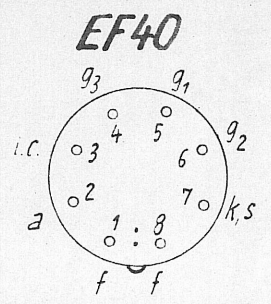
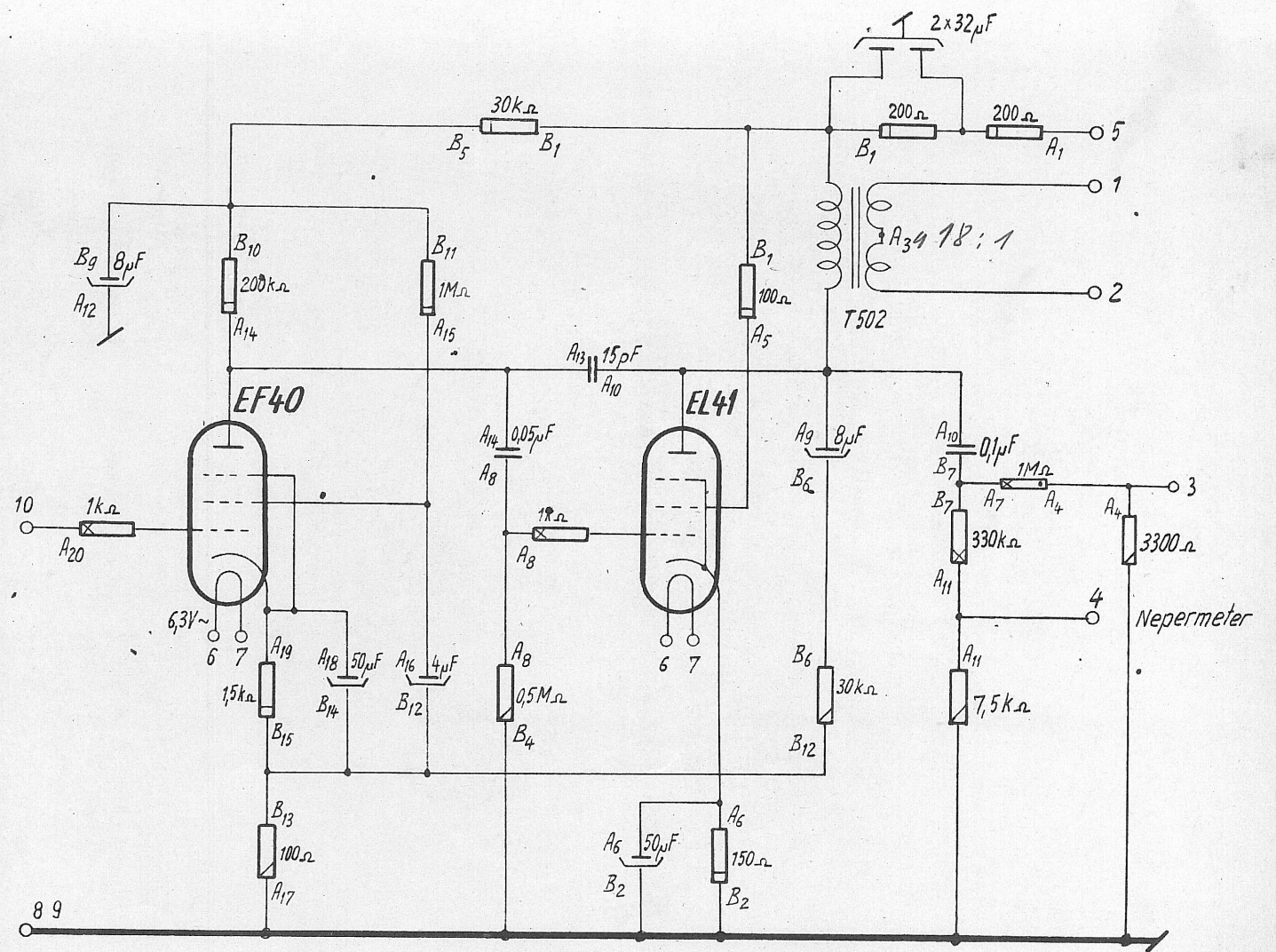

III		II		I	
Stück		Pos.		No.	
Gegenstand		Mat.		Bemerkung	
Maßstab		Gez.		Gepr.	
4-S27z16		1/6.5.52		16. MRZ. 1954	
Willi Studer		Aend.: 12.12.52		Hkwn	
Elektronische Apparate		Zürich 56		Oszillator 100kHz, 30kHz	

